

ROADMAP • OPEN ACCESS

2024 roadmap on membrane desalination technology at the water-energy nexus

To cite this article: Antonio Politano *et al* 2024 *J. Phys. Energy* **6** 021502

View the [article online](#) for updates and enhancements.

You may also like

- [Stakeholder perspectives on fostering the water-energy-food nexus in Jordan: lessons beyond agricultural water management](#)
Abel Chemura, Walaa Al-Smadi, Ali Abkar et al.
- [The Water-Energy-Food Nexus: A systematic review of methods for nexus assessment](#)
Tamee R Albrecht, Arica Crootof and Christopher A Scott
- [Hydropower representation in water and energy system models: a review of divergences and call for reconciliation](#)
David E Rheinheimer, Brian Tarroja, Anna M Rallings et al.



ROADMAP

OPEN ACCESS

2024 roadmap on membrane desalination technology at the water-energy nexus

RECEIVED
2 July 2023REVISED
12 January 2024ACCEPTED FOR PUBLICATION
26 February 2024PUBLISHED
12 April 2024

Original content from this work may be used under the terms of the [Creative Commons Attribution 4.0 licence](#).

Any further distribution of this work must maintain attribution to the author(s) and the title of the work, journal citation and DOI.



Antonio Politano^{1,*} , Raed A Al-Juboori² , Sultan Alnajdi³, Albraa Alsaati^{3,21} , Athanassia Athanassiou⁴ , Maya Bar-Sadan⁵, Ali Naderi Beni³, Davide Campi⁶, Anna Cupolillo⁷, Gianluca D'Olimpio¹ , Giuseppe D'Andrea⁸, Humberto Estay⁹ , Despina Fragouli⁴ , Luigi Gurreri¹⁰ , Noredine Ghaffour¹¹, Jack Gilron¹², Nidal Hilal² , Jessica Occhuzzi¹, Mateo Roldan Carvajal³, Avner Ronen¹², Sergio Santoro⁸, Michele Tedesco¹³, Ramato Ashu Tufa⁸, Mathias Ulbricht¹⁴, David M Warsinger³, Dimitrios Xevgenos¹⁵, Guillermo Zaragoza^{16,17} , Yong-Wei Zhang¹⁸, Ming Zhou^{19,22} and Efrem Curcio^{8,20,*}

¹ Department of Physical and Chemical Sciences, University of L'Aquila, 67100 L'Aquila, Italy

² NYUAD Water Research Center, New York University Abu Dhabi, Abu Dhabi, United Arab Emirates

³ School of Mechanical Engineering, Birck Nanotechnology Center, Purdue University, West Lafayette, IN 47907, United States of America

⁴ Smart Materials, Istituto Italiano di Tecnologia, via Morego 30, Genova 16163, Italy

⁵ Department of Chemistry & Ilse Katz Institute for Nanoscale Science and Technology, Ben-Gurion University, Be'er Sheva 8410501, Israel

⁶ Department of Materials Science, University of Milano-Bicocca, Via R. Cozzi 55, 20125 Milano, Italy

⁷ Department of Physics, University of Calabria, Via P. Bucci Cubo 31C, 87036 Rende, CS, Italy

⁸ Department of Environmental Engineering, University of Calabria, Via Pietro Bucci cubo 44A, 87036 Rende (CS), Italy

⁹ Advanced Mining Technology Center (AMTC), University of Chile, Av. Tupper 2007 (AMTC Building), Santiago, Chile

¹⁰ Department of Electrical, Electronics and Computer Engineering, University of Catania, viale Andrea Doria 6, 95125 Catania, Italy

¹¹ Water Desalination and Reuse Center (WDRC), King Abdullah University of Science and Technology (KAUST), Thuwal 23955-6900, Saudi Arabia

¹² The Zuckerberg Institute for Water Research, Ben Gurion University of the Negev, Israel

¹³ TNO Sustainable Process and Energy Systems, Lange Kleiweg 137, 2288 GJ, Rijswijk, The Netherlands

¹⁴ Lehrstuhl für Technische Chemie II and Center for Nanointegration Duisburg-Essen (CENIDE), Universität Duisburg-Essen, Universitätsstr. 5, 45141 Essen, Germany

¹⁵ Engineering Systems & Services Department, Technology Policy & Management faculty, Delft University of Technology, Jaffalaan 5, 2628 BX Delft, The Netherlands

¹⁶ CIEMAT-Plataforma Solar de Almería, Ctra. de Senés s/n, Tabernas, 04200 Almería, Spain

¹⁷ CIESOL-Universidad de Almería, Ctra, Sacramento s/n, Almería 04120, Spain

¹⁸ Institute of High Performance Computing (IHPC), Agency for Science, Technology and Research (A*STAR), 1 Fusionopolis Way, #16-16 Connexis, Singapore 138632, Singapore

¹⁹ State Key Laboratory of Materials-Oriented Chemical Engineering, National Engineering Research Center for Special Separation Membrane, Nanjing Tech University, Nanjing 210009, People's Republic of China

²⁰ Seligenda Membrane Technologies s.r.l., c/o University of Calabria, Via P. Bucci Cubo 45A, 87036 Rende, CS, Italy

²¹ Present Address: Mechanical Engineering Department, Umm Al-Qura University, Makkah 24382, Saudi Arabia.

²² State Key Laboratory of Water Resource Protection and Utilization in Coal Mining, National Institute of Clean and Low Carbon Energy, Beijing 102211, China.

* Authors to whom any correspondence should be addressed.

E-mail: antonio.politano@univaq.it and efrem.curcio@unicat.it

Keywords: water-energy nexus, membrane technology, thermoplasmonics, solar desalination, photothermal materials, light-to-heat conversion, nanomaterials

Abstract

Water and energy are two strategic drivers of sustainable development, intimately interlaced and vital for a secure future of humanity. Given that water resources are limited, whereas global population and energy demand are exponentially growing, the competitive balance between these resources, referred to as the water-energy nexus, is receiving renewed focus. The desalination industry alleviates water stress by producing freshwater from saline sources, such as seawater, brackish or groundwater. Since the last decade, the market has been dominated by membrane desalination technology, offering significant advantages over thermal processes, such as lower energy demand, easy process control and scale-up, modularity for flexible productivity, and feasibility of synergic integration of different membrane operations. Although seawater reverse osmosis (SWRO) accounts for more than 70% of the global desalination capacity, it is

circumscribed by some significant technological limitations, such as: (i) the relatively low water recovery factor (around 50%) due to the negative impact of osmotic and polarization phenomena; (ii) an energy consumption in the range of 3–5 kWh m⁻³, still far from the theoretical energy demand (1.1 kWh m⁻³) to produce potable water from seawater (at 50% water recovery factor). Ultimately, desalination is an energy intensive practice and research efforts are oriented toward the development of alternative and more energy-efficient approaches in order to enhance freshwater resources without placing excessive strain on limited energy supplies. Recent years have seen a relevant surge of interest in membrane distillation (MD), a thermally driven membrane desalination technology having the potential to complement SWRO in the logic of Process Intensification and Zero Liquid Discharge paradigm. Due to its peculiar transport mechanism and negligibility of osmotic phenomena, MD allows high-quality distillate production (theoretically, non-volatile species are completely rejected) with a recovery factor of up to 80% at a relatively low operative temperature (typically 60 °C–80 °C). Although low operative temperatures make MD technology attractive for renewable power applications (e.g. solar thermal, wind or geothermal energy sources) or for efficient exploitation of low-grade or waste heat streams, the low energy efficiency intrinsically due to heat losses—and specifically to temperature polarization—has so far hindered the application at industrial scale. Nowadays, photothermal materials able to absorb and convert natural or artificial irradiation into heat have gained great attention, demonstrating the potential to mitigate the ‘anthropic’ energy input to MD and to mitigate the impact of thermal inefficiencies. On this road, a step-change improvement in light-to-heat conversion is expected through high-throughput computational screening over thermoplasmonic materials based on electronic and optical properties of advanced materials including novel topological phases of matter used as nanofillers in polymeric membranes. Coherently with the concept of Circular Economy, waste hypersaline solutions rejected from desalination process (referred as ‘brine’) are now the subject of valorization activities along two main exploitation routes: (1) recovery of valuable minor and trace metals and minerals, with special focus on critical raw materials (including, among others, Mg, Na, Ca, K, Sr, Li, Br, B, and Rb); (2) production of salinity gradient power (SGP) renewable energy resulting from the recovery of the Gibbs energy of mixing (mainly represented by the entropic contribution) of two solutions having different ionic concentration. The exciting new frontier of sustainable mining of seawater concentrates is accelerating the appearance of a plethora of innovative membrane materials and methods for brine dehydration and selective extraction of trace ions, although under the sword of Damocles represented by cost feasibility for reliable commercial application. On the other hand, among several emerging technologies, reverse electrodialysis (SGP-RED) was already proven capable—at least at the kW scale—of turning the chemical potential difference between river water, brackish water, and seawater into electrical energy. Efforts to develop a next generation of ion exchange membranes exhibiting high perm-selectivity (especially toward monovalent ions) and low electrical resistance, to improve system engineering and to optimize operational conditions, pursue the goal of enhancing the low power density so far achievable (in the order of a few W per m²). This Roadmap takes the form of a series of short contributions written independently by worldwide experts in the topic. Collectively, such contributions provide a comprehensive picture of the current state of the art in membrane science and technology at the water-energy nexus, and how it is expected to develop in the future. In addition, this Roadmap acknowledges the challenges and advances in membrane systems, particularly emphasizing the interplay of material innovation and system optimization, which collectively contribute to advancing the desalination field within the water-energy nexus framework.

Contents

Introduction	5
1. Advanced functional membranes for water treatment	7
2. Renewable energy-powered membrane desalination systems	11
3. Offshore membrane desalination facilities powered by renewable energy	14
4. Energy effectiveness in membrane-based desalination	16
5. Light-to-heat conversion in nanomaterials	20
6. Computational screening of photothermal materials	24
7. Electromembrane processes for water treatment	27
8. Blue energy generation from brines	30
9. Seawater and brines: the mine of the future?	34
10. Integrated processes for membrane-based circular blue economy	38
Data availability statement	40
Acknowledgments	41
References	41

Acronyms

AEM	Anion-exchange membrane
AEMWE	Anion exchange membrane water electrolysis
AGMD	Air gap membrane distillation
AI	Artificial intelligence
AWC	Artificial water channels
BMED	Bipolar membrane electro dialysis
BSE	Bethe–Salpeter equation
CEM	Cation-exchange membrane
CSP	Concentrating solar power
DD	Donnan dialysis
DFT	Density functional theory
ED	Electrodialysis
EMP	Electro-membrane process
ERD	Energy recovery devices
FO	Forward osmosis
FOM	Figure-of-merit
GOR	Gain output ratio
HC	High-concentration
ICP	Internal concentration polarization
IEM	Ionic exchange membranes
IPA	Independent particle approximation
LC	Low-concentration
LSPR	Localized surface Plasmon resonance
IEM	Ion exchange membrane
MCr	Membrane crystallization
MD	Membrane distillation
MED	Multi-effect distillation
MOF	Metal-organic framework
MSF	Multistage flash
NIR	Near-infrared
NF	Nanofiltration
NP	Nanoparticle
PA	Polyamide
PRO	Pressure retarded osmosis
PV	Photovoltaic
RED	Reverse electro dialysis
RO	Reverse osmosis
RSD	Reflection salt diffusion
SEC	Specific energy consumption
SGE	Salinity gradient energy
SGP	Salinity gradient power
SWRO	Seawater reverse osmosis
TD-DFT	Time-dependent density functional theory
TDS	Total dissolved solids
TFC	Thin-film composite
TP	Temperature polarization

Introduction

Antonio Politano¹, Sergio Santoro² and Efrem Curcio^{2,3}

¹ Department of Physical and Chemical Sciences, University of L'Aquila, 67100 L'Aquila, Italy

² Department of Environmental Engineering, University of Calabria, Via Pietro Bucci cubos 44A, 87036 Rende, CS, Italy

³ Seligenda Membrane Technologies s.r.l., c/o University of Calabria, Via P. Bucci Cubo 45A, 87036 Rende, CS, Italy

Water and energy are two critical factors for sustainable development that are intimately interconnected and essential for ensuring a secure future for humanity. With limited water resources and exponentially growing global population and energy demand, the balance between these resources—known as the water-energy nexus—is receiving renewed focus from experts and policymakers alike. Membrane technology has emerged as a promising solution in addressing the challenges of water treatment, desalination and energy production, and this Roadmap is dedicated to exploring its potential applications and advancements in this field.

The Roadmap comprises several sections, each examining a specific aspect of membrane technology's role in water treatment and desalination at the water-energy nexus.

In section 1, 'Advanced Functional Membranes for Water Treatment,' the focus is on the latest innovations in the field of functional membranes for water treatment and their application in desalination and pollutant removal. This section delves into the design, fabrication and the performance of advanced materials and structures that improve the efficiency and selectivity of these membranes.

Section 2, 'Renewable Energy-Powered Membrane Desalination Systems' explores membrane desalination systems that use renewable energy sources such as solar, wind, and geothermal energy to reduce environmental impact. This section covers various configurations and optimization strategies to enhance the efficiency and sustainability of these energy-powered desalination systems.

Section 3, 'Offshore membrane desalination facilities powered by renewable energy' discusses the challenges and advancements related to offshore desalination. The section highlights the need for continuous energy production on-site and the optimization of the location of offshore plants considering factors like energy and cost of transporting water to the shore.

Section 4, 'Energy Effectiveness in Membrane-Based Desalination,' is focused on the importance of energy efficiency in membrane desalination. This section covers the historical progression of energy consumption in the process, the technological developments that have improved energy efficiency, and the current challenges such as high specific energy consumption and greenhouse gas emissions. The need for exploiting renewable energy, refining ERDs, and overcoming limitations like TP in MD is underscored to improve the energy effectiveness further.

Section 5, 'Light-to-heat conversion in nanomaterials' delves into photothermal materials' potential in improving desalination through thermoplasmonics. Despite showing promise, these materials face efficiency, quantification, stability, durability, scalability, and integration challenges. Future solutions include systematic band structure analysis, methodology standardization, surface coating technologies, manufacturing method refinement, and hybrid system development. Various materials show potential for photothermal applications, though some present efficacy and stability issues. With ongoing advancements, photothermal materials promise a significant impact on solar membrane desalination.

Section 6, 'Computational screening of photothermal materials,' describes the current efforts to optimize the light-to-heat conversion efficacy of photothermal materials. The section illustrates the potential of exploiting advanced computational tools, high-throughput calculations, and machine learning to overcome limitations in current methodologies, aiming to optimize nanostructure and expedite the discovery of superior photothermal materials.

Section 7, 'EMPs for Water Treatment' focuses on EMPs such as ED and DD for water treatment. This section delves into the principles, advancements, and applications of various EMPs in improving the efficiency of water treatment and resource recovery.

Section 8, 'Blue Energy Generation from Brines,' examines the potential for generating renewable energy, known as blue energy, from salinity gradients between seawater and freshwater sources. This section discusses the principles, technologies and challenges associated with harnessing blue energy and its role in a sustainable future.

Section 9, 'Seawater: The Mine of the Future?' explores the emerging trend of extracting valuable minerals and elements from seawater and desalination brines. This section investigates the potential economic and environmental benefits of seawater mining and its implications for the water-energy nexus.

Finally, section 10, 'Integrated Processes for Membrane-Based Circular Blue Industry,' examines the concept of a circular economy within the water-energy nexus and how membrane technologies can play a

crucial role in resource recovery and waste minimization. This section presents case studies and strategies for integrating various membrane-based processes to create sustainable and circular water energy systems.

Together, these sections provide a comprehensive picture of the current state of the art in membrane science and technology at the water energy nexus and how it is expected to develop in the future. This Roadmap strives to spark continued research, encourage interdisciplinary collaboration, and drive ground-breaking innovation within the field, playing a vital role in advancing the potential of membrane technology in the water-energy nexus.

1. Advanced functional membranes for water treatment

Mathias Ulbricht

Lehrstuhl für Technische Chemie II and Center for Nanointegration Duisburg-Essen (CENIDE), Universität Duisburg-Essen, Universitätsstr. 5, 45141 Essen, Germany

Status

A wide range of membrane-based technologies is highly relevant for the water energy-nexus [1–3]. Membranes have an enormous potential to make traditional processes more resource-saving (e.g. water desalination by energy-efficient membrane processes, or reducing the water demand of the energy production sector via water recycling by membrane technology). Realizing the vision of a truly ‘green hydrogen’-based society will most likely depend strongly on the successful development and implementation of membrane-enabled water electrolysis, and the resulting major additional demand for purified water will certainly be met by membrane-enabled water purification [4].

It must be emphasized that the success of a membrane-based technology for an intended application depends on innovations and engineering at different levels, i.e. membrane process, membrane unit or module, and membrane material [5]. Nevertheless, an essential requirement for viability and efficiency of any membrane process is the availability of membranes with suited structure and hence appropriate separation performance that can be fabricated by scalable methods [6]. The key criteria for performance are selectivity (impacting the quality/purity of the product), permeability (impacting the energy demand for providing the driving force to produce a certain quantity of product), and stability of performance under real process conditions. With regard to water purification (specifically, water desalination or resource recovery from saline waters), very different types of membranes are relevant depending on the specific membrane process that will fit to the requirements regarding feed and permeate quality and quantity.

In the focus of the roadmap are pressure-driven SWRO (nowadays, the dominating technology for large-scale seawater desalination), NF (established for several partial desalination applications, including softening and monovalent/multivalent ion partitioning), electrically driven ED (a proven technology that can be more energy-efficient than SWRO to yield pure and ultrapure water from low-salinity feeds), and the thermally driven membrane contactor process MD (a potential alternative in specific parts of water desalination schemes). The relevant membranes are typically made from synthetic organic polymers [6] and contain transport channels in a stabilizing matrix. Those transport channels (‘pores’) are either selective for water from liquid mixtures (SWRO), for solutes below a certain size from aqueous solutions (NF), for cations or anions from aqueous feeds (ED), or they cannot be wet by liquid aqueous feeds so that only water vapor will permeate through the membrane (MD).

Current and future challenges

Advanced or novel membranes should be superior to state-of-the-art in terms of the key criteria for performance (cf. above). Common guidelines to overcome trade-off relationships between selectivity and permeability, which are very well documented for SWRO and NF [7] but can be identified also for ED [8] and MD [9], are maximizing the density and minimizing the length and tortuosity the selective transport channels in the barrier layer of the membrane.

However, the detailed strategies toward advanced membranes are different for the different types, caused by different involved transport mechanisms and process boundary conditions [10]. The ultimate SWRO membrane should enable a fast, single-file water transport through water-selective pores, as it is known for Aquaporins (biological water channels, figure 1(a)) and predicted for single-wall carbon nanotubes (figure 1(b)). Functional groups at the pore entrance can have an additional influence on the selectivity of solute transport (figure 1(c)). In contrast, the transport of water through the free volume of established suited, modestly hydrophilic, amorphous organic polymers is based on a solution-diffusion mechanism, and the transport of ions is hindered by the energy barrier for ion dehydration. In materials for NF membranes, the governing mechanisms are even more complex and involve the effects of solute exclusion based on size, electrostatic, and dielectric effects. ED membranes are typically made from amphiphilic copolymers with cationic or anionic groups that are optionally chemically crosslinked. The composition and nanoscale (‘channel-in-matrix’) morphology strongly influence ion conductivity and selectivity, and the governing mechanisms are dominated by electrostatic and ion-exchange effects. In marked contrast, the only nanoscale effects that may be relevant for MD are related to the wetting of the pores by water or an aqueous feed, which depends on the hydrophobicity of the membrane surface and the (largest) pore size.

The goals of membrane development are the upscaling of fabrication to the required level and implementation in real-life processes. Hence, the common challenge in all efforts toward ‘better’ membranes that shall have a real impact is to find an appropriate balance between innovations in terms of intrinsic

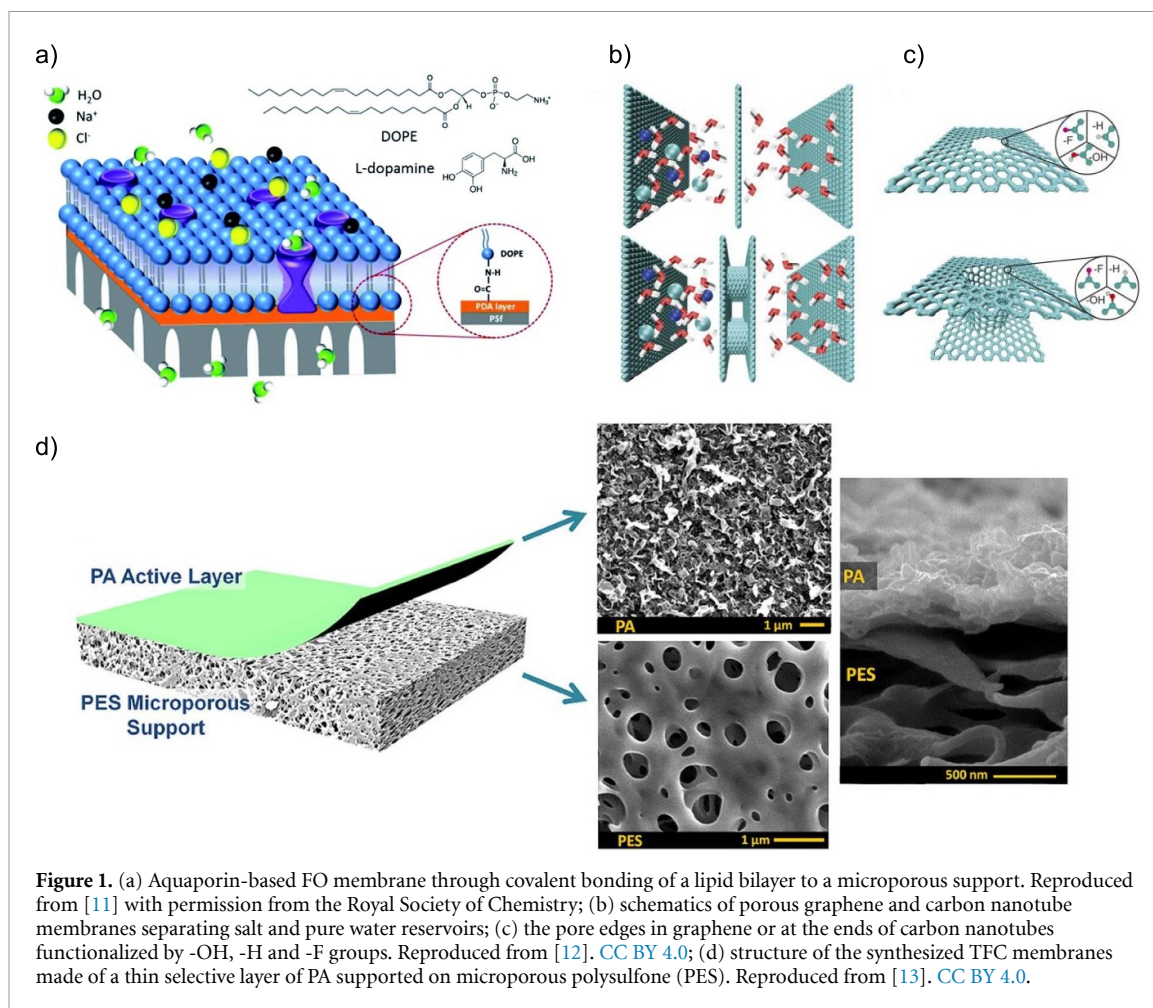
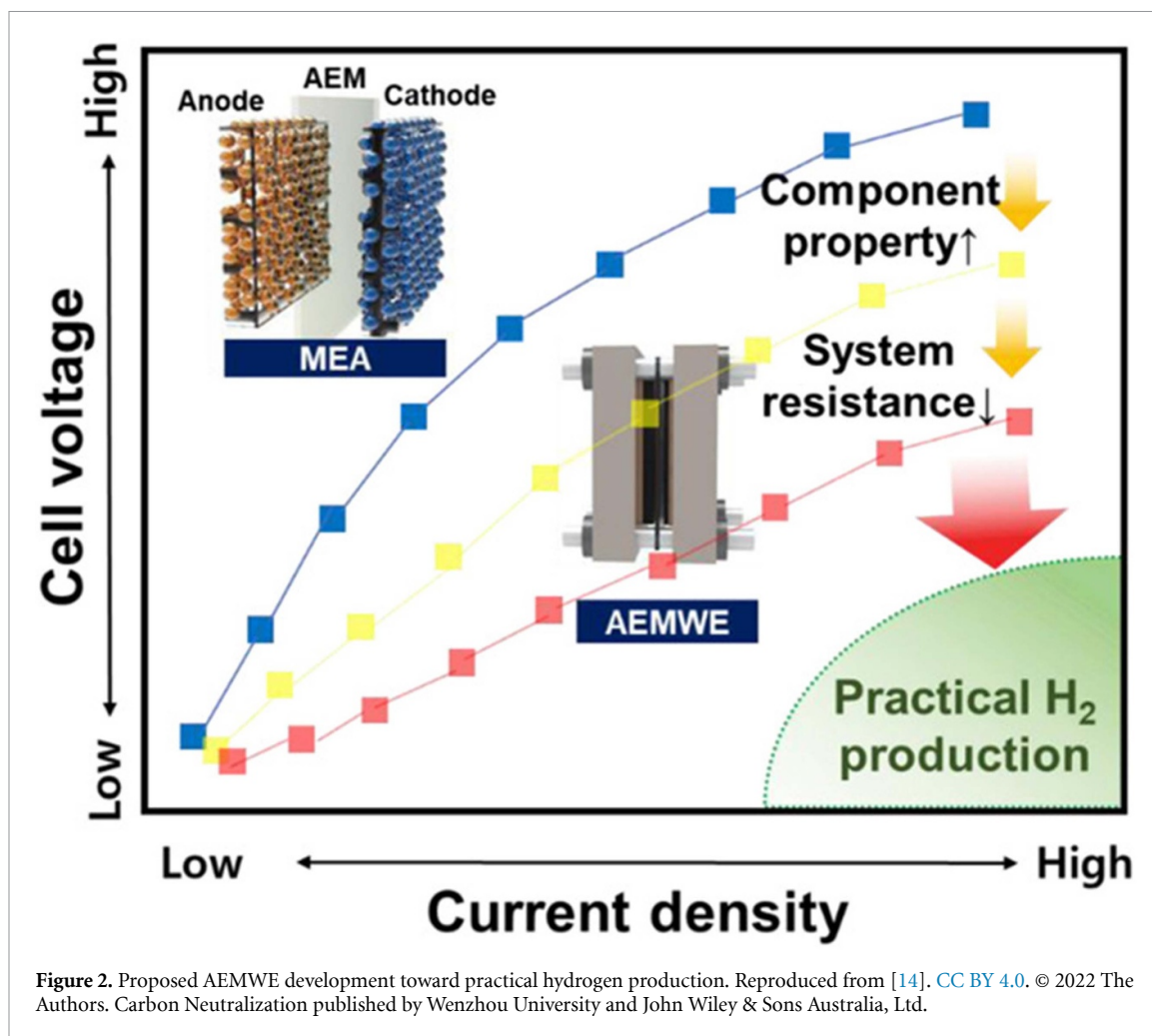

Figure 1. (a) Aquaporin-based FO membrane through covalent bonding of a lipid bilayer to a microporous support. Reproduced from [11] with permission from the Royal Society of Chemistry; (b) schematics of porous graphene and carbon nanotube membranes separating salt and pure water reservoirs; (c) the pore edges in graphene or at the ends of carbon nanotubes functionalized by -OH, -H and -F groups. Reproduced from [12]. CC BY 4.0; (d) structure of the synthesized TFC membranes made of a thin selective layer of PA supported on microporous polysulfone (PES). Reproduced from [13]. CC BY 4.0.

membrane properties based on sophisticated tailored structures on the one hand and sufficient robustness of fabrication processes and stability of performance under application conditions on the other.

Advances in science and technology to meet challenges

Almost all SWRO membranes and many NF membranes that are currently used for water desalination are TFC structures. TFC membranes are fabricated by casting a porous support with ultrafiltration membrane characteristics, typically from a polysulfone, followed by interfacial polymerization toward a thin PA film as barrier layer (figure 1(d)). The major research and development efforts in the recent decades can be classified into two categories: (i) step-wise (gradual) advancement of PA TFC-based technology platform; (ii) exploration of alternative materials as barrier layers (or at least of their suitability as functional additive in PA TFC membranes). The best industrial PA TFC SWRO membranes are close to physical limits based on the used materials and fabrication conditions [7]. Nevertheless, there are recent research papers that provide relevant new insights, e.g. regarding the effects of certain details of PA fabrication conditions toward markedly improved solute selectivity [15], or insights into the role of specific facets of nanoscale PA structure on permeance [16]. The vision for using alternative materials is to increase the water permeability of desalination membranes by orders of magnitude compared to the state-of-the-art. Important results have been obtained with very different structures such as aquaporins, single-wall carbon nanotubes, graphene in perforated or laminated configurations as well as other 2D materials as building blocks for water-selective membranes [17, 18]. However, the industrial implementation of such lab-scale membranes with ‘game changing’ higher performance had until now not been accomplished. The most important obstacles are a low density of selective pores, a large fraction of defects, limited stability, and complicated fabrication, translating into insufficient scalability. Furthermore, the maximum flux in RO-based seawater desalination will be limited by concentration polarization (and fouling), so that the intrinsic advantages of membranes with ‘orders of magnitude’-higher permeance can not be used in the established application technology framework. An example of realistic significant improvements is the successful integration of biomimetic AWC (based on the assembly of easily accessible specific small organic molecules) into PA TFC SWRO membranes, which leads to a substantial increase in permeance without compromising the high salt



rejection. Industrial implementation could lead to a significant decrease in the energy consumption of RO-based seawater desalination [19].

Polymer-based membranes for ED have been established for decades. Nevertheless, there is continuous further material development regarding advanced ion-exchange group structures and macromolecular architectures for higher selectivity, permeability and stability [8, 9]. Recent progress also in terms of industrial implementation of novel ion-exchange polymer membranes is triggered by the dynamic development of EMP in the energy sector, such as fuel cells or membrane-enabled systems for water electrolysis. Of particular interest for green hydrogen generation is the alkaline membrane electrolysis of water because non-noble metal catalysts can be used; however, a new generation of very stable anion-exchange polymer membranes is required [20] (figure 2). In that context, it is also relevant that not only the novel ion-exchange polymer but also the detailed membrane fabrication conditions have a major influence on the ultimate separation performance [21]. On the other hand, such stable ion-exchange polymers, when fabricated into thin barrier layers with nanoscale segregated ‘channel-in-matrix’ morphology in a TFC membrane, can also be of great interest for advanced NF or even SWRO separations [22].

In recent years, there is also rapidly increasing emphasis on the selectivity of desalination membranes [23, 24] not only in order to reduce the leakage of salt (or boron) during seawater desalination but also with view on recovery of valuable resources from various water sources including SWRO brine. Triggered by fast developments in the energy sector, in particular the exponentially increasing demand for Li ion batteries, a ‘boom’ regarding research on NF or ED membranes with maximum Mg/Li selectivity can be observed. This provides opportunities for alternative-barrier materials, in particular porous crystalline MOFs that have tailorable well-defined pores of Ångstrom size [25]. The challenge is still to obtain thin defect-free barrier layers of robust membranes. Another pathway is using liquid crystalline mesophases with ion-selective pores, but the design is less flexible and fabrication of stable ordered thin layers is complicated [26]. Furthermore, various biomimetic artificial ion channels with interesting transport selectivity have been reported, but their scalable integration into barrier layers of membrane for real applications has still not been realized [17].

In general, it is interesting that typical most promising ion-selective membranes have barrier structures where the combination of size- and charge-selectivity is used [18, 23, 27]. Furthermore, the influence of different driving force (pressure, concentration, or electrical potential) onto real ion selectivity of the same membrane is studied in detail; a relevant implication is that for actual separations pressure-driven NF, concentration-driven dialysis or electrically driven ED could be viable options.

The fundamentals of MD have been established for a long time, but large-scale industrial implementation has not yet been accomplished. Besides issues on the process and unit or module level, it is very well recognized that further improvement and optimization of MD membranes are crucial. A structure with large porosity and thin barrier is required for high permeance; however, the undesired wetting of pores by liquid water under (real) application conditions remains the critical bottleneck [28]. Membranes made from polymers that are intrinsically not wetted by water, i.e. polytetrafluoroethylene (PTFE, Teflon) or derivatives, are most robust but can still wet once fouling has reached a critical level. However, such polymers are expensive and—compared to other synthetic polymers—least sustainable. Therefore, an intense research and development is devoted to the fabrication and evaluation of MD membranes from various materials comprising different macro- and nanoscale morphologies. Electrospinning of nanofiber membranes is one prominent and potentially promising route. A recent overview on advanced and novel membrane concepts for MD can be found in the reviews by Qasim *et al* [9] and Chamani *et al* [28].

Concluding remarks

Both the adaptation of established membranes and the development of advanced or novel membranes are highly relevant for the further progress of membrane-based technologies in the context of the water-energy nexus. Therefore, exploration of novel concepts for barrier structures or membrane preparation methods has become an attractive and highly visible area in materials science and engineering. RO/NF, ED, and MD membranes, which are the focus of this section, have different barrier structures and separation mechanisms. Nevertheless, there are also common aspects of the different membrane processes, separation mechanisms, and challenges for application in aqueous systems. This reveals similarities in the guidelines for improving intrinsic performance with regard to the relationship between permeability and selectivity as well as for enhancing the robustness of the membranes as a precondition for stable separation performance. To make a true impact, the scalability of fabrication and implementation in real application scenarios must be considered in an early stage of membrane development.

2. Renewable energy-powered membrane desalination systems

Guillermo Zaragoza

CIEMAT-Plataforma Solar de Almería, Ctra. de Senés s/n, Tabernas 04200, Almería, Spain

CIESOL-Universidad de Almería, Ctra, Sacramento s/n, Almería 04120, Spain

Status

Currently installed desalination capacity exceeds 90 million $\text{m}^3 \text{d}^{-1}$ of desalinated water, and the estimated direct carbon footprint of desalination worldwide is roughly 120 million metric tons annually [29]. In the current climate crisis that requires decarbonization of the industry, the increasing growth of desalination must be associated with renewable energy use [30].

More than 70% of desalination worldwide is based on membrane technologies [31]. The most implemented is SWRO followed by NF and ED. They all require electrical energy. Of all the renewable energy sources that can be used to generate electricity, solar, wind and wave energy are the most suitable for desalination since biomass and hydroelectric intrinsically require water. The regional coincidence of high solar radiation and water scarcity have made solar energy the most prevalent [30]. An ascending desalination technology such as MD uses low temperature heat as FO does to a certain extent. This can be obtained from solar and geothermal energy. Nevertheless, their implementation is sporadic.

The main difficulty for coupling renewable energy sources with membrane desalination systems is the intermittent and fluctuating nature of the former, especially in the case of solar and wind energy, since the recommended operation of membrane technologies is steady state. Therefore, when there is a possibility to connect to the grid, renewable energy-powered desalination plants do so using renewable energy when it is available. When there is no grid or the connectivity to it is limited by the excessive load of the desalination plants, they must rely entirely on renewable energy. In this case, energy storage systems must be used to guarantee a stable operation. However, energy storage significantly increases the cost of renewable energy, especially in the case of electricity. This in turn increases the cost of desalinated water.

Technical solutions are needed to facilitate the coupling of renewable energy sources with membrane desalination technologies. Since renewable energy and membrane desalination are very different technologies, expertise from both fields is required.

Current and future challenges

The main challenge to power membrane desalination technologies with intrinsically intermittent renewable energy is that membrane performance and lifetime can be affected by discontinuous operation. Fluctuations in pressure and unsteady flow can also accelerate membrane compaction. Typically, the solution is to use batteries for storing the electricity generated with renewable sources and to connect the desalination systems to the batteries for steady supply of energy [32]. The use of batteries, however, is restricted to small-scale plants due to their high footprint and cost aggravated by their short lifetime. In addition, batteries are affected by environmental and geopolitical problems related to their life cycle and the scarcity of critical materials required to fabricate them. When the energy source is very varying as is the case of wind power, batteries and charge controllers are not enough to smooth out the fluctuations as they are limited by the charging/discharging rates. Thus, additional short-term energy storage devices are required to improve the stability.

An alternative to the use of batteries is hydraulic storage, pumping water to an elevated reservoir with renewable energy. The stored potential energy can be used steadily to produce electricity or even directly the pressure required by the SWRO pump [33]. However, this application is limited geographically and in size.

On the energy side, the choice of renewable sources can be important. CSP benefits from storing high temperature heat in molten salts before converting it to electricity (typically in steam Rankine cycles). PV and wind power, however, is not dispatchable and has a lower capacity factor. Despite this strength as an energy source for desalination, the cost of CSP electricity is still higher than that of PV or wind [34]. Wave energy is still in a pre-commercial state and more research and experimental work is needed for coupling to SWRO [35].

As for heat-powered membrane desalination technologies, since the operating temperature of MD is low (typically 80 °C), stationary solar collectors are sufficient to generate the required heat. Concentrating collectors can be used in regions with direct solar radiation. However, since they operate at higher temperature, it can be more feasible to exploit the economy of scale and use the concentrated collectors in large-scale CSP plants for the cogeneration of electricity and water. For the latter, an optimal coupling between MD operation and the low temperature waste heat from the turbine of CSP plant must be engineered.



Figure 3. (a) PTC in operation, i.e. a parabolic trough collector used for CSP production. (b) A field of solar PV collectors. (c) A view of a field of stationary flat plate solar collectors that can supply heat at 80 °C.

Advances in science and technology to meet challenges

To meet the overarching challenge, given the higher cost of steady supply of renewable energy, the energy use of membrane desalination should be minimized. This is more difficult for RO which is not far from its thermodynamic limit [36]. However, the overall efficiency of the plant can be enhanced with hybridization, i.e. by recovering the osmotic energy of the rejected brine with SGP technologies [37]. Batch and semi-batch operation is another strategy to reduce the SEC of SWRO [38]. Improved membranes can help reduce the energy consumption of NF and ED together with improved stacks for the latter. For MD, the use of long spiral-wound modules in vacuum-assisted air-gap configuration has shown maximum thermal efficiency [39], but further improvements in operation and membrane efficiency can push it further.

To reduce the cost of steady supply of energy, advances in energy storage systems are also needed. Batteries must be made cheaper with longer discharge times and using renewable materials [40]. Storing energy in hydrogen is another option, but the conversion efficiency must be improved at both ends. For short-term fluctuations, flywheels [41], supercapacitors [42] or compressed air storage [43] is options to develop. In the case of already-dispatchable CSP, the development of more efficient Brayton cycles that operate with air or supercritical CO₂ is proposed [44].

Ultimately, the main technological advances for using renewable energy in membrane desalination must come with variable operation, varying the production rate and permeate recovery vary to adjust the power consumption to the available energy. Developments in model predictive control [45] and AI tools [46] have shown great promise for SWRO as well as MD [47]. However, variable operation needs to be supplemented by developing more resistant membranes.

When there is a grid connection, modular operation of desalination plants can play an important role in enhancing the penetration of renewable energy. Often, when their generation exceeds the load on the grid, the renewable energy plants are disconnected, and that energy is lost since large-scale storage of electricity is yet unfeasible. By increasing the demand from the desalination plants, excess generation can be used and converted into desalinated water. This discontinuous operation requires advances in smart grid management and control strategies.

Concluding remarks

Renewable energy sources can decarbonize the desalination industry. However, their intermittency and fluctuations are barriers for membrane technologies designed for stable operation.

When the electric grid is available as a backup, modular and intermittent operation of large-scale SWRO plants as load elements on the grid can enhance the penetration of renewable energy on the grid. When there is no grid and the only energy source for desalination is renewable, improvements in energy storage are required. Membrane desalination technologies powered by heat have less problems because heat is easier and cheaper to store, but they need to improve their energy efficiency.

Nevertheless, storage always comes at an additional cost and variable operation of membrane desalination technologies can be cheaper in all cases. To implement it successfully, advanced control systems using AI tools are required, complemented by short-term energy storage devices that smooth out fluctuations and enhance the window of acceptable operating conditions, facilitating the control.

3. Offshore membrane desalination facilities powered by renewable energy

Jack Gilron and Avner Ronen*

The Zuckerberg Institute for Water Research, Ben Gurion University of the Negev, Israel

E-mail: avnerr@bgu.ac.il

Status

Large desalination facilities based on membrane technology (e.g. SWRO) used to supply high quality drinking water are relatively energy intensive and require occupation of land in prime locations near the ocean [48].

An important aspect in reducing the energetic and environmental footprint of desalination is by addressing the system design and operation, specifically by optimizing the configuration and operation of desalination systems based on the specific water source and energy source [49, 50]. Desalination based on renewable energy was already shown feasible on a commercial scale (e.g. Ocean Oasis for wave energy, and Ocean Sun for solar energy).

In addition, the discharged brine stream can be used to produce additional energy through coupling SWRO with PRO [51] or RED [52].

Potential new energy savings can be found in locating SWRO plants offshore [53, 54]. These can be built on artificial islands or floating platforms (see figure 4). While in conventional SWRO facilities, a significant energy cost (up to 1 kWh m^{-3}) is associated with pumping the feed from offshore to the desalination plant and pumping the brine to an outfall that is often as far as 2 km offshore, in an offshore desalination facility, the costs associated with pumping the feed and discharging the brine are significantly lower. In addition, designing such desalination facilities in offshore locations will release land near the shores while reducing the need for long-distance water transmission infrastructure. Furthermore, they will reduce the environmental impact of desalination associated with seawater intakes and brine discharge as they are located in deep water, where marine life is less likely to be affected [55–57].

Current and future challenges

One of the main challenges related to offshore desalination is the storage and continuous energy production onsite versus taking energy from power plants located along the shore. Furthermore, offshore production of renewable energy should match the specific desalination unit operation and the feedwater qualities (e.g. wind and wave energy for seawater SWRO desalination as compared to onshore PV solar energy for ED of brackish water) [58, 59].

In addition, the harsh ocean environment, which can damage the desalination equipment and make maintenance and repairs more difficult, requires optimization of the location of the offshore plant. Furthermore, selection of a location must be accompanied by an optimization study addressing the distance of feed intake and brine discharge while considering the energy and cost of transporting the product water to the shore and the cost of constructing and operating the offshore platform or ship. Finally, there is a need to search for an optimum in distributing intake and pretreatment versus centralizing the SWRO section.

Advances in science and technology to meet challenges

As we believe the future of desalination lies in offshore facilities powered by renewable (hybrid) energy, there is a need to address the deployment of renewable energy devices conducive to open ocean environments (e.g. wave and wind energy). Furthermore, there is a need to develop technologies that directly couple the desalination process with mechanical energy. Solar energy (i.e. PV) may be less favorable for offshore facilities due to the impact of sea spray on panels. Different energy storage techniques should be explored, including supercapacitors [60] and mechanical storage (accumulators) for intermittent power generation. The impact of intermittent operation from wind and wave on SWRO operation should also be examined in terms of reduction membrane fouling [61].

Furthermore, there is a need to study the impacts of seawater intake and brine discharge resulting from offshore desalination facilities (2–12 km from the shore) as such facilities will discharge brine in deeper oceans (as far as 12 km from shore) but closer to desalination facilities. The assessment should include the impact of feed intake and brine outfall on deep ocean ecology (currently most research addresses the impact of brine discharge on the marine environment near the shores [62, 63] and on desalination pretreatment requirements. Current assessment claims that deep offshore desalination facilities have less environmental impacts in terms of effects on coastal circulation, sediment transport regime, brine discharge, and water intake (see figure 5). Furthermore, as the marine environment in deep sea contains lower concentrations of plankton and other microbiota, the cost associated with pretreatment could be reduced. In addition, the

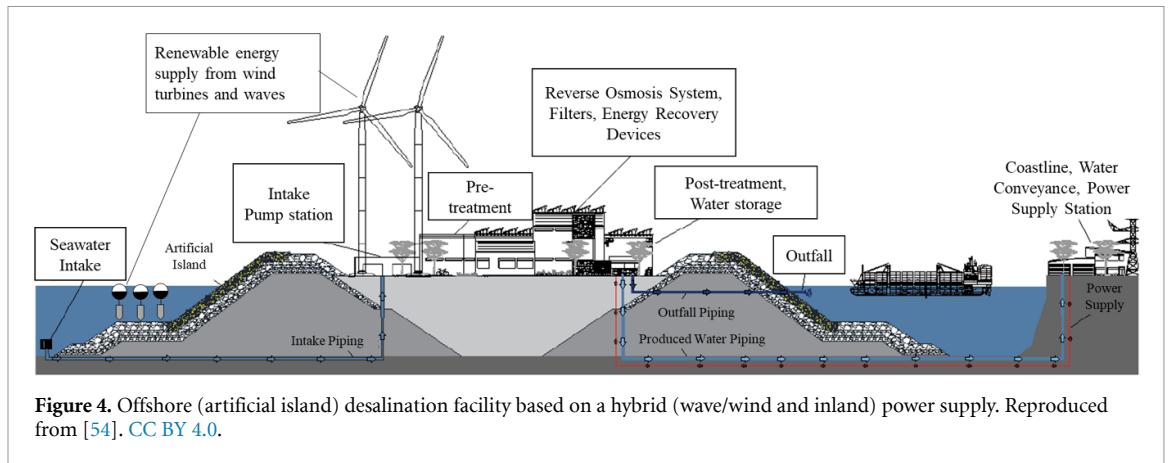

Figure 4. Offshore (artificial island) desalination facility based on a hybrid (wave/wind and inland) power supply. Reproduced from [54]. CC BY 4.0.

Criteria	Effect on coastal circulation	Effect on sediment transport regime	Land use	Effects of brine/chemical discharge	Effects of water intake
Onshore					
1 km offshore					
5 km offshore					

Figure 5. Qualitative assessment of the environmental impacts of offshore desalination facilities compared to an onshore facility. The darker the box, the more severe the environmental impact. Reproduced from [54]. CC BY 4.0.

crude oil contamination from oil tankers mainly occurs in shallow seas; therefore, an offshore desalination plant may be less susceptible to crude oil spills.

Overall, knowledge from the construction and operation of oil and gas production platforms should be exploited and expanded to design robust functioning offshore desalination platforms.

Concluding remarks

As previously mentioned, the scope for increased effectiveness of new membrane materials in increasing energy efficiency for seawater desalination is limited. Instead, the most promising approach is to make changes to the system design. A potential solution is the offshore deployment of large-scale desalination facilities, which can result in cost savings by reducing the volume of seawater that needs to be pumped from the sea to the shore (product only, rather than feed) and minimizing the distance that brine must be pumped from the desalination plant to the open sea to avoid damaging coastal ecosystems. Another promising solution is to use renewable energy sources directly for desalination, which can help decrease energy consumption and costs. The necessary engineering and scientific studies have been outlined for implementing this approach.

4. Energy effectiveness in membrane-based desalination

Antonio Politano¹, Sergio Santoro², Giuseppe D'Andrea², Ming Zhou³, Efrem Curcio², Dimitri Xevgenos⁴ and Avner Ronen^{5,*}

¹ Department of Physical and Chemical Sciences, University of L'Aquila, 67100 L'Aquila, Italy

² Department of Environmental Engineering, University of Calabria, Via Pietro Bucciubò 44A, 87036 Rende, CS, Italy

³ State Key Laboratory of Materials-Oriented Chemical Engineering, National Engineering Research Center for Special Separation Membrane, Nanjing Tech University, Nanjing 210009, People's Republic of China

⁴ Engineering Systems & Services Department, Technology Policy & Management faculty, Delft University of Technology, Jaffalaan 5, 2628 BX Delft, The Netherlands

⁵ The Zuckerberg Institute for Water Research, Ben Gurion University of the Negev, Israel

E-mail: avnerr@bgu.ac.il

Status

The call for evaluating the impact of anthropic activities on energetic and water resources is exponentially increasing. In fact, the energy efficiency and water footprint are crucial performance attributes in determining the viability and sustainability of a process, raising the dilemma about the water-energy nexus.

The significance of the energy efficiency in membrane desalination is paramount as it directly affects the cost and environmental sustainability of the technology. The universal thermodynamic limit to recover 50% of water from seawater is estimated by Gibbs equations in 1.06 kWh m^{-3} [64]. Unfortunately, the effective SEC of current desalination plants is in the range of $3\text{--}5 \text{ kWh m}^{-3}$.

Historically, the first desalination plants installed in 60' were based on thermal evaporation of the water and its subsequent condensation, such as MED and MSF. Despite the implementation of strategies for energy recovery, both MED and MSF require an important energetic input for the thermal change of phase ($12.2\text{--}23.5 \text{ kWh m}^{-3}$) [64]. To this, at least 2 kWh m^{-3} must be added for pumping systems [65]. Overall, the relevant SEC has limited the operation of thermal desalination plants in areas with enormous availability of fossil fuel resources with the ultimate result is that the cost of freshwater desalted in large-scale plants via thermal processes lies in the range of $0.52\text{--}1.56 \text{ US\$ m}^{-3}$ [65].

The SEC of desalination has been significantly reduced over time and efficient SWRO plants currently operate at $3\text{--}4 \text{ kWh m}^{-3}$ with capacity higher than $10\,000 \text{ m}^3 \text{ day}^{-1}$ and TDS concentration of approximately $30\,000\text{--}40\,000 \text{ mg l}^{-1}$ (figure 6) [48]. The largest part of the SEC is employed to pressurize the seawater at more than 55 bar to promote the transport of the water through the membrane exciding the osmotic pressure and the resistance of the membrane. The necessity to provide a significant amount of electrical energy (in large part generated by fossil fuels) to drive high-pressure RO pumps results in a significant emission of greenhouse gasses (the estimated carbon footprint of SWRO desalination ranges between 0.4 and $6.7 \text{ kg CO}_2\text{eq m}^{-3}$ [66] impacting negatively on the environment.

Despite SWRO being the leading technology in the desalination industry, in 1999, only 10% of the desalted freshwater was obtained by exploiting this membrane process [67]. The exponential growth of SWRO (accounting today more than 65% of the global capacity [68]) has been helped by: the development of highly-permeable membranes and the employment of ERD. In fact, the advent of cellulose acetate asymmetric membranes thanks to Loeb and Sourirajan represent a significant step on the way of industrialization of SWRO [69]. Their work has opened the door for the preparation of membranes with thin selective layer securing high-water permeability at low feed pressure. Current SWRO plants are equipped with TFC membranes with an ultra-thin PA selective layer ($0.1\text{--}1 \mu\text{m}$) responsible for a permeability of $1\text{--}2 \text{ LMH bar}^{-1}$ [70]. Because of the high mass transfer through the membrane, the desalted water results pressurized and ERDs are able to recover the hydraulic energy from the permeate exploitable for the mitigation of the SEC.

Nevertheless, SWRO remains energy intensive, as electrical energy constitutes 35%–40% of total operating costs, leading to a production cost of $0.45\text{--}0.66 \text{ US\$ m}^{-3}$ [65].

Current and future challenges

A primary challenge in membrane desalination is the high energy consumption associated with the process. The development of more energy-efficient desalination technologies is crucial to minimize environmental impact and make clean water accessible to a larger population.

Furthermore, advancements in energy storage technologies will enhance the integration of renewable energy sources into desalination processes. Efficient storage systems can help mitigate the intermittent nature of solar and wind energy, ensuring a stable and continuous power supply for desalination plants.

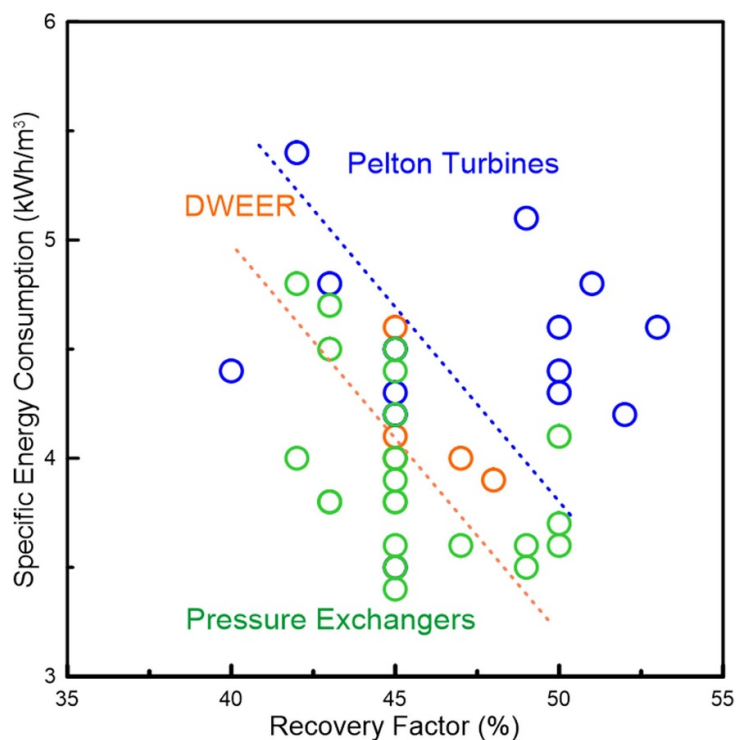

Figure 6. SEC vs recovery factor of SWRO desalination plants integrating different typologies of ERD. Data from [48].

MD is a hybrid thermal-membrane process able to desalinate seawater by evaporating water at the micropore mouths of a hydrophobic membrane; the water vapor, diffusing through the membrane under a partial pressure gradient, is collected at the permeate (or ‘distillate’) side. From a thermodynamic point of view, the evaporative nature of the separation process makes MD an inherently more energy-intensive process than RO: the latent heat of vaporization for water—depending on the temperature and salinity—is around 2400 kJ kg^{-1} , corresponding to about 670 kWh m^{-3} [71]. However, MD can harvest renewable thermal sources, low-grade or waste heat, and to operate at high water recovery factor since unlike RO—MD is not limited by osmotic phenomena and is less sensitive to concentration polarization. Moreover, the opportunity to implement internal heat recovery (offered, for instance, by AGMD configuration and related variants) or to use external heat exchangers (e.g. in Direct Contact Membrane Distillation configuration) increases the energy efficiency by exploiting the latent heat of condensation accumulated at the distillate side in order to pre-heating the feed stream. Thermal desalination technologies have also been employed for treatment of seawater desalination brines. Xevgenos *et al* demonstrated the use of forward-feed multiple effect distillation systems for concentrating the brine from 7% to 26% through the use of solar energy [72–74].

GOR is a dimensionless energy parameter widely adopted to compare different thermal systems; in MD, GOR is defined as the ratio between the energy required for vaporizing the total distillate produced and the thermal energy added externally to the system. GOR is a global measure of the system energy efficiency: higher GOR values—achieved by maximizing both the recovery of the latent heat of vaporization and the exploitation of the driving force (through the reduction of the heat conduction loss across the membrane and the mitigation of TP)—correspond to better MD performance. Figure 7 collects GOR data for AGMD configuration and related variants for some pilot-scale studies reported in the literature (membrane area between 7.2 and 25.9 m^2) [75].

Regarding MD, despite the progress made in TP mitigation, several challenges remain that must be addressed to fully harness the potential of MD systems.

Firstly, the development of novel materials to enhance heat transfer and minimize TP is an ongoing challenge. Second, the optimization of feed channel designs is crucial to enhance local mixing and heat distribution at the membrane-feed interface. While various designs have been proposed, there is no one-size-fits-all solution. Different applications and operating conditions require tailored designs that strike a balance between mitigating TP and maintaining energy efficiency. Additionally, the scalability of these designs for large-scale operations must be evaluated. Moreover, the development of self-heated MD systems offers significant potential for improved energy efficiency and distillate flux. However, these systems are still in their infancy stage and require further optimization for commercialization and scale-up. Challenges

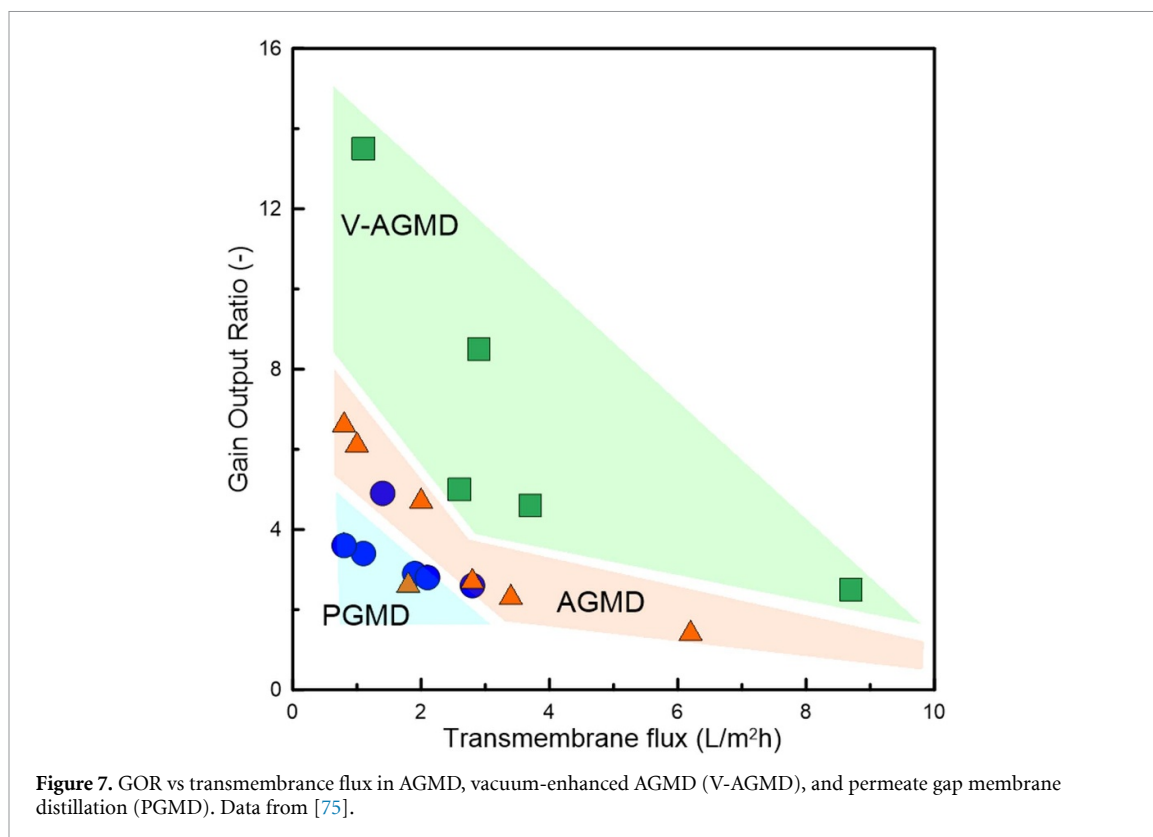

include the need for novel materials that can be used for self-heating, addressing limiting phenomena such as concentration polarization and scaling, and developing designs that can simultaneously enhance mixing and directly heat the membrane-feed surface.

It is imperative to incorporate renewable energy sources, notably solar or PV cells, into self-heating MD systems to diminish energy expenditure and enhance environmental sustainability. By focusing on the augmentation of energy conversion and the advancement of storage technologies, it is possible to effectively harness the potential of renewable energy within the context of self-heating MD systems.

Integrating renewable energy sources with membrane desalination systems presents another challenge. Using solar, wind or geothermal energy can decrease the carbon footprint of desalination operations and augment their sustainability. However, the intermittent nature of renewable energy sources necessitates creative solutions for energy storage and management to ensure the continuous operation of desalination plants.

Advances in science and technology to meet challenges

The technological innovation should target the refinement of ERD that recapture energy from the high-pressure brine stream in RO systems. By improving the efficiency of ERDs, the overall energy usage of these systems could be significantly reduced.

In addition to material and mechanical improvements, the integration of machine learning algorithms for process optimization could be valuable. These algorithms could be employed to track variables like water pressure, volume, salinity, recovery ratio, time, and energy and adjust these variables over time to achieve optimal energy efficiency.

Moreover, the development of a process known as ‘batch counterflow reverse osmosis’ has demonstrated the potential. This process recirculates specific concentrations of water on both sides of the membrane and is the most energy-efficient desalination process for high-salinity water.

One of the challenges associated with MD is TP, a phenomenon that reduces the temperature gradient across the membrane and impedes the efficiency of the process. However, technological advancements can help mitigate this issue by improving heat transfer and fluid dynamics thereby maintaining the temperature gradient necessary for efficient desalination. Unfortunately, due to access restrictions, it was not possible to cite specific research papers that discuss recent advances in addressing TP in MD. Nonetheless, addressing TP is a crucial aspect to improve the energy efficiency of membrane desalination processes.

Renewable energy sources such as solar, wind and hydropower are becoming more accessible and cost-effective, making them ideal alternatives to fossil fuels for powering membrane desalination systems. As

the prices continue to decrease, these energy sources become more viable for large scale desalination applications. For example, CSP plants could be used to generate the thermal energy required for MED or MSF desalination processes. Similarly, wind and hydropower can provide electricity to drive SWRO systems.

Scaling and fouling of membranes pose additional challenges for energy efficiency in membrane desalination. The buildup of salts, organic matter, and other impurities on membrane surfaces can result in reduced water permeability and increased energy consumption.

Developing effective anti-fouling strategies such as surface modification and advanced cleaning techniques is critical for maintain the energy efficiency and longevity of membrane systems.

Lastly, the development of theoretical models and simulation tools to accurately describe heat and mass transfer mechanisms in MD processes is necessary. These tools will aid researchers in optimizing membrane materials, feed channel designs, and heating methods for TP mitigation, ultimately resulting in more efficient and scalable MD systems.

Concluding remarks

The escalating demand for clean water necessitates the development and implementation of sustainable and cost-effective desalination solutions. Advancements in renewable energy sources, materials science, and system design and operation hold immense potential for enhancing the energy efficiency of membrane desalination processes.

It is crucial to continue pushing the boundaries of innovation to develop and refine membrane desalination technologies that are both energy efficient and environmentally sustainable. Integration of renewable energy sources into desalination systems can mitigate our dependence on fossil fuels while bolstering sustainability. Cutting-edge membrane materials can augment permeability and selectivity while curbing energy consumption. Enhanced system design and operation can elevate durability and reduce operational costs.

The integration of renewable energy sources like solar, wind, and hydropower into desalination systems offers a sustainable and increasingly cost-effective alternative to traditional fossil fuels. The continual development and refinement of novel membrane materials and optimization of system design and operation contribute to advancements in permeability, selectivity, and durability. These innovations ultimately reduce energy consumption and operational costs.

The collaboration of various stakeholders including governments, industries, and research institutions is of paramount importance in fostering innovation and catalyzing the adoption of energy-efficient desalination technologies.

The future of desalination technology hinges on our capacity to continuously innovate and refine the processes. Integration of renewable energy sources into desalination systems can significantly reduce our reliance on fossil fuels while ensuring sustainability. Novel membrane materials hold the potential to enhance permeability and selectivity while minimizing energy consumption. Furthermore, the optimization of system design and operation can augment durability and decrease operational costs.

5. Light-to-heat conversion in nanomaterials

Antonio Politano¹, Jessica Occhiuzzi¹, Gianluca D'Olimpio¹, Maya Bar-Sadan², Despina Fragouli³, Athanassia Athanassiou³ and Anna Cupolillo⁴

¹ Department of Physical and Chemical Sciences, University of L'Aquila, 67100 L'Aquila, Italy

² Department of Chemistry & Ilse Katz Institute for Nanoscale Science and Technology, Ben-Gurion University, Be'er Sheva 8410501, Israel

³ Smart Materials, Istituto Italiano di Tecnologia, via Morego 30, Genova 16163, Italy

⁴ Department of Physics, University of Calabria, Via P. Bucci cubo 31/C, 87036 Rende, CS, Italy

Status

While MD emerged as a hybrid membrane-thermal technology able to exceed the water recovery factor of SWRO—being unaffected by osmotic pressure—and to distillate water at low temperature (40 °C–60 °C), the intrinsic heat losses in the membrane module—named TP—have hampered its industrial feasibility by reducing the productivity of the process and raising the SEC. In this section, we will illustrate the opportunities to overcome TP by photothermal effects in nanomaterials.

In recent years, the opportunity to exploit metal nanostructures as nano-sources of heat tunable with light has originated the fast-growing field of thermoplasmonics [76–81] revolutionizing the concept of heat harvesting. Upon illumination at the plasmon frequency, metal NPs display enhanced light absorption enabling efficient light-to-heat conversion [82]. Recently, thermoplasmonic effects have been successfully exploited for photothermal cancer therapy [80, 83–88], photothermal actuators [89], nanofurnaces for heterogeneous catalysis [90], solar-driven hydrogen generation [91–93], and solar-driven water evaporation [94–101]. Interestingly, the embodiment of thermoplasmonics in membranes has gained great attention demonstrating the potential to mitigate the water-energy nexus in MD by reducing the anthropic energy input required to heat-up the feed and increasing the productivity of the desalination operation by overcoming the TP [102–109].

Thermoplasmonics is a process that occurs when light interacts with metallic NPs or nanostructures, which leads to the excitation of LSPRs. These resonances induce strong electromagnetic fields around the NPs which can be converted into heat by non-radiative decay of the plasmons. The efficiency of this process depends on the absorption cross-section, the quality factor, and the thermal conductivity of the NPs as well as the spectral overlap between the LSPR and the incident light [81].

Exciton-mediated processes, on the other hand, involve the absorption of photons by molecules or semiconducting materials, which leads to the generation of excitons (bound electron-hole pairs). The excitons can then decay radiatively or non-radiatively, with the latter resulting in heat generation. The efficiency of this process is determined by the absorption cross section, exciton lifetime, and thermal conductivity of the material [91, 110–112].

In recent years, there have been significant efforts to develop photothermal materials that can efficiently convert light into heat. Semiconducting nanocrystals have shown great potential for photothermal applications [113]. These materials have high absorption cross-section, and their absorption can be tuned by changing their size and composition. Moreover, photothermal effects were also reported for other classes of sustainable materials, such as carbonized biowastes [114], composite cryogels [101], and foams [115].

In general, replacing Ag and Au with cheap materials exhibiting plasmonic resonances matching with the solar spectrum is one of the main open challenges of the whole plasmonic community [116]. Recently, several candidates for have emerged, such as nitrides (TiN [117] and HfN[118]), SnS₂ [119]/SnSe₂ [120], xenes (phosphorene [121], arsenene [122], stanene [123]), titanium carbides (namely, MXenes [124, 125]), metal oxides [126–129], etc. However, most of them have poor photothermal efficacy [130] and high chemical instability with spontaneous oxidation already at room temperature, as in the case of Mxenes [131] or tin dichalcogenides [132].

Current and future challenges

Despite their potential, photothermal materials pose some challenges that must be overcome to make their use widespread in the technology.

One of the primary challenges with photothermal materials is their efficiency in converting sunlight into heat. The efficiency of photothermal materials can be influenced by various factors including the material's optical properties, the concentration of solar energy, and the temperature at which the material operates. Increasing efficiency of photothermal materials is crucial to make them cost-effective for large-scale applications such as solar membrane desalination.

Furthermore, a significant challenge in the field of photothermal materials is the reproducible and accurate quantification of a material's ability to convert light into heat. This light-to-heat conversion is a

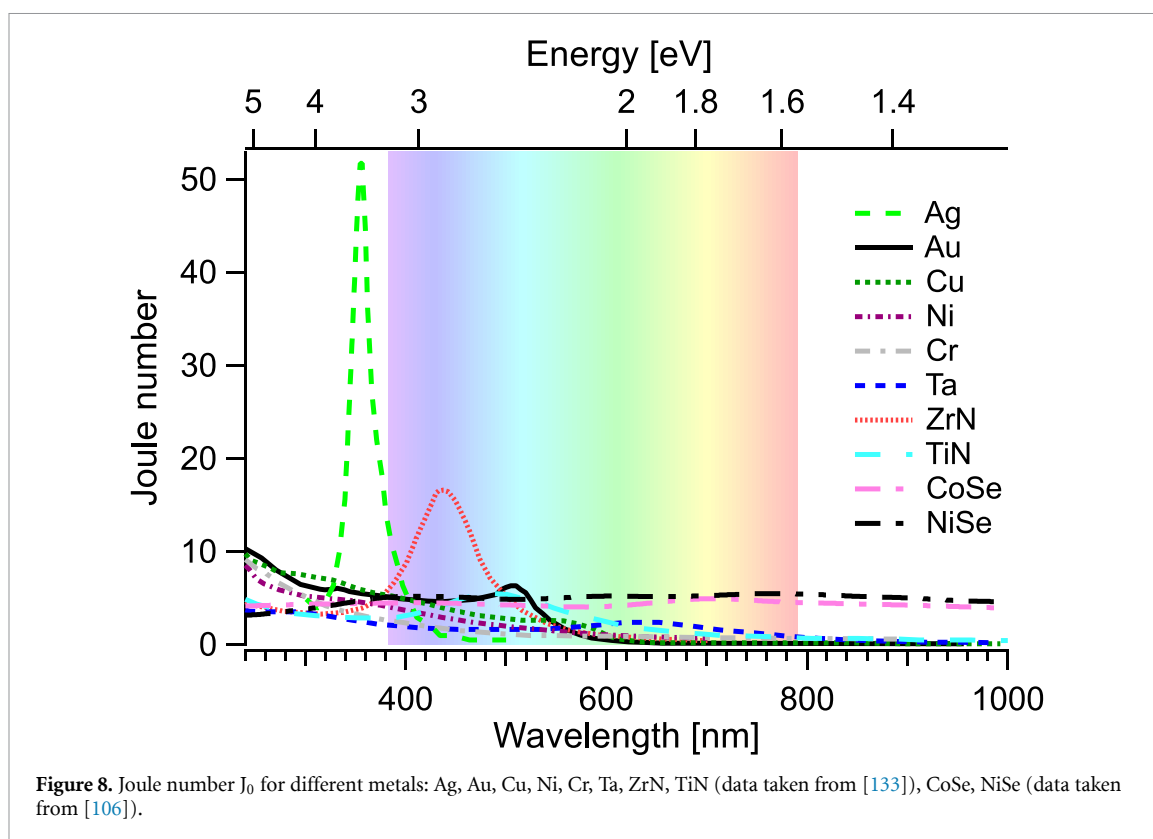

fundamental characteristic that determines the efficiency and effectiveness of photothermal materials in various applications. However, achieving consistent and easily measurable parameters for this conversion process remains a complex task, although the Joule number introduced in [133] represents a reasonable figure of merit (figure 8). The measurements must be conducted under controlled conditions, and the initial temperature of the testing environment and the material itself should ideally be identical to ensure a consistent starting point. Overcoming this challenge is crucial for the advancement of photothermal materials and their potential applications.

Another challenge with photothermal materials is their stability and durability. The nanomaterials used for photothermal conversion acting as nanoscale thermal hotspots (figure 9) must be able to withstand harsh environmental conditions, such as extreme temperatures, high salinity, and corrosive media. The materials must also maintain their properties over time to ensure the longevity of the system. Research is ongoing to develop photothermal materials with improved stability and durability to enable their widespread use in renewable energy applications.

The scalability of photothermal materials is another challenge that must be addressed. To be cost-effective for large-scale applications such as solar membrane desalination, photothermal materials must be manufactured at scale. However, the production of these materials is still relatively expensive, and their synthesis often requires complex processes. Therefore, reducing the cost and simplifying the manufacturing process is essential to make photothermal materials more accessible to a wider range of applications.

Finally, the integration of photothermal materials with existing technologies is a significant challenge. Photothermal materials must be compatible with other components such as membranes to achieve optimal performance. The integration of nanofillers in polymeric membranes implies the emergence of thermal collective phenomena (figure 9(g)). Achieving compatibility with existing technologies and developing new systems that leverage the unique properties of photothermal materials is critical to enable their adoption in renewable energy applications such as solar membrane desalination.

Advances in science and technology to meet challenges

Historically, individual plasmonic materials were initially identified mainly by intuition, trial, and error, and analogy to other materials, often with successive theoretical models to unveil their connection with band structure [136, 137]. However, recent efforts to perform a systematic analysis of band structure [138, 139] can provide step-change support in the quest of photothermal materials with desired features in terms of excitation spectrum and light-to-heat conversion efficiency [136]. Such a materials genome approach, now implemented in open-source databases [140], is ideal for achieving a band-structure engineered platform for

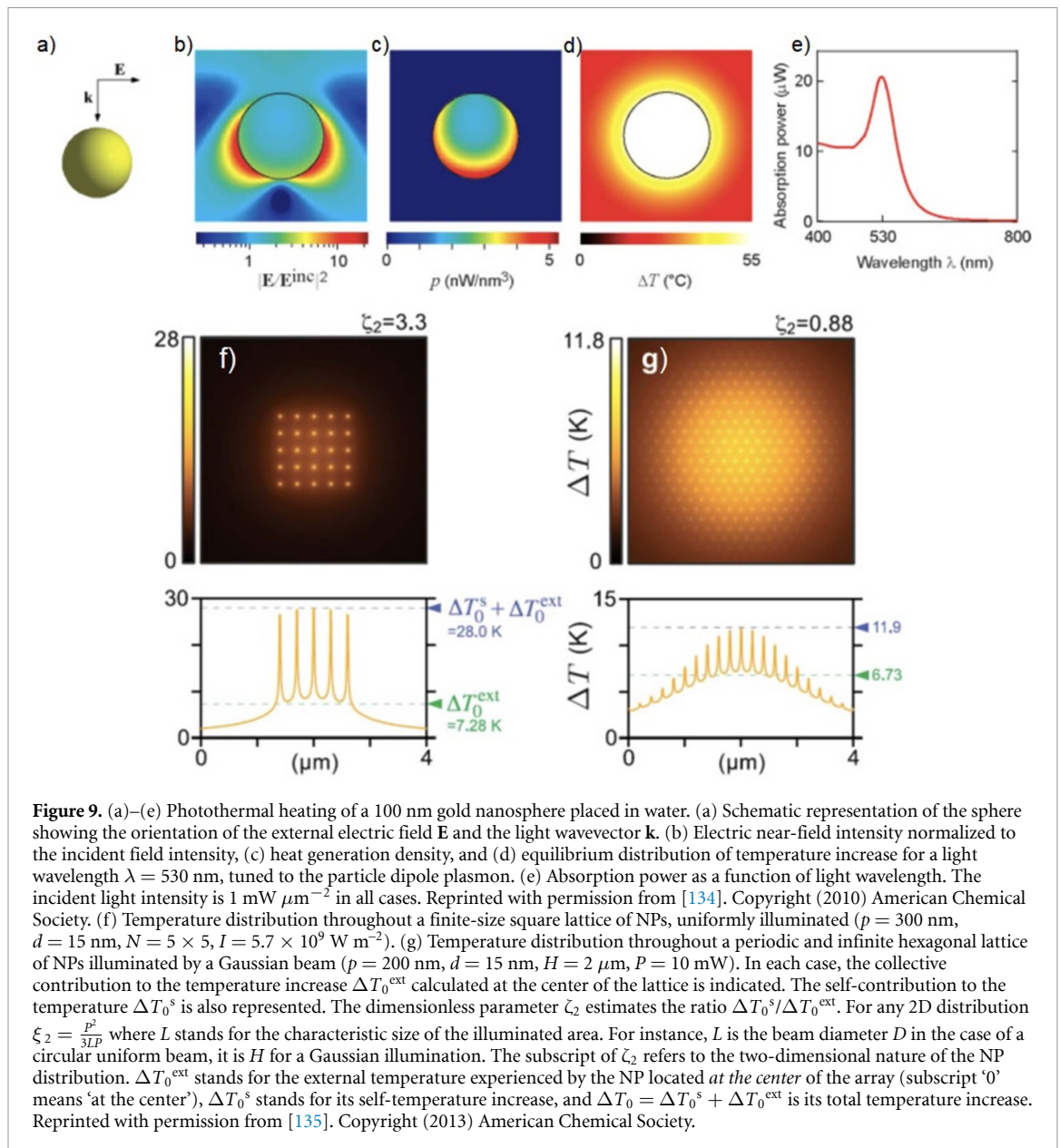

Figure 9. (a)–(e) Photothermal heating of a 100 nm gold nanosphere placed in water. (a) Schematic representation of the sphere showing the orientation of the external electric field E and the light wavevector k . (b) Electric near-field intensity normalized to the incident field intensity, (c) heat generation density, and (d) equilibrium distribution of temperature increase for a light wavelength $\lambda = 530$ nm, tuned to the particle dipole plasmon. (e) Absorption power as a function of light wavelength. The incident light intensity is $1 \text{ mW } \mu\text{m}^{-2}$ in all cases. Reprinted with permission from [134]. Copyright (2010) American Chemical Society. (f) Temperature distribution throughout a finite-size square lattice of NPs, uniformly illuminated ($p = 300$ nm, $d = 15$ nm, $N = 5 \times 5$, $I = 5.7 \times 10^9 \text{ W m}^{-2}$). (g) Temperature distribution throughout a periodic and infinite hexagonal lattice of NPs illuminated by a Gaussian beam ($p = 200$ nm, $d = 15$ nm, $H = 2 \mu\text{m}$, $P = 10$ mW). In each case, the collective contribution to the temperature increase ΔT_0^{ext} calculated at the center of the lattice is indicated. The self-contribution to the temperature ΔT_0^s is also represented. The dimensionless parameter ζ_2 estimates the ratio $\Delta T_0^s / \Delta T_0^{\text{ext}}$. For any 2D distribution $\zeta_2 = \frac{P^2}{3LP}$ where L stands for the characteristic size of the illuminated area. For instance, L is the beam diameter D in the case of a circular uniform beam, it is H for a Gaussian illumination. The subscript of ζ_2 refers to the two-dimensional nature of the NP distribution. ΔT_0^{ext} stands for the external temperature experienced by the NP located at the center of the array (subscript ‘0’ means ‘at the center’), ΔT_0^s stands for its self-temperature increase, and $\Delta T_0 = \Delta T_0^s + \Delta T_0^{\text{ext}}$ is its total temperature increase. Reprinted with permission from [135]. Copyright (2013) American Chemical Society.

thermoplasmonics and related applications. By engineering materials with specific band structures, the solar spectrum can be utilized effectively, leading to a significant increase in photothermal efficiency. Anisotropy in crystals [141, 142], together with associated anisotropic optical properties, open new avenues for photothermal enhancement [143]. Following the successful application of electromagnetic anisotropy in various optical devices [144–148], similar principles could be leveraged to develop photothermal materials with superior light-to-heat conversion efficiency, also by improving the matching with the sunlight radiation spectrum.

Reproducibility and precision in quantifying a material’s light-to-heat conversion efficiency remain paramount. Standardizing methodologies using advanced tools such as spectrophotometry to measure reflectance and transmittance is essential. Establishing temperature-independent heat dissipation coefficients for both laser and electric heating methods can ensure more accurate calculations of light-to-heat conversion efficiency [149]. Such advances could expedite the development of highly efficient photothermal materials, enhancing potential applications.

Material stability and durability, which are crucial for practical applications, are being addressed through advances in materials science. Techniques such as surface coating technologies can augment the resistance of photothermal materials to harsh environmental conditions [150, 151]. As a result, the durability of photothermal materials is improved, making them more suitable for renewable energy applications. Note that it is crucial to develop more stringent standards for evaluating the durability and stability of photothermal materials. One can propose an assessment of their longevity under variable operational

conditions and a comparative analysis of data from extended stability tests, which are vital for their practical application in desalination technologies.

Scalability is being addressed by refining manufacturing methods. The production of high-concentration functional inks of nanofillers using a wet-jet mill [152], microfluidics [153], and other methods [154] offers a scalable, cost-effective strategy for the large-scale production of photothermal materials. Such advanced manufacturing methods could streamline the synthesis process, reduce production costs, and make photothermal materials more accessible.

Integration with existing technologies presents a considerable challenge being addressed by the development of hybrid systems. This involves tailoring the optical and thermal properties of the photothermal materials to align with the membrane characteristics and optimizing their combined performance.

These scientific and technological advances are expected to drive the development and application of photothermal materials.

Concluding remarks

The advancement of photothermal materials is pivotal not only for solar energy conversion and waste heat recovery but also for propelling the field of solar membrane desalination. Their unique ability to convert light into heat efficiently is integral to addressing global water scarcity through sustainable methods. To this end, ensuring that photothermal materials are designed with desalination efficacy in mind is essential.

However, there are still significant challenges that need to be addressed to make their use widespread. Improving the efficiency, stability, scalability, and integration of photothermal materials with existing technologies is essential to unlock their full potential for solar membrane desalination and other renewable energy applications.

High-throughput computational screening is a powerful tool that enables rapid identification and optimization of photothermal materials with desirable optical and thermal properties. By combining the power of computational modeling and machine learning algorithms, researchers can quickly evaluate the potential of large libraries of candidate materials for solar desalination, greatly accelerating the discovery and development of novel photothermal materials with unprecedented efficiency and stability.

Acknowledgments

A P and M B S acknowledge the IVANHOE project funded by MAECI for Italy and MOST for Israel. A P and A C acknowledge the EURIPIDES project funded by MAECI for Italy and A*STAR for Singapore. A P and A C acknowledge funding of the PRIN 2022LFWJBR PLANET- PLAsmons of topological Nodal-line semimetals project by the Ministry of University and Research of Italy. A P, A C, and E C acknowledge funding of the PRIN P20223LXTA ENTANGLE- thermoplasmonic quantum materials-enhanced seawater mining for circular blue Economy project by the Ministry of University and Research of Italy.

6. Computational screening of photothermal materials

*Davide Campi*¹ and *Yong-Wei Zhang*²

¹ Department of Materials Science, University of Milano-Bicocca, Via R. Cozzi 55, 20125 Milano, Italy

² A*STAR Research EISSN 2010–0523, Institute of High-Performance Computing, Agency for Science, 1, #20-10 Fusionopolis Way, Connexis, North Tower, Singapore 138632, Singapore

Status

Increasing the efficiency of photothermal materials is key to realize solar MD at large-scale and sustainable costs. Recently, developments in photothermal materials have been largely led by individual experimental efforts aimed at specific materials or restricted families of compounds. However, progress in the development of large materials databases [138, 139] and advances in the fundamental theoretical treatment of the problem as well as in computational automation are opening the way to large-scale *in silico* screenings able to pinpoint promising photothermal materials for solar desalination among thousands of candidates to more effectively direct experimental efforts.

The complete and reliable simulation of photothermal nanomaterials is a complex problem because it involves simultaneous calculation of different properties (like the optical response and the thermal coupling) and requires protocols able to combine simulations spanning different length scales, from the atomistic to the mesoscopic level. The performances of photothermal devices are strictly related to both the intrinsic properties of the material, most importantly its dielectric function, as well as the size and shape of the nanostructure in which such a material is engineered and how the nanostructure couples with its environment.

A widespread method for the simulation of intrinsic material properties is represented by first-principles calculations based on the DFT approach [155], which gives detailed information on the electronic structure that can be used to compute the dielectric function under certain approximations. The dielectric function can then be used as an input for nanoscale electromagnetic device simulations that typically determine electromagnetic field distributions using classical finite-difference methods [156]. The use of these theories has been proven successful for certain microscopic structures [157], but a rigorous application to nanostructures requires particular care because quantum effects start to play important roles. Finally, for particularly small structures (made at most of few hundreds atoms), it is possible to simulate the whole nanostructure plasmonic response within a fully quantum mechanical framework, for example, through TD-DFT [158].

Current and future challenges

Computational approaches for the study of photothermal materials are rapidly developing and are beginning to enable vast computational quests for novel photothermal materials as well as larger scale simulations with unprecedented accuracy. The fields of first-principle simulations of dielectric properties and optical responses on one side and classical electromagnetic simulations on the other are both relatively mature. Each one, however, presents its own peculiar challenges, and additional complexity arises when the two fields need to be combined. First-principle simulations based on DFT present well-known intrinsic limitations in the description of electronic excited states [159]. Complementary approaches that use DFT calculations as a starting point have been developed to overcome these limitations based on the many-body perturbation theory [160]. In conjunction with the BSE for insulators, this has become the state-of-the-art approach for the calculation of optical properties in bulk systems. These approaches can provide remarkably accurate results but at the price of a computational cost more than one order of magnitude higher than plain DFT. In metallic materials, DFT introduces errors that are less pronounced than for insulators; for the latter, the bandgap can be dramatically wrong, whereas for metals, the errors can be identified as a compression of the empty bands, which lessens the influence of the optical spectrum. For these reasons, plain DFT calculations are often used to readily compute dielectric functions for metallic materials that can be qualitatively useful. Such information can be directly used to identify materials with specific characteristics, for example, highly anisotropic optical properties, that are known to be effective in thermoplasmonic solar MD [106] or they can be used as a starting point for complete multiscale simulations of the electromagnetic field distribution in the whole nanostructure to better estimate the overall efficiency and include the effects of shape and size factors. Here, important challenges reside in the proper treatment of non-classical phenomena such as Landau damping, quantum tunneling, and nonlocality for materials with nanometric features where these effects might become important [161–163]. Recently developed codes implement a rigorous treatment of such effects for nanostructures with simple shapes [164].

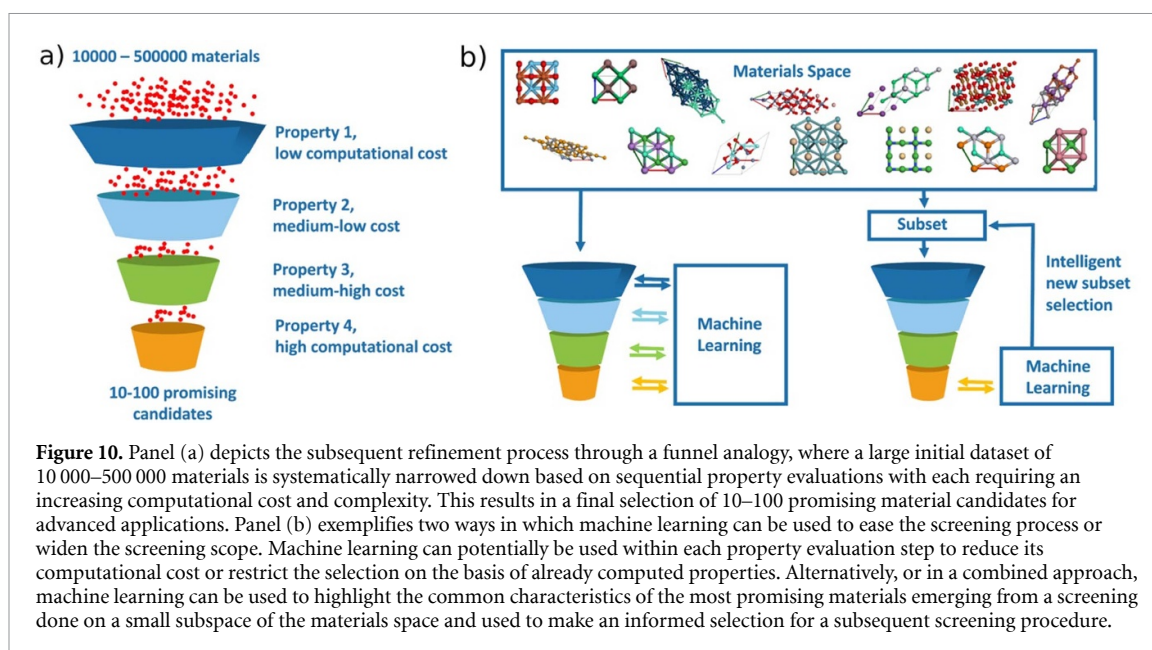

Advances in science and technology to meet challenges

To meet the challenges required to enable an effective exploration of the materials space for efficient, cheap, and sustainable photothermal materials to overcome TP, the computational approaches need to provide very accurate results at each simulation stage at a reasonable computational cost. To this end, the development of functionals that go beyond the standard DFT implementations without the large computational cost of many-body techniques, such as hybrid functionals [165], discontinuity-corrected functionals [166], or Koopmans-compliant functionals [167], represents valuable options that allow a fruitful compromise between accuracy and cost. Other interesting strategies are offered by novel techniques to accelerate many-body calculations [168, 169]. Moreover, recently, new methods based on the Shirley optimal basis set have been developed to allow seamless treatment of the inter- and intra-band contributions [170], which, if applied to photothermal materials, could simplify the calculations. These theoretical advancements, together with the development of more efficient algorithms and computational architectures, will surely empower the treatment of larger and more complex systems at all levels of theory (DFT, many-body but also TD-DFT) and open the route to high-throughput computational campaigns, i.e. the possibility to run calculations on several systems to systematically explore the materials space in search of the best candidates. This type of study is being extensively used in various fields of research but is just starting to appear for photothermal materials [171]. The use of dedicated informatic infrastructures [172, 173] designed to run high-throughput calculations and that allow the creation of turn-key solutions through high-level automated workflows can ease the computational process by incorporating the various steps needed for the complete computational characterization of a photothermal nanostructure into a single script that requires only minimal input. The field will also benefit from further developments in classical and semi-classical electromagnetic simulation codes, especially in open-source packages, expanding the treatment of simple shapes [164] to allow more complex geometries at both the microscale and nanoscale and including non-classical phenomena relevant at the nanoscale [161–163]. Finally, it is possible to envisage a relevant role for AI algorithms both in the accelerated selection of materials starting from the results of high-throughput screenings and in the optimization of the shape and size of thermoplasmonic nanostructures for solar desalination. Specifically, AI techniques can help thermoplasmonic materials modeling and discovery at different stages, from the accelerated prediction of accurate optical spectra [174, 175] to the prediction of the macroscopic fields [176] to material selection in large databases. This enters in a broader trend that in recent years brought an ever-increasing presence of AI in various aspects of membrane research and development starting from material selection [177] up to the optimization of the industrial membrane processes [178].

Concluding remarks

Recent advances in simulation methods, both in materials modeling from first principles and nanostructure modeling from finite differences, combined with the steady growth of computational power and the development of high-level informatic infrastructures for computational automation, are allowing accurate simulations of complex materials as well as large-scale simulation campaigns to screen for optimal materials

and optimize their nanostructures for solar desalination. This will crucially help to guide and accelerate the research toward novel materials that could overcome the limitations of the widely used noble metals, potentially increasing the efficiency of thermoplasmonic solar desalination, reducing its cost, and improving the matching with the solar energy range.

Acknowledgments

Y W Z acknowledges the EURIPIDES project funded by MAECI for Italy and A*STAR for Singapore.

7. Electromembrane processes for water treatment

Ramato Ashu Tufa¹, Luigi Gurreri² and Michele Tedesco³

¹ Department of Environmental Engineering, University of Calabria, Via Pietro Bucci cubo 44A, Rende, CS 87036, Italy

² Dipartimento di Ingegneria Elettrica, Elettronica e Informatica, Università di Catania, viale Andrea Doria 6, 95125 Catania, Italy

³ TNO Sustainable Process and Energy Systems, Lange Kleiweg 137, 2288 GJ Rijswijk, The Netherlands

Status

EMP have gained increasing attention in the area of desalination and water treatment in the last years thanks to the ability of IEM to separate charged particles in the presence of an applied electric field under mild operating conditions [179, 180]. The most mature EMP is ED, whose principle is based on the use of alternating CEMs and AEMs to produce two streams (i.e. a dilute and a concentrate) from a salt feed solution (figure 11(a)) [181]. Another promising ED-based process is BMED, which is an alternative ED configuration that uses bipolar membranes to produce (or recover) acid and base streams via a catalytic water dissociation mechanism (figure 11(b)), and has recently gained attention for other applications including ammonia recovery from wastewater and CO₂ capture [182]. The advantages of ED-based technologies are limited use of chemicals (e.g. for pre-treatment, cleaning, or as anti-fouling agents), mild operating conditions (i.e. ambient temperature and pressure), and the possibility to (ideally) achieve selective ion separation (though reaching high ion-ion selectivity is still challenging, given the current stage of development of commercial IEMs). Therefore, ED-based technologies are potentially attractive for many emerging applications in (waste)water treatment [181–184]. ED is commercially applied for brackish water desalination, corresponding today to ~2% of global desalination capacity [185]. However, ED-based processes are under development for other applications, such as seawater desalination, treatment of industrial brines and municipal wastewater, acid/base regeneration, salt conversion, (heavy) metal separation, and nutrient recovery [183, 186]. Among the ED-based technologies, another promising option for water treatment is DD, which is an alternative EMP process named after F. G. Donnan (in 1924) first described the equilibrium that resulted when a semipermeable membrane separated two electrolyte solutions [187]. In DD, the electrochemical potential gradients of the target and draw ions across the membrane promote a selective separation as a result of the ion exchange process between the feed and draw solutions [188, 189]. The membrane separator can be either an AEM or a CEM depending on the charge of target ions in solution (figures 11(c) and (d)). The key advantage of DD compared to other separation technologies like ED or SWRO is that it does not require any external source of electric potential or pressure difference as driving force, but only the concentration difference between the feed and a draw solution, thus providing the advantages of simplicity, potentially low energy requirements, and less environmental threat [189]. The process has been widely tested to remove pollutants [190] and recover resources from water and wastewater samples [191].

Current and future challenges

The large potential of ED methods in water treatment, environmental protection, and resource recovery faces technical issues that limit their industrial implementation [180, 183, 186]. Some of the current challenges include (relatively) high energy consumption, low permselectivity (in case of high salinity in the feed), low purity and concentration (operations of concentration of industrial effluents, acid/base (re)generation) and membrane fouling. For example, high energy consumption affects the desalination performance of high-salinity streams (like seawater) or the production of acid/base. The ion selectivity may affect the current efficiency (which, in turn, increases the energy consumption) and in the case of multi-ion solutions the product (typically acids or base) purity. The presence of a limiting current is a phenomenon that intrinsically limits the operational window of ED, as it restricts the ‘cost-effective’ operational range (i.e. energy consumption) of the technology, especially in relatively long stacks [192]. It is foreseen that future ED applications will be ‘process-tailored’, i.e. with the membrane manufacturing process as well as the process design and operating conditions that will be customized (and optimized) for specific applications and ion mixtures, for instance to reach efficient ion-ion selective separation. This is a hard challenge that will require much effort in research and development on various fronts. Moreover, the performance of ED-based treatments of real streams and their duration in long-term operations should be carefully addressed. Finally, the techno-economic viability is still affected by the high costs of IEMs, which—unlike SWRO membranes—have not yet seen a significant cost reduction as a result of economies of scale.

Regarding DD, even though the technology development has advanced over several decades, its industrial implementation is still hindered by some key factors, i.e. slow kinetics for ion transport, the availability of

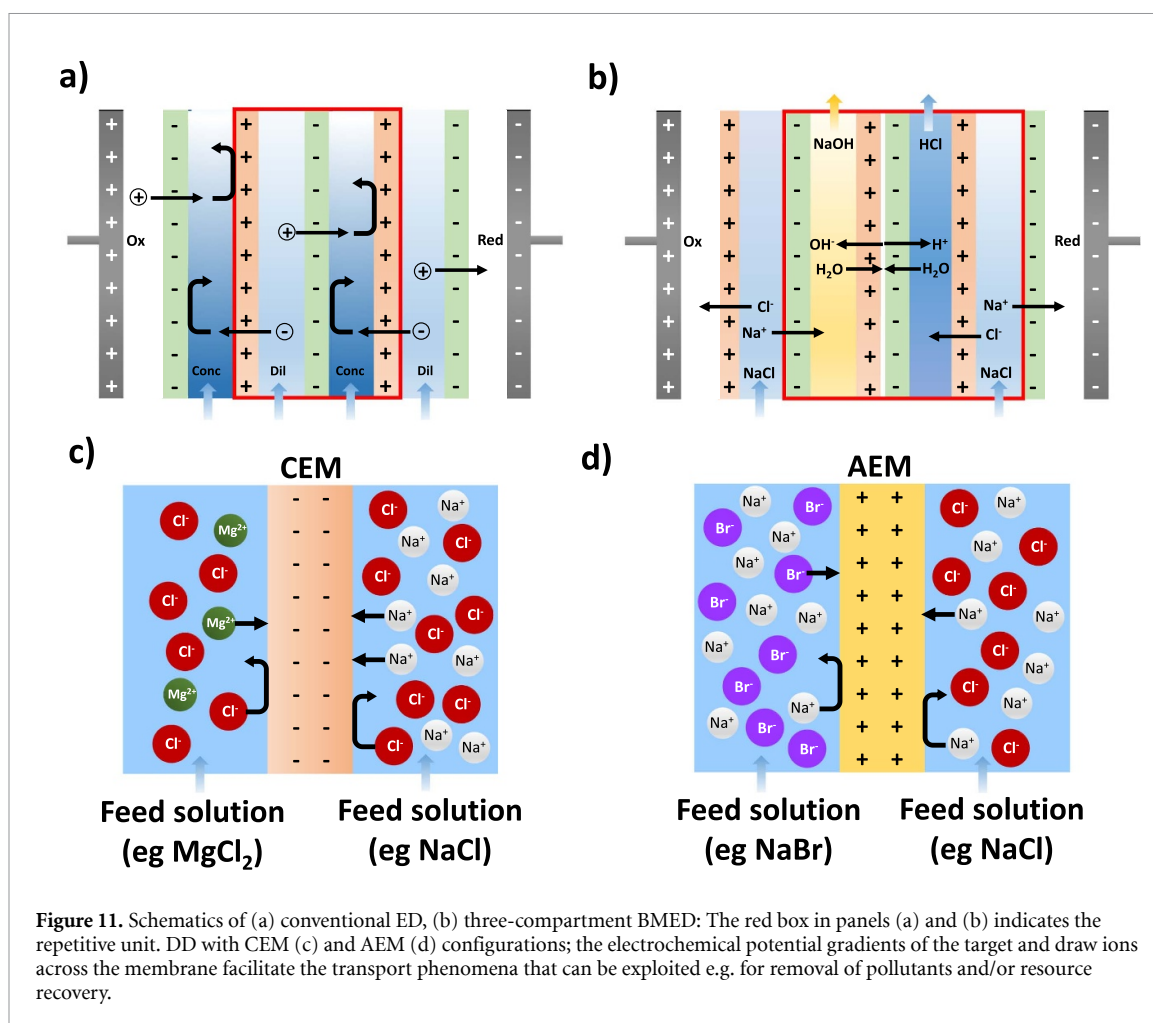

highly selective membranes at affordable costs, and the regeneration costs of draw solutions [188, 189]. In particular, reaching full separation (and/or recovery) of target ions from feed could require long operational time (~several hours to days) depending on the composition of the solution as well as on the membrane properties. Moreover, a poor understanding of the impact of key process parameters such as feed/draw solution pH and composition as well as flow rates is a hurdle to identifying the most optimal configuration of DD for scale-up [188]. The opportunities gained from integrated operations of DD with other membrane technologies are a less explored area as discoveries in hybrid implementation grow to advance the existing membrane technologies.

Advances in science and technology to meet challenges

A wide range of technical solutions is currently being explored to meet the current challenges of ED processes [183]. Novel/special membranes are continuously developed, aiming at reducing the electrical resistance or increasing the selectivity (e.g. proton-blocking AEMs, and monovalent selective membranes for 'selectrodialysis'). Profiled IEMs offer an alternative solution to flat IEMs and conventional spacers, leading to potential benefits for process performance (e.g. energy saving) [193, 194]. Moreover, NF or UF membranes can be included in ED stacks, enhancing process selectivity and product purity [195–198]. On the other hand, energy consumption may increase significantly due to the high electrical resistance. Numerous alternative designs and operational modes have been proposed to improve the process performance, including multi-stage configurations, integrated (electro-)membrane processes (ED-BMED, ED-SWRO [199] and many others), and overlimiting regime operations for electroconvective enhancement of mass transport [180, 200]. ED reversal operation, pulsed electric fields, pre-treatment and cleaning procedures can act against fouling, thus preserving or restoring membrane properties. Piloting, experiments in real environments and long-term testing are driving ED processes to scale up. However, optimization and techno-economic analysis are required for several applications. In this regard, modeling tools [181] can accelerate technological advancement. IEM cost abatement due to scale factors and growing commercial applications can be expected, thus providing positive feedback to the technology spread.

When looking at the challenges related to membrane materials employed in DD, there is a large opportunity for the exploration of new materials for enhanced selectivity as well as facilitating the transport dynamics [8, 201]. For instance, the use of monovalent selective membranes could be an interesting opportunity to separate either monovalent or divalent ions [201, 202]. In this context, chemical or electrochemical modification of existing commercial membranes into monovalent selective IEMs can also be a good strategy [203]. Regarding the impact of process parameters such as e.g. pH, a full understanding of the optimal pH regulation and its effect in relation to ion transport and membrane properties is still lacking. Design of selective membrane materials based on cheap hydrocarbon materials is one way to enhance the performance and reduce the capital cost regarding the scale-up of DD. For the design of selective membranes, new technical development based on, e.g. layer-by-layer assembly [201] or new frontiers of materials like the use of porous organic cages [204] can be a promising strategy. A significant reduction in capital cost can also be expected in using such membranes in hollow-fiber design to form compact modules for DD. Moreover, the development of such membranes using 'green' solvents (e.g. dimethyl sulfoxide, Cyrene™, Isosorbide [205]) presents an interesting perspective from an environmental point of view. New opportunities in hybrid membrane systems can be further explored to alleviate the technological limitations of standalone configurations. For example, DD can be explored as a promising system, e.g. combined with RED to reduce the impact of multivalent ions like Mg^{2+} [202], or with ED to mitigate fouling and scaling issues (e.g. $MgSO_4$ or $CaSO_4$) [188, 206]. In a hybrid application of DD-MCr system for the recovery of Li from brine resources, pre-treatment of the brine by DD for the removal of Mg^{2+} is expected to reduce the Mg^{2+}/Li^+ for better product purity.

Concluding remarks

EMPs have gained increasing attention in the past years as promising technologies for desalination and (waste)water treatment. Such notable potential of EMPs can be attributed to several key advantages, especially low pre-treatment requirements, mild operating conditions, and the possibility to achieve selective ion separation. Moreover, EMPs—being electricity-driven processes—offer a major advantage from an environmental perspective as they can be directly powered with renewable energy sources, thus leading to reduced greenhouse gas emissions compared to conventional (thermal) processes. This is a significant advantage for (waste)water treatment operators as a tool for the development of fully carbon-neutral (waste)water treatment processes.

Recent advancements in membrane materials and design have resulted in improved membrane selectivity and performance, opening up opportunities for novel applications (e.g. selective heavy metal removal, production and recovery of acids and bases, in situ pH control, ammonia recovery from wastewaters). Since the demand for high-quality water is continuously increasing, the adoption of selective and cost-effective separation processes is essential, and EMPs can play a major role in the future. In this regard, specific R&D challenges are related to improved anti-fouling resistance, low electrical resistance, and high ion-ion selectivity (especially for challenging separations such as chloride *vs.* nitrate, or sodium *vs.* potassium).

Besides mature technologies such as ED and electrodeionization, the list of EMPs is still growing, and other processes are now being tested at various pilot/demonstration scale (e.g. bipolar electrodialysis, DD, membrane capacitive deionization) or laboratory scale (ED metathesis, shock ED). Overall, the future of EMPs in water treatment looks promising and their full potential is still largely unexplored. The continued and growing research efforts in this field will play a crucial role in ensuring cost-effective and environmentally friendly water treatment processes.

8. Blue energy generation from brines

Ali Naderi Beni, Albraa Alsaati, Sultan Alnajdi, Mateo Roldan Carvajal and David M Warsinger
School of Mechanical Engineering, Birck Nanotechnology Center, Purdue University, West Lafayette, IN 47907, United States of America

Status

SGE, also known as ‘blue energy,’ can be attained when two streams with different salinities are mixed together and generate electrical or mechanical energy [207]. This energy comes from the chemical potential of mixing these streams and thermodynamically is the opposite of desalination process: the least work needed for desalination is thus the maximum extractable work in SGE. Methods of harvesting SGE have been proposed, such as PRO and RED [208, 209]. PRO and RED use membranes to produce energy but have different working principles (figure 12). PRO uses a semi-permeable membrane with an osmotic pressure difference to drive water flux from a LC stream, feed stream, to a HC side, also known as a draw stream [210]. In contrast, RED is an electrochemical process that utilizes IEM and electrodes, such that the transport of ions produces an electrochemical potential harvesting electrical energy at the electrodes [210]. Although proposed in 1978 [211] the interest in RED technology has exponentially increased since the last decade. PRO was first recognized as having potential for energy production by Loeb in 1975 [208, 212]. The importance of SGE technologies stems from attracting renewable, low-footprint energy sources, diversifying energy sources, and reducing the cost of energy production.

Current and future challenges

RED challenges can be divided into technological and economic challenges. Essentially, the critical properties in the IEM used in the RED application are ionic strength, permselectivity, membrane swelling, and ion exchange capacity [214]. In system operation, as the ionic strength increases, the effects of Donnan exclusion (charge exclusion) capacity decreases, causing ion exchange in the membranes to increase internal stack resistances [213, 214]. In other words, as the concentration of the solution increases, the IEM selectivity is decreased because of the reduction effects of fixed charges from Donnan exclusion in high concentrations, and thus more membrane area is needed for RED [213]. This phenomenon has been explored both theoretically and experimentally [213, 215] where at high concentrations (i.e. wastewater brine, seawater, brine) power density was negligible [216]. The second pseudo effect in RED is the permselectivity of the IEMs where specifically charged ions are able to pass through, which creates a bottleneck in the system efficiency and scale-up. Other notable effects are membrane swelling, where the ability to absorb water to the matrix is insufficient, and ion exchange capacity that limits the density of fixed charges in the membrane material to capture ions at the same time, mechanical strength and chemical stability have marginal effects [214].

The challenges in designing PRO include ICP, RSD, fouling, mechanical stability, and operational conditions [217]. It is worth noting that PRO can be constructed in spiral wound and hollow fiber configurations. A spiral wound must include a spacer to maintain mechanical stability. This results in spacer deformation and pressure drop in the LC channel. On the other hand, hollow fibers are self-supporting and do not need any spacers, thus demonstrating better mechanical stability than spiral wound configuration [10]. ICP dampens the water flux in PRO due to the accumulation of salt behind the selective layer. This imposes the active layer to have a more negligible salinity difference [218]. RSD is magnified at lower membrane selectivity and increases the LC salinity, reducing the salinity gradient between the two streams and, as a result, reducing the power density. PRO is inflicted by higher fouling than SWRO as the support layer faces the LC stream. This allows for infiltration of foulants from the LC-side to the support layer and then entanglement of foulants in the pores of the support layer. ICP also increases fouling as salinity inside the support layer is increased. As the membrane in PRO is subjected to high pressure difference, the membrane has to withstand it. The mechanical stability of the membrane is determined by the material, morphology, porosity, and thickness of the membrane. Operating PRO under different salinity conditions for feed and draw poses a trade-off with the membrane structural parameter (figure 14). This parameter describes the mass transfer resistance to salt within the membrane and is reduced by less tortuous flow paths and reduced ICP of salt within the membrane. Increasing the salinity difference between the LC and HC channels and decreasing the structural parameter both enhance the power density. This demonstrates a challenge in balancing between strengthening the membrane structurally and output performance.

Advances in science and technology to meet challenges

In RED, lower water permeability causes the cell to exert higher voltage [207] as lower passage of water would avoid mixing. Ideal membranes in RED should have high permeability for co-ions while blocking counter-ion passage. As a generic trade-off between co-ion conductivity and permselectivity for polymers,

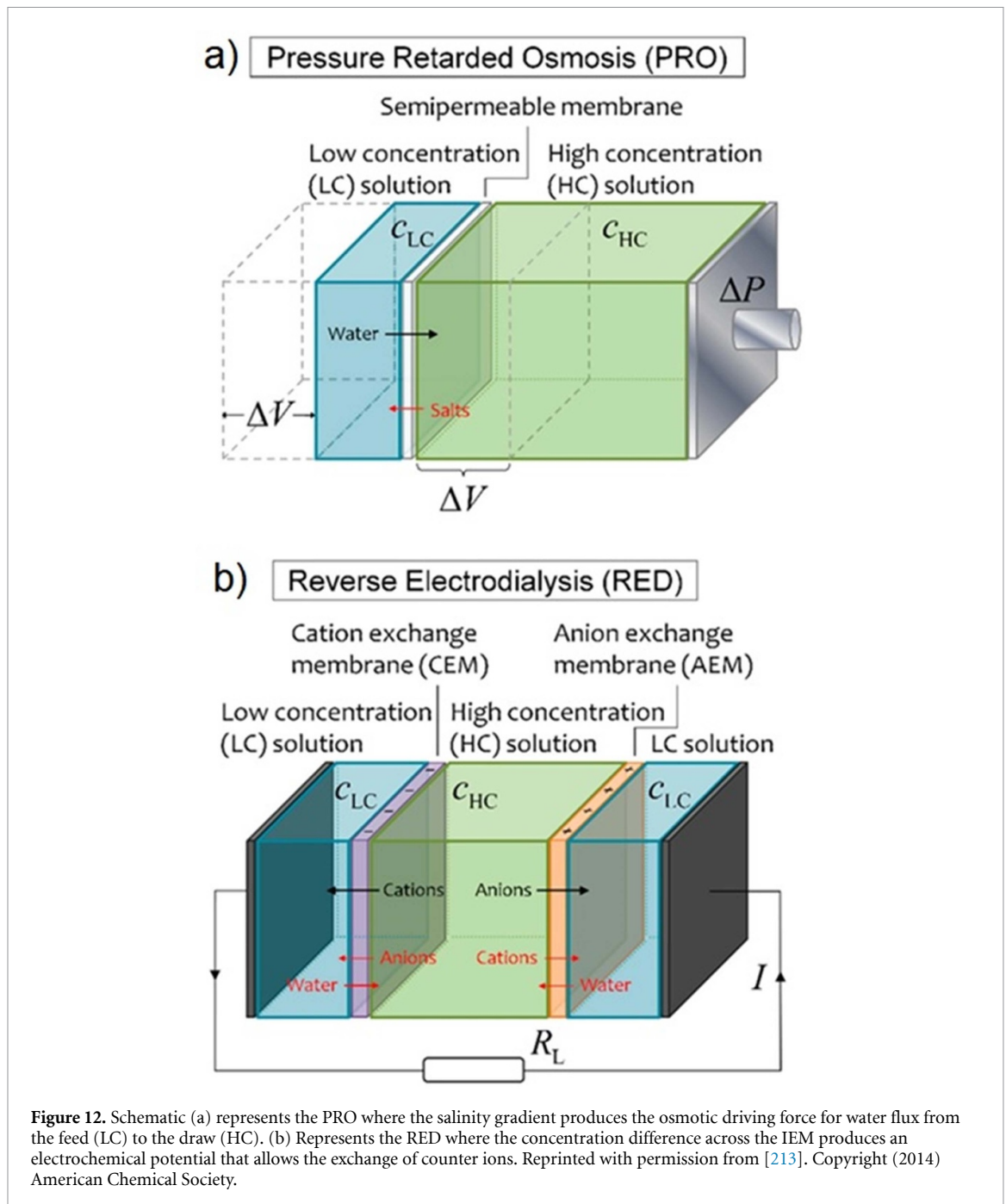

higher co-ion permeability is intertwined with lower permselectivity. Recent advances in implementing surface modifications [200] and novel membranes [220] can improve properties to increase power density. RED membranes can be synthesized very thin. Mechanical stability for RED membranes is generally not an issue as transmembrane pressure is negligible [200]. Spacers hold the integrity of channels and initiate mixing to avoid concentration polarization. However, spacers in RED are usually non-conductive, having a shadow effect, which reduces the effective membrane area. Using conductive spacers decreases stack resistance and in turn increases the power production [221]. The membrane lifetime is greatly affected by numerous factors, such as fouling, scaling, and membrane degradation. Recent studies counter this effect by introducing pre-treatment of feed water [222], titanium mesh end electrodes coated with mixed metal oxides and carbon aerogel electrodes [223], and mechanically stable membranes [224]. Cost is one of the major bottlenecks of RED; researchers have been working on more durable and selective membranes such as carbon nanotubes [225] and polymer nanocomposites [219]. Recovering energy from concentrated brine streams could increase the overall efficiency and reduce disposal costs [226].

As for PRO, improving its performance requires novel approaches to resolve the challenges. Concentration polarization and bursting pressure pose a trade-off for the selection of the membrane

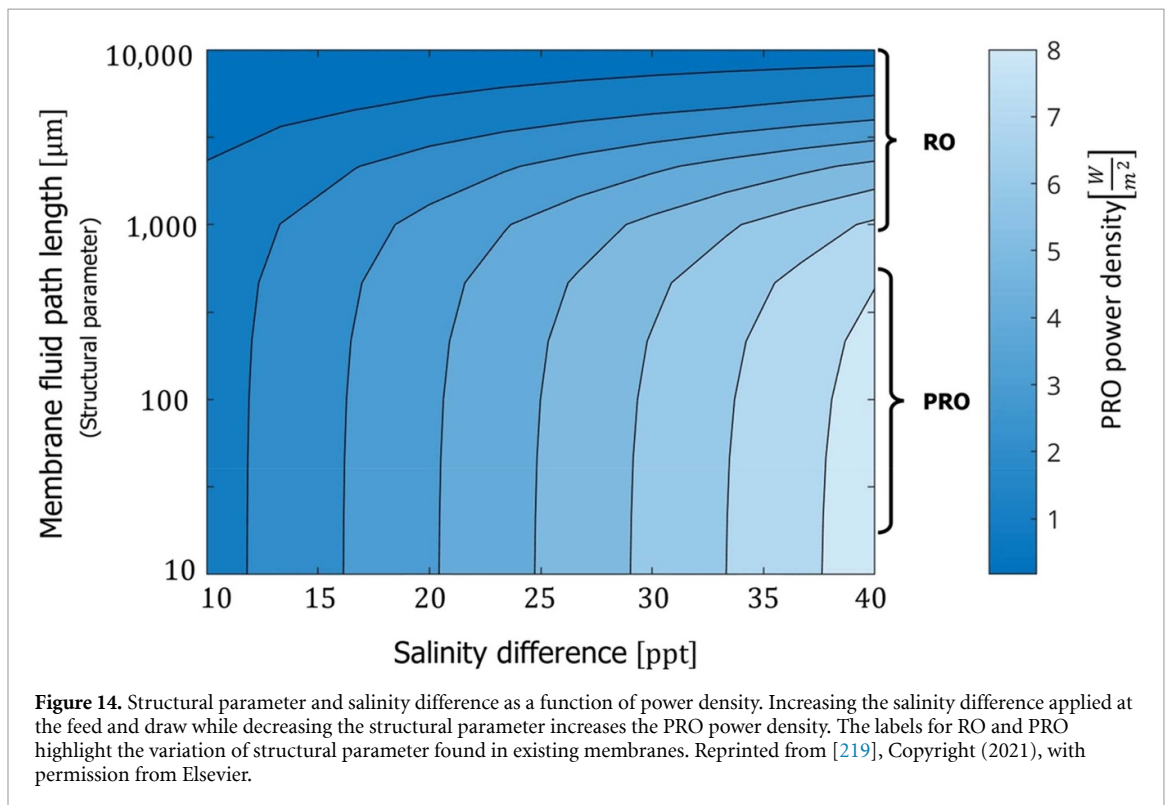
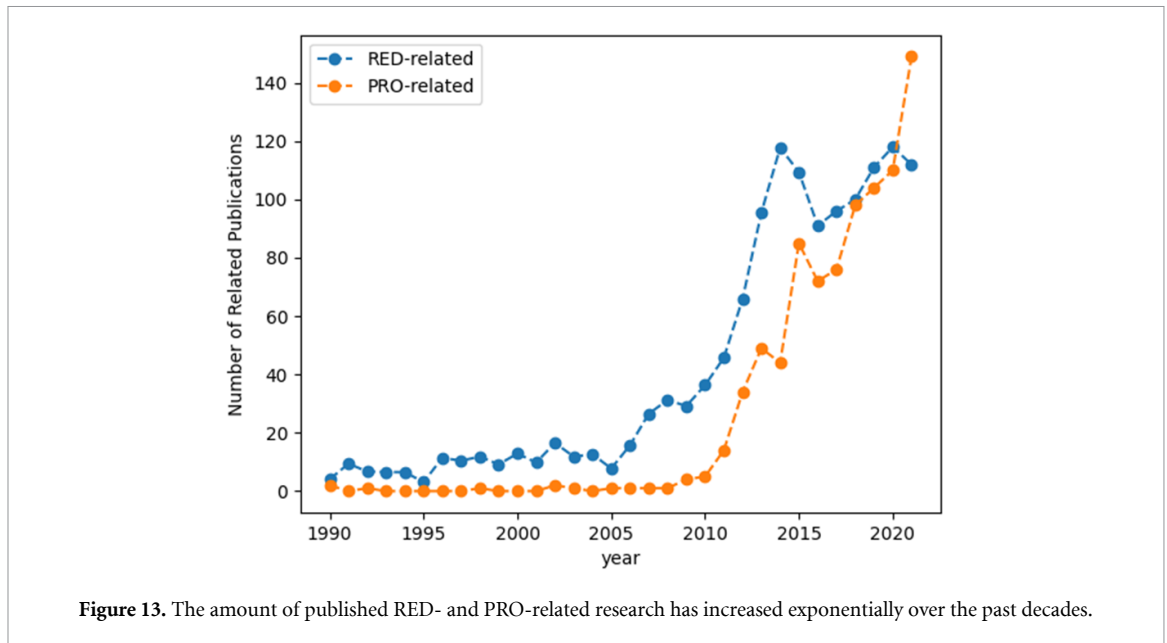

structural parameters, as a low structural parameter mitigates ICP [227], yet reduces the bursting pressure [227]. Better membranes are needed as the similar available SWRO membranes have structural parameters that are orders of magnitude higher than desired. Other promising improvement areas for PRO membranes include incorporating intrinsic hydrophilicity nanosized materials that can control fouling, such as carbon quantum dots, carbon nanotubes, and silver nanotubes [228]. Moreover, module development requires attention as SWRO modules have only one port for feed circulation, while PRO needs two ports for feed and draw circulation. Although FO modules contain the required ports for feed and draw circulation, FO modules cannot sustain hydraulic pressure applied in PRO applications [213]. A key promising area to bring PRO toward economic viability is hybrid systems, such as those capable of operating in PRO or SWRO modes depending on increasingly variable electricity markets [219].

Concluding remarks

Salinity gradient energy can be attained from systems with unbalanced salinity using chemical potential as the main driving force for the power production. It can be accomplished with technologies including PRO and RED. PRO suffers from a trade-off between ICP and burst pressure; this imposes a challenge to discover the optimum structural parameter. Intrinsic membrane developments were studied to enhance membrane and system performance in PRO operations. RED main bottlenecks lie in membrane material properties and cost. Efforts continue to focus on exploring new materials for high permselectivity, surface modifications, and hybrid integration for energy recovery purposes. Overall, both technologies present high potential in salinity gradient energy in the future.

Acknowledgments

This work was funded by the Bureau of Reclamation (Grant Number R21AC10168-00). We would like to thank the group members who contributed directly or indirectly to facilitate this work. Sultan Alnajdi acknowledges the support of the Department of Mechanical Engineering of Kuwait University fellowship sponsored by Kuwait University. The authors would also like to thank the School of Mechanical Engineering and Birck Nanotechnology Center, Purdue University.

9. Seawater and brines: the mine of the future?

Raed A Al-Juboori and Nidal Hilal*

NYUAD Water Research Center New York University Abu Dhabi, Abu Dhabi, United Arab Emirates

E-mail: nidal.hilal@nyu.edu

Status

The global demand for minerals has been increasing rapidly over the past decades, especially with the hasty growth of the clean technology industry. In fact, some leading industry and economy hubs such as the European Union, the United States of America (USA), Australia, Canada, and Japan have identified groups of metals as critical elements [229–233]. The reason behind designating critical status to these elements is their increasing societal use, depletion of terrestrial reserves, and the political and economic stability of their key producers. This has led to the exploration of alternative sources such as seawater and brines to meet the demands.

Seawater, which covers more than 70% of the earth's surface, contains valuable minerals such as magnesium (Mg), lithium (Li), Nickel (Ni), and cobalt (Co) among others. The concentration of these minerals is low, but the vast volume of seawater makes it a potentially abundant source of minerals. For instance, the concentration of lithium is estimated to be only 0.17 ppm [234]. However, the total amount of lithium in seawater is estimated to be around 230 billion metric tons, which is significantly higher than the known terrestrial reserves. On the other hand, the demand for Li from the clean energy industry alone is expected to quadruple by 2040, and the overall demand to increase by about 25 times by 2100 [235, 236]. Figure 15 shows examples of the production, market demands and prices of various metals.

Natural brines such as salt lakes are a concentrated source of minerals. Brines are commonly found in arid regions. The recovery of minerals from brines is an established industry, with lithium being the most widely extracted mineral. Overall, seawater and brine contain over 20 trillion dollars worth of minerals. Brines can also be generated from seawater desalination. The recent seawater desalination industry capacity is about 174 million m³ d⁻¹ [237]. The desalination brine is estimated to be five times more concentrated than seawater [235]. This stream presents great opportunities for metal recovery while producing clean water for the growing population.

While natural and industrial brines form potential sources for metals, the question remains which metals should be prioritized. Metals in high concentrations and have high demands and market prices are viable options for recovery [238]. The other class of metals that should be the focus of recovery are companion metals that have no or limited deposits, poor recyclability, and exist naturally entangled to their host metals [239].

Current and future challenges

Common extraction technologies for metals from brines include precipitation, solvent extraction, ion exchange, and membrane separation. Each technique has its challenges regarding extract target metals from brines. Selectivity is one of the major concerns in all these technologies. Extra chemicals are normally spent on co-occurring metals in precipitation. The loss of target elements to undesirable reactions could also occur in precipitation [241]. Subsequent leaching and evaporation are required after precipitation, which makes the process energy intensive except for arid regions [242]. Similarly, ion exchange is hampered by slow adsorption kinetics and poor performance in concentrated mediums [242]. Solvent extraction suffers from poor quality of extractants when competing metals with similar physio-chemical exist. Membrane technologies afford attractive opportunities for metal recovery due to their various separation mechanisms based on size, charge, polarity, functional groups, and water affinity of membrane surface and target elements. However, membranes are not immune to technical challenges. Fouling and wetting are the most common problems in membranes. Fouling necessitates frequent cleaning and replacement of membranes, increasing overall production cost. The most popular membrane technologies for metal recovery are SWRO and NF: SWRO is capable of rejecting all anions while NF has the capacity of rejecting divalent and higher valency anions. High energy requirements and production of chemically harsh waste are other technical challenges that accompany the aforementioned extraction technologies.

In addition to technical challenges, there are other hurdles related to policies and regulations, industry acceptance, and sourcing funds for maintaining research and developments in this arena. While extracting metals for seawater is not a new research field as it was explored in the early 60 s [243], it did not garner much attention due to the advancement in mining and fossil industries that disparaged its value. Natural resource management organizations and agencies on national and global levels should incentivize harvesting metals from brines to relieve pressure on natural reserves through financially supporting activities in this field and

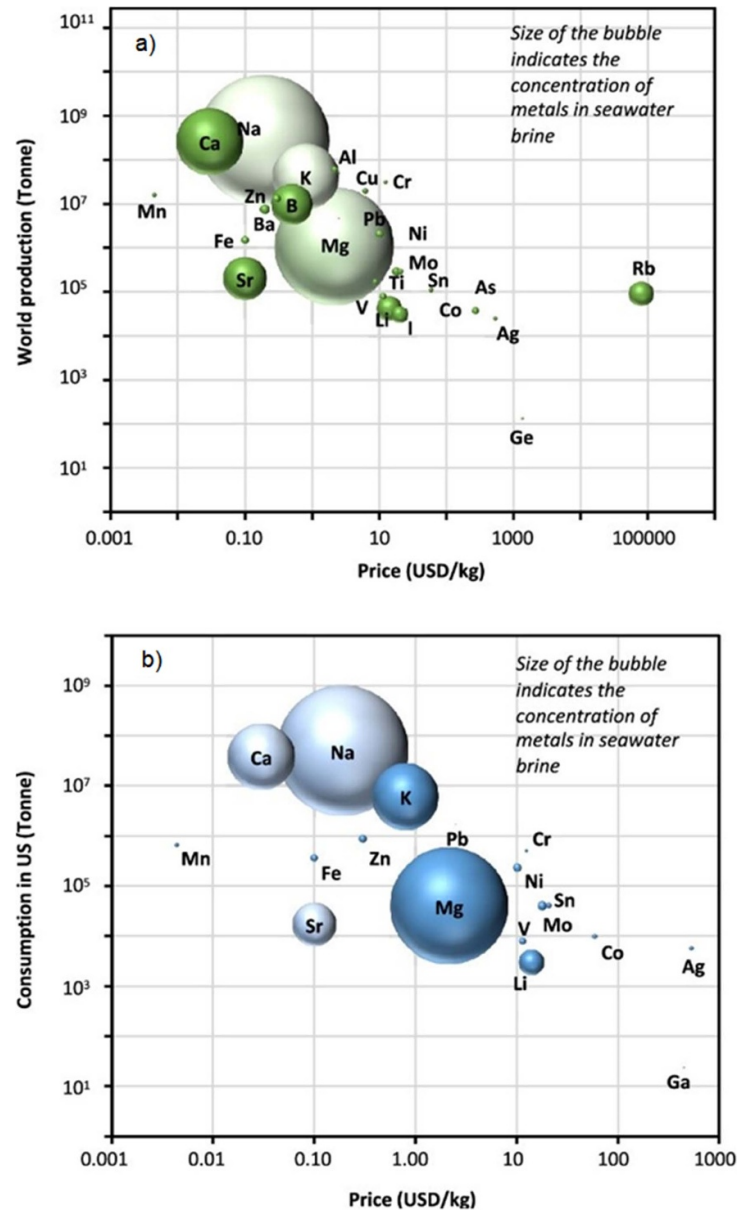

Figure 15. Production, consumption, and market values of various elements worldwide and in the USA using data from the USA geological survey mineral commodity summaries 2018 report. Reprinted with permission from [240]. Copyright (2021) American Chemical Society.

fashioning regulations for recognizing recovered metals as salable products. Examples of such initiatives exist but are limited to developed regions such as the SEA4VALUE project funded by the European Union for exploring the various permutations of metals recovery from seawater desalination brine [244]. Such efforts should be extended to other regions of the world so that global sustainability goals can be achieved.

Advances in science and technology to meet challenges

Technological upgrades might enable a more efficient and sustainable mineral extraction from seawater with the ultimate prospect to reduce our reliance on non-renewable resources. However, the process of extracting these minerals from seawater is often difficult and costly, and traditional methods have been largely inefficient. One of the steps toward improving metal extraction is the use of the impressive advancements in AI and computational chemistry. These tools can efficiently help in understanding the dynamicity of chemically interactive environment of metals, which provides ample opportunities for improving processes and system design.

Other possible ways for improving the metal extraction include optimizing single and hybrid extraction techniques and crafting new materials with unique separation functionalities. An example is the use of advanced adsorbents and electrode materials. Engineering adsorbents and electrodes based on low-cost

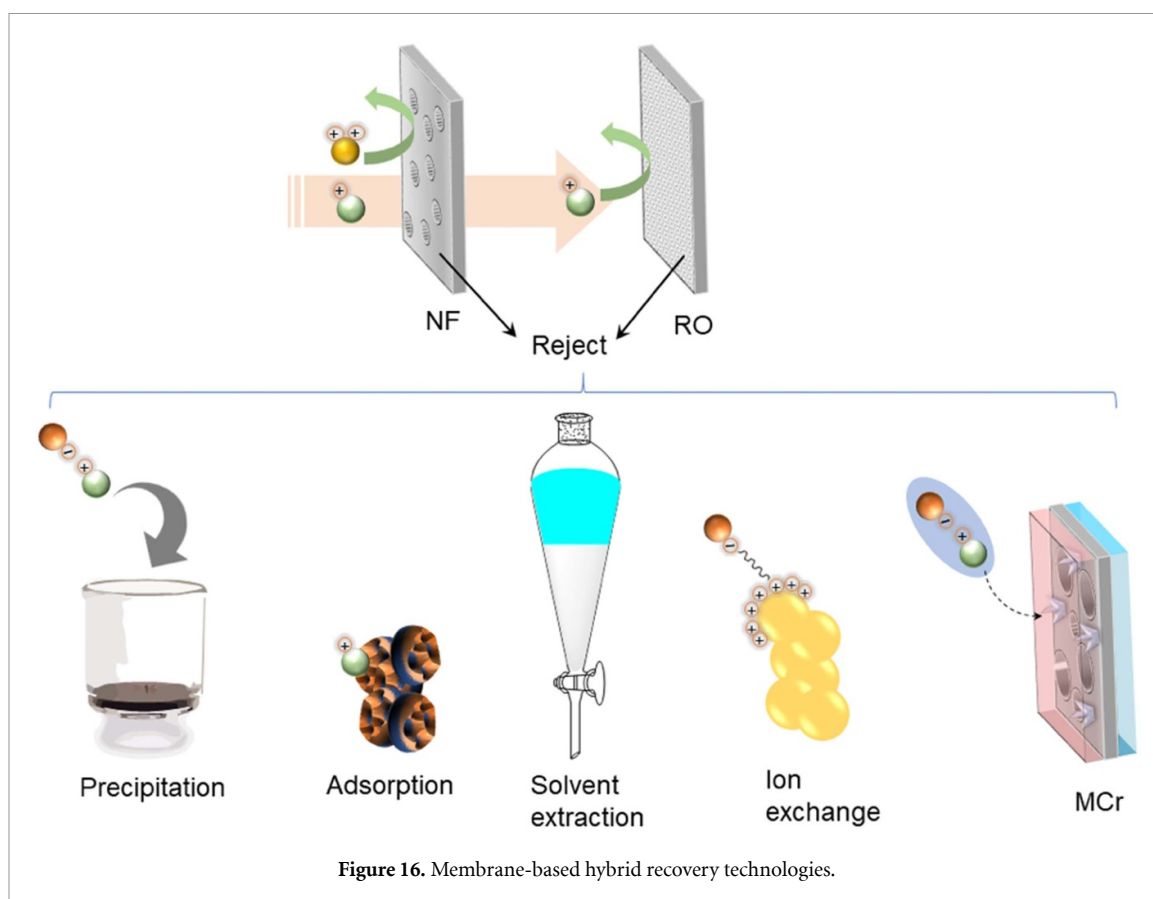

Figure 16. Membrane-based hybrid recovery technologies.

materials with efficient multi-separation mechanisms are a plausible idea for making metal recovery more affordable. Engineered adsorbent materials are designed to bind with specific minerals, allowing selective separation from seawater. Some examples of advanced adsorbent materials include carbon nanotubes, graphene oxide, biochar, and MOFs. These materials have shown high selectivity and efficiency in extracting various minerals from seawater including rare earth elements which are essential for many modern technologies.

Developing membrane technologies with dual functionalities such as MCr, which is a separation technique involving the formation of a solid crystal phase on the surface of a membrane, promises to be a game-changer in the mining industry. One promising solution to address the challenges of MCr is the use of photothermal effects to promote crystallization. Enhancing the selectivity of NF or even lower pressure membranes such as ultrafiltration through surface chemistry modification [245–248] or combined with other techniques (e.g. selective precipitation [249]) can significantly improve the energy efficiency of extraction process. More complex hybrid systems that harness energy spent/generated by other systems can further reduce the cost of the process, such as the case of harnessing the heat generated from pressure-driven membranes for inducing metal precipitation and water production with thermal-driven membranes. Figure 16 presents an illustration of possible membrane-based hybrid systems for metal recovery.

In addition to the above, careful assessment of environmental impact of processes and materials used in metal extraction should be considered. Special attention should be paid to the impact of withdrawing metals on the health of aquatic ecosystem. Tools such as life cycle assessment can be utilized to fulfill this aspect.

Concluding remarks

Metal recovery from natural and desalination brines has emerged as a response to two needs: the increasing demands on metals, especially those with depleting terrestrial reserves, and improving waste management of the drinking water industry. The large volume of seawater makes the recovery a promising viable alternative source for metals. Metal recovery could also lower the cost of clean water production. However, this is not without its challenges. There is a wide spectrum of metals that exist naturally in seawater with other constituents. To achieve efficient recovery, a strategic prioritizing of metals based on concentration, market value, natural reserve status, and recyclability should be adopted. Based on the availability of energy sources and the physiochemical properties of brines, a suitable separation technique should be selected.

The common separation techniques that are applied in metal recovery include precipitation, ion exchange, solvent extraction, and membrane processes. All these technologies have shortcomings that hinder their efficient application. However, low chemical consumption, stability, and high energy efficiency give membrane technology competitive edge over other technologies. Hybrid systems based on membrane technologies alone or in combination with other techniques hold great promise for metal recovery.

Acknowledgments

This work was jointly sponsored by the New York University Abu Dhabi (NYUAD) and Tamkeen under NYUAD Research Institute Award (Project CG007). All experiments were conducted using the research facilities at NYUAD Water Research Center.

10. Integrated processes for membrane-based circular blue economy

Sergio Santoro¹, Humberto Estay², Efrem Curcio^{1,3}, and Noredine Ghaffour⁴

¹ Department of Environmental Engineering, University of Calabria, Via Pietro Bucci cubos 44A, 87 036 Rende, CS, Italy

² Advanced Mining Technology Center (AMTC), University of Chile, Av. Tupper 2007 (AMTC Building), Santiago, Chile

³ Seligenda Membrane Technologies s.r.l., c/o University of Calabria, Via P. Bucci Cubo 45A, 87 036 Rende, CS, Italy

⁴ Water Desalination and Reuse Center (WDRC), King Abdullah University of Science and Technology (KAUST), Thuwal 23955–6900, Saudi Arabia

Status

The blue economy aims to promote prosperous, socially equitable and environmentally friendly ocean-based development [250] coherently with the UN Sustainable Development Goal 14.7: ‘Sustainable use of marine resources’ [251]. Moreover, the limited availability of freshwater has imposed the transition from the obsolete traditional linear approach (‘take, make and dispose’) to the circular economy in which any wastewater is potentially considered as a potential valuable source of water explorable in another process.

Membrane technologies have archived the maturity to accelerate the transition toward the circular blue economy, offering a wide portfolio of energy-saving and sustainable processes able to produce freshwater from effluents [252]. Seawater desalination, considered the most reliable solution to face the freshwater scarcity problem (being the sea an unlimited and renewable water body), is today dominated by SWRO.

The drawback of SWRO is a relatively low water recovery factor—usually limited to about 50% due to the high osmotic pressure of the rejected stream, also known as ‘brine’. The obvious consequence is that the desalination industry produces more than 140 million m³ d^{−1} of brine as a by-product discharged to the sea, severely impacting the marine and costal ecosystem due to its hypersaline nature [31].

The recent achievements in emergent membrane technologies have helped advance the circular blue economy by shifting the perception of the brine from a waste to a potential resource of: (i) water, by intensifying the SWRO desalination by MD, a hybrid thermal-membrane process less sensitive to osmotic and concentration polarization phenomena; (ii) minerals, by promoting a controlled (heterogeneous) nucleation and growth of dissolved salts by MCr; and (iii) energy, by harvesting SGP via PRO, RED [107] or other electrochemical membrane processes. Taking inspiration from the success story of SWRO outclassing thermal processes in the desalination industry, the mitigation of SEC for emerging membrane technologies—still struggling to reach commercialization—is the key challenge for the growth of the circular blue economy.

Several pilot plants have been developed and tested around the world to validate the effectiveness of integrated membrane based processes. MD plants have been installed by different players including Fraunhofer ISE, Memsys, Mediras, SolarSpring from Germany, Keppel Seghers from Singapore, and Aquastill from the Netherlands, contributing about 2% to the total desalination capacity [253]. In Afsluitdijk (Netherlands), a RED pilot plant is currently able to generate 50 kW of blue energy per hour by mixing water from IJsselmeerlake with seawater from the Wadden Sea [254].

By leveraging these next-generation technologies, the circular blue economy can be advanced, resulting in a more sustainable and resilient marine environment. Nevertheless, more research and development are still required to optimize these innovative processes and make them more cost-effective and scalable for widespread adoption.

Current and future challenges

One way for overcoming the limitations of each single membrane technology is by synergically exploiting the strengths of two or more process units through their integration [49]. In the research and development phase, membrane-based processes are usually tested as stand-alone operations, thus hindering their potential for circularity. Nowadays, the transition from pilot-plants to large scale applications imposes the need for systematic studies focused on the harmonious hybridization and the exergoeconomic analysis of the integrated processes [255]. As an example the integration of MD, MCr and RED stages can recover freshwater, extract valuable resources and harvest energy in the same process [240] (figure 17) combined with solar energy to supply the energetic requirements of the process.

Despite the socio-political inclination to promote water reuse practices, the practical implementation of the circular blue economy faces obstacles related to the scarce public acceptance and uncertainties caused by the absence of supranational regulations [256]. In this scenario, the European Regulation on Water Reuse in

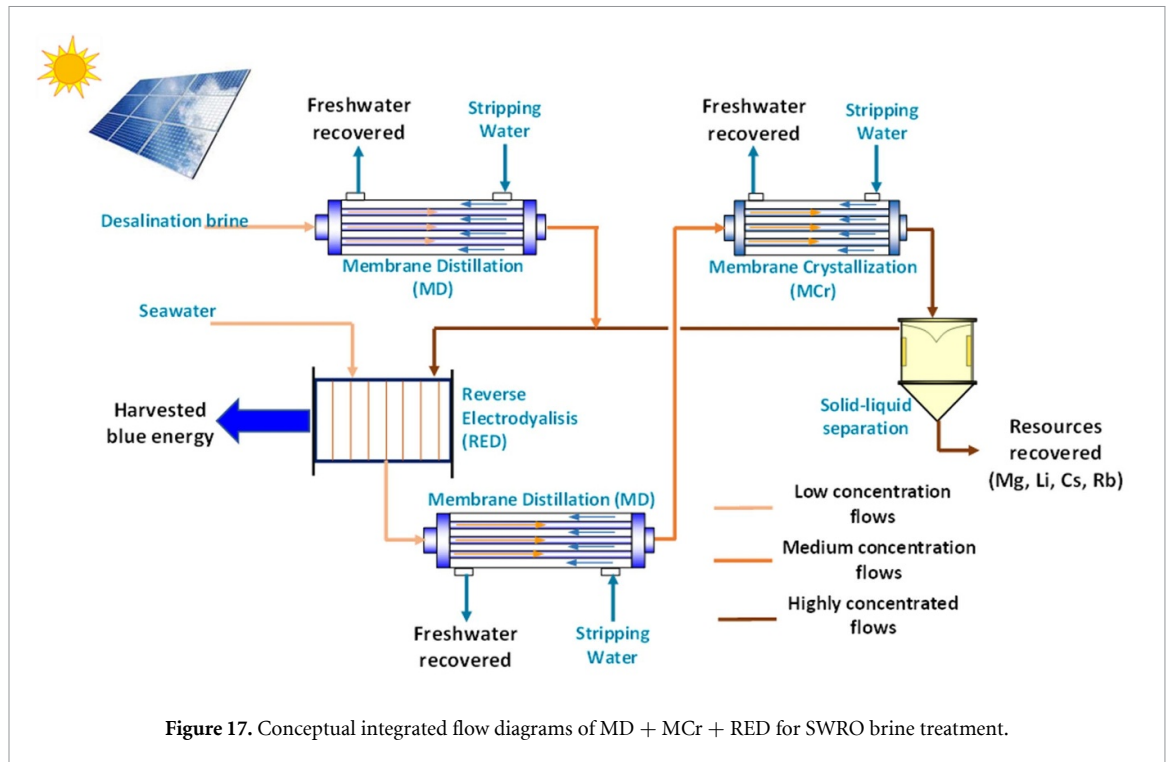

Figure 17. Conceptual integrated flow diagrams of MD + MCr + RED for SWRO brine treatment.

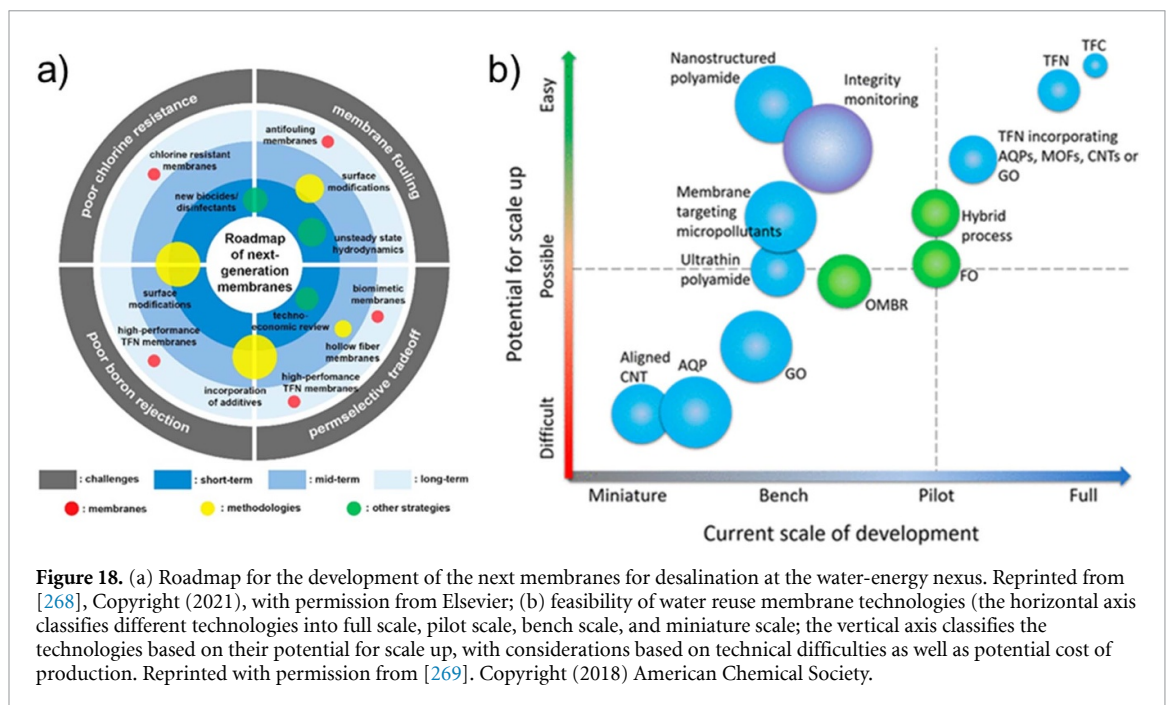

Figure 18. (a) Roadmap for the development of the next membranes for desalination at the water-energy nexus. Reprinted from [268], Copyright (2021), with permission from Elsevier; (b) feasibility of water reuse membrane technologies (the horizontal axis classifies different technologies into full scale, pilot scale, bench scale, and miniature scale; the vertical axis classifies the technologies based on their potential for scale up, with considerations based on technical difficulties as well as potential cost of production. Reprinted with permission from [269]. Copyright (2018) American Chemical Society.

force from June 2023 (Regulation (EU) 2020/741) has been recognized as a first milestone on the way for the harmonization of circular blue practices.

Also, membrane technologies suffer from a lack of globally recognized standards for design and process optimization, leading to variations in performance and reliability.

The inadequate past circular strategies adopted on plastic disposal have provoked a serious global problem severely impacting the aquatic ecosystem: the presence of microplastics in seas and oceans. While pressure-driven membrane technologies are the most appropriate candidates to remove microplastics from effluents at the point of discharge [257], implications related to microplastics issue imposes the reuse and recycling of end-of-life polymeric membranes [258].

Similarly, membrane technologies are effective over conventional techniques for providing clean water from streams contaminated by emerging pollutants (such as pharmaceuticals and personal care products) at an affordable cost and energy consumption [259].

Currently, industrial membrane processes are focused on water treatment, while the recovery of valuable resources and energy from the retentate stream is still in an embryonic phase, representing an unprecedented opportunity for circularity and sustainability. With respect to this, the development of highly performing membranes able to guaranty cost-effective and energy-saving processes is vital. Nevertheless, there is still a gap market in membrane materials for emerging operations for the blue growth: MD/MCr and RED pilot-plants are usually equipped with commercial membranes specifically developed for microfiltration or ED, respectively [260, 261].

Advances in science and technology to meet challenges

The SEC of membrane processes is mainly related to the activation of a driving force required to promote selective mass transport. Some of the possible solutions for achieving energy-efficient membranes include the development of low-pressure membranes, optimization of membrane structure and surface chemistry, and hybridization with renewable energy sources.

In this view, the recent technological upgrades are related to the employment of nanomaterials with advanced functional properties able to promote a facilitated and/or energy-intensified transport of the species through the membranes [262]. The development of mixed matrix membranes based on the incorporation of advanced nanomaterials in polymeric matrixes is deemed necessary for improving the performance and lifespan of membrane-based technologies [263].

Tendentially, both the achievement of a high recovery factor and the treatment of concentrated effluents drastically increase the risk of fouling, i.e. the Achille's heel of membrane processes. Fouling occurs when contaminants and microorganisms accumulate on the membrane surface, thus reducing the stability of the membrane (e.g. loss of hydrophobicity, causing wetting in MD membranes) or decreasing its permeability (e.g. creation of an extra-resistance to the mass-transport in pressure-driven membrane processes) with obvious implication on the process productivity and SEC [264]. Analogously, the treatment of saline solution is prone to precipitation of sparingly soluble salts, referred to as scaling. Interestingly, the integration of different membrane units (e.g. Microfiltration, Ultrafiltration and NF) at pre-treatment stage represents one of the most reliable technological solutions for fouling mitigation [265]. Research activities focused on the design of novel antifouling membrane surfaces also play a key role for future practical applications of membranes in the circular blue economy [266].

Moreover, the development of smart membrane monitoring and control systems (including advanced sensors, data analytics, and machine learning algorithms) is essential to achieve real-time monitoring and control of membrane systems, which can optimize the performance, reduce energy consumption, and prevent system failures [267].

Concluding remarks

Integration of membrane processes is a promising approach for advancing the circular blue economy. These membrane-based processes offer a sustainable and efficient solution for producing clean water, renewable energy and recovering valuable resources from seawater. The successful implementation of this approach in pilot plants around the world indicates its potential for widespread adoption and highlights the need for continued research and development to optimize and scale these technologies. The use of these membrane-based processes can lead to the creation of a more sustainable and eco-friendly blue economy and as a result, promote the conservation and sustainable use of marine resources.

The membrane-based circular blue economy holds immense promise for tackling pressing concerns such as water scarcity, contamination, and resource exhaustion in our oceans. Nonetheless, current constraints in membrane technology impede its widespread acceptance and application. Essential advancements encompass energy-conserving techniques, anti-fouling coatings, innovative membrane materials, and intelligent monitoring and control systems. Incorporating these enhancements will render membrane-centric circular blue economy more sustainable and environmentally friendly.

From this vantage point, a considerable commitment to investment and collaboration among the industrial, governmental, and academic sectors is imperative. The potential of this innovative blue economy is vast, and with the appropriate backing and resources, it can become a pivotal force in driving economic growth, social prosperity, and ecological sustainability.







Data availability statement

No new data were created or analysed in this study.

Acknowledgments

This work is funded by ANID under project Grant Basal AFB220002.

ORCID iDs

Antonio Politano  <https://orcid.org/0000-0002-4254-2102>
Raed A Al-Juboori  <https://orcid.org/0000-0001-6454-3264>
Albraa Alsaati  <https://orcid.org/0000-0003-1929-5083>
Athanassia Athanassiou  <https://orcid.org/0000-0002-6533-3231>
Gianluca D'Olimpio  <https://orcid.org/0000-0002-6367-3945>
Humberto Estay  <https://orcid.org/0000-0001-8518-7131>
Despina Fragouli  <https://orcid.org/0000-0002-2492-5134>
Luigi Gurreri  <https://orcid.org/0000-0002-8443-6025>
Nidal Hilal  <https://orcid.org/0000-0001-7885-4020>
Guillermo Zaragoza  <https://orcid.org/0000-0002-4452-9980>

References

- [1] Meng L, Shi W, Li Y, Li X, Tong X and Wang Z 2023 Janus membranes at the water-energy nexus: a critical review *Adv. Colloid Interface Sci.* **318** 102937
- [2] Fontananova E, Grosso V, Pantuso E, Donato L and Di Profio G 2023 Energy duty in direct contact membrane distillation of hypersaline brines operating at the water-energy nexus *J. Membr. Sci.* **676** 121585
- [3] Son H S, Nawaz M S, Soukane S and Ghaffour N 2022 Hybrid desalination technologies for sustainable water-energy nexus: innovation in integrated membrane module development *Desalin. Water Treat.* **263** 1–2
- [4] Winter L R, Cooper N J, Lee B, Patel S K, Wang L and Elimelech M 2022 Mining nontraditional water sources for a distributed hydrogen economy *Environ. Sci. Technol.* **56** 10577–85
- [5] Beuscher U, Kappert E and Wijmans J 2022 Membrane research beyond materials science *J. Membr. Sci.* **643** 119902
- [6] Nunes S P, Culfaz-Emecen P Z, Ramon G Z, Visser T, Koops G H, Jin W and Ulbricht M 2020 Thinking the future of membranes: perspectives for advanced and new membrane materials and manufacturing processes *J. Membr. Sci.* **598** 117761
- [7] Yang Z, Guo H and Tang C Y 2019 The upper bound of thin-film composite (TFC) polyamide membranes for desalination *J. Membr. Sci.* **590** 117297
- [8] Luo T, Abdu S and Wessling M 2018 Selectivity of ion exchange membranes: a review *J. Membr. Sci.* **555** 429–54
- [9] Qasim M, Samad I U, Darwish N A and Hilal N 2021 Comprehensive review of membrane design and synthesis for membrane distillation *Desalination* **518** 115168
- [10] Zuo K et al 2021 Selective membranes in water and wastewater treatment: role of advanced materials *Mater. Today* **50** 516–32
- [11] Ding W, Cai J, Yu Z, Wang Q, Xu Z, Wang Z and Gao C 2015 Fabrication of an aquaporin-based forward osmosis membrane through covalent bonding of a lipid bilayer to a microporous support *J. Mater. Chem. A* **3** 20118–26
- [12] Song Z and Xu Z 2015 Ultimate osmosis engineered by the pore geometry and functionalization of carbon nanostructures *Sci. Rep.* **5** 10597
- [13] Khorshidi B, Thundat T, Fleck B A and Sadrzadeh M 2016 A novel approach toward fabrication of high performance thin film composite polyamide membranes *Sci. Rep.* **6** 22069
- [14] Lee S A, Kim J, Kwon K C, Park S H and Jang H W 2022 Anion exchange membrane water electrolysis for sustainable large-scale hydrogen production *Carbon Neutralization* **1** 26–48
- [15] Liang Y, Zhu Y, Liu C, Lee K-R, Hung W-S, Wang Z, Li Y, Elimelech M, Jin J and Lin S 2020 Polyamide nanofiltration membrane with highly uniform sub-nanometre pores for sub-1 Å precision separation *Nat. Commun.* **11** 2015
- [16] Culp T E et al 2021 Nanoscale control of internal inhomogeneity enhances water transport in desalination membranes *Science* **371** 72–75
- [17] Tu Y-M, Samineni L, Ren T, Schantz A B, Song W, Sharma S and Kumar M 2021 Prospective applications of nanometer-scale pore size biomimetic and bioinspired membranes *J. Membr. Sci.* **620** 118968
- [18] Liu X, Zhang L, Cui X, Zhang Q, Hu W, Du J, Zeng H and Xu Q 2021 2D material nanofiltration membranes: from fundamental understandings to rational design *Adv. Sci.* **8** 2102493
- [19] Di Vincenzo M, Tiraferri A, Musteata V-E, Chisca S, Sougrat R, Huang L-B, Nunes S P and Barboiu M 2021 Biomimetic artificial water channel membranes for enhanced desalination *Nat. Nanotechnol.* **16** 190–6
- [20] Henkensmeier D, Najibah M, Harms C, Žitka J, Hnát J and Bouzek K 2021 Overview: state-of-the art commercial membranes for anion exchange membrane water electrolysis *J. Electrochem. Energy Convers. Storage* **18** 024001
- [21] Fischer L, Hartmann S S, Maljusch A, Däschlein C, Prymak O and Ulbricht M 2023 The influence of anion-exchange membrane nanostructure onto ion transport: adjusting membrane performance through fabrication conditions *J. Membr. Sci.* **669** 121306
- [22] Wiczorek J and Ulbricht M 2021 Amphiphilic poly (arylene ether sulfone) multiblock copolymers with quaternary ammonium groups for novel thin-film composite nanofiltration membranes *Polymer* **217** 123446
- [23] DuChanois R M, Porter C J, Violet C, Verduzco R and Elimelech M 2021 Membrane materials for selective ion separations at the water-energy nexus *Adv. Mater.* **33** 2101312
- [24] Zhuo Y, Chen J, Xiao S, Li T, Wang F, He J and Zhang Z 2021 Gels as emerging anti-icing materials: a mini review *Mater. Horiz.* **8** 3266–80
- [25] Lu J et al 2020 Efficient metal ion sieving in rectifying subnanochannels enabled by metal-organic frameworks *Nat. Mater.* **19** 767–74
- [26] McGrath M J, Hardy S H, Basalla A J, Dwulet G E, Manubay B C, Malecha J J, Shi Z, Funke H H, Gin D L and Noble R D 2019 Polymerization of counteranions in the cationic nanopores of a cross-linked lyotropic liquid crystal network to modify ion transport properties *ACS Mater. Lett.* **1** 452–8

- [27] Fan H, Huang Y and Yip N Y 2023 Advancing ion-exchange membranes to ion-selective membranes: principles, status, and opportunities *Front. Environ. Sci. Eng.* **17** 25
- [28] Chamani H, Woloszyn J, Matsuura T, Rana D and Lan C Q 2021 Pore wetting in membrane distillation: a comprehensive review *Prog. Mater. Sci.* **122** 100843
- [29] Lienhard J, Thiel G, Warsinger D and Banchik L 2016 Low carbon desalination: status and research development, and demonstration needs, report of a workshop conducted at the Massachusetts Institute of Technology in Association with the Global Clean Water Desalination Alliance (Massachusetts Institute of Technology) (available at: <https://dspace.mit.edu/handle/1721.1/105755>)
- [30] Bundschuh J, Kaczmarczyk M, Ghaffour N and Tomaszewska B 2021 State-of-the-art of renewable energy sources used in water desalination: present and future prospects *Desalination* **508** 115035
- [31] Jones E, Qadir M, van Vliet M T, Smakhtin V and Kang S-M 2019 The state of desalination and brine production: a global outlook *Sci. Total Environ.* **657** 1343–56
- [32] Subiela-Ortín V J, Peñate-Suárez B and de la Fuente-Bencomo J A 2022 Main technical and economic guidelines to implement wind/solar-powered reverse-osmosis desalination systems *Processes* **10** 653
- [33] Slocum A H, Haji M N, Trimble A Z, Ferrara M and Ghaemsaïdi S J 2016 Integrated pumped hydro reverse osmosis systems *Sustain. Energy Technol. Assess.* **18** 80–99
- [34] Boretti A and Castelletto S 2021 Techno-economic performances of future concentrating solar power plants in Australia *Humanit. Soc. Sci. Commun.* **8** 1–10
- [35] Leijon J, Salar D, Engström J, Leijon M and Boström C 2020 Variable renewable energy sources for powering reverse osmosis desalination, with a case study of wave powered desalination for Kilifi, Kenya *Desalination* **494** 114669
- [36] Zarzo D and Prats D 2018 Desalination and energy consumption. What can we expect in the near future? *Desalination* **427** 1–9
- [37] Lee S, Choi J, Park Y-G, Shon H, Ahn C H and Kim S-H 2019 Hybrid desalination processes for beneficial use of reverse osmosis brine: current status and future prospects *Desalination* **454** 104–11
- [38] Hosseiniour E, Karimi S, Barbe S, Park K and Davies P A 2022 Hybrid semi-batch/batch reverse osmosis (HSBRO) for use in zero liquid discharge (ZLD) applications *Desalination* **544** 116126
- [39] Andrés-Mañas J, Requena I and Zaragoza G 2022 Characterization of the use of vacuum enhancement in commercial pilot-scale air gap membrane distillation modules with different designs *Desalination* **528** 115490
- [40] Ma J et al 2021 The 2021 battery technology roadmap *J. Appl. Phys.* **54** 183001
- [41] Carta J, Gonzalez J and Subiela V 2003 Operational analysis of an innovative wind powered reverse osmosis system installed in the Canary Islands *Sol. Energy* **75** 153–68
- [42] Li S, D. Carvalho A P, Schäfer A I and Richards B S 2021 Renewable energy powered membrane technology: electrical energy storage options for a photovoltaic-powered brackish water desalination system *Appl. Sci.* **11** 856
- [43] Zheng A, Cao Z, Xu Y, Chen H and Deng J 2022 Analysis of hybrid adiabatic compressed air energy storage-reverse osmosis desalination system with different topological structures *Desalination* **530** 115667
- [44] Cekirge H M, Erturan S E and Thorsen R S 2020 The CSP (concentrated solar power) plant with Brayton cycle: a third generation CSP system *Am. J. Mod. Energy* **6** 43–50
- [45] Mito M T, Ma X, Albuflasa H and Davies P A 2022 Variable operation of a renewable energy-driven reverse osmosis system using model predictive control and variable recovery: towards large-scale implementation *Desalination* **532** 115715
- [46] Cabrera P, Carta J A, González J and Melián G 2017 Artificial neural networks applied to manage the variable operation of a simple seawater reverse osmosis plant *Desalination* **416** 140–56
- [47] Gil J D, Roca L, Zaragoza G, Pérez M and Berenguel M 2022 Improving the performance of solar membrane distillation processes for treating high salinity feeds: a process control approach for cleaner production *J. Clean. Prod.* **338** 130446
- [48] Kim J, Park K, Yang D R and Hong S 2019 A comprehensive review of energy consumption of seawater reverse osmosis desalination plants *Appl. Energy* **254** 113652
- [49] Ahmed F E, Hashaikeh R and Hilal N 2020 Hybrid technologies: the future of energy efficient desalination—a review *Desalination* **495** 114659
- [50] Okampo E J and Nwulu N 2021 Optimisation of renewable energy powered reverse osmosis desalination systems: a state-of-the-art review *Renew. Sustain. Energy Rev.* **140** 110712
- [51] Touati K, Salamanca J, Tadeo F and Elfil H 2017 Energy recovery from two-stage SWRO plant using PRO without external freshwater feed stream: theoretical analysis *Renew. Energy* **105** 84–95
- [52] Tristán C, Fallanza M, Ibáñez R and Ortiz I 2020 Recovery of salinity gradient energy in desalination plants by reverse electrodialysis *Desalination* **496** 114699
- [53] Lilas T, Dagkinis I, Stefanakou A-A, Antoniou E, Nikitakos N, Maglara A and Vatisas A 2022 Energy utilisation strategy in an offshore floating wind system with variable production of fresh water and hybrid energy storage *Int. J. Sustain. Energy* **41** 1572–90
- [54] Janowitz D, Groche S, Yüce S, Melin T and Wintgens T 2022 Can large-scale offshore membrane desalination cost-effectively and ecologically address water scarcity in the Middle East? *Membranes* **12** 323
- [55] Kenigsberg C, Abramovich S and Hyams-Kaphzan O 2020 The effect of long-term brine discharge from desalination plants on benthic foraminifera *PLoS One* **15** e0227589
- [56] Frank H, Fussmann K E, Rahav E and Zeev E B 2019 Chronic effects of brine discharge from large-scale seawater reverse osmosis desalination facilities on benthic bacteria *Water Res.* **151** 478–87
- [57] Ibrahim H D and Eltahir E A 2019 Impact of brine discharge from seawater desalination plants on Persian/Arabian gulf salinity *J. Environ. Eng.* **145** 04019084
- [58] Biesheuvel P, Porada S, Elimelech M and Dykstra J 2022 Tutorial review of reverse osmosis and electrodialysis *J. Membr. Sci.* **647** 120221
- [59] Patel S K, Ritt C L, Deshmukh A, Wang Z, Qin M, Epsztein R and Elimelech M 2020 The relative insignificance of advanced materials in enhancing the energy efficiency of desalination technologies *Energy Environ. Sci.* **13** 1694–710
- [60] Park G L, Schäfer A I and Richards B S 2013 Renewable energy-powered membrane technology: supercapacitors for buffering resource fluctuations in a wind-powered membrane system for brackish water desalination *Renew. Energy* **50** 126–35
- [61] Freire-Gormaly M and Bilton A 2019 Impact of intermittent operation on reverse osmosis membrane fouling for brackish groundwater desalination systems *J. Membr. Sci.* **583** 220–30
- [62] Belkin N, Rahav E, Elifantz H, Kress N and Berman-Frank I 2017 The effect of coagulants and antiscalants discharged with seawater desalination brines on coastal microbial communities: a laboratory and in situ study from the southeastern Mediterranean *Water Res.* **110** 321–31

- [63] Sola I, Fernández-Torquemada Y, Forcada A, Valle C, Del Pilar-Ruso Y, González-Corrae J M and Sánchez-Lizaso J L 2020 Sustainable desalination: long-term monitoring of brine discharge in the marine environment *Mar. Pollut. Bull.* **161** 111813
- [64] Nassrullah H, Anis S F, Hashaikheh R and Hilal N 2020 Energy for desalination: a state-of-the-art review *Desalination* **491** 114569
- [65] Al-Karaghoulis A and Kazmerski L L 2013 Energy consumption and water production cost of conventional and renewable-energy-powered desalination processes *Renew. Sustain. Energy Rev.* **24** 343–56
- [66] Cornejo P K, Santana M V, Hokanson D R, Mihelcic J R and Zhang Q 2014 Carbon footprint of water reuse and desalination: a review of greenhouse gas emissions and estimation tools *J. Water Reuse Desal.* **4** 238–52
- [67] Khawaji A D, Kutubkhanah I K and Wie J-M 2008 Advances in seawater desalination technologies *Desalination* **221** 47–69
- [68] Aljuwaiser A, Aleisa E and Alshayji K 2023 Environmental and economic analysis for desalinating seawater of high salinity using reverse osmosis: a life cycle assessment approach *Environ. Dev. Sustain.* **25** 4539–74
- [69] Loeb S and Sourirajan S 1963 Sea water demineralization by means of an osmotic membrane *Saline Water Conversion—II (Advances in Chemistry vol 38)* (American Chemical Society) ch 9, pp 117–32
- [70] Okamoto Y and Lienhard J H 2019 How RO membrane permeability and other performance factors affect process cost and energy use: a review *Desalination* **470** 114064
- [71] Sharqawy M H, Lienhard J H and Zubair S M 2010 Thermophysical properties of seawater: a review of existing correlations and data *Desalin. Water Treat.* **16** 354–80
- [72] Xevgenos D, Marcou M, Louca V, Avramidi E, Ioannou G, Argyrou M, Stavrou P, Mortou M and Küpper F C 2021 Aspects of environmental impacts of seawater desalination: cyprus as a case study *Desalin. Water Treat.* **211** 15–30
- [73] Xevgenos D, Vidalis A, Moustakas K, Malamis D and Loizidou M 2015 Sustainable management of brine effluent from desalination plants: the SOL-BRINE system *Desalin. Water Treat.* **53** 3151–60
- [74] Xevgenos D, Michailidis P, Dimopoulos K, Krokida M and Loizidou M 2015 Design of an innovative vacuum evaporator system for brine concentration assisted by software tool simulation *Desalin. Water Treat.* **53** 3407–17
- [75] Andrés-Mañas J, Ruiz-Aguirre A, Ación F and Zaragoza G 2020 Performance increase of membrane distillation pilot scale modules operating in vacuum-enhanced air-gap configuration *Desalination* **475** 114202
- [76] Liu Y, Liu J, Zhang Q, Zhu Q, Liu X, Wang Z and Dai Z 2022 CuO/Ag₂S/CuS nanohybrids-integrated photoelectric and photothermal effects for ultrasensitive detection of inorganic pyrophosphatase *Adv. Funct. Mater.* **32** 2106854
- [77] Uson L et al 2022 Nanoengineering palladium plasmonic nanosheets inside polymer nanospheres for photothermal therapy and targeted drug delivery *Adv. Funct. Mater.* **32** 2106932
- [78] Yu Q, Peng T, Zhang J, Liu X, Pan Y, Ge D, Zhao L, Rosei F and Zhang J 2022 Cu_{2-x}S_x capped AuCu nanostars for efficient plasmonic photothermal tumor treatment in the second near-infrared window *Small* **18** e2103174
- [79] Xiang Q, Yang C, Luo Y, Liu F, Zheng J, Liu W, Ran H, Sun Y, Ren J and Wang Z 2022 Near-infrared II nanoadjuvant-mediated chemodynamic, photodynamic, and photothermal therapy combines immunogenic cell death with PD-L1 blockade to enhance antitumor immunity *Small* **18** e2107809
- [80] Shan B, Liu H, Li L, Lu Y and Li M 2022 Near-infrared II plasmonic phototheranostics with glutathione depletion for multimodal imaging-guided hypoxia-tolerant chemodynamic-photocatalytic-photothermal cancer therapy triggered by a single laser *Small* **18** e2105638
- [81] Baffou G and Quidant R 2013 Thermo-plasmonics: using metallic nanostructures as nano-sources of heat *Laser Photonics Rev.* **7** 171–87
- [82] Baffou G, Cichos F and Quidant R 2020 Applications and challenges of thermoplasmonics *Nat. Mater. Rev.* **19** 946–58
- [83] Ma N, Zhang M-K, Wang X-S, Zhang L, Feng J and Zhang X-Z 2018 NIR light-triggered degradable MoTe₂ nanosheets for combined photothermal and chemotherapy of cancer *Adv. Funct. Mater.* **28** 1801139
- [84] Tian B, Liu S, Feng L, Liu S, Gai S, Dai Y, Xie L, Liu B, Yang P and Zhao Y 2021 Renal-clearable nickel-doped carbon dots with boosted photothermal conversion efficiency for multimodal imaging-guided cancer therapy in the second near-infrared biowindow *Adv. Funct. Mater.* **31** 2100549
- [85] Ye P et al 2022 In situ generation of gold nanoparticles on bacteria-derived magnetosomes for imaging-guided starving/chemodynamic/photothermal synergistic therapy against cancer *Adv. Funct. Mater.* **32** 2110063
- [86] Tang H, Xu X, Chen Y, Xin H, Wan T, Li B, Pan H, Li D and Ping Y 2021 Reprogramming the tumor microenvironment through second-near-infrared-window photothermal genome editing of PD-L1 mediated by supramolecular gold nanorods for enhanced cancer immunotherapy *Adv. Mater.* **33** e2006003
- [87] Ali M R, Ali H R, Rankin C R and El-Sayed M A 2016 Targeting heat shock protein 70 using gold nanorods enhances cancer cell apoptosis in low dose plasmonic photothermal therapy *Biomaterials* **102** 1–8
- [88] Zheng R, Zhao Q, Qing W, Li S, Liu Z, Li Q and Huang Y 2022 Carrier-free delivery of ultrasmall π -conjugated oligomer nanoparticles with photothermal conversion over 80% for cancer theranostics *Small* **18** e2104521
- [89] Li Z, Ye Z, Han L, Fan Q, Wu C, Ding D, Xin H L, Myung N V and Yin Y 2021 Polarization-modulated multidirectional photothermal actuators *Adv. Mater.* **33** 2006367
- [90] Naldoni A et al 2020 Solar thermoplasmonic nanofurnace for high-temperature heterogeneous catalysis *Nano Lett.* **20** 3663–72
- [91] Gaspari R, Della Valle G, Ghosh S, Krieger I, Scotognella F, Cavalli A and Manna L 2017 Quasi-static resonances in the visible spectrum from all-dielectric intermediate band semiconductor nanocrystals *Nano Lett.* **17** 7691–5
- [92] Hu S, Shi J, Luo B, Ai C and Jing D 2022 Significantly enhanced photothermal catalytic hydrogen evolution over Cu₂O-rGO/TiO₂ composite with full spectrum solar light *J. Colloid Interface Sci.* **608** 2058–65
- [93] Li J, Ma L, Fu C, Huang Y, Luo B, Cao J, Geng J and Jing D 2022 Urchinlike carbon-coated TiO₂ microspheres with enhanced photothermal-photocatalytic hydrogen evolution performance for full-spectrum solar energy conversion *Ind. Eng. Chem. Res.* **61** 6436–47
- [94] Mascaretti L, Schirato A, Zbořil R, Kment Š, Schmuki P, Alabastris A and Naldoni A 2021 Solar steam generation on scalable ultrathin thermoplasmonic TiN nanocavity arrays *Nano Energy* **83** 105828
- [95] Lin Y, Xu H, Shan X, Di Y, Zhao A, Hu Y and Gan Z 2019 Solar steam generation based on the photothermal effect: from designs to applications, and beyond *J. Mater. Chem. A* **7** 19203–27
- [96] Han X et al 2021 Intensifying heat using MOF-isolated graphene for solar-driven seawater desalination at 98% solar-to-thermal efficiency *Adv. Funct. Mater.* **31** 2008904
- [97] Zhang H, Shen X, Kim E, Wang M, Lee J-H, Chen H, Zhang G and Kim J-K 2022 Integrated water and thermal managements in bioinspired hierarchical MXene aerogels for highly efficient solar-powered water evaporation *Adv. Funct. Mater.* **32** 2111794
- [98] Irshad M S, Arshad N, Wang X, Li H R, Javed M Q, Xu Y, Alshahrani L A, Mei T and Li J 2021 Intensifying solar interfacial heat accumulation for clean water generation excluding heavy metal ions and oil emulsions *Solar RRL* **5** 2100427

- [99] Irshad M S, Wang X, Abbas A, Yu F, Li J, Wang J, Mei T, Qian J, Wu S and Javed M Q 2021 Salt-resistant carbon dots modified solar steam system enhanced by chemical advection *Carbon* **176** 313–26
- [100] Irshad M S, Wang X, Abbasi M S, Arshad N, Chen Z, Guo Z, Yu L, Qian J, You J and Mei T 2021 Semiconductive, flexible MnO₂ NWs/chitosan hydrogels for efficient solar steam generation *ACS Sustain. Chem. Eng.* **9** 3887–900
- [101] Loo S-L, Vásquez L, Zahid M, Costantino F, Athanassiou A and Fragouli D 2021 3D photothermal cryogels for solar-driven desalination *ACS Appl. Mater. Interfaces* **13** 30542–55
- [102] Lou M, Li J, Zhu X, Chen J, Zhang X, Fang X and Li F 2023 Difunctional MOF-wrapped graphene membranes for efficient photothermal membrane distillation and VOCs interception *J. Membr. Sci.* **676** 121592
- [103] Yu J, Sun D, Li B, Yue D, Ge Y, Xu R, Liang H, Song X and Zhai D 2023 Flower-like CuO light traps as anti-wetting armor of Janus membrane for spraying wastewater treatment by photothermal membrane distillation *J. Membr. Sci.* **688** 122113
- [104] Xu G R, Wang M, Xu K, Zhao H L and Liu Q 2023 Membrane fabrication and configuration design development of photothermal membrane distillation (PMD) *Desalination* **565** 116833
- [105] Wang Y, Liao X, Zhang X, Shi M, You X, Liao Y and Razaqpur A G 2023 Engineering surface wettability to alleviate membrane scaling in photothermal membrane distillation *ACS ES T Water* **3** 1847–54
- [106] Abramovich S et al 2022 NiSe and CoSe topological nodal-line semimetals: a sustainable platform for efficient thermoplasmonics and solar-driven photothermal membrane distillation *Small* **18** 2201473
- [107] Avci A H, Santoro S, Politano A, Propato M, Miceli M, Aquino M, Wenzhan Z and Curcio E 2021 Photothermal sweeping gas membrane distillation and reverse electro dialysis for light-to-heat-to-power conversion *Chem. Eng. Process* **164** 108382
- [108] Elmaghraoui D, Politano A and Jaziri S 2020 Photothermal response of plasmonic nanofillers for membrane distillation *J. Chem. Phys.* **152** 114102
- [109] Politano A, Argurio P, Di Profio G, Sanna V, Cupolillo A, Chakraborty S, Arafat H A and Curcio E 2017 Photothermal membrane distillation for seawater desalination *Adv. Mater.* **29** 1603504
- [110] Li Y, Song Y, Zhang X, Liu T, Xu T, Wang H, Jiang D-E and Jin R 2022 Atomically precise Au₄₂ Nanorods with longitudinal excitons for an intense photothermal effect *J. Am. Chem. Soc.* **144** 12381–9
- [111] Yang M Q, Tan C F, Lu W, Zeng K and Ho G W 2020 Spectrum tailored defective 2D semiconductor nanosheets aerogel for full-spectrum-driven photothermal water evaporation and photochemical degradation *Adv. Funct. Mater.* **30** 2004460
- [112] Dong J, Li J, Yang L, Zhang T, Lu R, Li J, Zhang L and Zhou S 2020 Decoupling of thermo-electronic effect by traveling photothermal mirror method for characterization of thermal properties of semiconductors *Appl. Phys. Lett.* **116** e0004143
- [113] Ghosh S et al 2016 Colloidal CuFeS₂ nanocrystals: intermediate Fe d-band leads to high photothermal conversion efficiency *Chem. Mater.* **28** 4848–58
- [114] Zafar M S, Zahid M, Athanassiou A and Fragouli D 2021 Biowaste-derived carbonized bone for solar steam generation and seawater desalination *Adv. Sustain. Syst.* **5** 2100031
- [115] Loo S-L, Vásquez L, Paul U C, Campagnolo L, Athanassiou A and Fragouli D 2020 Solar-driven freshwater generation from seawater and atmospheric moisture enabled by a hydrophilic photothermal foam *ACS Appl. Mater. Interfaces* **12** 10307–16
- [116] Naik G V, Shalaev V M and Boltasseva A 2013 Alternative plasmonic materials: beyond gold and silver *Adv. Mater.* **25** 3264–94
- [117] Li Y et al 2021 Solution-processed all-ceramic plasmonic metamaterials for efficient solar-thermal conversion over 100–727 °C *Adv. Mater.* **33** e2005074
- [118] O'Neill D B, Frehan S K, Zhu K, Zoethout E, Mul G, Garnett E C, Huijser A and Askes S H C 2021 Ultrafast photoinduced heat generation by plasmonic HfN nanoparticles *Adv. Opt. Mater.* **9** 2100510
- [119] Yang J, Sun L, Hui S, Zhang P, Li J, Wang D, Wang X and Jiang S 2021 Ag functionalized SnS₂ with enhanced photothermal activity for safe and efficient wound disinfection *Biomater. Sci.* **9** 4728–36
- [120] Lee S, Truong L, Lee M-J and Chun S-H 2021 Comparative study of SnSe₂ exfoliation and the photothermal current from the products *Cryst. Growth Des.* **21** 6648–54
- [121] Xie Z et al 2020 The rise of 2D photothermal materials beyond graphene for clean water production *Adv. Sci.* **7** 1902236
- [122] Liu C et al 2021 Arsenene nanodots with selective killing effects and their low-dose combination with β-element for cancer therapy *Adv. Mater.* **33** e2102054
- [123] Ouyang J et al 2021 Cryogenic exfoliation of 2D stanene nanosheets for cancer theranostics *Nano Micro. Lett.* **13** 1–18
- [124] Fan X, Ding Y, Liu Y, Liang J and Chen Y 2019 Plasmonic Ti₃C₂T_x MXene enables highly efficient photothermal conversion for healable and transparent wearable device *ACS Nano* **13** 8124–34
- [125] Chaudhuri K, Alhabeib M, Wang Z, Shalaev V M, Gogotsi Y and Boltasseva A 2018 Highly broadband absorber using plasmonic titanium carbide (MXene) *ACS Photonics* **5** 1115–22
- [126] Sachet E et al 2015 Dysprosium-doped cadmium oxide as a gateway material for mid-infrared plasmonics *Nat. Mater.* **14** 414–20
- [127] Sun K, Xiao W, Ye S, Kalfagiannis N, Kiang K S, de Groot C H (Kees) and Muskens O L 2020 Embedded metal oxide plasmonics using local plasma oxidation of AZO for planar metasurfaces *Adv. Mater.* **32** 2001534
- [128] Wang Y, Overvig A C, Shrestha S, Zhang R, Wang R, Yu N and Dal Negro L 2017 Tunability of indium tin oxide materials for mid-infrared plasmonics applications *Opt. Mater. Express* **7** 2727–39
- [129] Shabani A, Nezhad M K, Rahmani N, Mishra Y K, Sanyal B and Adam J 2021 Revisiting the optical dispersion of aluminum-doped zinc oxide: new perspectives for plasmonics and metamaterials *Adv. Photon. Res.* **2** 2000086
- [130] Tan Y Z, Wang H, Han L, Tanis-Kanbur M B, Pranav M V and Chew J W 2018 Photothermal-enhanced and fouling-resistant membrane for solar-assisted membrane distillation *J. Membr. Sci.* **565** 254–65
- [131] Island J O, Steele G A, van der Zant H S J and Castellanos-Gomez A 2015 Environmental instability of few-layer black phosphorus *2D Mater.* **2** 011002
- [132] Paolucci V, D'Olimpio G, Kuo C-N, Lue C S, Boukhvalov D W, Cantalini C and Politano A 2020 Self-assembled SnO₂/SnSe₂ heterostructures: a suitable platform for ultrasensitive NO₂ and H₂ sensing *ACS Appl. Mater. Interfaces* **12** 34362–9
- [133] Lalisce A, Tessier G, Plain J and Baffou G 2015 Quantifying the efficiency of plasmonic materials for near-field enhancement and photothermal conversion *J. Phys. Chem. C* **119** 25518–28
- [134] Baffou G, Quidant R and García de Abajo F J 2010 Nanoscale control of optical heating in complex plasmonic systems *ACS Nano* **4** 709–16
- [135] Baffou G, Berto P, Bermúdez Ureña E, Quidant R, Monneret S, Polleux J and Rigneault H 2013 Photoinduced heating of nanoparticle arrays *ACS Nano* **7** 6478–88
- [136] Cortie M B, Arnold M D and Keast V J 2020 The quest for zero loss: unconventional materials for plasmonics *Adv. Mater.* **32** 1904532
- [137] Gong T and Munday J N 2015 Materials for hot carrier plasmonics *Opt. Mater. Express* **5** 2501–12

- [138] Rasmussen A, Deilmann T and Thygesen K S 2021 Towards fully automated GW band structure calculations: what we can learn from 60,000 self-energy evaluations *npj Comput. Mater.* **7** 1–9
- [139] Xu Y, Elcoro L, Song Z-D, Wieder B J, Vergniory M G, Regnault N, Chen Y, Felsner C and Bernevig B A 2020 High-throughput calculations of magnetic topological materials *Nature* **586** 702–7
- [140] Jain A et al 2013 Commentary: the materials project: a materials genome approach to accelerating materials innovation *Appl. Mater.* **1** 011002
- [141] Wang C, Zhang G, Huang S, Xie Y and Yan H 2020 The optical properties and plasmonics of anisotropic 2D materials *Adv. Opt. Mater.* **8** 1900996
- [142] Nemilentsau A, Low T and Hanson G 2016 Anisotropic 2D materials for tunable hyperbolic plasmonics *Phys. Rev. Lett.* **116** 066804
- [143] Korzeb K, Gajc M and Pawlak D A 2015 Compendium of natural hyperbolic materials *Opt. Express* **23** 25406–24
- [144] Zhang S, Shi W, Siegler T D, Gao X, Ge F, Korgel B A, He Y, Li S and Wang X 2019 An all-inorganic colloidal nanocrystal flexible polarizer *Angew. Chem.* **131** 8822–7
- [145] Yang H, Jussila H, Autere A, Komsa H-P, Ye G, Chen X, Hasan T and Sun Z 2017 Optical waveplates based on birefringence of anisotropic two-dimensional layered materials *ACS Photonics* **4** 3023–30
- [146] Dehbashi R, Bialkowski K S and Abbosh A M 2017 Uniqueness theorem and uniqueness of inverse problems for lossy anisotropic inhomogeneous structures with diagonal material tensors *J. Appl. Phys.* **121** 203103
- [147] Song Y, Tran V and Lee J 2017 Tuning plasmon resonance in magnetoplasmonic nanochains by controlling polarization and interparticle distance for simple preparation of optical filters *ACS Appl. Mater. Interfaces* **9** 24433–9
- [148] Zhang X, Guo L, Zhang B, Yu J, Wang Y, Wu K, Wang H-J and Lee M-H 2021 From silicates to oxonitridosilicates: improving optical anisotropy for phase-matching as ultraviolet nonlinear optical materials *Chem. Commun.* **57** 639–42
- [149] Gu K and Zhong H 2023 A general methodology to measure the light-to-heat conversion efficiency of solid materials *Light: Sci. Appl.* **12** 120
- [150] Zhang F, Xu D, Zhang D, Ma L, Wang J, Huang Y, Chen M, Qian H and Li X 2021 A durable and photothermal superhydrophobic coating with entwined CNTs-SiO₂ hybrids for anti-icing applications *Chem. Eng. J.* **423** 130238
- [151] Shao B, Wu X, Wang Y, Gao T, Liu Z-Q, Owens G and Xu H 2020 A general method for selectively coating photothermal materials on 3D porous substrate surfaces towards cost-effective and highly efficient solar steam generation *J. Mater. Chem. A* **8** 24703–9
- [152] Seekkuarachchi I N, Tanaka K and Kumazawa H 2008 Dispersion mechanism of nano-particulate aggregates using a high pressure wet-type jet mill *Chem. Eng. Sci.* **63** 2341–66
- [153] Choi C-H, Kwak Y, Malhotra R and Chang C-H 2020 Microfluidics for two-dimensional nanosheets: a mini review *Processes* **8** 1067
- [154] Pinilla S, Coelho J, Li K, Liu J and Nicolosi V 2022 Two-dimensional material inks *Nat. Rev. Mater.* **7** 717–35
- [155] Hohenberg P and Kohn W 1964 Inhomogeneous electron gas *Phys. Rev.* **136** B864–B871
- [156] Myroshnychenko V, Rodríguez-Fernández J, Pastoriza-Santos I, Funston A M, Novo C, Mulvaney P, Liz-Marzán L M and García de Abajo F J 2008 Modelling the optical response of gold nanoparticles *Chem. Soc. Rev.* **37** 1792–805
- [157] Duan H, Fernández-Domínguez A I, Bosman M, Maier S A and Yang J K 2012 Nanoplasmonics: classical down to the nanometer scale *Nano Lett.* **12** 1683–9
- [158] Adamo C and Jacquemin D 2013 The calculations of excited-state properties with time-dependent density functional theory *Chem. Soc. Rev.* **42** 845–56
- [159] Onida G, Reining L and Rubio A 2002 Electronic excitations: density-functional versus many-body Green's-function approaches *Rev. Mod. Phys.* **74** 601–59
- [160] Hybertsen M S and Louie S G 1986 Electron correlation in semiconductors and insulators: band gaps and quasiparticle energies *Phys. Rev. B* **34** 5390
- [161] Esteban R, Zugarramurdi A, Zhang P, Nordlander P, García-Vidal F J, Borisov A G and Aizpurua J 2015 A classical treatment of optical tunneling in plasmonic gaps: extending the quantum corrected model to practical situations *Faraday Discuss.* **178** 151–83
- [162] Zhu W, Esteban R, Borisov A G, Baumberg J J, Nordlander P, Lezec H J, Aizpurua J and Crozier K B 2016 Quantum mechanical effects in plasmonic structures with subnanometre gaps *Nat. Commun.* **7** 1–14
- [163] Christensen T, Yan W, Jauho A-P, Soljačić M and Mortensen N A 2017 Quantum corrections in nanoplasmonics: shape, scale, and material *Phys. Rev. Lett.* **118** 157402
- [164] Mystilidis C, Zheng X and Vandenbosch G A 2023 OpenSANS: a semi-analytical solver for nonlocal plasmonics *Comput. Phys. Commun.* **284** 108609
- [165] Heyd J, Scuseria G E and Ernzerhof M 2003 Hybrid functionals based on a screened Coulomb potential *J. Chem. Phys.* **118** 8207–15
- [166] Kuisma M, Ojanen J, Enkovaara J and Rantala T T 2010 Kohn-Sham potential with discontinuity for band gap materials *Phys. Rev. B* **82** 115106
- [167] Dabo I, Ferretti A, Poilvert N, Li Y, Marzari N and Cococcioni M 2010 Koopmans' condition for density-functional theory *Phys. Rev. B* **82** 115121
- [168] Marini A, Hogan C, Grüning M and Varsano D 2009 Yambo: an ab initio tool for excited state calculations *Comput. Phys. Commun.* **180** 1392–403
- [169] Deslippe J, Samsonidze G, Strubbe D A, Jain M, Cohen M L and Louie S G 2012 BerkeleyGW: a massively parallel computer package for the calculation of the quasiparticle and optical properties of materials and nanostructures *Comput. Phys. Commun.* **183** 1269–89
- [170] Prandini G, Galante M, Marzari N and Umari P 2019 SIMPLE code: optical properties with optimal basis functions *Comput. Phys. Commun.* **240** 106–19
- [171] Ngo T D, Tran T P, Ngo H D and Nagao T 2022 A simultaneous material-device optimization for plasmonic devices: a combined ab initio and electromagnetic simulation for photothermal transducers *Adv. Opt. Mater.* **10** 2201320
- [172] Jain A et al 2015 FireWorks: a dynamic workflow system designed for high-throughput applications *Concurr. Comput. Pract. Exp.* **27** 5037–59
- [173] Pizzi G, Cepellotti A, Sabatini R, Marzari N and Kozinsky B 2016 AiiDA: automated interactive infrastructure and database for computational science *Comput. Mater. Sci.* **111** 218–30
- [174] Kulik H J et al 2022 Roadmap on machine learning in electronic structure *Electron. Struct.* **4** 023004
- [175] Zauchner M G, Horsfield A and Lischner J 2023 Accelerating GW calculations through machine-learned dielectric matrices *npj Comput. Mater.* **9** 184

- [176] Wiecha P R and Muskens O L 2020 Deep learning meets nanophotonics: a generalized accurate predictor for near fields and far fields of arbitrary 3D nanostructures *Nano Lett.* **20** 329–38
- [177] Priya P, Nguyen T C, Saxena A and Aluru N R 2022 Machine learning assisted screening of two-dimensional materials for water desalination *ACS Nano* **16** 1929–39
- [178] Ray S S, Verma R K, Singh A, Ganesapillai M and Kwon Y-N 2023 A holistic review on how artificial intelligence has redefined water treatment and seawater desalination processes *Desalination* **546** 116221
- [179] Ran J et al 2017 Ion exchange membranes: new developments and applications *J. Membr. Sci.* **522** 267–91
- [180] Bazinet L and Geoffroy T R 2020 Electrodialytic processes: market overview, membrane phenomena, recent developments and sustainable strategies *Membranes* **10** 221
- [181] Campione A, Gurreri L, Ciofalo M, Micale G, Tamburini A and Cipollina A 2018 Electrodialysis for water desalination: a critical assessment of recent developments on process fundamentals, models and applications *Desalination* **434** 121–60
- [182] Pärnamäe R et al 2021 Bipolar membranes: a review on principles, latest developments, and applications *J. Membr. Sci.* **617** 118538
- [183] Gurreri L, Tamburini A, Cipollina A and Micale G 2020 Electrodialysis applications in wastewater treatment for environmental protection and resources recovery: a systematic review on progress and perspectives *Membranes* **10** 146
- [184] Al-Amshawee S, Yunus M Y B M, Azoddein A A M, Hassell D G, Dakhil I H and Hasan H A 2020 Electrodialysis desalination for water and wastewater: a review *Chem. Eng. J.* **380** 122231
- [185] Eke J, Yusuf A, Giwa A and Sodiq A 2020 The global status of desalination: an assessment of current desalination technologies, plants and capacity *Desalination* **495** 114633
- [186] Luo Y, Liu Y, Shen J and Van der Bruggen B 2022 Application of bipolar membrane electrodialysis in environmental protection and resource recovery: a review *Membranes* **12** 829
- [187] Donnan F G 1911 Theorie der Membrangleichgewichte und Membranpotentiale bei Vorhandensein von nicht dialysierenden Elektrolyten. Ein Beitrag zur physikalisch-chemischen Physiologie *Z. Elektrochem. Angew. Phys. Chem.* **17** 572–81
- [188] Chen H, Rose M, Fleming M, Souizi S, Shashvatt U and Blaney L 2023 Recent advances in Donnan dialysis processes for water/wastewater treatment and resource recovery: a critical review *Chem. Eng. J.* **455** 140522
- [189] Asante-Sackey D, Rathilal S, Kweiner Tetteh E, Ezugbe E O and Pillay L V 2021 Donnan membrane process for the selective recovery and removal of target metal ions—a mini review *Membranes* **11** 358
- [190] Ping Q, Abu-Reesh I M and He Z 2015 Boron removal from saline water by a microbial desalination cell integrated with donnan dialysis *Desalination* **376** 55–61
- [191] McCartney S N, Fan H, Watanabe N S, Huang Y and Yip N Y 2022 Donnan dialysis for phosphate recovery from diverted urine *Water Res.* **226** 119302
- [192] Filingeri A, Gurreri L, Ciofalo M, Cipollina A, Tamburini A and Micale G 2023 Current distribution along electrodialysis stacks and its influence on the current-voltage curve: behaviour from near-zero current to limiting plateau *Desalination* **556** 116541
- [193] Gurreri L, Filingeri A, Ciofalo M, Cipollina A, Tedesco M, Tamburini A and Micale G 2021 Electrodialysis with asymmetrically profiled membranes: influence of profiles geometry on desalination performance and limiting current phenomena *Desalination* **506** 115001
- [194] Loza S, Loza N, Kutenko N and Smyshlyaev N 2022 Profiled ion-exchange membranes for reverse and conventional electrodialysis *Membranes* **12** 985
- [195] Ge L, Wu B, Li Q, Wang Y, Yu D, Wu L, Pan J, Miao J and Xu T 2016 Electrodialysis with nanofiltration membrane (EDNF) for high-efficiency cations fractionation *J. Membr. Sci.* **498** 192–200
- [196] Ye W, Liu R, Chen X, Chen Q, Lin X, Van der Bruggen B and Zhao S 2020 Loose nanofiltration-based electrodialysis for highly efficient textile wastewater treatment *J. Membr. Sci.* **608** 118182
- [197] Lu H, Zou W, Chai P, Wang J and Bazinet L 2016 Feasibility of antibiotic and sulfate ions separation from wastewater using electrodialysis with ultrafiltration membrane *J. Clean. Prod.* **112** 3097–105
- [198] Tamersit S, Bouhidel K-E and Zidani Z 2018 Investigation of electrodialysis anti-fouling configuration for desalting and treating tannery unhairing wastewater: feasibility of by-products recovery and water recycling *J. Environ. Manage.* **207** 334–40
- [199] Gurreri L, La Cerva M, Moreno J, Goossens B, Trunz A and Tamburini A 2022 Coupling of electromembrane processes with reverse osmosis for seawater desalination: pilot plant demonstration and testing *Desalination* **526** 115541
- [200] Gurreri L, Ciofalo M, Cipollina A, Tamburini A and Micale G 2022 Application of computational fluid dynamics technique in electrodialysis/reverse electrodialysis processes *Current Trends and Future Developments on (Bio-) Membranes* (Elsevier) pp 81–160
- [201] Beshia A T, Tsehay M T, Aili D, Zhang W and Tufa R A 2019 Design of monovalent ion selective membranes for reducing the impacts of multivalent ions in reverse electrodialysis *Membranes* **10** 7
- [202] Rijnaarts T, Shenkute N T, Wood J A, de Vos W M and Nijmeijer K 2018 Divalent cation removal by donnan dialysis for improved reverse electrodialysis *ACS Sustain. Chem. Eng.* **6** 7035–41
- [203] Tufa R A, Piallat T, Hnát J, Fontananova E, Paidar M, Chanda D, Curcio E, Di Profio G and Bouzek K 2020 Salinity gradient power reverse electrodialysis: cation exchange membrane design based on polypyrrole-chitosan composites for enhanced monovalent selectivity *Chem. Eng. J.* **380** 122461
- [204] Xu T et al 2022 Highly ion-permselective porous organic cage membranes with hierarchical channels *J. Am. Chem. Soc.* **144** 10220–9
- [205] Kim D and Nunes S P 2021 Green solvents for membrane manufacture: recent trends and perspectives *Curr. Res. Green Sustain. Chem.* **28** 100427
- [206] Van Geluwe S, Braeken L, Robberecht T, Jans M, Creemers C and Van der Bruggen B 2011 Evaluation of electrodialysis for scaling prevention of nanofiltration membranes at high water recoveries *Resour. Conserv. Recycl.* **56** 34–42
- [207] Moreno J, Grasman S, Van Engelen R and Nijmeijer K 2018 Upscaling reverse electrodialysis *Environ. Sci. Technol.* **52** 10856–63
- [208] Jones A and Finley W 2003 Recent development in salinity gradient power *Oceans 2003. Celebrating the Past.. Teaming Toward the Future (IEEE Cat. No. 03CH37492)* vol 4 pp 2284–7
- [209] Cummings C Y et al 2011 Electron hopping rate measurements in ITO junctions: charge diffusion in a layer-by-layer deposited ruthenium(II)-bis(benzimidazolyl)pyridine-phosphonate- TiO₂ film *J. Electroanal. Chem.* **657** 196–201
- [210] Elmakki T, Zavahir S, Gulied M, Qiblawey H, Hammadi B, Khraishem M, Shon H K, Park H and Han D S 2023 Potential application of hybrid reverse electrodialysis (RED)-forward osmosis (FO) system to fertilizer-producing industrial plant for efficient water reuse *Desalination* **550** 116374
- [211] Loeb S 1979 *Method and Apparatus for Generating Power Utilizing Reverse Electrodialysis* (Google Patents)
- [212] Loeb S and Norman R S 1975 Osmotic power plants *Science* **189** 654–5

- [213] Yip N Y and Elimelech M 2014 Comparison of energy efficiency and power density in pressure retarded osmosis and reverse electro dialysis *Environ. Sci. Technol.* **48** 11002–12
- [214] Zhang B, Gao H, Tong X, Liu S, Gan L and Chen Y 2019 Pressure retarded osmosis and reverse electro dialysis as power generation membrane systems *Current Trends and Future Developments on (Bio-) Membranes* (Elsevier) pp 133–52
- [215] Ju J, Choi Y, Lee S and Jeong N 2021 Comparison of fouling characteristics between reverse electro dialysis (RED) and pressure retarded osmosis (PRO) *Desalination* **497** 114648
- [216] Nazif A, Karkhanechi H, Saljoughi E, Mousavi S M and Matsuyama H 2022 Recent progress in membrane development, affecting parameters, and applications of reverse electro dialysis: a review *J. Water Process Eng.* **47** 102706
- [217] Shi Y, Zhang M, Zhang H, Yang F, Tang C Y and Dong Y 2021 Recent development of pressure retarded osmosis membranes for water and energy sustainability: a critical review *Water Res.* **189** 116666
- [218] Oussama N, Bouabdesselam H, Ghaffour N and Abdelkader L 2019 Characterization of seawater reverse osmosis fouled membranes from large scale commercial desalination plant *Chem. Int.* **5** 158–67
- [219] Rao A K, Li O R, Wrede L, Coan S M, Elias G, Cordoba S, Roggenberg M, Castillo L and Warsinger D M 2021 A framework for blue energy enabled energy storage in reverse osmosis processes *Desalination* **511** 115088
- [220] Kotoka F, Merino-Garcia I and Velizarov S 2020 Surface modifications of anion exchange membranes for an improved reverse electro dialysis process performance: a review *Membranes* **10** 160
- [221] Dhugołęcki P, Dąbrowska J, Nijmeijer K and Wessling M 2010 Ion conductive spacers for increased power generation in reverse electro dialysis *J. Membr. Sci.* **347** 101–7
- [222] Tian H, Wang Y, Pei Y and Crittenden J C 2020 Unique applications and improvements of reverse electro dialysis: a review and outlook *Appl. Energy* **262** 114482
- [223] Veerman J, Saakes M, Metz S J and Harmsen G J 2010 Reverse electro dialysis: evaluation of suitable electrode systems *J. Appl. Electrochem.* **40** 1461–74
- [224] Santoro S, Tufa R A, Avci A H, Fontananova E, Di Profio G and Curcio E 2021 Fouling propensity in reverse electro dialysis operated with hypersaline brine *Energy* **228** 120563
- [225] Shah S A, Choi S-Y, Cho S, Shahbabaee M, Singh R and Kim D 2020 Modified single-wall carbon nanotube for reducing fouling in perfluorinated membrane-based reverse electro dialysis *Int. J. Hydrog. Energy* **45** 30703–19
- [226] Kwon K, Han J, Park B H, Shin Y and Kim D 2015 Brine recovery using reverse electro dialysis in membrane-based desalination processes *Desalination* **362** 1–10
- [227] Idarraga-Mora J A, Ladner D A and Husson S M 2018 Thin-film composite membranes on polyester woven mesh with variable opening size for pressure-retarded osmosis *J. Membr. Sci.* **549** 251–9
- [228] Gonzales R R, Abdel-Wahab A, Adham S, Han D S, Phuntsho S, Suwaileh W, Hilal N and Shon H K 2021 Salinity gradient energy generation by pressure retarded osmosis: a review *Desalination* **500** 114841
- [229] European Commission 2020 Study on the EU's list of critical raw materials *Brussels* (available at: <https://op.europa.eu/en/publication-detail/-/publication/c0d5292a-ee54-11ea-991b-01aa75ed71a1/language-en>)
- [230] O. Canada G 2023 Canada's hub for critical minerals (available at: www.canada.ca/en/campaign/critical-minerals-in-canada.html) (Accessed 27 February 2023)
- [231] Australian Trade and Investment Commission 2022 Australian critical minerals prospectus 2022 (available at: www.globalaustralia.gov.au/sites/default/files/2022-12/Australian_Critical_Minerals_Prospects_2022_Dec22.pdf)
- [232] Petty T R 2018 Federal Register-The Daily Journal of the United States Government *Final List of Critical Minerals 2018* (available at: www.federalregister.gov/documents/2018/05/18/2018-10667/final-list-of-critical-minerals-2018)
- [233] 2018 *Final List of Critical Minerals 2018* (available at: www.federalregister.gov/documents/2018/05/18/2018-10667/final-list-of-critical-minerals-2018)
- [234] Vikström H, Davidsson S and Höök M 2013 Lithium availability and future production outlooks *Appl. Energy* **110** 252–66
- [235] Khalil A, Mohammed S, Hashaikeh R and Hilal N 2022 Lithium recovery from brine: recent developments and challenges *Desalination* **528** 115611
- [236] Ambrose H and Kendall A 2020 Understanding the future of lithium: part 1, resource model *J. Ind. Ecol.* **24** 80–89
- [237] Global Water Intelligence *GWIDesalData DESALINATION* (available at: www.desaldata.com/)
- [238] Loganathan P, Naidu G and Vigneswaran S 2017 Mining valuable minerals from seawater: a critical review *Environ. Sci. Water Res. Technol.* **3** 37–53
- [239] DuChanois R M, Cooper N J, Lee B, Patel S K, Mazurowski L, Graedel T E and Elimelech M 2023 Prospects of metal recovery from wastewater and brine *Nat. Water* **1** 37–46
- [240] Kumar A, Naidu G, Fukuda H, Du F, Vigneswaran S, Drioli E and Lienhard J H 2021 Metals recovery from seawater desalination brines: technologies, opportunities, and challenges *ACS Sustain. Chem. Eng.* **9** 7704–12
- [241] Chen P, Tang S, Yue H, Liu C, Li C and Liang B 2017 Lithium enrichment of high Mg/Li ratio brine by precipitation of magnesium via combined CO₂ mineralization and solvent extraction *Ind. Eng. Chem. Res.* **56** 5668–78
- [242] Pramanik B K, Nghiem L D and Hai F I 2020 Extraction of strategically important elements from brines: constraints and opportunities *Water Res.* **168** 115149
- [243] Kaplan D 1963 Process for the extraction of lithium from Dead Sea solutions *ISR J. Chem.* **1** 115–20
- [244] SEA4VALUE 2023 Novel technologies in seawater desalination plants to extract minerals and metals from seawater brines (available at: <https://sea4value.eu/>) (Accessed 26 February 2023)
- [245] Alpatova A, Verbych S, Bryk M, Nigmatullin R and Hilal N 2004 Ultrafiltration of water containing natural organic matter: heavy metal removing in the hybrid complexation–ultrafiltration process *Sep. Purif. Technol.* **40** 155–62
- [246] Hilal N, Ismail A F and Wright C 2015 *Membrane Fabrication* (CRC Press)
- [247] Seman M A, Khayet M and Hilal N 2011 Development of antifouling properties and performance of nanofiltration membranes modified by interfacial polymerisation *Desalination* **273** 36–47
- [248] Hilal N and Kochkodan V 2003 Surface modified microfiltration membranes with molecularly recognising properties *J. Membr. Sci.* **213** 97–113
- [249] Figueira M, Rodríguez-Jiménez D, López J, Reig M, Cortina J L and Valderrama C 2023 Experimental and economic evaluation of nanofiltration as a pre-treatment for added-value elements recovery from seawater desalination brines *Desalination* **549** 116321
- [250] Bennett N J et al 2019 Towards a sustainable and equitable blue economy *Nat. Sustain.* **2** 991–3
- [251] (Available at: <https://sdgs.un.org/goals>) Accessed

- [252] Czuba K, Bastrzyk A, Rogowska A, Janiak K, Pacyna K, Kosińska N, Kita M, Chrobot P and Podstawczyk D 2021 Towards the circular economy—a pilot-scale membrane technology for the recovery of water and nutrients from secondary effluent *Sci. Total Environ.* **791** 148266
- [253] Parani S and Oluwafemi O S 2021 Membrane distillation: recent configurations, membrane surface engineering, and applications *Membranes* **11** 934
- [254] Mir N and Bicer Y 2021 Integration of electro dialysis with renewable energy sources for sustainable freshwater production: a review *J. Environ. Manage.* **289** 112496
- [255] Drioli E, Criscuoli A and Curcio E 2002 Integrated membrane operations for seawater desalination *Desalination* **147** 77–81
- [256] Wintgens T, Melin T, Schäfer A, Khan S, Muston M, Bixio D and Thoeve C 2005 The role of membrane processes in municipal wastewater reclamation and reuse *Desalination* **178** 1–11
- [257] Malankowska M, Echaide-Gorritz C and Coronas J 2021 Microplastics in marine environment: a review on sources, classification, and potential remediation by membrane technology *Environ. Sci. Water Res. Technol.* **7** 243–58
- [258] Lejarazu-Larrañaga A, Molina S, Ortiz J M, Navarro R and García-Calvo E 2020 Circular economy in membrane technology: using end-of-life reverse osmosis modules for preparation of recycled anion exchange membranes and validation in electro dialysis *J. Membr. Sci.* **593** 117423
- [259] Dharupaneedi S P, Nataraj S K, Nadagouda M, Reddy K R, Shukla S S and Aminabhavi T M 2019 Membrane-based separation of potential emerging pollutants *Sep. Purif. Technol.* **210** 850–66
- [260] Eykens L, De Sitter K, Dotremont C, Pinoy L and Van der Bruggen B 2017 Membrane synthesis for membrane distillation: a review *Sep. Purif. Technol.* **182** 36–51
- [261] Mei Y and Tang C Y 2018 Recent developments and future perspectives of reverse electro dialysis technology: a review *Desalination* **425** 156–74
- [262] Santoro S, Avci A H, Politano A and Curcio E 2022 The advent of thermoplasmonic membrane distillation *Chem. Soc. Rev.* **51** 6087–125
- [263] Esfahani M R et al 2019 Nanocomposite membranes for water separation and purification: fabrication, modification, and applications *Sep. Purif. Technol.* **213** 465–99
- [264] Nunes S P 2020 Can fouling in membranes be ever defeated? *Curr. Opin. Chem. Eng.* **28** 90–95
- [265] Huang H, Schwab K and Jacangelo J G 2009 Pretreatment for low pressure membranes in water treatment: a review *Environ. Sci. Technol.* **43** 3011–9
- [266] Zhao X, Zhang R, Liu Y, He M, Su Y, Gao C and Jiang Z 2018 Antifouling membrane surface construction: chemistry plays a critical role *J. Membr. Sci.* **551** 145–71
- [267] Li X, Mo Y, Li J, Guo W and Ngo H H 2017 In-situ monitoring techniques for membrane fouling and local filtration characteristics in hollow fiber membrane processes: a critical review *J. Membr. Sci.* **528** 187–200
- [268] Lim Y J, Goh K, Kurihara M and Wang R 2021 Seawater desalination by reverse osmosis: current development and future challenges in membrane fabrication—A review *J. Membr. Sci.* **629** 119292
- [269] Tang C Y, Yang Z, Guo H, Wen J J, Nghiem L D and Cornelissen E 2018 Potable water reuse through advanced membrane technology *Environ. Sci. Technol.* **52** 10215–23