

MEETING ABSTRACTS

Open Access

ESICM LIVES 2023



Milan, Italy, 21–25 October 2023

Published: 24 October 2023

Best Abstracts

000265

Antibiotic target failure in neurocritically ill patients: a DOLPHIN trial post-hoc analysis

S. Ergezen¹, T. Ewoldt², B. Koch³, M. van der Jagt², H. E. Endeman²

¹Department of Intensive Care & Neurosurgery, Erasmus MC, Rotterdam, Netherlands; ²Department of Intensive care, Erasmus MC, Rotterdam, Netherlands; ³Department of hospital pharmacy, Erasmus MC, Rotterdam, Netherlands

Correspondence: S. Ergezen

Intensive Care Medicine Experimental 2023, **11(Suppl 1)**:000265

Introduction. Previous studies showed a high prevalence of augmented renal clearance (ARC), based on high creatinine clearance, in neurocritically ill patients and lower serum levels of vancomycin in these patients with ARC (1–3). In this post-hoc analysis of the DOLPHIN trial, we aimed to describe target attainment of beta-lactam antibiotics and fluoroquinolone in neurocritically ill patients and to explore underlying associated variables for differences in target attainment.

Methods. We performed a post-hoc analysis in the neurological ICU patients who were included in the DOLPHIN trial; a multicenter, open-label RCT comparing standard dosing of antibiotics based on local guidelines and model-informed precision dosing (MIPD). In this post-hoc analysis we primarily focused on antibiotic target attainment in neurocritically ill versus non-neurological patients. Secondly, we assessed ARC, defined as a creatinine clearance of ≥ 120 mL/min/1.73 m², and patient characteristics that may influence ARC and target attainment.

Results. In total, data of 51 neurocritically ill patients were available, versus 337 non-neurological patients. Low target attainment was more prevalent among the neurocritically ill patients (Fig. 1), with a significantly higher chance for low target attainment; adjusted OR 2.53 (95% CI 1.29–5.09). Low target attainment was predominantly seen in the early stage after antibiotic initiation. Baseline creatinine clearance was higher in the neurocritically ill patients, with half of these patients reaching levels of ARC; median creatinine clearance neurocritically ill patients 120 mL/min/1.73 m² (IQR 95–136), median

creatinine clearance non-neurological patients 55 mL/min/1.73 m² (IQR 28–89) (Fig. 2). The neurocritically ill patients were significantly younger, however other factors associated with ARC including sex and trauma, did not differ between the neurocritically ill and non-neurological patients.

Conclusions. Target failure for beta-lactam antibiotics and fluoroquinolone is more frequently seen in neurocritically ill patients versus non-neurological patients and is associated with ARC. Therefore, neurocritically ill patients are at risk of suboptimal antibiotic dosing. Further research should assess the impact of adjusted antibiotic dosing, beyond the limits of the current standard dosing regimen, in the neurocritically ill patients.

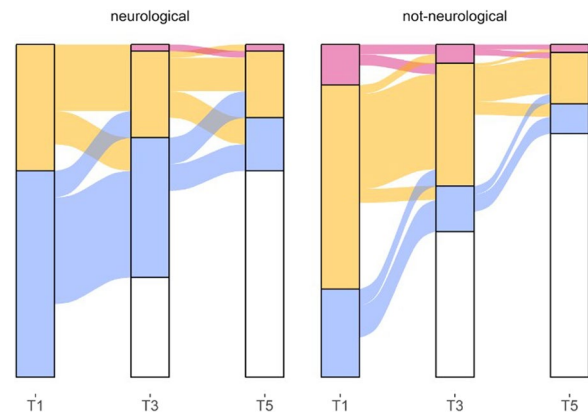

Figure 1 (abstract 000265) Alluvial plot of target attainment over time in the neurocritically ill and the non-neurological patients. T1: first moment of antibiotic sampling, one day after antibiotic initiation; T3: second moment of sampling, 48h after T1; T5: third moment of sampling, 48h after T3. Blue: low target attainment, orange: adequate target attainment, red: high target attainment

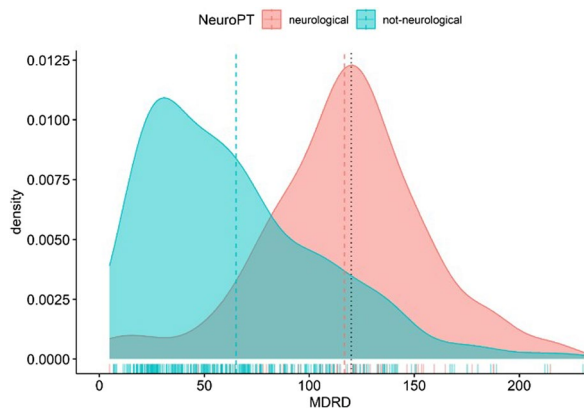

Figure 2 (abstract 000265) Baseline creatinine clearance (mL/min/1.73m²) at randomization in the neurocritically ill patients and the non-neurological patients. MDRD: Modification of Diet in Renal Disease

References

- Hefny F, Stuart A, Kung JY, Mahmoud SH. Prevalence and Risk Factors of Augmented Renal Clearance: A Systematic Review and Meta-Analysis. *Pharmaceutics*. 2022;14(2)
- Chen Y, Liu L, Zhu M. Effect of augmented renal clearance on the therapeutic drug monitoring of vancomycin in patients after neurosurgery. *J Int Med Res*. 2020;48(10):300060520949076
- Morbitzer KA, Rhoney DH, Dehne KA, Jordan JD. Enhanced renal clearance and impact on vancomycin pharmacokinetic parameters in patients with hemorrhagic stroke. *J Intensive Care*. 2019;7:51
- The main DOLPHIN trial has received funding from the Dutch Organization for Health Research and Development ZonMw (Grant 848017008), Stichting de Merel and Erasmus MC MRace Grant.
- The Phd program of S. Ergezen is funded by the Dutch Brain Foundation

Topic: Neurointensive care.

000340

Machine-learning approach for detecting hydrostatic pulmonary oedema in the Emergency Department through haemoglobin changes

F. Gavelli¹, L. M. Castello², X. Monnet³, D. Azzolina⁴, I. Nerici¹, S. Priora¹, V. Giai Via¹, M. Bertoli¹, C. Foieni¹, M. Beltrame¹, M. Bellan², P. P. Sainaghi², N. De Vita², F. Patrucco², J. L. Teboul³, G. C. Avanzi¹

¹Emergency Medicine Department, Università degli Studi del Piemonte Orientale, Novara, Italy; ²Dipartimento di medicina traslazionale, Università degli Studi del Piemonte Orientale 'Amedeo Avogadro', Novara, Italy; ³Service de médecine intensive-réanimation, Hôpital de Bicêtre, Hôpitaux universitaires Paris-Sud, AP-HP, Le Kremlin-Bicêtre, France; ⁴Department of Environmental and Preventive Science, University of Ferrara, Ferrara, Italy

Correspondence: F. Gavelli

Intensive Care Medicine Experimental 2023, **11(Suppl 1)**:000340

Introduction. Acute dyspnoea is one of the leading causes of emergency department (ED) admission. Emergency physicians need to detect the underlying cause and seek prompt treatment. In this context the diagnosis of hydrostatic pulmonary oedema (HPO) is challenging, as symptoms and signs are non-specific and laboratory tools are often costly and present several limitations. The variation of

haemoglobin (Δ Hb) concentration induced by fluid transfer through the interstitium has been proposed in the intensive care unit as a useful method to detect HPO [1]. However, its use in the ED setting still needs to be clarified.

Objectives. To test the ability of Δ Hb at 4 to 8 h from ED presentation to detect HPO, by also developing a machine-learning-based predictive tool for HPO status.

Methods. In this observational retrospective monocentric study, patients admitted to ED for acute dyspnoea were enrolled. Demographic, clinical and laboratory data were collected. Hb values were recorded both at ED presentation (T0) and after 4 to 8 h (T1). Δ Hb between T1 and T0 (Δ HbT1-T0) was calculated as absolute and relative value. Also, we retrieved data regarding radiological investigations and the administered therapy. Two senior investigators, unaware of Hb values, defined a posteriori the cause of dyspnoea as HPO and non-HPO. The ability of Δ HbT1-T0 to detect HPO was evaluated through a receiver operating characteristic (ROC) method. A machine learning approach was adopted to develop a predictive tool for HPO, by considering as covariate the ability of Δ Hb together with the baseline patient characteristics. Different algorithms were used to train the model, in 100bootstrap runs. The leading performing algorithm according to the predictive ROC criteria was used to develop the final model. The predictive tool is available in a Shiny web application (Fig. 1).

Results. 706 dyspnoeic patients (203 HPO and 503 non-HPO) were enrolled over 19 months. Hb levels were significantly different between HPO and non-HPO patients both at T0 and T1 ($p < 0.001$). Δ HbT1-T0 were more pronounced in HPO patients than non-HPO patients, both as relative (-8.2 [-11.2 to -5.6] vs. 0.6 [-2.1 to 3.3]%) and absolute (-1.0 [-1.4 to -0.8] vs. 0.1 [-0.3 to 0.4] g/dL) values ($p < 0.001$). A relative Δ HbT1-T0 of -4.6% detected HPO with an area under the ROC curve (AUROC) of 0.901 [0.896 – 0.906] (Sensitivity 83%, Specificity 90%). Among the considered models, Gradient Boosting Machine showed excellent predictive ability in identifying HPO patients (AUROC 0.916 [0.907 – 0.928]). According to the mean decrease in accuracy as a measure of importance, Δ HbT1-T0 was confirmed as the most important covariate for HPO prediction.

Conclusions. The developed machine learning predictive tool represents a performing and clinically handy tool for predicting HPO. Moreover, Δ Hb in patients admitted for acute dyspnoea reliably identifies HPO in the ED setting.

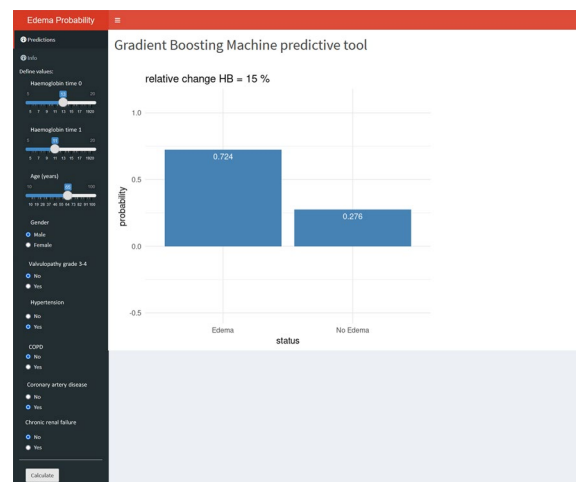

Figure 1 (abstract 000340) Gradient boosting machine predictive tool—example of functioning

References

1. Anguel N, Monnet X, Osman D, et al. (2008) Increase in plasma protein concentration for diagnosing weaning-induced pulmonary oedema. *Intensive Care Med* 34:1231–1238. <https://doi.org/10.1007/s00134-008-1038-3>
2. Not applicable.

Topic: Cardiovascular issues in ICU.

000380

Long term brain structural correlates of cognitive outcome in survivors of Covid-19 related ARDS (C-ARDS)

E. Baruzzo¹, L. Zigiottò², L. Vavassori³, F. Moro⁴, D. Ottaviani⁵, S. Lassola⁶, A. Sanna⁶, S. Miori⁶, U. Rozzanigo⁷, K. Zimmerman⁸, S. Sarubbo², G. Bellani⁹, S. Magnoni⁶

¹CeRiN, Center for Neurocognitive Rehabilitation, Trento, Italy; ²Neurosurgery, Santa Chiara Hospital, Trento, Italy; ³Center for Mind/Brain Sciences (CIMeC), University of Trento, Mattarello, Italy; ⁴Department of Acute Brain Injury, Mario Negri Institute for Pharmacological Research, Milano, Italy; ⁵Neurology, S.Maria del Carmine Hospital, Rovereto, Italy; ⁶Anesthesia and Intensive Care, Santa Chiara Hospital, Trento, Italy; ⁷Radiology, Santa Chiara Hospital, Trento, Italy; ⁸UK Dementia Research Institute, Care Research & Technology Centre, Imperial College London, London, United Kingdom; ⁹Anesthesia and Intensive Care, Centre for Medical Sciences-CISMed, University of Trento, Trento, Italy

Correspondence: S. Magnoni

Intensive Care Medicine Experimental 2023, **11(Suppl 1)**:000380

Introduction. Patients with Covid-19 related ARDS (C-ARDS) suffer from neurological and neuropsychological long-term consequences which are likely to involve disruption to the micro-structural and functional brain integrity. The mechanisms may be related to the specific neurotrophic potential of SARS-CoV-2 infection and brain injury caused by vascular damage or hypoxia.

Objectives. Determine long-term neurological and neuropsychological function and its correlation to advanced brain imaging in a cohort of C-ARDS survivors with a high rate of impaired quality of life at follow-up.

Methods. A previously described cohort of 79 C-ARDS survivors was screened for this prospective study. Brain MRI with conventional and diffusion tensor imaging (DTI) was acquired 12 months after hospital discharge in a subgroup of 24 C-ARDS patients. Regional and whole fractional anisotropy (FA) and mean diffusivity (MD) values were quantified on DTI images and analyzed vs 15 non-COVID-19 healthy controls using TBSS and tractography (Fig. 1).

The patients underwent a detailed neurological assessment and a whole battery of neuropsychological tests for memory, language, visual perception, executive function. Neuropsychiatric symptoms (anxiety, depression, and PTSD) were also explored administering questionnaires to the caregivers (Neuropsychiatric Inventory-NPI and the Frontal Behavioral Inventory-FBI). Spearman rank-correlation test was used to test for associations between variables and Mann Whitney for comparisons between groups.

Results. Participants were 24 C-ARDS patients (83.3% males; mean age 59.46 ± 8.85), with prolonged ICU and hospital stay (22 ± 11 and 41 ± 14 days, respectively) and long-term impairment in the

quality of life (SF-36 physical and mental summary scores below normal in 42% and 29% of the subjects, respectively). The most frequent long-term neurological symptoms were peripheral motor deficits (62%), sleep disorders (29%) and hypogeusia and hyposmia (20%).

Neuropsychological assessment showed long-term cognitive impairment in 10/24 subjects (41.7%), with deficits at verbal short-term memory test (12.5%) and screening for executive functions deficit (20.8%). Disorders in the emotional role were found in 8/24 patients (27%), including PTSD syndrome (50%), anxious symptoms (25%) and depression (25%).

The results of questionnaires to the caregivers (NPI) showed a large presence of irritability and anxiety, followed by agitation and depression.

Brain imaging analysis showed significantly lower MD values in patients compared to healthy controls in the whole white matter skeleton ($p < 0.05$) and in the genu and splenium of the corpus callosum ($p < 0.01$). Significantly lower FA values were also found in the genu, body and splenium of the corpus callosum ($p < 0.05$), but not in the whole white matter skeleton.

We also correlated the FA and MD values in IFOF and FAT tracts with the results of the neuropsychological tests. We found significant negative correlation between verbal short-term memory and MD in the right IFOF ($r_s = -0.474$, $p = 0.042$), and between PTSD symptoms ($r_s = -0.702$, $p = 0.002$) and total score at FBI questionnaire ($r_s = -0.484$, $p = 0.049$) and MD in the left FAT tract. Positive correlation was found between anxiety ($r_s = 0.487$, $p = 0.035$), PTSD ($r_s = 0.512$, $p = 0.036$) and FBI total score ($r_s = 0.552$, $p = 0.022$) and FA in the right FAT tract.

Conclusions. The present study shows disruption of the white matter integrity in brain regions involved in cognitive domains and behavior. Changes in the brain structural properties correlate with reduction in short-term memory, frontal-behavioral changes and high levels of anxiety and PTSD. These findings suggest long-term cerebral consequences specific to SARS-CoV-2 infection and/or secondary to brain damage. Future studies in ARDS and other critically ill patients should carefully investigate the associations between long-term neuropsychological and mental health problems and brain microstructural integrity using DTI MRI.

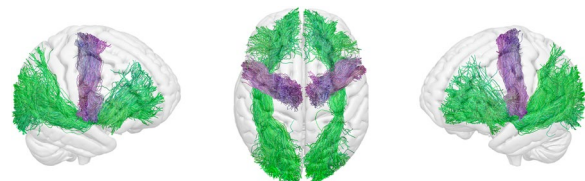

Figure 1 (abstract 000380) The inferior fronto occipital fasciculus (IFOF) in "green" and the frontal aslant tract (FAT) in "violet". These tracts were segmented in C-ARDS survivors using a whole-brain probabilistic constrained spherical deconvolution (CSD) tractography using an in-house processing pipeline and FA (fractional anisotropy) and MD (mean diffusivity) were calculated for each bundle to assess their microstructural properties

References

1. Umbrello M, Miori S, Sanna A, Lassola S, Baruzzo E, Penzo D, et al. High rates of impaired quality of life and social and economic problems at 6 months after COVID-19-related ARDS. *J Anesthesia Analgesia Critical Care.* 2022;2:20.
2. Mikkelsen ME, Christie JD, Lanken PN, Biester RC, Thompson BT, Bellamy SL, et al. The Adult Respiratory Distress Syndrome Cognitive Outcomes Study. *Am J Resp Crit Care.* 2012;185:1307–15.
3. Newcombe VFJ, Spindler LRB, Das T, Winzeck S, Allinson K, Stamatakis EA, et al. Neuroanatomical substrates of generalized brain dysfunction in COVID-19. *Intensive Care Medicine.* 2021;47:116–8.
4. Becker JH, Lin JJ, Doernberg M, et al. Assessment of Cognitive Function in Patients After COVID-19 Infection. *Jama Netw Open.* 2021;4(10):e2130645.

Topic: Neurointensive care.

000612

Utility of tracheal pressure to estimate the muscle pressure index

G. Guidetti¹, J. F. Martínez Carmona¹, C. Joya Montosa¹, M. Mora Moreno¹, A. Rodríguez Carmona², J. M. Serrano Simón³

¹Intensive Care Unit, Hospital Regional Universitario de Málaga, Málaga, Spain; ²Intensive Care Unit, Hospital El Carmen, Mendoza, Argentina; ³Intensive Care Unit, Hospital Regional Universitario Reina Sofía, Córdoba, Spain

Correspondence: J.M. Serrano Simón

Intensive Care Medicine Experimental 2023, **11(Suppl 1)**:000612

Introduction. During Pressure support ventilation (PSV), the difference between Pplateau and Ppeak in airway pressure (Paw), at a stable inspiratory hold, is the conventional method to obtain the muscle pressure index (PMI). However, the absence of inspiratory resistance in the tracheal pressure signal (Ptrach) and its relationship with alveolar and pleural pressure could more accurately estimate PMI.

Objectives. To evaluate the PMI with both signals (Ptrach vs. Paw) about inspiratory effort parameters.

Methods. Analysis of prospective collected data of 10 patients, admitted to the polyvalent ICU of a tertiary hospital (37 beds), from March to May 2020. Patients with hypoxemic acute respiratory failure of different causes were included during the weaning period, receiving pressure support ventilation (PSV), with 3 levels of assistance (baseline setting ± 5 cmH2O). Respiratory signals of Flow, Paw, Ptrach, and esophageal pressure (Pes) were registered at 1045 Hz, for 60 min. Ptrach was measured using a specific dedicated intratracheal catheter. Measurements: Drive and Effort parameters: P0.1, PTP/min, Delta Pes. Respiratory mechanics were calculated: Elastance (Ers) by holds, and resistances (Rrs) by the time constant. PMI was obtained through the signal of Paw and Ptrach for each level of assistance. Three inspiratory and expiratory holds were performed at each level of support, separated by 1 min. For analysis, 90 data were obtained, 30 at each level of PSV. A correlation between the effort parameters and the PMI calculated with both signals was performed.

Results. Characteristics of patients. Age 64 ± 11 years. Males 68%. Days MV 7 (4.15–9.12). PaO2/FiO2 188.21 ± 42.32 . Diagnoses (N): Pneumonia-COVID 3. Postoperative Abdominal 2. Lung transplant 2. Trauma 3. Baseline PSV 10 ± 2.3 , Peep 5.5 ± 2.2 cmH2O. Ers: 24.14 ± 5.3 cmH2O/L. Rrs 11.15 ± 7.3 cmH2O/l/s. For any level of assistance, the correlation of the effort parameters was better between PMI for Ptrach than Paw (Fig. 1). The most relevant data on the methods and results of the respiratory components are shown in Figs. 2, 3.

Conclusions. The tracheal pressure signal allows the calculation of the muscle pressure index with higher precision than the airway pressure, for all and the different levels of assistance during PSV. Ptrach reflects elastic components and could be considered an alternative to Pes.

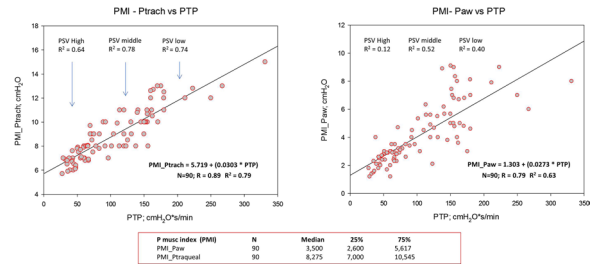

Figure 1 (abstract 000612) Correlation between muscle pressure index (PMI) and effort by Ptrach and Paw

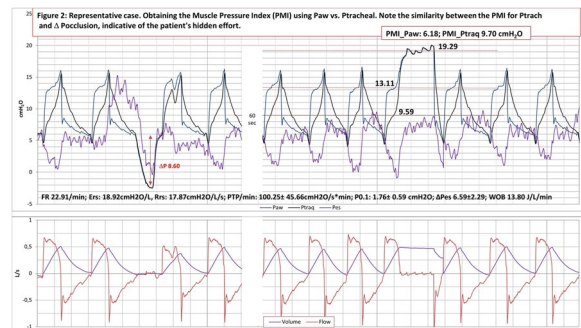

Figure 2 (abstract 000612) Representative case. PMI obtained by Ptrach and Paw

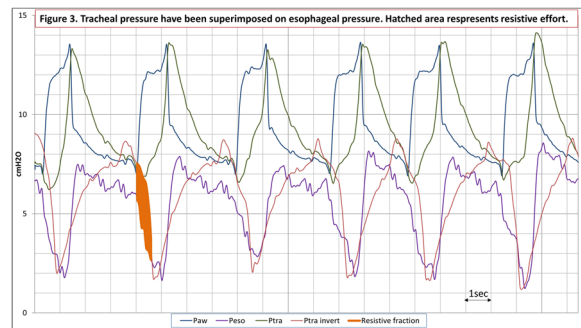

Figure 3 (abstract 000612) Pressure tracings during PSV. Note inverted tracheal pressure superimposed on esophageal pressure. The shaded area theoretically represents the fraction of effort corresponding to the resistive component

Topic: Acute respiratory failure and mechanical ventilation.

000709

Enhancing early rehabilitation across two adult critical care units

A. Makower-Jones¹, D. Glenn¹, D. Barghouthy¹, D. McWilliams²
¹Physiotherapy Dept, University Hospital Coventry & Warwickshire, Coventry, United Kingdom; ²Centre for care excellence, University Hospital Coventry & Warwickshire, Coventry, United Kingdom

Correspondence: A. Makower-Jones

Intensive Care Medicine Experimental 2023, **11(Suppl 1)**:000709

Introduction. Patients admitted to critical care and requiring invasive mechanical ventilation (IMV) often require prolonged sedation and associated immobility [1]. This in turn leads to increased length of stay (LOS) on both critical care and hospital wards and patients are at risk of long term physical and non-physical morbidity [2]. The delivery of early and structured rehabilitation has been demonstrated to improve patient outcomes, although consistency of delivering this is often challenging [3, 4].

University Hospitals of Coventry & Warwickshire NHS Trust (UHCW) had a dedicated critical illness rehabilitation team (CIRT) to provide rehabilitation to support the transition from critical care to the wards, with limited involvement prior to intensive care unit (ICU) discharge.

Recent investment enhanced CIRT with an aim to enable earlier involvement, aiming to provide more consistent rehabilitation delivery within ICU and improvement of mobility levels prior to discharge to the ward.

Objectives. To evaluate the impact of increased investment in the critical illness rehabilitation team on length of stay and mobility levels at ICU discharge.

Methods. This project was conducted across two adult ICUs in a large university hospital in the United Kingdom. Patients were eligible for inclusion if they were ventilated for ≥ 4 days, not on an existing specialist rehabilitation pathway (e.g. major trauma or neurological pathways), and survived to ICU discharge. ICU LOS and mobility data (using the Manchester Mobility Score) were collected prospectively between Dec 2022-March 2023 and compared to historical baseline data collected retrospectively for the same period in the previous year.

Patients who met the criteria for inclusion underwent a comprehensive assessment to develop an individualised plan for treatment, including goal setting and the implementation of early, structured rehabilitation. This process was supported by education to the multidisciplinary team (MDT), introduction of safety resources, development of an MDT rehabilitation steering group, and additional investment for specialist seating.

Results. Forty-seven patients met the inclusion criteria and were seen by CIRT during the trial period and were compared to 29 patients in the baseline period. The enhancement of CIRT was associated with a significant increase in the number of patients mobilised within ICU (98% vs 71%, $P < 0.001$), higher levels of mobility at the point of ICU discharge (median MMS 5 vs 2, $P < 0.001$), and a significant reduction in ICU LOS (mean 16.7 vs 23.7 days, $P < 0.05$).

Conclusions. Enhancement of CIRT enabled timely, structured and specialist rehabilitation for patients admitted to ICU and ventilated for ≥ 4 days. This increased involvement was associated with reduced ICU LOS and improved mobility levels at ICU discharge.

References

1. Pedro A Mendez-Tellez, Dale M Needham, (2012) Early Physical Rehabilitation in the ICU and Ventilator Liberation, *Respiratory Care*, 57 (10) 1663–1669; <https://doi.org/10.4187/respcare.01931>
2. Fernando, S.M., Mclsaac, D.I., Rochweg, B. et al. (2019) Frailty and invasive mechanical ventilation: association with outcomes, extubation failure, and tracheostomy. *Intensive Care Med* 45, 1742–1752. <https://doi.org/10.1007/s00134-019-05795-8>
3. D.J. McWilliams, E.V. Westlake. (2011) Structured rehabilitation for patients admitted to critical care. *Intensive Care Med*, 37, p. S270
4. P. Nydahl, A. Parker-Ruhl, G. Bartoszek, R. Dubb, S. Filipovic, H.J. Flohr, et al. (2014) Early mobilization of mechanically ventilated patients: a 1-day point prevalence stud in Germany *Crit Care Med*, 42, pp. 1178–1186
5. Not applicable.

Topic: Nursing care and physiotherapy.

000714

Starting with recognition: using education to improve CAMICU assessment in a District General Hospital's Intensive Care Unit

M. Salamanca¹, A. White¹, C. Coyle²

¹Newham University Hospital, Barts Health NHS Trust, London, United Kingdom; ²Royal London Hospital, Barts Health NHS Trust, London, United Kingdom

Correspondence: M. Salamanca

Introduction. Delirium is common in the Intensive Care Unit (ICU); studies suggest it can affect up to 89% of ICU. Delirium in the critically ill is associated with increased mortality, increased length of stay and nursing home placements.

The CAM-ICU (Confusion Assessment Method for Intensive Care Unit) is a well-recognised scoring system which is proven to be superior to previously recommended assessment tools for detecting delirium in ICU.

We decided to form a multidisciplinary team at our adult general ICU to systematically assess and improve upon our collective approach to delirium prevention and management. As a consequence, we recognised that our patients were not being regularly assessed for delirium. We present an ongoing process to improve the usage of the CAM-ICU assessment.

Objectives. To evaluate whether a multi-faceted approach implemented by a newly established multidisciplinary taskforce would improve frequency of CAM-ICU assessments.

Methods. We recruited doctors, nurses, physiotherapy and occupational therapists to create a multidisciplinary task force to address delirium prevention and management comprehensively. We identified a lack of understanding of the purpose of the CAM-ICU assessments and how to carry them out.

We provided in-person tutorials to doctors, nurses and allied health-care professionals regularly working in our unit; these focused on the impact of ICU delirium, the benefits of the regular CAM-ICU assessment and how to use it. We agreed that all eligible ICU patients should have a CAM-ICU assessment documented each day.

We retrospectively measured how many patients had a daily CAM-ICU assessment one week before and one week after the staged intervention.

Results. Prior to the educational intervention, in a week there were 11 to 14 patients on the unit each day. This created 92 patient days where we believed the patient should have a CAM-ICU assessment. No CAM-ICU assessments were documented. During a week after the intervention there were documented CAM-ICU assessments for 16/75 patient days. Rate of CAM-ICU assessments per patient day therefore improved from 0% to 21.3%.

Conclusions. Our educational intervention has significantly improved the departments frequency of documented CAM-ICU assessments and therefore recognition of delirium. However, there is still much improvement to be had. The creation of a multidisciplinary taskforce is allowing us to rapidly provide more interventions to iteratively meet our objective. The formation of the taskforce is allowing multiple other interventions to run in parallel to improve delirium prevention and management; this includes extending visitor hours, supporting family involvement, reorientation boards and promoting sleep hygiene.

References

1. Chen, T-J. et al. Diagnostic accuracy of the CAM-ICU score and ICDS-C in detecting intensive care unit delirium: A bivariate meta-analysis. *Int J Nurs Stud.* 2021;113:103782. <https://doi.org/10.1016/j.ijnurstu.2020.103782>
2. Koftis K, Marra A, Ely EW. ICU delirium- a diagnostic and therapeutic challenge in the intensive care unit. *Anaesthesiol Intensive Ther.* 2018;50(2):160–167. <https://doi.org/10.5603/AIT.a2018.0011>
3. Cavallazzi, R, Saad M, Marik PE. Delirium in the ICU- an overview. *Ann. Intensive Care.* 2012;2(49). <https://doi.org/10.1186/2110-5820-2-49>
4. N/A

Topic: Sedation, analgesia and delirium

000798

Virtual Reality pre-operative immersive experience to improve patient's ICU experience and reduce post-operative delirium incidence

R. Anderson¹, P. Bauer¹, A. Arghami², R. Haney², K. Baalson³, E. Reisdorf³
¹Pulmonary/Critical Care, Mayo Clinic, Rochester, United States of America; ²Cardiovascular Surgery, Mayo Clinic, Rochester, United States of America; ³Critical Care, Mayo Clinic, Rochester, United States of America

Correspondence: R. Anderson

Intensive Care Medicine Experimental 2023, **11(Suppl 1)**:000798

Introduction. Delirium in the intensive care unit (ICU) is frequent, especially in the cardiothoracic surgical population, affecting up to 87% of patients. Negative sequelae include increased morbidity, ventilation time, extended hospital stay, poorer discharge outcomes and increased 6-month mortality rate. Diagnosis and management of delirium is challenging. Therefore, at risk patient identification and prevention strategies are crucial.

Pre-procedural education via audio/video experiences and facility tours have been shown to improve outcomes. Presenting such education in an immersive virtual reality (VR) format has yet to be thoroughly evaluated.

Objectives. The purpose of this study was to evaluate a multi-sensory VR educational program for patients undergoing elective

cardiothoracic surgery with planned post-operative ICU admission. The impact on the patient's overall ICU experience and post-operative delirium rates were measured.

Methods. A multidisciplinary research team of clinicians and education/simulation experts developed a novel VR simulation session to expose patients pre-operatively to planned/expected post-operative ICU experience. Educational objectives included patient safety, family presence, ICU machinery/activities, reorientation, and communication with the care team.

Baseline patients underwent medical record review and were surveyed retrospectively on their ICU admission. VR simulation patients were surveyed at a pre-operative clinic visit on their expectations of their upcoming ICU admission. They viewed the 10-min simulation via VR headset. Following, they were surveyed. Patients underwent standard of care peri and post-procedurally. After ICU discharge, a survey was performed. We hypothesized improved patient experiences and reduced delirium rates in the VR group as compared to the baseline group.

Results. A total of 138 patients were included: 94 baseline, 44 VR. Delirium incidence trended lower in the VR group (n = 1) versus baseline (n = 4; p = 0.911). Reductions in antipsychotic medication administration (Baseline, n = 16; VR n = 1), mechanical ventilator time (p = 0.008), and post-operative sedation were observed (p = 0.016) despite overall longer cardiopulmonary bypass time for the VR patients (p = 0.002). VR patients (92%) described the simulation as helpful to alleviate anxiety and provide an understanding of what they could expect in the ICU. VR patients stated: "Give this to everybody about to have an operation!", "It prepared me in a way nothing else could have". VR patients experienced greater feelings of safety in the ICU and "fear of the unknown" was significantly ameliorated.

Conclusions. Pre-operative VR simulation can improve the experience and outcomes of patients undergoing elective cardiothoracic surgery recovering in the ICU. All patients undergoing a medical procedure benefit from pre-procedural education. VR simulation is a multi-sensory modality to provide that education in an immersive and effective manner.



Figure 1 (abstract 000798)



Figure 2 (abstract 000798)



Figure 5 (abstract 000798)



Figure 3 (abstract 000798)



Figure 6 (abstract 000798)



Figure 4 (abstract 000798)



Figure 7 (abstract 000798)

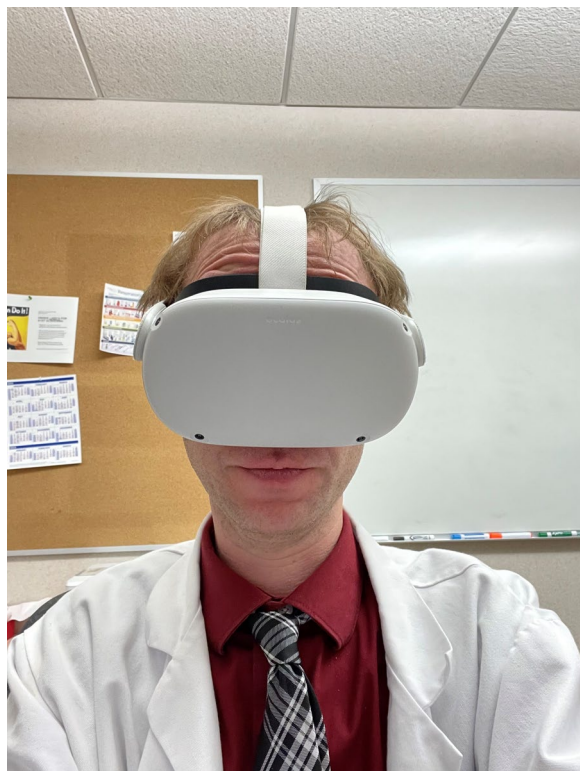

Figure 8 (abstract 000798)

References

- Hounsoms, J., Lee, A., Greenhalgh, J. et al. (2017). A systematic review of information format and timing before scheduled adult surgery for peri-operative anxiety. *Anaesthesia*, 72(10):1265–1272. <https://doi.org/10.1111/anae.14018>.
- Chevillon, C., Hellyar, M., Madani, C. et al. (2015). Preoperative education on postoperative delirium, anxiety, and knowledge in pulmonary thromboendarterectomy patients. *American J of Critical Care*, 24(2):164–71. <https://doi.org/10.4037/ajcc2015658>.
- Mayo Clinic Critical Care Research Subcommittee
- Ryu, J., Oh, A., Yoo, H., et al. (2018). The effect of an immersive virtual reality tour of the operating theater on emergence delirium in children undergoing general anesthesia: a randomized controlled trial. *Paediatric Anaesthesia*, <https://doi.org/10.1111/pan.13535>.
- Zhong, Q., Qu, X., Xu, C. (2018). Effect of preoperative visiting operating room on emergence agitation in preschool children under sevoflurane anesthesia. *International J of Pediatric Otorhinolaryngology*, 104:32–35. <https://doi.org/10.1016/j.ijporl.2017.10.038>.
- Society of Critical Care Medicine. (2018). 2018 clinical practice guidelines for the prevention and management of pain, agitation/sedation, delirium, immobility, and sleep disruption in adult patients in the ICU. Retrieved from <http://www.sccm.org/ICULiberation/guidelines>.
- Shrivani, F., Naji, S., Davari, E., Sedighi, M. (2020). Early mobilization reduced delirium after coronary artery bypass graft surgery. *Asian Cardiovascular and Thoracic Annals*, 28(9).
- Lynn-McHale, D., Corsetti, A., Brady-Avis, E. et al. (1997). Preoperative ICU tours: are they helpful? *American J of Critical Care*, 6(2):106–15.
- Habeeb-Allah, A., Alshraideh, J. (2021). Delirium post-cardiac surgery: Incidence and associated factors. *Nursing in Critical Care*, 26(3).
- Chen (2021). Risk factors of postoperative delirium after cardiac surgery: a meta analysis. *J Cardiothoracic Surgery*, 16(113).

Topic: Perioperative care.

001163

Predictive value of the EEG after cardiac arrest: validation of the ERC-ESICM recommendations

S. Turella¹, J. Dankiewicz², N. D. Nielsen³, C. Sandroni¹, T. Cronberg⁴, E. Westhall⁵

¹Department of Anesthesiology and Intensive Care Medicine, Università Cattolica del Sacro Cuore, Roma, Italy; ²Department of clinical sciences Lund, Cardiology, Lund University, Lund, Sweden; ³Department of clinical sciences Lund, Anesthesiology and Intensive Care Medicine, Helsingborg Hospital, Helsingborg, Sweden; ⁴Department of clinical sciences Lund, Neurology, Lund University, Lund, Sweden; ⁵Department of clinical sciences Lund, Clinical neurophysiology, Lund University, Lund, Sweden

Correspondence: S. Turella.

Intensive Care Medicine Experimental 2023, **11(Suppl 1)**:001163

Introduction. The current ERC-ESICM guidelines updated the EEG strategy for prognostication after cardiac arrest (CA) compared to the 2015 recommendations [1,2]. The new algorithm proposes the so-called *highly malignant* EEG patterns which include suppression or burst-suppression with or without discharges (see Figure) [3,4] and are defined according to the standardized EEG terminology by the American clinical neurophysiology society (ACNS) [5].

Objectives. To validate the predictive value of highly malignant EEG patterns in the latest ERC-ESICM guidelines for post-resuscitation care. Secondary aims were to investigate if hypothermia treatment or sedation impact EEG as a prognostic tool and whether unreactive EEG background increases prognostic performance.

Methods. Prospective observational multi-center sub-study of the Target Temperature Management trial 2 (TTM2 trial), that randomised comatose patients after CA to 33°C versus early treatment of fever (37.8 °C) [6]. EEG was mandatory in all patients still comatose between 48 and 96 h after cardiac arrest. Sedation was mandatory during the temperature intervention and kept as low as possible afterwards. We assessed the first EEG performed beyond 24 h after CA using the ACNS terminology. Presence of highly malignant EEG patterns and EEG background reactivity was prospectively reported by the trial sites. Poor neurological outcome at 6 months was defined as a modified Rankin Scale score of 4–6.

Results. 845 patients at 59 trial sites had an EEG beyond 24 h after CA and were included in the study. EEGs were recorded at a median of 71 h after CA. Highly malignant EEG had 50% (CI 46–54%) sensitivity and 93% (CI 90–96%) specificity to predict poor outcome. Specificity was similar across patients in the two temperature groups

($p = 0.149$) and with or without ongoing sedation ($p = 1.000$). Specificity improved to 97% (CI 94–99%; $p = 0.008$) using the combination of a highly malignant and unreactive EEG while sensitivity decreased to 46% (CI 42–50%; $p \leq 0.001$).

Conclusions. The highly malignant EEG patterns recommended in the ERC-ESICM 2021 guidelines accurately predict poor outcome after CA, but not without false positives. However, the combination with an unreactive EEG background significantly improves specificity. The prognostic ability of EEG is not affected by temperature levels or ongoing sedation in clinically used doses.

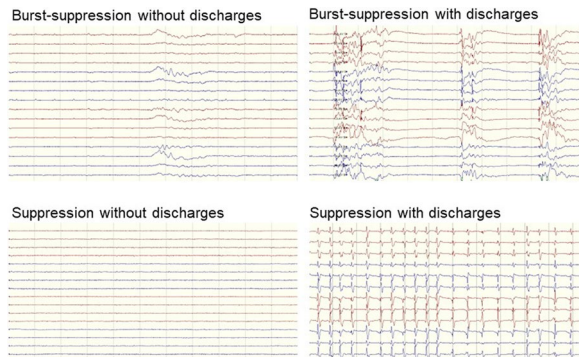

Figure (abstract 001163) Highly malignant EEG patterns

References

- [1] Nolan JP, Sandroni C, Bottiger BW, Cariou A, Cronberg T, Friberg H, Genbrugge C, Haywood K, Lilja G, Moolaert VRM, Nikolaou N, Olasveengen TM, Skrifvars MB, Taccone F, Soar J (2021) European Resuscitation Council and European Society of Intensive Care Medicine guidelines 2021: postresuscitation care. *Intensive Care Med* 47:369–4.
- [2] Nolan JP, Soar J, Cariou A, Cronberg T, Moolaert VR, Deakin CD, Bottiger BW, Friberg H, Sunde K, Sandroni C, European Resuscitation C, European Society of Intensive Care M (2015) European Resuscitation Council and European Society of Intensive Care Medicine 2015 guidelines for post-resuscitation care. *Intensive Care Med* 41:2039–2056. <https://doi.org/10.1007/s00134-015-4051-3>.
- [3] Westhall E, Rossetti AO, van Rootselaar AF, Wesenberg Kjaer T, Horn J, Ullen S, Friberg H, Nielsen N, Rosen I, Aneman A, Erlinge D, Gasche Y, Hassager C, Hovdenes J, Kjaergaard J, Kuiper M, Pellis T, Stammet P, Wanscher M, Wetterslev J, Wise MP, Cronberg T (2016) Standardized EEG interpretation accurately predicts prognosis after cardiac arrest. *Neurology* 86:1482–1490. <https://doi.org/10.1212/wnl.0000000000002462>
- [4] Sandroni C, D'Arrigo S, Cacciola S, Hoedemaekers CWE, Kamps MJA, Oddo M, Taccone FS, Di Rocco A, Meijer FJA, Westhall E, Antonelli M, Soar J, Nolan JP, Cronberg T Prediction of poor neurological outcome in comatose survivors of cardiac arrest: a systematic review. *Intensive Care Med* (2020) 46:1803–1851 <https://doi.org/10.1007/s00134-020-06198-w>.
- [5] Hirsch LJ, Fong MWK, Leitinger M, LaRoche SM, Beniczky S, Abend NS, Lee JW, Wusthof CJ, Hahn CD, Westover MB, Gerard EE, Herman ST, Haider HA, Osman G, Rodriguez-Ruiz A, Maciel CB, Gilmore EJ, Fernandez A, Rosenthal ES, Claassen J, Husain AM, Yoo JY, So EL, Kaplan PW, Nuwer MR, van Putten M, Sutter R, Drislane FW, Trinka E, Gaspard N (2021) American Clinical Neurophysiology Society's standardized critical care EEG terminology: 2021 version. *J Clin Neurophysiol* 38:1–29.
- [6] Dankiewicz J, Cronberg T, Lilja G, Jakobsen JC, Levin H, Ullén S, Rylander C, Wise MP, Oddo M, Cariou A, Bělohávek J, Hovdenes J, Saxena M, Kirkegaard H, Young PJ, Pelosi P, Storm C, Taccone FS, Joannidis M, Callaway C, Eastwood GM, Morgan MPG, Nordberg P, Erlinge D, Nichol AD, Chew MS, Hollenberg J, Thomas M, Bewley J, Sweet K, Grejs AM, Christensen S, Haenggi M, Levis A, Lundin A, Düring J, Schmidbauer S, Keeble TR, Karamasis GV, Schrag C, Faessler E, Smid O, Otáhal M, Maggiorini M, Wendel Garcia PD, Jaubert P, Cole JM, Solar M, Borgquist O, Leithner C, Abed-Maillard S, Navarra L, Annborn M, Undén J, Brunetti I, Awad A, McGuigan P, Bjørkholm Olsen R, Cassina T, Vignon P, Langeland H, Lange T, Friberg H, Nielsen N (2021) Hypothermia versus normothermia after out-of-hospital cardiac arrest. *N Engl J Med* 384:2283–2294
- Supported by independent research grants from nonprofit or governmental agencies and by governmental funding of clinical research within the Swedish National Health Service.

Topic: Cardiac arrest.

001357

Red blood cell transfusion in the intensive care unit: the InPUT-study, a Worldwide Prospective Cohort Study on Transfusion Practices

J. Raasveld¹, S. de Bruin², M. Reuland¹, C. Van Den Oord¹, J. Schenk³, C. Aubron⁴, J. Bakker⁵, M. Cecconi⁶, A. Feldheiser⁷, J. Meier⁸, M. C. A. Müller⁹, T. Scheeren¹⁰, Z. Mcquillen¹¹, H. J. De grooth¹², A. P. J. Vlaar²

¹Intensive Care, Amsterdam UMC, locatie AMC, Amsterdam, Netherlands; ²Department of intensive care medicine, Academic Medical Centre, Amsterdam, Netherlands; ³Anesthesiology, Amsterdam UMC, locatie AMC, Amsterdam, Netherlands; ⁴Médecine Intensive Réanimation, Université de Bretagne Occidentale, Brest, France; ⁵Department of intensive Care Adults, Erasmus University Medical Center, Rotterdam, Netherlands; ⁶Anesthesia and intensive care, Humanitas Research Hospital, Milan, Italy; ⁷Department of anaesthesiology and operative intensive care medicine (ccm, cvk); department of an, Charité-Universitätsmedizin Berlin; Evang. Kliniken Essen-Mitte, Essen, Germany; ⁸Department of Anesthesiology and Intensive Care, Kepler University Clinic, Linz, Austria; ⁹Department of Critical Care, Amsterdam UMC, locatie AMC, Amsterdam, Netherlands; ¹⁰Department of anaesthesiology, University Medical Centre Groningen, Groningen, Netherlands; ¹¹School of Public Health and Preventive Medicine, Monash University Clayton Campus, Clayton, Australia; ¹²Intensive care adults, Amsterdam UMC, locatie VUmc, Amsterdam, Netherlands

Correspondence: J. Raasveld

Intensive Care Medicine Experimental 2023, **11(Suppl 1)**:001357

Introduction. Red blood cell (RBC) transfusion is common in patients admitted to the intensive care unit (ICU). Multiple randomized controlled trials (RCTs) have shown a more restrictive hemoglobin (Hb) threshold for RBC transfusion is safe. Whether these have been incorporated in current clinical practice is unknown. Therefore, current insight into current transfusion behavior in ICUs worldwide could facilitate the optimization of transfusion care.

Objectives. To evaluate real-world RBC transfusion practices worldwide.

Methods. The InPUT study was an international prospective cohort study, performed in 233 ICUs worldwide in 30 countries. Data were collected in prescheduled weeks between March-2019 and October-2022. All newly admitted adult patients admitted to the ICU were eligible. Patients were excluded if they did not consent for the use of data or in case the data did not fulfill quality standards. The main outcome was the incidence of RBC transfusion during ICU stay. Also, the reasons and triggers for RBC transfusion, Hb thresholds for RBC transfusion and the center-dependent probability of receiving an RBC transfusion were assessed.

Results. Out of 3,908 potentially eligible patients, 3,643 were included. A total of 894 patients (25%) received one or more RBC transfusions during their ICU stay, with a median of 4 (1st-3rd quartile 2–7) units per transfused patient. In the 1,727 RBC transfusions administered, mostly stated clinical reasons for RBC transfusion were low Hb value (N=1,412; 82%) and hemodynamic instability (N=406; 24%). Mostly stated physiological triggers were no trigger at all (N=682; 40%), hypotension (N=728; 42%) and tachycardia (N=474; 27%). Median Hb threshold stated by the centers for RBC transfusion was 8 g/dL (1st–3rd quartile 7–9 g/dL). However, after correcting for individual-patient characteristics, centers differed significantly in their propensity to transfuse patients with a Hb of 8 g/dL (range 7–92% probability, 95% prediction interval 13–79%).

Conclusions. Despite robust literature and guidelines leaning towards more restrictive transfusion of RBC, this is only partly reflected in daily practice. RBC transfusion in the ICU remains common, and there is significant unexplained variance in transfusion behavior between centers.

References

1. This study was endorsed by the European Society of Intensive Care Medicine (ESICM). No funding was received for the design and analyses of this study. Monash University, Australia, received a project grant from the National Blood Authority of Australia to conduct the study in Australia and New Zealand.

Topic: Transfusion and haemostasis disorders.

001387

Impact of subject-ventilator dyssynchrony on diaphragm function and structure

M. Capdevila¹, A. de Jong¹, B. Jung², F. Reynaud³, S. Matecki³, A. Lacampagne³, S. Jaber¹

¹Anesthesia and critical care department b, University Hospital Center Saint Eloi Hospital, Montpellier, France; ²Intensive care unit, Lapeyronie Center University Hospital, Montpellier, France; ³Department of acquired muscle weakness in critically ill patients, PhyMedExp INSERM U1046, Montpellier, France

Correspondence: M. Capdevila

Intensive Care Medicine Experimental 2023, 11(Suppl 1):001387

Introduction. Subject-ventilator dyssynchrony following prolonged invasive mechanical ventilation is common and associated with extubation failure, extended ICU length of stay and mortality (1–5). Ineffective effort and double triggering are the two main dyssynchrony patterns (4). The direct impact of dyssynchrony on diaphragm function and structure after prolonged invasive mechanical ventilation is unknown.

Objectives. To assess the effect of dyssynchrony after prolonged totally controlled mechanical ventilation (CMV) on diaphragm function and structure in a piglet model of eccentric contraction (assimilated to ineffective efforts) and overdistension (assimilated to double triggering).

Methods. In this experimental study, 10 Large-White piglets were sedated and maintained under totally CMV during 72 h followed by 2 h of dyssynchrony with ineffective efforts and double triggering patterns. Diaphragm function (as previously described (6–9) supramaximal diaphragm force assessed by negative tracheal pressure (Ptrach) after phrenic nerve transvenous stimulation) was recorded at baseline (start of sedation), after 72 h of CMV and after additional 2 h of dyssynchrony. Diaphragm structure (sarcomeric injuries) was evaluated by electronic microscopy from biopsies harvested after 72 h of CMV and after additional 2 h of dyssynchrony.

Results. Of all the piglets, initially healthy, one died of sudden cardiac arrest following severe ARDS and was therefore excluded. The others 9 piglets completed the experiment. Supramaximal diaphragm force decreased by 22% from 69.9 ± 12.7 to 54.9 ± 19.7 cmH₂O ($p=0.025$) after 72 h of CMV attesting the ventilatory-induced-diaphragm-dysfunction (VIDD). It dropped by an additional 29% from 54.9 ± 19.7 to 38.9 ± 15.5 cmH₂O ($p<0.005$) after the additional 2 h period of dyssynchrony (Fig. 1), with a $54 \pm 15\%$ rate of dyssynchronous cycles. Diaphragm sarcomeric injuries accounted for $13 \pm 10\%$ of the total micrograph area after 72 h of CMV and increased to $24 \pm 19\%$ ($p<0.001$) after the additional 2 h of dyssynchrony (Fig. 2).

Conclusions. Two hours of subject-ventilator dyssynchrony in pre-existing ventilatory-induced-diaphragm-dysfunction are associated with further impairment of diaphragm function and additional damage to the diaphragm structure in this experimental piglet model.

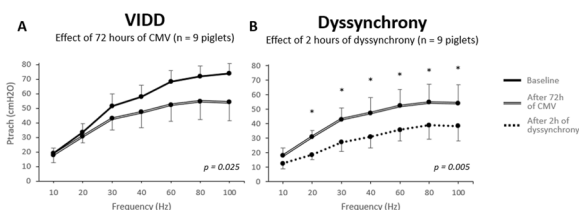

Figure 1 (abstract 001387) Diaphragmatic force frequency curves (A) at baseline versus after 72 h of totally controlled mechanical ventilation (CMV), (B) and after 72 h of CMV versus after additional 2 h of dyssynchrony, for the same piglets (n = 9)

Force-frequency curves illustrates supramaximal diaphragm force represented by negative tracheal pressure in airway occlusion condition (Ptrach), after different frequencies of bilateral phrenic nerve stimulation. After 72 h of CMV the force frequency curve showed a decrease in supramaximal diaphragm force of 22% and after additional 2 h of dyssynchrony the supramaximal diaphragm force dropped by an additional 29%. VIDD: Ventilatory-Induced-Diaphragm-Dysfunction. CMV: Totally controlled mechanical ventilation. Ptrach: tracheal pressure. Posted p-values between two periods were obtained after two-way ANOVA. * $p<0.01$ between two periods using paired t-test with Bonferroni correction for post hoc analysis.

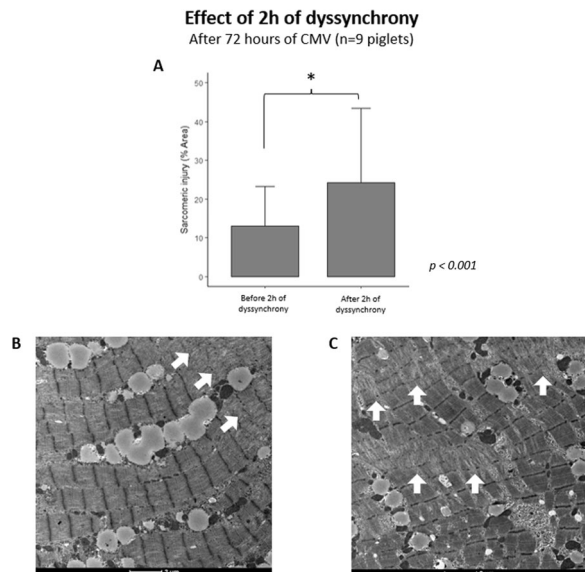

Figure 2 (abstract 001387) (A) percentage area of diaphragm sarcomeric injury after 72 h of totally controlled mechanical ventilation (CMV), before versus after additional 2 h of dyssynchrony. Representative electron microscopy images of longitudinal ultrathin sections obtained from the diaphragms after 72 h of CMV (B) before and (C) after additional 2 h of dyssynchrony. White arrows show disorganization of sarcomeric structure

After 72 h of CMV, diaphragm sarcomeric injuries represented $13 \pm 10\%$ of total area of the micrographs. This rate rises to $24 \pm 19\%$ after additional 2 h of dyssynchrony. CMV: Totally controlled mechanical ventilation. Posted *p*-values between two periods was obtained after paired *t*-test. * $p < 0.05$ between two periods.

References

- Blanch L, Villagra A, Sales B, Montanya J, Lucangelo U, Luján M, et al. Asynchronies during mechanical ventilation are associated with mortality. *Intensive Care Med.* 2015;41(4):633–41.
- Vaporidi K, Babalis D, Chytas A, Lilitis E, Kondili E, Amargianitakis V, et al. Clusters of ineffective efforts during mechanical ventilation: impact on outcome. *Intensive Care Med.* 2017;43(2):184–91.
- Magrans R, Ferreira F, Sarlabous L, López-Aguilar J, Gomà G, Fernandez-Gonzalo S, et al. The Effect of Clusters of Double Triggering and Ineffective Efforts in Critically Ill Patients. *Crit Care Med.* 2022;50(7):e619-29.
- Thille AW, Rodriguez P, Cabello B, Lellouche F, Brochard L. Patient-ventilator asynchrony during assisted mechanical ventilation. *Intensive Care Med.* 2006;32(10):1515–22.
- Sousa ML de A, Magrans R, Hayashi FK, Blanch L, Kacmarek RM, Ferreira JC. Predictors of asynchronies during assisted ventilation and its impact on clinical outcomes: The EPISYNC cohort study. *J Crit Care.* 2020;57:30–5.
- Jung B, Constantin JM, Rossel N, Le Goff C, Sebbane M, Coisel Y, et al. Adaptive Support Ventilation Prevents Ventilator-induced Diaphragmatic Dysfunction in Piglet. *Anesthesiology.* 2010;112(6):1435–43.

- Jaber S, Jung B, Sebbane M, Ramonatxo M, Capdevila X, Mercier J, et al. Alteration of the Piglet Diaphragm Contractility In Vivo and Its Recovery after Acute Hypercapnia: *Anesthesiology.* 2008;108(4):651–8.
- Jaber S, Sebbane M, Koechlin C, Hayot M, Capdevila X, Eledjam JJ, et al. Effects of short vs. prolonged mechanical ventilation on antioxidant systems in piglet diaphragm. *Intensive Care Med.* oct 2005;31(10):1427–33.
- Jung B, Sebbane M, Goff C, Rossel N, Chanques G, Futier E, et al. Moderate and prolonged hypercapnic acidosis may protect against ventilator-induced diaphragmatic dysfunction in healthy piglet: an in vivo study. *Crit Care.* 2013;17(1).

Topic: Acute respiratory failure and mechanical ventilation.

e-POSTERS

000006

Effect of regional nerve block on postoperative delirium or cognitive dysfunction after cardiothoracic surgery: a systematic review and meta-analysis

H. J. Shin¹, H. S. Na¹, S. Lee¹, C. H. Koo¹

¹Department of Anesthesiology and Pain Medicine, Seoul National University Bundang Hospital, Seongnam, Republic of Korea

Correspondence: H.J. Shin

Intensive Care Medicine Experimental 2023, **11(Suppl 1)**:000006

Introduction. Regional nerve blocks reduce the incidence of postoperative delirium (POD) and postoperative cognitive dysfunction (POCD) in adult patients undergoing cardiothoracic surgery. However, conflicting results have been reported in several randomized controlled trials (RCTs).

Objectives. This systematic review and meta-analysis was conducted to identify the benefits of regional nerve blocks, focusing on the effects of nerve blocks on postoperative cognitive function in patients after cardiothoracic surgery.

Methods. Electronic databases, including PubMed, EMBASE, CINAHL, Scopus, and Web of Science, were searched to identify studies that evaluated the effects of regional nerve blocks on POD and POCD. The primary outcome was the incidence of POD or POCD during the postoperative recovery period. The secondary outcome was postoperative pain scores at 24 and 48 h after surgery. We estimated the log odds ratio (LOR) and standardized mean difference using the Hedges' *g* method with 95% confidence intervals (CIs) to determine the effect size using a random-effect model. The LOR was converted to an OR when describing the effect size of categorical data.

Results. A total of 1010 adult patients from seven randomized controlled trials were included in the final analysis. The incidence of POD and POCD was 14.1% and 16.7%, respectively, in the regional nerve block group, and 27.3% and 35.2%, respectively, in the control group. The pooled effect size revealed that regional nerve blocks significantly reduced the incidence of POD (OR, 0.44; 95% CI 0.30 to 0.64; $P < 0.001$; $I^2 = 0.00\%$) and POCD (OR 0.43, 95% CI 0.24 to 0.76; $P < 0.001$; $I^2 = 0.00\%$) in adult patients undergoing cardiothoracic surgery. Additionally, adults in the regional nerve block group reported significantly lower pain scores than those in the control group at 24 h (SMD, -2.60 ; 95% CI -3.90 to -1.30 , $P < 0.001$; $I^2 = 97.68\%$) and 48 h (SMD -1.80 , 95%CI -3.18 to -0.41 , $P = 0.01$; $I^2 = 98.14\%$) postoperatively.

Conclusions. Regional nerve blocks can reduce the incidence of POD and improve POC in adult patients after cardiothoracic surgery.

References

1. Strike E, Arklina B, Stradins P, Cusimano RJ, Osten M, Horlick E, et al. Postoperative Pain Management Strategies and Delirium After Transapical Aortic Valve Replacement: A Randomized Controlled Trial. *J Cardiothorac Vasc Anesth* 2019;33:1668–72.
2. Vaurio LE, Sands LP, Wang Y, Mullen EA, Leung JM. Postoperative delirium: the importance of pain and pain management. *Anesth Analg* 2006;102:1267–73.
3. Jin Z, Hu J, Ma D. Postoperative delirium: perioperative assessment, risk reduction, and management. *Br J Anaesth* 2020;125:492–504.
4. Vacas S, Cole DJ, Cannesson M. Cognitive Decline Associated With Anesthesia and Surgery in Older Patients. *JAMA* 2021.

Topic: Sedation, analgesia and delirium.

000007

Predictive factors and outcome of Right ventricle dysfunction in ARDS- A prospective observational study

V. Saini¹, C. Balaji², N. Yaddanapudi³

¹Anaesthesia and Intensive Care, Postgraduate Institute of Medical Education and Research, Chandigarh, France; ²Anaesthesia and Intensive Care, Postgraduate Institute of Medical Education and Research, Chandigarh, India; ³Anaesthesia, Post Graduate Institute of Medical Education & Research, Chandigarh, Chandigarh, India

Correspondence: V. Saini

Intensive Care Medicine Experimental 2023, **11(Suppl 1)**:000007

Introduction. Right ventricle (RV) dysfunction in ARDS increases the morbidity and mortality by causing hemodynamic instability and refractory hypoxemia. In spite of changes in ARDS management such as lung protective low tidal volume ventilation and early prone ventilation, the prevalence of RV dysfunction still ranges between 22%–50%. Early prediction of RV dysfunction in high-risk patients is possible by assessing various predictors which contributes to increase in RV afterload. We used 2D transthoracic echocardiography (TTE) to assess RV function in moderate to severe ARDS. We intend to assess prevalence of RV dysfunction, early predictors and outcome of RV dysfunction.

Objectives. A prospective observational study to evaluate the impact of clinical parameters, demographic and etiologic factors on RV dysfunction in patient with ARDS admitted in main ICU, Postgraduate Institution of Medical Education and Research, Chandigarh.

Methods. This was a prospective observational study conducted between January 2021 to October 2021 in main ICU, PGIMER. Based on BERLIN definition, 118 patients were screened for eligibility and 80 moderate to severe ARDS patients included in this study. Low tidal volume ventilation by limiting plateau pressure of less than 30 cmH₂O and restrictive fluid strategy were followed in all the patients. 2D TTE was used to assess RV function at admission, daily till first week and weekly till ICU discharge. We used RV end diastolic area/LV end diastolic area cut off of 0.6 to confirm RV enlargement. All the ventilatory parameters, gas exchange parameters (pH, PaO₂, PaCO₂) and outcome parameters (mechanical ventilation days, ventilator free days, all-cause mortality at 28 days, over-all ICU mortality) were observed. All patients were followed up till discharge from hospital.

Results. Out of 80 patients, 38 patients found to have RV dysfunction with median delay of 5 days from initiation of mechanical ventilation. Our study showed observed prevalence of RV dysfunction of 47.5% (95% CI: 36.2–59.0%). Patients admitted with viral pneumonia and known history of chronic obstructive pulmonary disease had higher risk of RV dysfunction with relative risk (RR) of 2.98 (95% CI: 1.43–6.21) and 3.83 (95% CI: 1.54–9.52) respectively. On multivariate regression analysis, we found that high PaCO₂ (OR: 1.37, 95% CI: 1.01–1.26) and high mean airway pressure (OR: 1.57, 95% CI: 1.15–2.16) in first three days of mechanical ventilation were independently associated with RV dysfunction. Out of 38 patients who developed RV dysfunction, 20 (52.6%) patients died within 28 days. However, our study did not reveal any association between RV dysfunction and 28 days mortality. Patients developed VAP/HAP in the first week and low PaO₂/FiO₂ in first three days had increased odds for 28 day mortality.

Conclusions. To conclude, our study revealed that high mean airway pressure and high PaCO₂ on the first three days of mechanical ventilation are independent predictors of RV dysfunction in ARDS. This study also revealed that a low PF ratio on the first three days of mechanical ventilation and HAP/VAP in the first week of ICU stay are independent predictors of 28 days mortality.

Topic: Cardiovascular issues in ICU.

000010

Novel, simple and useful smartphone indirect ophthalmoscope for intensivists

K. Hayashi¹, F. Araki², T. Toyama³, S. Temma⁴, Y. Sato⁵, G. Yamazaki⁶, H. Matsui¹

¹Pediatrics, The University of Tokyo Hospital, Bunkyo City, Japan; ²Ophthalmology, Showa General Hospital, Kodaira, Japan; ³Ophthalmology, The University of Tokyo Hospital, Bunkyo City, Japan; ⁴Research & Development Center, Nipro Corporation, Shiga prefecture, Japan; ⁵Department of Emergency Medicine and Critical Care Medicine, The University of Tokyo Hospital, Bunkyo City, Japan; ⁶Faculty of Medicine, The University of Tokyo, Bunkyo City, Japan

Correspondence: K. Hayashi

Intensive Care Medicine Experimental 2023, **11(Suppl 1)**:000010

Introduction. Examination of the retina and preservation of retinal images can be quite informative in the management of severely comatose patients in critical care. Although indirect ophthalmoscopy is the gold standard for retinal examination, it still requires an expensive device to store images and highly specialized skills of ophthalmologists. Establishment of bedside retinal point-of-care testing using a commonly available tool will be useful for critically-ill patients with impaired consciousness requiring rapid diagnosis and evaluation of treatment efficacy.

Objectives. We innovated a novel non-ophthalmologist friendly smartphone indirect ophthalmoscope (SO) and examined its feasibility in eyeball models by non-ophthalmologists and medical students.

Methods. We conducted a single-center, cross-sectional, observational study with subjects of non-ophthalmologists including pediatricians, emergency physicians, junior residents and medical students from October 22, 2022 to March 31, 2023. We developed a novel SO consisting of 3D printed attachment device with technical support by Nipro Corporation (Shiga, Japan), (Fig. 1), a 40-diopter

lens and an iPhone 7 (Apple, Tokyo, Japan). The source of the light for retinal images is a LED light on the smartphone. We tested subjects for utilization of SO by imaging two mydriatic adult and pediatric eyeball models (a pupil diameter of 10 mm and 7 mm, respectively) (Fig. 2). Retinal images in the models were optic papilledema in the adult model and retinal hemorrhage in the pediatric model (Fig. 3). Subjects first recorded a movie image with the adult model before recording another movie image with the pediatric eye model. Instruction for participants before the test was to hold the iPhone in place for 5 s once in focus. For each model, we evaluated the percentage of retinal images suitable for diagnosis by two independent ophthalmologists, time for capturing retinal movies, and inter-rater reliability. Statistical analysis was performed by McNemer test and Wilcoxon signed-rank test. Inter-rater reliability was represented as the Gwet's AC1.

Results. Consents for the test was obtained with 99 subjects (36 medical students and 63 physicians) in 113 participants. Percentage and the median time for obtaining images suitable for diagnosis was 97% and 30 s [Interquartile range (IQR) 21–48.5] in the adult model and 99% and 18 s [14–31.0] in the pediatric model, respectively ($p=0.48$ in the percentages and $p<0.001$ in the median time). Inter-observer reliabilities represented by the Gwet's AC1 in the adults and pediatric model were 0.98 and 0.99, respectively.

Conclusions. The novel smartphone indirect ophthalmoscope has a significant potential for easy recording of retinal images by non-ophthalmologists, suggesting possible application for a wide range of situations including critical care and emergency treatment.

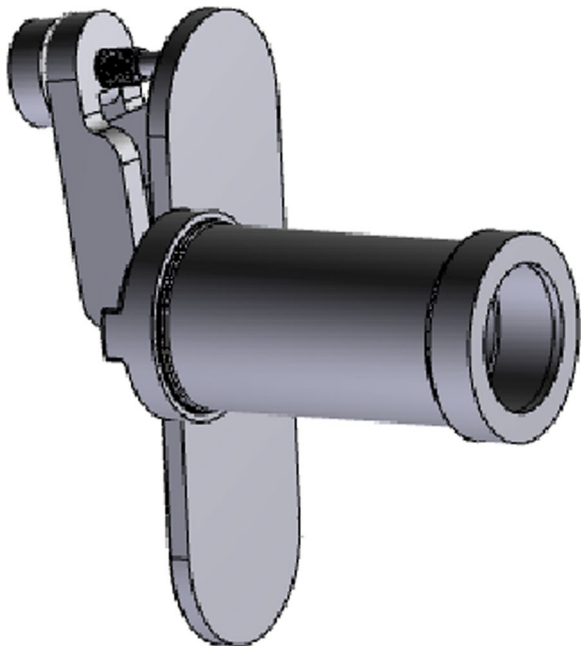

Figure 1 (abstract 000010) Smartphone indirect ophthalmoscope



Figure 2 (abstract 000010) Eyeball model



Figure 3 (abstract 000010) Images of optic papilledema (left) and retinal hemorrhage (right)

References

1. The authors disclosed receipt of the following financial support for the research: This work was supported by the Nipro Corporation. Nipro Corporation participated in the development of the SO, but was not involved in conducting the study or analyzing the results.

Topic: Imaging in intensive care.

000011

Impact on the flora of an intensive care unit after implementation of a model of selective digestive-oro-pharyngeal decontamination

R. Fernández Fernández¹, G. J. M. Giménez¹, R. Morón Moreno², P. Fernández Morales¹, M. E. Yuste Ossorio¹

¹Intensive Care Unit, Hospital Universitario San Cecilio, Granada, Spain;

²Farmacia, Hospital Universitario Clínico San Cecilio, Granada, Spain

Correspondence: R. Fernández Fernández

Intensive Care Medicine Experimental 2023, **11(Suppl 1)**:000011

Introduction. Selective digestive decontamination and oropharyngeal (DDS-DOF) is a prophylactic strategy whose objective is to reduce the incidence of infections, mainly pneumonia associated with mechanical ventilation, preventing or eradicating the oropharyngeal and gastrointestinal carrier state of potentially harmful microorganisms pathogens.

Objectives. To expose the pathogenesis of infections in the patients of our unit, describe the DDS-DOF, to analyze the available evidence on its efficacy in relation to isolated colonizations.

Methods. July 22-October 22. Our unit has 22 beds. Inclusive criteria: 1. Positive growth in any clinical or surveillance sample of any multi-resistant microorganism. 2. All patients in whom tracheal intubation or tracheostomy is considered with a duration greater than 72 h. 3. All non-intubated patients who present any of the risk factors for pneumonia: Low level of consciousness with GSC ≤ 11 , esophago-gastroctomy. Necrotizing pancreatitis. Transplanted and/or neutropenic. 1. DOF. Intubation: Wash mouth 0.1% Chlorhexidine. DOF paste (5 ml). Without intubation: Wash with 0.2% Chlorhexidine. DOF paste. 2. DDS. Antibiotics by tube nasogastric (NGS). Will be applied/8 h. Absolute diet, only DOF. Paste DOF 125 gr: colistin sulfate 2.5 gr + gentamicin sulfate 4 g + nystatin 2.5 gr + liquid vaseline + lemon essence + orabase. Antibiotic solution: same composition for every 20 ml of solution 100 mg of colistin + 80–120 mg of gentamicin and 800,000 IU of nystatin. Isolation by MARS will add 4% vancomycin. Maintained 72 h after extubation, except MDR in which until negative in ICU.

Results. 33 patients, 24 men (72%), 9 women (28%), median age 59 years. Regarding the reason for admission, most frequent was PCR, 8 patients (24%) followed by respiratory failure with 5 patients (15%). APACHE II scale was 21 points and the median ICU stay was 21 days. 100% of patients received empirical antibiotic therapy, with the b-lactam group being the most used (39%). 93.9% of patients received DDS and DOF upon initiation of mechanical ventilation. 90% had no colonization. After the administration of DDS-DOF, growth was observed in 18% of the patients, not highlighting any microorganism due to its frequency.

Conclusions. No patient to whom the technique has been applied has presented colonization by multiresistant bacteria, only 1 has been infected. We demonstrate technique is worthwhile as well as the training of personnel. The success depends on the teamwork of the ICU as well as interdisciplinary with the Pharmacy Service.

Topic: Infections and prevention.

000012

Nosocomial infections in the ICU since the beginning of the COVID-19 pandemic

R. Fernández Fernández¹, P. Fernández Morales¹, M. E. Yuste Ossorio¹

¹Intensive Care Unit, Hospital Universitario San Cecilio, Granada, Spain

Correspondence: R. Fernández Fernández

Intensive Care Medicine Experimental 2023, **11(Suppl 1)**:000012

Introduction. Bearing in mind that during the worst times of the pandemic (20 and 21) admissions in our unit doubled, requiring help of personnel who were not experts in critical care.

Objectives. We want to analyze nosocomial infections that patients have presented admitted since the beginning of pandemic and after it and study the differences between them.

Methods. Retrospective descriptive observational study. ICU admissions (cardiological, medical: polyvalent, COVID, traumatological) during 2020, 2021 and 2022, analyzing incidence density (ID): associated pneumonia mechanical ventilation (VAP), catheter-associated bacteremia (CAB) and infections urinary tract related to bladder catheterization (ITU). Nursing and auxiliary team during pandemic was ICU and Anesthesia staff with differences in experience in critical patients. Categorical variables are described as a percentage of each category and the continuous as means and standard deviation or medians and interquartile range. The statistics have been developed in programs written in asp, visual basic and SPSS. Demographic variables are collected, APACHE II, days of stay in ICU and mortality.

Results. VAP: incidence density period 1: 5.06, 2: 5.39, 3: 5.93, CAB: 5/3.58/0.67, ITU: 7.24/15.88/6.901.2020: APACHE 13.96 \pm 8.27; days stay 7.15 \pm 10.49, mortality 13.96% Medical: N 525 47.64% Surgical: N 140 12.70% Trauma: N 27 2.45% Coronary: N 410 37.21% 2021: APACHE 15.65 \pm 9.35; days of stay 6.39 \pm 10, mortality 12.65% Medical N 670 46.66% Surgical N 188 13.09% Trauma N 36 2.51% Coronary N 542 37.74% 3. 2022: APACHE 14.66 \pm 9.59; days stay 4.08 \pm 5.86, mortality 8.96% Medical: N 494 39.02% Surgical: N 218 17.22% Trauma: N 53 4.19% Coronary: N 501 39.57%

Conclusions. In pandemic (2020 and 2021), nosocomial infections, especially CAB and ITUSV, exceed the incidence that we have presented later. DI has been higher possibly due to the care overload and that nursing staff were inexperienced in both the Zero programs and the job from ICU. The reasons for this increase may be different and deserve a detailed study to identify the causes and avoid them. There is no doubt that it is more fragile patients and longer stays than non-COVID patients, so extreme care should be taken them the prevention measures proposed in the different Zero Projects.

Topic: Infections and prevention.

000015

MVP ECG risk score as predictor of postoperative atrial fibrillation in patients undergoing coronary artery bypass graft procedure

H. J. Ramos¹

¹Critical Care Medicine, Philippine Heart Center, Quezon City, Philippines

Correspondence: H.J. Ramos

Intensive Care Medicine Experimental 2023, **11(Suppl 1)**:000015

Introduction. Atrial fibrillation (AF) is one of the most common serious cardiac rhythm disturbances and is responsible for substantial morbidity and mortality in the general population. A simpler tool to identify patients at risk for AF by only using basic, noninvasive, and easily obtainable electrocardiographic markers known as the MVP ECG risk score (morphology-voltage-P-wave duration) was proposed by Alexander et al. to predict occurrence of AF in patients with known or suspected coronary artery disease who underwent coronary angiography. Results of this study showed that the high- and intermediate-risk groups were more likely to develop AF than the low-risk group.

Objectives. The purpose of this study was to determine if there is association of the MVP ECG risk score in predicting Postoperative Atrial Fibrillation (POAF) in patients who underwent Coronary Artery Bypass Graft (CABG) procedure, which may be a useful tool for preoperative risk stratification.

Methods. A total of 118 patients without previous AF undergoing CABG were retrospectively studied. The MVP ECG risk score allocated points to their baseline ECG's based on P-wave morphology in the inferior leads, P-wave voltage in lead 1, and P-wave duration in the inferior leads. The scores were classified under three risk groups either low, moderate or high risk for developing AF. Finally, patients were followed postoperatively until their last available ECG record to document presence of AF.

Results. Mean age was 65 years and 89% were male. The incidence of POAF in this population was 25.42%. Patients with intermediate risk score were more likely to develop POAF compared to low risk group (odds ratio [OR] 9.4203, 95% confidence interval [CI] 3.37–26.4; $p \leq 0.001$) and for every score increase, the odds of having POAF also increases (OR 2.8281, 95% CI 1.83–4.37; $p \leq 0.001$).

Conclusions. This study demonstrates that the MVP ECG Score composed of easily measured electrocardiographic variables can predict the risk of having AF in patients who undergo CABG procedure.

References

1. Friberg L, Rosenqvist M, Lip GY. Evaluation of risk stratification schemes for ischaemic stroke and bleeding in 182 678 patients with atrial fibrillation: the Swedish Atrial Fibrillation cohort study. *Eur Heart J*. 2012;33:1500–1510. <https://doi.org/10.1093/eurheartj/ehr488>
2. Creswell LL, Schuessler RB, Rosenbloom M, Cox JL. Hazards of postoperative atrial arrhythmias. *Ann Thorac Surg*. 1993;56:539–549.
3. Aranki SF, Shaw DP, Adams DH, Rizzo RJ, Couper GS, VanderVliet M, Collins JJ Jr, Cohn LH, Burstin HR. Predictors of atrial fibrillation after coronary artery surgery: current trends and impact on hospital resources. *Circulation*. 1996;94:390–397.
4. Mathew JP, Parks R, Savino JS, Friedman AS, Koch C, Mangano DT, Browner WS, for the Multicenter Study of Perioperative Ischaemia Research Group. Atrial fibrillation following coronary artery bypass graft surgery: predictors, outcomes, and resource utilization. *JAMA*. 1996;276:300–306.
5. Chebbout R, Heywood EG, Drake TM, Wild JRL, Lee J, Wilson M, et al. A systematic review of the incidence of and risk factors for postoperative atrial fibrillation following general surgery. *Anaesthesia*. 2018;73:490–498. <https://doi.org/10.1111/anae.14118>
6. Dela Cruz A, Bayani D, Gonzales E et al. Timelines of Philhealth Z Benefit Package for Standard Risk Coronary Artery Bypass Graft (CABG) Surgery at the University of the Philippines- Philippine General Hospital. *Acta Medical Philippina*. 2021; 55–1
7. Cantre J, Permejo C (2014). Validating the Postoperative Atrial Fibrillation Score. Unpublished manuscript. Philippine Heart Center
8. Ramos-Salamanca L, Cuyco R, Flores V, Tucay E (2012). Preoperative Left Atrial Parameters as Predictors of Postoperative Atrial Fibrillation after Cardiac Surgery. Unpublished manuscript. Philippine Heart Center. Downloaded from <https://www.herdin.ph/index.php/herdin-home?view=research&cid=68570>
9. Maravillas-Garcia I, Cuyco R, Tucay E et al. (2010). Left Atrial Volume and Left Atrial Function Indices As Predictors for the Occurrence of Post-operative Atrial Fibrillation Among Patients Undergoing Cardiac Surgeries. Unpublished manuscript. Philippine Heart Center
10. Alonso et al., 2013; Chamberlain et al., 2011; January et al., 2014; Kokubo et al., 2017; Schnabel et al., 2009.
11. Mariscalco G, Biancari F, Zanobini M, Cottini M, Piffaretti G, Saccocci M. Bedside tool for predicting the risk of postoperative atrial fibrillation after cardiac surgery: the POAF score. *J Am Heart Assoc*. 2014;3:e000752.
12. Lip GY, Lane DA. Modern management of atrial fibrillation requires initial identification of “low-risk” patients using the CHA2DS2-VASc score, and not focusing on “high-risk” prediction. *Circ J*. 2014;78:1843.
13. de Vos CB, Pisters R, Nieuwlaat R, Prins MH, Tieleman RG, Coelen RJ, et al. Progression from paroxysmal to persistent atrial fibrillation clinical correlates and prognosis. *J Am Coll Cardiol*. 2010;55:725–31.
14. Alexander B, Mildren J, Hazim B, et al. New electrocardiographic score for the prediction of atrial fibrillation: The MVP ECG risk score (morphology-voltage-Pwave duration). *Ann Noninvasive Electrocardiol*. 2019;24:e12669. <https://doi.org/10.1111/anec.12669>
15. Greenberg M, Katz N, Iuliano S, et al. Atrial Pacing for the Prevention of Atrial Fibrillation After Cardiovascular Surgery. *Journal of the American College of Cardiology*. 2000; Vol. 35, No.6.
16. Trappe HJ, Brandts B, Weismueller P. arrhythmias in the intensive care patient. *Curr Open Crit Care*. 2003; 9 (5): 345–55.
2. The researchers would like to thank Dr. Leahdette Padua for her insights and guidance that greatly assisted us in the conduct of this study. Also, we would like to express our gratitude to Sir Rhalph Jaylord Valenzuela for his expertise in the statistical analysis. Lastly, we are equally indebted to the ETRS staffs that helped us in paper works as well as in the accomplishment of necessary requirements needed in accomplishing this study.

Topic: Perioperative care.

000016

Comparison of cardiac output measurements in septic shock and hemorrhagic shock patients between Flotrac/Vigileo and transthoracic Doppler echocardiography

V. Piccoli¹, P. Grassi¹, T. Pellis², A. De Luca³, G. Sinagra³, G. Berlot¹, U. Lucangelo¹

¹Department of Anaesthesia, Intensive Care Medicine and Pain Medicine, Cattinara Hospital, Trieste, Italy; ²Department of Anaesthesia and Intensive Care Medicine, Azienda Sanitaria Friuli Occidentale, Pordenone, Italy; ³Department of Cardiology, Cattinara Hospital, Trieste, Italy

Correspondence: V. Piccoli

Intensive Care Medicine Experimental 2023, **11(Suppl 1)**:000016

Introduction. Whether the ability of haemodynamic monitoring devices in patients with altered elastance may be effective is unclear.

Objectives. The primary outcome of this prospective observational study was to monitor stroke volume (SV) and cardiac index (CI) comparing a mini-invasive haemodynamic monitoring system (Flotrac/Vigileo) and trans thoracic Doppler echocardiography (Echo) in septic patients or patients with hemorrhagic shock.

Methods. This study enrolled 47 patients older than 18 years in circulatory shock requiring cardiac output monitoring and prolonged administration of norepinephrine (>0.25 mcg/Kg/min) and eventually another vasopressor. Patients with atrial fibrillations or arrhythmia, severe aortic stenosis, women in pregnancy and patients with an expectation of survival < 24 h (or requiring urgent surgery) were excluded. Echo was performed by a cardiologist.

Results. On a Bland–Altman graph the mean and SD between the two devices were $-9 \pm 15,1$ ml in terms of SV (LOA $-38,7$ 20,6) and $-0,42 \pm 0,48$ L/min/m² in terms of CI (LOA $-1,38$ 0,53). Flotrac/Vigileo had good correlation with Echo. 4 patients had atrial fibrillation during this study and the collection of data stopped. Considering Echo as reference method, a larger sample (101 measurements) was divided into two groups: in the subgroup with haemodynamics supported by more than one vasopressor the bias and SD were $8,1 \pm 9,1$ ml (LOA $-9,8$ 26) while in the subgroup with one vasopressor the bias and SD were $8,1 \pm 12,9$ ml (LOA $-17,2$ 33,3).

Conclusions. Among these patients with haemodynamic instability (34 in septic shock and 13 in hemorrhagic shock) the two devices correlated well, although Flotrac/Vigileo slightly overestimated Sv and Ci. However, in the subgroup with haemodynamics sustained by two vasopressors, measurements of the two devices appeared to diverge compared to subgroup with one vasopressor, using Echo as reference method.

Topic: Cardiovascular issues in ICU.

000019

The value of mottling score in evaluating tissue hypoperfusion in cardiac surgical critical ill patients

J. C. Luo¹

¹Cardiac Intensive Care Center, Zhongshan Hospital, Fudan University, Shanghai, China

Correspondence: J.C. Luo

Intensive Care Medicine Experimental 2023, **11(Suppl 1)**:000019

Introduction. Skin mottling is a common clinical feature of tissue hypoperfusion. The mottling score is a semi-quantitative description of the severity of mottling.

Objectives. The aim of this study is to evaluate the value of mottling score in critically ill patients after cardiac surgery.

Methods. Critically ill patients after cardiac surgery with the risk of tissue hypoperfusion were enrolled. The mottling score, capillary refill time

(CRT), mean arterial pressure (MAP), lactate, urine output, vasopressor dose, and other parameters reflecting tissue perfusion were recorded, and patients were followed up until death or discharge. Patients with and without mottling were compared in terms of characteristics, and survival curves were compared to assess the impact of skin mottling on clinical survival. The accuracy of mottling score and other tissue perfusion parameters in predicting clinical outcomes was also compared.

Results. A total of 373 patients were enrolled, and only 13 patients had skin mottling, with mottling scores ranging from 1 to 5 (5, 1, 2, 2, and 3 cases, respectively). Mottling patients had lower MAP, higher vasopressor dose, less urine output, higher CRT, and higher lactate levels. There were significant correlations among mottling score and urine output, lactate, vasopressor dose, and CRT. There were also widespread correlations between other tissue perfusion parameters, and the correlations were more significant in patients with skin mottling. The optimal threshold of mottling score for predicting mortality was 1, with a sensitivity of 20 (95% CI: 10–33), specificity of 99 (95% CI: 98–100), positive predictive value of 85 (95% CI: 55–98), and negative predictive value of 88 (95% CI: 84–91).

Conclusions. In cardiac surgical critical ill patients, mottling score is a specific but not sensitive parameter for assessing the severity of tissue hypoperfusion.

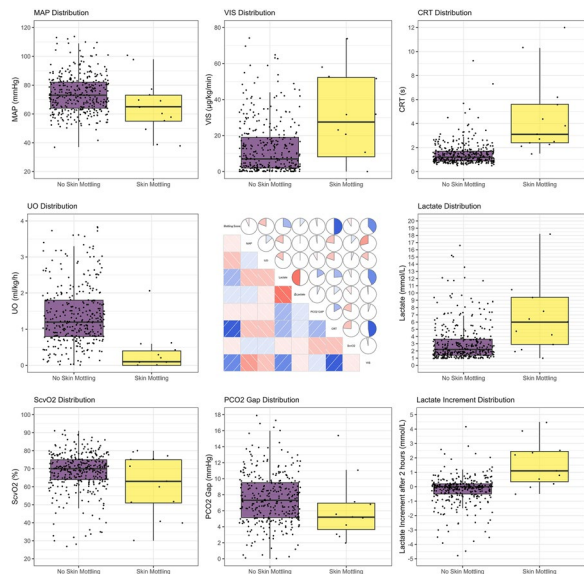

Figure 1 (abstract 000019) Distribution of tissue perfusion parameters between patients with and without mottling

Topic: Cardiovascular issues in ICU.

000020

Short- and long-term outcomes following maternal critical illness

J. Masterson¹, I. Adamestam², M. Beatty¹, J. Boardman³, L. Chislett⁴, P. Johnston⁵, J. Joss⁵, H. Lawrence⁶, K. Litchfield⁷, N. Plummer⁸, S. Rhode⁴, T. Walsh¹, A. Wise¹, C. Weir², N. Lone⁴

¹Department of Anaesthesia, Critical Care, and Pain Medicine, Royal Infirmary of Edinburgh, University of Edinburgh, Edinburgh, United Kingdom; ²Edinburgh Clinical Trials Unit, Usher institute, The University of Edinburgh, Edinburgh, United Kingdom; ³MRC centre for reproductive health, Queen’s Medical Research Institute, The University of Edinburgh, Edinburgh, United Kingdom; ⁴Usher institute, The University of Edinburgh, Edinburgh, United Kingdom; ⁵Department of Anaesthesia, Critical Care, and Pain Medicine, Ninewells hospital, Dundee, United Kingdom; ⁶Patient representative, The University of Edinburgh, Edinburgh, United Kingdom; ⁷Department of Anaesthesia, Critical Care, and Pain Medicine, Glasgow Royal Infirmary, Glasgow, United

Kingdom; ⁸Department of Critical Care, Nottingham University Hospitals, Nottingham, United Kingdom

Correspondence: J. Masterson

Intensive Care Medicine Experimental 2023, 11(Suppl 1):000020

Introduction. For each maternal death, 70–90 mothers experience critical illness [1,2] and with rising maternal age and obesity rates the incidence may increase [3]. Evidence from general ICU populations demonstrates an increase in physical and psychological morbidity, healthcare resource use and mortality following critical illness [4,5,6]. However, there is a paucity of research considering the outcomes of women who experience critical illness during pregnancy.

This study aimed to report short- and long-term maternal and fetal outcomes following pregnancy in women admitted to critical care during their pregnancy and to compare this with women who did not require admission.

Methods. A retrospective cohort study using Scotland’s national healthcare databases. The population included all women delivering between 01/01/2005–31/12/2018 in a Scottish hospital. Critical illness was defined as an Intensive Care Unit (ICU) admission during pregnancy. Outcomes included hospital readmission (short-term ≤ 42d; long-term 43-365d post-discharge), mortality (short-term ≤ 42d; long-term 43-365d post-delivery), psychiatric admission, stillbirth, and neonatal critical care admission. Cox regression was used to estimate the hazard ratio (HR) for hospital readmission, mortality, and psychiatric admission. Logistic regression was used to identify the risk of stillbirth and neonatal ICU admission.

Results. Of 762,918 pregnancies included in our study 1,449 (0.18%) required ICU care. Short-term readmission was more common in the ICU cohort compared with the non-ICU cohort (26.7%, n = 383 vs 5.3%, n = 40,556; unadjHR 4.5, 95%CI (3.3, 6.0), p < 0.001). Findings were similar for long-term readmission (14.1%, n = 201 vs 4.1%, n = 30,915; unadjHR 1.80, 95%CI (1.32, 2.45), p < 0.001). Readmission risk was greater in the ICU vs non-ICU cohort after confounder adjustment (short-term adjHR 4.33 (2.79, 6.72), p < 0.001; long-term adjHR 1.93 (1.25, 2.93), p = 0.003).

Increased mortality was seen in the ICU cohort for both short-term (1.4%, n = 21 vs < 0.01%, n = 20) and long-term (0.6%, n = 8 vs < 0.01%, n = 172) outcomes, which persisted after confounder adjustment (adjHR = 34.7 (20.15, 59.73), p < 0.001). Psychiatric admission within 1-year of delivery occurred in 0.7% (n = 10) of the ICU cohort and 0.3% (n = 2157) of those not requiring admission (unadjHR 2.35 (1.12, 4.94), p = 0.024). This association was attenuated after confounder adjustment (adjHR 1.34 (0.56, 3.25), p = 0.51).

The odds of stillbirth (OR 8.41 (6.05, 11.70), p < 0.001) and neonatal critical care admission (OR 9.20 (8.02, 10.57), p < 0.001) were significantly increased in the cohort admitted to ICU after adjustment.

Conclusions. Women admitted to critical care during pregnancy have a significantly increased risk of adverse short- and long-term maternal and fetal outcomes. Consequently, optimising the prevention of and aftercare for critical illness during pregnancy may reduce the health impact for these women and their offspring.

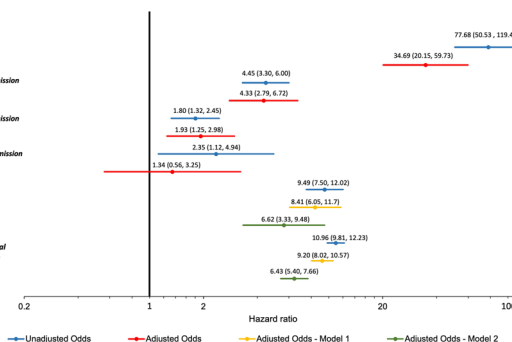

Figure 1 (abstract 000020) Forest plot comparing the hazard/odds ratios of each outcome between women who were admitted to critical

care during their pregnancy compared to those who were not. Unadjusted hazard ratios (blue) and adjusted ratios (red) are presented for each maternal outcome. Unadjusted odds ratios (blue) are presented for birth outcomes and adjusted model 1 (yellow) and model 2 (green)

References

1. We are grateful to Roz Pollock for deriving the cohort and linking the datasets. We are grateful to the late Prof. Denison who contributed to study design, analysis and securing funding. We thank the eDRIS Team (Public Health Scotland) for its involvement in obtaining approvals, provisioning and linking data and the use of the secure analytical platform within the National Safe Haven
2. Obstetric Anaesthetists' Association
3. N. I. Lone, M. A. Gillies, C. Haddow, R. Dobbie, K. M. Rowan, S. H. Wild, G. D. Murray and T. S. Walsh, "Five-Year Mortality and Hospital Costs Associated with Surviving Intensive Care," *American Journal of Respiratory and Critical Care Medicine*, vol. 194, no. 2, pp. 198–208, 2015.
4. T. S. Walsh, L. G. Salisbury, J. L. Merriweather, J. A. Boyd, D. M. Griffith, G. Hubby, S. Kean, S. J. Mackenzie, A. Krishan, S. C. Lewis, G. D. Murray, J. F. Forbes, J. Smith and J. E. Rattray, "Increased Hospital-Based Physical Rehabilitation and Information Provision After Intensive Care Unit Discharge: The RECOVER Randomized Clinical Trial," *JAMA Internal Medicine*, vol. 175, no. 6, pp. 901–10, 2015.
5. S. V. Desai, T. J. Law and D. M. Needham, "Long-term complications of critical care," *Critical Care Medicine*, vol. 39, no. 2, pp. 371–379, 2011.
6. Public Health Scotland, "Births in Scotland Year ending 31 March 2021," 30 November 2021. [Online]. Available: <https://publichealthscotland.scot/publications/births-in-scotland/births-in-scottish-hospitals-year-ending-31-march-2021/>. [Accessed 18 November 2022].
7. Maternal Critical Care Working Group, "Providing equity of critical and maternity care for the critically ill pregnant or recently pregnant woman," July 2011. [Online]. Available: https://www.oaa-anaes.ac.uk/assets/_managed/cms/files/Maternal_Critical_Care.pdf. [Accessed 18 November 2022].
8. Morbidity: reducing avoidable harm," July 2014. [Online]. Available: https://www.healthcareimprovementscotland.org/our_work/reproductive_maternal_child/programme_resources/scasmm.aspx. [Accessed 18 November 2022].

Topic: Critical care organisation, quality management, information systems, outcomes.

000022

Severe burned patients should receive enteral nutrition within 72 hours of injury

Z. Yin¹

¹Burn & Plastic Department, Ruijin Hospital, School of Medicine, Shanghai Jiaotong University, Shanghai, China

Correspondence: Q. Zhang

Intensive Care Medicine Experimental 2023, **11(Suppl 1)**:000022

Introduction. The International Society for Burn Injuries (ISBI) recommends that severely burned patients start enteral nutritional therapy as early as possible. However, patients with severe burns usually suffer from delayed enteral nutrition. Gastrointestinal reflux and dynamic intestinal obstruction such as decreased bowel sounds and the disappearance of intestinal peristalsis increase the risk of respiratory tract infections. However, gastrointestinal mucosal edema may lead to poor absorption of nutrients by the gastrointestinal tract. Consequently, the timing of early enteral nutrition is still uncertain.

Objectives. To analyze the main factors affecting the early enteral nutrition and the effect of enteral nutrition within 72 h after injury on outcomes through a retrospective cohort study of 11 years of hospitalization data, so as to provide a prove for enteral nutrition regimens for critical burn injuries.

Methods. Clinical data and methods: This retrospective cohort study of adult inpatients with a more than 30% of total burned surface area of from January 1, 2009 to December 31, 2020.

Results. The main single factors affecting gastrointestinal nutrition in one week after injury were: total burn area, full-thickness burn area, whether flame burns, and whether inhalation injury of comorbidity ($P < 0.05$). Incorporating the above single factors into multiple regression analysis found that the main influencing factors affecting enteral nutrition for intensive burned patients were full-thickness burned area ($P = 0.017$) and comorbidity of inhalation injury ($P = 0.001$). In this study, it was further analyzed the treatment outcomes of initiating enteral nutrition after 72 h after injury whether the patients with flame burns, the larger the total burn area, and the larger the area of third-degree burns. The data matched that enteral nutrition administered 72 h after injury had a lower incidence of intravenous catheters infection and a lower rate of receiving total parenteral nutrition within 7 days after injury.

Conclusions. This study found that gastrointestinal nutrition within 72 h after injury can reduce the incidence of catheter infection and the utilization rate of intravenous nutrition, thereby reducing the risk of treatment of patients with severe burns.

Topic: Nursing care and physiotherapy.

000027

TIMP-2 attenuates pyroptosis in early sepsis-associated acute kidney injury by inhibiting NLRP3 inflammasome activation via cAMP-dependent pathway

D. Xu¹

¹Department of Critical Care Medicine, Zhongnan Hospital of Wuhan University, Wuhan, China

Correspondence: D. Xu

Intensive Care Medicine Experimental 2023, **11(Suppl 1)**:000027

Introduction. The novel biomarker, TIMP-2 is used clinically to predict different types of acute kidney injury (AKI) and has drawn significant attention as a urinary biomarker. However, as a secreted protein in the circulation of patients with AKI, it is unclear whether TIMP-2 acts as a key regulator in AKI progression, and if mechanisms underlying its upregulation still need to be determined.

Objectives. The objective of this project was to: 1) study the role of TIMP-2 on inflammatory regulation following AKI; 2) elucidate the mechanism of TIMP-2 function on subsequent inflammatory and repair following AKI by modulation of cAMP signaling.

Methods. Kidney tubule specific TIMP2 knockout mice were generated to examine the importance of it during SA-AKI.

Results. In this study, kidney tubule-specific TIMP2 knockout mice exhibited more profound kidney injury than WT mice did in the early stage, accompanied by the elevation of pyroptosis marker NLRP3 and GSDMD as higher inflammatory cytokines IL-1 and IL-18 levels. Further in vitro study revealed that extracellular TIMP2 promoted the ubiquitination and autophagy-dependent degradation of NLRP3. Moreover, KH7, a cAMP inhibitor remarkably prevented, while the cAMP agonist forskolin further enhanced, the ubiquitination of NLRP3 induced by recombinant TIMP2 following LPS stimulation, demonstrating the pivotal role of intracellular cAMP in mediating the effects of exogenous TIMP2. Together, we demonstrated that extracellular TIMP2 promoted NLRP3 ubiquitination and degradation by increasing intracellular cyclic adenosine monophosphate (cAMP), attenuating downstream pyroptosis, and thus alleviating renal damage.

Conclusions. Our results revealed the renoprotective role of early secreted extracellular TIMP2 during SA-AKI by attenuating tubular pyroptosis and the viability of exogenous administration of TIMP2 as a potential therapeutic intervention in SA-AKI treatment.

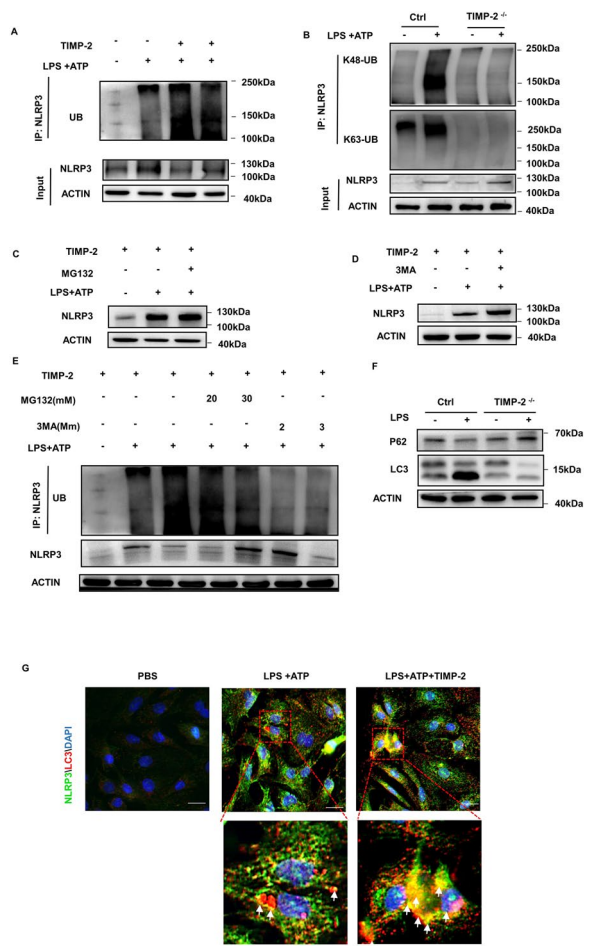

Figure 4 (abstract 000027) Forest plot comparing the hazard/odds ratios of each outcome between women who were admitted to critical care during their pregnancy compared to those who were not. Unadjusted hazard ratios (blue) and adjusted ratios (red) are presented for each maternal outcome. Unadjusted odds ratios (blue) are presented for birth outcomes and adjusted model 1 (yellow) and model 2 (green) TIMP-2 promoted NLRP3 inflammasome ubiquitination and autophagic degradation.

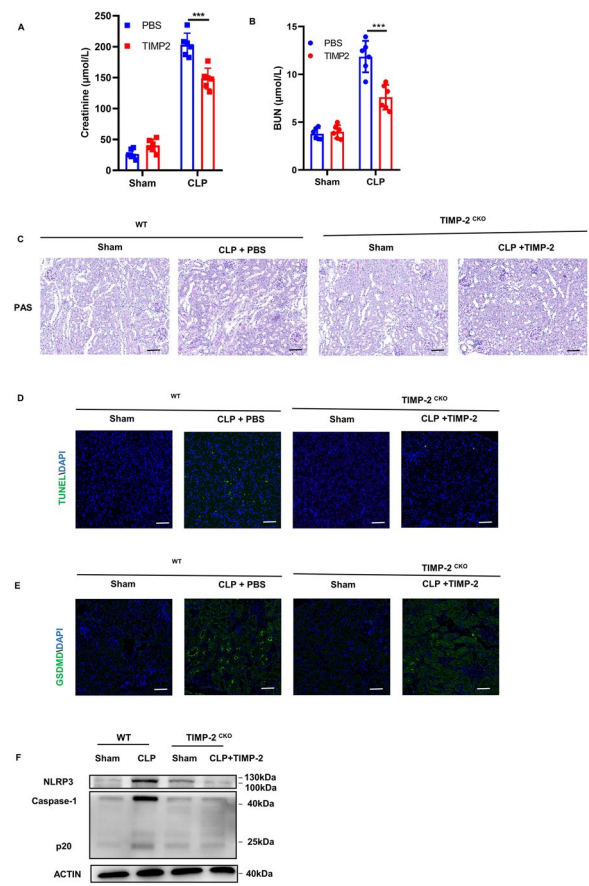
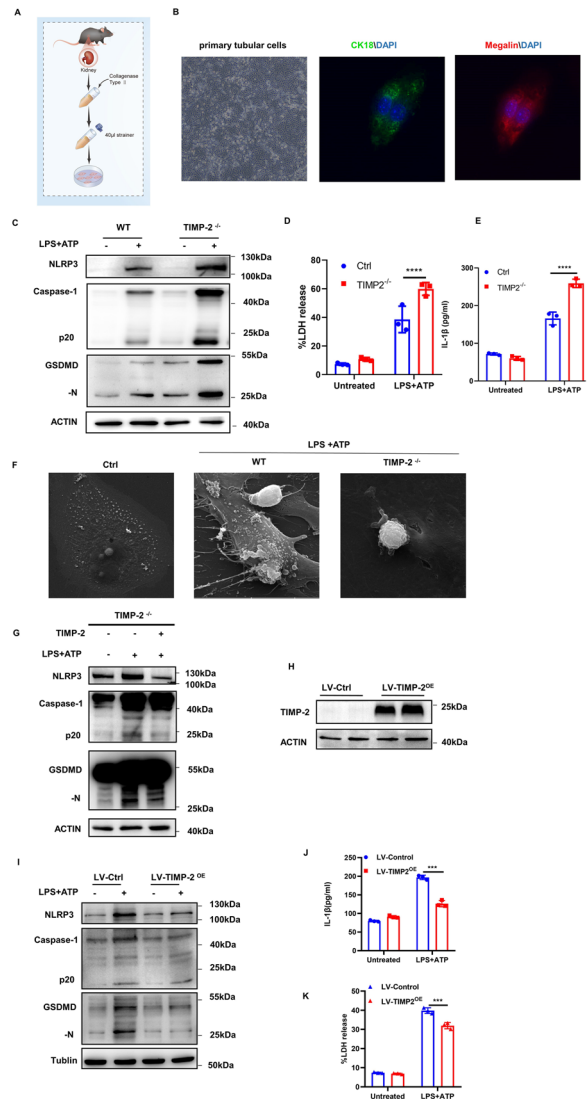
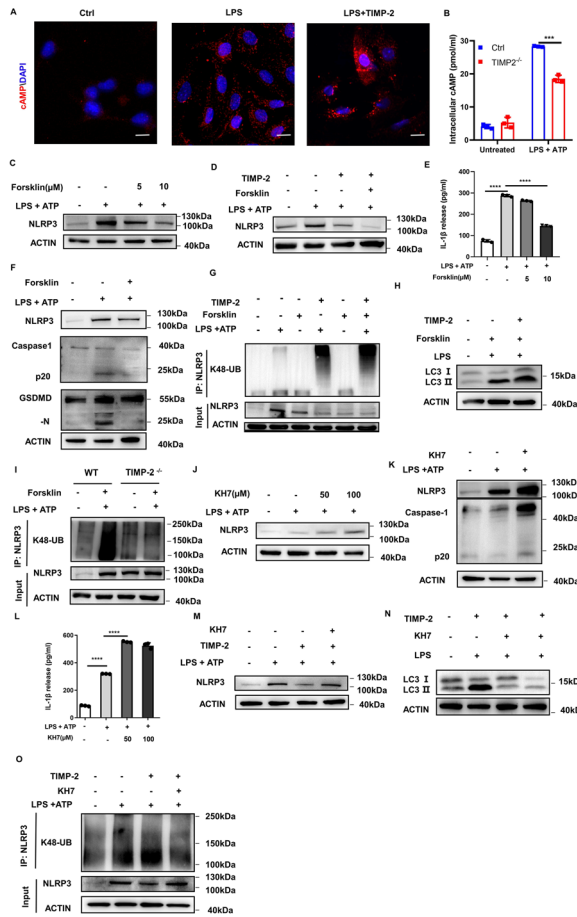

Figure 6 (abstract 000027) TIMP-2 mitigated SA-AKI inflammation in vivo



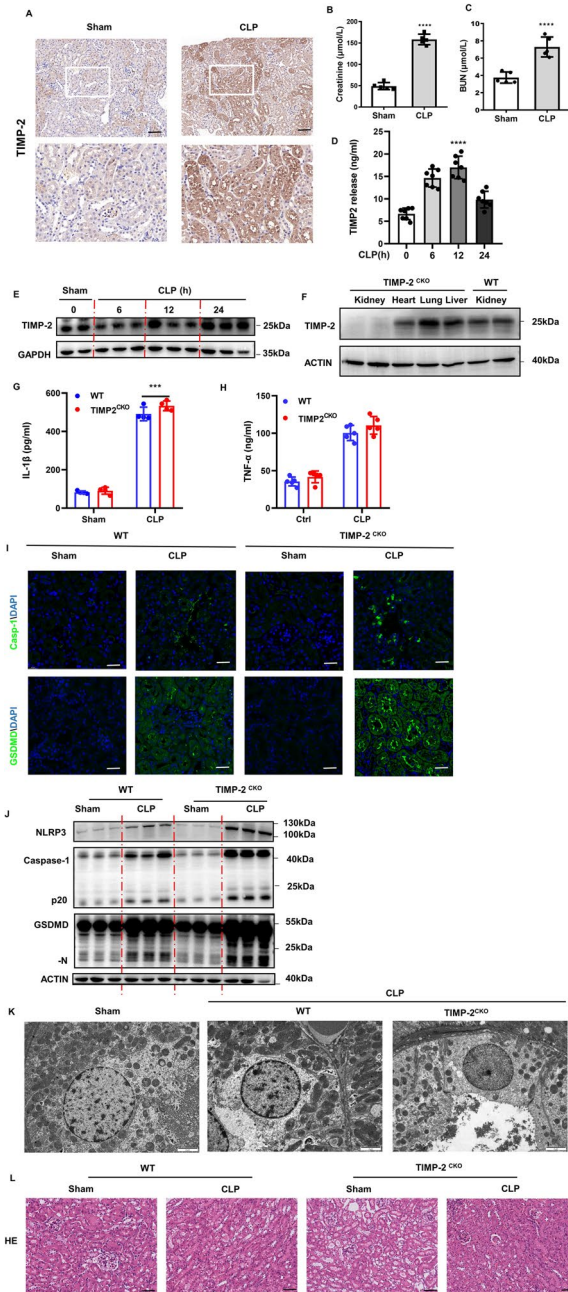

Figure 1 (abstract 000027) Elevation of TIMP-2 in SA-AKI was associated with tubular pyroptosis

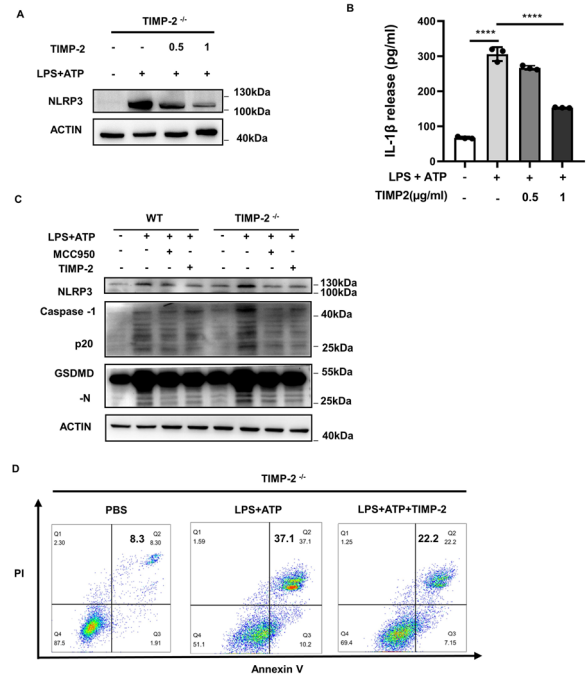

Figure 3 (abstract 000027) Extracellular TIMP-2 repressed NLRP3 inflammasome activation in vitro

References

1. Bergsbaken, T., S.L. Fink, and B.T. Cookson, Pyroptosis: host cell death and inflammation. *Nat Rev Microbiol*, 2009. 7(2): p. 99–109.
2. Seo, D.W., et al., TIMP-2 mediated inhibition of angiogenesis: an MMP-independent mechanism. *Cell*, 2003. 114(2): p. 171–80.
3. Emler, D.R., et al., Insulin-like growth factor binding protein 7 and tissue inhibitor of metalloproteinases-2: differential binding expression and secretion in human kidney tubule cells. *Am J Physiol Renal Physiol*, 2017. 312(2): p. F284-f296.
4. Kashani, K., et al., Discovery and validation of cell cycle arrest biomarkers in human acute kidney injury. *Crit Care*, 2013. 17(1): p. R25.
5. Bihorac, A., et al., Validation of cell-cycle arrest biomarkers for acute kidney injury using clinical adjudication. *Am J Respir Crit Care Med*, 2014. 189(8): p. 932–9.
6. Poston JT, Koyner JL: Sepsis associated acute kidney injury. *BMJ (Clinical research ed)* 2019;364: k4891
7. The authors confirmed no any conflicts of interest.

Topic: Acute Kidney Injury and haemofiltration.

000029

Impact of AMPA receptor antagonist for first onset seizure versus usual care in Neurosurgical intensive care unit, clinical outcome and safety aspects

P. Boontoterm¹, S. Sakoolnamarka¹, Y. Chinvarun¹, C. Udommongkol¹, K. Urasyanandana¹, P. Fuengfoo¹, A. Puvichitsutin²

¹Surgery, Phramongkutklo Hospital, Bangkok, Thailand; ²Pharmacology, NeuroPharmacology, Bangkok, Thailand

Correspondence: P. Boontoterm

Intensive Care Medicine Experimental 2023, 11(Suppl 1):000029

Introduction. Seizure increased mortality rates in Neurosurgical intensive care unit, it is important to achieve seizure control in these patients. AMPA receptor (perampanel therapy) was known novel target for focal-onset seizures, with or without focal to bilateral tonic-clonic seizures, and generalized tonic-clonic seizures. This study collected efficacy and safety information on clinically important treatment-emergent adverse events of perampanel as monotherapy.

Objectives. To study efficacy and safety information on clinically important treatment-emergent adverse events of perampanel as monotherapy.

Methods. This study is prospective interventional study. Data from all 64 patients were assigned to perampanel as monotherapy (intervention, n=26) and usual care (control, n=38). Predefined clinical outcomes were assessed by proportions of individuals with a reduction in seizure frequency of 50% (50% responder rate) in 28 days. Both groups were retrieved during December 1st, 2020 to November 30th, 2022, comparing perampanel group with usual care. Treatment outcome included retention rate, responder, and seizure-free rate at observational point 28 days, and 6 months. Treatment-emergent adverse events and adverse drug reactions were recorded.

Results. There was no difference in baseline characteristics and no difference in overall incidence of treatment-emergent adverse events and adverse drug reactions. between 2 groups. The median perampanel dosage was 4 mg (range 2-8 mg). Compared to usual care, perampanel group had proportions of individuals with a reduction in seizure frequency of 50% (50% responder rate) at 28 days, and 6 months significantly were 69% and 77% and 61% and 53% respectively and more 50% seizure frequency reduction in 28 day (Hazard ratio 1.4, p=0.001) and no difference in ICU length of stay, ventilator free day. Common AEs were dizziness and somnolence.

Conclusions. Perampanel as monotherapy in neurosurgical intensive care unit showed good effectiveness and safety profile. Low dosage helped to minimize the impact of adverse effects, maximize adherence, and increase patient retention.

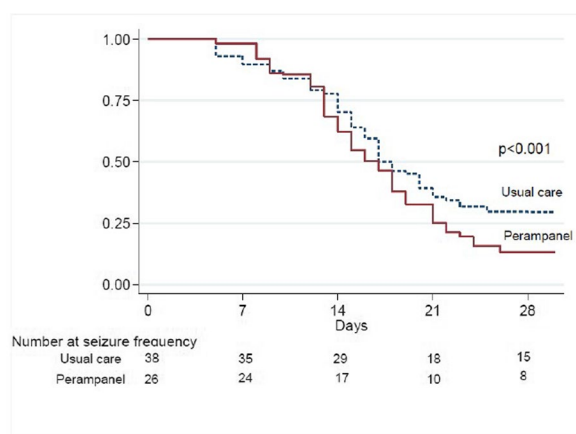

Hazard ratio 1.4, p<0.001
Value presented as median. P-value analyzed using the Kaplan-Meier survival estimates.

Figure 1 (abstract 000029) Primary outcome in proportions of individuals with a reduction in seizure frequency of 50% (50% responder rate at 28 days)

Table 1 (abstract 000029) Demographic data of each group classify in preampanel and usual care group

	Perampanel (n=26)	Usual care (n=38)	p-value
Male	12 (46.7%)	24 (64.1%)	0.249
Age (year)	65.8 ± 14.62	59.5 ± 14.18	0.086
Body weight (kg)	63.1 ± 8.47	59.3 ± 9.16	0.921
BMI (kg/m ²)	19.23 ± 2.84	18.18 ± 2.91	0.949
Seizure frequency per month, median (min. max)	(1.4), 2.5	(1.3), 1.5	0.25
Focal seizures, n (%)			
Focal onset with awareness	21 (80%)	25 (65%)	0.480
Focal onset with impaired awareness	13 (50%)	15 (40%)	0.751
Evolving to bilateral tonic-clonic seizure	5 (20%)	10 (25%)	1
Etiology not known	3 (10%)	2 (5%)	0.231
Etiology known			
Cranial trauma	8 (30%)	7 (18.4%)	0.065
Cerebrovascular	9 (35%)	15 (39%)	1
Neurodegenerative	2 (7.7%)	4 (10.5%)	0.605
Cerebral neoplasm	2 (7.7%)	4 (10.5%)	0.231
Malformations of cortical development	1 (4%)	2 (5%)	0.906
Mesial temporal sclerosis	1 (4%)	1 (2.6%)	0.762
Hippocampal atrophy	1 (4%)	2 (5%)	0.843
AVM	1 (4%)	1 (2.6%)	0.864
Other	1 (4%)	2 (5%)	0.968

Value presented as mean±SD. p-value analyzed using Chi-square test.

Table 2 (abstract 000029) Baseline characteristics comparison seizure status, treatment-emergent adverse event and secondary outcomes between two patients

	Perampanel (n=26)		Usual care (n=38)		p-value	
	28 days	6 months	28 days	6 months	28 days	6 months
Retention rates	23 (88%)	17 (65%)	32 (84%)	22 (58%)	0.48	0.51
50% responder rate	18 (69%)	20 (77%)	23 (61%)	20 (53%)	0.026*	0.010*
Seizure-free status	17 (65%)	16 (61%)	22 (58%)	19 (50%)	0.017*	0.048*
ICU length of stay	10 (8, 12)	NA	12 (10, 14)	NA	0.739	NA
Ventilator free day	8 (6, 10)	NA	10 (8, 12)	NA	0.598	NA
Treatment-emergent adverse event (TEAEs)						
Any AEs	8 (30%)	7 (27%)	12 (31%)	11 (29%)	0.273	0.228
Serious AEs	0	0	0	0	NA	NA
Severe AEs	0	0	0	0	NA	NA
Death	0	0	0	0	NA	NA
Discontinuation due to AEs	1 (3.8%)	1 (3.8%)	4 (10%)	3 (7.9%)	1	0.75
Incidence of individual AEs						
Dizziness	6 (23%)	5 (19%)	9 (23%)	8 (21%)	0.78	0.61
Somnolence	3 (11%)	4 (15%)	4 (10%)	3 (7.9%)	0.66	0.73
Ataxia	2 (7.7%)	1 (3.8%)	3 (7.9%)	4 (10%)	0.34	0.49
Dry mouth	1 (3.8%)	1 (3.8%)	3 (7.9%)	2 (5.3%)	0.89	0.52
Depression	1 (3.8%)	1 (3.8%)	3 (7.9%)	4 (10%)	0.92	0.67
Confusion	0 (0%)	1 (3.8%)	2 (5.3%)	1 (2.6%)	0.46	0.37

Value presented as mean. p-value analyzed using Mann-Whitney test and Chi-square test. Abbreviation: AEs, Adverse effects; TEAE, Treatment-emergent adverse event.

References

- Chinvarun Y. A retrospective, real-world experience of perampanel monotherapy in patient with first new onset focal seizure: A Thailand experience. *Epilepsia Open*. 2022 Mar;7(1):67–74.
- St Louis EK, Rosenfeld WE, Bramley T. Antiepileptic drug monotherapy: the initial approach in epilepsy management. *Curr Neuropharmacol*. 2009;7:77–82.
- Namba T, Morimoto K, Sato K, Yamada N, Kuroda S. Antiepileptogenic and anticonvulsant effects of NBQX, a selective AMPA receptor antagonist, in the rat kindling model of epilepsy. *Brain Res*. 1994;638:36–44.
- Jones RM, Butler JA, Thomas VA, Peveler Rc, Prevet M. Adherence to treatment in patients with epilepsy: associations with seizure control and illness beliefs. *Seizure*. 2006;15:504–8.
- Gao L, Xia L, Pan SQ, Xiong T, Li SC. Burden of epilepsy: a prevalence-based cost of illness study of direct, indirect and intangible costs for epilepsy. *Epilepsy Res*. 2015;110:146–56.

6. Abril Jaramillo J, Estevez Maria JC, Giron Ubeda JM, Vega López Ó, Calzado Rivas ME, Pérez Díaz H, et al. Effectiveness and safety of perampanel as early add-on treatment in patients with epilepsy and focal seizures in the routine clinical practice: Spain prospective study (PERADON). *Epilepsy Behav.* 2020;102:106,655.
7. French JA, Krauss GL, Steinhoff BJ, Squillacote D, Yang H, Kumar D, et al. Evaluation of adjunctive perampanel in patients with refractory partial-onset seizures: results of randomized global phase III study 305. *Epilepsia.* 2013;54:117–25.
8. French JA, Krauss GL, Biton V, Squillacote D, Yang H, Laurenza A, et al. Adjunctive perampanel for refractory partial-onset seizures: randomized phase III study 304. *Neurology.* 2012;79:589–96.
9. Food and Drug Administration (FDA). Fycompa1 Prescribing Information. Food and Drug Administration (FDA); July 2017.
10. Chen Z, Brodie MJ, Liew D, Kwan P. Treatment outcomes in patients with newly diagnosed epilepsy treated with established and new antiepileptic drugs. *JAMA Neurol.* 2018;75(3):279–86.
11. My grateful thanks to Mrs Dollapas Panpanich for her helpful doing the data analysis, and extend to the staff of the surgical and medical intensive care unit of Phramongkutklao hospital for their help in offering me the resources in running the study.

Topic: Neurointensive care.

000030

Clinical outcome and safety of Neuromodulation for neurological recovery after traumatic brain injury and stroke in Neurosurgical intensive care unit

P. Boontoterm¹, S. Sakoolnamarka¹, C. Udommongkol¹, K. Urasyanandana¹
¹Surgery, Phramongkutklao Hospital, Bangkok, Thailand

Correspondence: P. Boontoterm

Intensive Care Medicine Experimental 2023, **11(Suppl 1)**:000030

Introduction. Traumatic brain injury and stroke lead to a brain dysfunction and complex neurological sequelae despite aggressive surgical intervention and secondary brain injury prevention. However, alternative neuromodulation therapies can be a potential modality. Cerebrolysin is the drug which contains peptides derived from the brain of a pig that has potential neuroprotective properties and may help to protect and repair brain cells.

Objectives. To compare the efficacy and safety of Cerebrolysin with usual care.

Methods. Randomized single blind study from December 2016 to May 2022. 68 Subjects including all the adult patients with severe disability (GOS of 2 and 3) after trauma or stroke. Patients were classified to receive cerebrolysin (n=32) and usual care (n=36). Cerebrolysin was administered intravenously in 30 mL dosage daily for 21 days. The 6-month NIHSS, Barthel Index and modified Rankin Scale were recorded. The outcome scales, safety and complications were compared between two study groups.

Results. Baseline characteristics were comparable between two groups. We found that NIHSS and modified Rankin Scale were significantly lower in those receiving cerebrolysin [6.40 ± 2.13 vs 10.02 ± 3.75 (p=0.013) and 2.34 ± 0.11 vs 3.2 ± 0.46 (p=0.048)] and Barthel Index was significantly higher in those receiving cerebrolysin [77.23 ± 11.71 vs 68.82 ± 9.63 (p=0.025)]. Cerebrolysin administration was associated with lower mortality rate, and no significant in seizure, cardiovascular complication, recurrent ischemic stroke and intracerebral hemorrhage.

Conclusions. Cerebrolysin administration is associated with improved functional neurorecovery and increased favorable outcome.

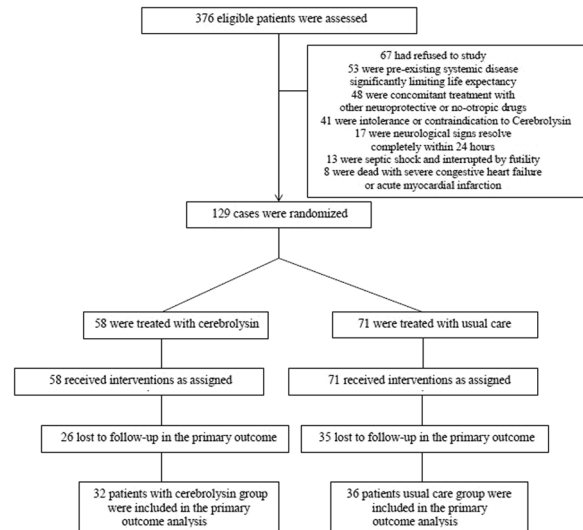

Figure 1 (abstract 000030) Flow chart of patient enrollment and analysis in this study

Table 1 (abstract 000030) Baseline characteristics comparison between two patient groups

Variables	Cerebrolysin (n=32)	Usual care (n=36)	p-value
Male, n (%)	14 (43.8)	16 (44)	1.0
Age (yr)	70 ± 12	62 ± 15	0.16
BMI (kg/m ²)	22.7 ± 3.4	22.0 ± 2.1	0.58
Coexisting diseases, n (%)			
HT	13 (40.6)	16 (44.4)	0.480
DLP	8 (25)	10 (27.8)	0.751
DM	8 (25)	10 (27.8)	0.751
CKD	2 (6.3)	3 (8.3)	0.65
chronic liver disease	2 (6.3)	3 (8.3)	0.65
CAD	2 (6.3)	1 (2.8)	0.106
Smoking	8 (25)	10 (27.8)	0.751
Alcohol	2 (6.3)	3 (8.3)	0.65
Thrombolysis treatment	2 (6.3)	3 (8.3)	0.65
ASPECTS score (median)	5	6	0.63
NIHSS score	13.1 ± 4.59	14.15 ± 5.30	0.8
APACHE II Score	12.7 ± 1.95	12.65 ± 2.23	0.940
Time until admission (hr)	11.59 ± 3.25	11.81 ± 3.301	0.381
Time until treatment (hr)	13.1 ± 4.10	13.30 ± 4.95	0.741
Dominant lobe	16 (50)	18 (50)	1
BI score	31 ± 2.93	37.5 ± 2.25	0.56
mRS score	3.75 ± 0.29	4.5 ± 0.27	0.15
Survival at hospital admission	16 (80)	13 (65)	0.480
Pulmonary complication	2 (10)	1 (5)	0.231
Seizure complication	11 (34.4)	13 (36.1)	0.598
Cardiovascular complication	7 (21.9)	9 (25)	0.559
Recurrent ischemic stroke	2 (6.3)	3 (8.3)	0.64
Recurrent intracerebral hemorrhage	1 (5)	3 (8.3)	0.3
Means days in neuro intensive care unit	5	6	0.63

Table 2 (abstract 000030) Baseline characteristics comparison between two patient groups in specific condition

Variables	Cerebrolysin (n=32)	Usual care (n=36)	p-value
Acute hemispheric ischemic stroke	11 (34.4)	14 (38.9)	0.592
- Right MCA or ICA infarction	7 (21.9)	9 (25)	0.447
- Left MCA or ICA infarction	4 (12.5)	5 (13.9)	0.584
Acute hemorrhagic stroke	13 (40.6)	15 (41.7)	0.139
- Right Basal ganglion	4 (12.5)	5 (13.9)	0.584
- Left Basal ganglion	2 (6.25)	3 (8.3)	0.630
- Right Thalamic	1 (3.1)	1 (2.8)	1.000
- Left Thalamic	1 (3.1)	1 (2.8)	1.000
- Right cerebellar	1 (3.1)	1 (2.8)	1.000
- Left cerebellar	1 (3.1)	1 (2.8)	1.000
- Lobar	2 (6.25)	1 (2.8)	0.980
- Brainstem	1 (3.1)	2 (5.6)	0.849
Traumatic Brain injury	8 (25)	7 (19.4)	0.965
- Acute subdural hematoma	3 (9.4)	4 (11.1)	0.776
- Acute Epidural hematoma	2 (6.25)	1 (2.8)	0.106
- Traumatic intracerebral hemorrhage anywhere	1 (3.1)	1 (2.8)	1.000
- Others traumatic brain injury	2 (6.25)	1 (2.8)	0.106

Value presented as n (%). P-value corresponds to Independent-t test and Fisher's exact test. Abbreviations: ICA, Internal carotid artery; MCA, Middle cerebral artery; Others traumatic brain injury, Diffuse axonal injury, Traumatic subarachnoid hemorrhage, Combination of Traumatic intracerebral hemorrhage.

Table 3 (abstract 000030) Comparison of outcome assessment pre- and post-therapy between two patient groups at 6 month follow-up

Variables	Cerebrolysin (n=32)	Usual care (n=36)	p-value
Pre-NIHSS score	13.1 ± 4.59	14.15 ± 5.30	0.8
Post-NIHSS score	6.40 ± 2.13	10.02 ± 3.75	0.013
Pre-BI score	31 ± 2.93	37.5 ± 2.25	0.56
Post-BI score	77.23 ± 11.71	68.82 ± 9.63	0.025
Pre-mRS score	3.75 ± 0.29	4.5 ± 0.27	0.15
Post-mRS score	2.34 ± 0.11	3.2 ± 0.46	0.048
Survival after hospital discharge at 6 month	19 (59.4)	10 (27.8)	<0.001
Seizure complication at admission	11 (34.4)	13 (36.1)	0.598
Seizure complication after discharge	15 (46.9)	18 (50)	0.291
Cardiovascular complication at admission	7 (21.9)	9 (25)	0.559
Cardiovascular complication after discharge	8 (25)	10 (27.8)	0.751
Recurrent ischemic stroke	2 (6.3)	3 (8.3)	0.64
Recurrent ischemic stroke after discharge	6 (18.8)	7 (19.4)	0.754
Recurrent intracerebral hemorrhage	1 (5)	3 (8.3)	0.3
Recurrent intracerebral hemorrhage after discharge	2 (6.3)	4 (11.1)	0.45

Value presented as mean ± SD, or n (%). P-value corresponds to ANOVA. Abbreviations: ANOVA, analysis of variance; BI, Barthel Index; mRS, modified Rankin Scale; NIHSS, National Institute of Health Stroke Scale; SD, standard deviation.

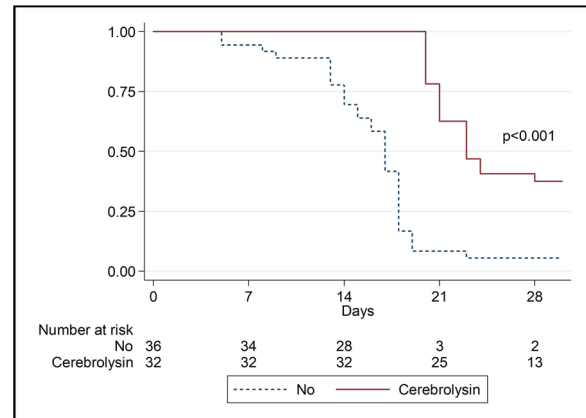
**Figure 2 (abstract 000030)** Primary outcome in proportions of individuals with cox regression analysis: 28th day Mortality

References

- Khalili H, Niakan A, Ghaffarpasand F. Effects of cerebrolysin on functional recovery in patients with severe disability after traumatic brain injury: A historical cohort study. *Clin Neurol Neurosurg.* 2017 Jan;152:34–38.
- Chemer N, Bilanovskiy V. Cerebrolysin as a New Treatment Option for Post-Stroke Spasticity: Patient and Physician Perspectives. *Neurol Ther.* 2019 Jun;8(1):25–27.
- Sharma HS, Muresanu DF, Sahib S, Tian ZR, Lafuente JV, Buzoianu AD, Castellani RJ, Nozari A, Li C, Zhang Z, Wiklund L, Sharma A. Cerebrolysin restores balance between excitatory and inhibitory amino acids in brain following concussive head injury. Superior neuroprotective effects of TiO₂ nanowired drug delivery. *Prog Brain Res.* 2021;266:211–267.
- Sharma HS, Muresanu DF, Castellani RJ, Nozari A, Lafuente JV, Buzoianu AD, Sahib S, Tian ZR, Bryukhovetskiy I, Manzhulo I, Menon PK, Patnaik R, Wiklund L, Sharma A. Alzheimer's disease neuropathology is exacerbated following traumatic brain injury. Neuroprotection by co-administration of nanowired mesenchymal stem cells and cerebrolysin with monoclonal antibodies to amyloid beta peptide. *Prog Brain Res.* 2021;265:1–97.
- My grateful thanks to the staff of the surgical and medical intensive care unit of Phramongkutklao hospital for their help in offering me the resources in running the study.
- Talypov AE, Myachin MY, Kuksova NS, Kordonsky AY. [Cerebrolysin in the treatment of brain injuries of moderate severity]. *Zh Nevrol Psikhiatr Im S S Korsakova.* 2014;114(11):98–106.
- Chen CC, Wei ST, Tsaia SC, Chen XX, Cho DY. Cerebrolysin enhances cognitive recovery of mild traumatic brain injury patients: double-blind, placebo-controlled, randomized study. *Br J Neurosurg.* 2013 Dec;27(6):803–7.
- Zhang L, Chopp M, Wang C, Zhang Y, Lu M, Zhang T, Zhang ZG. Prospective, double blinded, comparative assessment of the pharmacological activity of Cerebrolysin and distinct peptide preparations for the treatment of embolic stroke. *J Neurol Sci.* 2019 Mar 15;398:22–26.

9. Poon W, Vos P, Muresanu D, Vester J, von Wild K, Hömberg V, Wang E, Lee TM, Matula C. Cerebrolysin Asian Pacific trial in acute brain injury and neurorecovery: design and methods. *J Neurotrauma*. 2015 Apr 15;32(8):571–80.
10. Lucena LLN, Briones MVA. Effect of Cerebrolysin in severe traumatic brain injury: A multi-center, retrospective cohort study. *Clin Neurol Neurosurg*. 2022 Mar 23;216:107216.
11. Zhang, Y, Chopp, M., Zhang, Y., Gang Zhang, Z., Lu, M., Zhang, T., Wu, K. H., Zhang, L., Mahmood, A., & Xiong, Y. (2020). Randomized controlled trial of Cerebrolysin's effects on long-term histological outcomes and functional recovery in rats with moderate closed head injury. *Journal of Neurosurgery*, 133(4), 1072–1082.

Topic: Neurointensive care.

000031

Evaluation of post-operative handover practices for critically ill patients between surgical teams and intensive care unit: an audit

S. A. Abbas¹, K. Ferenc²

¹Urology, London North West University Healthcare NHS Trust, Luton, United Kingdom; ²Intensive care unit, North Middlesex University Hospital, London, United Kingdom

Correspondence: S.A. Abbas

Intensive Care Medicine Experimental 2023, **11(Suppl 1)**:000031

Introduction. Patient handovers are crucial for the continuity of care and patient safety. Several studies have linked inadequate handovers between healthcare professionals to medical errors and patient harm [1,2,3,4,5,6]. Guidelines from the Royal College of Surgeons of England and the National Institute for Health and Care Excellence (NICE) recommend the use of structured handovers to improve communication and patient outcomes [7,8]. There is limited data available on handovers received between the operating room (OR) and the intensive care unit (ICU) [9]. This study aims to evaluate the quality of post-operative handovers provided by surgical teams to the ICU for critically ill patients being moved from the OR to the ICU.

Objectives. The objectives of this audit were to investigate current handover practices of surgical teams for patients being admitted to the ICU immediately post-surgery and to observe if NICE guidelines for structured handovers during patient transitions between specialities were being met.

Methods. A cross-sectional study was conducted to evaluate handover practices of surgical teams for patients admitted to ICU for post-operative care at a university teaching hospital in the United Kingdom. A sample size of 20 patients was selected for the audit using simple random sampling, and the study period was from December 2022 to February 2023. ICU doctors were asked to track the handovers provided by the surgical teams whenever post-operative patients were received in the department. Documented post-operative orders on electronic patient records were considered equivalent to written handovers. The required data were gathered from the EPR of patients enrolled in the audit, and a structured audit tool was developed to collect the data. Categorical data were analysed using IBM SPSS.

Results. The surgical teams provided handover to ICU for only 5% (1) of the 20 patients admitted to the ICU immediately post-procedure for observation and management. For the other 95% (19) patients, ICU did not receive a direct handover from the surgical teams. Of the 65% (13) patients who required antibiotics post-procedure, the duration of antibiotic treatment was only specified for 30% (6), and 35% (7) did not have any duration specified. Similarly, 80% (16) of the patients were allowed to have venous thromboembolism (VTE) prophylaxis post-procedure, but only 85% (17) had time-specific instructions documented for when the patient could receive VTE prophylaxis. Regarding feeding instructions, only 15% (3) of the patients had a specified time to restart feeding, while 50% (10) had no specified time documented. The type of diet was only specified for 55% (11) of the patients. Moreover, expected drain output was specified for only 5% (1) of the patients,

and 75% (15) had no comments on drain output in the post-op surgical instructions. Table 1 provides a brief summary of the results.

Conclusions. This audit reveals that there are significant gaps in the post-operative handover practices of surgical teams for critically ill patients being moved from the OR to the ICU. Inadequate handovers can lead to medical errors, delays in treatment, and patient harm. Structured handovers using guidelines such as those provided by NICE, and the World Health Organization can improve communication and patient outcomes. There is a need for further education and training of healthcare professionals to ensure that effective handovers are provided for patients being transferred between specialities.

Table 1 (abstract 000031) Summary of the Audit Results

Criteria	Met Standard
Surgical Team Provided Handover	1/20 (5.0%)
Patient Require Antibiotics, Post-Procedure	13/20 (65.0%)
Duration of Antibiotics Treatment Specified	7/20 (35.0%)
Patient to have VTE prophylaxis	16/20 (80.0%)
Instructions Provided Regarding VTE	17/20 (85.0%)
Instructions When Patient Could Resume Feeding	13/20 (65.0%)
Feeding Time Specified	3/20 (15.0%)
Feeding Route Specified NG/Oral/ PEJ/TPN	13/20 (65.0%)
Type of Diet Specified? Clear liquid/soft/regular	11/20 (55.0%)
Instructions Regarding Drains	4/20 (20.0%)
Site(s) of the Drain Specified	4/20 (20.0%)
Expected Drain Output Specified	1/20 (5.0%)

References

1. Krimminger D, Sona C, Thomas-Horton E, Schallom M. A Multidisciplinary QI Initiative to Improve OR-ICU Handovers. *Am J Nurs*. 2018 Feb;118(2):48–59. <https://doi.org/10.1097/01.NAJ.0000530248.45711.60>. PMID: 29,369,877.
2. Faiz T, Saeed B, Ali S, Abbas Q, Malik M. OR to ICU handoff: theory of change model for sustainable change in behavior. *Asian Cardiovasc Thorac Ann*. 2019 Jul;27(6):452–458. <https://doi.org/10.1177/0218492319850730>. Epub 2019 Jun 12. PMID: 31,189,326.
3. Emergency and acute medical care in over 16 s: service delivery and organisation. NICE guideline [NG94] Published: 28 March 2018. <https://www.nice.org.uk/guidance/ng94>.
4. The Royal College of Surgeons Good Surgical Practice <https://www.rcseng.ac.uk/standards-and-research/gsp/domain-3/3-4-continuity-and-coordination-of-care/>
5. Kitch BT, Cooper JB, Zapol WM, Marder JE, Karson A, Hutter M, Campbell EG. Handoffs causing patient harm: a survey of medical and surgical house staff. *Jt Comm J Qual Patient Saf*. 2008;34(10):563–70.
6. Arora V, Johnson J, Lovinger D, Humphrey HJ, Meltzer DO. Communication failures in patient sign-out and suggestions for improvement: a critical incident analysis. *Qual Saf Health Care*. 2005;14(6):401–7. <https://doi.org/10.1136/qshc.2005.015107>
7. Apker J, Mallak LA, Gibson SC. Communicating in the “gray zone”: perceptions about emergency physician hospitalist handoffs and patient safety. *Acad Emerg Med*. 2007;14(10):884–94. <https://doi.org/10.1197/jaem.2007.06.037>.
8. Riesenber LA, Leitzsch J, Cunningham JM. Nursing handoffs: a systematic review of the literature. *Am J Nurs*. 2010;110(4):24–34. <https://doi.org/10.1097/01.NAJ.0000370154.79857.09>.
9. Milby A, Böhmer A, Gerbershagen MU, Joppich R, Wappler F. Quality of post-operative patient handover in the post-anaesthesia care unit: a prospective analysis. *Acta Anaesthesiol Scand*. 2014;58(2):192–7. <https://doi.org/10.1111/aas.12249>.
10. World Health Organisation. WHO Collaborating Centre for Patient Safety Solutions. Communication during Patient Handovers. In: Patient Safety Solutions. vol. 1: World Health Organisation; 2007.

Topic: Perioperative care.

000033

Adaptive feeding could be a prelude of enteral nutrition for severe burns

W. Beiwen¹, Q. Zhang²

¹Nursing Department of Ruijin Hospital, School of Medicine, Shanghai Jiaotong University, Nursing Department of Ruijin Hospital, School of Medicine, Shanghai Jiaotong University, Shanghai, China; ²Burn and Plastic Department, Ruijin Hospital, Shanghai, China

Correspondence: Q. Zhang

Intensive Care Medicine Experimental 2023, **11(Suppl 1)**:000033

Introduction. Enteral nutrition as soon as possible in patients with severe burns is an important treatment to improve prognosis, but the pursuit of adequate gastrointestinal nutrition as soon as possible is considered harmful. In order to find out how critically ill burn patients can adapt more quickly to enteral nutrition, this study used retrospective cohort study to analyze the main reasons that influenced physicians to make two different decisions about complete fasting or adaptive feeding (feeding less than 30 ml water) for patients with severe burns from the medical history data of patients with severe burns in the past 11 years, and analyzed whether adaptive feeding in the first 24 h after injury was an appropriate pilot method.

Objectives. In order to find out how critically ill burn patients can adapt more quickly to enteral nutrition, this study used retrospective cohort study to analyze the main reasons that influenced physicians to make two different decisions about complete fasting or adaptive feeding (feeding less than 30 ml water) for patients with severe burns from the medical history data of patients with severe burns in the past 11 years, and analyzed whether adaptive feeding in the first 24 h after injury was an appropriate pilot method.

Methods. This study conducted a retrospective cohort study of inpatients in the burn center of Ruijin Hospital from January 1, 2009 to December 31, 2020. The patient population in this study was hospitalized with burns greater than 30%. The general information of the patients, the burn wound situation, the main causes of burns: flame, non-flame (thermal, chemical, electrical burns, etc.), whether there was inhalation injury, the occurrence of gastrointestinal adverse reactions after the start of gastrointestinal nutrition, and the indicators of patient outcome were studied separately.

Results. In this study, multiple regression analysis was used to find that the size of the third-degree burn area (standard regression coefficient 0.106, standard error 0.197, t-value 3.060, $P=0.002$) and whether there was inhalation injury (standard regression coefficient 0.141, standard error 0.202, t-value 2.299, $P=0.022$) within 24 h after injury of patients with large-scale burns were the main determinants of complete fasting or adaptive drinking of water. Further analysis of the main factors affecting the initiation of adaptive drinking within 24 h after injury in patients with severe burns and inhalation injury found that there were no significant differences in age, sex, BMI, total burn area, third-degree burn area, and whether the cause of the burn was flame. Complete fasting and initiation of adaptive drinking water 24 h after injury in patients with inhalation injury had no significant effect on the final treatment outcome, mortality at 28 days after injury, and the occurrence of bloodstream infection and catheter infection 0.05. There was no significant difference in the incidence of gastrointestinal nutritional intolerance between the fasting group and the adaptive drinking group in patients with inhalation injury ($X^2=2.679$, $P=0.102$).

The study further analyzed whether patients with large third-degree burn wounds could not receive adaptive drinking water for sufficient reasons. The study found that there was no difference in age, sex, BMI, total burn area, and whether inhalation injury was combined between the two groups of patients with fasting or adaptive drinking water, while the final survival rate of patients in the adaptive drinking group was significantly higher (6.94%, 16.32%, $X^2=3.869$, $P=0.049$). The incidence of positive blood cultures ($X^2=4.905$, $P=0.027$) and the incidence of positive sputum cultures 14 days after injury ($X^2=8.153$, $P=0.004$).

Conclusions. From this study found that physicians made complete fasting or adaptive drinking decisions for patients with severe burns and inhalation injury, regardless of age, sex, pre-injury BMI, burn cause, burn area, and third-degree burn area were not the main influencing factors, and the administration of adaptive drinking water did not cause increased risk of treatment. Analysis showed that the overall mortality, bloodstream infection, respiratory tract infection and catheter infection in the adaptive drinking group were lower and the onset time was later. Therefore, early adaptive drinking water can be used as a leading nutritional method for severe burns and severe burns combined with inhalation injury, and improving gastrointestinal function is an important measure to improve the success rate of treatment of severe burns.

Topic: Nursing care and physiotherapy.

000036

Furosemide stress test (FST) 2.0-Combining FST with the persistent AKI biomarker CCL14 improves the prediction of absolute indications for renal replacement therapy in a postsurgical cohort of critically ill patients

R. Weiss¹, M. Meersch¹, J. Gerss², F. Albert², J. Gruber¹, M. Sadjadi¹, J. A. Kellum³, L. Forri⁴, L. Chawla⁵, J. L. Koyner⁶, T. von Groote¹, A. Zarbock¹

¹Department of Anaesthesiology, Intensive Care and Pain Medicine, Münster University Hospital, Münster, Germany; ²Institute of Biostatistics and Clinical Research, University of Münster, Münster, Germany;

³Center for Critical Care Nephrology, Department of Critical Care Medicine, University of Pittsburgh, Pittsburgh, United States of America;

⁴Department of Intensive Care Medicine, Royal Surrey Hospital and Faculty of Health Sciences, University of Surrey, Guildford, United Kingdom;

⁵Department of Medicine, Veterans Affairs Department, San Diego, United States of America; ⁶Section of Nephrology, Department of Medicine, University of Chicago, Chicago, United States of America

Correspondence: T. von Groote

Intensive Care Medicine Experimental 2023, **11(Suppl 1)**:000036

Introduction. Prediction and timing of renal replacement therapy (RRT) initiation in acute kidney injury (AKI) remains a challenge for intensivists. The furosemide stress test (FST) has been suggested as a clinical tool to predict persistent AKI with high accuracy. (1, 2) Alternatively, persistent AKI or future requirement for RRT may be predicted using renal biomarkers. Recently, urinary c-motif chemokine ligand (CCL) 14 demonstrated prediction of persistent AKI in patients with moderate AKI, AUC of 0.83 (0.78–0.87) in the critical care setting and 0.92 (95% CI, 0.86–0.97) in the cardiac surgery setting. (3, 4).

Objectives. We investigate whether the combination of FST with a renal biomarker predicts the development of absolute indications for RRT.

Methods. A prospective, single-center, observational study, conducted at the University Hospital of Münster (Germany). Critically ill patients who received an FST in the setting of both stage 2 AKI and a predefined clinical risk factor (requirement of vasopressors and/or mechanical ventilation) were included. Patients with advanced CKD (eGFR < 20 ml/min/1.73 m²) or chronic dialysis dependency were excluded. FST was performed using 1.0 mg furosemide intravenously/kg body weight in diuretic-naïve and 1.5 mg/kg in diuretic pre-treated patients (1).

Urinary and blood sample collection and measurement of biomarkers (CCL14, NGAL, DPP3) was performed immediately prior to FST. The primary endpoint was the development of one or more pre-defined RRT indications: hyperkalemia ($K^+ \geq 6$ mmol/l), diuretic-resistant hypervolemia, urea serum levels (≥ 150 mg/dl), severe metabolic acidosis ($pH \leq 7.15$), oliguria (urinary output < 200 ml/12h), or anuria.

Results. 208 patients were enrolled, of which 108 demonstrated a negative FST, defined as a urinary output of less than 200 ml within 2 h following the FST (Fig. 1).

Overall, 98 (47%) patients met the primary endpoint, with 82% in the FST negative cohort. The combination of a negative FST test with

higher urinary CCL14 level had a significantly higher predictive value for the primary endpoint with an area under the receiver operating characteristic curve (AUROC) of 0.87 (95%CI, 0.82–0.92), compared to FST or CCL14 alone (AUC 0.79 (95%CI, 0.74–0.85), AUC 0.83 (95%CI, 0.77–0.89), $P < 0.001$, respectively). In subgroup analyses, other biomarkers showed lower AUCs in the FST negative group (Table 1).

Conclusions. The combination of the FST with a renal biomarker (CCL14) predicts the development of indications for RRT better than FST or CCL14 do in isolation. Application of such a combination may obviate the variability in application of RRT in critically ill patients with AKI with the associated high mortality rate and resource utilization. (5) Moreover, these results could also support future trials investigating the optimal time point of RRT initiation. To our knowledge, this is the first study that combines a renal stress test with novel renal biomarkers.

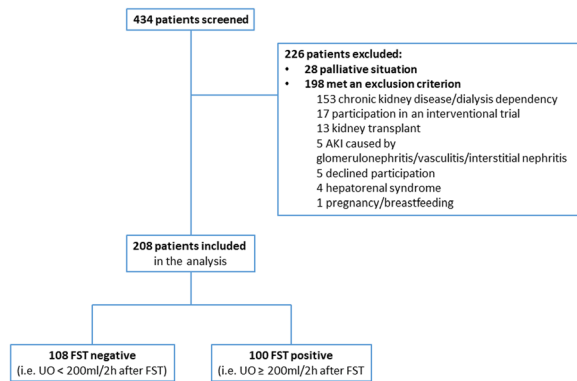

Biomarker	FST negative (UO < 200ml/2h), n=108	FST positive (UO ≥ 200ml/2h), n=100	P-value ^a
	AUC (95% CI)	AUC (95% CI)	
CCL-14	0.86 (0.77-0.94)	0.66 (0.52-0.80)	0.02
NGAL	0.72 (0.61-0.82)	0.72 (0.60-0.83)	0.98
DPP3	0.70 (0.57-0.83)	0.71 (0.57-0.84)	0.91

Abbreviations: AUC, area under the curve; CCL, C-motif chemokine ligand; DPP, dipeptidyl peptidase; FST, furosemide stress test; NGAL, neutrophil gelatinase associated lipocalin; UO, urine output

^a p-value for the AUC difference between FST negative and FST positive

References

- Chawla LS, Davison DL, Brasha-Mitchell E, et al. Development and standardization of a furosemide stress test to predict the severity of acute kidney injury. *Crit Care* 2013; 17: R207.
- Lumlertgul N, Peerapornratana S, Trakarnvanich T, Pet al. Early versus standard initiation of renal replacement therapy in furosemide stress test non-responsive acute kidney injury patients (the FST trial). *Crit Care* 2018; 22: 101.
- Hoste E, Bihorac A, Al-Khafaji A, et al. Identification and validation of biomarkers of persistent acute kidney injury: the RUBY study. *Intensive Care Med* 2020.
- Massoth C, Kullmar M, Enders D, et al. Comparison of C–C motif chemokine ligand 14 with other biomarkers for adverse kidney events after cardiac surgery. *Journal Thorac Cardiovasc Surg* 2021.
- Hoste EA, Bagshaw SM, Bellomo R, et al. Epidemiology of acute kidney injury in critically ill patients: the multinational AKI-EPI study. *Intensive Care Med* 2015; 41: 1411–1423.
- The trial was supported by the Interdisciplinary Center for Clinical Research of the University of Münster (Interdisziplinäres Zentrum für klinische Forschung, IZKF) (CST/004/22 to Melanie Meersch) and the German Research Foundation (Deutsche Forschungsgemeinschaft, DFG), (ME5413/1-1 to Melanie Meersch and ZA428/17-1 to Alexander Zarbock).

Topic: Acute Kidney Injury and haemofiltration.

000038

The Japan Sepsis Alliance study group looked at empiric antimicrobial use in patients with community-onset sepsis using data from a nationwide medical claims database

T. Abe¹, H. Iriyama¹, T. Imaeda², A. Komori¹, T. Oami², T. Aizimu², N. Takahashi², Y. Yamao², S. Nakagawa³, H. Ogura⁴, U. Yutaka⁴, A. Matsushima⁵, K. Fushimi⁶, N. Shime⁷, T. A. Nakada²

¹Department of Emergency and Critical Care Medicine, Tsukuba Memorial Hospital, 1187-299 Kaname, Tsukuba, Ibaraki, Japan, Tsukuba, Japan;

²Department of emergency and critical care medicine, Chiba University

Graduate School of Medicine, Chiba, Japan, Japan;

³Department of Critical Care Medicine, National center for children's health

and development, Setagaya City, Japan;

⁴Department of traumatology and acute critical medicine, Osaka University Graduate School

of medicine, Osaka, Japan;

⁵Department of Emergency & Critical Care, Nagoya City University Graduate School of Medical Sciences, Nagoya,

Aichi, Japan, Japan;

⁶Department of Health Policy and Informatics, Tokyo Medical and Dental University Graduate School of Medical and Dental

Sciences, Bunkyo, Tokyo, Japan, Japan;

⁷Department of emergency and critical care medicine, Graduate School of Biomedical and Health

Sciences, Hiroshima University, Hiroshima, Japan

Correspondence: T. Abe

Intensive Care Medicine Experimental 2023, **11(Suppl 1)**:000038

Introduction. Many clinicians may find it useful to investigate their experiences to do their next daily practice with a clear guide and evidence for choosing appropriate antimicrobials. The sepsis campaign guidelines, in contrast, recommend only early administration of appropriate broad-spectrum antimicrobials and covering drug-resistant pathogens if their infection is suspicious.

Objectives. We aimed to describe empiric antimicrobial choices for patients with community-onset sepsis using nationwide real-world data from Japan. We aimed to describe empiric antimicrobial choices for patients with community-onset sepsis using nationwide real-world data from Japan.

Methods. This is a retrospective cohort study that used nationwide data from Japan's medical reimbursement system. Patients were aged ≥ 20 years, had presumed infections and acute organ dysfunction, and were admitted to hospitals between 2010 and 2017. Only community-onset sepsis was chosen from among them. Then, we discussed the initial antimicrobial regimens for sepsis patients. We also classified sepsis patients who were admitted to the intensive care unit (ICU) or the ward.

Results. There were 1,195,741 people who had community-onset sepsis. Of those, 1,068,719 (89.4%) were admitted to wards, whereas 127,022 (10.6%) patients were admitted to the ICU. The participants' median age was 76 years (interquartile range: 60–84), and 55.9% were men. The lung was the most commonly infected site (38.0%), followed by the abdomen (15.7%), urinary tract (7.8%), and bone and soft tissues (5.3%).

Third-generation cephalosporins were the most commonly used antimicrobials (24.3%), followed by carbapenem (21.7%) and tazobactam/piperacillin (19.9%). In ICU, carbapenem was the most commonly used antibiotic (35.8%), followed by tazobactam/piperacillin (20.7%) and third-generation cephalosporins (16.4%); 7.7% of patients received combination therapy that excluded drug-resistant pathogens such as methicillin-resistant staphylococcus aureus (MRSA) or pseudomonas; 1.7% and 6.0% of patients initially used antimicrobials for MRSA coverage in the ward and ICU, respectively. Although antipseudomonal agents were initially used by half of the patients (47.1%), only 3.7% used antipseudomonal combinations (more than two antipseudomonal agents). Furthermore, 1.5% of patients initially used antimicrobial combinations to treat MRSA and pseudomonas.

Conclusions. Third-generation cephalosporins and carbapenem were the most commonly used as initial antimicrobials in the ward and ICU among patients with community-onset sepsis in Japan. Only a small

percentage of patients used antimicrobials to combat MRSA. Although antipseudomonal agents were initially given to half of the patients with community-onset sepsis, antimicrobial combination therapy for drug-resistant bacteria coverage was rarely given to patients with community-onset sepsis.

Topic: Sepsis.

000039

Proof of concept: use of a virtual reality game in rehabilitation of stroke patients in a tertiary hospital neuro intensive care unit (NICU) in Singapore

T. T. S. @ K. Cao¹, Y. L. Wong¹, S. R. Iqbal²

¹Anaesthesiology, Intensive Care and Pain Medicine, Tan Tock Seng Hospital, Singapore, Singapore; ²Physiotherapy, Tan Tock Seng Hospital, Singapore, Singapore

Correspondence: T.T.S.@K. Cao

Intensive Care Medicine Experimental 2023, **11(Suppl 1)**:000039

Introduction. Background: Patients with stroke make up the biggest proportion of admission to NICU. There are minimal physiotherapy (PT)-led rehabilitation activities currently in NICU. There is a potential to improve this by introducing virtual reality rehabilitation (VR) games for early mobilisation within the ICU. AHA/ASA recommends “range-of-motion activities, motor challenges and seated activities” within 24 h after stroke to prevent deconditioning and orthostatic intolerance. We hypothesize that the use of VR games in stroke patients in NICU would improve their muscle strength and frequency of physiotherapy.

Objectives. To estimate a change in muscle strength by Medical Research Council (MRC) grading.

1. To assess the residual disability post-ICU discharge using Modified Rankin Score (MRS) and Functional Status Score for ICU (FSS-ICU)

Methods. 20 patients with a diagnosis of stroke of pure motor/sensory type affecting the limbs, Glasgow Coma Scale (GCS) 14–15, Richmond Agitation Sedation Scale (RASS) – 1 to +1 were recruited. Eligible patients would use VR games to improve movement of upper and lower limbs daily under supervision of PT. The same PT reviewed the patients to assess MRC and FSS-ICU upon transfer out of the unit. The total number and duration of VR rehab sessions were recorded.

Results. 15 patients (75%) received 1 VR rehab in ICU, whereas 6 (30%) and 1 (5%) patient received 2 and 3 sessions, respectively. A total of 7 (35%), 9 (45%), and 4 (20%) patients received the first rehab session for 15, 20, and 25 min, respectively. On average, the total rehab duration was 27.5 min (Fig. 1). Majority of the patients (95%), returned to their pre-morbid status of physical mobility. 12 patients (60%) had improvement in MRS score at hospital discharge. 9 patients (45%) had improved motor strength of shoulder while 7 (35%) had improved motor strength of knee. FSS-ICU increased significantly at ICU discharge and hospital discharge (table 1).

Conclusions. Virtual Reality for early rehabilitation of stroke patients in the NICU is viable and shows promise.

References

1. Bruno, R.R. et al. Virtual Reality in intensive care. *Intensive Care Med* 4,1227–1229(2022)
2. This work was supported by Ng Teng Fong Healthcare Innovation Programme, Centre for Healthcare Innovation, Tan Tock Seng Hospital, Singapore (Grant Number: NTFPFY19_01)

Topic: Nursing care and physiotherapy.

000040

Renal cell cycle arrest biomarkers [TIMP2]*[IGFBP7] predict acute kidney injury in critically ill patients with COVID-19: an international, multicenter, prospective observational study

R. Weiss¹, T. von Groote², M. Ostermann³, N. Lumlertgul⁴, K. Weerapolchai⁵, M. I. Monge García⁶, C. Martín⁷, B. Diez Del Corral⁸, M. J. Broch-Porca⁹, M. Perez-Carrasco⁹, A. De La Vega Sánchez¹⁰, E. Sousa¹¹, A. Catarino¹², A. Betbesé-Roig¹³, M. D. I. J. Baldirà¹⁴, S. De Rosa¹⁵, M. Garcia-Montesinos De

La Peña¹⁶, V. Ruiz Artola¹⁷, M. Brivio¹⁸, F. J. Gonzalez-Molina¹⁹, J. Gerss²⁰, J. A. Kellum²¹, M. Sadjadi²², M. Meersch²², A. Zarbock²³

¹Dept. of anesthesiology and intensive care medicine, Universitätsklinikum Münster, Münster, Germany; ²Department of Anaesthesiology, Intensive Care and Pain Medicine, Münster University Hospital, Münster, Germany; ³Department of Critical Care, Guy's & St Thomas' NHS Foundation Trust, London, United Kingdom; ⁴Critical care, Guy's and St Thomas' NHS Foundation Trust, London, United Kingdom; ⁵Department of Critical Care, Guy's and St Thomas' NHS Foundation Trust, London, United Kingdom; ⁶University hospital of jerez, Intensive care unit, Jerez, Spain; ⁷Icu, Hospital Jerez de la Frontera, Jerez de la Frontera, Spain; ⁸Department of Critical Care Medicine, La Fe University and Polytechnic Hospital, València, Spain; ⁹Intensive care department, Hospital Vall d'Hebron, Barcelona, Spain; ¹⁰Intensive care, Vall d'Hebron University Hospital, Barcelona, Spain; ¹¹Intensive care unit, Centro Hospitalar e Universitário de Coimbra, Coimbra, Portugal; ¹²Serviço Medicina Intensiva, CHUC- Centro Hospitalar e Universitário de Coimbra, Coimbra, Portugal; ¹³Intensive care, Hospital de la Santa Creu i Sant Pau, Barcelona, Spain; ¹⁴Intensive medicine service, Hospital de la Santa Creu i Sant Pau, Barcelona, Spain; ¹⁵Department of anesthesia and intensive care unit, St. Bortolo Hospital, Vicenza, Italy; ¹⁶Department of Intensive Care, Complejo Hospitalario de Navarra, Navarre, Spain; ¹⁷Department of Intensive Care, Hospital Germans Trias i Pujol, Barcelona, Spain; ¹⁸Cardiac icu, ASST Papa Giovanni XXIII, Bergamo, Italy; ¹⁹Intensive care, Mútua Terrassa University Hospital, Terrassa, Spain; ²⁰Institute of Biostatistics and Clinical Research, University of Münster, Münster, Germany; ²¹Center for Critical Care Nephrology, Department of Critical Care Medicine, University of Pittsburgh, Pittsburgh, United States of America; ²²Department of Anaesthesiology, Intensive Care and Pain Medicine, Münster University Hospital, Münster, Germany; ²³Department of anesthesiology and intensive care medicine, University Hospital Münster, Münster, Germany

Correspondence: T. von Groote

Intensive Care Medicine Experimental 2023, **11(Suppl 1)**:000040

Introduction. Patients with COVID-19 associated acute respiratory distress syndrome (ARDS) have a high risk to develop acute kidney injury (AKI) (1, 2) and this may be associated with an up to 19-fold increased odds of in-hospital death in COVID-19 patients that develop AKI (3). Therefore, early prediction of AKI is crucial in order to implement preventive strategies. However, using current standard markers of kidney function such as serum creatinine and urinary output, the recognition of AKI is unacceptably delayed in up to 43% of hospitalized patients (4).

Objectives. This study investigates the predictive performance of tissue inhibitor of metalloproteinases 2 and insulin like growth factor binding protein 7 [TIMP-2]*[IGFBP7] in critically ill patients with COVID-19 associated ARDS.

Methods. This is a multicenter, prospective, observational study conducted at twelve centers across Europe and the United Kingdom. Critically ill patients with moderate or severe COVID-19 associated ARDS were included and serial measurements of [TIMP-2]*[IGFBP7] were performed. The primary endpoint was the development of moderate or severe AKI according to the KDIGO definition.

Results. The study enrolled 300 patients that were available for the primary analysis, and 39 met the primary endpoint. Outcome parameters differed significantly in all outcome measures between patients that developed moderate or severe AKI and those that did not (Table 1).

At enrollment, urinary [TIMP-2]*[IGFBP7] had high predictive value for the primary endpoint with an area under the receiver operating characteristic curve (AUC) of 0.89 (95% CI, 0.84 to 0.93). [TIMP-2]*[IGFBP7] was significantly higher in endpoint-positive patients at enrollment and at 12h.

Conclusions. Urinary [TIMP-2]*[IGFBP7] predicts the occurrence of AKI in critically ill patients with COVID-19 associated ARDS. In this study, we demonstrated that urinary [TIMP-2]*[IGFBP7] has an even better ability to predict AKI than in other settings (5, 6). When adding [TIMP-2]*[IGFBP7] to a clinical model, risk prediction increased significantly compared to only using clinical variables.

Outcome parameters				
Outcome	No AKI ^a (n=261)	Moderate/severe AKI ^a (n=39)	Moderate/severe AKI ^a (n=39)	p-value ^b
AKI all, No. (%)	47 (18.2)	39 (100)	14 (40.0)	<0.001
Transient ^c	32 (80.0)	14 (40.0)		
Persistent ^c	8 (20.0)	21 (60.0)		
Renal replacement therapy, No. (%)	8 (3.1)	17 (43.6)		<0.001
Mortality during hospital stay, No. (%)	63 (24.7)	32 (82.1)		<0.001
Duration of mechanical ventilation, median (Q1, Q3), days	11 (6, 30)	42 (19, 68)		0.004*
Duration of vasopressor administration, median (Q1, Q3), days	5 (2, 19)	46 (33, 46)		<0.001*
ICU length of stay, median (Q1, Q3), days	15 (8, 42)	48 (29, 70)		0.001*
Hospital length of stay, median (Q1, Q3), days	26 (17, 47)	77 (30, 91)		0.015*

*Log rank

Abbreviations: AKI, acute kidney injury; ICU, intensive care unit
^areferring to the primary endpoint moderate/severe AKI within 7 days
^bmissing values 11

Table 1 (abstract 000040)

References

- Alenezi FK, Almeshari MA, Mahida R, et al. Incidence and risk factors of acute kidney injury in COVID-19 patients with and without acute respiratory distress syndrome (ARDS) during the first wave of COVID-19: a systematic review and Meta-Analysis. *Renal failure* 2021;43(1):1621–1633.
- Chan L, Chaudhary K, Saha A, et al. AKI in Hospitalized Patients with COVID-19. *J Am Soc Nephrol* 2021;32(1):151–160.
- Cheruyiot I, Henry B, Lippi G, et al. Acute Kidney Injury is Associated with Worse Prognosis In COVID-19 Patients: A Systematic Review and Meta-analysis. *Acta Biomed* 2020;91(3):e2020029.
- MacLeod A. NCEPOD report on acute kidney injury—must do better. *Lancet* 2009;374(9699):1405–1406.
- Honore PM, Nguyen HB, Gong M, et al. Urinary Tissue Inhibitor of Metalloproteinase-2 and Insulin-Like Growth Factor-Binding Protein 7 for Risk Stratification of Acute Kidney Injury in Patients With Sepsis. *Crit Care Med* 2016;44(10):1851–1860.
- Su LJ, Li YM, Kellum JA, et al. Predictive value of cell cycle arrest biomarkers for cardiac surgery-associated acute kidney injury: a meta-analysis. *Br J Anaesth* 2018;121(2):350–357.
- The study was supported by the German Research Foundation (KFO342-1, ZA428/18-1, and ZA428/21-1 to Alexander Zarbock and ME5413/1-1 to Melanie Meersch) and an unrestricted research grant from BioMerieux.

Topic: Acute Kidney Injury and haemofiltration.

000044

Presence of procoagulant peripheral blood mononuclear cells in severe COVID-19 patients relate to ventilation perfusion mismatch and precede pulmonary embolism

M. Raadsen¹, T. Langerak¹, D. Gommers², E. Van Gorp¹, K. Schmitz¹, R. De Vries¹, J. Van De Akker³, H. E. Endeman³, M. Goeijenbier⁴

¹Viroscience, Erasmus University Medical Center, Rotterdam, Netherlands; ²Department of intensive care, Erasmus MC, Rotterdam, Netherlands; ³Intensive care, Erasmus University Medical Center, Rotterdam, Netherlands; ⁴Intensive care, Spaarne Gasthuis Haarlem Zuid, Haarlem, Netherlands

Correspondence: M. Goeijenbier

Intensive Care Medicine Experimental 2023, 11(Suppl 1):000044

Introduction. Coronavirus disease 2019 (COVID-19) is the result of infection with the emerged severe acute respiratory syndrome coronavirus 2 (SARS-CoV-2). The clinical spectrum ranges from mild, flu-like symptoms to a severe viral pneumonia in a minority of cases, resulting in an acute respiratory distress syndrome (ARDS). ARDS

due to COVID-19 is characterised by a high risk of venous thromboembolisms (VTE), especially pulmonary embolism (PE) in at least 25% of ICU patients (1, 2). This occurs primarily in the absence of immunity acquired through vaccination or previous infection and in the presence of a hyperinflammatory innate immune responses to SARS-CoV-2, which fail to adequately limit viral replication (3). Timely recognition and treatment of PE is vital to improve survival. To study the role of peripheral blood mononuclear cells (PBMC) in the procoagulant state of COVID-19 patients, we performed a functional bioassay and related outcomes to the occurrence of PE. The currently used methods for diagnosing PE rely on detecting the end net result of the immunothrombosis pathway, i.e. the presence of macrothrombi and resultant organ dysfunction. The aim of this study was to determine whether an assay measuring the procoagulant properties of PBMC, which drive immunothrombosis in COVID-19, could show potential for early detection of PE in critically ill COVID-19 patients, especially, compared to data from computed angiography (CTA) and end-tidal to arterial carbon dioxide gradient. The latter is known as a sensitive measure of ventilation to perfusion mismatch (4).

Methods. PBMC were obtained from 20 patients with a computed tomography angiograph (CTA) proven PE and compared to 15 COVID-19 controls without a proven PE. Functional procoagulant properties of PBMC were measured using a modified fibrin generation time (MC-FGT) assay (5). Tissue factor (TF) expression on monocyte subsets were measured by flow cytometry. Additional clinical data were obtained from patient records including end-tidal to arterial carbon dioxide gradient.

Results. MC-FGT levels were highest in the samples taken closest to the PE detection, similar to the end-tidal to arterial carbon dioxide gradient (ETCO₂-PaCO₂), a measurement to quantify ventilation-perfusion mismatch. In patients without proven PE, peak MC-FGT relates to an increase in end-tidal to arterial carbon dioxide gradient. We identified non-classical, CD16 positive monocytes as the subset with increased TF expression.

Conclusions. We show that the procoagulant state of PBMC could aid in early detection of PE in COVID-19 ICU patients. Combined with end-tidal to ETCO₂-PaCO₂ gradient, these tests could improve early detection of PE on the ICU.

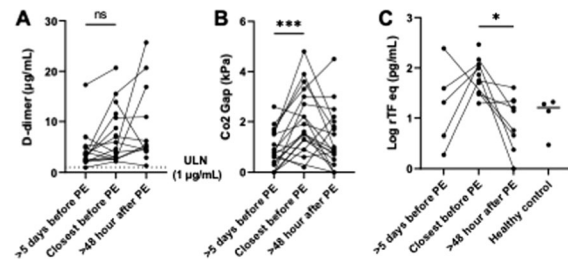

References

- van Zoelen MA, Bakhtiari K, Dessing MC, van't Veer C, Spek CA, Tanck M, et al. Ethyl pyruvate exerts combined anti-inflammatory and anticoagulant effects on human monocytic cells. *Thromb Haemost*. 2006;96(6):789–93.
- Khajebashi SH, Mottaghi M, Forghani M. PaCO₂(2)-EtCO₂(2) Gradient and D-dimer in the Diagnosis of Suspected Pulmonary Embolism. *Adv Biomed Res*. 2021;10:37.
- Vanderbeke L, Van Mol P, Van Herck Y, De Smet F, Humblet-Baron S, Martinod K, et al. Monocyte-driven atypical cytokine storm and aberrant neutrophil activation as key mediators of COVID-19 disease severity. *Nature Communications*. 2021;12(1).
- Kaptein FHJ, Stals MAM, Grootenboers M, Braken SJE, Burggraaf JLI, van Bussel BCT, et al. Incidence of thrombotic complications and overall survival in hospitalized patients with COVID-19 in the second and first wave. *Thromb Res*. 2021;199:143–8.

5. Brüggemann RAG, Spaetgens B, Gietema HA, Brouns SHA, Stassen PM, Magdelijns FJ, et al. The prevalence of pulmonary embolism in patients with COVID-19 and respiratory decline: A three-setting comparison. *Thromb Res*. 2020;196:486–90.
6. on behalf of Dutch COVID & Thrombosis Coalition

Topic: Transfusion and haemostasis disorders.

000045

Impact of COVID-19 on ICU-acquired multidrug-resistant bacteria: a prospective multicenter before-after study

L. Kreitmann¹, S. Jermoumi¹, J. Labreuche², S. Nseir¹

¹Médecine Intensive Réanimation, Hospital Center University De Lille, Lille, France; ²Statistics, Chu De Lille, Lille, France

Correspondence: L. Kreitmann

Intensive Care Medicine Experimental 2023, **11(Suppl 1)**:000045

Introduction. Patients presenting the most severe form of severe acute respiratory syndrome coronavirus 2 (SARS-CoV-2) disease 2019 (COVID-19) pneumonia have a prolonged intensive care unit (ICU) stay and are exposed to broad-spectrum antibiotics, but the impact of COVID-19 on antimicrobial resistance is unknown.

Objectives. Primary objective: To investigate the association of COVID-19 with the cumulative incidence of ICU-acquired colonization and infection related to multidrug-resistant (MDR) bacteria (ICU-MDR-col and ICU-MDR-inf, respectively).

Secondary objectives: To describe the microbiology of ICU-MDR-col and ICU-MDR-inf in COVID-19 patients, and to determine whether COVID-19 modifies the impact of ICU-MDR-col and ICU-MDR-inf on ICU length-of-stay, invasive mechanical ventilation (IMV) duration and 28-day mortality.

Methods. Observational prospective before-after study in 7 ICUs in France. All consecutive patients with an ICU stay > 48 h and a confirmed SARS-CoV-2 infection were included prospectively and followed for 28 days. Patients underwent systematic screening for colonization with MDR bacteria upon admission and every week subsequently. COVID-19 patients were compared to a recent prospective cohort of control patients from the same ICUs [1]. Screening for MDR bacteria was similar in COVID-19 and control patients.

Results. During the first and second waves of the pandemic, 367 COVID-19 patients were included, and compared to 680 controls. After adjustment for prespecified baseline confounders, the cumulative incidence of a composite outcome including ICU-MDR-col and/or ICU-MDR-inf was not significantly different between groups (adjusted sub-hazard ratio [sHR] 1.39, 95% confidence interval [CI] 0.91–2.09). When considering both outcomes separately, COVID-19 patients had a higher incidence of ICU-MDR-inf than controls (adjusted sHR 2.50, 95%CI 1.90–3.28), but the incidence of ICU-MDR-col was not significantly different between groups (adjusted sHR 1.27, 95%CI 0.85–1.88). Among MDR bacteria responsible for ICU-MDR-col and ICU-MDR-inf, third generation cephalosporins (3GC)-resistant *Enterobacteriaceae* were the most frequently isolated organisms (~75% in the overall cohort). Among patients with ICU-MDR-inf, COVID-19 patients had a higher incidence of ventilator-associated pneumonia (VAP) related to MDR bacteria than controls (65.7% vs. 36.5%).

The occurrence of ICU-MDR-col and/or ICU-MDR-inf was associated with a decreased survival (adjusted cHR 3.19, 95%CI 2.04–4.98) and a decreased duration of IMV (i.e., a higher probability of extubation alive, adjusted cHR 1.23, 95%CI 1.13 to 1.33) in COVID-19 patients, but not in controls. There was no impact of the occurrence of ICU-MDR-col and/or ICU-MDR-inf on ICU length-of-stay.

Conclusions. COVID-19 patients had an increased incidence of ICU-MDR-inf compared to controls, but the difference was not significant

when considering a composite outcome including ICU-MDR-col and/or ICU-MDR-inf.

References

1. Kreitmann, L, Vasseur, M., Jermoumi, S. et al. Relationship between immunosuppression and intensive care unit-acquired colonization and infection related to multidrug-resistant bacteria: a prospective multicenter cohort study. *Intensive Care Med* 49, 154–165 (2023). <https://doi.org/10.1007/s00134-022-06954-0>
2. None.

Topic: Infections and prevention.

000046

"Braking" the expiration: two diaphragms

G. Tagliabue¹, M. Ji¹, D. Zuege², P. A. Easton¹

¹Critical Care, Cumming School of Medicine U C, Calgary, Canada;

²Department of critical care medicine, University of Calgary and Alberta Health Services, Calgary, Canada

Correspondence: G. Tagliabue

Intensive Care Medicine Experimental 2023, **11(Suppl 1)**:000046

Introduction. There is growing clinical interest in understanding the role of the diaphragm in early expiration during mechanical ventilation (1,2). However, the current animal (1,2) and human (3,4) experimental evidence is inconclusive as to whether the "braking" activity is an inherent physiological function of the diaphragm, or if it is due to the experimental model adopted. Additionally, given the evidence of differences between the costal and crural segments (5,6) of the diaphragm, it is unclear if this activity is homogeneously distributed throughout the entire diaphragm.

Objectives. 1) Is the diaphragm normally active into expiration during spontaneous breathing and hypercapnic ventilation? 2) Is expiratory diaphragmatic activity distributed equally among the segments of the diaphragm, costal and crural?

Methods. In 13 spontaneously breathing canines, awake without confounding anesthetic, we measured directly both the inspiratory and expiratory electrical activity (EMG), and corresponding mechanical shortening of costal and crural diaphragm, at room air and during several levels of hypercapnia (RoomAir~38 mmHg; LowPETCO₂~46 mmHg; MidLowPETCO₂~53 mmHg; MidHighPETCO₂~58 mmHg; HighPETCO₂~63 mmHg).

Results. During eupnea, costal and crural diaphragm are active into expiration, showing significant and distinct expiratory activity, with crural expiratory activity greater than costal, for both magnitude and duration (Fig. 1,2). This diaphragm segmental difference diverged further during progressive hypercapnic ventilation: crural expiratory mechanical activity progressively increased, while costal mechanical expiratory activity disappeared (Fig. 3).

Conclusions. 1. The diaphragm plays an active role during expiration, and its expiratory activity, commonly referred to as "braking," is routinely expressed during spontaneous breathing.

2. However, this activity is not equally distributed between the costal and crural segments of the diaphragm. Studies have shown that the "braking" activity of the crural diaphragm is greater in magnitude and duration than that of the costal segment.

3. As hypercapnia leads to an increase in ventilation, the expiratory activity—"braking"—diverges notably between the two diaphragm regions. Indeed, crural expiratory activity greatly increases, while costal expiratory decreases in magnitude and duration, and tend to disappear.

The distinct expiratory response for each diaphragm segment would suggest a differing neural activation of the two segments.

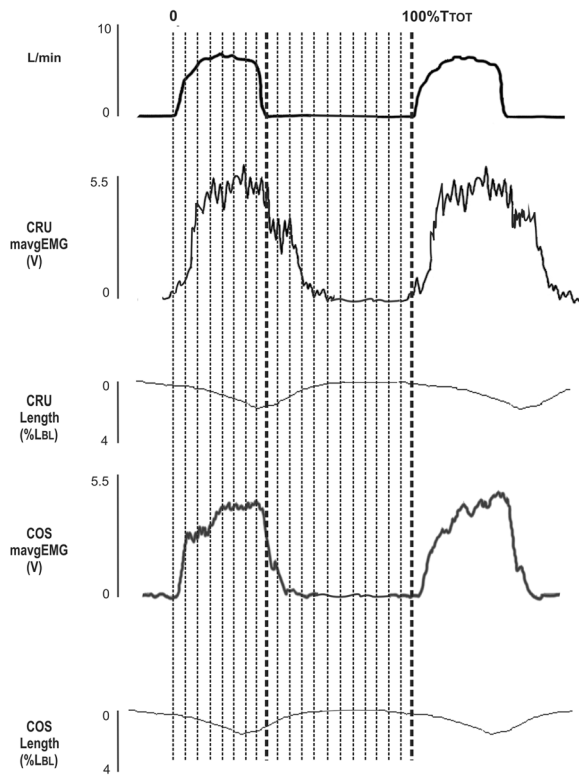

Figure 1 (abstract 000046)
 The expiratory activity of crural diaphragm, is greater than costal, during eupnea. Visualization of intrabreath analysis with percentage of Total time (%TTOT) slices of the whole breath. Typical recording of airflow, Crural, Costal diaphragm EMG (Volt, V) activity, and Shortening, during baseline room air (mean ~ 38 PETCO2 mmHg). From top to bottom: airflow, moving average EMG (mavgEMG), and Shortening (%LBL) of Crural (CRU) and Costal (COS) diaphragm, respectively.

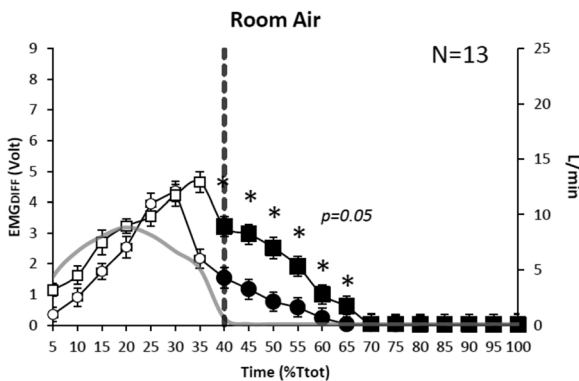

Figure 1 (abstract 000046)
 Intrabreath profile of Crural (black square) and Costal (black dot) EMG activity. The "braking" activity of Crural is significantly greater than Costal, at room air.

EMG activity (Volt) is expressed in absolute values, at Room Air. Air-flow, gray line; onset of expiration, vertical dot line. Significance, * P < 0.05.

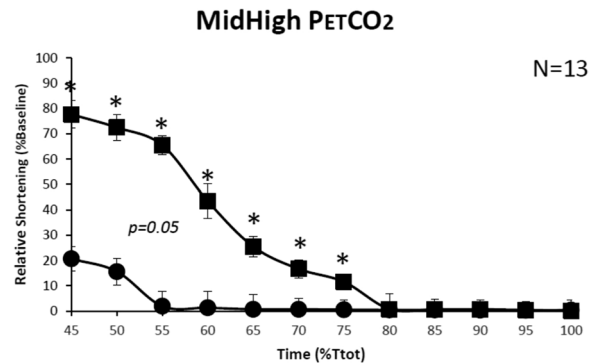

Figure 3 (abstract 000046)
 During hypercapnia, the relative mechanical action of Crural (black square) is significantly greater than Costal (black dot). Diaphragm Shortening is expressed as relative values. Significance, *P < 0.05.

References

1. Pellegrini M, Gudmundsson M, Bencze R, Segelsjo M, Freden F, Rylander C, Hedenstierna G, Larsson AS, Perchiazzi G. Expiratory resistances prevent expiratory diaphragm contraction, flow limitations and lung collapse. *AJRCCM* 2020; 201(10): 1218–1229
2. Pellegrini M, Hedenstierna G, Roneus A, Segelsjo M, Larsson A, Perchiazzi G. The diaphragm as a brake during expiration to prevent lung collapse. *AJRCCM* 2017; 195(12): 1608–1616
3. Emeriaud G, Beck J, Tucci M, Lacroix J, Sinderby C. Diaphragm electrical activity during expiration in mechanically ventilated infants. *Pediatr Research* 2006; 59: 705–710
4. Eichenwald EC, Ungarelli RA, Stark AR. Hypercapnia increases expiratory braking in preterm infants. *J Appl Physiol* 1993; 75:2665–2670
5. Nguyen DAT, Amirjani N, McCaughey EJ, Gandevia SC, Buttler JE, Hudson AL. Differential activation of the human costal and crural diaphragm during voluntary and involuntary breaths. *J Appl Physiol* 2020; 128: 1262–1270
6. Tagliabue G, Ji M, Suneby Jagers JV, Zuege DJ, Kortbeek JB, Easton PA. Distinct neural-mechanical efficiency of costal and crural diaphragm during hypercapnia. *Respir Physiol Neurobiol* 2019; 268:103247

Topic: Data Science.

000049

Oxygen debt as a predictor of high-flow nasal cannula therapy failure in SARS-CoV-2 patients with acute respiratory failure: a retrospective cohort study

M. Pérez-Garzón¹, C. Poveda-Henao¹, A. Rozo-Salinas¹, M. Díaz-Ardila², H. Robayo-Amortegui³
¹Intensive Care, Shaio Clinic, Bogotá, Colombia; ²Physiotherapy Department, Shaio Clinic, Bogotá, Colombia; ³Medicine, Critical Care Resident, Universidad de La Sabana, Chía, Colombia

Correspondence: H. Robayo-Amortegui
 Intensive Care Medicine Experimental 2023, 11(Suppl 1):000049

Introduction. Severe acute respiratory syndrome coronavirus type 2 (SARS-CoV-2) is characterized by its rapid progression to acute hypoxemic respiratory failure (AHRF) (1), with a prevalence between 20 and 40% 2. It requires increased oxygen therapy and, in the case of progression, there is the need for orotracheal intubation (OTI) and early invasive mechanical ventilation (IMV) to avoid self-inflicted lung injury (SILI) (2).

High-flow nasal cannula therapy (HFNC) is increasingly used in the treatment of ARTI, secondary to SARS-CoV-2 infection, as a potentially attractive strategy to avoid IMV (3). Multiple predictor indices of OTI requirement and the need for admission to the intensive care unit (ICU) have been developed (1), such as the 4C (4) and the ROX index (iROX) (5), with a failure of 29% of these scales in the population (6). They have a sensitivity of 86.8%, a specificity of 52.2%, and an AUROC of 0.759 (6).

The oxygen debt (DEOx) determines the total amount of oxygen molecules that does not supplement excessive oxygen consumption (VO₂) at rest, without being altered by body temperature, age, and body surface area (7,8), indicating an increase in oxygen demand to tissues below the critical oxygen delivery (DO₂) (7,8). Studies have proposed simplified formulas, with the use of base excess (BE) and lactate in comparison with other variables. They have an adequate correlation and easy clinical application (7), as a perfusion parameter and management center of the critical patient (7,9), acquired in arterial gases for a quantitative, reproducible, feasible, and easily accessible measurement.

Given the uncertainty surrounding the decision to advance OTI in patients with SARS-CoV-2 who were under management with HFNC, it is important to develop and validate stratification tools to define when to initiate IMV (7).

Objectives. The aim of the study was to determine the validity of quantitative measurement of oxygen debt (DEOx) according to arterial gases compared to the use of iROX in patients with high-flow nasal cannula (HFNC) therapy requirement, presenting with acute respiratory failure as a consequence of SARS-CoV-2 infection. In addition, we aimed to identify the factors associated with the need for orotracheal intubation (OTI).

Methods. This is a retrospective observational cohort study of a database collected from patients with SARS-CoV-2 infection admitted to intensive care units with hypoxemic acute respiratory failure and had received HFNC upon admission during the Covid-19 pandemic (March 23, 2020 through August 02, 2021). The variables of interest were factors determining the predictive ability of DEOx and iROX. We used a multiple logarithmic regression model to correct for confounding and mixed-effects variables, and validated for OTI in patients treated with HFNC.

Results. From a total of 373 patients treated with HFNC, 317 patients (84.9%) required invasive mechanical ventilation. APACHE II (AOR 1.44; 95% CI: 1.14–1.83, p 0,032), vasopressor use (AOR 27.7; 95% CI: 1.83–420,63, p 0,017), and DEOx (AOR 1.26; 95% CI: 1.10–1.44, p 0,001) were associated with the need for intubation. The predictive model between iROX and DEOx evidenced an AUC of 0.535 vs. 0.606, respectively, with a DEOx cut off point of 7.14 (± 10.16 , $p < 0.01$). DEOx as an independent factor of OTI presents an OR 2,48 with cut point 4.5 mlO₂/kg (AUC 0.780, CI 95%, 0.753–0.808, $p < 0.01$).

Conclusions. Our study is the only one that documents the usefulness of DEOx as a quantitative measurement to predict the need for OTI in patients with acute respiratory failure associated with SARS-CoV-2 infection who were being managed with HFNC according to the models established in multiple logarithmic regression with the correction of confounding variables with a good predictive value above iROX. This could be a reproducible and valid method to implement its use and extrapolate to other populations. Oxygenation was not a good factor for failure in HFNC, whereas APACHE II, vasopressor use, and albumin were independently associated with intubation. Further studies and data from other centers are needed to characterize the usefulness of DEOx more precisely in view of the possibility of further expanding a term with global characteristics in intensive care and of great clinical relevance.

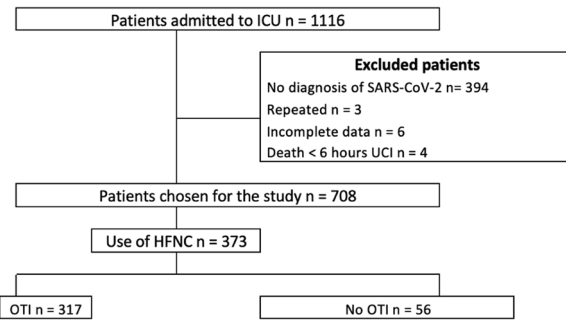

Figure 1 (abstract 000049) Flowchart of the admission of subjects to the study. ICU - intensive care unit, n - number, HFNC - high flow nasal. SARS-CoV-2 - Severe acute respiratory syndrome coronavirus 2. OTI - Orotraquel intubation

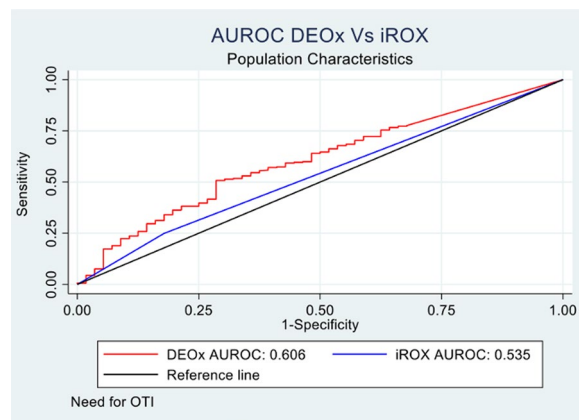

Figure 2 (abstract 000049) Abbreviation: DEOx- Oxygendebt. iROX- ROC index. AUC - area under the curve. ROC - receiver operating characteristics. OTI - Orotraquel intubation

Table 1 (abstract 000049) General characteristic of patients presenting SARS-CoV-2 with ARIH under management with HFNC

Characteristics	Population n= 373	OTI n= 317	No OTI n= 56	p-value
Age (years), mean (SD)	62.21 (13.41)	62.21 (13.41)	62.21 (13.41)	0.937
Gender, Male n (%)	264 (70.78)	264 (70.78)	264 (70.78)	0.967
Weight, kg, mean (SD)	71.92 (15.78)	71.92 (15.78)	71.92 (15.78)	0.983
Body mass index, mean (sd)	23.21 (4.32)	23.21 (4.32)	23.21 (4.32)	0.483
SO ₂ (%, SD)	92.86 (4.96)	92.86 (4.96)	92.86 (4.96)	<0.001*
Mortality (%)	203 (54.40)	155 (47.32)	51 (90.94)	<0.001*
Comorbidity, n (%)				
Atrial fibrillation	181 (48.52)	158 (49.84)	24 (42.86)	0.235
Dyslipidemia	138 (36.99)	120 (37.85)	18 (32.14)	0.004*
COPD	40 (10.72)	40 (12.62)	0 (0.00)	0.137
Hypertension	203 (54.40)	192 (60.57)	11 (19.64)	0.001*
Vital signs upon admission, mean (sd)				
Heart rate, bpm	85.65 (18.49)	85.19 (18.78)	85.93 (17.58)	0.211
Respiratory rate, bpm	20.39 (5.61)	20.22 (5.49)	20.49 (5.29)	0.982
Systolic blood pressure, mmHg	113.71 (20.14)	113.16 (20.70)	113.96 (18.16)	0.286
Diastolic blood pressure, mmHg	71.74 (14.86)	71.72 (14.94)	71.78 (13.76)	0.953
Pneumatic parameters, mean (sd)				
C (reactive power), mmHg	171.61 (23.71)	166.67 (23.90)	171.15 (24.08)	<0.001*
Leakage, ml	33.04 (4.61)	33.07 (4.71)	32.97 (4.32)	0.796
Pressure, cmH ₂ O	23.64 (4.92)	23.64 (4.92)	23.64 (4.92)	0.547
Sodium, mmol/L	137.80 (0.41)	137.80 (0.41)	137.80 (0.41)	0.383
Creatinine, mg/dL	1.09 (0.33)	1.09 (0.33)	1.09 (0.33)	<0.001*
Urea, mg/dL	110.61 (11.78)	110.61 (11.78)	110.61 (11.78)	0.579
D-dimer, ng/mL	2962.81 (1049.76)	3026.47 (1099.90)	2645.71 (1081.08)	0.178
Lactate, mg/dL	252.49 (117.79)	252.49 (117.79)	252.49 (117.79)	0.597
Geometry upon admission, mean (sd)				
pH	7.36 (0.16)	7.35 (0.16)	7.41 (0.16)	<0.001*
pO ₂ , mmHg	58.71 (12.84)	58.91 (12.84)	57.89 (12.29)	0.494
pCO ₂ , mmHg	39.71 (12.47)	40.91 (12.49)	37.29 (10.71)	<0.001*
SatO ₂ , %	90.87 (3.77)	90.81 (3.71)	92.73 (4.49)	0.035
PaO ₂ /FiO ₂ ratio	190.89 (46.48)	190.79 (46.48)	191.44 (46.18)	0.305
Conditions during hospitalization, n (%)				
Total cases	130 (24.29)	108 (33.44)	4 (7.14)	<0.001*
Need for intubation	21 (6.70)	21 (6.64)	0 (0.00)	<0.001*
Vasopressor	140 (37.53)	137 (42.29)	3 (5.36)	<0.001*
No need for intubation	21 (6.70)	21 (6.64)	0 (0.00)	<0.001*
SO ₂ score	8.13 (2.17)	8.13 (2.17)	8.13 (2.17)	<0.001*
APACHE II score	12.66 (4.56)	12.66 (4.56)	12.66 (4.56)	<0.001*
ICU score	20.33 (4.71)	20.45 (4.71)	20.45 (4.71)	<0.001*
Mortality	6.60 (16.62)	6.60 (16.62)	6.60 (16.62)	0.836
OTI	1 (0.21)	1 (0.31)	0 (0.00)	0.496

*p < 0.05. Data were obtained on 10/20/2021 using the following variables: Age, Sex, Weight, Height, Body Mass Index, SO₂, Mortality, Comorbidity, Atrial fibrillation, Dyslipidemia, COPD, Hypertension, Vital signs upon admission, Pneumatic parameters, Leakages, Pressures, Sodium, Creatinine, Urea, D-dimer, Lactate, Geometry upon admission, pH, pO₂, pCO₂, SatO₂, PaO₂/FiO₂ ratio, Conditions during hospitalization, Total cases, Need for intubation, Vasopressor, No need for intubation, SO₂ score, APACHE II score, ICU score, Mortality, OTI. The data were analyzed using the following statistical software: SPSS (Statistical Package for the Social Sciences), version 26.0.0.0. © 2023 by the author. Licensee MDPI, Basel, Switzerland. This article is an open access article distributed under the terms and conditions of the Creative Commons Attribution (CC BY) license (http://creativecommons.org/licenses/by/4.0/).

Table 2 (000049) Factors associated with OTI in 372 with SRS-CoV-2 under management with HFNC

Characteristics	OR (CI 95%)	p value	Adjusted OR (CI 95%)	p value
Age (Years)	1.02 (1.00–1.04)	0.023*	0.99 (0.89–1.13)	0.964
Gender, male	0.93 (0.51–1.80)	0.907	0.85 (0.14–4.92)	0.856
ICU Stay (Days)	1.33 (1.21–1.45)	<0.001*	1.47 (1.21–1.79)	0.000*
Arterial hypertension	1.42 (0.80–2.53)	0.228	1.06 (0.60–1.74)	0.021*
Diabetes	1.44 (0.51–1.00)	0.012*	1.18 (0.50–1.39)	0.024*
Sodium	1.07 (1.00–1.14)	0.030*	1.13 (0.28–1.56)	0.041*
Creatinine	3.25 (1.21–8.73)	0.019*	1.94 (0.89–1.17)	0.433
PaCO ₂ (5 mmHg increase)	1.10 (1.08–1.15)	<0.001*	1.44 (1.14–1.83)	0.002*
APACHE II Score	1.38 (1.27–1.51)	<0.001*	1.26 (1.10–1.44)	0.001*
SFOA Score	1.55 (1.32–1.82)	<0.001*	2.97 (0.26–33.62)	0.378
SOFA Score	1.08 (1.04–1.13)	<0.001*	27.7 (1.89–420.63)	0.017*
Renal lesion	6.53 (2.30–18.53)	<0.001*	1.99 (0.09–0.32)	0.098
Vasopressor	13.4 (4.11–43.94)	<0.001*		
No invasive ventilation	1.95 (0.2–1.6)	<0.001*		

OR - Odds Ratio, CI - confidence interval, ICU - intensive care unit, PaCO₂ - Partial pressure of carbon dioxide, APACHE II - Acute physiology and chronic health disease classification system, SOFA - Sepsis Organ Failure Assessment, SOFA - Sequential Organ Failure Assessment, SFOA - Sequential Organ Failure Assessment.

References

- Shoemaker WC, Appel PL, Kram HB. Tissue oxygen debt as a determinant of lethal and nonlethal postoperative organ failure: Critical Care Medicine 1988;16(11):1117–1120.
- Siegel JH, Fabian M, Smith JA, Kingston EP, Steele KA, Wells MR. Oxygen Debt Criteria Quantify the Effectiveness of Early Partial Resuscitation after Hypovolemic Hemorrhagic Shock: The Journal of Trauma: Injury, Infection, and Critical Care 2003;54(5):862–880.
- We thank the Shaio Clinic Foundation for making its technological resources available to carry out the data collection in a very limited time. We also thank all the health personnel involved in the care of patients with SARS-CoV-2 infection who helped in the management of the pandemic in our country, as well as the researchers involved in this work.
- Xu R, Hou K, Zhang K, Xu H, Zhang N, Fu H, et al. Performance of Two Risk-Stratification Models in Hospitalized Patients With Coronavirus Disease. Front Med 2020;7:518.
- Rempel V, Grandoch A, Safi A-F, Buller J, Riekert M, Schick V, et al. The prognostic implications of comorbidity and risk factors for (post) operative complications, days spent in the intensive care unit (ICU), and length of hospitalization in patients with oral squamous cell carcinoma: A prospective study. Journal of Cranio-Maxillofacial Surgery 2020;48(9):868–874.
- Lee JH, Rehder KJ, Williford L, Cheifetz IM, Turner DA. Use of high flow nasal cannula in critically ill infants, children, and adults: a critical review of the literature. Intensive Care Med 2013;39(2):247–257.
- Docherty AB, Mulholland RH, Lone NI, Cheyne CP, De Angelis D, Diaz-Ordaz K, et al. Changes in in-hospital mortality in the first wave of COVID-19: a multicentre prospective observational cohort study using the WHO Clinical Characterisation Protocol UK. The Lancet Respiratory Medicine 2021;9(7):773–785.
- Roca O, Messika J, Caralt B, Garcia-de-Acila M, Sztrymf B, Ricard J-D, et al. Predicting success of high-flow nasal cannula in pneumonia patients with hypoxic respiratory failure: The utility of the ROX index. Journal of Critical Care 2016;35:200–205.
- Kang BJ, Koh Y, Lim C-M, Huh JW, Baek S, Han M, et al. Failure of high-flow nasal cannula therapy may delay intubation and increase mortality. Intensive Care Med 2015;41(4):623–632.
- Dunham CM, Siegel JH, Weireter L, Fabian M, Goodarzi S, Guadalupi P, et al. Oxygen debt and metabolic acidemia as quantitative predictors of

mortality and the severity of the ischemic insult in hemorrhagic shock: Critical Care Medicine 1991;19(2):231–243.

Topic: Acute respiratory failure and mechanical ventilation.

000052

Liraglutide attenuates inflammation in brain-dead donors: a randomized clinical trial

G. Custodio Lee¹, C. Leita², D. C. Moreira³, T. Rech³, A. M. Massutti⁴, M. R. Igreja⁴, N. E. Lemos³, F. Visioli⁵

¹Intensive Care, Hospital Santa Isabel, Blumenau, Brazil; ²Endocrine division, Universidade Federal do Rio Grande do Sul, Porto Alegre, Brazil; ³Endocrine division, Hospital de Clínicas de Porto Alegre, Porto Alegre, Brazil; ⁴Transplant Division, Hospital Santa Isabel, Blumenau, Brazil; ⁵Department of Oral Pathology, Hospital de Clínicas de Porto Alegre, Porto Alegre, Brazil

Correspondence: G. Custodio Lee

Intensive Care Medicine Experimental 2023, **11(Suppl 1)**:000052

Introduction. Brain death triggers an inflammatory cascade that damages organs before harvesting, affecting the quality of grafts and, consequently, transplantation outcomes. This randomized clinical trial aims to compare the effect of liraglutide versus placebo in attenuating brain death-induced inflammation and oxidative stress in brain-dead donors.

Methods. We conducted a double-blinded, placebo controlled, randomized clinical trial involving brain-dead donors. Subjects were randomized to receive either liraglutide or placebo after completion of brain death protocol and where followed until organ retrieval. Primary outcome was the reduction in interleukin-6 (IL-6) serum levels. Secondary outcomes were changes in other serum pro-inflammatory (IL-1 β , INF- δ , TNF- α) and anti-inflammatory cytokines (IL-10), expression of antiapoptotic (*BCL-2*, *BIP*, *CHOP*) and antioxidant (*SOD-2*, *UCP-2*) genes, and expression of inflammatory (TNF), antiapoptotic (*CHOP*) and antioxidant (*SOD-2*) proteins in liver biopsies. Cytokines were measured using multiplex ELISA method. Gene expression was evaluated by RT-qPCR in liver tissue, and protein quantification was performed by immunohistochemistry in paraffin-embedded liver sections.

Results. From September 2018 to December 2020, a total of 50 brain-dead donors were randomized to receive subcutaneous liraglutide or placebo. Liraglutide group had lower cytokine levels compared to placebo during the follow-up: Δ IL-6 (– 28 [– 182 to 135] vs. 32 [– 10.6 to 70.7] pg/mL; $p=0.041$) and Δ IL-10 (– 0.01 [– 2.2 to 1.5] vs. 1.9 [– 0.2 to 6.1] pg/mL; $p=0.042$), respectively. Gene and protein expression were not modified by liraglutide. Treatment with liraglutide did not increase organ recovery rate OR 1.24 (CI95% 0.18–8.64), $p=0.82$.

Conclusions. The use of liraglutide reduces IL-6 and prevented the increase of IL-10 levels in brain-dead donors. [T1] Expression of genes and proteins related to inflammation, apoptosis and oxidative stress were not modified by treatment with liraglutide. ClinicalTrials.gov ID: NCT03672812.

[T1]Cris, ajuda a descrever melhor isso: a IL-6 cai, mas a IL-10 sobe menos com liraglutida.

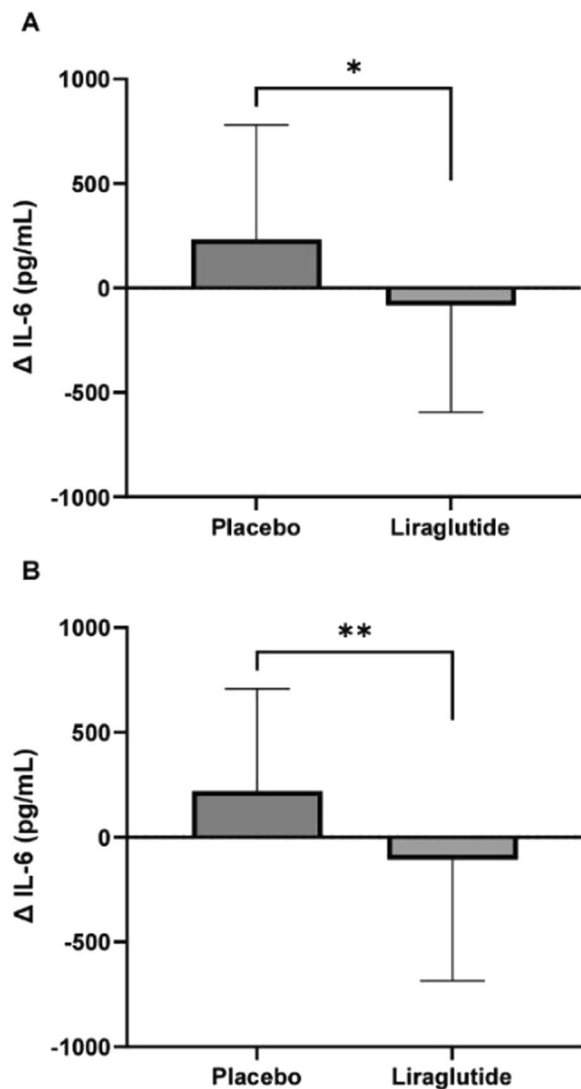

Figure 2 (abstract 000052) Interleukin-6 levels (IL-6) in liraglutide and placebo groups. **A.** Difference in IL-6 levels between the second minus the first time point (IL-6) using the intention-to-treat analysis. **B.** Difference in Δ IL-6 levels between the second minus first time point (Δ IL-6) using the per-protocol analysis

References

1. K N, C N. IL-10 in Mast Cell-Mediated Immune Responses: Anti-Inflammatory and Proinflammatory Roles. *International journal of molecular sciences*. 2021;22(9).
2. GA W, CC R, AB C, ARR G, CM G, C T, et al. Brazilian guidelines for the management of brain-dead potential organ donors. The task force of the Associação de Medicina Intensiva Brasileira, Associação Brasileira de Transplantes de Órgãos, Brazilian Research in Critical Care Network, and the General Coordination of the National Transplant System. *Revista Brasileira de terapia intensiva*. 2021;33(1).
3. GA W, CC R, AB C, ARR G, CM G, C T, et al. Brazilian guidelines for the management of brain-dead potential organ donors. The task force of the AMIB, ABTO, BRICNet, and the General Coordination of the National Transplant System. *Annals of intensive care*. 2020;10(1).

4. DM W, A N, M E. Drug Therapy in Obesity: A Review of Current and Emerging Treatments. *Diabetes therapy: research, treatment and education of diabetes and related disorders*. 2020;11(6).
5. YY Z, CC Y, CC H, CC L, CC L, CH W, et al. Extendin-4 protects kidney from acute ischemia-reperfusion injury through upregulation of NRF2 signaling. *American journal of translational research*. 2017;9(11).
6. R C, NE L, AL D, FS O, LA B, LH C, et al. Exendin-4 protects rat islets against loss of viability and function induced by brain death. *Molecular and cellular endocrinology*. 2015;412
7. TH R, D C, J R, SS B, AB O, TJ GF, et al. Brain death-induced inflammatory activity in human pancreatic tissue: a case-control study. *Transplantation*. 2014;97(2).
8. JL C, C E, CA S, MT S, M V, G B, et al. Brain death significantly reduces isolated pancreatic islet yields and functionality in vitro and in vivo after transplantation in rats. *Diabetes*. 2003;52(12)
9. A B. Systemic inflammation in the brain-dead organ donor. *Acta anaesthesiologica Scandinavica*. 2009;53(4).
10. K W, AC B, LE SH, NG O, SE P, SD D, et al. Brain stem death induces pro-inflammatory cytokine production and cardiac dysfunction in sheep model. *Biomedical journal*. 2022;45(5).
11. Liraglutide or other more potent GLP-1 analogue agents have the potential to modify the outcomes of organ transplantation and different doses and duration of exposure to liraglutide should be further evaluated in a multicentric clinical trial.
12. Attenuating inflammation may reduce the organ damage induced by BD itself
13. Liraglutide reduces IL-6

Topic: Brain death, organ donation and transplantation.

000055

Oxygen debt yield (DEOx) for 28-day mortality and multiple organ failure in patients with COVID-19

M. Pérez-Garzón¹, C. Poveda-Henao¹, A. Bastidas-Goyes², H. Robayo-Amortegui³

¹Intensive Care, Shaio Clinic, Bogotá, Colombia; ²Medicine, Universidad de La Sabana, Chía, Colombia; ³Medicine, Critical Care Resident, Universidad de La Sabana, Chía, Colombia

Correspondence: H. Robayo-Amortegui

Intensive Care Medicine Experimental 2023, **11(Suppl 1)**:000055

Introduction. Coronavirus disease 2019 (COVID-19) has spread around the worldwide since its initial outbreak in Wuhan China in December 2019, with a global mortality rate of 5% (1). Observing severe clinical forms that require management in an intensive care unit (ICU) and those presenting with adult respiratory distress syndrome (ARDS) and/or Multiple organ dysfunction syndrome (MODS) (2), highlights the importance of ICU in the assessment, stabilization and management of these patients during the pandemic.

One of the main goals of patient care in the ICU is to maintain an adequate delivery of oxygen (DO₂) to the tissues, which allows sufficient production of cellular energy to guarantee adequate organic functioning; in other words, to correct the oxygen debt (DEOx) generated during critical conditions to maintain the basic cellular processes that allow the patient to survive (3). The DEOx concept is commonly used in the ICU to indicate a change from aerobic to anaerobic metabolism (3), but its clinical utility is not completely clear (3), being a little used tool and in many places a "end forgotten." However, in studies of hemorrhagic shock (4) and postoperative states (5,6), DEOx has shown a correlation with the clinical outcomes of MODS and mortality (6,7).

In patients with severe SARS-CoV-2 (Severe acute respiratory syndrome coronavirus 2) infection, there may be a deficit in oxygen consumption (VO₂) (6) and wide variability in the patient's clinical

condition; DEOx measurement is not altered by factors such as age, body surface area, and temperature (4), and can be used as a prognostic tool in these patients. DEOx has a simple and reproducible calculation that indicates the critical DO₂ at rest (8), calculated from equations where the levels of lactate and base excess (BE) obtained from arterial gases are used (4). DEOx is not included in general prognostic scores such as the SOFA Score (Sequential Organ Failure Assessment score) (8), APACHE II Score (Acute Physiology and Chronic Health Evaluation II) (9), or in specific scores for COVID-19 such as the 4C (10), which opens the possibility that this value can generate additional, useful and complementary information to that provided by these scores. However, DEOx has not been widely and reliably studied in severely ill COVID-19 patients. The aim of this study was to determine the validity of DEOx through indirect quantitative calculation to predict MFO and 28-day mortality in patients admitted to the ICU.

Objectives. The main goal of critical patients is to maintain an adequate tissue DO₂, avoiding DEOx as an indicator of critical DO₂. The objective of this study was to determine the validity of DEOx through indirect quantitative calculation to predict MODS and 28-day mortality in patients admitted to the ICU for SARS-CoV-2 infection in relation to the APACHE II, SOFA, and 4C Scores.

Methods. Retrospective cohort study included patients with SARS-CoV-2 infection admitted to the ICU between 2020 and 2021. Acute Physiology and Chronic Health Evaluation (APACHE II), Sequential Organ Failure Assessment (SOFA) and 4C mortality scores were calculated upon admission to the ICU, comparing its accuracy in predicting mortality at 28 days and FOM with DEOx.

Results. 708 patients were included, with a mortality rate of 44.4% (n = 315), of these, 72.5% were men, with a DEOx value of 11.16 ml O₂/kg. The mean age was 58.7 (SD 14.51) years. Multivariate analysis independently related DEOx to mortality, as well as intubation with an OR of 8.69 (95% CI, 4.28–17.62) and renal injury of 3.35 (95% CI, 2.40–4.68), and for each point increase in creatinine the risk of MODS increased with an OR of 4.1 (95% CI, 1.87–8.98). To determine the precision of the scores, an AUROC analysis was performed with weak discrimination and similar behavior for the primary outcomes. The most accurate scale for mortality and MODS was 4C with an AUC of 0.683 (95% CI, 0.64–0.72) and APACHE II with an AUC of 0.814 (95% CI, 0.77–0.85), while that of AROC of DEOx was 0.612 (95% CI, 0.57–0.65) and 0.646 (95% CI, 0.57–0.71), respectively.

Conclusions. DEOx as a predictor of MODS and 28-day mortality in a critically ill patients with SARS CoV-2 was similar to the APACHE II, SOFA, and 4C scores. The correlation of the DEOx with these scales can be useful for early interventions in the critically ill patients.

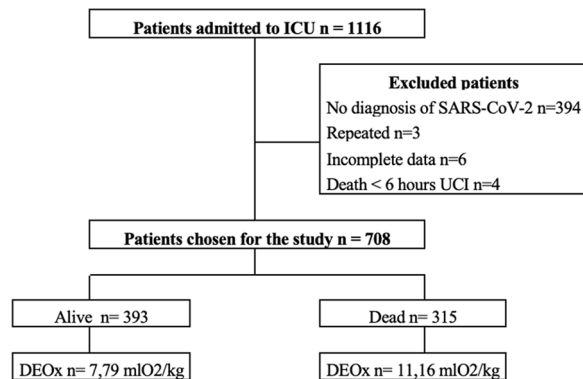

Figure 1 (abstract 000055) Flowchart of the admission of subjects to the study

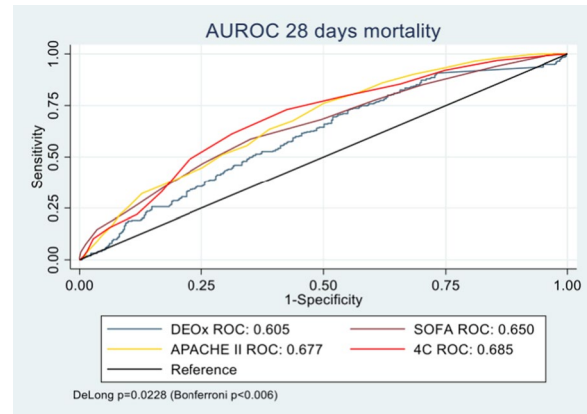

Figure 2 (abstract 000055) DEOx in comparison with the different scores. AUROC, area under the curve of receiver operating characteristics; SOFA, Sequential organ failure assessment; APACHE, acute physiology and chronic health disease classification system

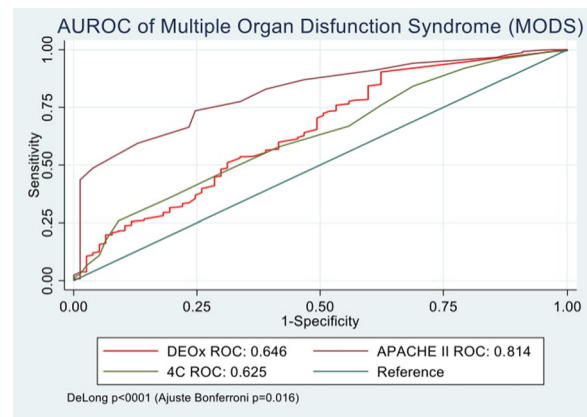

Figure 3 (abstract 000055) DEOx in comparison with the different scores. AUROC, area under the curve of receiver operating characteristics; APACHE, acute physiology and chronic health disease classification system

Table 1 (abstract 000055) Clinical and demographic characteristics of the 708 patients included in this study

CHARACTERISTICS(n=708)	VALUES
MEDIAN AGE	61(54-73)
NO OF MALE	37(74%)
MEDIAN LOS (ICU)	4.6days (3-7)
MEDIAN LOS (HOSPITAL)	9 days (6-12)
MORTALITY	14/50 (28%)
MEDIAN APACHE 2	16 (11-20)
MEDIAN SOFA	5 (3-8)
NO OF PATIENTS AT HIGH RISK FOR MALNUTRITION	12/50 (24%)
MEDIAN mNUTRIC	8(3-6)
MEDIAN GRASP mmh	21.08(16.9-25.54)
MEDIAN NLR	7.84(4.24-18.02)

References

1. Siegel JH, Fabian M, Smith JA, Kingston EP, Steele KA, Wells MR. Oxygen debt criteria quantify the effectiveness of early partial resuscitation after hypovolemic hemorrhagic shock. *J Trauma*. 2003;52(5):862–80.
2. Rixen D, Siegel JH. Bench-to-bedside review: oxygen debt and its metabolic correlates as quantifiers of the severity of hemorrhagic and post-traumatic shock. *Crit Care*. 2005 Oct 5;9(5):441–53. <https://doi.org/10.1186/cc3526>.
3. Shoemaker WC, Appel PL, Kram HB. Role of oxygen debt in the development of organ failure sepsis, and death in high-risk surgical patients. *Chest*. 1992 Jul;102(1):208–15. <https://doi.org/10.1378/chest.102.1.208>.
4. Alhazzani W, Møller MH, Arabi YM, Loeb M, Gong MN, Fan E, Oczkowski S, Levy MM, Derde L, Dziedra A, Du B, Aboodi M, Wunsch H, Cecconi M, Koh Y, Chertow DS, Maitland K, Alshamsi F, Belle-Cote E, Greco M, Laundry M, Morgan JS, Kesecioglu J, McGeer A, Mermel L, Mammen MJ, Alexander PE, Arrington A, Centofanti JE, Citerio G, Baw B, Memish ZA, Hammond N, Hayden FG, Evans L, Rhodes A. Surviving Sepsis Campaign: guidelines on the management of critically ill adults with Coronavirus Disease 2019 (COVID-19). *Intensive Care Med*. 2020 May;46(5):854–887. <https://doi.org/10.1007/s00134-020-06022-5>.
5. Chen N, Zhou M, Dong X, Qu J, Gong F, Han Y, Qiu Y, Wang J, Liu Y, Wei Y, Xia J, Yu T, Zhang X, Zhang L. Epidemiological and clinical characteristics of 99 cases of 2019 novel coronavirus pneumonia in Wuhan, China: a descriptive study. *Lancet*. 2020 Feb 15;395(10,223):507–513. [https://doi.org/10.1016/S0140-6736\(20\)30211-7](https://doi.org/10.1016/S0140-6736(20)30211-7).
6. Dunham CM, Siegel JH, Weireter L, Fabian M, Goodarzi S, Guadalupi P, et al. Oxygen debt and metabolic acidemia as quantitative predictors of mortality and the severity of the ischemic insult in hemorrhagic shock. *Vol. 19, Critical Care Medicine*. 1991. p. 231–43.
7. Crowell JW, Smith EE. Oxygen Deficit and Irreversible Hemorrhagic Shock. *Am J Physiol*. 1964;206:313–6.
8. Vincent JL, de Mendonça A, Cantraine F, Moreno R, Takala J, Suter PM, Sprung CL, Colardyn F, Blecher S. Use of the SOFA score to assess the incidence of organ dysfunction/failure in intensive care units: results of a multicenter, prospective study. Working group on "sepsis-related problems" of the European Society of Intensive Care Medicine. *Crit Care Med*. 1998 Nov;26(11):1793–800. <https://doi.org/10.1097/00003246-199811000-00016>.
9. Knight S R, Ho A, Pius R, Buchan I, Carson G, Drake T M et al. Risk stratification of patients admitted to hospital with covid-19 using the ISARIC WHO Clinical Characterisation Protocol: development and validation of the 4C Mortality Score *BMJ* 2020; 370:m3339 <https://doi.org/10.1136/bmj.m3339>
10. We thank Fundación Clínica Shaio for making the technological resources available for data collection in a short time. Also to the Universidad de La Sabana for all the support and methodological advice provided; and the health personnel involved in the care of patients with SARS-CoV-2 infection who helped manage the pandemic in our country, as well as the researchers involved in this work.
11. Knaus WA, Draper EA, Wagner DP, Zimmerman JE. APACHE II: a severity of disease classification system. *Crit Care Med*. 1985 Oct;13(10):818–29.

Topic: Sepsis.

000056

Sirt3 deficiency influences spontaneous recurrent seizures and exacerbates hippocampal cell death

W. J. Kim¹¹Neurology, Yonsei University Hospital, Seoul, Republic of Korea

Correspondence: W.J. Kim

Intensive Care Medicine Experimental 2023, **11(Suppl 1)**:000056

Introduction. Status Epilepticus (SE) is kind of common neuronal disorders that accompanied with persistence seizure with oxidative damage, and consequently it can be acquired chronic epilepsy, goes through the latent period. Excessive oxidative stress can cause neuronal cell death in acute epileptic phase that is key factor in progression of epileptogenesis. Sirtuin 3(Sirt3) is NAD⁺-dependent histone deacetylases, has been considered as an important role through regulating manganese superoxide dismutase (Mn SOD), which is major antioxidant enzymes that contributes to aging and

neurodegeneration. In present study aims to investigate the effect of Sirt3 deficiency on neuronal damaged and epileptogenesis following pilocarpine-induced SE.

Methods. Sirt3 KO on a C57BL/6 background and wild-type (WT) C57BL/6 mice were administrated to pilocarpine. Seizure onset, spontaneous recurrent seizures and mortality are assessed. At 2 months after pilocarpine-induced SE, hippocampal damage assessed. In addition, alteration of astrocyte and MnSOD activity were assessed in latent period.

Results. Sirt3 deficiency showed increased mortality rate, but no difference detected in seizure onset time after pilocarpine injection. Interestingly, total numbers of spontaneous recurrent seizures were increased, and hippocampal neuronal loss remarkably exacerbate in chronic epileptic period in Sirt3 deficiency. Also, severe gliosis and decreased MnSOD activity was detected in Sirt3 deficiency rather than WT.

Conclusions. This study suggest that Sirt3 deficiency could be related with development and severity of spontaneous recurrent seizures during epileptogenesis in pilocarpine – induced seizure model.

Topic: Translational Medicine.

000057

The role of pulmonary endothelial cell-derived extracellular vesicles in acute respiratory distress syndrome

L. Wang¹, Y. Tang¹, C. Jie¹, H. Qiu¹¹Jiangsu Provincial Key Laboratory of Critical Care Medicine, Department of Critical Care Medicine, Zhongda Hospital, School of Medicine, Southeast University, Nanjing, China

Correspondence: L. Wang

Intensive Care Medicine Experimental 2023, **11(Suppl 1)**:000057

Introduction. Acute lung injury (ALI)/acute respiratory distress syndrome (ARDS) is an acute life-threatening respiratory critical syndrome with acute onset, rapid progression and high mortality. There is still a lack of effective therapeutic drugs, hence it is urgent to find new therapeutic targets. Emerging evidence indicates extracellular vesicles (EVs) play a critical role in the pathogenesis of inflammatory diseases [1]. Our earlier studies revealed that EVs isolated from the perfusate of the ex vivo perfused human ALI model could cause acute injury in naive human lung, and demonstrated that these EVs were primarily derived from endothelial cells [2], suggesting that pulmonary endothelial cell-derived EVs (EC-EVs) play an important role in ARDS. However, it is still unknown how EC-EVs aggravate lung injury.

Objectives. To clarify the role and underlying mechanisms of EC-EVs in the occurrence and development of ALI/ARDS.

Methods. Mouse pulmonary microvascular endothelial cells were stimulated with LPS or not to isolate normal EC-EVs (Con-EVs) or inflammatory EC-EVs (LPS-EVs). These EVs were injected into C57BL/6J wild-type mice intravenously and then examined for lung inflammation by qRT-PCR and histological assessment. Fluorescence labeled EVs were injected into mice, flow cytometry analysis confirmed the target cells of LPS-EVs among various immune cells. Clodronate liposome was used to reduce peripheral monocytes before injection of LPS-EVs into mice, and then the degree of lung injury and inflammation was measured. Multicolor flow cytometry was used to evaluate the phenotypic changes of pulmonary monocyte-derived macrophages in mice treated with LPS-EVs. In vitro co-culture system was applied where the mouse bone marrow-derived monocytes were co-cultured with EC-EVs to further confirm the results of in vivo studies by flow cytometry, qRT-PCR and ELISA.

Results. The mice injected with LPS-EVs exhibited varying degrees of increased respiratory rate, mental distress, and decreased food intake. Further testing revealed that the expression of inflammatory factors in the lung tissue of LPS-EV-treated mice was significantly higher than that of Con-EV-treated mice, which was consistent with the results of pathological sections of the lung tissue, indicating that LPS-EVs could lead to ALI. Flow cytometry results showed that the injected LPS-EVs were preferentially ingested by monocytes in the lung. The degree of lung injury and inflammation caused by LPS-EVs was decreased after

the depletion of monocytes. In addition, *in vivo* studies showed that LPS-EV treatment significantly increased the number of monocyte-derived macrophages in the lung and promoted their differentiation into the pro-inflammatory M1 type macrophages, but it was worth noting that LPS-EV treatment had no effects on tissue resident macrophages. *In vitro* studies also confirmed that LPS-EVs could drive mouse bone marrow-derived monocytes to differentiate into M1 type macrophages.

Conclusions. The present study demonstrated that EC-EVs generated upon inflammatory stimulation could lead to lung injury by targeting monocytes and changing their fate into pro-inflammation macrophages. This study revealed an unknown crosstalk between endothelial cells and monocytes, and clarified the important role of EC-EVs in the development of ALI/ARDS, which is expected to provide new therapeutic targets for the prevention and treatment of ALI/ARDS.

References

- [1] Buzas EI. The roles of extracellular vesicles in the immune system. *Nat Rev Immunol.* 2022, 4:1–15.
- [2] Liu A, et al. Therapeutic Effects of Hyaluronic Acid in Bacterial Pneumonia in Perfused Human Lungs. *Am J Respir Crit Care Med.* 2019, 200(10):1234–1245.
- The present study was supported by Key Program of National Natural Science Foundation of China (No. 81930058), Jiangsu Provincial Key Medical Discipline (Laboratory) (ZDXKA2016025) and Jiangsu Provincial Special Program of Medical Science (BE2019749).

Topic: Acute respiratory failure and mechanical ventilation.

000058

Respiratory function at 3 months after hospital discharge in critically ill patients with COVID-19

F. J. Lobato¹, G. Tavares¹, F. Trindade Neto¹, S. Souza¹, H. Freitas¹, A. Cruz¹, A. Silva¹, J. Azevedo¹

¹ICU, Hospital São Domingos, São Luís, Brazil

Correspondence: J. Azevedo

Intensive Care Medicine Experimental 2023, **11(Suppl 1)**:000058

Introduction. Up to 20% of patients with COVID-19 get critically ill and require intensive care unit (ICU) admission. At hospital discharge, most patients still have physical and mental limitations, which affect their quality of life. Pulmonary functional alterations in patients with COVID-19 vary from the absence of functional abnormalities to restrictive and diffusion impairments.

Objectives. We aimed to describe pulmonary function abnormalities as well as their impact on the 6-min walk test (6 MWT) and SF-36 physical component summary (PCS) score in patients with COVID-19 at ≥ 3 months after hospital discharge.

Methods. This retrospective observational cohort study included 65 patients 18 years and older with severe COVID-19 confirmed by real-time reverse transcriptase-polymerase chain reaction (RT-PCR), admitted to a 35-bed intensive care unit of a tertiary hospital from April 2020 to October 2021. Pregnant and breastfeeding women, palliative care as well as chronic obstructive pulmonary disease and symptomatic asthmatic patients were excluded. Patients were evaluated after at least 3 months after hospital discharge in our multidisciplinary follow-up clinic. A trained research team applied the 6-min walk test, pulmonary function tests and the physical component summary (PCS) score of quality of life. Pulmonary function tests included forced vital capacity (FVC), forced expiratory volume in the first second (FEV1), FEV1/FVC ratio and MMEF (maximal mid-expiratory flow) using spirometer Spirobank II—MIR, Italy. The standardization and categorization of functional changes were based on Brazilian guidelines for pulmonary function tests.

Results. From April 1, 2020, to October 31, 2021, 689 patients were admitted to the ICU for COVID-19 at the Hospital São Domingos. Moreover, 358 and 332 patients were discharged from the ICU and

hospital, respectively. Among them, 65 discharged patients were evaluated at the hospital's ICU follow-up clinic within a median post-discharge period of 146 (120–183) days. The median age of the enrolled participants was 50 years (43–60 years), with 36 (55.3%) men and 29 (44.6%) women. The most common comorbidity was hypertension (22 patients, 33.8%), followed by diabetes (13 patients, 20%) and obesity (9 patients, 13.8%). In addition, 45 (69.2%) patients underwent invasive mechanical ventilation. Furthermore, 27 (41.5%) patients had abnormal PFT findings as follows: FVC < 80% in 21 (32.3%) patients, FEV1 < 80% in 17 (26.1%) patients, FEV1 / FVC < 0.7 in 0 patients, and MMEF < 65% in 4 (6.1%) patients. Compared with patients without abnormal PFT findings, patients with abnormal PFT findings were older and had significantly higher ferritin levels [1358 (635–1807) vs. 2000 (886–3000), $p=0.02$]. There were no significant between-group differences in invasive and noninvasive respiratory support, mechanical ventilation duration, vasopressor use, and renal replacement therapy. However, compared with the group with normal PFT findings, the group with abnormal PFT findings showed a significantly lower 6-MWT score [78% (0.0–92) vs. 95% (75–100), $p=0.01$] and worse PCS scores [39.4 (32.1–51.3) vs. 52.0 (47.4–57.3), $p=0.007$].

In the logistic regression model of PFT after 4 months with adjustment for independent covariates, multivariate analysis showed statistical significance for the PCS ($p=0.01$) and a tendency toward significance for the 6-MWT ($p=0.09$).

Conclusions. This retrospective study showed that a significant proportions of patients who are discharged from hospital after treatment of severe COVID-19 present alterations in pulmonary function tests after at least 3 months of the discharge and these alterations impact on physical functional capacity and quality of life.

References

- Gassel RJJ, Bels JLM, Raafs A, et al. High prevalence of pulmonary sequelae at 3 months after hospital discharge in mechanically ventilated survivors of COVID-19. *Am J Respir Crit Care Med* 2021; 203: 371–4.
- Fortini A, Torrigliani A, Sbaragli S, et al. COVID-19: persistence of symptoms and lung alterations after 3–6 months from hospital discharge. *Infection* 2021;49: 1007–15.
- Mo X, Jian W, Su Z, et al. Abnormal pulmonary function in COVID-19 patients at time of hospital discharge. *Eur Respir J.* 2020;55:2001217
- Garrigues E, Janvier P, Kherabi Y, et al. Post-discharge persistent symptoms and health-related quality of life after hospitalization for COVID-19. *J Infect.* 2020;81:e4–6.

Topic: Acute respiratory failure and mechanical ventilation.

000060

Improving delirium care in surgical intensive care unit

J. Wee¹, N. L. B. Abdul Jalal²

¹Anaesthesia, Tan Tock Seng Hospital, Singapore, Singapore;

²Occupational Therapy, Tan Tock Seng Hospital, Singapore, Singapore

Correspondence: J. Wee

Intensive Care Medicine Experimental 2023, **11(Suppl 1)**:000060

Introduction. Quality Improvement (QI) Project was set out in the Surgical Intensive Care Unit (SICU) with aim to improve Delirium Management. Duration of delirium is an independent predictor of long-term cognitive impairment after critical illness. Delirium in ICU results in increased morbidity and mortality, motor, cognitive and functional decline, LOS in hospital & hospital costs. 66–84% of delirium in its hypoactive form remains unrecognized. Early diagnosis of delirium improve the prognosis of the patients.

Objectives. To increase the percentage of patients (aged 65 years old and above, SICU emergency admission) receiving optimal delirium management** from 17 to 80% within 6 months.

**Optimal delirium management includes both timely detection and structured delirium intervention.

Timely detection of delirium

+ delirium risk assessment within 24h of admission to SICU.

+ accurate CAM-ICU use.

+ delirium documented as current issue in patient's notes.

Structured delirium intervention

+ correct siting of patient to receive multi-disciplinary delirium management care.

+ delirium prevention OR delirium intervention.

Methods. Methodology used for Quality Improvement Project, including macro and micro flowchart following a patient journey, root cause analysis as evidenced on the cause and effect diagram. Pareto chart to determine which root causes to embark on to target root cause for interventions. Intervention were then carried out through Plan-Do-Study-Act (PDSA) cycles to implement interventions in a step wise process and measure if there are improvements to the rates of Delirium Care management during the period of May through July 2022.

Results. With the implementation of a multi-disciplinary delirium management with the aim to improve optimal delirium management, the baseline rate for optimal delirium care increased from 17% to 31.3% on average 11 weeks after initiation of the quality improvement. This includes timely detection of delirium onset as well as structured delirium management strategies based on risk categories—with patients at lower risk into delirium prevention or higher risk patient receiving delirium intervention.

There was also 1 day reduction in delirium duration of 4 to 3 days for those who developed duration after the interventions has been introduced, and these could translate to potential cost savings of SGD \$44,255. ICU length of stay is also reduced by 1 day.

We recognize that delirium is also multifactorial, and data from retrospective collection of data could have its limitations as well, and results showed are of association rather than causation. There are also other benefits of having a structured management plan which includes better coordination and awareness among various multidisciplinary care teams—including the nursing, physiotherapist, occupational and medical team in managing the patient.

Conclusions. In conclusion, delirium which has a multifactorial cause, would benefit from a structured management plan. Patients at risk of delirium should be assessed for delirium routinely and multi-disciplinary structured intervention targeted to patients based on their risk categories. This could help to reduce delirium duration, potentially length of ICU stay and significant cost savings.

References

1. Cerejeira & Mukaetova-Ladinska, 2011
2. Spronk, Rickerk & Rommes, 2009
3. Peterson et. al, 2006
4. Girard et al., 2010
5. Rivosecchi et al., 2015
6. Brummel & Girard, 2013

Topic: Sedation, analgesia and delirium.

000063**Risk prediction for subsequent infection after colonization with carbapenem-resistant *Enterobacteriales***

G. Zheng¹, H. Bai², C. Jiaqi³, H. Juan⁴

¹School of Public Health, Li Ka Shing Faculty of Medicine, The University of Hong Kong, Shanghai, China; ²Pharmacy, Chongqing University Cancer Hospital, Chongqing, China; ³Clinical Laboratory, Kunshan Hospital Affiliated to Nanjing University of Chinese Medicine, Kunshan, China; ⁴Pharmacy, Ruijin Hospital Affiliated to Shanghai Jiao Tong University School of Medicine, Shanghai, China

Correspondence: G. Zheng

Intensive Care Medicine Experimental 2023, **11(Suppl 1)**:000063

Introduction. Colonization of carbapenem-resistant *Enterobacteriales* (CRE) is considered as one of vital preconditions for infection, with high morbidity and mortality. Identifying potential risk factors for the switch from CRE colonization to infection is significant for early detecting high-risk patients and developing effectively preventive and therapeutic strategies.

Objectives. To construct a reliable prediction model and develop preventive and therapeutic strategies for those high-risk infected CRE carriers.

Methods. A retrospective cohort study was conducted in two Chinese tertiary hospitals for patients with CRE colonization from 2011 to 2021. Univariate analysis and the Fine-Gray subdistribution hazard model were utilized to identify potential risk factors for CRE-colonized infection, while death was the competing event. A nomogram was established to predict 30-day and 60-day risk of CRE-colonized infection.

Results. 879 eligible patients were enrolled in our study and divided into training (n=761) and validation (n=118) group, respectively. There were 196 (25.8%) patients suffered from subsequent CRE infection within 20 (interquartile range [IQR], 14–32) days after detection of colonization. Multisite colonization, polymicrobial colonization, catheterization and receiving albumin after colonization, concomitant respiratory diseases, receiving carbapenems and antimicrobial combination therapy before CRE colonization within 90 days were reserved in final model. Model discrimination and calibration were acceptable for predicting the probability of 60-day CRE-colonized infection in both training (area under the curve [AUC], 74.7) and validation dataset (AUC, 81.1). Decision-curve analysis revealed a significantly better net benefit in current model.

Conclusions. In conclusion, as a convenient clinical tool, our nomogram exhibits a good predictive performance, which could be useful to early identify CRE carriers with high risk of subsequent infection.

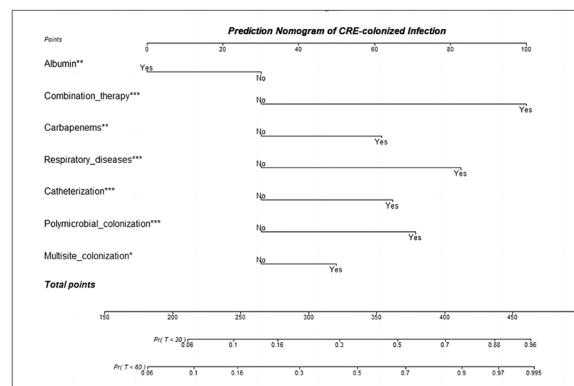

Model-informed nomogram for prediction of 30-day and 60-day cumulative risk of developing subsequent CRE infection. Abbreviation: CRE: carbapenem-resistant *Enterobacteriales*; Pr: Probability; T: Time (days).

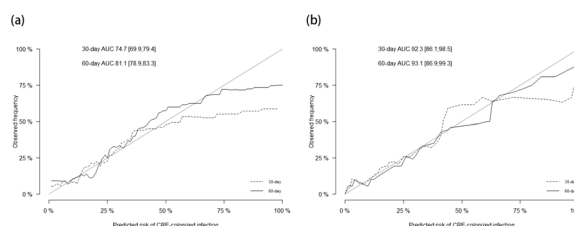

Calibration curves for the (a) training dataset and (b) validation dataset. The AUC is expressed as the point estimates and 95% CI. A clinical prediction model with an AUC value > 80 is deemed to have a good discriminatory accuracy. The 45° angle long black solid line indicates an ideal calibration, as predicted and observed probabilities are equal. Abbreviations: AUC: the area under the curve; CI: confidence interval; CRE: carbapenem-resistant *Enterobacteriales*.

References

- Zhang L, Zhai W, Lin Q, Zhu X, Xiao Z, Yang R, et al. Carbapenem-resistant Enterobacteriaceae in hematological patients: Outcome of patients with Carbapenem-resistant Enterobacteriaceae infection and risk factors for progression to infection after rectal colonization. *Int J Antimicrob Agents* 2019;54(4):527–9.
- Giannella M, Trecarichi EM, De Rosa FG, Del Bono V, Bassetti M, Lewis RE, et al. Risk factors for carbapenem-resistant *Klebsiella pneumoniae* bloodstream infection among rectal carriers: a prospective observational multicentre study. *Clinical microbiology and infection: the official publication of the European Society of Clinical Microbiology and Infectious Diseases* 2014;20(12):1357–62.
- Borer A, Saidel-Odes L, Eskira S, Nativ R, Riesenber K, Livshitz-Riven I, et al. Risk factors for developing clinical infection with carbapenem-resistant *Klebsiella pneumoniae* in hospital patients initially only colonized with carbapenem-resistant *K pneumoniae*. *American journal of infection control* 2012;40(5):421–5.
- Schechner V, Kotlovsky T, Kazma M, Mishali H, Schwartz D, Navon-Venezia S, et al. Asymptomatic rectal carriage of blaKPC producing carbapenem-resistant Enterobacteriaceae: who is prone to become clinically infected? *Clinical microbiology and infection: the official publication of the European Society of Clinical Microbiology and Infectious Diseases* 2013;19(5):451–6.
- Tischendorf J, de Avila RA, Safdar N. Risk of infection following colonization with carbapenem-resistant Enterobacteriaceae: A systematic review. *American journal of infection control* 2016;44(5):539–43.
- Khawcharoenporn T, Laichuthai W. Subsequent carbapenem-resistant Enterobacteriaceae (CRE)-associated infections among hospitalized patients with CRE colonization: Impact of antibiotic use and other factors. *Infect Control Hosp Epidemiol* 2020;41(9):1084–9.

Topic: Infections and prevention.

000067

Early versus late continuous renal replacement therapy in ACLF Patients with septic shock and acute kidney injury—a randomized controlled trial [NCT03343340]

R. Maiwall¹, H. Ashinikumar², N. Chauhan², A. Kumar², H. Tevetia¹, V. Rajan¹, S. K. Sarin¹

¹Hepatology, Institute of Liver and Biliary Sciences, New Delhi, India;

²Department of Molecular and Cellular Medicine, Institute of Liver and Biliary Sciences, New Delhi, India

Correspondence: R. Maiwall

Intensive Care Medicine Experimental 2023, **11(Suppl 1)**:000067

Introduction. Early initiation of continuous renal replacement therapy (CRRT) improves outcomes in patients with acute liver failure (ALF), however there are no studies in patients with acute on chronic liver failure (ACLF).

Methods. ACLF patients with septic shock and Stage 3 AKI after initial fluid resuscitation underwent open-label randomization to early group (EG) wherein CRRT was initiated within 6–24 h of presentation while in the late group (LG) CRRT was initiated once the patient met absolute criteria. Dialysis response was defined as improvement in hemodynamics with lactate clearance after initiation of CRRT at 48 h. Renal recovery was defined as discontinuation of CRRT with improvement in renal functions and urine output > 400 ml/day in patients who were anuric. Urine and plasma samples (n = 30) were collected at initiation of CRRT and after 48 h for analysing the impact of CRRT

on markers of inflammation and endothelial function, renal injury and repair. Primary endpoint was 28-day mortality.

Results. Fifty-one patients with ACLF (aged 41.36 ± 9.57 years, 93% males), 78% alcohol-related with mean MELD 37.72 ± 6.84, and SOFA 12.36 ± 3.10 score were enrolled. Baseline demographic and renal parameters were comparable. The cause of sepsis in the majority of patients was pneumonia [80.0% vs. 83.7%; p = 0.795] in EG vs. LG respectively. Dialysis response was associated with higher chances of renal recovery, P < 0.001, OR 0.118, 95% CI 0.061–0.226. Time to CRRT initiation from septic shock was significantly associated with renal recovery, P = 0.011, OR 0.95, 95% CI 0.92–0.99. Each hour delay in initiation of CRRT from the onset of septic shock was associated with 5% decrease chance of renal recovery. The mean time to CRRT in EG (n = 50) and LG (n = 50) after vasopressors was 14.47 ± 5.38 and 47.73 ± 27.98 h respectively (p < 0.001). Mean dosage of CRRT in both group was not different [20.13 ± 0.82 vs. 20.76 ± 2.21; p = 0.135]. Mortality at 28-days [20 (48.8%) vs. 36 (81.8%); p = 0.048] was significantly lower in the EG. Patients in EG showed a significantly higher urea reduction ratio [27 (54%) vs. 14 (28.6%); p = 0.014], recovery of renal functions [22 (44%) vs. 10 (20%); p = 0.018], and a lower incidence of intradialytic hypotension (IDH) [23 (39.7%) vs. 35 (60.3%); p = 0.025]. The two groups were comparable for achievement of target ultrafiltration goals [19 (43.2%) vs. 11 (23.9%); p = 0.074], lactate clearance at 24 h [20 (45.5%) vs. 14 (30.4%); P = 0.192], and the duration of intensive care unit stay (7.12 ± 2.38 vs. 5.43 ± 1.67; p < 0.001). The dialysis response was higher in EG [36 (72%) vs 25 (50%); p = 0.031] and the duration of RRT was better in EG [60.9 ± 51.7 vs. 33.9 ± 45.9; p = 0.032]. Patients in LG showed significantly higher renal injury and decreased renal repair markers at CRRT initiation. A significant decrease in renal and endothelial injury, increase in repair markers was noted in dialysis-responders. [Figure].

Conclusions. Early initiation of CRRT restores hemodynamics, endothelial function, enhances renal recovery and improves overall outcomes and should be considered in ACLF patients with septic shock and AKI.

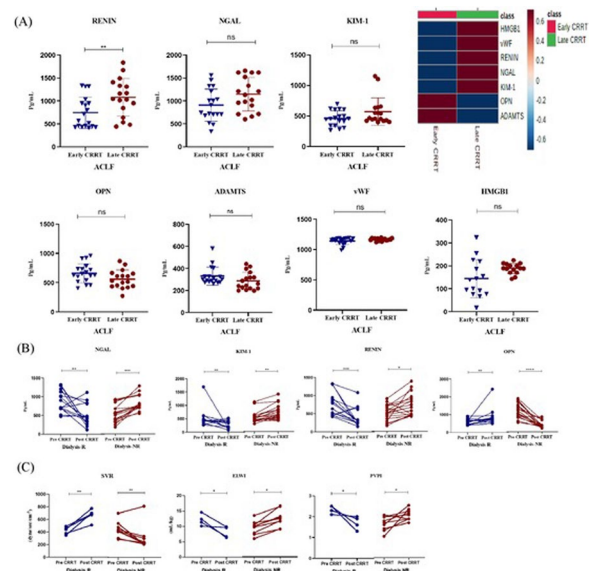

Fig 1 (abstract 000067) In baseline urine maker analysis, renal injury marker Renin were significantly high in late CRRT (continuous renal replacement therapy) with respect to patients with early CRRT. Also, heatmap depicted the segregation in their respective groups. (B) Further, urine NGAL, renin and KIM - 1 (Kidney injured molecule-1) were significantly elevated after post RRT in dialysis non-responder

(D-NR) patients, while these markers were declined after post therapy in case of dialysis responders (DR). Also, the renal repair marker OPN (osteopontin) was significantly increased after post therapy in DR as compared to D-NR. In vascular functional analysis, ADAMTS (was significantly elevated after RRT in DR as compared to D-NR. On the other hand, vascular injury marker vWF (Von Willebrand factor) was significantly increased after therapy in D-NR. (C) Furthermore, patients with DR showed improvement in Pulmonary functionality [lung water (ELWI), pulmonary vascular permeability index (PVPI) and systemic vascular resistance (SVR)].

References

1. Effect of Early vs Delayed Initiation of Renal Replacement Therapy on Mortality in Critically Ill Patients With Acute Kidney Injury: The ELAIN Randomized Clinical Trial. Zarbock et al. *Trials* 2016 May;315(20):2190–9. <https://doi.org/10.1001/jama.2016.5828>.
2. The Artificial Kidney Initiation in Kidney Injury 2 (AKIKI2): Study protocol for a randomized controlled trial. Gaudry et al. *Trials* (2019) 20:726 <https://doi.org/10.1186/s13063-019-3774-9>
3. Initiation Strategies for Renal-Replacement Therapy in the Intensive Care Unit. S. Gudrey et al. <https://doi.org/10.1056/NEJMoa1603017>. Epub 2016 May 15.
4. Natural history, spectrum and outcome of stage 3 AKI in patients with acute-on-chronic liver failure. Rakhi et al. *Liver International* 42(10), August 2022. <https://doi.org/10.1111/liv.15413>

Topic: Acute Kidney Injury and haemofiltration.

000069

Usefulness of phase angle on bioelectrical impedance analysis as a surveillance tool for postoperative infection in critically ill patients

Y. J. Chung¹, K. Hyesung¹, G. R. Lee¹, E. Y. Kim¹, J. Yoojin¹

¹Division of Trauma and Surgical Critical Care, Department of Surgery, The Catholic University of Korea Seoul St. Mary's Hospital, Seoul, Republic of Korea

Correspondence: Y. J. Chung

Intensive Care Medicine Experimental 2023, **11(Suppl 1)**:000069

Introduction. Bioelectrical impedance analysis (BIA) has advantages of obtaining results quickly, safely, reproducibly, and non-invasively. Phase angle (PhA) is one of the parameter of BIA, its values represent the permeability or integrity of cell membrane. With the exception of C-reactive protein (CRP), few studies have estimated an association between PhA and these conventional biomarkers. Herein, we aimed to investigate the association between the PhA value and the conventional inflammatory markers in postoperative patients in intensive care unit (ICU). Also, the correlation between the change in PhA and the occurrence of infectious complication were determined.

Methods. From July 2020 to February 2022, retrospective observation study conducted in 221 patients who admitted to ICU after abdominal surgery. BIA measurements and blood sampling were routinely performed the next morning. The relationship between PhA and the inflammatory markers were assessed after adjusting for age and body mass index (BMI). Univariate and multivariate logistic regression analysis was performed to examine the predisposing factors for postoperative infections.

Results. Among 221 patients admitted to ICU after abdominal surgery, infectious complications occurred in 62 cases. CRP, procalcitonin, or presepsin levels were negatively correlated with PhA in both gender. (-0.295 , -0.198 or -0.212 of partial correlation coefficients, respectively in males, and 0.313 , -0.245 or -0.36 of partial correlation coefficients, respectively in females) But, white blood cell did not show significant association with PhA in both genders. For males, increased level of CRP on postoperative day1(POD1) was revealed as

the significant predicting factor for postoperative infectious complication [odds ratio (OR): 1.184, 95% confidence interval(CI): 1.090–1.285, $p < 0.001$]. For females, increased Acute Physiology and Chronic Health Evaluation II score at admission (OR: 1.457, 95% CI: 1.068–1.987, $p = 0.018$), increased level of presepsin on POD1 (OR: 1.003, 95% CI: 1.001–1.006, $p = 0.016$) and decreased value of PhA on POD1 (OR: 0.980, 95% CI: 0.967–0.993, $p = 0.003$) were revealed as the significant predicting factors.

Conclusions. Phase angle obtained through BIA can be used as a predictor of infection as it shows a significant association with inflammatory markers. Phase angle measurements through BIA could improve patient prognosis after abdominal surgery through the careful observation of infections and early, appropriate treatment.

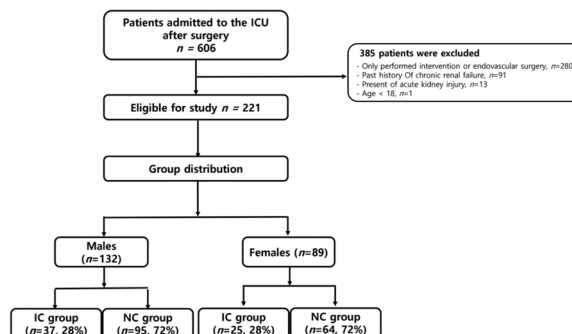

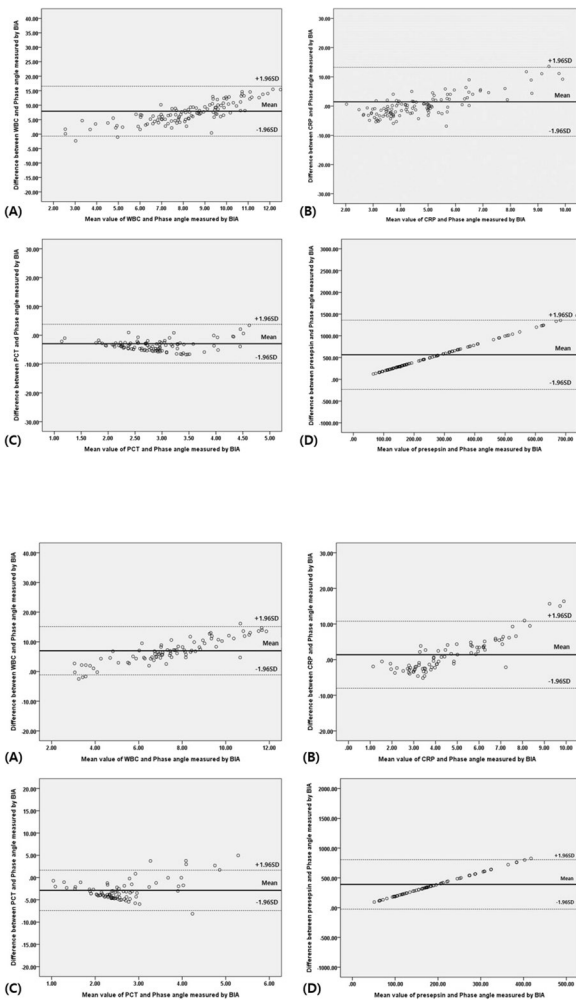

References

- Okano K, Hirao T, Unno M, Fujii T, Yoshitomi H, Suzuki S, et al. Postoperative infectious complications after pancreatic resection. *Br J Surg.* (2015) 102:1551–60. <https://doi.org/10.1002/bjbs.9919>
- Pessaux P, Msika S, Atalla D, Hay JM, Flamant Y. Risk factors for postoperative infectious complications in noncolorectal abdominal surgery: a multivariate analysis based on a prospective multicenter study of 4718 patients. *Arch Surg.* (2003) 138:314–24. <https://doi.org/10.1001/archsurg.138.3.314>
- No additional investigators were involved in this research project.

Topic: Infections and prevention.

000070

Cytomegalovirus reactivation in severe COVID-19 patients. Time to bear it in mind

V. Ruiz de Santaquiteria Torres¹, A. Estrella Alonso¹, R. Fernández Tobar¹, N. Arriero Fernández¹, M. D. M. Rubio Arroyo², B. Castiñeiras Amor¹, Z. Eguileor Marín¹, J. P. Copa Morales¹, GA. González Wagner¹, W. Chas Brami¹, J. E. Romo Gonzales¹, C. Benito Puncel¹, B. Mariblanca-Nieves¹,

R. Garcia Hernández¹, A. Albaya Moreno¹, N. Agurto-Rivera¹, A. Gonzalez Praetorius³, D. L. Meza Escobar³, C. Marian Crespo¹, J. A. Silva Obregón¹
¹Intensive Care Unit, Hospital Universitario de Guadalajara, Guadalajara, Spain; ²Obstetrics and Gynaecology, Hospital Universitario de Guadalajara, Guadalajara, Spain; ³Microbiology department, Hospital Universitario de Guadalajara, Guadalajara, Spain

Correspondence: V. Ruiz de Santaquiteria Torres
 Intensive Care Medicine Experimental 2023, 11(Suppl 1):000070

Introduction. Cytomegalovirus (CMV) reactivation must be kept in mind in differential diagnosis over Intensive Care Unit (ICU) admitted critical patients, especially SARS-CoV-2 sufferers.

Objectives. To evaluate CMV reactivation precocity over severe COVID-19 pneumonia patients, we decided to describe incidence and time to diagnose.

Methods. A descriptive study (February 2020 to December 2022) over severe SARS-CoV-2 pneumonia admitted to Guadalajara ICU (Spain). Demographics, severity, time to CMV reactivation diagnosis and type of sample were evaluated. Samples were extracted in patients with hematologic or hepatic analytics alterations, fever or sudden respiratory deterioration. The diagnosis was made by plasma and/or bronchoalveolar lavage (BAL) polymerase chain reaction (PCR). Categorical variables were expressed as frequencies and percentages, and qualitative as median and interquartile range.

Results. PCR for CMV was extracted from over 125 (42,4%) out of 295 patients (100%) admitted to ICU with severe COVID-19 pneumonia. The time from ICU admission to CMV reactivation suspicion median was 9 days, and 20 days from ICU admission to symptoms onset. BAL PCR was performed in 77 patients (61,6%), plasma PCR in 97 patients (77,6%) and both-acquired in 49 patients (29,2%). A positivity of 28.6% (22 patients) in BAL samples, 46.4% (45 patients) in plasma samples, and 34,7% (17 patients) in both-acquired was found (see table).

Variables	N = 125
Demographics and severity	
Age (years)	67,0 (58,9–73,53)
Male (%)	90 (72,0)
Charlson Comorbidity Index	3 (2–4)
APACHE II	18 (15–21)
SOFA	7 (5–8)
Symptoms onset—ICU admission (days)	10 (7–14)
ICU stay (days)	30,8 (18,3–48,0)
ICU mortality (%)	41 (32,8)
Related to CMV reactivation	
Symptoms—Suspicion (days)	20 (13–25)
ICU admission—Suspicion (days)	9 (2–12)
CMV reactivation (%)	50 (40)
Symptoms—CMV reactivation	20 (14–26)
ICU admission—CMV reactivation	10 (3–13)
Samples	
BAL samples (%)	77 (61,6)
BAL positivity (%); (n = 77)	22 (28,6)
Plasma samples (%)	97 (77,6)
Plasma positivity (%); (n = 97)	45 (46,4)
BAL and plasma samples (%)	49 (29,2)
Both-acquired positivity (%); (n = 49)	17 (34,7)
APACHE: Acute Physiology and Chronic Health Evaluation. SOFA: Sequential Organ Failure Assessment. ICU: Intensive Care Medicine Experimental Unit. CMV: Cytomegalovirus. BAL: Bronchoalveolar Lavage	

Conclusions. In our series, the time from ICU admission to CMV reactivation suspicion median was 9 days and 20 days to symptoms onset. CMV reactivation incidence was 40% in those who were suspected. CMV reactivation must be early and actively searched in severe COVID-19 pneumonia ICU-admitted patients.

Topic: Infections and prevention.

000075

Post-traumatic stress disorder and resilience process of patients following a stay in intensive care for severe critical illness requiring mechanical ventilation: Resirea study

A. Mathieu¹, J. Reignier², A. Le Gouge³, G. Plantefeve⁴, J. P. Quenot⁵, V. Maxime⁶, L. Argaud⁷, P. Asfar⁸, J. Badie⁹, N. V. Botoc¹⁰, H. N. Bui¹¹, D. Chatellier¹², L. Chauvelot¹³, M. Darmon¹⁴, A. Delbove¹⁵, J. Devaquet¹⁶, L. M. Dumont¹⁷, O. Gontier¹⁸, S. Groyer¹⁹, L. Guerin²⁰, Y. Hourmant²¹, S. Jaber²², F. Lambiotte²³, B. Madeux²⁴, A. Laurent²⁵

¹Psychology, University of Burgundy, Dijon, France; ²Médecine intensive réanimation, Nantes University Hospital Hotel-Dieu, Nantes, France; ³Statistic department, Chru Hôpitaux De Tours, Hospital Bretonneau, Tours, France; ⁴Medical surgical intensive care unit, General Hospital Center, Argenteuil, France; ⁵Medical intensive care unit, Chu Dijon, Dijon, France; ⁶Paris, Raymond Poincaré University Hospital (AP-HP), Garches, France; ⁷Service de médecine intensive-réanimation, Hospital Édouard Herriot, Lyon, France; ⁸Médecine intensive réanimation, centre hospitalier universitaire d'Angers, Angers, France; ⁹Intensive care unit, Hospital Nord Franche-Comté, Trévenans, France; ¹⁰Ille et Vilaine, Hospital Center De Saint-Malo, Saint-Malo, France; ¹¹Réanimation médicale, CHU Pellegrin, Bordeaux, France; ¹²Médecine intensive et réanimation, CHU de Poitiers, Poitiers, France; ¹³Médecine intensive et réanimation, Hospital La Croix-Rousse—Hcl, Lyon, France; ¹⁴Medical icu, Hôpital Saint-Louis, Paris, France; ¹⁵Medical intensive care unit, Hospital Center Bretagne Atlantique, Vannes, France; ¹⁶Intensive care unit, Hospital Foch, Suresnes, France; ¹⁷Paris, Louis-Mourier Hospital, Colombes, France; ¹⁸Intensive care unit, Hospital Louis Pasteur, Le Coudray, France; ¹⁹Tarn et Garonne, Hospital De Montauban, Montauban, France; ²⁰Médecine intensive réanimation, Bicetre Hospital AP-HP, Le Kremlin-Bicêtre, France; ²¹Surgical ICU, University Hospital of Nantes, Nantes, France; ²²(8) anesthesia and critical care department b, Centre Hospitalier Universitaire Montpellier, Montpellier, France; ²³Intensive care unit, Hospital Jean Bernard, Valenciennes, France; ²⁴Hautes Pyrénées, Hospital Center De Bigorre, Tarbes, France; ²⁵Psy-DREPI, University of Burgundy, Dijon, France

Correspondence: A. Mathieu

Intensive Care Medicine Experimental 2023, **11(Suppl 1)**:000075

Introduction. Patients in intensive care units experience a sudden and critical state with high risk of death. This can lead to a post-traumatic impact potentially long-lasting. This study aims to identify traumatized patients or not following their stay, to assess their resilience skills and to have a better understanding in the involvement of some factors in the resilience process such as social support, illness perception or quality of life.

Methods. Complementary to the medical study NUTRIREA-3, RésiRéa is a prospective and longitudinal study involving 42 different units of intensive care in France. At two different times (3 months and 1 year after ICU), patient hospitalized for severe critical illness were asked to answer 5 scales assessing post-traumatic stress (IES-R), resilience (CDRISC), quality of life (SF-36), illness perception (BIPO) and social support (MSPSS). Resilience was defined by a score at CDRISC \geq 80 and a low score at IESR (absence of post-traumatic stress).

Results. A total of 380 patients have been included: 125 women (32.9%) and 255 men (67.1%), 61 \pm 13 years old, IGS2 56 \pm 18, SOFA 10 \pm 3., 22.1% [17.9; 26.9] were suffering from post-traumatique stress at 3 months and 17.3% [12.6; 22.9] at 1 year. The rate of patients with a score of CDRISC \geq 80 was 18.0% [14.0; 22.6] at 3 months and 24.3% [18.8; 30.5] at 1 year. The rate of resilient patients was 12.6% [9.5; 16.4]. In comparison to non resilient patients, resilient patients had a higher score of social support at 3 months (MSPSS 78.9 \pm 9.3 vs. 70.9 \pm 14.3,

$p < 0.001$), a better peception of illness (BIPQ 27.7 \pm 8.8 vs 38.2 \pm 12.6, $p < 0.001$) and a better quality of life (PCS 44.1 \pm 10.6 vs 38.9 \pm 10.8, $p = 0.009$; MCS 55.3 \pm 8.1 vs 47.6 \pm 12.4, $p < 0.001$). These differences are still true 1 year after inclusion in the study.

Conclusions. Resilience seems to be an important indicator to consider when focusing on how to better support patients after a stay in intensive care and to reduce the risks of PTSD or increase quality of life. Resilience by patients from ICU seems to be influenced by social support and illness perception.

Topic: Acute respiratory failure and mechanical ventilation.

000078

IRE1 α -XBP1 activation elicited by viral singled stranded RNA via TLR8 may modulate lung cytokine induction in SARS-CoV-2 pneumonia

E. Bustamante-Munguira¹; A. Francisco Amador¹; M. Artola Blanco¹; M. Bustamante-Munguira¹; J. J. Fernández Rodríguez²; N. Mamolar Herrera³; S. Garcinuño Perez⁴; M. A. De Pedro Sanchez²; E. Portugal Rodriguez⁵; M. Sanchez Crespo²

¹Medicina Intensiva, University Clinical Hospital of Valladolid, Valladolid, Spain; ²Medicina, Institute of Molecular Biology and Genetics IBGM, Valladolid, Spain; ³Intensive Care, University Clinical Hospital of Valladolid, Valladolid, Spain; ⁴Microbiología, University Clinical Hospital of Valladolid, Valladolid, Spain; ⁵Intensive Care Unit, Hospital Clínico Universitario Valladolid, Valladolid, Spain

Correspondence: E. Bustamante-Munguira

Intensive Care Medicine Experimental 2023, **11(Suppl 1)**:000078

Introduction. The pandemic caused by the SARS_CoV-2 coronavirus is a major healthproblem worldwide. The virus presents with variable clinical pictures, ranging from asymptomatic patients to episodes of severe pneumonia with symptoms of adultrespiratory distress (ARDS). Virus use host cellorganelles to produce their proteins and thus overwhelm the protein-folding capacity of the endoplasmic reticulum (ER). This process evokes ER stress and activation of the unfolded protein response (UPR), an adaptivesignaling pathway directed to preserve ER homeostasis.The IRE1 α -XBP1 branch of the UPR is activatedin many viral diseases, and viral RNA might trigger the IRE1 α -XBP1 branch via Toll-like receptors.since activation of TLR2 and TLR4 by their cognate ligands underpins cytokine expressionthrough IRE1 α -driven XBP1 splicing (sXBP1).

Objectives. Analyze, through studies of molecular mechanisms, whether the transcription factors activated during the response to misfolded proteins (UPR), inparticular SXBP1, maintain the transcription of genes thatencode the cytokines involved in hyperinflammation. associated with cytokine storm (CT).

Methods. Infection by SARS-CoV-2 causes hyperinflammation and pneumonia in severalpatients. This differs fromcommon viral respiratory infections andtherefore urges a pathophysiological analysis. Viruses use host cellorganelles to produce their proteins and thus overwhelm the protein-folding capacity of the endoplasmic reticulum (ER). This process evokes ER stress and activation of the unfolded protein response (UPR), an adaptivesignaling pathway directed to preserve ER homeostasis. Of note, the IRE1 α -XBP1 branch of the UPR is activatedin many viral diseases, and viral RNA might trigger the IRE1 α -XBP1 branch via Toll-like receptors. Thisis not unexpected, since activation of TLR2 and TLR4 by their cognate ligands underpins cytokine expressionthrough IRE1 α -driven XBP1 splicing (sXBP1). We studied in the nasopharyngeal samples and bronchial aspirates (BAS)of patients with (60 patients) and without (59 patients) Covid-19 admitted to a critical careunit and on invasive mechanical ventilation during the 3rd and 4th wave, the presence or absence of active infection and sXBP1.

Results. After observing a high incidence of sXBP1 in RNA obtained from nasopharyngeal swabs of SARS-CoV-2 infectedpatients, a systematic study was undertaken in samples of bronchoalveolar aspirates (BAAs). Thepresence of sXBP1 and a high expression of IL1B, IL6, and TNF mRNA were detected during active infection. Monocytic/

macrophagic populations showed a reduction of markers associated with antigen presentation and survival, as well as the IFN stimulated gene MX1. In contrast, the expression of the mRNA of the serine protease TMPRSS2 involved in S protein priming showed a high expression. TLR8 mRNA showed an overwhelming expression as compared to TLR7 mRNA. MDDCs activated with ssRNA40, a selective TLR8 ligand-induced sXBP1, and the expression of IL-1 β , IL-6, and TNF α at mRNA and protein levels. These responses were blunted by the IRE1 α ribonuclease inhibitor MKC8866 and enhanced by the non-toxic IRE1 α -XBP1 activator IXA4.

Conclusions. The SARS-Cov-2 coronavirus infection occurs with a viral infection with variable clinical pictures, whose pathogenic mechanisms are still not fully known, as well as its diagnostic and therapeutic management. For this purpose, the present study intends to study the involvement of TLR 7/8 and SxBP 1 in viral sepsis, outline the transcriptional landscape and control the inflammatory cascade, identifying a pathogenic factor and providing an early prognostic biomarker. Experiments showed that activation of immune cell receptors by pathogen-associated molecular patterns mimicking viral RNA induced a pattern of cytokine expression like that observed in bronchoalveolar aspirates of patients with critical COVID-19 pneumonia. The study revealed that cell organelle overload and engagement of receptors targeted by viral RNA team up to produce the proinflammatory cytokines commonly associated with viral sepsis.

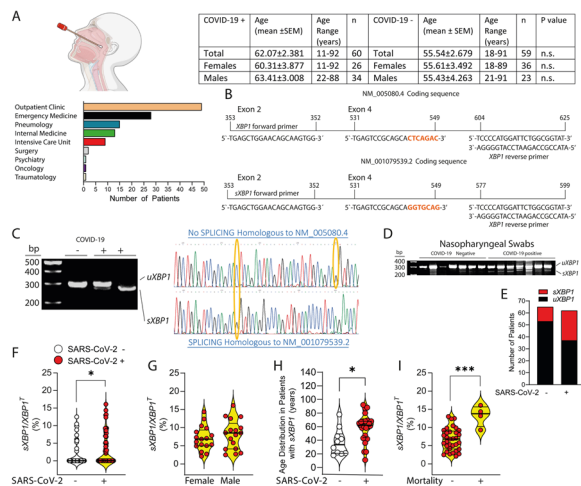

Figure 1 (abstract 000078)

References

- Márquez S, Fernández JJ, Terán-Cabanillas E, Herrero C, Alonso S, Azogil A, et al. Endoplasmic Reticulum Stress Sensor IRE1 α Enhances IL-23 Expression by Human Dendritic Cells. *Front Immunol* (2017) 8:639. <https://doi.org/10.3389/fimmu.2017.00639>
- Calfon M, Zeng H, Urano F, Till JH, Hubbard SR, Harding HP, et al. IRE1 couples endoplasmic reticulum load to secretory capacity by processing the XBP-1 mRNA. *Nature* (2002) 415(6867):92–6. <https://doi.org/10.1038/415092a>.
- Bettigole SE, Glimcher LH. Endoplasmic Reticulum Stress in Immunity *Annu Rev Immunol* (2015) 33:107–38. <https://doi.org/10.1146/annurev-immunol-032414-112116>
- WPS "Immune"

Topic: Sepsis.

000085

The prognostic utility of oxygenation index in acute respiratory distress syndrome: a meta-analysis

D. Jayasimhan¹, J. Chieng², J. Kolbe², D. Sidebotham³

¹Intensive Care Unit, Wellington Regional Hospital, Wellington, New Zealand; ²Department of Respiratory Medicine, Auckland City Hospital, Auckland, New Zealand; ³Cardiothoracic and Vascular Intensive Care Unit, Auckland City Hospital, Auckland, New Zealand

Correspondence: D. Jayasimhan

Intensive Care Medicine Experimental 2023, 11(Suppl 1):000085

Introduction. The severity of acute respiratory distress syndrome is determined by the ratio of partial pressure of oxygen to the fraction of inspired oxygen (PaO₂:FiO₂), a measure that inconsistently predicts mortality. PaO₂:FiO₂ does not consider the effect of alveolar pressure on oxygenation, which may account for its imprecision. The oxygenation index is a simple bedside tool that incorporates mean airway pressure with PaO₂:FiO₂, which may reflect a more accurate measure of oxygenation. First studied as a tool in neonatal and paediatric respiratory, failure, its utility in the prognostication of adults with ARDS is unclear.

Objectives. We evaluated the ability of oxygenation index to predict mortality in adults with ARDS.

Methods. We systematically searched the MEDLINE, CENTRAL, and Google Scholar databases. We included studies of adults with ARDS reporting oxygenation index and mortality. We performed a meta-analysis of the mean difference in survivors vs non-survivors and adjusted results from multiple logistic regression using a random effects model. We assessed heterogeneity using the I² statistic.

Results. We included eight studies in our meta-analysis from our search of 1248 records. In six studies reporting differences between survivors and non-survivors, oxygenation index was significantly lower in survivors than non-survivors (n, 1329; Mean Difference, -2.87; 95%CI, -3.97 to -1.77; I², 1%). Among the six studies that controlled for confounders, oxygenation index was independently associated with mortality (n, 1209; OR, 1.06; 95% CI, 1.02 to 1.10; I², 46%).

Conclusions. Among adults with ARDS, survivors have a significantly higher oxygenation index than those who died. Oxygenation index is also independently associated with mortality in adults with ARDS.

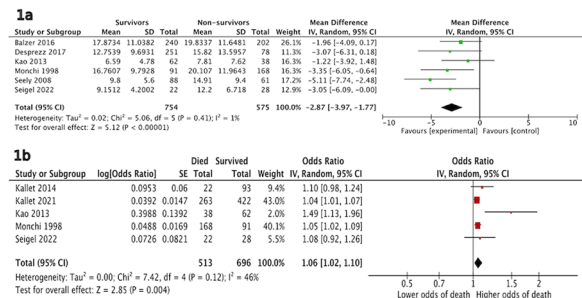

Mean difference in oxygenation index between survivors and non-survivors (Fig. 1a) and adjusted odds of mortality for every 1 unit increase in oxygenation index (Fig. 1b).

Topic: Acute respiratory failure and mechanical ventilation.

000087

The depth of central venous catheter in left subclavian compare with supraclavicular using peres formula

B. Lubis¹, P. Mathilda², B. Luwih³

¹Anesthesiology, Universitas Sumatera Utara, Medan, Indonesia;

²Anesthesiology, laksana 15, Medan, Indonesia; ³Anesthesiology, haji medan, Medan, Indonesia

Correspondence: A.H. Nasution

Intensive Care Medicine Experimental 2023, **11(Suppl 1)**:000087

Introduction. Central Venous Pressure (CVP) is the measure most often used to guide fluid resuscitation in critically ill patients. CVC placement has become common practice for anesthesiologists and intensivists in operating theaters and intensive care units. It is very important to position the catheter tip in the correct position to avoid the consequences of malposition.

Objectives. To determine the comparison of the accuracy of the tip depth of central venous catheterization in the left subclavian using the Peres formula with evaluation of the radiological images between the supraclavicular and infraclavicular.

Methods. This study used a *double blind RCT (Randomized Clinical Trial)* design, i.e. the research subjects and observers did not know the treatment or intervention given. Sample study are patients who have a *central venous catheter installed* in the emergency room, ICU, or surgery at the Adam Malik Haji Center General Hospital in Medan who fulfill criteria inclusion and exclusion.

Results. The frequency of Supraclavicular samples with incorrect tips was 36 samples (42.4%) and 9 samples (10.6%) were correct. Furthermore, for the experiment using the infraclavicular as many as 32 samples (37.6%) were not correct, while 8 samples (9.4%) the tip was correct. It is known that the analysis was carried out using the Chi-Square test and it was known that there was no significant relationship between groups with the level of accuracy of central venous catheter tip depth ($p = 1.000$).

Conclusions. The accuracy of central venous catheterization in the left subclavian using the Peres formula supraclavicular and infraclavicular is known to be the same, namely 20.0% or 1 out of 5 procedures directly reaches the carina/region about the fifth thoracic vertebra which does not have a significant difference between infraclavicular and supraclavicular.

Table 4. 5 Analysis of average tip distance for central venous catheterization

Data	Means	±SD	Accuracy
Supraclavicular	2.55	1.00	20%
Infraclavicular	2.33	0.79	20%
Total	2.44	0.89	20%

Table (abstract 000087)

References

- Hill B, Smith C. Central venous pressure monitoring in critical care settings. *British Journal of Nursing*. 2021;30(4):230–6. 2. Bodkhe A, Purohit A, Pitale C, Bhirud H. Subclavian vein catheterization: Comparative evaluation of supraclavicular versus infraclavicular approach in oncology patients *Indian Journal of Clinical Anaesthesia*. 2021;8(3): 408–412. <https://doi.org/10.18231/ijca.2021.078>. 3. Javed N, Malik J. Access times for supraclavicular and infraclavicular approaches of subclavian vein catheterization in pacemaker insertion. *International Journal of Health Sciences*. 2020;14(3):14. 4. Govindswamy S, Shamanna AM, Gowda P. Comparison between supraclavicular and infraclavicular approaches for subclavian venous catheterization in adults *Sri Lankan Journal of*

Anaesthesiology. 2017;26(1):34. <https://doi.org/10.4038/slja.v26i1.8269>. 5. Thakur A, Kaur K, Lamba A, Taxak S, Dureja J, Singhal S, et al. Comparative evaluation of subclavian vein catheterisation using supraclavicular versus infraclavicular approach *Indian Journal of Anaesthesia*. 2014;58(2):160. <https://doi.org/10.4103/0019-5049.130818>.

Topic: Cardiovascular issues in ICU.

000088

Effect of thermocycling on the reflection of volatile anesthetics after applying carbon dioxide

D. Brauchle¹, N. Rosinus¹, A. Kermad², A. Brauchle¹, T. Volk¹, A. Meiser¹

¹Department of Anaesthesiology, Intensive Care and Pain Therapy, Saarland University Medical Center and Saarland University Faculty of Medicine, Homburg, Germany; ²Department of Cardiac Anaesthesiology and Intensive Care, German Heart Institute Berlin, Berlin, Germany

Correspondence: D. Brauchle

Intensive Care Medicine Experimental 2023, **11(Suppl 1)**:000088

Introduction. During intensive care therapy, there is often a need for sedation to reduce emotional load and negative memories. With a reflection device, such as the Sedaconda-ACD-S (Sedana Medical, Danderyd, Sweden), it is possible to apply volatile anesthetics efficiently. Most of the agent is adsorbed in the reflection device during expiration and released back to the patient during inspiration. As volatile anesthetics are potent greenhouse gases, it is urgent to reduce their consumption by improving the reflection efficiency of the device.

Objectives. We therefore tested, whether warming the reflector during inspiration and cooling it during expiration (thermocycling) has influence on reflection efficiency.

Methods. A test lung was ventilated with a tidal volume of 500 ml and a respiratory rate of 10/min with an intensive care ventilator. Constant body conditions (37 °C and humidity over 95%) were implemented in the test lung.

Isoflurane was applied with a syringe pump via a Sedaconda-ACD-S with different infusion rates (0.5, 1, 2 and 5 ml/h). After achieving a steady state, isoflurane concentration was measured in the test lung and the reflection efficiency was calculated.

Furthermore, a physiological carbon dioxide concentration (35–45 mmHg) was created in the test lung. The reflector was warmed up to 37 °C during inspiration and cooled down to either 12 °C or 1 °C in expiration (Thermocycling), resulting in a temperature difference of 25 °C ($\Delta 25$) and 36 °C ($\Delta 36$).

Results. After adding carbon dioxide, lower isoflurane concentrations were measured in the test lung. Thermocycling ($\Delta 25$) lead to a significantly higher concentration of isoflurane for every infusion rate even though carbon dioxide was added. Intensifying thermocycling by using a greater temperature difference ($\Delta 36$) resulted in even higher isoflurane concentrations for 0.5, 1 and 2 ml/h. Interpolation of data showed that for achieving 0.4 (0.6) vol% isoflurane, infusion rates can be lowered from 1.17 (1.86) ml/h to 0.77 (1.14) ml/h with thermocycling $\Delta 25$ and to 0.60 (0.90) ml/h with thermocycling $\Delta 36$. To achieve clinical target concentrations, isoflurane consumption may thus be reduced by 34 (39) % and 48 (52) %, respectively. In thermocycling $\Delta 36$ reflection efficiency increased up to 10% resulting in an reflection efficiency of 91%.

Conclusions. The addition of carbon dioxide decreases the reflection efficiency of the Sedaconda-ACD-S. However, its reflection efficiency can be restored and even further improved by thermocycling with temperature differences of 25 °C and of 36 °C. Thereby, isoflurane consumption can be halved.

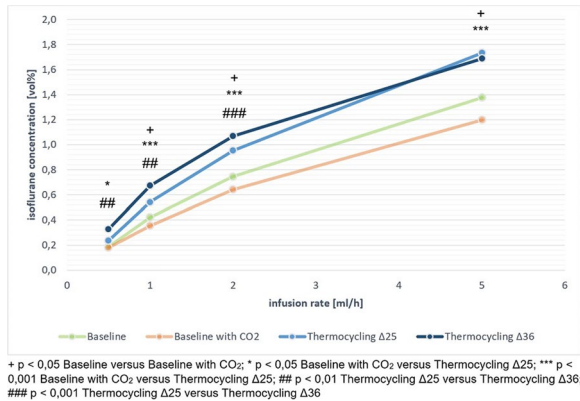

Topic: Acute respiratory failure and mechanical ventilation.

000089

Intraoperative neurological pupil index and postoperative delirium and neurologic adverse events after cardiac surgery: an observational study

H. Kim¹, J. Y. Sohn¹, S. Lee¹, D. Park¹, T. Kim², H. C. Lee¹, J. Bae¹, K. Nam¹, Y. Jeon¹, Y. J. Cho¹

¹Anesthesiology and Pain Medicine, Seoul National University Hospital, Seoul, Republic of Korea; ²Department of Critical Care Medicine, Seoul National University Hospital, Seoul, Republic of Korea

Correspondence: H. Kim

Intensive Care Medicine Experimental 2023, 11(Suppl 1):000089

Introduction. The neurological pupil index (NPI) is calculated based on automated pupillometric parameters and predicts clinical outcomes in critically ill patients. However, there are few data on the association of intraoperative NPi and postoperative clinical outcome after cardiac surgery. We investigated the relationships between intraoperative NPi and postoperative delirium and neurologic outcome after cardiac surgery.

Methods. This study was a sub-analysis of the Registry of Perioperative Data in Cardiovascular Surgery at Seoul National University Hospital. We included patients who underwent pupillometric assessment during cardiac surgery. NPi was measured using an automated digital pupillometer at baseline, after anesthesia induction, at 30 min intervals during cardiopulmonary bypass or anastomosis of coronary artery bypass graft, at protamine infusion, and at skin closure. The worst NPi was recorded, and multivariate logistic regression analysis was performed to evaluate the relationships between abnormal intraoperative NPi and postoperative delirium, neurologic adverse events, and composite outcome, including stroke, acute kidney injury, continuous renal replacement therapy, mechanical circulatory support device, and in-hospital mortality.

Results. Among 123 patients, 19.5%, 24.4%, and 40.7% developed postoperative delirium, neurologic adverse events, and composite outcome, respectively. The worst intraoperative NPi was lower in patients who developed postoperative delirium compared to those who did not (median [IQR], 3.2 [0.0–3.4] vs 3.3 [3.0–3.6], respectively; P=0.009; Fig. 1). Compared to baseline, NPi decreased greater in patients with postoperative delirium at the end of surgery than those did not (P=0.025 between the groups, Mann–Whitney U test; Fig. 2). After adjustment, intraoperative NPi < 3.0 was significantly associated with postoperative delirium (adjusted odds ratio [OR]: 5.314, 95% confidence interval [CI]: 1.280–22.067, P=0.021) and neurologic adverse

events (adjusted OR: 6.689, 95% CI: 1.591–28.124, P=0.009), but not with postoperative composite outcome (adjusted OR: 2.102, 95% CI: 0.555–7.963, P=0.274).

Conclusions. Abnormal intraoperative NPi measured using automated pupillometry independently predicted postoperative delirium and neurologic adverse events, but not the composite outcome, following cardiac surgery. Intraoperative pupillometric measurements may predict postoperative neurologic events and may facilitate early intervention after cardiac surgery.

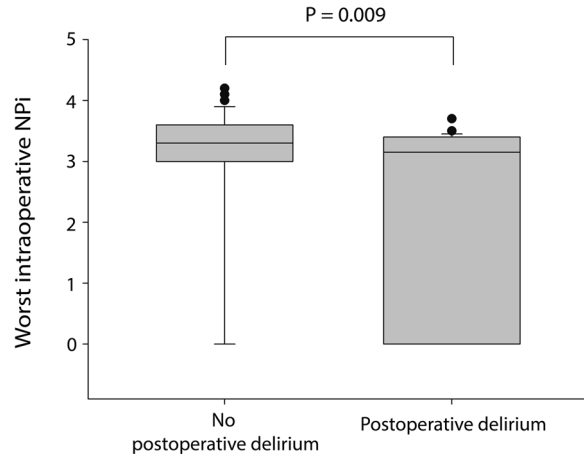

Figure 1 (abstract 000089) Box plot of the worst intraoperative NPi in patients with and without postoperative delirium. NPi, neurological pupil index

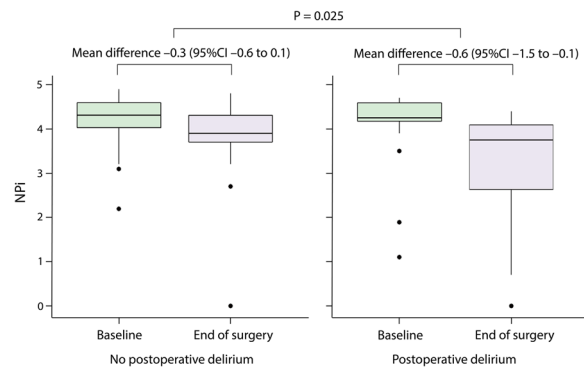

Figure 2 (abstract 000089) Comparison of NPi at baseline and at the end of surgery in patients with and without postoperative delirium. CI, confidence interval; NPi, neurological pupil index

References

- Favre, E. et al. Neuromonitoring of delirium with quantitative pupillometry in sedated mechanically ventilated critically ill patients. Crit. Care 24, 66. <https://doi.org/10.1186/s13054-020-2796-8> (2020).
- Riker, R. R. et al. Neurological Pupil Index and Pupillary Light Reflex by Pupillometry Predict Outcome Early After Cardiac Arrest. Neurocrit. Care 32, 152–161. <https://doi.org/10.1007/s12028-019-00717-4> (2020).
- Couret, D. et al. Reliability of standard pupillometry practice in neurocritical care: an observational, double-blinded study. Crit. Care 20.99. <https://doi.org/10.1186/s13054-016-1239-z> (2016).
- None

Topic: Perioperative care.

000091

Prevention of delirium in the intensive care unit

A. Hagana¹, S. Sivanesan², G. Bhardwaj², T. Ali¹

¹Anaesthetics and Critical Care, Stoke Mandeville Hospital, Aylesbury, United Kingdom; ²Anaesthetics and Critical Care, University of Buckingham, Eaglestone, United Kingdom

Correspondence: A. Hagana

Intensive Care Medicine Experimental 2023, 11(Suppl 1):000091

Introduction. Delirium is characterised as a fluctuating disturbance of consciousness and cognition that develops over a short period of time, with a reported prevalence in nearly a third of critically ill patients (1). It is associated with prolonged mechanical ventilation and hospitalisation, as well as increased risk of hospital mortality and long-term cognitive impairment (1, 2). Various interventions have been proposed in literature to prevent delirium in the intensive care unit, including environmental changes, cognitive stimulation, and addressing factors such as dehydration, constipation, nutrition, and pain (2, 3) Given the high prevalence of delirium in critically ill patients and the associated adverse outcomes, consideration of risk factors to prevent delirium is a crucial component of the care provided in ICU.

Objectives. To investigate the consideration of risk factors by doctors and nurses in preventing delirium in critically ill patients.

Methods. An audit was performed on patients admitted to the ICU between 22/09/22-5/10/22 at Buckinghamshire Healthcare NHS Trust. Daily reviews performed by doctors and nursing notes were assessed to identify whether factors that prevent delirium were considered on each day of the patient's admission. Risk factors that were assessed were selected based on NICE CKS guidelines (4).

Results. The data consisted of 38 patient admissions across two intensive care units.

Table 1 (abstract 000091) Summary of results

Addressing risk factors	Doctors	Nurses
Addressing cognitive impairment/disorientation:	–	–
- Environmental (lighting, signage, clocks, calendars, sleep environment)	0%	5.7%
- Reorientation	1.9%	5.2%
- Cognitively stimulating activities	2.4%	2.4%
- Family/ friend visitation	6.1%	46.2%
Hydration	78.3%	92.9%
Constipation	47.2%	65.1%
Hypoxia	85.4%	90.1%
Immobility	21.7%	88.2%
Pain	62.3%	65.1%
Medication reviews	30.7%	0%
Nutrition	76.4%	91.5%
Sensory impairment	0.5%	0.9%
Sleep	2.4%	13.2%

Conclusions. This audit highlights that factors preventing delirium are poorly considered and implemented by both doctors and nurses in the ICU, with doctors having lower rates across almost all factors in comparison to nurses. This is particularly noted for aspects not commonly considered in a standard medical review, such as addressing cognitive impairment and disorientation through environmental optimisation, as well as active reorientation of patients and improving sensory impairment. These results highlight aspects in the care of critically unwell patients that can be improved to prevent delirium and improve patient outcomes.

References

1. No grants were received for this project.
2. NICE. Delirium: Prevention, diagnosis and management in hospital and long-term care: Guidance. 2010. Available from: <https://www.nice.org.uk/guidance/cg103/chapter/Recommendations#preventing-delirium>
3. Arumugam S, El-Menyar A, Al-Hassani A, et al. Delirium in the Intensive Care Unit. *Journal of Emergencies, Trauma, and Shock*. 2017;10(1):37–46.
4. Brummel NE, Girard TD. Preventing delirium in the intensive care unit. *Critical Care Clinics*. 2013;29(1):51–65.
5. Salluh JF, Wang H, Schneider EB, et al. Outcome of delirium in critically ill patients: systematic review and meta-analysis. *BMJ*. 2015;350:h2538.

Topic: Sedation, analgesia and delirium.

000092

CAM-ICU compliance in the intensive care unit

G. Bhardwaj¹, A. Hagana², S. Sivanesan¹, T. Ali²

¹Anaesthetics and Critical Care, University of Buckingham, Eaglestone, United Kingdom; ²Anaesthetics and Critical Care, Stoke Mandeville Hospital, Aylesbury, United Kingdom

Correspondence: A. Hagana

Intensive Care Medicine Experimental 2023, 11(Suppl 1):000092

Introduction. Delirium is a commonly occurring clinical syndrome in the intensive care unit associated with various adverse outcomes, including increased length of hospital stay, increased risk of hospital mortality and cognitive impairment (1). Early diagnosis through serial assessments to screen for delirium is a crucial component of caring for critically ill patients (2). This can be achieved by utilising The Confusion Assessment Method for the ICU (CAM-ICU), a monitoring and diagnostic tool for delirium, performed twice daily on ICU patients with RASS greater than – 3 (3). Below this, 'unable to assess' (UTA) is assigned due to patient unresponsiveness, although it is suggested this is often inappropriately overused due to misunderstanding surrounding the diagnostic tool and how it is performed (3,4).

Objectives. To assess frequency of daily CAM-ICU measurements performed by nursing staff to evaluate the compliance with guideline recommendations for twice daily CAM-ICU assessments.

Methods. An audit was carried out across two sites at Buckinghamshire Healthcare NHS Trust evaluating the frequency of CAM-ICU measurements performed daily for patients admitted to the intensive care units, consisting of a total of 212 ICU days. UTA inputs were also measured independently, interpreted as an attempt to perform CAM-ICU.

Results. The results show that CAM-ICU was measured at least twice daily on 30.7% of days, not including where they were unable to assess due to low RASS. When also including UTA inputs that occurred at least twice daily, CAM-ICU measurements increased to 59%.

Table 1 (abstract 000092) CAM-ICU daily measurements

No. of CAM-ICU measurements daily	% of total ICU days
0	25.9%
1	9.0%
≥ 2	30.7%
UTA	34.4%

Table 2 (abstract 000092) UTA input breakdown

No. of times UTA inputted daily	% of total UTA days
1	17.8%
≥ 2	82.2%

Conclusions. Overall, this audit highlights that twice daily CAM-ICU compliance is poorly achieved, only occurring on 30.7% of ICU days. Although this improves when UTA attempts are included, it is difficult to ascertain whether these are appropriate inputs and genuine attempts to perform CAM-ICU measurements. This is particularly important considering the high proportion of UTA assessments, at 34.4% of total ICU days, which may be explained by the simple nature of inputting UTA in comparison to performing a thorough CAM-ICU assessment. These results could be in keeping with previous literature suggesting that UTA inputs are inappropriately overused, possibly due to confusion surrounding how CAM-ICU measurements are performed (4). Investigating the accuracy of CAM-ICU measurements and the appropriateness of UTA inputs would be valuable contributions for future studies, allowing for improvements to be made in education and daily practice to optimise CAM-ICU implementation. This would consequently allow for earlier delirium identification and management.

References

- Swan JT. Decreasing inappropriate unable-to-assess ratings for the confusion assessment method for the intensive care unit. *American Journal of Critical Care*. 2014;23(1):60–9.
- Ely EW, Truman B. *Confusion Assessment Method for the ICU (CAM-ICU), The Complete Training Manual*. Nashville: Vanderbilt University. 2016;1–32.
- Miranda F, Arevalo-Rodriguez I, Díaz G, et al. Confusion Assessment Method for the intensive care unit (CAM-ICU) for the diagnosis of delirium in adults in critical care settings. *The Cochrane Database of Systematic Reviews*. 2018;2018(9):CD013126.
- Salluh JIF, Wang H, Schneider EB, et al. Outcome of delirium in critically ill patients: systematic review and meta-analysis. *BMJ*. 2015;350:h2538.

Topic: Sedation, analgesia and delirium.

000093

Treatment escalation plan and CPR status documentation in intensive care

A. Hagana¹, J. Mandeville¹, P. Shanmugasundaram¹, T. Ali¹

¹Anaesthetics and Critical Care, Stoke Mandeville Hospital, Aylesbury, United Kingdom

Correspondence: A. Hagana

Intensive Care Medicine Experimental 2023, **11(Suppl 1)**:000093

Introduction. The treatment escalation plan (TEP) and CPR status are important tools in critical care that allow for discussion and formal documentation of appropriate ceilings of care, particularly for patients at risk of deterioration. Guidelines for the Provision of Intensive Care Services states 'Patients must have a clear and documented TEP', as well as a handover on discharge from critical care units which includes 'any treatment limitations in place [and] plans if readmission to critical care becomes necessary including DNAR/TEP'(1).

Objectives.

- To assess documentation of TEP and CPR status on admission to ICU, review on daily ward rounds and documentation on discharge.
- To assess whether the introduction of mandatory TEP and CPR status fields on admission and discharge forms improves completion rates.

Methods. Data was collected retrospectively across two ICUs in district general hospitals. An initial search assessed the completion rate for TEPs and CPR status on admission, one day post-admission to allow for completion of the formal TEP form, as well as consultant review on ward rounds and documentation on discharge. This was consequently repeated following introduction of mandatory fields to the TEP and CPR status fields on admission and discharge documents.

Results. Following the introduction of mandatory fields on admission and discharge forms, TEP and CPR status documentation increased significantly (Table 1). However, these results include TEP documentation on the admission form itself, rather than completion of a formal

TEP document countersigned by a consultant. If focusing solely on formally completed TEP documents, the completion rate worsened.

Table 1 (abstract 000093) Summary of results

	Prior to mandatory fields N = 35	Post mandatory fields N = 20
CPR on admission	77.1%	100%
TEP on admission	31.4%	85%
TEP by day 1 of admission	45.7% formal TEP	84.2% (10.5% formal TEP)
Daily review	11.1%	84.9%
CPR on discharge	82.9%	100%
TEP on discharge	51.4%	94.4% (11.1% formal TEP)

Conclusions. The results showed overall improvement to completion rates of TEP and CPR status documentation following introduction of mandatory fields, possibly through encouraging discourse with consultants early in patient admission and documenting decisions. However, the rate of formal TEP form completion reduces, possibly due to an assumption that a form is likely to have been completed if the TEP is stated on admission. Nonetheless, the relevant information regarding TEP and CPR status is included on discharge forms, despite the lack of a formal TEP form, providing important information for the receiving team continuing the patient's care. Although formal TEPs should be completed and cross signed by a consultant, given the initial poor results and the immense pressures faced, this overall improvement in documentation allows for decisions to be communicated to the broader ICU team and on discharge to receiving teams, ensuring continuity of care.

References

- Faculty of Intensive Care Medicine, Intensive Care Society. Guidelines for the Provision of Intensive Care Services, Version 2.1, 2022
- No grants were received.

Topic: Cardiac arrest.

000094

Incidence and severity of pediatric delirium in the PICU: a single-center retrospective study

Y. Enomoto¹, T. Kido², T. Hoshino³, M. Ikeda⁴, M. Kotani⁴, Y. Inoue¹

¹Department of Emergency and Critical Care Medicine, Faculty of Medicine, University of Tsukuba Tsukuba, Tsukuba, Japan; ²Department of Pediatrics, Tsukuba University Hospital, 2 Chome-1-1 Amakubo, Tsukuba, Ibaraki, Japan, Tsukuba, Japan; ³Department of Emergency and Critical Care Medicine, University of Tsukuba Hospital, Tsukuba, Japan; ⁴Intensive Care Unit, University of Tsukuba Hospital, Tsukuba, Japan

Correspondence: Y. Enomoto

Intensive Care Medicine Experimental 2023, **11(Suppl 1)**:000094

Introduction. Delirium is a complex and multifactorial acute brain disorder associated with adverse outcomes, such as increased morbidity, mortality, longer hospital stays, and cognitive impairment. However, it is often underdiagnosed in children owing to a lack of awareness and recognition of the syndrome in this population. Children admitted to the pediatric intensive care unit (PICU) are particularly vulnerable to delirium due to underlying illnesses, use of sedatives and analgesics, and other environmental factors. Although delirium is a well-recognized complication in critically ill adult patients, limited research has been conducted on its characteristics and outcomes in children admitted to the PICU. Moreover, reports on the differences in outcomes according to the severity of delirium are limited.

Objectives. This study aimed to determine the incidence, characteristics, and severity of delirium in children admitted to the PICU and to provide fundamental data for future studies on this topic.

Methods. This single-center retrospective study assessed patients ≤ 16 years old who had been admitted to the PICU between 2018 and 2022. Clinical data were extracted from electronic medical records. Delirium was assessed using the Cornell Assessment Pediatric Delirium (CAPD) scale, which was correctly translated and validated in Japanese. Consciousness during the first 10 days after admission was classified as coma (Richmond Agitation Sedation Scale [RASS] ≤ -4), delirium (RASS > -4 and CAPD ≥ 9), or non-delirium (RASS > -4 and CAPD < 9). The severity of delirium was classified as mild (1 d) or severe (> 1 d) based on the number of days the delirium lasted. Data on age, sex, postoperative status, pediatric index of mortality 3, length of ICU stay, and outcomes at ICU discharge were also collected. Each data point was compared among the three groups using the Kruskal–Wallis test.

Results. A total of 619 patients were enrolled in this study, with a delirium prevalence of 58% ($n=208/357$). Regarding the severity of delirium, 132 (37%) patients had mild delirium and 76 (21%) had severe delirium. The more severe the delirium, the younger the patient and the longer the ICU stay. Coma was the most common condition in the PICU (Figure). Patients with severe delirium had significantly longer ICU stay than those of patients with mild delirium or without delirium (18 days [8–94] vs 12 days [5–50] and 7 days [3–29], respectively; $p < 0.001$).

Conclusions. Delirium is prevalent in children admitted to the PICU, and the more severe the delirium, the longer the ICU stay. Further studies are necessary to explore the underlying mechanisms and identify effective interventions for delirium in this vulnerable population.

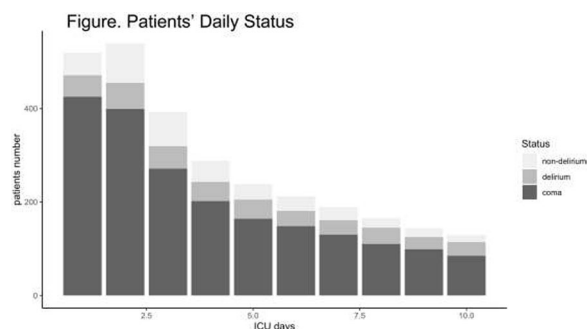

Patients' status was categorized into three groups (non-delirium, delirium, coma). coma: Richmond Agitation Sedation Scale (RASS) ≤ -4 , delirium: RASS > -4 & Cornell Assessment Pediatric Delirium ≥ 9 , non-delirium: RASS > -4 & CAPD < 9 .

References

- Hoshino H, et al. The Validity and Reliability of the Japanese Version of the Cornell Assessment of Pediatric Delirium. *Pediatr Crit Care Med* 2020;21:e267–73.
- Meyburg J, et al. Patterns of Postoperative Delirium in Children: *Pediatric Critical Care Medicine* 2017;18:128–33.
- Pisani MA, et al. Days of Delirium Are Associated with 1-Year Mortality in an Older Intensive Care Unit Population. *Am J Respir Crit Care Med*. 2009;180(11):1092–1097.
- Semple D, et al. A Systematic Review and Pooled Prevalence of Delirium in Critically Ill Children. *Crit Care Med* 2022, 50:317–328
- Smith HAB, et al. 2022 Society of Critical Care Medicine Clinical Practice Guidelines on Prevention and Management of Pain, Agitation, Neuro-muscular Blockade, and Delirium in Critically Ill Pediatric Patients With Consideration of the ICU Environment and Early Mobility. *Pediatric Critical Care Medicine* 2022;23:e74–110.1
- This study was supported by the JSPS KAKENHI (grant number: JP20K09261).

Topic: Sedation, analgesia and delirium.

000095

Clinical study of super resolution ultrasound imaging in the evaluation of cerebral microcirculation in severe traumatic brain injury

W. Huang¹, Y. Li²

¹Department of Intensive Care Medicine, The Sixth People's Hospital, Shanghai Jiao Tong University school of medicine, Shanghai, China;

²Department of Critical Care Medicine, Shanghai Tenth People's Hospital, Tongji University School of Medicine, Shanghai, China

Correspondence: W. Huang

Intensive Care Medicine Experimental 2023, **11(Suppl 1)**:000095

Introduction. Severe traumatic brain injury (sTBI) is a common neurosurgical disease. It has high mortality and disability rate that has brought heavy burden to the society and families. Effective and precise monitoring of intracranial pressure (ICP) is particularly crucial for the prognosis of sTBI patients. Currently, invasive ICP monitoring has been widely recognized as the gold standard to guide the treatment of sTBI patients. However, it has limited utilization in clinical practice, because it is expensive and requires a professional doctor to operate. Furthermore, multiple complications, such as infection and rebleeding, may influence the effect on reducing the mortality by ICP monitoring. More important, ICP monitoring cannot directly or completely reflect the situation of cerebral microcirculation. In clinical practice, effective cerebral microcirculation perfusion is crucial for the recovery and functional preservation of brain tissue, which directly affects the prognosis of patients. However, there remains a lack of direct and effective methods to determine the cerebral microcirculation in clinical practice.

Objectives. This study principally aims to improve the ICP monitoring on the cerebral microcirculation perfusion, which could achieve the identification of the change in the cerebral microcirculation perfusion before irreversible damage to brain tissue.

Methods. We utilized the super resolution ultrasound imaging technology to establish and validate the super resolution imaging of cerebral microcirculation of sTBI patients, and then compared its agreement with traditional ICP monitoring.

Results. In this study, a super resolution ultrasound imaging method was established to directly and non-invasively determine the cerebral perfusion. This method was further employed to compare the effect of cerebrospinal fluid drainage and mannitol on ICP reduction. It was found that it differed between these two methods; in addition, the perfusion of capillaries and large vessels also had different reactions to the ICP reduction. Furthermore, 40 sTBI patients were included to compare the agreement between the time-intensity curve (area under the curve) of super-resolution ultrasound imaging and traditional ICP monitoring results. Correlation coefficient r was determined to be 0.665 ($P = 0.001$), suggesting a moderate agreement.

Conclusions. Our study establishes a non-invasive super-resolution imaging technology for cerebral microcirculation, which may provide an effective tool for decision-making on clinical diagnosis and treatment and prognosis evaluation among sTBI patients.

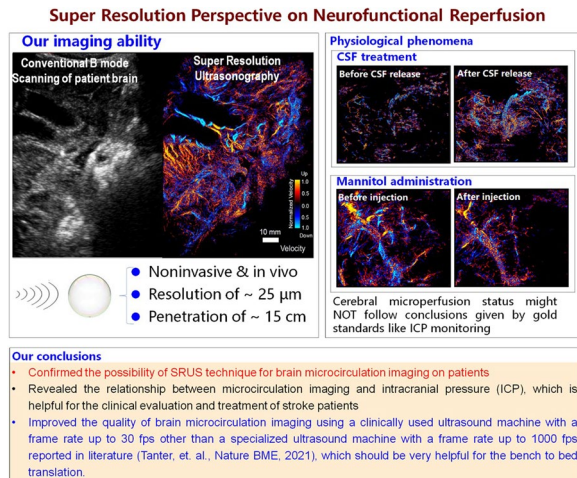

Graphical Abstract

Introduction. Advanced age is a known risk factor for cardiovascular disease development, as aging negatively affects the proliferative and regenerative capacity of the endothelium, endothelial gene expression, and monolayer integrity [1]. By regulating leukocyte migration and blood-tissue barrier permeability, the endothelium plays an important role in the resolution of acute inflammation [2]. Endocan (ESM-1), an endothelium-derived soluble proteoglycan, participates in fundamental biological processes of endothelial cells, including cell adhesion, migration, proliferation, and neoangiogenesis [3]. ESM-1 is a marker of endothelial activation and has been recognized as a prognostic biomarker in sepsis, pulmonary, and cardiovascular diseases.

Objectives. We aimed to examine whether endotheliopathy is a consequence of critical illness or older age leading to poor outcomes.

Methods. ESM-1 levels were measured in the sera of mechanically ventilated critically-ill patients, including 154 COVID-19, 164 non-septic (24-h post ICU admission), and 79 septic (6-h after sepsis diagnosis) patients, using an enzyme-linked immunosorbent assay (ELISA). The 3 patient cohorts were divided each into two subgroups based on age: patients equal or older than 65 years of age, and patients younger than 65 years of age.

Results. Critically-ill COVID-19 patients had statistically higher ESM-1 levels compared to critically-ill septic and critically-ill non-septic patients [1527 (951.4–2406) pg/ml vs. 659.3 (389.1–941.3) pg/ml and 756.7 (369.8–1228) pg/ml, $p < 0.0001$, respectively]. In critically-ill COVID-19 patients, older patients (≥ 65) tended to have higher ESM-1 levels compared to younger patients, without reaching statistical significance ($p = 0.051$). On the other hand, older critically-ill septic patients (≥ 65) exhibited higher ESM-1 levels compared to younger septic patients [860.9 (623.2–1397) pg/ml vs. 519.8 (352.3–820.9) pg/ml, respectively, $p = 0.0013$]. No statistical difference was observed between the two age groups of the critically-ill non-septic patients ($p > 0.05$). Finally, the two age subgroups patients were further subdivided based on ICU outcome. ESM-1 levels in COVID-19 patients were similar in survivors and non-survivors, irrespective of age. Interestingly, in the ≥ 65 years old critically-ill septic patients, survivors and non-survivors had similar serum levels of ESM-1, yet in younger critically-ill septic patients (< 65), non-survivors had higher ESM-1 levels compared to survivors [760 (429–1176) pg/ml vs. 510.8 (332.2–788.8) pg/ml, respectively, $p = 0.045$]. In the non-septic survivors and non-survivors, ESM-1 levels remained unaltered in the younger critically-ill patients, and tended to be higher in the elderly ($p = 0.056$).

Conclusions. Even though endocan has been recognized as an important prognostic biomarker in critically-ill patients with sepsis, increased age, as well as the extent of endothelial dysfunction seem to impede its prognostic ability.

References

- Kali, A. and K. S. Shetty (2014). "Endocan: a novel circulating proteoglycan." *Indian J Pharmacol* 46(6): 579–583
- Kadl, A. and N. Leitinger (2005). "The role of endothelial cells in the resolution of acute inflammation." *Antioxid Redox Signal* 7(11–12): 1744–1754
- Brandes, R. P., et al. (2005). "Endothelial aging." *Cardiovascular Research* 66(2): 286–294

Topic: Sepsis.

000102

Ultra-protective ventilation with veno-venous extracorporeal membrane oxygenation decreases acute lung inflammation in experimental acute respiratory distress syndrome

G. Deniel¹, F. Dhelt², S. Lancelot³, M. Orkisz⁴, E. Roux⁴, N. Benzerdjeb⁵, W. Mouton⁶, J. C. Richard², L. Bitker²

¹Médecine intensive Réanimation, Hospices Civils de Lyon—HCL, Lyon, France; ²Médecine intensive et réanimation, Hôpital de la Croix-Rousse—HCL, Lyon, France; ³Radiochemistry, Cermep—Imagery Du Vivant, Bron, France; ⁴Creatis, CREATIS, Villeurbanne, France; ⁵Pathology, Hospices Civils de Lyon—HCL, Lyon, France; ⁶Biology, Hospices Civils de Lyon—HCL, Lyon, France

Correspondence: G. Deniel

Intensive Care Medicine Experimental 2023, **11(Suppl 1)**:000102

Introduction. Tidal volume (Vt) setting is a major determinant of ventilator induced lung injuries (VILI) in patients with acute respiratory distress syndrome (ARDS). Veno-venous extracorporeal membrane oxygenation (VV-ECMO) allows Vt decrease down to 1 ml/kg (ultra-protective ventilation, UPV) or less, while maintaining efficient oxygenation and decarboxylation.

Positron emission tomography (PET) with [11C](R)-PK11195 coupled with quantitative computerized tomography (CT) allows non-invasive and specific quantification of lung macrophagic inflammation, in parallel with the determination of CT-derived parameters quantifying VILI.

Objectives. We aimed to demonstrate that a UPV strategy decreased acute lung inflammation in animals with experimental ARDS, compared to conventional Vt settings.

Methods. We performed a randomized preclinical open-label controlled trial in swine receiving mechanical ventilation with general anesthesia and neuromuscular blockade. Experimental ARDS was induced by intratracheal instillation of 3 ml/kg of 0.1 M chlorohydric acid after animal conditioning. Then, animals (median weight 32 [30–38] kg) were randomised to receive during 4 h conventional protective ventilation (controls, Vt 6 ml/kg and positive end-expiratory pressure [PEEP] set to maintain plateau pressure at 28–30 cmH2O), or UPV (Vt 1 ml/kg and PEEP set to maintain plateau pressure at 20–25 cmH2O) with femoro-jugular VV-ECMO. After 4 h of strategy application, a 60-min PET with [11C](R)-PK11195 radiotracer injection coupled with lung CT was performed. Lung segmentation of imaging acquisitions was performed using a semi-automatic segmentation algorithm. Lung masks were divided into 8 lung regions, distributed along antero-posterior axis. The study primary outcome (i.e. regional lung macrophagic inflammation) was quantified regionally by the value of [11C](R)-PK11195 non-displaceable binding potential (BPnd) determined by a multi-compartment kinetic model, describing the distribution of the PET radiotracer. The study primary outcome was compared between study groups using linear mixed effects regression analysis.

Results. Five animals were randomised in each group, after ARDS induction (median PaO2/FiO2 ratio 78 [68–104] mmHg). Vt setting in the UPV group was 1.0 [1.0–1.4] ml/kg, and 6.0 [6.0–6.0] ml/kg in the control group ($p < 0.05$). After 4 h of application, UPV animals displayed a significant decrease in the regional non-aerated compartment in the posterior lung levels at the price of a significant increase in the hyperinflated compartment in the anterior lung levels. Concomitantly, [11C](R)-PK11195 BPnd was significantly lower in UPV animals (0.35 [0.20–0.59] vs. 1.01 [0.75–1.59], $p < 0.01$), a difference that statistically present across all lung regions. Higher radiotracer lung uptake was

significantly and independently associated with increasing regional hyperinflation and dynamic strain in multivariate regression analysis.

Conclusions. In an experimental model of ARDS, 4 h of a UPV strategy with VV-ECMO induced a three-fold decrease in acute lung inflammation compared to conventional protective ventilation.

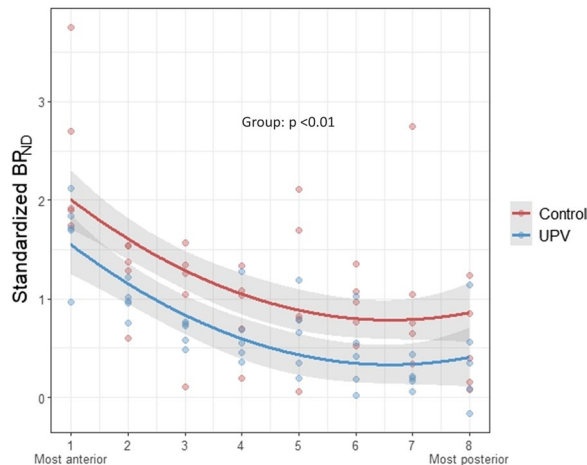

Figure 1 (abstract 000102) [11C](R)?PK11195 BPnd in each lung level in the 2 study groups

The figure shows the BPnd of [11C](R)?PK11195 in each of the 8 levels, in animal in the UPV group (blue dots and line) and those in the control group (red points and line). Dots represent experimental data collected after 4 h of strategy application in all animals. The predicted values of the mixed effects model describing the fixed effect of the study group (UPV vs. control) on BPnd is represented by the two curves. Shading along the lines represent the 95% confidence interval of the model. The p value examines the association between the study group and lung level BPnd (no significant interaction with lung level). BPnd: non-displaceable binding potential; UPV: ultra-protective ventilation strategy.

References

- Dhelt F, Lancelot S, Mouton W, Le Bars D, Costes N, Roux E, Orkisz M, Benzerdjeb N, Richard JC, Bitker L. Prone position decreases acute lung inflammation measured by [11C](R)-PK11195 positron emission tomography in experimental acute respiratory distress syndrome. *J Appl Physiol*. 2023
- Bitker L, Dhelt F, Lancelot S, Le Bars D, Costes N, Benzerdjeb N, et al. Non-invasive quantification of acute macrophagic lung inflammation with [11C](R)-PK11195 using a three-tissue compartment kinetic model in experimental acute respiratory distress syndrome. *Eur J Nucl Med Mol Imaging*. 2022
- Terragni PP, Rosboch G, Tealdi A, Corno E, Menaldo E, Davini O, et al. Tidal hyperinflation during low tidal volume ventilation in acute respiratory distress syndrome. *Am J Respir Crit Care Med*. 2007
- Bitker L, Costes N, Le Bars D, Lavenne F, Orkisz M, Hernandez Hoyos M, et al. Noninvasive quantification of macrophagic lung recruitment during experimental ventilation-induced lung injury. *J Appl Physiol* 2019
- Wellman TJ, Winkler T, Costa ELV, Musch G, Harris RS, Zheng H, et al. Effect of Local Tidal Lung Strain on Inflammation in Normal and Lipopolysaccharide-Exposed Sheep. *Crit Care Med*. 2014
- Bourse Jeunes Chercheurs 2019 (recipient: L Bitker), Hospices Civils de Lyon

Topic: Acute respiratory failure and mechanical ventilation.

000103

Predicting individualized treatment effects of corticosteroids in community-acquired-pneumonia: preliminary results of a secondary analysis of randomized controlled trials

J. Smit¹, P. A. Van Der Zee², M. E. Van Genderen³, S. Stooft³, D. Snijders⁴, W. Boersma⁵, P. Confalonieri⁶, F. Salton⁶, M. Lloyd⁷, H. Karunajeewa⁸,

G. U. Meduri⁹, M. C. Shih¹⁰, P. F. Dequin¹¹, A. Le Gouge¹², W. J. W. Bos¹³, E. M. Van Der Garde¹⁴, E. Wittermans¹³, J. C. Grutters¹⁵, C. A. Blum¹⁶, M. Christ-Crain¹⁷, S. Fernández-Serrano¹⁸, G. Suárez Cuartín¹⁹, A. Torres²⁰, A. Motos²¹, D. Gommers²², M. J. T. Reinders²³, J. Van Bommel²⁴, J. Krijthe²⁵, H. E. Endeman³

¹Intensive Care, Erasmus Medical Center, Doctor Molewaterplein, Rotterdam, Netherlands, Rotterdam, Netherlands; ²Pulmonary Medicine, Erasmus MC, Doctor Molewaterplein, Rotterdam, Netherlands; ³Intensive care, Erasmus University Medical Center, Rotterdam, Netherlands; ⁴Pulmonary Medicine, Spaarne Gasthuis Haarlem Zuid, Haarlem, Netherlands; ⁵Pulmonary Medicine, Noordwest Ziekenhuisgroep locatie Alkmaar, Alkmaar, Netherlands; ⁶Pulmonology Department, University Hospital of Cattinara, Trieste, Italy; ⁷Department of Medicine, Western Health, The Western Health Chronic Disease Alliance and the University of Melbourne, Melbourne, Australia; ⁸Department of Medicine, Western Health, The Western Health Chronic Disease Alliance and the University of Melbourne, Melbourne, Australia; ⁹Department of Pharmaceutical Sciences, University of Tennessee Health Science Center, Memphis, United States of America; ¹⁰Cooperative Studies Program Coordinating Center, VA Palo Alto, Palo Alto, United States of America; ¹¹Medicine intensive reanimation, Chru Hôpitaux De Tours, Hospital Bretonneau, Tours, France; ¹²Statistic department, Chru Hôpitaux De Tours, Hospital Bretonneau, Tours, France; ¹³Internal medicine, St. Antonius Hospital, Nieuwegein, Netherlands; ¹⁴Clinical Pharmacology, St. Antonius Hospital, Nieuwegein, Netherlands; ¹⁵Polmunology, St. Antonius Hospital, Nieuwegein, Netherlands; ¹⁶Aarau, Hormonpraxis Aarau, Aarau, Switzerland; ¹⁷Division of Endocrinology, Diabetes and Metabolism, Department of Clinical Research, Universitätsklinik Basel, Basel, Switzerland; ¹⁸Pulmonary Medicine, Badalona Serveis Assistencials S.A., Badalona, Spain; ¹⁹Pulmonary Medicine, Bellvitge University Hospital, L'Hospitalet de Llobregat, Spain; ²⁰Department of Pulmonology, Hospital Clinic. University of Barcelona. IDIBAPS.CIBERES. ICREA, Barcelona, Spain; ²¹Centro de Investigación Biomedica En Red-Enfermedades Respiratorias (CIBERES), Institut d'Inve, Universitat de Barcelona, Barcelona, Spain; ²²Department of intensive care, Erasmus MC, Rotterdam, Netherlands; ²³Eemcs, pattern recognition & bioinformatics group, Delft University of Technology (TU Delft), Mekelweg, Delft, Netherlands, Delft, Netherlands; ²⁴Intensive care, Erasmus MC, Rotterdam, Netherlands, Netherlands; ²⁵Eemcs, pattern recognition & bioinformatics group, Delft University of Technology (TU Delft), Delft, Netherlands

Correspondence: J. Smit

Intensive Care Medicine Experimental 2023, **11(Suppl 1)**:000103

Introduction. Although adjuvant corticosteroids have the potential to improve outcomes in community-acquired pneumonia (CAP), their effectiveness has yielded inconsistent results, and routine usage is not recommended [1]. Heterogeneity in the treatment effect (HTE) among CAP patients may offer an explanation, with the hypothesis that severe CAP patients benefit more from corticosteroids [2].

Objectives. To create and validate a model that predicts individualized treatment effects (ITEs) of corticosteroids on mortality rate in patients with CAP, in order to personalize treatment.

Methods. Our systematic literature search identified ten eligible trials that investigated corticosteroid adjuvant therapy versus placebo in CAP. From seven trials, we received baseline clinical characteristics, consisting of demographics, vital signs and laboratory test results. The endpoint was 30-day mortality. The ITE, ie, the probabilistic difference in predicted 30-day mortality under corticosteroid versus placebo treatment for an individual patient, was modelled through effect modelling [3] using logistic regression. The modelling process had five steps: (1) dividing patients into development and validation cohorts, (2) pre-selecting variables based on data availability, (3) data normalization and imputation, (4) selecting main effects and interaction terms through multi-penalty LASSO regression, and (5) fitting the effect model to predict ITEs for the validation cohort. To externally validate our procedure, we employed cross-validation, where in each iteration, patients from six trials formed the development cohort and patients from one left-out trial formed the validation cohort. Patients with negative and positive predicted ITEs were assigned to the "predicted harm" and "predicted benefit" group, respectively. Subsequently, we

compared observed treatment effects between groups, and tested for HTE between the groups using an interaction test.

Results. From the 1925 CAP patients included, 1,077 were assigned to the predicted harm group, and 848 to the predicted benefit group. We found a significant HTE between the groups (p for interaction = 0.013). In the predicted benefit group, corticosteroids were associated with substantially lower mortality, while in the predicted harm group corticosteroids were associated with higher mortality (Fig. 1). Compared with the predicted harm group, the predicted benefit group was defined by higher concentrations of C-reactive protein, leukocytes and glucose and lower concentration of sodium (Fig. 2).

Conclusions. Our modelling approach demonstrated ability in identifying CAP patients, at baseline, who would benefit from the investigated corticosteroid treatment and those who would not. To further validate the model's robustness, we will test its performance in the two most recent trials [4,5]. If the model proves robust, we intend to include patients with predicted benefit in future randomized trials.

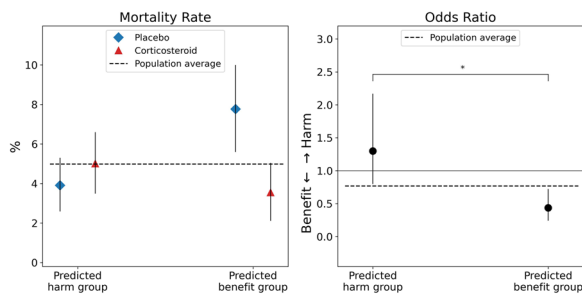

Figure 1 (abstract 000103) Results of the external validation in 7 trials (cross-validation procedure). Mortality rates (left) and treatment effect in terms of odds ratios (right) are shown with 95% CIs. * p for interaction = 0.013

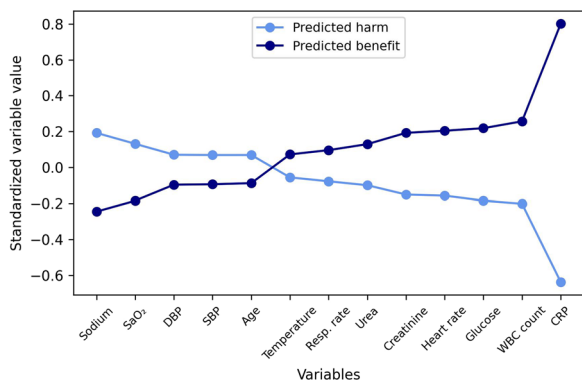

Figure 2 (abstract 000103) Differences in standardized values of each continuous variable between subgroups. The variables are sorted on the degree of separation between the harm and benefit group. For example, a value of 1 for a certain variable implies that the mean value of this variable in this subgroup is one standard deviation higher than the mean value in the cohort as a whole

References

- Dequin P-F, Meziani F, Quenot J-P, et al. Hydrocortisone in Severe Community-Acquired Pneumonia. *N Engl J Med* 2023;:1–11.
- Meduri GU, Shih MC, Bridges L, et al. Low-dose methylprednisolone treatment in critically ill patients with severe community-acquired pneumonia. *Published Online First*: 2022.
- Kent DM, Paulus JK, Van Klaveren D, et al. The Predictive Approaches to Treatment effect Heterogeneity (PATH) statement. *Ann Intern Med* 2020;172:35–45. <https://doi.org/10.7326/M18-3667>

- Briel, M. et al. Corticosteroids in Patients Hospitalized with Community-Acquired Pneumonia: Systematic Review and Individual Patient Data Metaanalysis. *Clin. Infect. Dis.* 66, 346–354 (2018).
- Martin-Loeches, I. et al. ERS/ESICM/ESCMID/ALAT guidelines for the management of severe community-acquired pneumonia. *Intensive Care Med.* 1–18 (2023) <https://doi.org/10.1007/s00134-023-07033-8>.

Topic: Data Science.

000105

Predictors of intracranial hemorrhage and ischemic stroke in venovenous extracorporeal membrane oxygenation: a systematic review and causal diagram

S. Thiara¹, A. Willms²

¹Division of Critical Care, Faculty of Medicine, Vancouver General Hospital, Vancouver, Canada; ²Faculty of Medicine, Dalhousie University, Halifax, Canada

Correspondence: A. Willms

Intensive Care Medicine Experimental 2023, **11(Suppl 1)**:000105

Introduction. Venovenous extracorporeal membrane oxygenation (VV-ECMO) is a life-preserving intervention for patients with respiratory compromise refractory to mechanical ventilation. Both intracranial hemorrhage (ICH) and ischemic stroke are well-known, life-threatening complications associated with VV-ECMO. Despite this, little is known regarding the risk factors for each of these complications, and how clinicians may be able to predict and prevent them on a case-by-case basis.

Objectives. To conduct a systematic review that characterizes causal risk factors of ICH and/ or ischemic stroke during VV-ECMO, and to create a clinically-oriented causal diagram for each complication.

Methods. Using the Preferred Reporting Items for Systematic Reviews and Meta-Analyses (PRISMA) guidelines, we conducted a systematic literature review through PubMed and EMBASE using controlled vocabulary and keywords.

We included randomized controlled trials, retrospective and prospective cohort studies, and cross-sectional studies that reported on predictors of ICH and/ or ischemic stroke in adult patients undergoing VV-ECMO. 248 studies met criteria for screening, which was then performed manually through abstract and subsequent full text review using the COVIDENCE online application. 26 studies met inclusion criteria for final data extraction.

Included studies were evaluated for risk of bias through the evidence-based Quality in Prognosis Studies (QUIPS) tool. Importance and certainty of predictors of ICH and/ or ischemic stroke in the literature was assessed using the evidence-based GRADE strategy.

Results. 26 studies met inclusion criteria, 22 of which reported on predictors of ICH, while 11 reported on ischemic stroke.

Predictors of both ICH and ischemic stroke include pre-ECMO reduced pH, as well as rapid rise in PaO₂ and rapid decline in PaCO₂ following ECMO initiation. Renal failure, use of renal replacement therapy, gastrointestinal (GI) bleed, hemolysis, and disseminated intravascular coagulopathy (DIC) were also risk factors for both neurologic complications.

Predictors of ICH only include reduced fibrinogen levels, elevated serum creatinine, thrombocytopenia, pre-existing diabetes, lymphoma, elevated BMI, previous chemotherapy, and septic shock. Furthermore, viral pneumonia and asthma as indications for VV-ECMO increased the risk of ICH. Finally, the use of larger cannulation size, as well as increased duration of mechanical ventilation prior to VV-ECMO initiation increased the risk of ICH.

Risk factors for ischemic stroke only include lower pre-ECMO PF ratio and hypoglycemia.

Conclusions. A number of factors reported in the literature increase the risk of ICH or ischemic stroke during VV-ECMO, some of which increase the risk of both complications. Identifying predictors of each complication and illustrating them in a clinically-oriented way is an important step towards developing clinical strategies that can be used to mitigate these devastating neurologic complications.

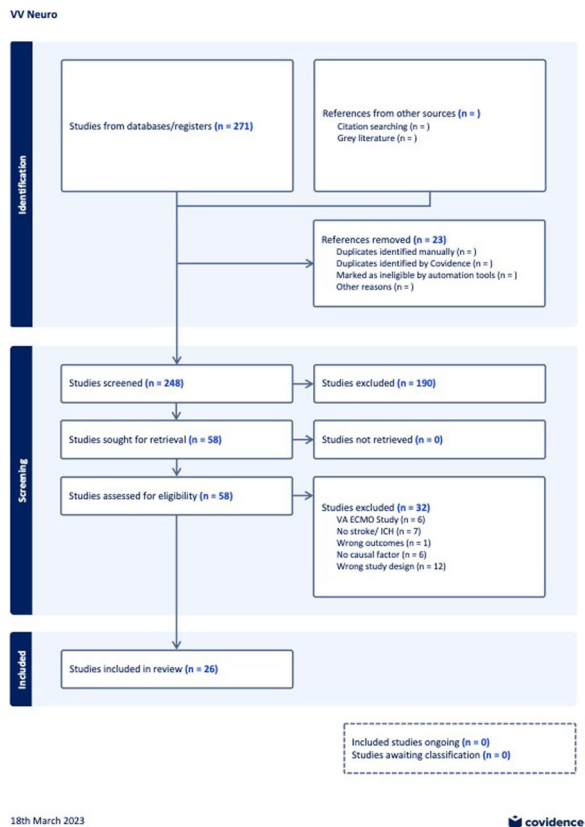

Topic: Neurointensive care.

000106

Frailty, outcomes, recovery and care steps of critically ill patients (FORECAST): a prospective observational multi-centre study

J. Muscedere¹, P. Archambault², S. Bagshaw³, I. Ball⁴, J. G. Boyd¹, D. Cook⁵, A. Day¹, M. Kho⁶, O. Loubani⁷, A. Martin⁸, S. Mehta⁹, T. Mele¹⁰, P. Norman¹, O. Rewa¹¹, A. Sarti¹², J. Shahin¹³, S. Sibley¹, H. Wang¹⁴

¹Critical Care Medicine, Queen's University Kingston, Kingston, Canada; ²Critical care, L'Hotel-Dieu de Levis, Levis, Canada; ³Department of critical care medicine, faculty of medicine and dentistry, University of Alberta and Alberta Health Services, Edmonton, Canada; ⁴Critical Care Medicine, Western University, London, Canada; ⁵Department of medicine/department of health research methods, evidence and impact, McMaster University, Hamilton, Canada; ⁶School of Rehabilitation Sciences, McMaster University, Hamilton, Canada; ⁷Critical Care Medicine, Dalhousie University, Halifax, Canada; ⁸Institut de Cardiologie de Montréal, Université de Montréal, Montreal, Canada; ⁹Critical care, Mount Sinai Hospital, Toronto, Canada; ¹⁰Surgery, Western University, London, Canada; ¹¹Critical Care Medicine, University of Alberta, Edmonton, Canada; ¹²Critical Care Medicine, The Ottawa Hospital, Ottawa, Canada; ¹³Critical Care Medicine, McGill University, Montreal, Canada; ¹⁴Critical Care Medicine, Université de Montréal, Montreal, Canada

Correspondence: J. Muscedere

Intensive Care Medicine Experimental 2023, **11(Suppl 1)**:000106

Introduction. Frailty is common in critically ill patients and associated with increased morbidity and mortality. The timing and optimal method of frailty determination, frailty trajectory and relationship with care processes remain uncertain. Understanding contributory and

potentially modifiable factors is essential to plan interventions which may improve outcomes.

Objectives. To describe the baseline and trajectory of frailty, as measured by the Clinical Frailty Scale (CFS) and Frailty Index (FI) among patients admitted to intensive care and the impact of care processes on the evolution of frailty during an episode of critical illness.

Methods. Multi-center prospective observational study enrolling patients >50 years receiving at least one day of any life support intervention, defined as: 1) mechanical ventilation (MV) – invasive or non-invasive, 2) vasopressors, or 3) acute renal replacement therapy (RRT). Patients were excluded if they were > 5 days after ICU admission; had no available collateral history; predicted to be unable to complete 6-month follow-up; or were expected to survive < 72 h after enrollment. Frailty was evaluated at ICU admission, hospital discharge, and at 6 months with both the Clinical Frailty Scale (CFS), and Frailty Index (FI) derived from a modified comprehensive geriatric assessment (CGA). Processes of care (nutrition, mobility, sedation), and adverse events (nosocomial infections, delirium) were collected during ICU and ward stay, and vital status ascertained at ICU discharge, hospital discharge and 6 months.

Results. Among 2186 screened, 687 patients were enrolled in 14 Canadian centers (mean ± SD): age 69 ± 9 years, APACHE II 23.3 ± 8.1, 90% receiving MV, 74% vasopressors and 5% RRT. Frailty (CFS ≥ 5 or FI ≥ 0.2) prevalence was higher when measured with FI but was common at all time points (%): ICU admission (30, 45), hospital discharge (55, 68), and 6 months (34, 43) respectively. Aggregate frailty scores increased from ICU admission to hospital discharge but improved by 6 months; mortality was higher in patients with frailty measured at all time points (Fig. 1). Processes of care and adverse events were similar with the exception of differences in mobility and delirium (Table 1). Patients without frailty achieved higher mobility as assessed by the ICU mobility scale and as a proportion of those walking on the ward. There was no difference in delirium incidence in frail patients measured by the CFS, however more people with frailty measured by the FI had delirium.

Table 1 (abstract 000106) Mobility, delirium by frailty status

Frailty Level	Max ICU Mobility Scale: Median (IQR)	p value	Max Ward Mobility-Ambulatory; n (%)	p value	ICU Delirium: n (%)	p value
CFS ≥ 5	2.0 (0.0–5.0)	< 0.0001	19 (15%)	0.002	107 (60%)	0.4
CFS < 5	3.0 (1.0–6.0)		110 (29%)		231 (57%)	
FI ≥ 0.20	2.0 (0.0–5.0)	< 0.0001	32 (16%)	< 0.0001	170 (62%)	0.04
FI < 0.20	4.0 (1.0–6.0)		96 (33%)		166 (54%)	

In survivors, CFS and FI scores were higher in 45% and 51%, respectively at 6 months compared with ICU admission. Compared to hospital discharge, 19% and 20% had higher CFS and FI scores at 6 months. In multivariate analysis of baseline characteristics and process measures, only age was associated an increase in both CFS and FI frailty scores.

Conclusions. Frailty is dynamic, and can be measured during recovery from critical illness. Screening for frailty at hospital discharge can inform planning of care transitions and community interventions. While the CFS can serve as a screening tool, a FI based on CGA

can measure frailty levels and specify new deficits and targets for intervention.

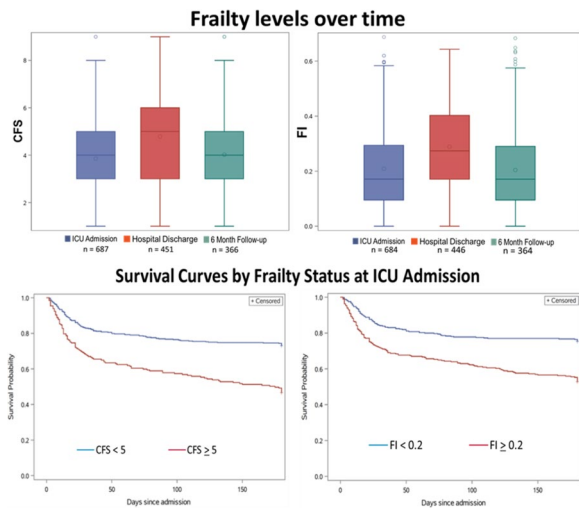

Frailty levels, mortality over time.

References

- Muscudere J, Bagshaw SM, Boyd G et al. The frailty, outcomes, recovery and care steps of critically ill patients (FORECAST) study: pilot study results. *Intensive Care Med Exp.* 2022;10:23. <https://doi.org/10.1186/s40635-022-00446-7>.
- Brummel NE, Girard TD, Pandharipande PP et al. Prevalence and Course of Frailty in Survivors of Critical Illness. *Crit Care Med.* 2020;48:1419–1426. <https://doi.org/10.1097/CCM.0000000000004444>.
- Study funding was received from the Canadian Frailty Network

Topic: Systemic diseases.

000107

Vasospasm after aneurysmal subarachnoid hemorrhage: does it affect outcome?

R. Pereira¹, L. Antunes², J. Fernandes³, R. Guedes⁴, E. Pereira⁴, C. Dias⁴, J. A. Paiva⁴, E. Monteiro⁴

¹Serviço de Cuidados Intensivos, Hospital Geral de Santo António, Porto, Portugal; ²Intensive Care Medicine Department, Hospital Fernando Fonseca, EPE, Lisbon, Portugal; ³Intensive Care Medicine Department, Centro Hospitalar De Trás-Os-Montes E Alto Douro, E.P.E., Vila Real, Portugal; ⁴Intensive Care Medicine Department, Centro Hospitalar Universitário São João, EPE, Porto, Portugal

Correspondence: R. Pereira

Intensive Care Medicine Experimental 2023, **11(Suppl 1)**:000107

Introduction. Cerebral vasospasm (CVS) remains a major contributor to increase morbidity and mortality after aneurysmal subarachnoid hemorrhage (aSAH). Delayed cerebral ischemia and cerebral infarction may occur as complications of CVS and can lead to permanent neurological impairment, severe disability, and poor quality of life [1]. Conventional approach includes serial monitoring with Transcranial Doppler (TCD), prophylactic oral nimodipine, avoid hypovolemia and vasopressor-induced hypertension, while invasive measures such as endovascular rescue treatment are reserved for CVS refractory to medical therapy [2,3]. **Objectives.** Compare outcomes between aSAH patients with and without vasospasm.

Methods. Retrospective cohort study of all adult patients with aSAH admitted from 1st January 2018 to 30th June 2022 at a Neurocritical Care Unit in a tertiary hospital. CVS was diagnosed with TCD or cerebral angiography. Functional outcome was defined by Glasgow Outcome Scale (GOS), considering GOS 1–3 as unfavorable and GOS 4–5

as a favorable outcome. GOS was accessed at the 28th day, 3rd and 6th months.

Results. A total of 199 patients were included, of whom 91 developed CVS. Baseline characteristics, complications, length of stay, and GOS of both groups are shown in Table 1. Considering patients with vasospasm, 67% were female, with a mean age of 54 years and 98% had a previous mRS 0–1. Initial severity evaluated by Hunt and Hess score was ≥ 4 in 35% patients (vs. 28%) and the risk of vasospasm accessed by Fisher score was ≥ 3 in 91% (vs. 83%). In vasospasm group, 28 patients required endovascular rescue therapy with intra-arterial verapamil, and 30 a combination of intra-arterial treatment of verapamil and intravenous milrinone perfusion. Although the vasospasm group had a higher incidence of complications such as delayed cerebral ischemia (50%), hydrocephalus (37%), and re-bleeding (15%), vasospasm was only an independent risk factor to develop delayed cerebral ischemia ($p = 0,001$). Vasospasm was not related to an unfavorable or a favorable GOS on the 28th day ($p = 0,007$), 3rd month ($p = 0,07$) and 6th month ($p = 0,405$) after the event. However, there is an association between the presence of delayed cerebral ischemia and an unfavorable outcome at any time accessed: 28th day ($p < 0,001$), 3rd month ($p < 0,001$) and 6th month ($p = 0,001$).

Conclusions. This study highlights the impact of delayed cerebral ischemia on the prognosis of aSAH patients. It was not possible to establish a positive correlation between vasospasm and unfavorable outcome, however delayed cerebral ischemia plays a major role to increase the burden of disease. This could be explained by the presence of other risk factors besides vasospasm competing to development of delayed cerebral ischemia in aSAH patients.

Table 1 (abstract 000107) Baseline characteristics, complications, length of stay, and GOS of patients with and without vasospasm. GCS—Glasgow Coma Scale, GOS—Glasgow Outcome Scale, ICU—Intensive Care Unit

	No Vasospasm (n=108)	Vasospasm (n=91)
Age (years; mean,range)	61; 28-86	Mean: 54; 23-82
Sex, n (%)	Male: 45 (42%); Female: 63 (58%)	Male: 30 (33%); Female: 61 (67%)
GCS at admission		
GCS > 8, n (%)	88 (82%)	70 (77%)
GCS ≤ 8, n (%)	20 (18%)	21 (23%)
Hunt-Hess severity scale		
I-III, n (%)	78 (72%)	59 (65%)
IV-V, n (%)	30 (28%)	32 (35%)
Fisher scale		
Grade 1, n (%)	4 (3%)	4 (4%)
Grade 2, n (%)	15 (14%)	5 (5%)
Grade 3, n (%)	18 (17%)	16 (18%)
Grade 4, n (%)	71 (66%)	66 (73%)
GOS 28 days		
4-5, n (%)	59 (54%)	34 (37%)
2-3, n (%)	31 (29%)	50 (55%)
1 (death), n (%)	14 (13%)	7 (8%)
Not available	4 (4%)	0
GOS 3 Months		
4-5, n (%)	65 (60%)	43 (47%)
2-3, n (%)	20 (18%)	33 (36%)
1 (death), n (%)	16 (15%)	10 (11%)
Not available	7 (7%)	5 (6%)
GOS 6 Months		
4-5, n (%)	66 (61%)	49 (54%)
2-3, n (%)	15 (14%)	20 (22%)
1 (death), n (%)	18 (17%)	12 (13%)
Not available	9 (8%)	10 (11%)
Complications		
• Late ischemia, n (%)	21 (19%)	45 (50%)
• Hydrocephalus, n (%)	33 (31%)	34 (37%)
• Re-Bleeding, n (%)	9 (8%)	14 (15%)
ICU length of stay (days; mean,range)	16; 1-61	26; 2-87
Hospital length of stay (days, mean, range)	31; 1-113	48; 5-150

References

- Findlay JM, Nisar J, Darsaut T. Cerebral Vasospasm: A Review. *Can J Neurol Sci.* 2016 Jan;43(1):15–32. <https://doi.org/10.1017/cjn.2015.288>. Epub 2015 Sep 2. PMID: 26332908.

- Kassell NF, Sasaki T, Colohan AR, Nazar G. Cerebral vasospasm following aneurysmal subarachnoid hemorrhage. *Stroke*. 1985 Jul-Aug;16(4):562–72. <https://doi.org/10.1161/01.str.16.4.562>. PMID: 3895589.
- Rosengart AJ, Schultheiss KE, Tolentino J, Macdonald RL. Prognostic factors for outcome in patients with aneurysmal subarachnoid hemorrhage. *Stroke*. 2007 Aug;38(8):2315–21. <https://doi.org/10.1161/STROKEAHA.107.484360>. Epub 2007 Jun 14. PMID: 17569871.

Topic: Neurointensive care.

000108

Prognostic factor of respiratory failure in tuberculosis

J. Ryoo¹, J. Lee²

¹Division of Pulmonary, Allergy and Critical Care, The Catholic University of Korea, Seoul, Republic of Korea; ²Division of Pulmonary, Allergy and Critical Care, Seoul St. Mary's Hospital, College of Medicine, The Catholic University of Korea Songjeui Campus, Seoul, Republic of Korea.

Correspondence: J. Ryoo

Intensive Care Medicine Experimental 2023, **11(Suppl 1)**:000108

Introduction. The predictive factors of tuberculosis were known as low BMI, hypoalbuminemia, longer time to diagnosis and treatment. However, there were little to validate and develop the prognostic factor of respiratory failure in tuberculosis (TB) patients. We investigated the prognostic factor of respiratory failure with TB.

Methods. This study used a retrospective cohort of TB at the Catholic Medical Center between January 2019 and December 2021. Of 488 patients diagnosed as TB, 52 patients who transferred to the other hospitals were excluded. Respiratory failure was defined as PF ratio ≤ 300 .

Results. A total of 436 patients were included in analysis, and 31 (7.11%) patients developed respiratory failure during treatment. We analyzed by dividing into 405 patients who were diagnosed as TB without respiratory failure and 31 patients who were diagnosed as TB with respiratory failure. Sex was not distinctive. Age was older in the respiratory failure group (59.7 ± 16.76 vs. 67.9 ± 17.44 ; p -value 0.009). BMI was not different statistically. However, the respiratory failure group tended to lower BMI (22.28 ± 3.38 vs. 22.00 ± 4.33 ; $p=0.0736$). The number of the patients who had underlying diseases were higher in respiratory failure with TB group (56.5% vs. 90.3%; p -value < 0.001). Respiratory failure with TB group took longer time from symptom onset to diagnosis (19.78 ± 26.67 days vs. 27.53 ± 42.44 days; $p=0.004$). Anemia and hypoalbuminemia and severe radiologic TB involvement confirmed by radiologist were more common in respiratory failure with TB group (12.69 ± 2.15 vs. 11.93 ± 2.38 ; $p < 0.001$, 3.8 ± 0.68 vs. 2.35 ± 0.69 ; $p < 0.001$, 10.07% vs. 18.45%; $p=0.006$). But cavity lesion, AFB stain, culture was not different between two groups.

Conclusions. Not only low BMI, hypoalbuminemia, longer time from symptom onset to diagnosis but also anemia was associated with respiratory failure with TB. We should try to find to modifiable prognostic factor in respiratory failure with TB.

Topic: Infections and prevention.

000109

Immunosenescence and cytomegalovirus reactivation in ICU-admitted severe SARS-CoV-2 patients

V. Ruiz de Santaquiteria Torres¹, A. Estrella Alonso¹, R. Fernández Tobar¹, N. Arriero Fernández¹, M. D. M. Rubio Arroyo², B. Castiñeiras Amor¹, Z. Eguileor Marín¹, J. P. Copa Morales¹, W. Chas Brami¹, G. A. González Wagner¹, J. E. Romo Gonzales¹, C. Benito Puncel¹, E. Quiros Oyaguez¹, A. Albaya Moreno¹, B. Mariblanca-Nieves¹, R. Garcia Hernández¹, C. Marian Crespo¹, J. A. Silva Obregón¹

¹Intensive Care Unit, Hospital Universitario de Guadalajara, Guadalajara, Spain; ²Obstetrics and Gynaecology, Hospital Universitario de Guadalajara, Guadalajara, Spain

Correspondence: V. Ruiz de Santaquiteria Torres

Intensive Care Medicine Experimental 2023, **11(Suppl 1)**:000109

Introduction. Immunosenescence could play a crucial role in the elderly fast worsening. Cytomegalovirus (CMV) past infection is a contributing factor, but CMV reactivation could lead to an uncontrolled immune response and increase morbimortality.

Objectives. To describe the potential nexus between CMV reactivation and severe SARS-CoV-2 patients' morbimortality.

Methods. A prospective study (February 2020 to December 2021) in ICU-admitted severe COVID-19 patients. Demographics, comorbidity, severity, treatment strength, ICU stay and ICU mortality were tested. Categorical variables were expressed as frequencies and percentages, and qualitative as median and interquartile range. Multivariate logistic regression was used to evaluate CMV reactivation. Odds ratio and confidence interval of 95% were performed.

Results. From an amount of 246 patients, 37 (15%) developed CMV reactivation with a median time of onset of 22 days (14–30) from ICU admission. Univariate analysis (Table 1) showed CMV reactivation probability multiplied by three in above-70-year patients. In addition, CMV reactivation patients had, with statistical significance, more renal failure and thrombocytopenia. No differences were found in steroid administration or mechanical ventilation indication, but a higher time of mechanical ventilation, catecholamines, renal replacement and blood transfusion were needed. Furthermore, ICU length-of-stay and mortality were increased. Multivariate analysis showed ICU length-of-stay and age above 70 were CMV reactivation independent predictors (Table 2).

Table 1	Total (N = 246)	CMV (n = 37)	No CMV (n = 209)	OR (CI 95%)	P
Age	65.4 (56,6–72,2)	71,2 (66,7–74,2)	63,5 (55,5–71,2)	1.07 (1,03–1.11)	0,001
< 70 years	165 (67,07)	17 (45,95)	148 (70,81)	1	
Renal failure	105 (42,7)	22 (59,5)	83 (39,7)	2,27 (1,09–4,54)	0,028
Thrombocytopenia	42 (17,07)	16 (43,24)	26 (12,44)	5,36 (2,48–11,57)	< 0,001
Time of MV	11,41 (5,7–24,6)	31,6 (24–47,8)	9,5 (4,9–18,7)	1,10 (1,7–1,13)	< 0,001 emphasis>
Catecholamines	183 (74,4)	35 (94,6)	148 (70,8)	7,21 (1,68–30,93)	0,008
Renal replacement	18 (7,32)	6 (16,2)	12 (5,74)	3,18 (1,11–9,09)	0,031
Blood transfusion	53 (21,5)	21 (56,76)	32 (15,31)	7,26 (3,42–15,39)	< 0,001
ICU length-of-stay	14,8 (9,25–30,83)	47,9 (27,8–66,38)	13 (8,77–24,69)	1,07 (1,05–1,10)	< 0,001
ICU mortality	67 (27,24)	16 (43,24)	51 (24,40)	2,36 (1,14–4,86)	0,020

CMV: Cytomegalovirus. OR: Odds Ratio. CI: Confidence Interval. BMI: Body Mass Index. CFS: Clinical Frailty Scale. APACHE: Acute Physiology and Chronic Health Evaluation. SOFA: Sequential Organ Failure Assessment. ICU: Intensive Care Unit. MV: Mechanical Ventilation

Table 1 (abstract 000109)

Table 2	HR	CI 95%	p
Age > 70 years	3,88	1,48 – 10,1	0,006
ICU stay	1,07	1,02 – 1,12	0,004

HR: Hazard Ratio. CI: confidence Interval. ICU: Intensive Care Unit

Table 2 (abstract 000109)

Conclusions. In our series, age above 70 is an independent factor of CMV reactivation in severe ICU-admitted COVID-19 patients. This association could be explained by immunosenescence, however, more studies are needed to prove it.

Topic: Infections and prevention.

000110

Infectious factors related to in-hospital mortality in COVID-19 patients

V. Ruiz de Santaquiteria Torres¹, M. D. M. Rubio Arroyo², B. Castiñeiras Amor¹, A. Estrella Alonso¹, R. Fernández Tobar¹, N. Arriero Fernández¹, Z. Eguileor Marín¹, J. P. Copa Morales¹, C. Benito Puncel¹, J. E. Romo Gonzales¹, G. A. González Wagner¹, W. Chas Brami¹, B. Mariblanca-Nieves¹, A. Albaya Moreno¹, R. Garcia Hernández¹, E. Yañez Parareda¹, N. Agurto-Rivera¹, E. Quiros Oyaguez¹, C. Marian Crespo¹, J. A. Silva Obregón¹

¹Intensive Care Unit, Hospital Universitario de Guadalajara, Guadalajara, Spain; ²Obstetrics and Gynaecology, Hospital Universitario de Guadalajara, Guadalajara, Spain

Correspondence: V. Ruiz de Santaquiteria Torres
Intensive Care Medicine Experimental 2023, 11(Suppl 1):000110

Introduction. Bacterial, viral or fungal coinfections (usually Cytomegalovirus (CMV) and Aspergillus spp.) play an important role in morbidity mortality in Intensive Care Unit (ICU). During severe COVID-19, steroids immunosuppressor therapy may increase the risk of developing these coinfections and, therefore, of morbimortality.

Objectives. To evaluate infectious factors as possible mortality predictors in severe SARS-CoV-2 patients.

Methods. A prospective study (February 2020 to December 2021) in ICU-admitted severe COVID-19 patients was performed. Demographics, comorbidity, severity, mechanical ventilation and steroid treatment, infectious factors and ICU stay were tested. Categorical variables were expressed as frequencies and percentages, and qualitative as median and interquartile range. Univariate logistic regression and Multivariate cox regression was used to evaluate in-hospital mortality factors. Odds ratio, Hazard ratio and confidence interval of 95% were performed.

Results. 246 patients were evaluated. The in-hospital mortality was 30%. The deceased were elderly and with more comorbidities, as well as worse ICU admission severity, with more mechanical ventilation needs, and higher steroid cumulative dose. In relation to evaluated infectious factors, just CMV reactivation and ICU admission septic shock was associated with mortality in univariate analysis (Table 1). However, after variable adjustment, septic shock at ICU admission was an independent in-hospital mortality factor (Fig. 1).

Table 1	Total (N = 246)	Dead (n = 74)	Alive (n = 172)	OR (CI 95%)	p
Age (years)	65.4 (56.6–72.2)	71.2 (63.1–75.5)	62.1 (53.2–69.7)	1.08 (1.05–1.12)	< 0.001
Elderly (> 70 years)	81 (32.9)	41 (55.4)	40 (23.3)	4.1 (2.3–7.32)	< 0.001

Table 1	Total (N = 246)	Dead (n = 74)	Alive (n = 172)	OR (CI 95%)	p
Charlson (per age)	0 (0–1)	1 (0–2)	0 (0–1)	1.58 (1.24–2.02)	< 0.001
APACHE II (per age)	12 (10–15)	14 (11–17)	12 (10–14)	1.13 (1.06–1.2)	< 0.001
SOFA	6 (4–8)	7 (6–9)	5 (3–7)	1.44 (1.26–1.64)	< 0.001
MV	213 (86.6)	73 (98.7)	140 (81.4)	16.69 (2.23–124–6)	0.006
SS (ICU admission)	18 (7.3)	15 (20.3)	3 (1–74)	14.32 (4–51.23)	< 0.001
Steroids c. (mg)	850 (600–1520)	1200 (750–2300)	800 (550–1310)	1 (1–1)	0.001
CMVr	37 (15.04)	17 (23)	20 (11.6)	2.27 (1.11–4.63)	0.025
CAPA	15 (6.1)	8 (10.8)	7 (4.1)	2.86 (0.99–8.2)	ns
Candida (col)	126 (51.2)	39 (52.7)	87 (50.6)	1.09 (0.63–1.88)	ns
Bacteremia	25 (10.2)	9 (12.2)	16 (9.3)	1.35 (0.57–3.21)	ns
MR (col)	33 (13.4)	12 (16.2)	21 (12.2)	1.39 (0.65–3)	ns
ICU stay (days)	14.8 (9.25–30.83)	17.3 (11–28.2)	13.7 (8.9–32.5)	1 (0.99–1.01)	ns
In-hospital stay (day)	29.9 (18.8–52.3)	25.6 (14.8–37.1)	21.6 (19.6–62.2)	0.98 (0.98–0.99)	0.003

OR: Odds Ratio. CI: Confidence Interval. APACHE: Acute Physiology And Chronic Health Evaluation. SOFA: Sequential Organ Failure Assessment. MV: Mechanical Ventilation. SS: Septic Shock. ICU: Intensive Care Unit. C: Cumulative. CMVr: Cytomegalovirus reactivation. CAPA: Covid-19 Associated Pulmonary Aspergillosis. Col: Colonization. MR: Multiresistant

Conclusions. As other series show, there is no association between CMV reactivation and in-hospital mortality. Septic shock at ICU admission is an independent in-hospital mortality factor in severe SARS-CoV-2 patients.

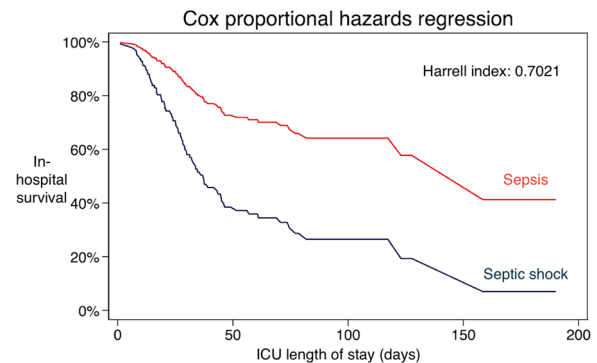

Figure 1 (abstract 000110)

Topic: Infections and prevention.

000115

Early implementation experiences with a multicomponent family support intervention in adult intensive care units (FICUS Trial)

S. Oesch¹, L. Verweij¹, R. Naef¹

¹Institute for Implementation Science in Health Care, University of Zurich, Zurich, Switzerland

Correspondence: S. Oesch

Intensive Care Medicine Experimental 2023, **11(Suppl 1)**:000115

Introduction. The multicenter FICUS trial was launched in June 2022 to investigate whether a nurse-led family support intervention (FSI) increases the quality of care and reduces negative mental health outcomes for family members of critically ill patients in 16 Swiss intensive care units (ICU) (Naef et al., 2022). Successful delivery of the three FSI components, namely family engagement, support, and communication, is expected to be critically influenced by ICU contexts (May et al., 2016; Pfadenhauer et al., 2017; Skivington et al., 2021). Hence, a mixed-methods multiple case study is conducted alongside the main FICUS cluster-randomized trial with a process and summative evaluation of the implementation.

Objectives. The aim of the first process evaluation data collection time point was to assess key clinical partner's understanding and perceptions of the FSI, influencing contextual determinants, and the implementation progress.

Methods. Qualitative process data were collected three months after implementation start (September to December 2022) as part of an interprofessional meeting that was scheduled to support implementation and to ensure quality of FSI delivery. Data were collected from 30 key clinical partners (intervention nurses, implementation support persons, physicians, and nurse leaders) of the eight participating ICUs allocated to the intervention arm. Audiotaped qualitative data was analyzed inductively and deductively using a pragmatic rapid thematic analysis approach.

Results. We identified four themes with subthemes, namely 1) key clinical partner's appraisal of the FSI through positive feedback from families (i.e., perceived fit and value of the FSI for family members and enhanced relationship between families and ICU staff through higher continuity of care), 2) interprofessional workflow and communication (i.e., collaboration and communication between physicians and family nurses, leadership support of family nurses, culture of interprofessional communication, collaboration and involvement of bedside nurses in family care), 3) individual capacity and ICU staff resources for FSI implementation and delivery (i.e., ICU staff resources, family nurses' capacity and availability for FSI delivery) and 4) external support structures (i.e., support by the study team, ongoing exchange and reflection with peers within study).

Conclusions. Our implementation is well underway. Preliminary findings of this first process assessment demonstrate the most influencing determinants related to interprofessional coordination of family care and the necessity of individual changes in behaviour and individual workflow. Additionally, delivering the FSI as part of a clinical study was experienced as challenging.

References

1. Naef, R., Filipovic, M., Jeitiner, M. M., von Felten, S., Safford, J., Riguzzi, M., & Rufer, M. (2022). A multicomponent family support intervention in intensive care units: study protocol for a multicenter cluster-randomized trial (FICUS Trial). *Trials*, 23(1), 533. <https://doi.org/10.1186/s13063-022-06454-y>
2. May, C. R., Johnson, M., & Finch, T. (2016). Implementation, context and complexity. *Implementation Science*, 11(1), 141. <https://doi.org/10.1186/s13012-016-0506-3>
3. This study is funded by the Swiss National Science Foundation and supported by the Swiss Society of Intensive Care Medicine.
4. We are very grateful to the local key clinical partners, participating and supporting this study.

5. Skivington, K., Matthews, L., Simpson, S. A., Craig, P., Baird, J., Blazeby, J. M., Boyd, K. A., Craig, N., French, D. P., McIntosh, E., Petticrew, M., Rycroft-Malone, J., White, M., & Moore, L. (2021). A new framework for developing and evaluating complex interventions: update of Medical Research Council guidance. *Bmj*, 374, n2061. <https://doi.org/10.1136/bmj.n2061>
6. Pfadenhauer, L. M., Gerhardus, A., Mozygemba, K., Lysdahl, K. B., Booth, A., Hofmann, B., Wahlster, P., Polus, S., Burns, J., Brereton, L., & Rehfuess, E. (2017). Making sense of complexity in context and implementation: the Context and Implementation of Complex Interventions (CICI) framework. *Implementation Science*, 12(1), 21. <https://doi.org/10.1186/s13012-017-0552-5>

Topic: Nursing care and physiotherapy.

000116

ICU physicians' beliefs and perceived importance of TBI-associated agitation in critically ill patients. A survey of Canadian intensivists

M. Saavedra-Mitjans¹, A.J. Frenette², V. McCredie³, L. Burry⁴, C. Arbour⁵, S. Mehta⁶, E. Charbonney⁷, H. T. Wang⁸, A. Martin⁹, F. Bernard⁹, D. Williamson¹⁰

¹Pharmacy, University of Montreal, Montréal, Canada; ²Pharmacy, Hôpital du Sacré-Coeur de Montreal, Montréal, Canada; ³Critical Care, Toronto Western Hospital, Toronto, Canada; ⁴Pharmacy, Mount Sinai Hospital, Toronto, Canada; ⁵Research centre, Hôpital du Sacré-Coeur de Montreal, Montréal, Canada; ⁶Interdepartmental division of critical care medicine, University of Toronto, Toronto, Canada; ⁷Intensive care, CHUM—Centre hospitalier de l'Université de Montréal, Montréal, Canada; ⁸Critical care, CHUM—Centre hospitalier de l'Université de Montréal, Montréal, Canada; ⁹Critical care, Hôpital du Sacré-Coeur de Montreal, Montréal, Canada; ¹⁰Pharmacy and critical care, Hôpital du Sacré-Coeur de Montreal, Montréal, Canada

Correspondence: D. Williamson

Intensive Care Medicine Experimental 2023, **11(Suppl 1)**:000116

Introduction. Agitation is a common behavioral problem following traumatic brain injury (TBI). Intensive care physicians' opinions and beliefs concerning agitation on TBI patients are unknown.

Objectives. The objective was to describe ICU physicians' beliefs and perceived importance of TBI-associated agitation in critically ill patients.

Methods. Following current standard guidelines, an electronic, self-administrated, closed-answer questionnaire was built to survey the 219 physicians working in ICU Level-1 trauma centre in Canada. Each centre was contacted to identify ICU physicians included in our participants list. The 42-items survey was pre-tested for reliability and validity. Results are reported using descriptive statistics.

Results. The overall response rate was 93/219 (42%) and the completion rate was 76/93 (82%). Responses represented all Level-1 trauma centers and all Canadian provinces. A total of 87% of respondents considered TBI agitation frequent enough to justify the implementation of management protocols. More diverse were the beliefs regarding sex, gender, age and socio-economic status. Respondents believe pre-existing dementia and regular recreational drug use are potential risk factors for agitation (90% and 86%, respectively). A total of 72% of respondents stated that alfa-2 adrenergic agonists efficacious for the management of TBI agitation, 90% believed that the severity of agitation can be reduced by the presence of family at the bedside, 91% believed the use of physical restraints can worsen agitation episodes. However, 84% of respondents perceived the current level of evidence insufficient. More than 85% of respondents were worried of acute and long-term detrimental outcomes and burden to patients, health care professionals and relatives.

Conclusions. TBI-associated agitation in critically ill patients is perceived as an important issue for ICU physicians. More variability was found in their beliefs on epidemiology, risks factors and management tools.

Topic: Neurointensive care.

000117

Cognitive and motor function effects of antipsychotics in traumatic brain injury: a systematic review of preclinical studies

G. Cataford,¹ L. A. Monton,¹ S. Karzon,¹ C. Livernoche-Leduc,² M. Saavedra-Mitjans¹, M. J. Potvin,² F. Bernard,³ L. Burry⁴, C. Arbour⁵, D. Williamson³

¹Pharmacy, University of Montreal, Montréal, Canada; ²Psychology, Université du Québec à Montréal, Montréal, Canada; ³Critical care, Hôpital du Sacré-Coeur de Montreal, Montréal, Canada; ⁴Pharmacy, Mount Sinai Hospital, Toronto, Canada; ⁵Research centre, Hôpital du Sacré-Coeur de Montreal, Montréal, Canada

Correspondence: D. Williamson

Intensive Care Medicine Experimental 2023, **11(Suppl 1)**:000117

Introduction. Traumatic brain injury (TBI) survivors often suffer from agitated behaviors and will most likely receive pharmacological treatments. Choosing an optimal and safe pharmacological treatment that will not interfere with neurological recovery, remains controversial. Despite their frequent use, there have been no randomized controlled studies of antipsychotics for the management of agitation in TBI patients. By interfering with dopaminergic circuits, antipsychotics may impede neuronal plasticity processes important to cognitive recovery. To date, there has been no systematic evaluation of the pre-clinical literature summarizing the effects of antipsychotics on cognitive and motor function following experimental TBI. We conducted a systematic review and meta-analysis of pre-clinical studies evaluating the effects of antipsychotics following TBI on both cognitive and motor recovery.

Methods. The systematic review was carried out in accordance with Preferred Reporting Items for Systematic Reviews and Meta-Analyses (PRISMA) guidelines, the SYRCLÉ guidelines for animal intervention studies and the protocol was registered on the International Platform of Registered Systematic Review and Meta-analysis Protocols (INPLASY202310034). Two investigators designed the search strategy and conducted the search. The MEDLINE and Embase databases were searched and references of identified studies were screened for additional studies. All pre-clinical animal studies evaluating the effects of antipsychotics on cognitive and motor functions were considered for inclusion. We only included studies administering antipsychotic agents after inducing a TBI. Studies, including randomized and non-randomized experiments, comparing pharmacological agents to a placebo, an active treatment or a non-pharmacological intervention were included. We considered studies with all types of mammals reproducing any form of TBI. We included animal models measuring motor and cognitive functions. Two reviewers independently evaluated each included study with the SYRCLÉ's risk of bias tool for animal studies. To enable meta-analysis, we graphically extrapolated repeated data measures and standard errors of the mean using WebPlotDigitizer 4.3.

Results. The search strategy identified 924 articles. After removal of duplicates, 896 articles were screened using the title and abstract. Full text assessment of 34 studies identified a total of 15 studies meeting the inclusion and exclusion criteria. In total, 1188 rodents were included in the studies. Haloperidol was the most studied antipsychotic (10 studies) followed by risperidone (3 studies) and aripiprazole (2 studies). The systematic review and meta-analysis revealed no consistent effect of haloperidol on motor function as evaluated by the beam balance and beam walk tests. However, risperidone was associated with a significant impairment motor function on day 5 post-injury. Atypical antipsychotics (aripiprazole, olanzapine and quetiapine) were not associated with impaired motor function, with aripiprazole improving beam-walk scores. In the 9 studies evaluating the Morris Water Maze (MWM) for cognitive function with haloperidol, the haloperidol-treated animals were significantly more impaired than the vehicle controls after 15 to 18 days. The 5 studies of risperidone showed similar results with increased impairment in

the risperidone-treated animals after 15 to 18 days. In one study, the effects of haloperidol administered during 19 consecutive days on the MWM task persisted one month after drug cessation. The combination of atypical antipsychotics (olanzapine, quetiapine and aripiprazole) showed no increased impairment after 15 to 18 days. When combining the two studies evaluating aripiprazole and including a group with environmental enrichment, there was a trend towards a reduction in MWM impairment. Finally, only continuous daily administration of haloperidol and risperidone were associated with cognitive dysfunction when compared to less frequent administration.

Conclusions. Continuous administration of haloperidol or risperidone may impede cognitive recovery from TBI. Intermittent dosing seems safer but would need to be studied in humans. Clinicians should avoid the use of regular use of haloperidol and risperidone until human studies are available.

Topic: Neurointensive care.

000121

External validation of HACOR score and ROX score for patients with coronavirus disease 2019 pneumonia managed with high-flow nasal cannula in Japan: a multicenter retrospective observational study

H. Okano¹, R. Yamamoto², Y. Iwasaki³, D. Irimada³, T. Tanaka⁴, T. Oishi⁵, H. Nawa⁶, A. Yano⁷, H. Taniguchi⁸, M. Otawara⁹, A. Matsuoka¹⁰, D. Konno³, M. Yamauchi³

¹Department of Intensive care medicine, St. Luke International hospital, Tokyo, Japan; ²Center for Innovative Research for Communities and Clinical Excellence (CIRC2LE), Fukushima Medical University, Fukushima, Japan; ³Department of Anesthesiology and Perioperative Medicine, Tohoku University Graduate School of Medicine,, Sendai, Japan; ⁴Department of Emergency and Critical Care Medicine, Nagoya University Graduate School of Medicine,, Nagoya, Japan; ⁵Department of Emergency and Critical Care Medicine, Jichi Medical University Saitama Medical Center, Saitama, Japan; ⁶Department of Intensive Care Medicine, Kameda Medical Center, Kamogawa, Japan; ⁷Department of General Medicine, Kochi Health Sciences Center, Kochi, Japan; ⁸Department of Traumatology and Critical Care Medicine, National Defense Medical College Hospital, Tokorozawa, Japan; ⁹Emergency and Critical Care, Tokyo Metropolitan Hiroo Hospital, Tokyo, Japan; ¹⁰Department of Emergency and Critical Care Medicine, Faculty of Medicine, Saga University, Saga, Japan

Correspondence: H. Okano

Intensive Care Medicine Experimental 2023, **11(Suppl 1)**:000121

Introduction. The ROX score has been validated and is widely used as a predictor of intubation in COVID-19 pneumonia patients treated with high-flow nasal cannula (HFNC). This score is calculated using only three variables: respiratory rate, SpO2 and fraction of inspired oxygen (FiO2) [1]. However, other critical indicators such as consciousness, blood pressure and acid-base balance are also important factors in determining the need for intubation. The HACOR score is a tool for predicting failure of non-invasive ventilation (NIV) and HFNC that incorporates these additional factors [1]. However, external validation of the HACOR score for predicting intubation in COVID-19 pneumonia patients treated with HFNC is limited. Therefore, the aim of this study is to externally validate both the HACOR score and the ROX score in the Japanese population.

Methods. This retrospective, observational, multicenter study was approved by the institutional review board of Tohoku University (2022-I-265) and each participating center. Patients with COVID-19 aged 18 years or older who were treated with HFNC between 16 January 2020 and 31 March 2022 (January 2020 to 2021: B.1.1.7 (alpha), July to December 2021: B.1.617.2 (delta), January to June 2022: B.1.1.529 (Omicron), July 2022 onwards: Omicron BA.5 in Japan). Patients who used HFNC after extubation or after using NIV were excluded. HACOR

score and ROX score were calculated at 2, 6, 12, 24, and 48 h. The target condition was treatment failure (intubation or death within 7 days). We calculated the area under the receiver operating characteristic curve (AUC-ROC) and calibration as diagnostic performance. We also assessed sensitivity and specificity at the 2-h time point using the cut-off value reported in a previous study (HACOR > 5 [2], ROX < 2.85 [1]).

Results. We analyzed 300 patients from nine medical centers (median age, 60 years; 76% male; median PaO₂/FiO₂ ratio at the start of HFNC, 157). The 7-day mortality was 2% (6/300) and the in-hospital mortality was 14% (43/300). Within 7 days of HFNC, 127 patients (42%) either required endotracheal intubation or died. The discrimination of the HACOR score and the ROX score at the 2-h time point was AU-ROC 0.63 and 0.57, respectively. The temporal changes in the discrimination of the HACOR score and the ROX score were 0.58 and 0.62 at 6 h, 0.70 and 0.68 at 12 h, 0.68 and 0.69 at 24 h, and 0.75 and 0.75 at 48 h. Sensitivity and specificity at the 2-h cut-off values were 18% sensitivity and 91% specificity for the HACOR score and 0% sensitivity and 100% specificity for the ROX score. Visual calibration assessment (Figs. 1 and 2) showed that the HACOR score at 6 h and the ROX score were not well calibrated. At 2 h, approximately 25% of patients with a HACOR score of 0 experienced treatment failure, while about 30% of those in the low-risk group by ROX score experienced treatment failure.

Conclusions. In patients with COVID-19 undergoing HFNC in Japan, the predictive performance of the HACOR score and the ROX score was inadequate. However, the discrimination of both scores tended to improve over time.

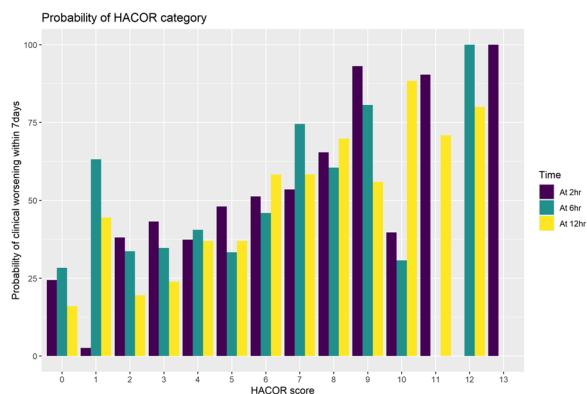

Figure 1 (abstract 000121) Calibration of HACOR score

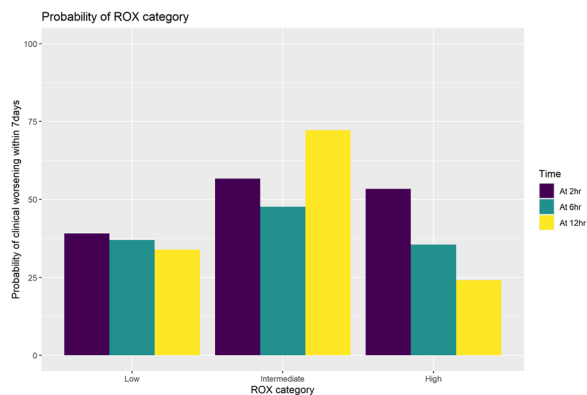

Figure 2 (abstract 000121) Calibration of ROX score

References

1. None
2. 1.Roca O, Caralt B, Messika J, et al. An Index Combining Respiratory Rate and Oxygenation to Predict Outcome of Nasal High-Flow Therapy. *Am J Respir Crit Care Med.* 2019;199(11):1368–1376. <https://doi.org/10.1164/rccm.201803-0589OC>
3. 2.Duan J, Han X, Bai L, Zhou L, et al. Assessment of heart rate, acidosis, consciousness, oxygenation, and respiratory rate to predict noninvasive ventilation failure in hypoxemic patients. *Intensive Care Med.* 2017;43(2):192–199. <https://doi.org/10.1007/s00134-016-4601-3>

Topic: Acute respiratory failure and mechanical ventilation.

000122

Impact of early renal replacement therapy in leptospirosis on mortality and long term renal function: a retrospective analysis over 11 years in the Reunion Island

M. Julien¹, Y. Lombardi¹, L. Raffray², C. Rafat¹, J. Jabot³

¹Nephrological intensive care unit and acute kidney, Tenon Hospital, Paris, France; ²Internal et immunological medicine, CHU Felix-Guyon, Saint-Denis, La Réunion, France; ³Medical-surgical intensive care unit, CHU Felix-Guyon, Saint-Denis, La Réunion, France

Correspondence: M. Julien

Intensive Care Medicine Experimental 2023, **11(Suppl 1)**:000122

Introduction. Leptospirosis is a widespread zoonosis responsible for 60,000 deaths annually worldwide (1). Acute kidney injury (AKI) is a hallmark of the disease. In addition leptospirosis-induced AKI (AKI-L) has been entertained as a potential cause of chronic kidney injury of unknown etiology, which is a significant burden in tropical rural settings (2,3). Anecdotal evidence suggests that early renal replacement therapy (RRT) may improve mortality associated with AKI-L (4). Conversely, intensive care unit (ICU)-based trials, including the landmark AKIKI carried have disproved a positive impact of early RRT on patient mortality (5). We aimed to determine i) whether the timing of RRT positively impacts mortality ii) provide an estimation of the incidence of post-leptospirosis chronic kidney disease (CKD-L).

Methods. We conducted a retrospective study in the Reunion island (Indian Ocean) between 2010 and 2020, including adult patients with confirmed leptospirosis complicated by KDIGO 2 or 3 AKI. We collected demographic clinical data both during hospital stay and at follow-up. The primary endpoint was a composite endpoint including death and CKD-L up to 3 years after hospital discharge. Factors associated with CKD-L and death were determined using logistic regression models with different adjustment variables.

Results. Three hundred eighty patients were included, 83% of whom had KDIGO 3 AKI. 71% required ICU hospitalization, and 39% were placed on RRT with a median initiation time of 1 day (0–2 days). According to the composite criterion, there was a 4% mortality in the overall study population and 8% of CKD. On univariate analysis, factors associated with the composite criterion of CKD and death included ICU severity scores, age, baseline kidney function, oligo-anuria and the need for RRT. ICU severity score, age, baseline kidney function and the need for RRT were also associated with the criteria CKD alone on univariate analysis. Using bivariate models adjusting on age or SAPS2 or prior renal function, we showed that when compared to patients who did not require dialysis, no significant difference was found between early or late dialysis initiation on the composite endpoint (Fig. 1): OR for RRT before 24 h was 5.7 (1.9–17.9) and OR for RRT after 24 h was 5.7 (2.1–16.3). Similarly, the timing of RRT initiation, whether it was early or initiated according to AKIKI criteria was not associated with the criterion CKD alone on adjusted bivariate analysis (Fig. 2): OR for RRT early was 5.1 (1.6–17.8) and OR for RRT according AKIKI criteria was 14.1 (3.7–57.8). However, the three fold ratio between these 2 OR could suggest a beneficial association of early dialysis vs AKIKI on the CKDI.

Conclusions. In conclusion, leptospirosis accounts for significant CKD. Early RRT does not seem to improve the composite mortality-CKD endpoint. Further investigations are needed to substantiate the potentially protective effects of early RRT on CKD.

Bivariate analysis			
	OR	CI 95%	p
RRT < 24h	5.7	1.9–17.9	<0.01
RRT >24h	5.7	2.1–16.3	<0.001
SAPS2, per unit	1.1	1.0–1.1	<0.001

Figure 1 (abstract 000122) Bivariate analysis of factors associated with death and chronic kidney disease post leptospirosis at last follow-up, according to time to RRT initiation and patients' SAPSII score

Bivariate analysis			
	OR	CI 95%	p
Early RRT	5.1	1.6–17.8	<0.01
RRT according to AKIKI criteria	14.1	3.7–57.8	<0.001
SAPS2, per unit	1.0	1.0–1.1	0.1

Figure 2 (abstract 000122) Bivariate analysis of factors associated with chronic kidney disease post leptospirosis at last follow-up, according to time to RRT initiation and patients' SAPSII score

References

- Costa F, Hagan José, Calcagno J, Kane M, Torgerson PR, Matinez-Silveira MS, et al. Global Morbidity and Mortality of Leptospirosis: A Systematic Review. *PLoS Negl Trop Dis.* 2015; 9: e3898. doi: 10.1371/journal.pntd.0003898.
- Riefkohl A, Ramirez-Rubio O, Laws RL, McClean MD, Weiner DE, Kaufman JS, et al. Leptospira seropositivity as a risk factor for Mesoamerican Nephropathy. *Int J Occup Environ Health.* janv 2017;23(1):1–10.
- Yang CW. Leptospirosis Renal Disease: Emerging Culprit of Chronic Kidney Disease Unknown Etiology. *Nephron.* 2018;138(2):129–36.
- Andrade L, Cleto S, Seguro AC. Door-to-Dialysis Time and Daily Hemodialysis in Patients with Leptospirosis: Impact on Mortality. *Clin J Am Soc Nephrol.* juill 2007;2(4):739–44
- Gaudry S, Hajage D, Schortgen F, et al. Initiation strategies for renal-replacement therapy in the intensive care unit. *N Engl J Med.* 2016;375(2):122–33.

Topic: Acute Kidney Injury and haemofiltration.

000129

Establishing lines of communication for rehabilitation in intensive care

K. Gollub¹, J. Zanin¹, M. Desai¹, T. Ali¹

¹Intensive Care Unit, Stoke Mandeville Hospital, Aylesbury, United Kingdom

Correspondence: K. Gollub

Intensive Care Medicine Experimental 2023, **11(Suppl 1)**:000129

Introduction. Rehabilitation goal setting during the ICU admission reduces the risk of Post Intensive Care Syndrome-related morbidity.1 In the UK, the National Institute of Care Excellence (NICE) Quality Statement 158 (QS158) recommends that carers/support persons of all adult ICU patients should be informed of rehabilitation goals within 4 days of admission or prior to discharge.2 During the emergency response phase of the COVID-19 pandemic, communication with carers/support persons was challenged by public health policies restricting visiting as well as the pressure on healthcare services. With services exiting the emergency response phase of the COVID-19 pandemic, it is essential to re-prioritise communication of rehabilitation goals with carers/support persons of patients admitted to ICU.

Objectives. To evaluate the documentation of communication with carers/support persons about rehabilitation goals for adults admitted

to ICU, to determine the extent to which Stoke Mandeville Hospital ICU is performing in relation to the NICE Quality Statement 158 (QS158).

Methods. Retrospective observational cohort review of admissions to Stoke Mandeville Hospital ICU between 1 January 2022 and 31 March 2022. Admissions were excluded if medical records were not available, if the patient transitioned to end of life care within 4 days of admission, or if rehabilitation goals were not set. A data collection proforma was used to systematically appraise scanned medical records by 2 auditors, with 10% of records dual screened to ensure inter-rater reliability. Discrepancies were discussed with intensive care consultants. Admissions were analysed according to length of stay [short stay (≤ 4 days), and long-stay (>4 days)]. Rehabilitation goals were defined as non-treatment goals aiming to optimise functioning or reduce disability.

Results. Of 127 ICU admissions during the study period, 41 were excluded (6 no records available; 18 end of life care, 17 no rehabilitation goal set). Notes from 86 admissions were analysed [52 (60%) short stay (≤ 4 days); 34(40%) long stay (>4 days)]. Rehabilitation goals were documented to have been communicated to carers/support persons in accordance with QS158 timeframe for 24 (46%) and 28 (82%) for short versus long stay admissions respectively. While nurses more commonly documented informing carers/support persons about rehabilitation goals for both admission groups, they were often the only multidisciplinary team representative to do so for patients with a short stay. Doctors were significantly more likely to document information given to carers/support persons about rehabilitation goals for long stay patients, which likely represents the complexity of the treatment and rehabilitation course. Multiple members of the multidisciplinary team were frequently involved with updating carers/support persons for the long stay cohort, which is generally consistent with duration of critical illness, ICU-related interventions, and phases of rehabilitation.

Conclusions. The bedside nurse is most frequently documented conversations with carers/support persons of ICU patients. There is a need for a standardised approach to documenting the communication of holistic rehabilitation goals in a manner that has low administration burden. Such an approach should be integrated into the bedside electronic patient records, minimise duplication and be easily accessible to and editable by all members of the multidisciplinary team.

References

- Colbenson, G. A., Johnson, A., & Wilson, M. E. (2019). Post-intensive care syndrome: impact, prevention, and management. *Breathe (Sheffield, England)*, 15(2), 98–101. <https://doi.org/10.1183/20734735.0013-2019>
- NICE. QS 158 Rehabilitation after Critical Illness in Adults 2017. <http://www.nice.org.uk/guidance/qs158>

Topic: Critical care organisation, quality management, information systems, outcomes.

000132

Prognostic accuracy of oxygen debt (DEOx) for mortality in patients with V-A ECMO support

M. Perez Garzon¹, C. Poveda-Henao¹, H. Robayo-Amortegui², N. Valenzuela Faccini², A. Quintero Altare²

¹Intensive Care Unit, Shaio Clinic, Bogotá, Colombia; ²Medicine, Critical Care Resident, Universidad de La Sabana, Chia, Colombia

Correspondence: A. Quintero Altare

Intensive Care Medicine Experimental 2023, **11(Suppl 1)**:000132

Introduction. Venous arterial extracorporeal membrane oxygenation (VA-ECMO) is a form of temporary mechanical circulatory support and simultaneous extracorporeal gas exchange for acute cardiorespiratory failure (1). Its use has increased significantly in recent years, becoming an invaluable bridging strategy for the care of critically ill patients (2). According to the ELSO registry, since 1995, more than 15,000 patients have received VA ECMO with a survival rate at hospital discharge of approximately 40%(1,3). Given the high mortality, attempts have been made to predict the risk of multiorgan failure (MOF) progression and mortality using various scales such as the Sequential Organ Failure Assessment score (SOFA)(4), Acute Physiology and Chronic Health

Assessment (APACHE) (1), Survival after veno-arterial ECMO (SAVE) score(5).

The oxygen debt (DEOx) determines the total amount of oxygen molecules that do not supplement excessive oxygen consumption (VO2) at rest, without being altered by body temperature, age, and body surface area (6,7). Given the complexity of this concept, simplified formulas have been proposed for the calculation of DEOx with parameters easily obtainable from the measurement of arterial gasses (6). Showing an adequate correlation with mortality and MOF in critically ill patients (8).

Objectives. To determine the validity of the quantitative measurement of oxygen debt (DEOx) by arterial gasses and to evaluate its predictive capacity for 28-day mortality and progression to multiple organ failure (MOF) in patients with veno-arterial ECMO.

Methods. Validation study of a prognostic test in a retrospective cohort of adult patients with an indication for VA ECMO support at Shaio Clinical Foundation in Bogotá DC, Colombia between 2020–2021. The primary outcome was mortality. APACHE 2, SOFA, and SAVE score were compared with DEOx, as well as the difference in associated factors using a crude and adjusted analysis, performing the area under the curve of the receiver operating characteristic.

Results. Of the 210 patients admitted during the study, 33 were selected, of whom 13 (39%) died. The average age of the population was 46.4 years (SD 12.3), with a higher proportion in the male gender (60.6%), the multivariate analysis of the variables independently related to the primary outcome. This shows an independent statistically significant relationship for mortality with DEOx. Discrimination of the primary outcome for the APACHE score, SOFA score, SAVE score, and DEOx was AUROC 0.584 (CI 0.42–0.74), AUROC 0.461 (CI 0.38–0.53), AUROC 0.446 (CI 0, 28–0.6) and AUROC 0.623 (CI 0.47–0.77) respectively; with the DeLong test $P < 0.001$.

Conclusions. Our study shows the usefulness of the DEOx as a quantitative measurement to predict mortality in patients with VA ECMO support As it is a unique variable that is easily accessible at the patient's bedside with similar behavior to the other mortality scores, it could be a reproducible and valid method to implement its use.

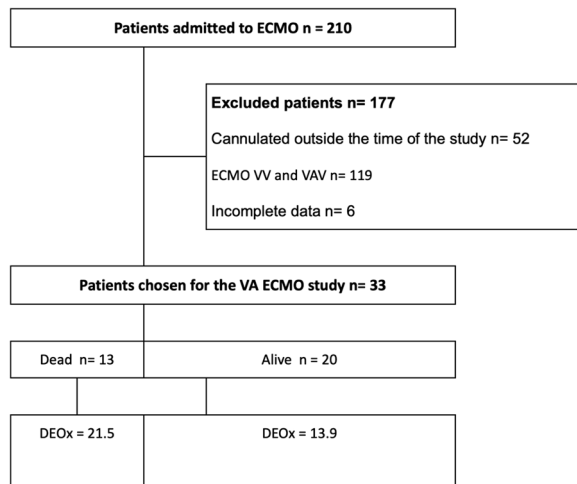

Figure 1 (abstract 000132) Flowchart for the admission of subjects to the study

Table 1. General characteristics

Characteristics	Population n = 33	Deaths = 13	Alive = 20	p= value
Age in years, mean (sd)	46.4 (12.3)	45.7 (12.9)	46.9 (12.1)	0.790
Gender, Male (%)	20 (60.6%)	8 (61.5%)	12 (60%)	0.930
Weight - Kg, mean (sd)	76.2 (17.5)	81.1 (22.6)	73.1 (12.8)	0.255
Body mass index, mean (sd)	27.1 (4.7)	28.4 (5.22)	26.9 (4.1)	0.246
ICU stay - IQR (Days)	16.2 (7-28.3)	7.9 (5.1-13.6)	22.5 (12.6-39.5)	0.024*
Mechanical ventilation IQR (Days)	11.3 (7.9-19.3)	9.9 (5.7-17.7)	19 (12.9-27.2)	0.336
Hospital stay, IQR (Days)	22 (13-36)	13 (10-22)	32 (17-56)	0.006*
Comorbidities, n (%)				
Arterial Hypertension	4 (12.1%)	2 (15.4%)	2 (10%)	0.643
Diabetes n	6 (18.2%)	2 (15.4%)	4 (20%)	0.737
Dyslipidemia	3 (9.1%)	1 (7.7%)	2 (10%)	0.822
Hypothyroidism	3 (9.1%)	2 (15.4%)	1 (5%)	0.311
Paraclinical tests prior to cannulation, mean (sd)				
Sodium meq/l	130.5 (94.1)	128.1 (39.1)	132.1 (31.3)	0.758
Potassium meq/l	4.04 (1.1)	3.82 (1.6)	4.18 (0.6)	0.448
Creatinine mg/dl	1.4 (0.7)	1.6 (0.8)	1.3 (0.6)	0.202
Thromboplastin time s	46.1 (27.8)	38.5 (21.5)	51.1 (30.7)	0.178
Glycemia mg/dl	133.9 (59.2)	150.4 (84.1)	123.3 (33.8)	0.286
Arterial blood gasses on admission mean (sd)				
pH	7.01 (1.27)	6.66 (2.1)	7.24 (0.22)	0.323
CO2 pressure mmHg	52.3 (26.1)	49.8 (23.9)	54 (27.9)	0.644
Base excess	-3.69 (7.67)	-4.81 (4.86)	-2.97 (9.1)	0.458
Lactate	3.84 (2.94)	3.08 (1.41)	4.33(3.55)	0.176
Cannulation support, n(%)				
Noradrenaline	30 (90.9%)	12 (92.3%)	18 (90%)	0.822
Levosimendan	9 (27.3%)	2 (15.4%)	7 (35%)	0.216
Vasopressin	27 (81.8%)	10 (76.9%)	17 (85%)	0.557
Dobutamine	15 (45.5%)	4 (30.8%)	11 (55%)	0.172
Cause of cardiogenic shock n (%)				
Postcardiotomy	12 (36.4%)	7 (53.8%)	5 (25%)	
Acute heart failure	8 (24.2%)	2 (15.4%)	6 (30%)	
Acute coronary syndrome	3 (9.1%)	2(15.4%)	1(5.0%)	
Pulmonary Embolism	3 (9.1%)	1 (7.7%)	2 (10%)	
Special conditions, n (%)				
Cardiac pacemaker	4 (12.1%)	1 (7.7%)	2 (10%)	0.335
Heparin infusion	25 (75.7%)	8 (61.5%)	17 (85%)	0.124
Intra aortic balloon pump	13 (39.4%)	4 (30.8%)	9 (45%)	0.414
Severity score, mean (sd)				
APACHE II Score	8 (7-12)	9 (8-12)	8 (6-9.5)	0.158
APACHE II Score	15 (9-20)	21 (12-22)	12 (7-18)	0.017*
DEOx	16.8 (1.92 -39.1)	21.7 (7.57-38.1)	13.9 ((-2.1)-54.8)	0.118
SAVE Score	0 (-3 a 0)	0 (-2 a 1)	-1 (-3-0)	0.639

sd, standard deviation; IQR, interquartile range; ECMO, extracorporeal membrane oxygenation; SOFA, Sequential organ failure assessment; APACHE, acute physiology and chronic health disease classification system; *p < 0.05.

Table 2 (abstract 000132) Mortality prediction by prognostic in VA support

Terapia ECMO VA								
Score	Cut point	S (IC95%)	E (IC 95%)	VPP (IC 95%)	VPN (IC 95%)	RV (IC 95%)	RV- (IC 95%)	AUROC (IC95%)
APACHE II	12	81,6% (77,2 - 86,0)	42,5% (37,5 - 47,5)	53,2% (48,7 - 57,8)	74,2% (68,3 - 80,2)	1,42 (1,28 - 1,57)	0,43 (0,33 - 0,56)	0,584 (0,42 - 0,74)
SOFA	4	94,0% (91,2 - 97,8)	14,8% (11,1 - 18,3)	46,9% (42,9 - 50,8)	75,3% (65,1 - 85,6)	1,10 (1,05 - 1,16)	0,41 (0,25 - 0,67)	0,461 (0,38 - 0,53)
SAVE Score	<2	85,4% (81,3 - 89,4)	34,4% (29,5 - 39,2)	51,0% (46,7 - 55,4)	74,6% (67,9 - 81,2)	1,30 (1,19 - 1,42)	0,43 (0,31 - 0,57)	0,446 (0,28 - 0,60)
DEOx	3,78	84,4% (80,3 - 88,61)	32,8% (28,1 - 37,6)	50,2% (45,8 - 54,4)	72,5% (65,6 - 79,3)	1,26 (1,16 - 1,37)	0,47 (0,35 - 0,64)	0,623 (0,47 - 0,77)

S: Sensitivity, E: Specificity, PPV: Positive Predictive Value, NPV: Negative Predictive Value, RV+: Positive Likelihood Ratio, RV-: Negative Likelihood Ratio, AUROC: Area Under the Receiver Operating Characteristics Curve, SOFA: Sequential organ failure assessment, APACHE: acute physiology and chronic health disease classification system.

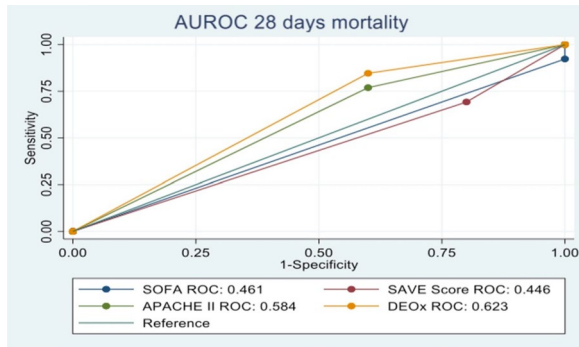

Figure 2 (abstract 000132) Comparison of DEOx mortality outcome compared to the different ICU mortality scores related to the general population with VA ECMO support

References

- Schmidt M, Burrell A, Roberts L, Bailey M, Sheldrake J, Rycus PT, et al. Predicting survival after ECMO for refractory cardiogenic shock: the survival after veno-arterial-ECMO (SAVE)-score. *Eur Heart J*. 2015 Sep 1;36(33):2246–56
- Laimoud M, Alanazi M. The Validity of SOFA Score to Predict Mortality in Adult Patients with Cardiogenic Shock on Venoarterial Extracorporeal Membrane Oxygenation. *Critical Care Research and Practice*. 2020 Sep 8;2020:1–9.
- Rao P, Khalpey Z, Smith R, Burkhoff D, Kociol RD. Venoarterial Extracorporeal Membrane Oxygenation for Cardiogenic Shock and Cardiac Arrest: Cardinal Considerations for Initiation and Management. *Circ: Heart Failure*. 2018 Sep;11(9):e004905
- Shoemaker WC, Appel PL, Kram HB. Tissue oxygen debt as a determinant of lethal and nonlethal postoperative organ failure. *Crit Care Med*. 1988 Nov;16(11):1117–20.
- Shoemaker WC, Appel PL, Kram HB. Role of oxygen debt in the development of organ failure sepsis, and death in high-risk surgical patients. *Chest*. 1992 Jul;102(1):208–15.
- Thiagarajan RR, Barbaro RP, Rycus PT, McMullan DM, Conrad SA, Fortenberry JD, et al. Extracorporeal Life Support Organization Registry International Report 2016. *ASAIO Journal*. 2017 Jan;63(1):60–7.
- Makdissi G, Wang IW. Extra Corporeal Membrane Oxygenation (ECMO) review of a lifesaving technology. *J Thorac Dis*. 2015 Jul;7(7):E166–176.
- Rixen D, Siegel JH. Bench-to-bedside review: oxygen debt and its metabolic correlates as quantifiers of the severity of hemorrhagic and post-traumatic shock. *Crit Care*. 2005 Oct 5;9(5):441–53.

Topic: Cardiovascular issues in ICU.

000133

Constipation in type B acute aortic dissection: a single-center retrospective observational study

T. Hoshino¹, Y. Enomoto², Y. Inoue¹

¹Department of Emergency and Critical Care Medicine, University of Tsukuba Hospital, Tsukuba, Japan; ²Emergency Care and Critical Care Medicine, University of Tsukuba Tsukuba Campus, Tsukuba, Japan

Correspondence: T. Hoshino

Intensive Care Medicine Experimental 2023, **11(Suppl 1)**:000133

Introduction. Acute aortic dissection (AAD) is a life-threatening medical emergency and requires intensive care unit (ICU) admission. It is classified as Stanford type A, requiring emergency surgery, and type B, which is generally managed with conservative medical therapy. Its complications include rupture and malperfusion of the splanchnic organ, spinal cord, and lower extremities. Intestinal ischemia due to impaired blood flow is a well-known intestinal complication requiring emergency surgery. On the other hand, a nonoperative intestinal

complication associated with type B AAD is not less well-known. Several patients experienced intractable constipation during medical treatment, and their ICU stays were extended. Surprisingly, no epidemiological data were recorded regarding the incidence of constipation in patients with type B AAD.

Objectives. This study aimed to determine the prevalence and characteristics of constipation associated with type B AAD.

Methods. A single-center retrospective observational study was conducted in patients admitted to the ICU for conservative treatment of type B AAD. Inclusion criteria were patients discharged from the ICU from January 2011 to August 2022. Type B AAD was diagnosed with computed tomography. We used the following exclusion criteria: (1) impending rupture which were determined by the attending physicians, (2) patients who underwent surgery during their ICU stay, (3) ICU readmission, and (4) missing data about the ICU admission date.

<Definition>Constipation was defined as the absence of stools without obstruction for ≥ 3 but < 6 consecutive days from the ICU admission day [1], paralytic ileus was defined as the absence of stools without obstruction for ≥ 6 consecutive days from the ICU admission day [2,3]. Oxygenation impairment was defined as the need for noninvasive ventilation, high-flow nasal cannula oxygen therapy, or oxygen administration of ≥ 5 L/min.

Results. A total of 75 patients with type B AAD admitted to our ICU for extensive medical therapy were examined. Of these patients, 15 were excluded. Finally, 60 patients were included. The median age and Acute Physiology and Chronic Health Evaluation II score (APACHE II) were 72 (interquartile range [IQR], 60–79) and 10 (IQR 7.3–12.0), respectively. ICU stays were 8 days (IQR 5–12). Moreover, 36 (60%) and 11 (18%) patients had constipation and paralytic ileus, respectively (table 1). Oxygenation impairment was higher in the paralytic ileus group than in constipation and non-constipation group (82%, 36%, and 23%, respectively). The patency rate of the false lumen was higher in the paralytic ileus group than in other groups (64%, 46%, and 33%, respectively). The ICU stay was longer in the paralytic ileus group than in other groups (11, 7, and 5 days, respectively). Therefore, the length of ICU stays increased with the duration between the first defecation day and ICU admission (Fig. 1).

Table 1 (abstract 000133) Characteristics of type B AAD patients

Characteristic	Overall	Paralytic ileus	Constipation	non-constipation
Cases, n	60	11	36	13
Age (median [IQR])	72 [60, 79]	69 [57, 77]	71 [60, 78]	76 [62, 80]
Male, n (%)	43 (72)	10 (92)	22 (61)	11 (85)
Body mass index (median [IQR])	23.8 [22.3, 26.2]	24.8 [23.9, 26.5]	23.2 [22.2, 26.0]	26.2 [23.8, 28.5]
APACHE II (median [IQR])	10 [7, 12]	9 [7, 10]	10 [6, 13]	11 [11, 14]
Diabetes mellitus, n (%)	7 (12)	2 (18)	3 (8)	2 (15)
False lumen patency, n (%)	23 (48)	7 (64)	13 (46)	3 (33)
Dissection of superior mesenteric artery, n (%)	4 (8)	2 (18)	1 (3)	1 (11)

Characteristic	Overall	Paralytic ileus	Constipation	non-constipation
Dissection of Abdominal Aorta, n (%)	42 (75)	7 (64)	25 (74)	10 (91)
Opioid use, n (%)	32 (53)	6 (55)	24 (67)	2 (15)

Conclusions. Constipation and paralytic ileus were prevalent in 60% and 18% of patients with type B AAD, respectively.

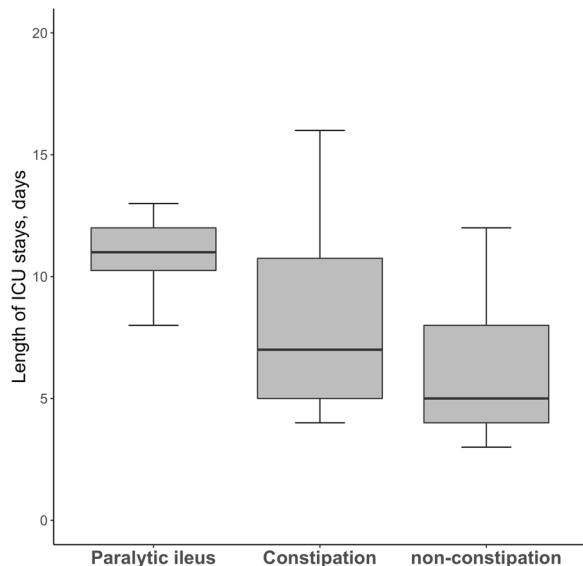

Figure 1 (abstract 000133) Length of ICU stays

References

1. This study was supported by JSPS KAKENHI Grant Number JP22K09177
2. [1] Blaser AR, Malbrain MLNG, Starkopf J, et al. Gastrointestinal function in intensive care patients: Terminology, definitions and management. Recommendations of the ESICM Working Group on Abdominal Problems. *Intensive Care Med.* 2012;38(3):384–394.
3. [2] Fukuda S, Miyauchi T, Fujita M, et al. Risk factors for late defecation and its association with the outcomes of critically ill patients: A retrospective observational study. *J Intensive Care.* 2016;4(1):1–8.
4. [3] Hyoung KP, Kwak C, Byun SS, Lee E, Sang EL. Early removal of nasogastric tube after cystectomy with urinary diversion: Does postoperative ileus risk increase? *Urology.* 2005;65(5):905–908.

Topic: Transfusion and haemostasis disorders.

000134

Higher caloric intake was associated with lower one-year mortality in critically ill medical patients

C. Y. Wang¹, C. H. Wang,² F. H. Wu¹

¹Department of Critical Care Medicine, Taichung Veterans General Hospital, Taichung, Taiwan; ²Graduate Institute of Education, National Changhua University of Education, Changhua Changhua County, Taiwan

Correspondence: C.Y. Wang

Intensive Care Medicine Experimental 2023, **11(Suppl 1)**:000134

Introduction. Previous studies have shown that higher caloric intake can reduce hospital mortality in critically ill patients with high

nutrition risk. However, there is still ongoing debate regarding the optimal amount of caloric intake to improve short-term outcomes. Few studies have focused on the long-term effects of caloric intake in critically ill patients.

Methods. Our retrospective study was conducted at a tertiary medical center, with data collected from January 2015 to December 2019. The study included patients aged over 20 years who required mechanical ventilation in the medical ICU for acute respiratory failure. We excluded patients who had ICU stays lasting less than 48 h.

Results. A total of 3764 patients with an average age of 67.1 years and an APACHE II score of 26.5 were enrolled in our study. Multivariable Cox regression analysis revealed that older age (HR: 1.01, 95% CI: 1.00–1.01), male gender (HR: 1.128, 95% CI: 0.13–0.72), shock requiring more than two vasopressors (HR: 2.19, 95% CI: 1.92–2.50), and positive fluid balance (HR: 1.07, 95% CI: 1.07–1.08) were associated with higher one-year mortality. On the other hand, higher albumin level (HR: 0.82, 95% CI: 0.76–0.88), higher hemoglobin level (HR: 0.88, 95% CI: 0.85–0.91), and higher caloric intake (HR: 0.69, 95% CI: 0.64–0.76) were associated with lower one-year mortality. Additionally, we found that patients older than 65 years, those with an APACHE II score greater than 26, and those with shock requiring more than two vasopressors were more likely to benefit from higher caloric intake.

Conclusions. The results of our study suggest that higher caloric intake might be linked to reduced one-year mortality in critically ill medical patients.

References

1. Wei et al. *Crit Care Med.* 2015 Aug;43(8):1569–79.
2. Needham et al. *BMJ.* 2013 Mar 19;346:f1532.
3. Efthymiou et al. *Clin Nutr.* 2021 Apr;40(4):1546–1554
4. Deane et al. *Am J Respir Crit Care Med.* 2020 Apr 1;201(7):814–822.

Topic: Metabolism, endocrinology, liver failure and nutrition.

000135

The effect of therapeutic hypothermia on ischemic brain injury assessed by 18F-FDG PET in a rat model of cardiac arrest

M. Suh¹, D. Kim¹, Y. Haijeon²

¹Department of Emergency Medicine, The Catholic University of Korea—Songyeui Campus, Seoul, Republic of Korea; ²Department of nuclear medicine, Ewha Womans University Mokdong Hospital, Seoul, Republic of Korea

Correspondence: D. Kim

Intensive Care Medicine Experimental 2023, **11(Suppl 1)**:000135

Introduction. Current guidelines strongly recommend the use of therapeutic hypothermia (TH) in comatose patients after cardiac arrest (CA) to prevent hypoxic-ischemic brain damage. However, there is recent controversy regarding its effectiveness. In this preclinical study, we evaluated the effect of TH on brain glucose metabolism, as measured by fluorine-18-fluorodeoxyglucose (18F-FDG) positron emission tomography (PET) in a rat model of CA.

Methods. CA was induced using vecuronium in Sprague–Dawley rats. 18F-FDG brain PET images were acquired from 21 CA rats, with or without TH intervention, by randomization. Between-group regional and voxel-based analyses of standardized uptake values relative to the pons (SUVrpons) were performed.

Results. Of the 21 CA rats, 9 were treated with TH, whereas 12 were simply observed without TH. The survival rates in the TH and non-TH groups were the same (67%). The SUVrpons of each brain cortical region on the PET scan did not show any difference according to the application of TH intervention. In a subgroup analysis of non-surviving rats, the SUVrpons of most brain cortical regions was significantly higher in the TH than in the non-TH group (FDR-corrected $p < 0.05$).

Conclusions. An improvement in the SUVrpons according to TH intervention was observed only in the cortical regions of the severely injured group that died. The application of TH showed protective effects in brain cortical regions but did not improve survival.

The application of TH to all CAs appears to have limited therapeutic effects.

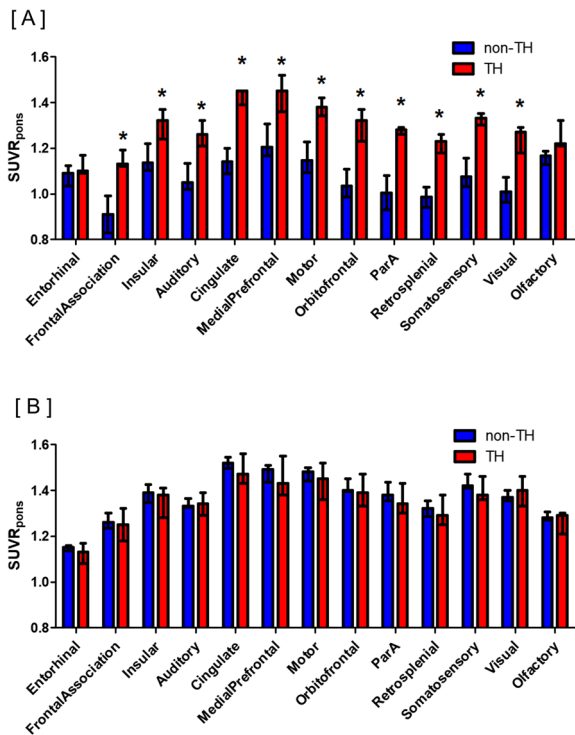

Regional distributions of SUVrpons according to the TH intervention in survived (a) and non-survived (b) subgroups

(a) When the subgroup analysis was performed regarding the 14 survived cardiac arrest (CA) rats, the SUVrpons of each brain cortical region did not show any difference in regional distribution between the TH (n=6, red) and non-TH (n=8) group. Data are presented as medians with interquartile ranges.

(b) When the subgroup analysis was performed regarding the 7 non-surviving cardiac arrest (CA) rats, the TH group (n=3) showed significantly higher SUVrpons than the non-TH group (n=4) in most brain cortical regions (*, $p < 0.05$). Data are presented as medians with interquartile ranges.

Topic: Cardiac arrest.

000136

In aortic stenosis, the ultrasonic B lines and cardiac tissue doppler correlate with left ventricular end-diastolic pressure

Z. Bitar¹, O. Maadarani², H. Dashti³, K. Almerri⁴
¹Critical Care Unit, New Ahmadi hospital KOC-Critical Care Medicine, Ahmadi, Kuwait; ²Critical Care Unit, New Ahmadi Hospital KOC-مستشفى الاحمدي الجديد, Ahmadi, Kuwait; ³Internal Medicine Department, General

Ahmadi Hospital, Ahmadi, Kuwait; ⁴Cardiology Department, Chest Diseases Hospital, الشويخ الصناعية, Kuwait

Correspondence: Z. Bitar

Intensive Care Medicine Experimental 2023, 11(Suppl 1):000136

Introduction. Aortic stenosis (AS) is the most common primary valve lesion requiring intervention in Europe and North America. It has a prolonged subclinical period during which, as AS worsens, left ventricular adaptation becomes inadequate, and impaired systolic and diastolic dysfunction may lead to overt heart failure (HF). The development of heart failure is an inflection point in the natural history of AS. pulmonary congestion is a cardinal feature in heart failure, and lung ultrasound (LUS) evaluation of B-lines has been proposed as a simple, noninvasive tool to assess pulmonary congestion.

Objectives. To assess the correlation of sonographic pulmonary congestion, Invasive LV pre-A pressure, and Echocardiographic estimation of LVEDP in patients with severe AS who are going to valve replacement.

Methods. Forty-eight consecutive patients with severe AS were enrolled and planned for Transcatheter aortic valve implantation (TAVI). All patients underwent comprehensive echocardiography and lung ultrasound (LUS) with the 12 scanning-site assessment. In addition, the patients underwent echocardiography before TAVI. Mitral inflow E/A ratio, E/e', and left atrial volume index were used to estimate LV filling pressure as normal or elevated using the ASE/EACVI algorithm. Invasive LV pre-A pressure was used as a reference, with > 12 mm Hg defined as elevated.

Results. Sixty-two patients were screened from May 21 to October 2022. Fourteen patients were excluded from the initial population (4 patients had concomitant moderate aortic regurgitation, four patients had concomitant moderate or severe mitral regurgitation, four patients had dilated cardiomyopathy with moderate AS, four patients had low-flow, low-gradient AS, three patients had severe chronic obstructive pulmonary disease, and one patient had active lung cancer). Forty-eight patients (25 women (52%), mean age 75 years, standard deviation 7.7 years, maximum 92, minimum 55) were enrolled in the study.

The baseline characteristics of the study population and the comparisons between the different degrees of severity of ultrasound B lines are shown in Table 1.

We found a severe degree of B-lines (≥ 30) in (13) 27% and moderate (15–30) in (33)68.6% of all patients. Furthermore, the number of B-lines increased significantly along with the worsening NYHA functional classes (Fig. 1), from 13 ± 12 in NYHA Class I, through 19 ± 15 in Class II, to 43 ± 34 in Class III ($p < 0.05$, $\rho = 0.383$).

The number of B-lines was correlated (Fig. 2) with LVEF ($R = -0.325$, $p < 0.05$), and E/E' ($R = 0.664$, $p < 0.0001$), LVEDP ($R = 0.448$, $p < 0.001$) and Pro BNP ($R = 0.882$, $p < 0.008$). We did not find a significant correlation between E/A, DT, and LAVI.

The LVEDP correlated well with E/E' ($R = 0.491$, $p < 0.001$). However, we did not find a correlation with E/A, DT, or LAVI.

All patients showed elevated LVEDP > 12, with a mean pressure of 26 mmHg, a minimum of 13 mmHg, and a maximum of 45 mmHg, Std-deviation 7.85428.

Conclusions. Evaluating B-lines is a simple, highly feasible method to detect pulmonary congestion in AS. The number of B-lines correlates with invasive LVEDP measurement, LVEF, E/E', and the functional status of patients. All patients had elevated LVDEP that correlates only with E/E'.

Table (abstract 000136) The clinical characteristics of the patients in relation to ultrasound chest profile

	All	severe degree of B-lines (≥30 in 13)	moderate (15-29) in 33 68.6 %	Mild <15	P
Age	75±7.7	78±4	76±6	72	
Gener (female)(%)	25 (52)				
BMI	27.11 ± 3.8	28.22 ± 3.4	26.99 ± 4.19	25.84±5	0.812
SBP(mmHg)	132.82 ± 12	140.85 ± 11	134.00 ± 14.7	127±80	0.521
DBP (mmHg)	76.66 ± 8	76.71 ± 6	76.71 ± 10.8	66.8	0.977
NYHA1	13 ± 12	0	0	13	
NYHA2	19 ± 15				
NYHA3	43 ± 34				
DM	37	9	27	1	
hypertension	45	12	31	2	
Renal impairment	24	8	15	1	
Hemodialysis (no %)	4	2	2	0	
IHD					
LVEF (mean)(%)	60.23	44.6	43.48	56	0.346
CABG (no)	34	10	22	2	0.56
LVEDP	28.3	30.00	26.46	25.5	0.001
E/E'	20.59	25.53	18.87	12	0.001
DT	228.5	209	221	240	0.168
E/A	1.6	1.5	1.11	0.85	0.293

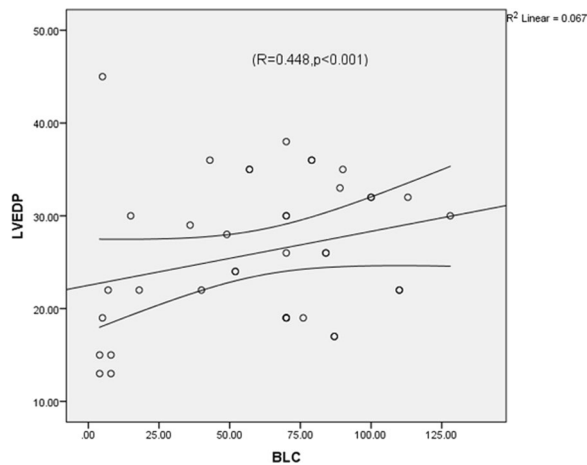

References

1. Bitar, Z., Maadarani, O. & Almerri, K. Sonographic chest B-lines anticipate elevated B-type natriuretic peptide level, irrespective of ejection fraction. *Ann. Intensive Care* 5, 56 (2015).

Topic: Cardiovascular issues in ICU.

000137

Hyper-metabolic pattern of hypothalamus as an early biomarker of brain injury in a rat model of heat stroke

M. Suh¹, D. Kim¹, Y. Hajjeon²

¹Department of emergency medicine, The Catholic University of Korea—Songjeu Campus, Seoul, Republic of Korea; ²Department of nuclear medicine, Ewha Womans University Mokdong Hospital, Seoul, Republic of Korea

Correspondence: Y. Hajjeon

Intensive Care Medicine Experimental 2023, **11(Suppl 1)**:000137

Introduction. Heat stroke (HS) is the most serious heat-related illness and recognized as a worldwide public concern as global temperature rise. Although the neurologic complications of HS are relatively well described clinically, there are limited number of studies regarding imaging findings. In this preclinical study, we aimed to identify the imaging findings of 18F-FDG brain PET in HS, and furthermore, to elucidate the utility of FDG PET in the evaluation of HS-induced brain injury.

Methods. HS was induced by placing Sprague Dawley rats in a hot and humid chamber maintained without food and water until meeting the diagnostic criterion of HS onset. 18F-FDG brain PET images were acquired in 7 controls and 14 HS rats three hours after the end of induction. Between group region-based (standardized uptake value normalized to the whole brain, SUVWB) and voxel-based analyses were performed.

Results. Of the 14 HS rats, 6 were non-survived, while 8 were survived. Non-survived rats showed significantly higher SUVRHB in hypothalamus and significantly lower SUVRHB in several cortical regions than controls by both of region-based and voxel-base analysis. Survived rats showed significant increase or decrease of SUVRHB compared to controls in a few cortical regions as a result of region-based analysis, but no difference was observed in voxel-based analysis.

Conclusions. The 3 h post-injury PET scan showed a distinctly different regional distribution of 18F-FDG in the brains of lethally injured HS rats compared to controls. 18F-FDG brain PET may have potential to provide early indicators of catastrophic injury as well as to reflect early neurological pathophysiology of HS.

Topic: Neurointensive care.

000139

Thrombotic and bleeding events in patients with severe COVID-19: a Japanese single center retrospective study

D. Fujita¹, A. Tsuruoka¹, R. Kuzumi¹, K. Shigemitsu¹, T. Yamashita¹, H. Rinka¹
¹Emergency and Critical Care Medical Center, Osaka City General Hospital, Osaka, Japan

Correspondence: D. Fujita

Intensive Care Medicine Experimental 2023, **11(Suppl 1)**:000139

Introduction. In patients with COVID-19, the risk of thrombotic complications following coagulopathy are higher. As thrombotic complications can be fatal, anticoagulation therapy is recommended in moderate-to-severe patients. It has been reported that Asians have a different incidence of thrombotic and bleeding complications than Caucasians, but only limited data are available.

Objectives. This study aimed to analyze the frequency and details of thrombotic complications, as well as those of bleeding complications during anticoagulation therapy, factors associated with major bleeding, and their association with prognosis among patients with severe COVID-19.

Methods. This single center, retrospective observational study included patients with severe COVID-19 admitted to our ICU from February 2022 to January 2023. The data was collected from medical records and statistically analyzed.

Results. In total, 357 patients, comprising 281 (78.7%) males, were included; their median age was 68 years. Of them, 310 patients (86.8%) received mechanical ventilation, 27 (7.5%) received kidney replacement therapy, and 17 (4.7%) received ECMO. ICU mortality rate was 24.2% for patients receiving mechanical ventilation, excluding ECMO cases. In contrast, it was 35.2% for patients who received ECMO and 51.8% for patients who received kidney replacement therapy. Thrombotic complications were observed in 22 patients (6.1%), and further details are presented in Fig. 1. Bleeding complications were observed in 113 patients (31.8%) treated with unfractionated heparin (UFH) while monitoring APTT three times a day,

and further details are provided in Fig. 2. Patients receiving UFH were divided into two groups based on their treatment doses: prophylactic doses (PD group) and therapeutic doses (TD group). The TD group had significantly more major bleeding events (as defined by the ISTH criteria) than the PD group ($p < 0.01$). The use of unfractionated heparin exceeding 300 units/kg/day resulted in a significant increase in bleeding complications ($p < 0.01$). Age (odds ratio 1.07, 95%CI 1.03–1.12, $p < 0.01$), UFH treatment dose (odds ratio 3.95, 95%CI 1.1–14.1, $p < 0.01$), CKRT (odds ratio 11.3, 95%CI 2.61–48.9, $p < 0.01$), and ECMO (odds ratio 30.8, 95%CI 4.47–213, $p < 0.01$) were significantly associated with major bleeding events. However, neither the occurrence of thrombotic nor bleeding complications was associated with the 28-day prognosis in this study (Logrank $p = 9.93$ and 5.03, respectively).

Conclusions. In the Asian population of the study, the frequency of bleeding complications associated with anticoagulation therapy was found to be higher than the frequency of thrombotic complications. This can result in increased costs of medical care, including the need for transfusions and hemostasis. Therefore, anticoagulation therapy with lower bleeding risk and more appropriate monitoring, such as thromboelastography is necessary, particularly for Asians.

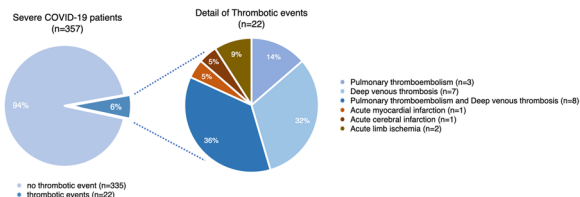

Figure 1 (abstract 000139) Description of Thrombotic events

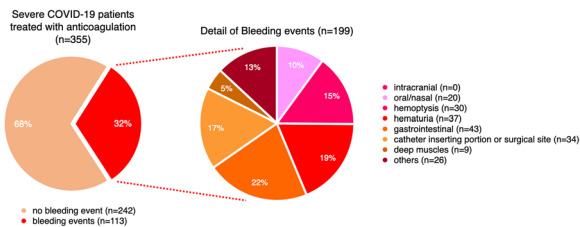

Figure 1 (abstract 000139) Description of Bleeding events

Factors related to major Bleeding

	Odds ratio	95% C.I.	P value
Age	1.07	1.03 - 1.12	<0.01
Sex	1.15	0.45 - 2.89	0.76
BMI	1.09	0.98 - 1.20	0.093
CKD	0.57	0.19 - 1.72	0.32
AKI	1.43	0.60 - 3.40	0.41
UFH TD	3.95	1.10 - 14.10	<0.05
CKRT	11.30	2.61 - 48.90	<0.01
ECMO	30.80	4.47 - 213.00	<0.01

Logistic regression

References

1. Thromb Haemost. 2014;111:789–797
2. Acute Med Surg. 2021 Jul 12;8(1):e664.
3. J Thromb Haemost. 2020 Aug;18(8):1859–1865.
4. None

Topic: Infections and prevention.

000140

Vascular tone is heterogeneous in nascent septic shock despite a standardised faecal peritonitis model

F. Catling¹, B. Garcia², F. Su², S. Harris³, A. Herpain², A. Gordon¹

¹Division of Anaesthetics, Pain Medicine and Intensive Care, Imperial College London, London, United Kingdom; ²Experimental Laboratory of Intensive Care, Université Libre de Bruxelles, Brussels, Belgium; ³Institute of Health Informatics, University College London, London, United Kingdom

Correspondence: F. Catling

Intensive Care Medicine Experimental 2023, 11(Suppl 1):000140

Introduction. Universal resuscitation strategies have proved ineffective in septic shock [1,2], leading many to highlight patient heterogeneity and call for personalised treatment. Much heterogeneity in sepsis is obvious—patients have varied demographics, medical history, foci of infection and delays in hospital presentation—yet subgroup analyses controlling for these factors have yielded few promising signals [1,2]. Is there other, latent, heterogeneity in cohorts with nascent septic shock, which might guide individualised resuscitation?

Objectives. We report cardiovascular changes during sepsis-induced hypotension in an ostensibly homogenous cohort: a standardised, high-fidelity porcine model of faecal peritonitis.

Methods. Experiments in pigs were conducted under general anaesthesia, following EU regulations and ethical approval. Data from 64 animals were combined from several completed [3–5] and ongoing studies from a single site, which used the same protocol for all periods of the experiment described here. Continuous arterial pressure and cardiac output were monitored via aortic, femoral, radial and pulmonary artery catheters. Animals received protocolised titration of maintenance IV fluids and sedation prior to intraperitoneal instillation of 3 g/kg of autologous faeces (“insult”). Cardiovascular parameters are reported at baseline (median values 15–30 min prior to insult) and at sepsis-induced hypotension (post-insult sustained mean arterial pressure < 50 mmHg). Between these timepoints, IV fluids were reduced to 1 ml/kg/hour and no vasoactive drugs were administered.

Results. Sepsis-induced hypotension occurred a median of 5.6 (IQR 4.6, 7.1) hours after insult. Large decreases in stroke volume and large increases in heart rate and pulse pressure variation were almost universal. Cohort-level summary statistics (see table) masked large, but heterogeneous, per-animal changes from baseline vascular tone (see figure). Surprisingly, but in keeping with hypovolaemia and increased sympathetic activity, systemic vascular resistance (SVR) increased in 39/49 (80%) animals, suggesting early vasoplegia in the remaining 10/49 (20%). Aortofemoral pulse transit time (PTT) shortened in 34/58 (59%). Changes in SVR and PTT were only weakly correlated (Spearman’s rho – 0.26), suggesting that PTT shortening primarily reflects increased large-artery stiffness rather than decreased radius. Peripheral systolic amplification decreased in 57/58 (98%), showing that vasodilated extremities may be an unreliable indicator of total SVR [4].

Table (abstract 000140) Cohort-level parameters at baseline and sepsis-induced hypotension

Variable	n (%)	Baseline: median (IQR)	Hypotension: median (IQR)
Mean arterial pressure (mmHg)	64 (100)	69 (63, 75)	48 (47, 49)
Heart rate (BPM)	64 (100)	86 (75, 105)	151 (136, 163)
Stroke volume (ml)	49 (76)	54 (47, 60)	18 (15, 23)
Pulse pressure variation (%)	62 (96)	10 (8, 12)	32 (24, 39)
Systemic vascular resistance (dyn s cm ⁻⁵)	49 (76)	1100 (961, 1484)	1258 (1081, 1695)

Variable	n (%)	Baseline: median (IQR)	Hypotension: median (IQR)
Pulse transit time (ms)	58 (90)	84 (72, 90)	80 (69, 90)
Femoral systolic— aortic systolic pressure (mmHg)	58 (90)	9 (7, 12)	− 3 (− 7, − 1)

Conclusions. We report heterogeneous vascular responses to nascent septic shock in an ostensibly homogenous cohort, where factors typically used for subgroup analysis in sepsis trials are standardised. Our results reinforce the need for early fluid resuscitation in faecal peritonitis but motivate investigation of personalised approaches to early vasopressor therapy. In particular, early vasopressors may be more likely to benefit patients with early vasoplegia and those without significant large-artery stiffening, as this latter group is less likely to experience harmful elevations in afterload [6].

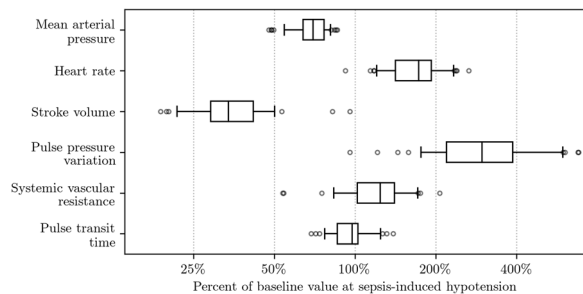

Per-animal changes from baseline to sepsis-induced hypotension. ‘Whiskers’ indicate the 5th and 95th data percentiles.

References

- Carrara M, Herpain A, Ferrario M. Tachycardia control in septic shock with esmolol and ivabradine: a comparison on heart function. In: 2020 42nd Annual International Conference of the IEEE Engineering in Medicine & Biology Society (EMBC). 2020. 2756–9.
- Carrara M, Herpain A, Baselli G, et al. Vascular Decoupling in Septic Shock: The Combined Role of Autonomic Nervous System, Arterial Stiffness, and Peripheral Vascular Tone. *Front Physiol* 2020;11:594.
- Garcia B, Su F, Dewachter L, et al. Myocardial effects of angiotensin II compared to norepinephrine in an animal model of septic shock. *Crit Care* 2022;26:281.
- Guarracino F, Ferro B, Morelli A, et al. Ventriculoarterial decoupling in human septic shock. *Crit Care* 2014;18:R80.
- FJRC: Wellcome Trust Clinical PhD Fellowship (222882/Z/21/Z)
- FJRC and ACG: NIHR Imperial Biomedical Research Centre
- BG: Année recherche, relations internationales, UFR3S, Université de Lille, France
- SH: NIHR University College London Hospitals Biomedical Research Centre, and University College London Collaborative Healthcare Innovation through Mathematics, EngineerRing and AI (UCL CHIMERA, EPSRC award EP/T017791/1)
- AH: Fonds Erasme pour la Recherche Médicale
- ACG: NIHR (RP-2015–06-018)
- PRISM Investigators, Rowan KM, Angus DC, et al. Early, Goal-Directed Therapy for Septic Shock—A Patient-Level Meta-Analysis. *N Engl J Med* 2017;376:2223–34.
- Early Restrictive or Liberal Fluid Management for Sepsis-Induced Hypotension. *N Engl J Med* Published Online First: 21 January 2023. <https://doi.org/10.1056/NEJMoa2212663>

Topic: Sepsis

000141

Relationship between perceived stress, health literacy, and family satisfaction among relatives of critically ill patients: a multicenter exploratory study

C. Padilla-Fortunatti¹, N. Rojas¹, C. Bustamante,¹ C. Toledo,² M. Abaitua², J. Espinoza,³ C. Villegas,³ V. Ovalle,⁴ I. Lama,⁴ B. Cifuentes,¹ C. Contreras,³ C. Honores,⁵ Y. Palmeiro,⁶

¹School of Nursing, Campus San Joaquín, Pontificia Universidad Católica de Chile, Macul, Chile; ²Adult Intensive Care Unit, Florida Hospital Dra. Eloísa Díaz, La Florida, Chile; ³Adult Intensive Care Unit, Clínica Alemana Osorno, Osorno, Chile; ⁴Adult Intensive Care Unit, Hospital San Pablo, Coquimbo, Chile; ⁵School of Nursing, Universidad Santo Tomás, La Serena, Chile; ⁶School of Nursing, Universidad de los Andes, Santiago, Chile

Correspondence: C. Padilla-Fortunatti

Intensive Care Medicine Experimental 2023, **11(Suppl 1)**:000141

Introduction. Admission to an intensive care unit (ICU) is often a stressful experience that can negatively influence relatives’ evaluation of their satisfaction with the ICU experience (1,2). Within the factors influencing family satisfaction, relatives’ educational level has reported contradictory results (3). As a related concept, health literacy is described in terms of the subjects’ ability to obtain, process, and understand health-related information to perform adequate decision-making regarding their health (4). Health literacy may influence key family satisfaction attributes such as satisfaction with care, communication, or decision-making but to date, few studies have explored health literacy among ICU relatives, particularly its role in family satisfaction levels.

Objectives. To examine the influence of perceived stress and health literacy on family satisfaction levels among relatives of ICU patients.

Methods. An exploratory, cross-sectional, multicenter study was conducted in 3 hospitals, one in the northern, central, and southern regions of Chile respectively. Relatives of ICU patients with >48 h of stay and with respiratory support were approached. The Family Satisfaction in the Intensive Care Unit -24 (5) questionnaire and the perceived stress scale-10 (6) were utilized. Health literacy was evaluated using 3 brief screening questions (7). Sociodemographic, communication with ICU staff, and clinical data were also collected. The relationship between family satisfaction and perceived stress, health literacy, and potential variables was guided by bivariate analyses and theory. Then, the association between selected predictors and family satisfaction was studied using a multivariate beta regression (8).

Results. A total of 101 relatives were included with 75.2% being female and a mean age of 47.3 years (SD=14.5). 63.4% of the relatives were classified as having low health literacy. Mean perceived stress and family satisfaction levels were 16.1 (SD=6.2) and 79.6 (SD=17.8) respectively. Multivariate beta regression showed that low health literacy was not statistically associated with family satisfaction (exp B; 95% confidence interval; *p*-value, 1.17 [0.78–1.75], *p*=0.45). But, family satisfaction was negatively associated with the relative’s perceived stress levels (0.97 [0.94–0.99], *p*=0.04), belonging to the central region center (0.26 [0.14–0.49], *p*<0.01), southern center (0.28 [0.1–0.50], *p*<0.01), having a close person related to healthcare (0.52 [0.34–0.77], *p*<0.01). Finally, the number of communications with ICU staff was positively associated with family satisfaction (1.01 [1.00–1.03], *p*<0.05).

Conclusions. While perceived stress can be detrimental to family satisfaction, health literacy status seems not to impact family satisfaction among relatives of ICU patients. Further studies are required to confirm the influence of relatives’ health literacy and the identified factors on their evaluation of the quality of their ICU stay.

References

- Herridge MS, Azoulay É. Outcomes after Critical Illness. *N Engl J Med*. 2023;388(10):913–924. <https://doi.org/10.1056/NEJMra2104669>
- Padilla-Fortunatti C, Munro CL, Gattamorta K. Psychological distress, social support, and family satisfaction among family members of non-COVID-19 critical care patients: A cross-sectional study. *J Nurs Scholarsh*. 2023;55(1):33–44. <https://doi.org/10.1111/jnu.12812>
- Padilla Fortunatti

C, Munro CL. Factors associated with family satisfaction in the adult intensive care unit: A literature review. *Aust Crit Care*. 2022;35(5):604–611. <https://doi.org/10.1016/j.aucc.2021.07.006> 4. Riley JB, Cloonan P, Norton C. Low health literacy: a challenge to critical care. *Crit Care Nurs Q*. 2006;29(2):174–178. <https://doi.org/10.1097/00002727-200604000-00011> 5. Padilla-Fortunatti C, Rojas-Silva N, Molina-Muñoz Y, Avendaño-Jara S. Cultural adaptation and psychometric properties of the Chilean-Spanish version of the Family Satisfaction in the Intensive Care Unit—24 questionnaire. *Med Intensiva (Engl Ed)*. 2023;47(3):140–148. <https://doi.org/10.1016/j.medine.2022.07.019> 6. Tapia D, Cruz C, Gallardo I, Dasso M. Adaptación de la Escala de Percepción Global de Estrés- (EPGE) en estudiantes adultos de escasos recursos en Santiago, Chile. *Rev Adm Sanit*. 2007;1:109–119. 7. Chew LD, Bradley KA, Boyko EJ. Brief questions to identify patients with inadequate health literacy. *Fam Med*. 2004;36(8):588–594. 8. Ferrari S, Cribari-Neto F. Beta Regression for Modelling Rates and Proportions. *J. Appl. Stat.* 2004;31:799–815. <https://doi.org/10.1080/0266476042000214501>

- This study was conducted with financial support from the Research and Doctorate Directorate of the School of Nursing of the Pontificia Universidad Católica de Chile.

Topic: Nursing care and physiotherapy.

000144

Results of a bedside ultrasound in the first 24 h at admission in our Cardiac Intensive Care Unit

O. Moreno Romero¹, G. J. M. Giménez², J. Pelaez Velez¹, M. T. Cruces Moreno³

¹Intensive Care Unit, Hospital Universitario Clínico San Cecilio, Granada, Spain; ²UCI, Hospital Universitario Clínico San Cecilio, Granada, Spain;

³Intensive care unit, Hospital Universitario San Cecilio, Granada, Spain

Correspondence: O. Moreno Romero

Intensive Care Medicine Experimental 2023, **11(Suppl 1)**:000144

Introduction. The evidence of bedside ultrasound performed by intensive care physicians in the management of critically ill patients has been growing in the past two–three decades, specially, in cardiologic patients in whom the use of early ultrasound and specially echocardiography, might guide or even change the actual treatment.

Objectives. First, to describe the characteristics of the acute patients admitted to our intensive care cardiologic unit in a 24-month study. Second, to describe whether the diagnosis and/or treatment at admission was modified after performing the screening bedside ultrasound in the first 24 h by our intensive care physicians.

Methods. Retrospective study of all acute patients admitted to our intensive care cardiologic unit in a 24-month period (January 2021 to January 2023) in whom an US in the first 24 h was performed (including transthoracic echocardiography, IVC ± pulmonary US). Variables analyzed: mean age, sex; diagnosis at admission (percentage): STEMI, NSTEMI, peri/myocarditis, clinical heart failure/cardiogenic shock, cardiorespiratory arrest, suspicious endocarditis, intermediate-high or high risk acute pulmonary embolism (PE) and other. Percentage of change in the diagnosis and/or treatment after performing de US.

Results. 1255 acute patients were admitted, a median of 1.8 incomes/day. Mean age 57y (14–93), 72% male. Diagnosis at admission: STEMI 329 (26.2%); NSTEMI 465 (37%); peri/myocarditis 108 (8.6%); heart failure/cardiogenic shock 92 (7.3%); cardiorespiratory arrest 58 (4.6%); suspicious infectious endocarditis IE 43 (3.4%); intermediate-high or high-risk PE 24 (1.9%) and 31 (2.5%) patients with other diagnosis. In 31% of US performed the treatment was significantly changed in the first 24 h: 68 (5.4%) emergent catheterism but not primary PCI; 8 (0.6%) urgent cardiac surgery; 4 (0.3%) urgent TAVI/valvuloplasty; 255 (20%) election/initiation of vasoactive drug; 165 (13%) guidance of liquid/diuretic treatment; 15 (1.19%) emergent pleural/pericardic drainage; 32 (2.5%) suspension of double antiaggregation; 7 (0.55%) systemic trombolisis or mechanical trombectomy. Percentage change diagnosis after US was very low: in STEMI variation 1.6% (308 finally) mostly due to LHBB; in NSTEMI variation 2.5% (432 finally).

Conclusions. In our study the treatment was guided or significantly changed after the first 24 h US in 31% of patients, but for change in

the diagnosis other complementary test need to be performed to asses final diagnosis (troponin, transesofagous echocardiography, catheterism...).

Topic: Cardiovascular issues in ICU.

000145

Percutaneous tracheostomy performed by intensive care residents guided with fiberoptic bronchoscopy in our ICU

O. Moreno Romero¹, G. J. M. Giménez², A. Martínez Cabezas¹, P. Fernández Morales²

¹Intensive care unit, Hospital Universitario Clínico San Cecilio, Granada, Spain; ²UCI, Hospital Universitario Clínico San Cecilio, Granada, Spain

Correspondence: O. Moreno Romero

Intensive Care Medicine Experimental 2023, **11(Suppl 1)**:000145

Introduction. Percutaneous tracheostomy is an essential procedure for weaning in patients with prolonged mechanical ventilation or difficulty in weaning due to miscellaneous etiologies in our intensive care units.

Objectives. First, to describe the characteristics of all percutaneous tracheostomies performed in our ICU. Second, to analyze the complications of the technic compared with those performed by intensive care fellow physicians in the same unit.

Methods. A retrospective 24 month-study (2020 and 2021) of all patients admitted to our ICU who needed a percutaneous tracheostomy for weaning from mechanical ventilation. All tracheostomies were performed by two intensive care physicians (a resident and a fellow) and one nurse. We compared the tracheostomies performed by residents versus the ones carried out by fellows (as first intervener). Variables analyzed in both groups: patient data (sex, age, SAPS II), use of fiberoptic bronchoscopy (FOB) and complications.

Results. In 24 months we performed 82 tracheostomies, 57 by residents, 25 by fellows. Men 55 (67%), mean age 60,2 years (32–78). SAPS II of 52 (29–75). 65 patients where COVID 19 pneumonia. Mean day of tracheostomy 11 (6–16) in COVID, 14.3 (10–17) in non-COVID. FOB: 28 in the group of residents (49%), 3 in the group of fellows (12%). Complications in both groups were alike: none severe haemorrhage was found; mild haemorrhage, 10 (17.5%) by residents vs 4 (16%) by fellows; mild granuloma: 2 (3.5%) by residents vs 1 (1.8%) by fellows; mild wound infection: 2 (3.5%) by residents vs 1 (4%) by fellows. None fatal complication was found.

Conclusions. Percutaneous tracheostomy is an essential procedure in our daily practice and the use of FOB to support the correct needle tracheal insert ensures security when it is performed by our internal intensive care residents, as the complications comparing with the fellow physicians with less use of FOB have been alike.

Topic: Acute respiratory failure and mechanical ventilation.

000146

A machine learning model for predicting short-term outcomes after rapid response system activation

T. Naito¹, M. Li², S. Fujitani¹

¹Department of Emergency and Critical Care Medicine, St. Marianna University School of Medicine, Kawasaki, Japan; ²Enterprise Analytics, Thomas Jefferson University Hospital, Philadelphia, United States of America

Correspondence: T. Naito

Intensive Care Medicine Experimental 2023, **11(Suppl 1)**:000146

Introduction. Maintaining rapid response team (RRT)/ medical emergency team (MET) response quality is difficult. A system that supports RRT assessment could potentially contribute to medical safety. Although rapid response system (RRS) triggers have been well-studied, studies on the prediction models of short-term prognosis after RRS activation are scarce.

Objectives. We aimed to develop a model to predict short-term outcomes after RRS activation using machine learning.

Methods. This retrospective cohort study used the In-Hospital Emergency Registry in Japan, a multicentre RRS online registry. We collected

data on patient demographics, treatment before RRS, RRT/MET calls, and physiological parameters. The outcome was death within 24 h after RRS calls or unplanned transfers to an intensive care unit. To develop the eXtreme Gradient Boosted Tree Classifier (XGB) and Random Forest (RF) algorithms, a logistic regression (LR) algorithm was used. For model comparison, receiver operating Area under the curve (AUC) was evaluated and compared with those of the National Early Warning Score (NEWS) and Modified Early Warning Score (MEWS).

Results. Overall, 5414 cases were included in the study. The outcome occurred in 28.4% of the cases. The XGB model showed the highest AUC (0.798) compared to the RF model (0.796), LR model (0.785), NEWS (0.696), and MEWS (0.660). The most weighted feature in the XGB model was doctor activation, followed by hypotension as the activation criteria and usage of oxygen.

Conclusions. We developed the first machine learning model for short-term prognosis after RRS. The new prediction model could prevent patients from inadequate evaluation and treatment during RRS.

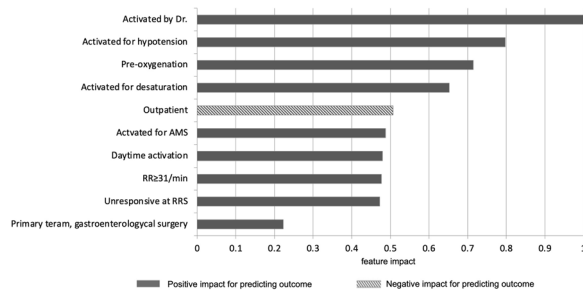

Figure 1 (abstract 000146) Feature impact for the eXtreme Gradient Boosted Tree Classifier model, top 10 features

References

1. JSPS KAKENHI (grant number JP18K16548)
2. Subbe CP, Bannard-Smith J, Bunch J, et al. Quality metrics for the evaluation of Rapid Response Systems: Proceedings from the third international consensus conference on Rapid Response Systems. Resuscitation 2019;141:1–12.
3. Kia A, Timsina P, Joshi HN, et al. MEWS+ ++: Enhancing the Prediction of Clinical Deterioration in Admitted Patients through a Machine Learning Model. J Clin Med Res 2020;9.
4. Lee YJ, Cho K-J, Kwon O, et al. A multicentre validation study of the deep learning-based early warning score for predicting in-hospital cardiac arrest in patients admitted to general wards. Resuscitation Ireland 2021;163:78–85.
5. Churpek MM, Yuen TC, Winslow C, Meltzer DO, Kattan MW, Edelson DP. Multicenter Comparison of Machine Learning Methods and Conventional Regression for Predicting Clinical Deterioration on the Wards. Crit Care Med 2016;44:368–74.
6. Chen J, Ou L, Hillman K, et al. The impact of implementing a rapid response system: a comparison of cardiopulmonary arrests and mortality among four teaching hospitals in Australia. Resuscitation 2014;85:1275–81
7. Naito T, Hayashi K, Hsu H-C, et al. Validation of National Early Warning Score for predicting 30-day mortality after rapid response system activation in Japan. Acute Med Surg 2021;8:e666.

Topic: Data Science.

000147

The optimal control of veno-arterial extracorporeal membrane oxygenation and Impella (ECPELLA) considering oxygen delivery in severe cardiogenic shock: a Simulation Study

H. Matsushita¹, T. Nishikawa², S. Yokota¹, H. Morita¹, M. Fukumitsu¹, A. Nishiura¹, Y. Yoshida¹, K. Uemura¹, T. Kawada¹, M. Li¹, K. Saku¹
¹Department of Cardiovascular Dynamics, National Cerebral and Cardiovascular Center, Suita, Japan; ²Department of Research

Promotion and Management, National Cerebral and Cardiovascular Center, Suita, Japan

Correspondence: H. Matsushita

Intensive Care Medicine Experimental 2023, 11(Suppl 1):000147

Introduction. The combination therapy of veno-arterial extracorporeal membrane oxygenation (VA-ECMO) and Impella, ECPELLA, is a powerful option for saving patients with cardiogenic shock. However, in severely compromised hemodynamics, the appropriate control of ECPELLA may vary among patients. Therefore, there is a great need in the field for the development of tools to derive optimal ECPELLA control.

Objectives. In this study, we established a mathematical hemodynamic simulator and evaluated the effects of ECPELLA on total systemic flow (F total) and oxygen delivery (DO₂) in a cardiogenic shock hemodynamics.

Methods. We used Simulink® (Mathworks, Inc.) for cardiovascular simulation using a 5-element resistance–capacitance network with four ventricles represented by time-varying elastance and unidirectional valves (Fig. 1). We compared F total and DO₂ in mild right ventricular dysfunction (RV end-systolic elastance (Ees): 0.4 mmHg/mL) and various left ventricular (LV) dysfunction (LV-Ees: 0.2 mmHg/mL), and VA-ECMO (0–5 L/min) and Impella flows (0–5.5 L/min), pulmonary oxygenation (SpvO₂: 40–80%). DO₂ was calculated by the following formula; $DO_2 = 1.34 \times 10^{-4} \times [Hb] \times (CO \text{ or } ECMO \text{ or } Impella \text{ flow})$.

Results. As shown in Figs. 2 and 3, both VA-ECMO and Impella significantly increased F total, and the addition of Impella further increased F total in cases of severe LV dysfunction. VA-ECMO significantly increased DO₂ (from 171 to 1,005 mL/min), and the addition of ImpellaCP further augmented DO₂ (from 1,005 to 1,168 mL/min) in cases of severe LV dysfunction with lower pulmonary oxygenation. As DO₂ is closely linked to F total, VV-ECMO (with SpvO₂ at 80%) with Impella had limited DO₂ elevation compared to ECPELLA.

Conclusions. ECPELLA significantly improved the oxygen delivery as well as total systemic flow. Through cardiovascular simulation of complex hemodynamics, the optimal control of ECPELLA can be visualized, taking into consideration oxygen delivery.

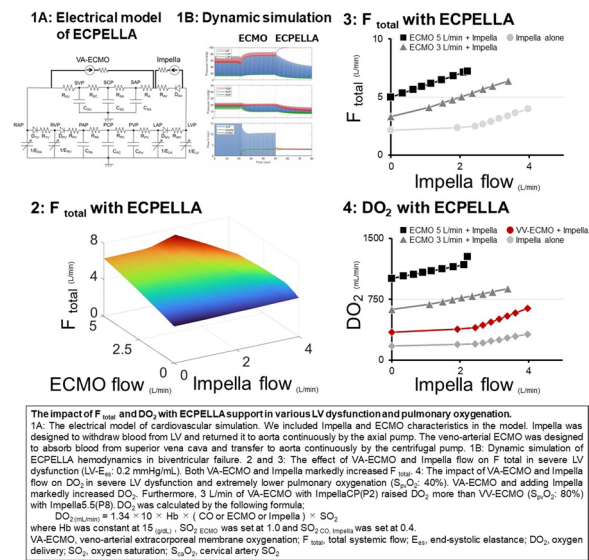

Figures 1 to 4 (abstract 000147)

Topic: Cardiovascular issues in ICU.

000152

“A prospective observational study comparing the effect of endotracheal tube with subglottic suction port (ETT SS) Vs standard endotracheal tube (ETT C) on incidence of ventilator associated pneumonia (VAP) in patients admitted to intensive care unit”

S. Ganeshbabu¹, S. Kandasamy²

¹Adult Intensive Care Unit, The Madras Medical Mission Hospital, Chennai, India; ²Surgical intensive care unit, CHRISTIAN MEDICAL COLLEGE, Vellore, India

Correspondence: S. Ganeshbabu

Intensive Care Medicine Experimental 2023, 11(Suppl 1):000152

Introduction. One of the postulated causes of ventilator associated pneumonia (VAP) is micro-aspiration of subglottic secretions, which pool in the laryngopharynx above the cuff of endotracheal tube. Standard endotracheal tubes (ETT C) do not have an option to remove these secretions. But, newer endotracheal tubes with a dedicated suction port just above the cuff (ETT SS), has facility to remove subglottic secretions.

While some previously studies did not show a definitive benefit, some did show benefits, with ETT SS use in VAP reduction. In our study we hypothesized the use of ETT SS will decrease the incidence of VAP.

Objectives. A Prospective Observational Study Comparing “the effect of endotracheal tube with subglottic suction port (ett ss) vs standard endotracheal tube (ett c) on incidence of ventilator associated pneumonia(vap)” in Patients Admitted To Intensive Care Unit.

Methods. Adult patients admitted to intensive care unit (ICU) with duration of ventilation more than 48 h were included in this study. The type of ET tube used for intubation was noted along with other variables like Patient details, diagnosis, pre-existing illness, APACHE II score (score based on severity of illness and any other long standing illness), number of days on ventilator, number of days of ICU & hospital stay and hospital mortality. Patients with fever, purulent respiratory secretions, increased or decreased White cell count, were screened for microorganisms from ET secretions. Surveillance for Ventilator Associated Pneumonia in this study was in accordance with the “Surveillance for ventilator-associated events in the National Healthcare Safety Network (NHSN)” guidelines released by CDC-Centers for Disease control and Prevention in Jan 2014.

Results. In total 160 patients were enrolled in the study, 80 in ETT SS group and 80 in ETT C group. The two groups were comparable in terms of age, presence of co morbid illnesses and APACHE II score. The incidence of VAP in our ICU was 4.76 per 1000 ventilator days.

Ventilator associated events	Nil	VAC	IVAC	Possible VAP	Probable VAP	Total
ETT SS	73	4	1	0	1	79
	92.41	5.06	1.27	0.00	1.27	100.00
ETT C	72	1	4	2	2	81
	88.89	1.23	4.94	2.47	2.47	100.00
TOTAL	145	5	5	2	3	160
	90.63	3.13	3.13	1.25	1.88	100.00

The incidence of VAP was lower in ETT SS (0.76%) compared with ETT C group (2.57%) which was statistically significant. The overall incidence of VAE- Ventilator associated events (VAC + IVAC + POSSIBLE VAP + PROBABLE VAP) when both groups combined was 14.27 per 1000 ventilator days. The incidence of Ventilator Associated Events

VAEs between the two groups were (18.4%) in ETT SS patients and 6 (10.68%) in ETT C. The mean duration of hospital stay were in ETT SS 16.01 ± 11.06 days and in ETT C 12.83 ± 9.39 days, The duration of mechanical ventilation were in ETT SS 8.16 ± 7.76 days and in ETT C 6.53 ± 10.89 days and the mean length of ICU stay were in ETT SS 9.20 ± 6.72 days and in ETT C 7.73 ± 0.82 days. The hospital mortality were in ETT SS group (39.24%) and in ETT C group (30.86%).

Conclusions. The incidence of VAP-ventilator associated pneumonia showed a significant reduction with the use of ETT SS-Endotracheal tube with subglottic suction drainage in comparison with standard endotracheal tube ETT C.

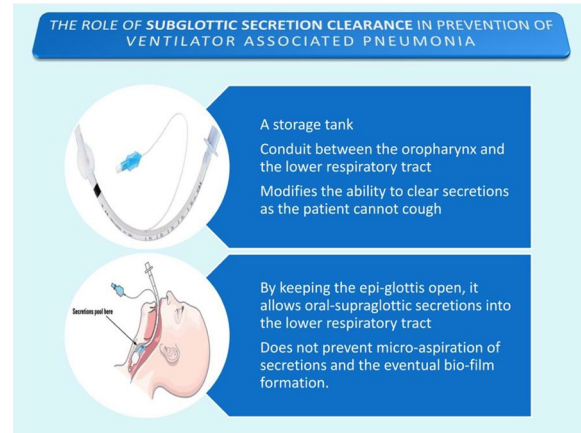

Figure 1 (abstract 000152) Micro aspiration of oral secretions in conventional endo tracheal tube

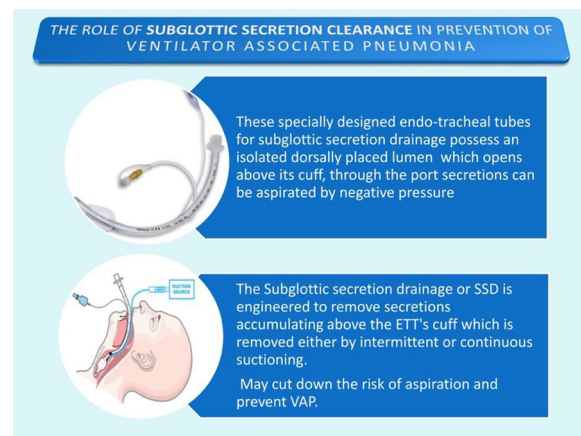

Figure 2 (abstract 000152) ETT with subglottic suction port enables subglottic drainage of secretions reducing the load of micro aspiration

References

1. CDC—ACH Surveillance for VAP Event—NHSN [Internet]. [cited 2014 Aug 22]. Available from: <http://www.cdc.gov/nhsn/acute-care-hospital/vap/>
2. IRB Min/Not 8999 FOBSERVEL dated 04.08.2014 Office of Reasearch Institutional Review board IRB CHRISTIAN MEDICAL COLLEGE VELLRE INDIA

- Bansode BR. Ventilator-Associated Pneumonia (VAP). [cited 2014 Sep 18]; Available from: http://apiindia.org/pdf/medicine_update_2011/72_ventilator_associated_pneumonia.pdf
- Mietto C, Pinciroli R, Patel N, Berra L. Ventilator associated pneumonia: evolving definitions and preventive strategies. *Respir Care*. 2013;58(6):990–1007.
- Melsen WG, Rovers MM, Groenwold RH, Bergmans DC, Camus C, Bauer TT, et al. Attributable mortality of ventilator-associated pneumonia: a meta-analysis of individual patient data from randomised prevention studies. *Lancet Infect Dis*. 2013 Aug;13(8):665–71
- Ventilator Associated Pneumonia – an Overview | British Journal of Medical Practitioners [Internet]. [cited 2014 Sep 14]. Available from: <http://www.bjmp.org/content/ventilator-associated-pneumonia-overview>
- National Guideline Clearinghouse | Prevention of ventilator-associated pneumonia. Health care protocol. [Internet]. [cited 2014 May 3]. Available from: <http://www.guideline.gov/content.aspx?id=36063>
- Mani R, Saxena P. Preventing hospital acquired infections: A challenge we must accept. *Indian J Crit Care Med*. 2014;18(3):125.
- Rosenthal VD, Maki DG, Salomao R, Moreno CA, Mehta Y, Higuera F, et al. Device-Associated Nosocomial Infections in 55 Intensive Care Units of 8 Developing Countries. *Ann Intern Med*. 2006 Oct 17;145(8):582–91.
- Prevention of hospital-acquired infections WHO [Internet]. [cited 2014 Sep 12]. Available from: <http://www.who.int/csr/resources/publications/whodcscsreph200212.pdf>

Topic: Acute respiratory failure and mechanical ventilation.

000153

Norepinephrine preserved flap blood flow compared to phenylephrine in free flap breast reconstruction surgery: a pilot study

J. Y. Sohn¹, H. Kim¹, S. Lee¹, U. S. Jin², C. Hak², Y. J. Cho¹

¹Anesthesiology and Pain Medicine, Seoul National University Hospital, Seoul, Republic of Korea; ²Plastic and Reconstructive Surgery, Seoul National University Hospital, Seoul, Republic of Korea

Correspondence: Y.J. Cho

Intensive Care Medicine Experimental 2023, **11(Suppl 1)**:000153

Introduction. Vasopressors are used up to 85% of cases during free flap surgery. However, their use is still debated with concerns of vasoconstriction-related complications, with rates up to 53% in minor cases. We investigated the effects of vasopressors on flap blood flow during free flap breast reconstruction surgery. We hypothesized that norepinephrine may preserve flap perfusion than phenylephrine during free flap transfer.

Methods. A randomized pilot study was performed in patients undergoing free transverse rectus abdominis myocutaneous (TRAM) flap breast reconstruction. Patients with peripheral artery disease, allergic to study drugs, previous abdominal operation, left ventricular dysfunction, or uncontrolled arrhythmias were excluded. Twenty patients were randomized to receive either norepinephrine (0.03–0.10 µg/kg/min) or phenylephrine (0.42–1.25 µg/kg/min) (each $n = 10$) to maintain mean arterial pressure 65–80 mmHg (Fig. 1). Primary outcome was differences in mean blood flow (MBF) flap vessels after anastomosis measured using transit time flowmetry in the two groups. Secondary outcomes included pulsatility index, flap loss, necrosis, thrombosis, wound infection, and reoperation within 7 days postoperatively.

Results. After anastomosis, MBF showed no significant change in the norepinephrine group (mean difference, -9.4 ± 14.2 mL/min; $p = 0.082$), whereas it was reduced in the phenylephrine group (-7.9 ± 8.2 mL/min; $p = 0.021$) (Fig. 2). There were no differences in secondary outcomes between the groups.

Conclusions. During free TRAM flap breast reconstruction, norepinephrine seems to preserve flap perfusion compared to phenylephrine. However, due to the small sample size and preliminary nature of data, further validation studies are required.

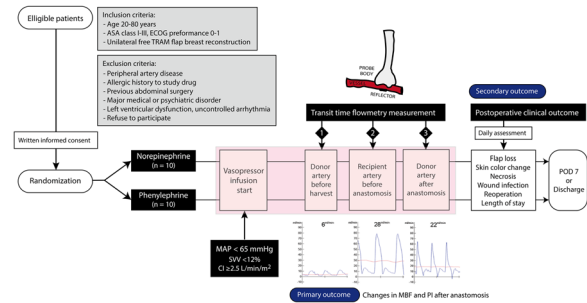

Figure 1 (abstract 000153) Study design. ASA, American Society of Anesthesiologists; CI, cardiac index; ECG, Eastern Cooperation Oncology Group; MAP, mean arterial pressure; MBF, mean blood flow; PI, pulsatility index; POD, postoperative day; SVV, stroke volume variation; TRAM, transverse rectus abdominis myocutaneous

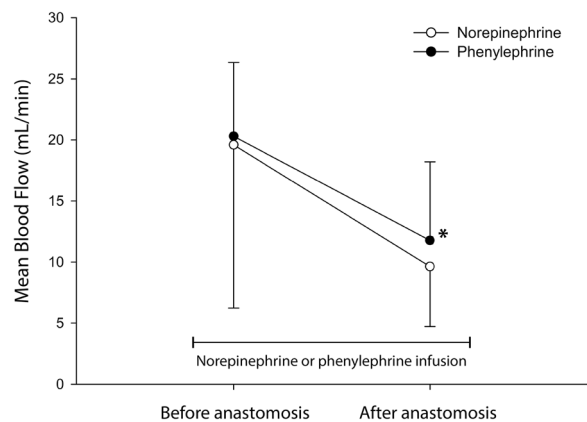

Figure 2 (abstract 000153) Changes in mean blood flow of flap before and after anastomosis in patients received norepinephrine or phenylephrine during breast reconstructive surgery. * $p < 0.05$ compared to before anastomosis in the phenylephrine group. Data points and error bars represent mean and standard deviation, respectively

References

- Monroe MM, McClelland J, Swide C, Wax MK. Vasopressor use in free tissue transfer surgery. *Otolaryng Head Neck* 2010;142:169–73.
- Fang L, Liu J, Yu CC, Hanasono MM, Zheng G, Yu P. Intraoperative Use of Vasopressors Does Not Increase the Risk of Free Flap Compromise and Failure in Cancer Patients. *Ann Surg* 2018;268:379–84.
- None
- Ibrahim AM, Kim PS, Rabie AN, Lee BT, Lin SJ. Vasopressors and reconstructive flap perfusion: a review of the literature comparing the effects of various pharmacologic agents. *Ann Plast Surg* 2014;73:245–8.
- Malagon P, Carrasco C, Vila J, Priego D, Higuera C. Intraoperative hemodynamic changes in the arterial blood flow measured by transit time flowmetry (TTFM) during breast reconstruction with free diep flap. *J Plast Reconstr Aesthet Surg* 2020;73:1775–84.
- Kieser TM, Rose S, Kowalewski R, Belenkie I. Transit-time flow predicts outcomes in coronary artery bypass graft patients: a series of 1000 consecutive arterial grafts. *Eur J Cardiothorac Surg* 2010;38:155–62.
- Nelson JA, Fischer JP, Grover R, et al. Intraoperative vasopressors and thrombotic complications in free flap breast reconstruction. *J Plast Surg Hand Surg* 2017;51:336–41.

8. Goh CSL, Ng MJM, Song DH, Ooi ASH. Perioperative Vasopressor Use in Free Flap Surgery: A Systematic Review and Meta-Analysis. *Journal of Reconstructive Microsurgery* 2019;35:529–40.

Topic: Perioperative care.

000154

Subdural empyema and abscess in neonates with acute bacterial meningitis: the clinical features, therapeutic strategies and outcomes

M. H. Tsai¹, J. F. Hsu², S. M. Chu³

¹Pediatrics, Chang Gung Memorial Hospital, Yunlin, Taiwan; ²Pediatrics, Linkou Chang Gung Memorial Hospital, Linkou, Taiwan; ³Pediatrics, Chang Gung Memorial Hospital, Linkou, Taiwan

Correspondence: M.H. Tsai

Intensive Care Medicine Experimental 2023, **11(Suppl 1)**:000154

Introduction. Subdural empyema is a serious complication of bacterial meningitis, a therapeutic challenge to clinicians and associated with long-term neurological sequelae.

Objectives. To evaluate the clinical features, therapeutic strategies, and outcome of subdural empyema complicating acute bacterial meningitis in neonates.

Methods. Case series from a retrospective cohort study conducted in two medical centers in Taiwan between 2003 to 2020.

Results. During the study period, a total of 153 neonates with bacterial meningitis were identified and enrolled. Among them, a total of 24 cases with subdural empyema or abscess were identified. *Streptococcus agalactiae* (Group B *Streptococcus*, GBS) and *E. coli* accounted for 37.5% (n=9) and 29.2% (n=7) of all neonatal bacterial meningitis with subdural empyema, respectively. Neonates with subdural empyema usually had more severe clinical manifestations than those with acute bacterial meningitis without subdural empyema, including more likely to have consciousness changes, focal seizures, and paresis. The cerebrospinal fluids findings cannot be predictive for occurrence of subdural empyema. Surgical intervention was performed for all cases with subdural empyema, and longer therapeutic duration of antibiotics was also noted. A higher percentage (70.8%, n=17) of them had neurological sequelae at discharge, although the final mortality rate was comparable to those without subdural empyema.

Conclusions. Subdural empyema and abscess is not uncommon in neonates with acute bacterial meningitis. Both GBS and *E. coli* are important pathogens to cause subdural empyema in neonates with acute bacterial meningitis. Neurosurgical intervention with longer broad-spectrum antibiotics are required to optimize the outcomes. Long-term follow-up is indicated for high risk of neurological sequelae.

Topic: Neurointensive care.

000156

Critical care nurses' perceived end of life care competencies and nursing performance based on Nursing Intervention Classification (NIC)

Y. Woo¹

¹Emergency Intensive Care Unit, Seoul National University Hospital, Seoul, Republic of Korea

Correspondence: Y. WOO

Intensive Care Medicine Experimental 2023, **11(Suppl 1)**:000156

Introduction. During the last days of patients' lives, invasive treatment to extend their lives causes pain and hinders human dignity and a peaceful death. In Korea, the death of patients usually occurs at medical institutions. Intensive care unit(ICU) nurses who provide care to end-of-life patients complain of difficulties in providing such care for a dignified death in the ICU environment where there are many medical devices, noises, and lights.

Objectives. This survey study analyzed the factors influencing the frequency of nursing performance based on nursing intervention classification (NIC) and the nursing competency of end-of-life nurses in ICUs.

Methods. The subjects were nurses in ICUs at each of the tertiary hospitals and general hospitals in Seoul, who provide independent and direct care, and have experience in caring for end-of-life patients. The data were collected after the researchers distributed the questionnaire themselves. Of the 230 questionnaires distributed, 181 were returned. After excluding three incomplete questionnaires, only 178 were used for research analysis. Using the SPSS version 25 program, the difference and correlation between nursing competency of end-of-life nurses in ICUs and the frequency of nursing of end-of-life patients according to the general characteristics were analyzed. The factors affecting the frequency of performance were analyzed using multiple return analysis.

Results. 1. The nursing competency of ICU nurses was statistically significantly higher when a nursing guideline reference for end-of-life patients ($p \leq 0.001$) was available at work.

2. The frequency of nursing for end-of-life patients was significantly high when the respondent said there was a nursing guideline for end-of-life patients available while working ($p = 0.013$).

3. The nursing capacity of end-of-life patients is the frequency of nursing ($p \leq 0.001$). There was a significant correlation with the lower factors such as knowledge (< 0.001), attitude competency (< 0.001), and acting capacity (< 0.001).

4. The factors influencing the frequency of nursing for end-of-life patients is the act of nursing ($p \leq 0.001$) and nursing knowledge (< 0.001), respectively.

Conclusions. Based on these findings, ICU nurses need to overhaul specific systems, such as providing education to enhance nursing capabilities, and providing practical support for nursing staff with end-of-life nursing expertise in the work environment, in order to protect the dignity and value of patients. In addition, as one of the core competencies of ICU nurses at the actual medical site, practical guidance needs to be provided to identify nursing capabilities for quality end-of-life care and to gauge the frequency of performance. It is also expected that the results of this study will be used as basic data for future standardized life care guidelines and improvements in ICUs.

Topic: Ethics and end of life care.

000159

An international study of Sedation, Analgesia and Delirium Management in medical, surgical, trauma, neurological, and COVID-19 ICU patients: Characteristics of SANDMAN centers

L. Prisco¹, S. Bensemmane², N. Ahluwalia³, M. Chew⁴, L. Burry⁵, FC. Carini⁶, I. Jammer⁶, D. Delange⁷, G. Meyfroidt⁸, F. S. Taccone⁹, J. Salluh¹⁰, B. Weiss¹¹, G. Citerio¹², S. Mehta³

¹Nuffield Department of Clinical Neurosciences, University of Oxford, Oxford (UK), Oxford, United Kingdom;

²Health Services Research, Epidemiology and Public Health, Sciensano, European Society of Intensive Care Medicine, Brussels, Belgium;

³Interdepartmental Division of Critical Care Medicine, University of Toronto, Sinai Health System, Toronto, Canada;

⁴Department of Anaesthesia and Intensive Care, Biomedical and Clinical Sciences, Linköping University Hospital, Linköping, Sweden;

⁵Departments of Pharmacy and Medicine, Sinai Health System, Leslie Dan Faculty of Pharmacy, University of Toronto, Toronto, Canada;

⁶Department of Anaesthesia and Intensive Care Medicine, Haukeland University Hospital, Bergen, Norway;

⁷Intensive Care Medicine, University Medical Center Utrecht, Utrecht, Netherlands;

⁸Intensive Care Medicine, University of Leuven (KU Leuven), Leuven, Belgium;

⁹Intensive Care Medicine, Hôpital Erasme, Brussels, Belgium;

¹⁰Intensive Care Medicine, D'OR Institute for Research and Education, Rio de Janeiro, Brazil;

¹¹Intensive Care Medicine, Berlin University Hospital, Berlin, Germany;

¹²Neurosurgical Intensive Care Unit, San Gerardo Hospital, Monza, Italy

Correspondence: S. Mehta

Intensive Care Medicine Experimental 2023, 11(Suppl 1):000159

Introduction. Despite compelling evidence and guidelines recommending light sedation in critically ill patients, pain, analgesia and delirium (PAD) management likely varies internationally. SANDMAN is an international retrospective observational study which evaluated sedative, analgesic, and antipsychotic administration practices in critically ill, mechanically ventilated adults, and adherence to PAD guidelines.

Objectives. The primary SANDMAN objective was to describe international practice variation in the use of medications and monitoring for PAD in mechanically ventilated adults prior to and during the COVID-19 (C19) pandemic. In this abstract we describe preliminary data on the 1) characteristics of participating ICUs; 2) self-reported adherence to evidence-based and guideline-directed PAD practices; 3) perceived changes in drug availability and sedation management during the C19 pandemic.

Methods. Multiple ICUs in each participating hospital were invited via the European Society of Intensive Care Medicine to contribute data on eligible patients. Ethics approval was obtained locally at all sites. Site data included hospital and ICU characteristics, common PAD therapeutic options, and use of PAD protocols and scales. Patient data were collected retrospectively, including baseline demographics, and PAD management for the first 7 consecutive days of invasive mechanical ventilation. All sites contributed data for the main cohort (20 consecutive patients admitted to ICU from 1st October 2019 to date of first C19 admission), and participation in the COVID-19 sub-cohorts was voluntary (20 consecutive C19 patients and up to 20 non-C19 patients admitted to ICU during the pandemic period).

Results. Across 27 countries and 4 continents 3008 patients were enrolled. 91 ICUs and 67/91 ICUs contributed patient data for the main cohort and C19 sub-cohorts respectively. 59 (65%) were university-affiliated hospitals, and 29 (31%) were community hospitals. 55/91 (60%) were closed ICUs, and 73/91 (81%) managed a mixed patient population. 24/90 (27%) had an open 24/7 visitation policy. 37 (41%) ICUs had 11–19 staffed beds, and 23 (25%) had ≤ 10 beds. Most ICUs (70/91) had ≥ 11 ventilators available. Nurse:patient ratio for mechanically ventilated patients was most commonly 1:2 (43%) or 1:1 (39%); and 1:2 (54%) for non-ventilated patients. Most ICUs had dedicated physiotherapists (80%) and pharmacists (65%), and $< 50\%$ had respiratory therapists or a mobility team.

Commonly available intravenous analgesics ($> 80\%$ ICUs) were fentanyl, morphine and paracetamol; $> 80\%$ ICUs reported intravenous midazolam, propofol, dexmedetomidine and ketamine were available. PAD assessment scales were in use in more than 75% of ICUs. The most common scales for each of these were RASS (94%), Numeric rating scale for pain (58%), and CAM-ICU (72%). Reported availability of local protocols were: sedation (59%), ventilator weaning/SBT (59%), delirium (57%), mobilization (49%), pain (46%), and physical restraint (43%). ICUs reported they routinely practice: daily sedation/analgesia interruption (69%), physical restraints (66%), weaning opioids to prevent iatrogenic withdrawal (62%), daily spontaneous breathing trials (56%), and analgesia-first sedation (49%). Nearly 60% ICUs who experienced drug shortages (44/87) changed their sedation practices during the pandemic and perceived that C19 patients required higher amounts of sedatives, analgesics, neuromuscular blockade, and had a higher incidence of delirium.

Conclusions. There is international variation in the use of protocols, monitoring and medications for PAD. Clinicians experienced shortages of medications during the C19 pandemic and perceived that C19 patients required higher doses of sedatives, analgesics and paralytics.

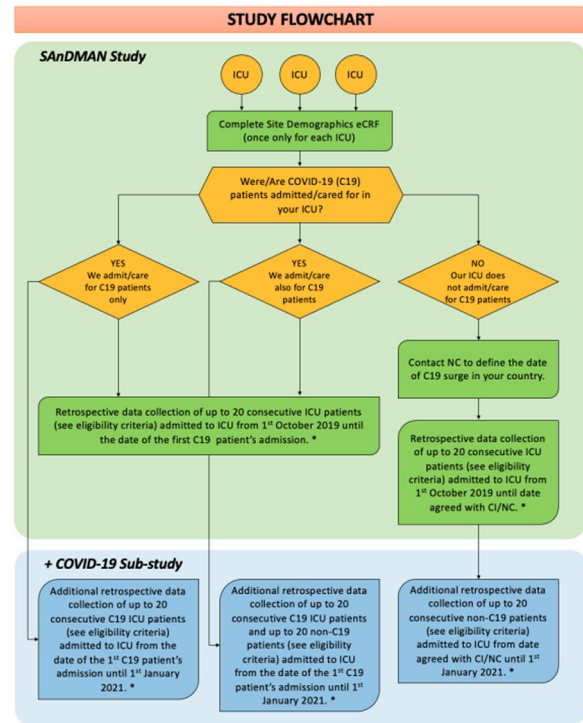

Study Flow for the SANDMAN study: an observational study describing sedation, analgesia, and delirium strategies used in ICUs around the world.

References

- Devlin JW, et al. Clinical Practice Guidelines for the Prevention and Management of Pain, Agitation/Sedation, Delirium, Immobility, and Sleep Disruption in Adult Patients in the ICU. *Crit Care Med*. 2018 Sep;46(9):e825-e873
- SANdMAN study Sedation, Analgesia and Delirium Management. ClinicalTrials.gov Identifier: NCT05027217. <https://www.esicm.org/sandman/>
- SANdMAN was awarded an ESICM Trials Group Award in 2018. The investigators are grateful for the funding and support provided by ESICM, and the support provided by Guy M Francois.

Topic: Sedation, analgesia and delirium.

000161

Analysis of the clinical picture of poisoning patients according to beta-blockers blood levels

S. Kim¹, W. J. Jeong², K. M. Cha,¹ B. H. So¹

¹Department of Emergency medicine, St. Vincent's Hospital, College of Medicine, The Catholic University of Korea, Seoul, Republic of Korea;

²Department of Emergency department, St. Vincent's Hospital, College of Medicine, The Catholic University of Korea, Seoul, Republic of Korea

Correspondence: S. Kim

Intensive Care Medicine Experimental 2023, **11(Suppl 1)**:000161

Introduction. Adrenergic beta-Antagonists(beta-blockers) are also widely prescribed to psychiatric patients to control adrenergic symptoms. These patients visit emergency department more frequently due to drug intoxication, and severe cardiovascular system abnormalities can be fatal to patients with poisoning. We analyze blood levels of beta-blockers and the clinical manifestations of patients, and want to predict the progression to severe complications at the beginning of the visit.

Methods. This study was conducted at the Regional Emergency Medical Center of a university hospital with about 60,000 patients visiting emergency centers annually. We analysed retrospective medical records in beta-blocker poisoning patients aged 18 years and older who visited the emergency department between 1 January 2016 and 31 May 2022.

Results. 200 patients were enrolled. Beta-blocker blood levels were significantly higher in patients with hypotension, bradycardia, and prolonged QT intervals, with median values of 247.0 (56.5: 333.8) ng/ml, 275.8(154.3:486.4) ng/ml, and 159.0 (33.9: 310.8) ng/ml, respectively. In the analysis of cardiovascular complication prediction rate with the ROC curve, the AUC value was 0.729, the cut-off value was 72.40 ng/ml (sensitivity, 0.667 and specificity, 0.819). In addition, the correlation coefficient between drug dose and blood concentration through medical history listening at the time of visit was 0.634, which was found to have a significantly higher relationship.

Conclusions. Because blood levels in patients with beta-blocker poisoning were significantly higher in patients with severe cardiovascular complications, consider performing a blood level test early in the emergency department visit. And, the amount of drugs found through listening to the medical history is highly correlated with blood levels, so they estimated to have taken more than 72 mg of beta-blockers need active treatment and intensive observation from an early stage.

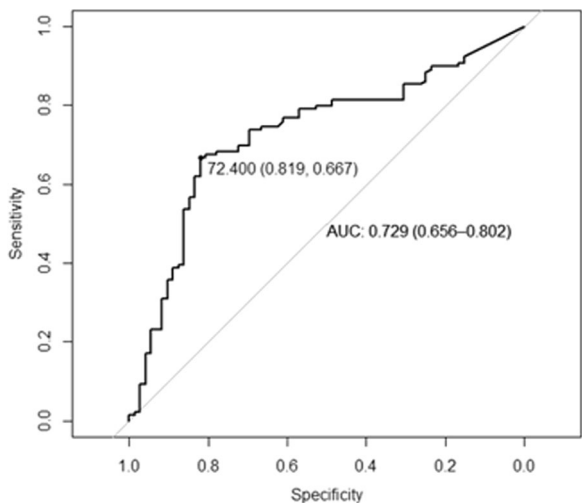

Figure 1 (abstract 000161) Receiving-operating characteristic curve for predicting between cardiovascular complication and blood level

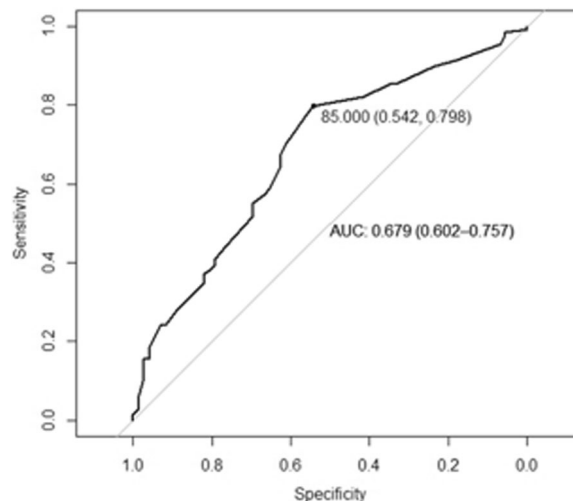

Figure 2 (abstract 000161) Receiving-operating characteristic curve for predicting between cardiovascular complication and verbal amount

	Total Patients (N=200)	Cardiovascular Complication (N=137)	Non-Cardiovascular Complication (N=63)	p-value
Age (mean ± SD)	41.0 (12.1)	41.1 (12.1)	40.9 (12.1)	0.716
Sex (Male)	152 (76.0%)	98 (71.5%)	54 (85.7%)	0.001
Co-Poisoning				
Z	18.9 (9.4%)	12.9 (9.4%)	6.0 (9.5%)	0.562
F	30.0 (15.0%)	20.7 (15.1%)	9.3 (14.6%)	0.264
I	88.7 (44.3%)	59.5 (43.4%)	29.2 (46.1%)	0.165
S	29.0 (14.5%)	19.6 (14.3%)	9.4 (14.9%)	0.502
A	74.0 (37.0%)	48.3 (35.3%)	25.7 (40.6%)	0.108
Co-Poisoning (n=168)				
Alcohol	17.0 (10.1%)	10.5 (7.6%)	6.5 (10.3%)	1.000
Benzodiazepines	17.0 (10.1%)	10.5 (7.6%)	6.5 (10.3%)	0.981
Anticholinergics	89.6 (53.3%)	58.3 (42.6%)	31.3 (49.4%)	0.007
Antipsychotics	89.6 (53.3%)	58.3 (42.6%)	31.3 (49.4%)	0.264
Tricyclics	89.6 (53.3%)	58.3 (42.6%)	31.3 (49.4%)	0.165
Sedatives	89.6 (53.3%)	58.3 (42.6%)	31.3 (49.4%)	0.001
Other	89.6 (53.3%)	58.3 (42.6%)	31.3 (49.4%)	0.001
Total	422.0 (211.0%)	281.7 (205.6%)	140.3 (223.9%)	0.001
Poisoning symptoms				
Cardiovascular	137 (68.5%)	137 (100.0%)	0 (0.0%)	<0.001
Hypotension	83.0 (41.5%)	63.0 (46.0%)	20.0 (31.7%)	0.001
Bradycardia	83.0 (41.5%)	63.0 (46.0%)	20.0 (31.7%)	0.001
Prolonged QT	113.0 (56.5%)	113.0 (82.5%)	0 (0.0%)	<0.001
Hypothermia	16.0 (8.0%)	10.0 (7.3%)	6.0 (9.5%)	0.625
Respiratory system	11.0 (5.5%)	7.0 (5.1%)	4.0 (6.3%)	0.634
Pneumonia	5.0 (2.5%)	3.0 (2.2%)	2.0 (3.2%)	0.375
COPD	6.0 (3.0%)	4.0 (2.9%)	2.0 (3.2%)	0.502
Lung cancer	0.0 (0.0%)	0.0 (0.0%)	0.0 (0.0%)	<0.001
Other	6.0 (3.0%)	4.0 (2.9%)	2.0 (3.2%)	<0.001
All other	17.0 (8.5%)	10.0 (7.3%)	7.0 (11.1%)	<0.001
Total	153.0 (76.5%)	100.0 (73.0%)	53.0 (84.1%)	<0.001
Total	153.0 (76.5%)	100.0 (73.0%)	53.0 (84.1%)	<0.001
Other	15.0 (7.5%)	10.0 (7.3%)	5.0 (7.9%)	0.001
Total	168.0 (84.0%)	110.0 (80.3%)	58.0 (92.1%)	0.001
Other	32.0 (16.0%)	27.0 (19.7%)	5.0 (7.9%)	0.001
Total	199.0 (99.5%)	137.0 (100.0%)	63.0 (100.0%)	<0.001
Other	1.0 (0.5%)	0 (0.0%)	1.0 (1.6%)	0.001
Total	200.0 (100.0%)	137.0 (100.0%)	63.0 (100.0%)	<0.001

References

- Joo SW, Min YG, Choi SH, Park EJ. The Intoxication of Beta Blocker with Psychiatric Drugs Focused on the Cardiovascular Adverse Effects. J Korean Soc Clin Toxicol 2016;14:100-6.
- DeWitt CR, Waksman JC. Pharmacology, pathophysiology and management of calcium channel blocker and betablocker toxicity. Toxicol Rev 2004;23:223-38
- Graudins A, Lee HM, Druda D. Calcium channel antagonist and beta-blocker overdose: antidotes and adjunct therapies. Br J Clin Pharmacol 2016;81:453-61

Topic: Poisoning/Toxicology/Pharmacology.

000164

Polymyxin B-immobilized membrane can scavenge damage associated molecular patterns and neutrophil extracellular traps in vitro

M. M. Islam¹, U. Salma¹, A. Okumura², E. Watanabe¹, N. Takeyama¹

¹Emergency and Critical Care Medicine, Aichi Medical University, Nagakute, Aichi, Japan; ²Pediatrics, Aichi Medical University, Nagakute, Aichi, Japan

Correspondence: M.M. Islam

Intensive Care Medicine Experimental 2023, **11(Suppl 1)**:000164

Introduction. Although both damage-associated molecular patterns (DAMPs) and neutrophil extracellular traps (NETs) have physiological roles in regulating inflammation and immune response including antimicrobial defenses against infection, they also have various pathological potential [1]. We hypothesized that the removal of excessively released DAMPs and NETs from circulation would give benefits to the patients. Direct hemoperfusion with a cartridge containing polymyxin B (PMX)-immobilized membrane (Toray, Japan) is frequently practiced in the treatment of septic shock to remove endotoxin.

Objectives. This study aimed to evaluate the efficacy of PMX-immobilized membrane to adsorb DAMPs and a released-NETs components in vitro.

Methods. DAMPs (commercially available DNA, RNA, nucleosomes and histone) and a released-NET from activated neutrophils were added separately into each well (9.5 cm²) with or without PMX-immobilized membrane (2 cm x 2 cm each with a surface area of 4 cm²) and incubated up to 60 min with shaking at room temperature. To increase the dose of PMX, the surface area of PMX-immobilized membrane was increased by repeated exposure of the membrane to the DAMPs and NETs. Following incubation, the levels of DAMPs and NETs components were assayed. Amounts of DNA conjugated with myeloperoxidase (MPO), and cell-free DNA were assayed by sandwich ELISA and Qubit fluorometer as NET-components, respectively.

Results. DAMPs and NETs components levels were significantly dampened dependent on an area of membrane surface and incubation time after incubation with PMX-immobilized membrane (Table).

Table (abstract 000164) DAMPs and NETs levels following 5 min incubation with PMX membrane

Surface area, cm ²	Surface area of PMX membrane, n = 5				P value
	0	4	8	12	
DNA, µg/ml	9.64 (9.10, 10.00)	8.36 (8.92, 7.90)	4.26 (4.56, 3.99)	3.27 (3.46, 2.96)	< 0.001
RNA, µg/ml	24.80 (25.80, 24.00)	20.00 (21.20, 18.90)	16.290 (16.80, 15.33)	12.87 (13.32, 11.96)	< 0.001
Nucleosome, µg/ml	47.47 (48.34, 45.13)	22.95 (23.77, 21.70)	10.42 (12.12, 9.10)	6.97 (9.55, 6.80)	< 0.001
Histone, AU	0.150 (0.169, 0.112)	0.091 (0.100, 0.075)	0.077 (0.084, 0.068)	0.051 (0.064, 0.043)	< 0.001
cell-free DNA, µg/ml	19.38 (20.35, 18.40)	11.48 (13.36, 10.13)	8.24 (9.12, 6.87)	4.46 (5.87, 3.00)	< 0.001
MPO-DNA, AU	0.244 (0.263, 0.227)	0.197 (0.209, 0.187)	0.084 (0.098, 0.068)	0.068 (0.079, 0.058)	< 0.001

Data was expressed as Median (IQR) and analyzed using ANOVA.

Conclusions. Our in vitro experiments demonstrate that PMX-immobilized membrane can absorb DAMPs and a released-NET components efficiently. Our results open new doors for understanding the application of hemoperfusion with a cartridge containing PMX-immobilized membrane to selective removal of circulating DAMPs and NETs in patients with sepsis which may improve remote organ damage.

References

1. JSPS KAKENHI Grant Number JP22K09131
2. Lee J, Jackman JG, Kwun J, et al., Nucleic acid scavenging microfiber mesh inhibits trauma-induced inflammation and thrombosis. *Biomaterials*, 2017 Mar;120:94–102.

Topic: Acute Kidney Injury and haemofiltration.

000166

Corticosteroid use as a risk factor for superimposed nosocomial bloodstream infections in hospitalized patients with COVID-19

N. Sathaporn, B. Khwannimit¹

¹Prince of songkla university, hat yai, songkhla, thailand, Department of Internal Medicine, Faculty of Medicine, Hat Yai, Thailand

Correspondence: N. Sathaporn

Intensive Care Medicine Experimental 2023, **11(Suppl 1)**:000166

Introduction. Corticosteroids are a component of the standard therapy for patients with coronavirus disease 2019 (COVID-19). In real-world practice, corticosteroid dose and treatment duration depend on the physician's pragmatics. Despite, various data from some studies investigating the risk factors for blood stream infection (BSI) in patients with COVID-19, there are limited data on corticosteroid doses. Therefore, this study aimed to evaluate the potential risk factors for nosocomial BSIs in hospitalized patients with COVID-19, including the exploration of corticosteroid dosage.

Methods. A retrospective cohort study of hospitalized adult patients with COVID-19 was conducted in a tertiary care hospital between February 2020 and January 2022. COVID-19 infection was diagnosed by a positive reverse transcription-polymerase chain reaction. Nosocomial BSIs were defined as the presence of microorganisms in one or more blood cultures at least 48 h after admission. We performed univariate and multivariate analyses of various parameters to identify risk factors for nosocomial bloodstream infection.

Results. Of 252 patients, most patients (81.4%) were admitted to the ICU. 19% had nosocomial BSI. The overall mortality rate was 27%. However, mortality in the nosocomial BSI group was significantly higher than that in the non-BSI group (62.5% vs. 18.6%, $p < 0.001$). Of the patients diagnosed with COVID-19 pneumonia, 97.9% were in the nosocomial BSI group, and 87.3% were in the non-BSI group. Corticosteroids were administered to all patients in the nosocomial BSI group. Meanwhile, 81.4% of the patients in the non-BSI group used corticosteroids. The median equivalent dexamethasone dose until the first episode of BSIs was 14.1 mg/day (interquartile range, 10.4–17.7). The median durations from corticosteroid administration to the first episode of BSIs were 11.5 days. The rate of receiving methylprednisolone was significantly higher in the nosocomial BSI group than in the non-BSI group (35.4% vs. 10.8%). The use of tocilizumab, baricitinib, and tofacitinib was not associated with nosocomial BSI. Forty-three patients (89.6%) experienced one episode of nosocomial BSI. The maximum number of episodes of nosocomial BSIs (five) occurred in one patient who underwent extracorporeal membrane oxygenation (ECMO); nonetheless, other patients (4 [8.3%]) experienced second episodes of nosocomial BSIs. Pneumonia (46.6%) was the most common source of infection, followed by primary BSI (20.7%), catheter-related BSI (10.3%), urinary tract infection (8.6%), intra-abdominal infection (8.6%), and skin and soft tissue infections (5.2%). Multivariate analysis revealed that male sex (odds ratio [OR] 3.18; 95% confidence interval [CI]: 1.60–7.33), receiving methylprednisolone (OR: 2.43; 95% CI: 1.24–7.31), receiving an equivalent dexamethasone dose of 6–12 mg (OR: 3.08; 95% CI: 2.08–26.94), and increased white blood cell count on admission (OR: 3.56; 95% CI: 1.05–1.17) were significant predictors of nosocomial BSIs.

Table 1 (000166) Different variables associated with nosocomial BSIs in hospitalized patients with COVID-19 in the multivariate analysis

Variables	OR (95% CI)	p-value
Male	3.18 (1.60–7.33)	0.001
Receiving methylprednisolone	2.43 (1.24–7.31)	0.015
Equivalent dexamethasone dose	Reference	0.002
< 6 mg/day	3.08 (2.08–26.94)	0.06
6–12 mg/day	1.91 (0.97–14.96)	
> 12 mg/day		
White blood cell count on admission × 10 ³ cell/mm ³ (± SD)	3.56 (1.05–1.17)	< 0.001

Conclusions. Unmodified risk variables for nosocomial bloodstream infections included male sex and leukocytosis at admission. Using methylprednisolone and obtaining a cumulative dosage of dexamethasone were adjusted risk variables associated with superimposed nosocomial bloodstream infections in hospitalized patients with COVID-19.

Topic: Sepsis.

000167

Comparison of multiplex PCR to endotracheal aspirates in patients with ventilation-associated pneumonia. Preliminary results

F. Jacobs¹, D. Prat¹, B. Sztrymf¹, K. Toumert¹, C. Guillet-Caruba², C. Damoiseil¹

¹Intensive Care Unit, Hôpital Antoine Bécère-APHP, Clamart, France;

²Microbiology department, Hôpital Antoine Bécère-APHP, Clamart, France

Correspondence: F. Jacobs

Intensive Care Medicine Experimental 2023, **11(Suppl 1)**:000167

Introduction. Multiplex polymerase chain reaction (mPCR) assays have emerged as tools for rapid diagnosis. The aim of this study was to assess the concordance of a semi-quantitative mPCR with conventional microbiological cultures (CMCs) in endotracheal aspirates (ETAs) among patients with suspected ventilator-associated pneumonia (VAP).

Methods. CMCs and mPCRs (Biofire FilmArray Pneumonia Panel plus, BioMérieux, France) were performed in parallel on the same ETA samples.

Results. A total of 32 samples from 27 patients were analysed. The median age of patients was years, the sex ratio (male/female) was 20/7, the median SAPSII score was 35.

Overall respectively 18 mPCRs and 21 CMCs were positive.

The most frequently identified bacteria on mPCRs were *Pseudomonas aeruginosa* (8), *Klebsiella aerogenes* (3), *Staphylococcus aureus* (3), *Enterobacter cloacae* (2). On CMCs results were as follow *Pseudomonas aeruginosa* (6), *Klebsiella aerogenes* (2), *Staphylococcus aureus* (3), *Enterobacter cloacae* (1).

mPCRs off-panel bacteria were detected in 8 cases (*Stenotrophomonas maltophilia* 3, *Achromobacter* 1, *Hafnia alvei* 2, *Citrobacter koseri* 1 *Acinetobacter radioresistens* 1).

Bacterial type

When both tests were positive, they were concordant for at least one bacterial type in 12 cases.

They were fully concordant in 9 cases.

In case of positive mPCRs and negative CMCs (n = 4), the discrepancy was linked to a previous recent infection with the same bacteria in 2 cases.

In 5 cases, CMCs retrieved a causative pathogen not included in the test panel.

Bacterial load

The number of bacteria copies/mL detected by mPCRs and CFU/mL by CMCs were compared.

Results were similar in 2 cases.

In 9 cases mPCRs results were higher than CMCs ones. Conversely CMCs never showed higher results.

Of note, in 3 cases positive but under the clinical significance thresholds (10⁵ CFU/mL) CMCs showed 10⁵ to 10⁶ copies/mL on PCRs.

Conclusions. mPCR may be a useful tool for VAP diagnostic.

However, interpretation of the results must be made with caution, integrating microbiological and clinical issues.

Topic: Infections and prevention.

000168

Maternal critical care provision in the intensive care unit: an international multicentre cross-sectional survey (MaCriCare)

P. Krawczyk¹, D. Dabrowska², E. Guasch³, H. Jörnvall⁴, N. Lucas⁵, F.J. Mercier⁶, A. Schyns-Van Den Berg⁷, C. F. Weiniger⁸, Ł. Balcerzak⁹, S. Cantello¹⁰

¹Anesthesia and Intensive Care, Jagiellonian University, Kraków, Poland;

²Department of Anaesthetics and Intensive Care, West Middlesex

University Hospital, Chelsea and Westminster Hospital NHS Foundation

Trust, London, United Kingdom; ³Servicio de Anestesia y Reanimación,

Hospital Universitario La Paz, Madrid, Spain; ⁴Function Perioperative

Medicine and Intensive Care, Department of Perioperative Care,

Karolinska University Hospital, Karolinska Institutet, Stockholm, Sweden;

⁵Consultant Anaesthetist, London North West University Healthcare NHS

Trust, London, United Kingdom; ⁶Département d'Anesthésie, Hôpital

Antoine Bécère, AP-HP, Université Paris-Saclay, Paris, France; ⁷Department

of Anesthesiology, Albert Schweitzer Ziekenhuis, Dordrecht, Leiden

University Medical Centre, Leiden, Netherlands; ⁸Division of Anesthesia,

Critical Care and Pain, Tel Aviv Sourasky Medical Center, Tel Aviv, Israel;

⁹Centre for Innovative Medical Education, Jagiellonian University

Medical College, Kraków, Poland; ¹⁰Consultant Anaesthetist, Nottingham

University Hospitals NHS Trust, Nottingham, United Kingdom

Correspondence: P. Krawczyk

Intensive Care Medicine Experimental 2023, **11(Suppl 1)**:000168

Introduction. Maternal critical care (MCC) encompasses the care of parturients from the onset of deterioration to post-discharge follow-up. Maternal critical illness can present additional management challenges, and maternity admissions to the intensive care unit (ICU) have been increasing in recent years. While the timely detection of critical illness in the labor suite has been receiving increasing attention, less focus has been given to the preparedness of ICUs to respond to the needs of maternity patients admitted to the intensive care unit. Many staff in the ICU may have had no prior exposure to the labor suite, and it is unusual for critical care training programs to address obstetric considerations in any depth.

Objectives. Our survey aimed to determine whether ICUs are adequately equipped to care for maternity patients. We assessed four broad areas: (i) competencies: the availability of staff with maternity-specific competencies in ICUs; (ii) emergency preparedness: the extent to which ICUs are ready to respond to obstetric emergencies, including the appropriate teams, drugs and equipment; (iii) follow-up and support: the provision of psychological screening, support and patient follow-up; and (iv) leadership and quality improvement: the presence of service leadership, local guidelines and data collection for quality improvement purposes.

Methods. Between September 2021 and January 2022, we conducted an international cross-sectional online survey of European hospitals with maternity units from 26 countries in the WHO Europe Region representing over 2 500 000 deliveries annually.

Results. 81.9% of centers (928 of 1133) provided onsite critical care facilities to maternity patients. Over 90% of the centers offered daily specialist obstetric reviews. Dual-trained staff (midwifery and critical care accreditation) were available in 24.3% of units, while 16% had access to the continuous presence of a midwife when a maternity patient was admitted. 3.5% of ICUs did not have immediate access

toutronic drugs, 7.5% to neonatal resuscitation equipment, 9.2% to a neonatal resuscitation team, and 11.4% to perimortem cesarean section equipment. Breastfeeding support was available in 82.2%, while physical contact between mother and baby was not possible in 29.5%. Screening for psychological trauma in maternity patients occurred in only 30.6%. Post-discharge follow-up was available in 33.1%. A named senior doctor who oversaw maternal critical care activities was available in 54.4%; 36.2% of units had an equivalent named senior nurse. Maternity-specific critical care policies were available in 71% of units. 62.5% collected data for quality improvement purposes, but only 41.2% submitted data on maternity patients to a national database. Detailed information is provided in Fig. 1.

Conclusions. Gaps exist in the provision for maternity patients admitted to European ICUs. Critical care facilities were not consistently available, and when they were available, they were often inadequately resourced, which could compromise patient safety and experience.



Figure 1 (abstract 000168) Maternal critical care resources available for maternity patients in the intensive care units

References

1. This work was supported by Jagiellonian University Medical College (grant number N41/DBS/000503 to PK)
2. The authors acknowledge National Coordinators and the survey respondents for their contribution to the MaCriCare study.
3. MBRRACE-UK Saving Lives Improving Mothers' Care—Lessons learned to inform maternity care from the UK and Ireland Confidential Enquiries into Maternal Deaths and Morbidity 2018–20 <https://www.npeu.ox.ac.uk/mbrrace-uk/reports>
4. Banerjee A, Cantellow S. Maternal critical care: part II. BJA Educ. 2021 May;21(5):164–171. <https://doi.org/10.1016/j.bjae.2020.12.004>. Epub 2021 Feb 6. PMID: 33927889; PMCID: PMC8071727.
5. Banerjee A, Cantellow S. Maternal critical care: part I. BJA Educ. 2021 Apr;21(4):140–147. <https://doi.org/10.1016/j.bjae.2020.12.003>. Epub 2021 Feb 5. PMID: 33777412; PMCID: PMC7984968.
6. Cranfield K, Horner D, Vasco M, Victory G, Lucas DN. Current perspectives on maternity critical care. Anaesthesia. 2023 Jan 12. <https://doi.org/10.1111/anae.15948>. Epub ahead of print. PMID: 36633911.

Topic: Critical care organisation, quality management, information systems, outcomes.

000171

Non-invasive electromagnetic phrenic nerve stimulation in critically ill patients—a feasibility study

A. Panelli¹, A. Grimm¹, S. Krause², M. A. Verfuß¹, B. Ulm³, H. G. Bartels¹, J. Grunow¹, T. Niederhauser¹, S. Weber-Carstens¹, L. Brochard⁴, S. J. Schaller¹
¹Department of Anesthesiology and Operative Intensive Care Medicine (CVK,CCM), Charité—Universitätsmedizin Berlin, Berlin, Germany, ²Institute for Human Centered Engineering, Berner Fachhochschule BFH, Bern, Switzerland; ³Department of Anesthesiology and Intensive Care, Technical University of Munich, School of Medicine,

Klinikum rechts der Isar, Munich, Germany; ⁴Keenan research centre for biomedical science, Interdepartmental Division of Critical Care, Toronto, Canada

Correspondence: A. Panelli

Intensive Care Medicine Experimental 2023, 11(Suppl 1):000171

Introduction. Electromagnetic stimulation of the phrenic nerve can induce diaphragm contractions; until recently, there were no specific coils designed for targeted and prolonged non-invasive electromagnetic phrenic nerve stimulation (NEPNS) in critically patients. We previously demonstrated the absence of interference with other electronic devices with 100% intensity at 30 cm distance (1). The feasibility of NEPNS was demonstrated by inducing diaphragmatic contractions before surgery in lung-healthy, normal-weight patients to ventilate these patients in a dose-dependent manner, i.e., higher intensity produced higher tidal volume (2).

Objectives. We aimed to test feasibility of NEPNS in critically ill patients i.e., can the intervention be applied in the ICU setting. Secondary aim was to examine if NEPNS has an effect on diaphragm thickness.

Methods. This feasibility non-randomized controlled study (NCT05238753) aimed to enrol 30 patients within 36 h of intubation, who were expected to remain ventilated for at least 72 h. The intervention group should receive 15 min NEPNS sessions (A) twice, (B) three, or (C) five times per day, while the control group received standard of care. For the simulation, the STIMIT exclusive PMR35 Dual Coils (STIMIT AG, Biel, Switzerland) driven by a PowerMAG 100 clinical stimulator (Mag&More GmbH, Munich, Germany) were used. If feasible, NEPNS was used stand-alone to ventilate the patient (ventilator in continuous positive airway pressure (CPAP) mode without pressure support); if necessary to adequately ventilate the patient, pressure support was added. Primary outcome was feasibility, measured as (1) sessions performed according to protocol or by follow-up session the following day, (2) time to find the optimal stimulation point, and (3) tidal volume with stimulation only (i.e., no further ventilatory support) reaching 3–6 ml/kg IBW. Key secondary endpoint was expiratory diaphragm thickness measured with ultrasound from Day 1 to Day 10 (or extubation).

Results. The study was stopped prematurely because the CE certificate of the coils was revoked due to the new medical device regulations in the EU, i.e., a total of 11 patients (5 intervention group (A), 6 control) were enrolled in 2022. The intervention twice per day was executed in 87% and 92% of cases without and with a recovery session on the following day, respectively. Time to find stimulation point was 23 [12–62] seconds. Lung ultraprotective ventilation (3–6 ml/kg IBW) was achieved in 732/6356 (11%) of stimulations with stimulation only and 2511/6356 (40%) of stimulations with additional pressure support. The remaining 49% stimulations were either with spontaneous breathing or stimulated breaths outside 3–6 ml/kg IBW. The diaphragm thickness increased by NEPNS (p = 0.034, Fig. 1).

Conclusions. NEPNS was feasible in the ICU setting. NEPNS seems to prevent diaphragm atrophy during mechanical ventilation measured by expiratory diaphragm thickness.

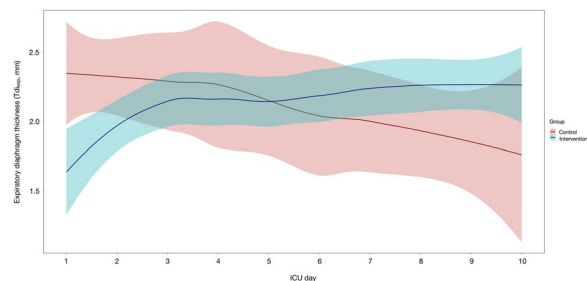

Figure 1 (abstract 000171) Trajectory of expiratory diaphragm thickness (Tdiexp, mm) measured by ultrasound over time (with 95% confidence interval) for intervention group (blue) and control (red). Intervention received non-invasive electromagnetic phrenic nerve

stimulation twice daily for 15 min which increased Tdiexp compared to controls as demonstrated in a mixed model analysis using Tdiexp from Day 1 to Day 10 (or till extubation). The intervention ($p=0.034$), time ($p=0.032$) and the interaction of time and group ($p=0.004$) were significant. Delta Day 10 vs. Day 1 was significantly different (0.926 [0.485–1.063] in the intervention vs. -0.731 [-0.909 to -0.565] in the control, $p=0.036$)

References

1. This investigator initiated study was partly funded by STIMIT AG, Biel, Switzerland.
1. Kuhn KF, Grunow JJ, Leimer P, Lorenz M, Berger D, Schefold JC, et al. Assessment of magnetic flux density properties of electromagnetic noninvasive phrenic nerve stimulations for environmental safety in an ICU environment. *Sci Rep.* 2021;11(1):16317.
2. Panelli A, Bartels H, Krause S, Verfuß M, Grimm A, Carbon NM, et al. First non-invasive magnetic phrenic nerve and diaphragm stimulation in anaesthetized patients—a proof-of-concept study. *Intensive Care Med Exp.* 2023: accepted for publication (<https://doi.org/10.1186/s40635-023-00506-6>).

Topic: Acute respiratory failure and mechanical ventilation.

000175

A quality improvement project aimed at improving documentation of central venous catheter (CVC) and arterial line insertion within the intensive care unit (ICU) following implementation of a new trust-wide electronic noting system

J. Deane¹, L. Achiam¹, A. Myers¹, T. Samuels¹

¹Intensive Care Medicine, East Surrey Hospital, Redhill, United Kingdom

Correspondence: J. Deane

Intensive Care Medicine Experimental 2023, **11(Suppl 1)**:000175

Introduction. Invasive catheterisation is associated with important complications including local and systemic infection. This can lead to increased mortality and higher health care costs (1). Accurate documentation of insertion and maintenance is essential in limiting catheter-associated infection and many centres now use an Electronic Health Record to improve record-keeping.

East Surrey Hospital has a busy 16 bed, mixed medical and surgical adult ICU. A comprehensive electronic notes system was introduced in 2022 to improve documentation. Prior to this, line insertion was documented by completing a separate electronic proforma which was copied into the patient's electronic notes.

Objectives. Our aim was to review the impact of using a fully electronic notes system on the documentation of central venous and arterial catheterisation and to explore ways to further promote accurate record keeping.

Methods. In this single centre study, an initial retrospective review was performed for a 2-week period (1/11/21–14/11/21) prior to electronic noting (pre-eSASH). Correct documentation of the following aspects of invasive catheterisation in ICU patients was recorded: indication (CVC only), clinician name, date inserted, type of line, patient and clinician preparation (CVC only), technique used, post-procedure care/complications. Comparable retrospective data were recorded for an early 'post-eSASH' cohort of patients (1/11/22–14/11/22).

Following these initial results, a poster was created and displayed locally, with a guide on how to correctly document lines alongside a QR code which users could scan to view a more detailed presentation on the line documentation process. The same dataset was then prospectively collected for patients admitted 1/2/23–14/2/23 (post-intervention).

Results. In the pre-eSASH cohort, a total of 23/29 (79.3%) CVCs and 10/15 (66.7%) arterial lines were correctly documented. These rates were much higher when compared with the post-eSASH cohort where

5/11 (45.5%) CVCs and 7/20 (35%) arterial lines were correctly documented. Following the intervention, a total of 10/26 (38.5%) CVCs and 13/26 (50%) arterial lines were correctly documented.

Conclusions. This survey suggests that the introduction of the new electronic notes system, eSASH, adversely affected rates of correct line documentation within the ICU (see Fig. 1). Rates of correctly documented arterial lines marginally improved following the intervention but there was minimal impact on CVC documentation. Overall, documentation appears to have significantly deteriorated following the implementation of eSASH even in spite of the intervention.

Documentation of invasive catheterisation must be improved and this may require systematic changes in the structure of the electronic system, such as simplifying the method and template for line insertion. This study is limited by small sample size and the retrospective nature of the initial phase. Further work will be done on education and reviewing the barriers to correct documentation.

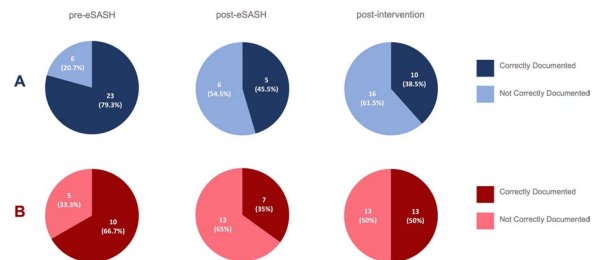

Figure 1 (abstract 000175) Pie Charts to show the number of correctly vs not correctly documented CVCs (A) and Arterial Lines (B) before and after implementation of eSASH and following our intervention. Percentages included in brackets (%)

References

1. Quan, K. A., Cousins, S. M., Porter, D. D., O'Brien M., Rudkin, S., Lambertson, B., Hoang, D., Dangodara, A. A., Huang S. S. (2016) Electronic health record solutions to reduce line-associated blood stream infections by enhancing documentation of central line insertion practices, line days and daily necessity. *American Journal of Infection Control* 44(4), 438–443
2. The author(s) received no grants for this project.

Topic: Cardiovascular issues in ICU.

000178

How patient sex affects alarm management in intensive care units—a retrospective observational study

A. R. Flint¹, D. von Wedel², A. Chaoui¹, M. Prendke¹, K. Rubarth¹, F. Balzer¹, A. S. Poncette¹

¹Institute of Medical Informatics, Charité-Universitätsmedizin Berlin, Berlin, Germany; ²Department of Anesthesia, Critical Care, and Pain Medicine, Beth Israel Deaconess Medical Center, Harvard Medical School, Boston, United States of America

Correspondence: A.R. Flint

Intensive Care Medicine Experimental 2023, **11(Suppl 1)**:000178

Introduction. Monitoring vital functions is an essential part of intensive care: alarm systems identify deteriorating patients and can trigger life-saving alarm reactions. Previous research suggested that patient characteristics influence alarm loads, with higher alarm loads being observed in male patients [1]. At comparable disease severity, women are admitted to the intensive care unit (ICU) less frequently and experience higher mortality rates than men [2,3]. Whether differences in alarm loads between male and female patients translate into differences in alarm management has not been studied.

Objectives. We sought to assess the impact of patient sex on health-care providers' reaction to ICU alarms.

Methods. Following IRB approval (Ethics vote no. EA1/127/18), this retrospective analysis included adult patients admitted to a German ICU between July 2019 and June 2021, who stayed at least 24 h, with annotated alarm data [3]. Blood pressure, heart rate, and oxygen saturation alarms were assessed in this study. Alarms were classified as actionable and non-actionable, with alarms triggering a medical intervention being defined as actionable. To account for age-related differences in alarm loads and actionable rates, we stratified patients by age (decade of life). Primary outcome was the average number of actionable alarms per sex per age group. The secondary outcome was the average number of alarms per sex per age group, independently of actionable rates. We compared both outcomes in terms of the patient's biological sex, as obtained from the medical record. Due to extremely high numbers of alarms per patient and in total, no hypothesis testing is applied. We present descriptive results.

Results. In our cohort of 976 patients, the total number of alarms was 1,226,079 with 18,077 monitored days. Female patients made up 40.3% of the cohort and were responsible for 36% of total alarms. Cohort sizes and monitoring days increased with age for both sexes (Fig. 1). The median number of alarms per monitored patient day was 93.3 [1st qt: 55.8, 3rd qt: 149.6]. In comparison, the female median of generated total alarms with 89.4 was lower than the male one with 96.1 alarms [female: 1st qt: 53.8, 3rd qt: 145.5; male: 1st qt: 56.5, 3rd qt: 152.4]. The average alarm actionable rate per patient was 12.8% [SD 10.0%]. Average actionable rates for the entire female patient cohort were lower [female: 12.6% mean, SD 9.5%; male: 13.0% mean, SD 9.8%]. When assessed individually, average actionable rates for alarm types for blood pressure [13.6% female; 14.1% male] and oxygen saturation alarms [13.7% female; 13.9% male] were higher than the average actionable rate for heart rate alarms [11.6% female; 10.4% male]. In an inter patient sex comparison, females had lower average actionable rates for blood pressure and oxygen saturation, but higher rates for heart rate alarms.

Conclusions. This study is the first to investigate the influence of patient sex on ICU providers' alarm reactions. In this descriptive analysis, we did not find large differences in actionable rates and alarm loads between female and male patients. Further research should focus on inter age group relationships—investigating the effects of alarm threshold settings and other pathophysiological factors, such as disease severity and patient comorbidities. This could pave the way towards more informed ICU alarm adjustments.

monitored days] and total actionable rate in percent (across all alarm types)

References

- INALO project (grant 16SV8559, German Federal Ministry of Education and Research)
- [2] Todorov A, Kaufmann F, Arslani K, Haider A, Bengs S, Goliash G, Zellweger N, Tontsch J, Sutter R, Buddeberg B, Hollinger A, Zemp E, Kaufmann M, Siegemund M, Gebhard C, Gebhard CE; Swiss Society of Intensive Care Medicine. Gender differences in the provision of intensive care: a Bayesian approach. *Intensive Care Med.* 2021 May;47(5):577–587. <https://doi.org/10.1007/s00134-021-06393-3>. Epub 2021 Apr 21. PMID: 33884452; PMCID: PMC8139895.
- [3] Lat TI, McGraw MK, White HD. Gender Differences in Critical Illness and Critical Care Research. *Clin Chest Med.* 2021 Sep;42(3):543–555. <https://doi.org/10.1016/j.ccm.2021.04.012>. PMID: 34353458; PMCID: PMC8328243.
- [4] Klopfenstein SAI, Flint AR, Heeren P et al. How to Annotate Patient Monitoring Alarms in Intensive Care Medicine for Machine Learning, 14 February 2023, PREPRINT (Version 1) available at Research Square [<https://doi.org/10.21203/rs.3.rs-2514969/v1>]. Accessed 11/04/2023
- [1] Sinno ZC, Shay D, Kruppa J, Klopfenstein SAI, Giesa N, Flint AR, Herren P, Scheibe F, Spies C, Hinrichs C, Winter A, Balzer F, Poncette AS. The influence of patient characteristics on the alarm rate in intensive care units: a retrospective cohort study. *Sci Rep.* 2022 Dec 16;12(1):21801. <https://doi.org/10.1038/s41598-022-26261-4>. PMID: 36526892; PMCID: PMC9758124.

Topic: Cardiac arrest.

000180

Does hemoperfusion with Seraph-100 improve survival prognosis in patients with severe covid?

E. Bustamante-Munguira¹, A. Francisco Amador¹, M. Artola Blanco¹, N. Mamolar Herrera¹, M. Bustamante-Munguira², C. Abad Molina³, M. A. De Pedro Sanchez¹, M. I. Acosta², R. Cicuendez⁴, A. Coca Rojo²
¹Intensive care, University Clinical Hospital of Valladolid, Valladolid, Spain;
²Nephrology, University Clinical Hospital of Valladolid, Valladolid, Spain;
³Immunology, University Clinical Hospital of Valladolid, Valladolid, Spain;
⁴Intensive care unit, University Clinical Hospital of Valladolid, Valladolid, Spain

Correspondence: E. Bustamante-Munguira
Intensive Care Medicine Experimental 2023, **11(Suppl 1):000180**

Introduction. Seraph-100 Microbind Affinity Blood Filter (ExThera Medical) is an extracorporeal hemoperfusion device designed to treat bloodstream infections. The filter membrane can bind bacterial and viral pathogens, increasing their elimination and reducing bacterial and viral blood titers. The device received an authorization for emergency use in critically ill patients with COVID-19 by the FDA. We aimed to summarize the efficacy and safety profile of the device in a consecutive sample of COVID-19 ICU patients.

Methods. Data was gathered from a sample of 26 consecutive COVID-19 patients that were admitted in the ICU of our hospital between November 2021 and February 2022. Eleven patients received treatment with Seraph-100 plus standard care. The control group was composed of subjects that received only standard care. Patients treated with Seraph received only a single hemoperfusion treatment. Clinical and analytical parameters, coinfections and mortality rates were compared between groups.

Results. We found no significant differences between groups regarding age, sex or comorbidities (Table 1). Treatment with Seraph was generally well tolerated. We observed no significant modifications of leukocyte cell count or C-reactive protein levels associated with

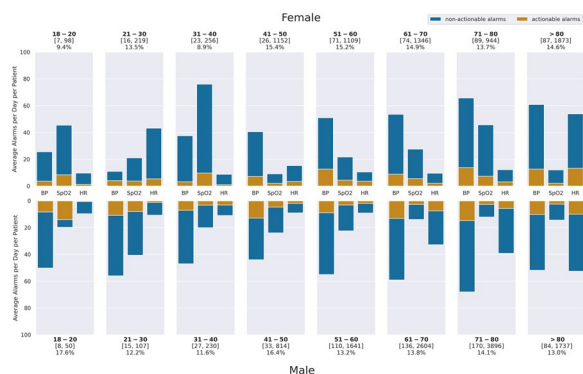

Figure 1 (abstract 000178) Distribution of actionable and non-actionable alarms in female versus male patients, stratified by life-decade. Alarm types: blood pressure (BP), oxygen saturation (SpO2), and heart rate (HR). Per age group and patient sex: [Number of patients,

Seraph-100 treatment. In addition, no differences regarding in-hospital mortality (Table 1 and Graphic 1) or length of ICU stay were observed, although patients treated with Seraph suffered less frequently cases of Gram-positive bacteria associated pneumonia.

Conclusions. In this case series, hemoperfusion with Seraph-100 was not associated with improved survival or shorter ICU stay. However, these results may be due to the small sample size and high heterogeneity present in key clinical parameters, such as COVID-19 severity, development of other clinical complications or length of ICU stay at the time of administration of therapy, as well as the duration or dose of hemoperfusion. To adequately standardize the use of this innovative therapy in It is necessary to analyze the most appropriate timing and dose for each patient profile.

	Treated with Seraph	Control Group	P value
N	12	14	
Age, years	60 (50-73)	68 (58-76)	0,584
Male sex, n (%)	8 (72,7)	11 (78,6)	0,734
Hypertension, n (%)	8 (72,7)	7 (50)	0,25
Diabetes, n (%)	4 (36,4)	4 (28,6)	0,678
Ischemic heart disease, n (%)	0 (0)	0 (0)	-
COPD, n (%)	1 (9,1)	1 (7,1)	0,859
CKD, n (%)	0 (0)	1 (7,1)	0,366
Previous solid organ transplant, n (%)	0 (0)	0 (0)	-
Cancer, n (%)	2 (10,1)	1 (7,1)	0,859
Hemoperfusion only, n (%)	7 (63,6)	-	-
Expected treatment duration >300 min, n (%)	2 (18,2)	-	-
Seraph-associated hypotension, n (%)	3 (27,3)	-	-
Blood line or circuit clotting, n (%)	2 (18,2)	-	-
Premature end of treatment, n (%)	2 (18,2)	-	-
Average change in systolic blood pressure, mmHg	0 (-10-12,5)	-	-
Average change in diastolic blood pressure, mmHg	0 (-7,5-15)	-	-
Average change in leukocytes, cells/mm³	4990 (880-7555)	-	-
Average change in C-reactive protein, mg/L	-7,4(-44,5-14,6)	-	-
Gram positive bacterial pneumonia, n (%)	5 (45,5)	13 (92,9)	0,009
Stage 3 AKI, n (%)	1 (9,1)	1 (7,1)	0,859
ICU stay, days	19 (11-94)	16 (4-34)	0,255
In-hospital death, n (%)	6 (54,5)	6 (42,9)	0,561

Comorbidities.

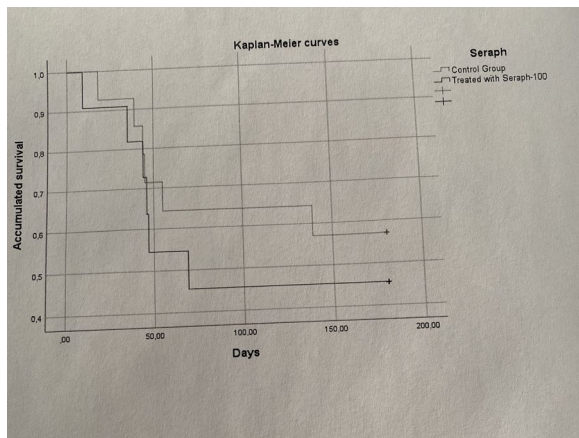

Hospital mortality.

References

1. None.

Topic: Sepsis.

000186

Exosomes derived from endothelial progenitor cells rescue Lipopolysaccharide-induced human brain microvascular endothelial cell injury via miR-126a-5p

B. Jia¹, H. Zhang¹

¹The Fourth Clinical Medical College, Faculty of Medicine, Nanchang University, Nanchang, China

Correspondence: H. Zhang

Intensive Care Medicine Experimental 2023, **11(Suppl 1)**:000186

Introduction. Sepsis is a potentially life-threatening complication of infection and one of the most intractable medical syndromes, accompanied by severe vascular endothelial injury, which is featured increased vascular permeability and the massive release of inflammatory mediators. During sepsis, endothelial cells (ECs) undergo multiple phenotypic and functional modifications, which are initially adaptive but eventually become harmful, leading to microvascular dysfunction. Thus, therapies that mitigate local inflammatory cytokine release could reduce the severity of ECs injury and improve patient outcomes. Endothelial progenitor cells (EPCs) are mobilized and migrate into the circulation from the bone marrow. A close association has been identified between the maintenance of endothelial structure and function by EPCs and their ability to differentiate and repair damaged endothelial tissue. EPCs mediate the process of re-endothelialization after vascular injury in multiple steps, including mobilization, chemotaxis, homing, proliferation, and differentiation. It has been shown that the process of endothelialization and angiogenesis after the endothelial injury is affected by EPCs. Our previous work found that EPCs from bone marrow transplantation promote neovascularization in the ischemic hind limbs of mice.

Exosomes are 30-150nm membrane vesicles recognized as a vehicle for modulating the function of recipient cells through the delivery of proteins, RNA, microRNAs, and other molecular constituents. They exchange their cargo with the endothelial cells of the target organ, opening new horizons for therapeutic application. Recent preclinical and clinical studies have shown that EPCs-EXOs have a beneficial therapeutic effect on various diseases, including cardiovascular diseases and kidney and lung disorders. However, there remains a research gap to fully understand the therapeutic potential of EPCs-Exos on the endothelium in sepsis. Based on that, a LPS induced septic model of Human Brain Microvascular Endothelial Cells (HB-ECs) was established to investigate the roles of EPCs-EXOs and miR-126 in sepsis-induced endothelium injury.

Objectives. EPCs play a crucial role in maintaining vascular homeostasis and facilitating vascular repair by releasing paracrine mediators such as exosomes, especially its bio-active molecules miRNAs. However, the effects of EPCs-EXOs on lipopolysaccharide(LPS)-induced endothelial cell injury are still unknown. To determine if EPCs-EXOs benefit LPS-induced endothelial cell injury and its underlying mechanism.

Methods. Methods: EPCs were isolated from peripheral blood in mice and identified by flow cytometry and immunocytochemistry. Exosomes extracted from EPCs were determined by transmission electron microscope and western blot. The HB-ECs were randomly

divided into five groups: control group (HB-ECs control), LPS group (HB-ECs + LPS), EPC group (HB-ECs + LPS + EPC), EPCs-EXOs group (HB-ECs + LPS + EPCs-EXOs), and GW4869 group (HB-ECs + LPS + EPC-EXOs + GW4869). GW4869, the exosome inhibitor, was added one hour before LPS treatment in the co-culture of HB-ECs and EPCs-EXOs. HB-ECs proliferation, cytokine secretion, apoptosis, tube forming, sprouting capacities, and miR-126a-5p expression were examined in each group at different coculture time.

Results. Compared to the control group, inflammation was induced in the LPS group by increasing cytokines and chemokines, including TNF- α , IL-6, and Caspase 3. EPCs-EXOs group show that EPCs-EXOs suppressed the increased secretion of LPS-induced cytokines at the 20th hour after coculture. The flow cytometry results showed that LPS significantly induced the apoptosis of HB-ECs. Still, it decreased after being co-cultured with EPCs or EPCs-EXOs, and the protective effect was antagonised by GW4869 significantly. In addition, microscopic image results showed that HB-ECs sprouting and tube formation were visible after 5 h of implantation. In contrast, LPS reduced tubule formation and budding, but EPCs or EPCs-Exo reversed this reduction. RT-PCR showed that LPS decreased the miR-126 RNA level, the EPCs-EXOs exhibited robust protective effects via reversing miR-126 RNA level.

Conclusions. Exosomes derived from EPCs in mice protect against LPS-induced HB-ECs injury, promote angiogenesis, antagonize apoptosis and inhibit inflammation in part due to the increased expression of miR-126a-5p.

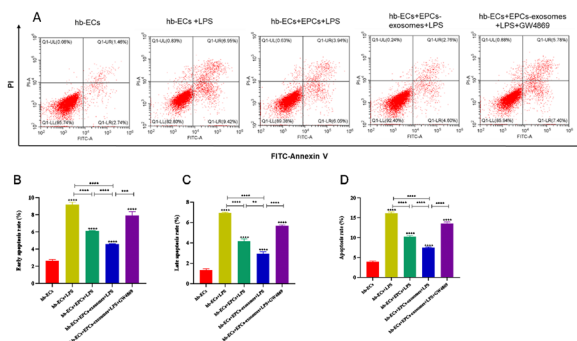

Figure 4 (abstract 000186) Flow cytometric analysis; B. Early apoptosis cells; C. Late apoptosis cells; D. Total apoptosis rate

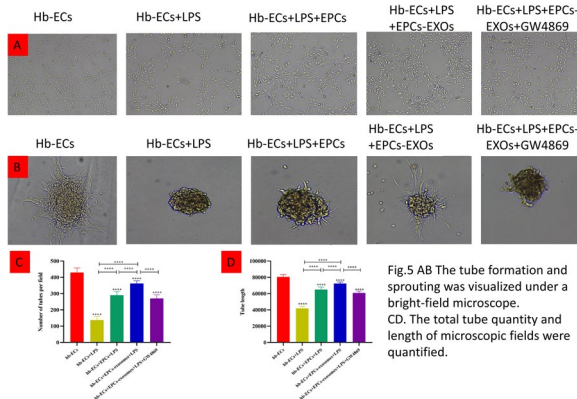

Figure 5 (abstract 000186) AB The tube formation and sprouting was visualized under a bright-field microscope. CD. The total tube quantity and length of microscopic fields were quantified

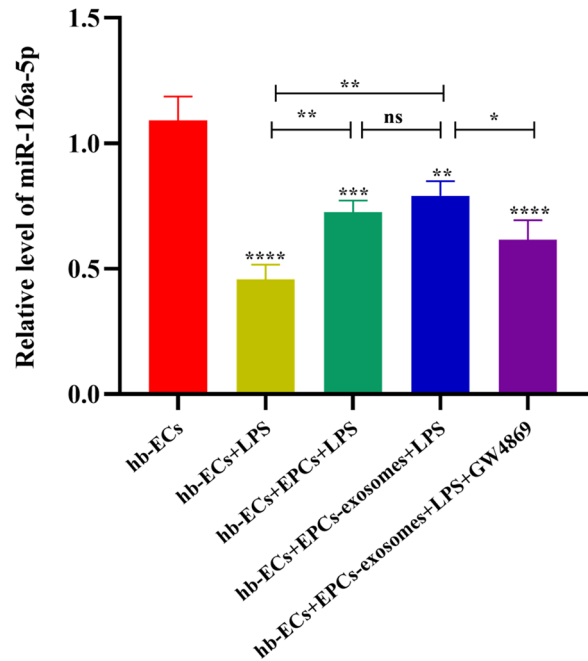

Figure 6 (abstract 000186) miR-126a-5p expression in each group

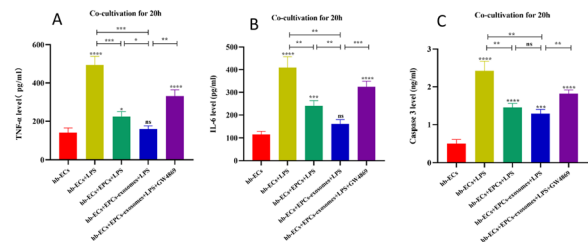

Figure 3 (abstract 000186) Protective effects of EPC exosomes in LPS-induced inflammation

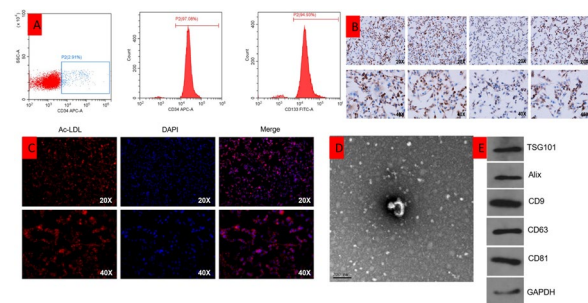

Figure 1 (abstract 000186) Isolation and identification of EPCs and EPCs-EXOs. A cell surface markers of EPCs. B EPCs marker factor. C EPCs uptake Ac-LDL could be visualized (red). DAPI was used to stain the nucleus (blue). D Morphology of EPCs-EXO by transmission electron microscopy. Scale bar: 200 nm. E The expression of Exo-specific surface proteins

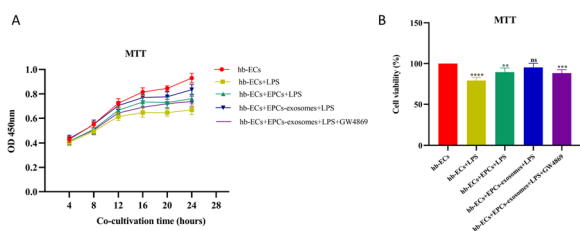

Figure 2 (abstract 000186) MTT analysis of exosomes derived from EPCs in promoting HB-ECs proliferation under set condition ($p < 0.01$ vs. control group, ** $P < 0.001$ and **** $P < 0.001$)

References

- Zhang X, Lu A, Li Z, Sun J, Dai D, Qian L. Exosomes secreted by endothelial progenitor cells improve the bioactivity of pulmonary microvascular endothelial cells exposed to hyperoxia in vitro. *Ann Transl Med.* 2019 Jun;7(12):254. <https://doi.org/10.21037/atm>.
- The authors gratefully acknowledge the financial support. This study is supported by the National Natural Science Foundation of China (grant No. 81760353). The authors also acknowledge Yixin Liu for help with language editing and figure artwork.
- Isaac R, Reis FCG, Ying W, Olefsky JM. Exosomes as mediators of intercellular crosstalk in metabolism. *Cell Metab.* 2021 Sep 7;33(9):1744–1762. <https://doi.org/10.1016/j.cmet>.
- Pan J, Wu T, Chen B, Wu H. Exosomes derived from endothelial progenitor cells ameliorate glyoxylate deprivation (OGD)-induced neuronal apoptosis by delivering miR-221-3p. *Histol Histopathol.* 2022 Oct 3;18,528. <https://doi.org/10.14670/HH-18-528>.
- Sun R, Huang J, Sun B. Mobilization of endothelial progenitor cells in sepsis. *Inflamm Res.* 2020 Jan;69(1):1–9. <https://doi.org/10.1007/s00011-019-01299-9>.
- Yeh CL, Pai MH, Shih YM, Shih JM, Yeh SL. Intravenous Arginine Administration Promotes Proangiogenic Cells Mobilization and Attenuates Lung Injury in Mice with Polymicrobial Sepsis. *Nutrients.* 2017 May 17;9(5). <https://doi.org/10.3390/nu9050507>.
- Peyter AC, Armengaud JB, Guillot E, Zydorczyk C. Endothelial Progenitor Cells Dysfunctions and Cardiometabolic Disorders: From Mechanisms to Therapeutic Approaches. *Int J Mol Sci.* 2021 Jun 22;22(13). <https://doi.org/10.3390/ijms22136667>.
- Joffre J, Hellman J. Oxidative Stress and Endothelial Dysfunction in Sepsis and Acute Inflammation. *Antioxid Redox Signal.* 2021 Nov 20;35(15):1291–1307. <https://doi.org/10.1089/ars.2021.0027>.
- Angus DC, van der Poll T. Severe sepsis and septic shock. *N Engl J Med.* 2013 Nov 21;369(21):2063. <https://doi.org/10.1056/NEJMc1312359>.
- Wei S, Gao Y, Dai X, Fu W, Cai S, Fang H, Zeng Z, Chen Z. SIRT1-mediated HMGB1 deacetylation suppresses sepsis-associated acute kidney injury. *Am J Physiol Renal Physiol.* 2019 Jan 1;316(1):F20–F31. <https://doi.org/10.1152/ajprenal.00119>.
- Youn YJ, Shrestha S, Lee YB, Kim JK, Lee JH, Hur K, Mali NM, Nam SW, Kim SH, Lee S, Song DK, Jin HK, Bae JS, Hong CW. Neutrophil-derived trail is a proinflammatory subtype of neutrophil-derived extracellular vesicles. *Theranostics.* 2021;11(6):2770–2787. <https://doi.org/10.7150/thno.51756>.

Topic: Sepsis.

000188

Efficacy of early and high-dose intravenous vitamin C in sepsis: preclinical study

H. J. Lee¹, O. H. Kim¹, M. S. Baek², T. W. Kim², W. Y. Kim²

¹Department of Anatomy and Cell Biology, Chung-Ang University College of Medicine, Seoul, Republic of Korea; ²Department of Internal Medicine, Chung-Ang University Hospital, Seoul, Republic of Korea

Correspondence: W.Y. Kim

Intensive Care Medicine Experimental 2023, 11(Suppl 1):000188

Introduction. Vitamin C has pleiotropic mechanisms of action that target multiple pathogenic pathways in sepsis. However, the effects of vitamin C on clinical outcomes of septic patients have been inconsistent among previous randomized trials [1, 2]. A recent randomized trial even showed a higher risk of death or persistent organ dysfunction in those who received vitamin C [3]. However, these trials may have been limited by delayed initiation and insufficient dosage of vitamin C.

Objectives. To assess the efficacy of early and high-dose intravenous vitamin C in a murine model of sepsis.

Methods. Sepsis was induced using the cecal ligation and puncture (CLP) model with fluid resuscitation and antibiotic therapy. Mice were randomized for treatment with intravenous vitamin C (45 mg/kg) or vehicle given 1 h after CLP in the early group and 6 h after CLP in the late group. The treatment continued every 12 h for 4 days for a total of 8 doses. To assess the synergistic effects of early and high-dose vitamin C, mice were additionally randomized for treatment with vitamin C (90 mg/kg) given 1 h after CLP in the early group. Serum inflammatory biomarker (interleukin-6 [IL-6]) was measured 24 h after CLP in the early group and 6 h after CLP in the late group. The Murine Sepsis Score (MSS) [4] was used to assess the severity of sepsis 24 h after CLP in both groups. Moreover, time-dependent IL-6 level was measured by collecting blood samples on 1, 6, 12, 24, 48, and 72 h after CLP in a separate model.

Results. In the late group, vitamin C did not increase survival compared to vehicle (median [IQR] survival time, 24 [18–78] h vs 108 [24–180] h; $p = 0.29$, log-rank test). In the early group, low-dose vitamin C did not increase survival compared to vehicle (median [IQR] survival time, 60 [24–180] h vs 72 [36–192] h; $p = 0.27$, log-rank test), while high-dose non-significantly increased survival compared to vehicle (median [IQR] survival time, 150 [36–192] h vs 72 [36–192] h; $p = 0.31$, log-rank test). In the late group, the mean (SEM) serum IL-6 level was non-significantly higher in the vitamin C-treated mice than in the vehicle-treated mice (49.1 [19.0] ng/ml vs 13.7 [4.6] ng/ml; $p = 0.09$, one-way ANOVA). The mean (SEM) serum IL-6 level was elevated after CLP in the early group, but this was not significantly decreased with low-dose or high-dose vitamin C (23.3 [6.5] ng/ml vs 28.6 [6.3] ng/ml vs 26.9 [7.0] ng/ml; $p = 0.84$, one-way ANOVA). Consistent findings were found for MSS in both groups. When only living mice were analyzed up to 72 h, the serum IL-6 levels peaked at 6 h after CLP and gradually decreased until 24 h ($p < 0.05$, one-way ANOVA with Tukey's multiple comparison test).

Conclusions. In our study, late intravenous vitamin C did not increase survival but showed a proinflammatory effect in CLP-induced sepsis. Conversely, early and high-dose vitamin C tended to increase survival. The IL-6 profile within 24 h of CLP should be further assessed in the early group.

References

- Assouline B, Faivre A, Verissimo T, Sangla F, Berchtold L, Giraud R et al. (2021) Thiamine, ascorbic acid, and hydrocortisone as a metabolic resuscitation cocktail in sepsis: a meta-analysis of randomized controlled trials with trial sequential analysis. *Crit Care Med* 49:2112–2120
- Sato R, Hasegawa D, Prasitlumkum N, Ueoka M, Nishida K, Takahashi K et al. (2021) Effect of IV high-dose vitamin C on mortality in patients with sepsis: a systematic review and meta-analysis of randomized controlled trials. *Crit Care Med* 49:2121–2130
- Lamontagne F, Masse MH, Menard J, Sprague S, Pinto R, Heyland DK et al. (2022) Intravenous vitamin C in adults with sepsis in the intensive care unit. *N Engl J Med* 386:2387–2398
- This research was supported by the National Research Foundation of Korea grant funded by the Korea government (Ministry of Science, ICT & Future Planning) (2022R1F1A1067609).

Topic: Sepsis.

000191

Effect of ventilator ratio on day 7 after ventilator care on 90-day mortality in patients with ARDS: a single-center study in Korea

W. Yoo¹, K. Lee²

¹pulmonary, national university, Busan, Republic of Korea; ²Department of internal medicine, Pusan National University Hospital, Busan, South Korea, Republic of Korea

Correspondence: W. Yoo

Intensive Care Medicine Experimental 2023, 11(Suppl 1):000191

Introduction. Ventilatory ratio (VR) is an index of impaired ventilation and has been reported as a prognostic factor in patients with acute respiratory distress syndrome (ARDS) requiring mechanical ventilation (MV). Few studies have investigated the effect of VR on mortality in ARDS patients requiring MV more than 7 days. The aim of our study was to investigate the relationship between VR on day 7 after MV and 90-day mortality.

Methods. Data from 131 patients (male, 67.9%, mean age 70.1 ± 11.0 years; 90-day mortality rate, 46.6%) who were hospitalized in a respiratory intensive care unit were retrospectively analyzed over 10 years. The relationships between VR with 90-day mortality were tested by logistic regression analysis.

Results. Of total enrolled patients, patients (n = 50) with VR ≥ 1.8 (cut-off level based on Youden's index) on day 7, 90-day mortality rate was significantly higher than dose of VR < 1.8 (64.0% vs 35.8%, p = 0.002). This cut-off level was associated with significantly higher 90-day mortality [odds ratio (OR), 2.873; 95% confidence interval [CI], 1.238–6.666; p = 0.014] based on multivariate logistic regression analysis. In patients without tracheostomy during hospital stay (n = 71), their 90-day mortality was significantly higher (57.7% vs 33.3%; p < 0.001) than those with tracheostomy. Also, their cut-off level of VR on day 7 was 2.2 (based on Youden's index), which was associated with higher 90-day mortality (OR 6.254, 95% CI 1.228–31.850; p = 0.027) based on multivariate analysis.

Conclusions. Higher VR on day 7 was associated with 90-day mortality in ARDS patients requiring MV more than 7 days. The cut-off level of VR was according to tracheostomy.

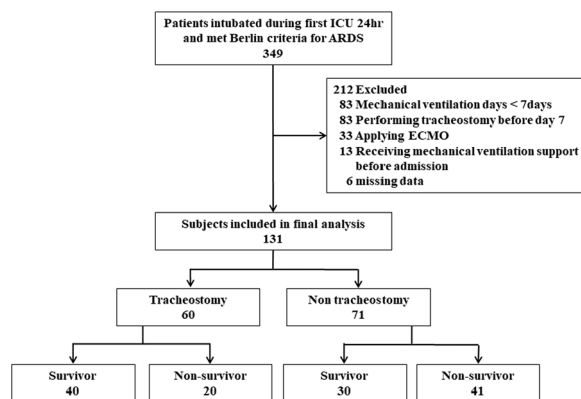

Figure 1 (abstract 000191) Flowchart of patient screening and enrollment. A total of 349 patients were followed-up until day-90. ECMO: Extracorporeal membrane oxygenation

Table 1 (abstract 000191) Demographic and clinical characteristics of patients that received invasive mechanical ventilation above 7 days

	All patients (n=131)	Survivors (n=70)	Non-survivors (n=61)	p-value
Male, n (%)	89 (67.9)	46 (65.7)	43 (70.5)	0.359
Age, median (range), years	72 (30-87)	69 (30-87)	75 (34-86)	0.014
Age ≥ 65, n (%)	100 (76.3)	48 (68.6)	52 (85.2)	0.025
BMI, kg/m ² , median (range)	23.4 (14.2-37.6)	23.4 (14.2-37.6)	23.7 (14.5-34.3)	0.753
BMI ≤ 18.5, n (%)	10 (7.6)	7 (10)	3 (4.9)	0.275
APACHE II score*, median (range)	19 (7-38)	16 (7-34)	20 (10-38)	0.982
SOFA score*, median (range)	8 (2-17)	8 (2-17)	8 (2-17)	0.780
Charlson's comorbidity index, median (range)	2 (0-7)	2 (0-6)	3 (0-7)	0.655
ARDS category, n (%)				
Mild	14 (10.7)	10 (14.3)	4 (6.6)	0.079
Moderate	73 (55.7)	42 (60)	31 (50.8)	0.276
Severe	44 (33.6)	18 (25.7)	26 (42.6)	0.176
CRP, median (range), mg/dL	11.6 (0.8-51.0)	11.9 (0.9-51.0)	11.6 (0.8-38.1)	0.402
Lactate, median (range), mg/dL	2.0 (0.5-15.0)	1.8 (0.6-12.6)	2.0 (0.5-15.0)	0.780
Lactate ≥ 2.0 mmol/L, n (%)	66 (50.4)	32 (45.7)	34 (55.7)	0.252
Comorbidities, n (%)				
Diabetes mellitus	59 (45.0)	26 (37.1)	33 (54.1)	0.052
Chronic cardiac disease	83 (63.4)	42 (60)	41 (67.2)	0.393
Chronic respiratory disease	39 (29.8)	23 (32.9)	16 (26.2)	0.408
Chronic kidney disease	24 (18.3)	9 (12.9)	15 (24.6)	0.083
Chronic liver disease	8 (6.1)	5 (7.1)	3 (4.9)	0.596
Chronic biliary disease	5 (3.8)	1 (1.4)	4 (6.6)	0.126
Cerebrovascular disease	39 (29.8)	24 (34.3)	15 (24.6)	0.226
Hematologic/oncologic disease	27 (20.6)	10 (14.3)	17 (27.9)	0.055
PaO ₂ /FiO ₂ ratio, median (range), mmHg				
PaO ₂ /FiO ₂ ratio day 1	155.6 (63.0-527.5)	196.5 (72.0-527.5)	140 (63.0-397.5)	< 0.001
PaO ₂ /FiO ₂ ratio day 7	220.0 (49.0-488.0)	246.8 (101.4-473.3)	168.6 (49.0-488.0)	0.863
Ventilator ratio, median (range)				
Ventilator ratio day 1	1.77 (0.89-5.75)	1.66 (0.93-5.75)	1.83 (0.87-4.46)	0.273
Ventilator ratio day 7	1.62 (0.84-4.18)	1.51 (0.84-4.18)	1.83 (0.88-3.73)	0.033

Normally distributed continuous variables are reported as mean ± standard deviation (SD), non-normally distributed continuous variables are reported as median (IQR), and categorical variables are reported as number (%).

Abbreviations: BMI, body mass index; APACHE II, Acute Physiology and Chronic Health Evaluation II; SOFA, Sequential Organ Failure Assessment; ARDS, acute respiratory distress syndrome; CRP, C-reactive protein.

Table 2 (abstract 000191) Univariate and multivariate analysis of factors associated with 90-day mortality in all patients and patients with no tracheostomy

	Univariate analysis			Multivariate analysis		
	Odds ratio	95% CI	p-value	Odds ratio	95% CI	p-value
All patients						
PaO ₂ /FiO ₂ ratio on day 7 ≤ 150*	5.447	2.134-13.903	< 0.001	5.190	1.912-14.087	0.001
RRT on day 7	3.521	1.176-10.543	0.024	6.484	1.980-21.235	0.002
Ventilator ratio on day 7 ≥ 1.8**	3.188	1.529-6.646	0.002	2.984	1.309-6.801	0.009
Age ≥ 65	2.648	1.110-6.315	0.028			
Hematologic/oncologic disease	2.318	0.969-5.548	0.059			
Diabetes mellitus	1.995	0.991-4.013	0.053			
Thrombocytopenia on day 7	1.984	0.882-4.460	0.098			
Patients without tracheostomy						
Age ≥ 65	3.889	1.253-12.074	0.019	3.759	1.001-14.115	0.050
PaO ₂ /FiO ₂ ratio on day 7 ≤ 150	5.614	1.660-18.987	0.006			
Ventilator ratio on day 7 ≥ 2.2	7.259	1.506-35.000	0.014	6.254	1.228-31.850	0.027
Thrombocytopenia on day 7	4.179	1.070-16.316	0.040	6.159	1.380-27.479	0.017
Diabetes mellitus	2.344	0.895-6.139	0.083			

References

- Maj R, Palermo P, Gattarello S, Brusatori S, D'Albo R, Zinnato C, Velati M, Romitti F, Busana M, Wieditz J, Herrmann P, Moerer O, Quintel M, Meissner K, Sanderson B, Chiumello D, Marini JJ, Camporota L, Gattinoni L, (2023) Ventilatory ratio, dead space, and venous admixture in patients with acute respiratory distress syndrome. Br J Anaesth 130: 360–367
- Monteiro ACC, Vangala S, Wick KD, Delucchi KL, Siegel ER, Thompson BT, Liu KD, Sapru A, Sinha P, Matthey MA, Network NP, (2022) The prognostic value of early measures of the ventilatory ratio in the ARDS ROSE trial. Crit Care 26: 297

- Siegel ER, Zhuo H, Sinha P, Papolos AI, Ni SA, Vessel K, Belzer A, Minus EB, Calfee CS, Matthay MA, Wick KD, (2022) Ventilatory Ratio Is a Valuable Prognostic Indicator in an Observational Cohort of Patients With ARDS. *Respir Care* 67: 1075–1081
- Yang Y, Chi Y, Yuan S, Zhang Q, Su L, Long Y, He H, (2022) The relationship between ventilatory ratio (VR) and 28-day hospital mortality by restricted cubic splines (RCS) in 14,328 mechanically ventilated ICU patients. *BMC Pulm Med* 22: 229
- Torres A, Motos A, Riera J, Fernandez-Barat L, Ceccato A, Perez-Arnal R, Garcia-Gasulla D, Penuelas O, Lorente JA, Rodriguez A, de Gonzalo-Calvo D, Almansa R, Gabarrus A, Menendez R, Bermejo-Martin JF, Ferrer R, Amaya Villar R, Anon JM, Barbera C, Barberan J, Blandino Ortiz A, Bustamante-Munguira E, Caballero J, Carbajales C, Carbonell N, Catalan-Gonzalez M, Galban C, Gumucio-Sanguino VD, de la Torre MDC, Diaz E, Estella A, Gallego E, Garcia Garmendia JL, Garnacho-Montero J, Gomez JM, Huerta A, Jorge Garcia RN, Loza-Vazquez A, Marin-Corral J, Martinez de la Gandara A, Martinez Varela I, Lopez Messa J, G MA, Novo MA, Penasco Y, Pozo-Laderas JC, Ricart P, Salvador-Adell I, Sanchez-Miralles A, Sancho Chinesta S, Socias L, Sole-Violan J, Soares Sipmann F, Tamayo Lomas L, Trenado J, Barbe F, Project C, (2021) The evolution of the ventilatory ratio is a prognostic factor in mechanically ventilated COVID-19 ARDS patients. *Crit Care* 25: 331
- Sinha P, Calfee CS, Beitler JR, Soni N, Ho K, Matthay MA, Kallet RH, (2019) Physiologic Analysis and Clinical Performance of the Ventilatory Ratio in Acute Respiratory Distress Syndrome. *Am J Respir Crit Care Med* 199: 333–341
- Sinha P, Fauvel NJ, Singh S, Soni N, (2009) Ventilatory ratio: a simple bedside measure of ventilation. *Br J Anaesth* 102: 692–697
- This work was supported by clinical research grant from Pusan National University Hospital.

Topic: Acute respiratory failure and mechanical ventilation.

000196

Epidemiology and its results in hip fractures followed in postoperative intensive care

C. Balci¹, E. Yildiz², T. Murat Emre², Y. Ayşe¹, A. Ozlem³, H. İ. Yildiz⁴

¹Anaesthesiology and Reanimation, Healty Science Un., Kütahya, Turkey;

²Anaesthesiology and Reanimation, Healty Science Un, Kütahya, Turkey;

³Biostatistics, Kütahya Sağlık Bilimleri Üniversitesi, Kütahya, Turkey;

⁴Orthopedics and Traumatology, Parkhayat Hospital, Kütahya, Turkey

Correspondence: C. Balci

Intensive Care Medicine Experimental 2023, **11(Suppl 1)**:000196

Introduction. Hip fractures are one of the leading injuries in the elderly population all over the world. Although there are many current discussions about the use of intensive care to improve postoperative care of patients with hip fractures, data on this subject are limited. Postoperative follow-up is as important as preoperative follow-up of elderly patients with hip fractures who have more than one comorbidity.

Objectives. The mortality and morbidity of elderly patients with hip fractures can be reduced by careful preoperative preparation of elderly patients, not delaying the operation, follow-up in the postoperative intensive care unit (ICU) and transferring them to the service from the ICU in a short time. For this reason, we wanted to retrospectively evaluate the outcomes of patients with hip fractures followed in the postoperative intensive care unit at 30 days, 90 days and one year mortality.

Methods. Age, gender, admission diagnosis, comorbidities, length of stay in ICU, APACHE II scores, NIM, IMV, length of stay on mechanical ventilator of 68 patients with femur fracture followed in the intensive care unit, need for inotropic support, RRT and HD requirement, blood transfusion, presence of central venous catheter, arterial catheterization status, length of stay in the intensive care unit, 30, 90-day and 1-year mortality, day of the operation and anesthesia technique performed was recorded.

Results. The approximate mean age of 68 patients included in the study was 78.52 (min: 57, max: 97). The mortality profile of the elderly patients followed in the postoperative intensive care unit at 30 days,

90 days and 1 year was calculated and found to be 34.48%-41.38% and 24.14%. There is a statistically significant difference in terms of mortality status of the patient and age, APACHE II scores, ICU length of stay and hospital stay values.

Conclusions. Among the factors affecting mortality after hip fracture in studies; age, gender, type of fracture, pre-fracture activity level of the patient, ASA score, time until surgery and anesthesia method are counted. As a result; Apart from the systemic changes due to aging, this patient group, who has an additional disease that impairs their life functions, requires careful preoperative preparation starting with hospitalization, ensuring that their co-morbidities are under control as much as possible, reviewing their nutritional status, and post-operative short-term intensive care follow-up with morbidity and mortality.

References

- Li T, Li J, Yuan L, Wu J, Jiang C, Daniels J, Mehta RL, Wang M, Yeung J, Jackson T, Melody T, Jin S, Yao Y, Wu J, Chen J, Smith FG, Lian Q; RAGA Study Effect of Regional vs General Anesthesia on Incidence of Postoperative Delirium in Older Patients Undergoing Hip Fracture Surgery: The RAGA Randomized Trial. *Investigators*. *JAMA*. 2022 Jan 4;327(1):50–58. <https://doi.org/10.1001/jama.2021.22647>.

Topic: Trauma.

000197

Heart rate variability (HRV) analysis at admission in the ICU of Covid-19 patients cannot predict intubation need: a prospective study

T. F. Fariña González¹, L. Julieta², A. Nuñez-Reiz³, V. Yordanov Zlatkov³, G. P. Veronica³, V. V. Mercedes³, M. Quintana Diaz⁴, M. E. Hernando-Perez⁵, F. Martínez-Sagasti³

¹Intensive Care, Infanta Sofia University Hospital, San Sebastián de

los Reyes, Spain; ²Anaesthesia, La Paz University Hospital, Madrid,

Spain; ³Critical care, Hospital Clínico San Carlos, Madrid, Spain;

⁴Intensive care unit, La Paz University Hospital, Madrid, Spain; ⁵School

of Telecommunications Engineering, Polytechnic University of Madrid, Madrid, Spain

Correspondence: T.F. Fariña González

Intensive Care Medicine Experimental 2023, **11(Suppl 1)**:000197

Introduction. Although Covid-19's main clinical features are related to respiratory disease, other organs are also affected directly by the virus. Neurological symptoms and syndromes are also found in the literature. Interestingly, many patients present a clinical dissociation between hypoxemia and the cardiovascular response; tachycardia or hypotension are not usually found in contrast to other severe infections. These characteristics features shall be related to the neurotropism of the virus.

Cardiovascular response to stress (such as hypoxemia) is mediated by the autonomic nervous system and heart rate variability (HRV) is an important part of it. It has been extensively studied that loss of variability is associated with poor outcomes in different diseases. HRV in Covid-19 is an actual research topic but its usefulness as a prognostic marker is yet to be defined.

Objectives. To analyse if HRV metrics could be used to identify, at admission in the ICU, those patients that were going to need mechanical ventilation during their stay.

Methods. We performed a prospective single-centre observational study. Adult patients admitted to the Hospital Clínico San Carlos ICU from February 2021 to December 2021 with confirmed SARS-CoV-2 disease but not under invasive mechanical ventilation were included. Exclusion criteria were previous history of diabetic neuropathy, history of neurologic autonomic disease, atrial fibrillation and recent (< 3 months) brain trauma.

Data was collected within 24 h from admission in spontaneous ventilation. Waveforms were continuously recorded at least for 10 min at 500 Hz during a stable sitting condition of the patient. We analyze EKG raw data, extracting RR intervals. Each recording was visually inspected, artifacts were deleted. R-R peak times were then export to R and analyze with the RHRV package. We interpolated the input data at 4 Hz.

The study protocol was approved by the local Ethics committee (CI 21/169.E).

HRV metrics were calculated as recommended by the Joint Task Force. For frequency domain metrics, we use wavelet based analysis. We also analyzed non-linear dynamics with Poincaré plots and detrended fluctuation analysis.

STATISTICAL ANALYSIS: a sample size of 21 patients was calculated. Variables were compared using non-parametrical tests. $p < 0.05$ was considered significant.

Results. 27 patients were analyzed, 55.5% of them required intubation. 73.3% of intubated patients were male and 3 patients (20%) had diabetes as a previous diagnosis. RAAS inhibitors were the more common treatments (53.3% vs 8.3%, $p = 0.019$). Betablockers were not commonly used in these patients (6.7% in intubated patients). Intubated patients had a more rapid evolution to disease as they were admitted to the hospital more precociously (5 days vs 8 days, $p = 0.007$) although the stay in the general ward previously to the ICU admission was the same (2 days, $p = 0.943$). Heart rate variability, defined by time domain metrics, was similar between groups (SDNN 29.55 vs 32.4 ms, $p = 0.981$; pNN50 0.32 vs 0.7, $p = 0.719$ and rMSSD 12.35 vs 15.25, $p = 0.981$). We found no statistical differences between intubated and non-intubated patients in frequency domain analysis: total power 339.08 vs 643.04 msec² ($p = 0.456$); normalized LF was lower (75 vs 83.67%, $p = 0.083$) and normalized HF higher (25 vs 16.32%, $p = 0.083$). Therefore, LF/HF ratio was lower in intubated patients, near statistical significance (3 vs 5.12, $p = 0.083$). Nonlinear dynamics analysis also showed no differences. SD1 and SD2 derived from Poincaré plots were similar between groups (8.73 vs 10.79, $p = 0.981$ and 41.05 vs 43.61, $p = 0.867$; respectively). DFA alpha1 was lower in intubated patients (1.22 vs 1.33, $p = 0.548$) but alpha2 was similar (1.11 vs 1.12, $p = 0.829$).

Conclusions. At ICU admission, mechanical ventilation need cannot be predicted using HRV analysis in Covid-19 patients. Although not reaching statistical significance, LF/HF ratio was lower in afterwards intubated patients. Further research is needed in order to define if this finding is related to Covid-19 pathophysiology.

	Non-intubated (n=12)	Intubated (n=15)	p
Record duration min, median (IQR)	42 (16.25-45.75)	38 (35-43)	0.581
HR beats/min, median (IQR)	80 (66.5-101)	80 (69-85)	0.829
SDNN msec, median (IQR)	32.4 (23.08-43.07)	29.55 (22.04-52.67)	0.981
SDANN msec, median (IQR)	16.67 (8.92-27.88)	17.83 (13-31.26)	0.574
pNN50, median (IQR)	0.7 (0-5.5)	0.32 (0.027-10.68)	0.719
SDSD, median (IQR)	15.26 (8.74-26.77)	12.35 (9.64-30.61)	0.981
IRRR, median (IQR)	39.32 (31.24-61.7)	39.38 (31.08-74.57)	0.792
rMSSD, median (IQR)	15.25 (8.74-26.77)	12.35 (9.64-30.61)	0.981
HRVI, median (IQR)	8.68 (6.95-14)	8.67 (6.01-16.37)	0.981
Total power msec ² , median (IQR)	643.04 (293.81-1298.98)	339.08 (205.61-961.43)	0.456
LFn %, median (IQR)	83.67 (76.64-92.22)	75 (70.5-86.6)	0.083
HF n %, median (IQR)	16.32 (7.77-23.36)	25 (13.39-29.5)	0.083
LF/HF, median (IQR)	5.12 (3.3-12)	3 (2.38-6.46)	0.083
SD1, median (IQR)	10.79 (6.18-18.93)	8.73 (6.82-21.65)	0.981
SD2, median (IQR)	43.61 (28.27-59.28)	41.05 (30.41-70.76)	0.867
SD1/SD2, median (IQR)	0.22 (0.14-0.34)	0.28 (0.18-0.42)	0.427
DFA α 1, median (IQR)	1.33 (1.08-1.47)	1.22 (0.86-1.43)	0.548
DFA α 2, median (IQR)	1.12 (1.04-1.19)	1.11 (1.05-1.19)	0.829
PSD index, median (IQR)	1.7 (1.41-2.06)	1.42 (1.01-1.81)	0.134

References

- Kamaleswaran R, Sadan O, Kandiah P, Li Q, Coopersmith CM, Buchman TG. Altered Heart Rate Variability Early in ICU Admission Differentiates Critically Ill Coronavirus Disease 2019 and All-Cause Sepsis Patients. *Critical Care Explorations*. 2021;3(12):e0570.
- Johnston BW, Barrett-Jolley R, Krige A, Welters ID. Heart rate variability: Measurement and emerging use in critical care medicine. *J Intensive Care Soc*. 2020;21(2):148–57.
- Bento L, Fonseca-Pinto R, Povoia P. Autonomic nervous system monitoring in intensive care as a prognostic tool. Systematic review. *Rev Bras Ter Intensiva*. 2017;29(4):481–9.

- Lambermont B, Davenne E, Maclot F, Delvenne P. SARS-CoV-2 in carotid body. *Intensive Care Med*. 2021 Jan 22:1–2. <https://doi.org/10.1007/s00134-021-06351-z>. Epub ahead of print.
- Eshak N, Abdelnabi M, Ball S, Elgwairi E, Creed K, Test V, Nugent K. Dysautonomia: An Overlooked Neurological Manifestation in a Critically ill COVID-19 Patient. *Am J Med Sci*. 2020 Oct;360(4):427–429. <https://doi.org/10.1016/j.amjms.2020.07.022>. Epub 2020 Jul 17.

Topic: Cardiovascular issues in ICU.

000202

Investigation of the effect of adsorbent and sepsis filtered CRRT on mortality and renal recovery in patients with acute renal failure due to septic shock in the intensive care unit

C. Balci¹, T. Murat Emre², E. Yildiz², O. Y. Kayikci³, A. Gunes¹

¹Anaesthesiology and Reanimation, Healty Science Un., Kütahya, Turkey;

²Anaesthesiology and Reanimation, Healty Science Un., Kütahya, Turkey;

³Anaesthesiology and Reanimation, Kütahya Sağlık Bilimleri Üniversitesi, Kütahya, Turkey

Correspondence: C. Balci

Intensive Care Medicine Experimental 2023, **11(Suppl 1)**:000202

Introduction. Sepsis and septic shock is a leading cause of mortality in the intensive care unit. Promising new therapies continue to be investigated for the management of septic shock. We tried to evaluate a novel Adsorbent through a retrospective evaluation of patient's data in our centre. We used it as an adjuvant therapy in our patients with septic shock due to varied causes.

Objectives. In this study, we aimed to present the effect of Adsorbent therapy, which is still being discussed in the treatment of septic shock, on renal recovery and mortality with our results.

Methods. We retrospectively analysed data of Septic shock between 2022 to 2023 had received Adsorbent (BioSkye MG350, China) as adjuvant therapy along with standard of care. Septic Shock and Septic Shock+ Adsorbent group were formed and their data were screened. We retrospectively analyzed patients admitted to ICU with sepsis between March 2022 and March 2023. Patients included in the study were diagnosed according to The Third International Consensus Definitions for Sepsis and Septic Shock (Sepsis-3). These therapy received continuous veno-venous hemodiafiltration (CVVHDF) for acute kidney injury and Adsorbent Demographic data, procalcitonin and leukocyte levels before and after therapeutic cytokine removal and duration of Adsorbent application were recorded.

Results. 2500 patients were screened in the last year. The data of 12 patients who received Adsorbent Treatment from 2500 patients were accessed. After the adsorbent treatment, the fever of the patients decreased and the need for antipyretic decreased. White blood cell and PCT values were found to be low in all patients who received adsorbent treatment. Decreases in the hourly vasopressor drug needed by the patients were detected, but it was not statistically significant. After CRRT, an increase in urine output was observed at the end of an average of 12 h, and creatinine values decreased after hours.

Conclusions. Adsorbent treatment with CRRT in patients with septic shock is thought to have a positive contribution in the treatment of septic shock. Since it was determined that this treatment was started too late in patients whose survival effect was not positive, it should be considered whether to start this treatment early. In addition, long-term discharge of patients from intensive care seems to be associated with comorbidities.

References

- Seymour CW, Liu VX, Iwashyna TJ, Brunkhorst FM, Rea TD, Scherag A, Rubenfeld G, Kahn JM, Shankar-Hari M, Singer M, Deutschman CS, Escobar GJ, Angus DC. Assessment of Clinical Criteria for Sepsis: For the Third International Consensus Definitions for Sepsis and Septic Shock (Sepsis-3). *JAMA*. 2016 Feb 23;315(8):762–74. <https://doi.org/10.1001/jama.2016.0288>.

Topic: Sepsis.

000203

Cost effectiveness of extracorporeal carbon dioxide removal (ECCO2R) in a UK healthcare system

D. Roberts¹, O. Ethgen², V. Sanjay³

¹Medical Science, Baxter Healthcare, Newbury, France; ²Economics, Serfan Innovation (Strategic Economic Research & F, Namur, Belgium; ³Health economics, Baxter Healthcare, Oxford, United Kingdom

Correspondence: D. Roberts

Intensive Care Medicine Experimental 2023, 11(Suppl 1):000203

Introduction. This study extends on the original research by Ethgen et al. (2) on the cost-effectiveness of ultra-protective lung ventilation (ULPV) strategies with extracorporeal carbon dioxide removal (ECCO2R) by applying cost analysis from a United Kingdom (UK) National Health Service (NHS) perspective.

Objectives. This economic evaluation complements existing clinical studies and value in facilitating ultra-lung protective ventilation (2).

Methods. The study utilised a decision-analytic model adapted for the UK NHS healthcare setting that tracks expected health states when ECCO2R with ULPV versus mechanical ventilation (MV) in patients with moderate ARDS in the ICU was used. Health outcomes were based on ventilation settings, duration of ventilation, length of stay in the Intensive Care Unit (ICU) and hospital, and complications associated with ECCO2R. (Table 1).

Results. Base case analysis (table 1) demonstrated ECCO2R-enabled ULPV is cost-effective compared to conventional MV by £1,133. Lifetime cost per Quality Adjusted Life Year (QALY) was £15,023 in the ECCO2R ULPV group, versus the £20,000 NICE QALY threshold. The analysis found this intervention aimed at enhancing ULPV adherence in ICU's would result in an additional 0.629 quality-adjusted life years (QALYs) per patient, with an incremental cost-effectiveness ratio (ICER) of £4,100 (– £7,664 to –£14,670) per QALY gained. Comparatively, the study found 3.086 QALYs for ULPV care and 2.457 QALYs for non-LPV care (table 1).

Sensitivity analysis showed in both short (60 days) and long terms (lifetime) that ventilated days (table 1) and the pressure support most impacted cost per QALY (Fig. 1).

Discount rate for both cost and QALYs was kept constant at 3.5% (common practice).

Conclusions. While few studies assess cost-effectiveness of MV versus ULPV with ECCO2R (2,3), this study used numerous parameters informed by the LUNG SAFE study as the primary source (1). This international study provided data on 2377 ARDS patients, including baseline characteristics, MV settings, length of stay, and survival outcomes. Limitations of the LUNG SAFE study to define the MV comparator in the analysis was plateau pressures were not monitored in 60% of ventilated ARDS patients, and a significant proportion of plateau pressure reached above 30 cm H2O. Influencing a possible overestimation of benefits associated with ECCO2R.

Despite these limitations, this study (1) still demonstrated the potential economic advantages of ULPV strategies with ECCO2R technology in managing ARDS patients within the UK NHS healthcare setting (table 1).

In conclusion, this study presents data that shows how ULPV ventilation with ECCO2R can benefit survival, provide fewer days in the ICU and hospital, and lower costs in a UK NHS. Further research is needed

to explore the long-term cost-effectiveness of ECCO2R and other ULPV strategies in the management of ARDS.

Table 1 (abstract 000203) Basecase analysis

Absolute	MV	ULPV	ULPV-MV
Survival	53.1%	66.5%	+13.4pp
LDs	39.8	45.7	+5.9
– Ventilated	9.2	5.3	-3.9
– Non-ventilated	30.6	40.4	+9.7
QALDs	17.1	20.3	+3.2
LoS (days)			
– ICU	11.7	12.3	+0.6
– Hospital	17.9	20.1	+2.2
Costs			
– Ventilation	£17,747	£10,362	-£7,385
– ECCO2R	£0	£5,000	£5,000
– ICU	£10,014	£10,501	£487
– Hospital (Non-ICU)	£2,566	£3,257	£691
– ECCO2R complications	£0	£200	£200
Total	£30,327	£29,194	-£1,133

Absolute	MV	ULPV	ULPV-MV
LYs (undiscounted)	7.550	9.461	+1.911
QALYs	2.457	3.086	+0.629
Lifetime cost	£15,023	£18,822	£3,799
Total cost	£45,350	£48,141	£2,792

Absolute	MV	ULPV	ULPV-MV
Lifetime cost			
Cost/LY	£6,007	£5,088	£1,461
Cost/QALY	£18,454	£15,600	£4,442

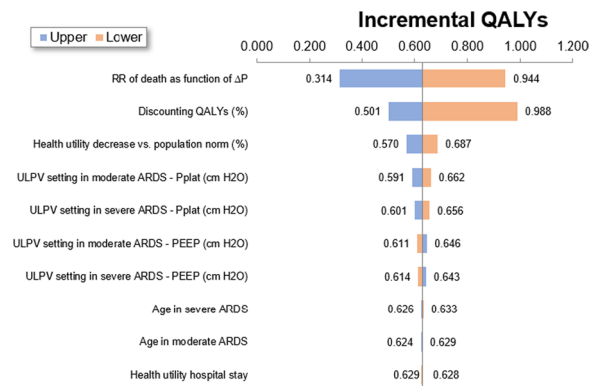

Figure 1 (abstract 000203) Tornado diagram

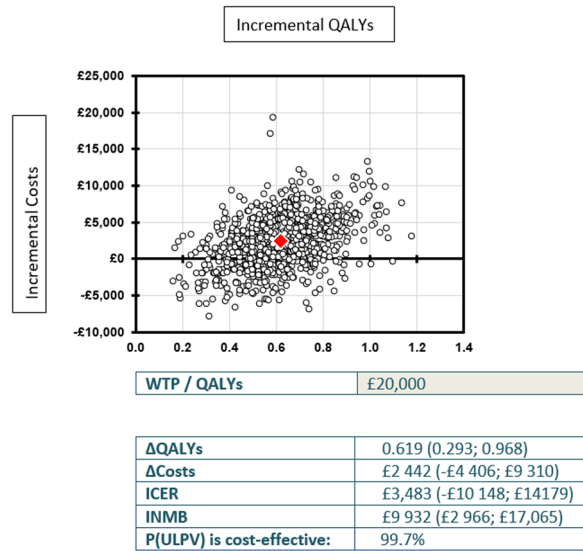

Figure 3 (abstract 000203) ICER QALYs

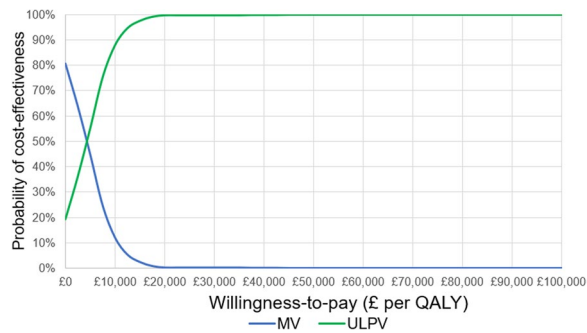

Figure 4 (abstract 000203) Cost effectiveness acceptability (CEAC)

References

- Bellani G, Laffey JG, Pham T, Fan E, Brochard L, Esteban A, et al. Epidemiology, patterns of care, and mortality for patients with acute respiratory distress syndrome in intensive care units in 50 countries. *JAMA*. 2016;315:788–800.
- Ethgen, Oliver, et al. "A preliminary cost-effectiveness analysis of lung protective ventilation with extra corporeal carbon dioxide removal (ECCO2R) in the management of acute respiratory distress syndrome (ARDS)." *Journal of Critical Care* 63 (2021): 45–53.
- Ethgen O, Schneider AG, Bagshaw SM, Bellomo R, Kellum JA. Economics of dialysis dependence following renal replacement therapy for critically ill acute kidney injury patients. *Nephrol Dial Transplant*. 2015;30:54–61.

Topic: Acute respiratory failure and mechanical ventilation.

000204

Transvenous diaphragm neurostimulation changes the concentration of inflammatory cytokines in dorsal and ventral lung regions

E. Rohrs¹, T. Bassi², M. Nicholas³, M. Ornowska⁴, J. Wittmann³, K. Fernandez³, M. Gani², D. Evans², S. Reynolds¹

¹Academic Research-Critical Care, Advancing Innovation in Medicine Institute, New Westminster, Canada; ²Research and Development, Lungpacer Medical USA Inc., Exton, United States of America; ³Critical Care Research, Fraser Health Authority, New Westminster, Canada;

⁴Biomedical physiology and kinesiology, Simon Fraser University, Maple Ridge, Canada

Correspondence: E. Rohrs

Intensive Care Medicine Experimental 2023, 11(Suppl 1):000204

Introduction. Mechanical ventilation (MV) can induce cytokine upregulation in both healthy and injured lungs due to alveolar cellular responses to stretch and decompartmentalization from cellular damage. (1) Cytokines include IL-1β and IL-6. (2) Granulocyte–macrophage colony-stimulating factor (GM-CSF) is a cytokine that plays a critical role in maintaining alveolar epithelium under homeostatic and pathologic conditions. (3) An external insult triggers GM-CSF to facilitate the epithelial wound-healing process, driving the repair processes. (3) GM-CSF also expresses elevated levels of IL1-β and IL-6. (3) We used transvenous diaphragm neurostimulation (TTDN) to reduce lung stretch during MV in a lung injury model and the resulting cytokine expression in lung tissue.

Methods. Lung injury was induced in deeply sedated pigs, ventilated using volume-control mode at 8 ml/kg, PEEP 5 cmH2O, with rate and FiO2 set to achieve normal blood gases. Injury was induced using oleic acid, delivered via the pulmonary artery until PaO2/FiO2 < 200. Animals were ventilated for 12 h post-injury. MV +TTDN100% group (n = 6) received TTDN synchronized to inspiration on every breath, targeting a reduction in ventilator pressure–time–product of 15–20%; MV group (n = 6) received volume-control ventilation only. At study end, lung tissue was sampled and homogenized. Cytokines were measured using porcine specific ELISA assays.

Results. Median (IQR) GM-CSF: 35 pg/ml (28–45) MV Dorsal; 20 pg/ml (5–41) MV Ventral, 1 pg/ml (0–8) MV +TTDN100% Dorsal, 0 pg/ml (0–18) MV +TTDN100% Ventral. IL-1β: 232 pg/ml (175–365) MV Dorsal, 611 pg/ml (227–973) MV Ventral, 331 pg/ml (188–465) MV +TTDN100% Dorsal, 359 pg/ml (201–765) MV +TTDN100% Ventral. IL-6: 18 pg/ml (14–59) MV Dorsal, 78 pg/ml (11–142) MV Ventral, 39 pg/ml (16–47) MV +TTDN100% Dorsal, 34 (9–54) pg/ml MV +TTDN100% Ventral.

Conclusions. TTDN resulted in lower cytokine expression in the ventral lung regions indicating a reduction in lung strain and ventilator-induced injury mitigation.

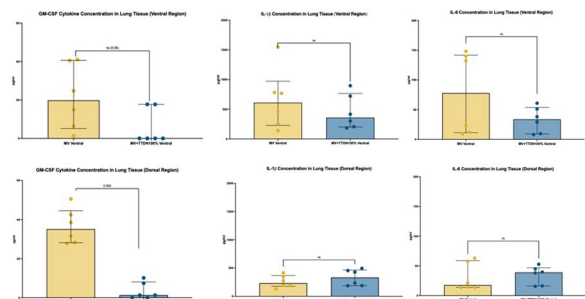

Figure 1 (abstract 000204) Results of administration of EVs from non-activated and activated MSCs with LPS (control and LPS EVs). A) Pro-inflammatory cytokines and chemoattractant mediators in lung tissue at 72 h (mRNA expression correlated vs. GAPDH) (n = 5–10); B) Pro-inflammatory cytokines, chemoattractant mediators and M2 phenotype markers in BAL alveolar macrophages at 72 h (mRNA expression correlated vs. GAPDH) (n = 5–10). C) Total and differential cell count in BAL by Flow Cytometry (n = 5–10). **p < 0.01 vs. control group; \$p < 0.05 vs HCl/LPS group; *p < 0.05 vs. control group

References

- Meisel C, Schefold JC, Pischowski R, Baumann T, Hetzger K, Gregor J, Weber-Carstens S, Hasper D, Keh D, Zuckermann H, Reinke P and Volk HD. Granulocyte–macrophage colony-stimulating factor to reverse sepsis-associated immunosuppression: a double-blind, randomized, placebo-controlled multicenter trial. *Am.J.Respir.Crit.Care Med*. 180: 7: 640–648, 2009.

- Goodman RB, Pugin J, Lee JS and Matthay MA. Cytokine-mediated inflammation in acute lung injury. 14: 523–535, 2003.
- Stüber F, Wrigge H, Schroeder S, Wetegrove S, Zinserling J, Hoefl A and Putensen C. Kinetic and reversibility of mechanical ventilation-associated pulmonary and systemic inflammatory response in patients with acute lung injury. *Intensive Care Med.* 28: 7: 834–841, 2002.
- TB Vets
- BC Lung Association
- Lungpacer Medical Inc.
- MITACS

Topic: Acute respiratory failure and mechanical ventilation.

000206

Prognostic factors in predicting longer hospital stay in patients with croup

J. Lee¹

¹Emergency Department, Chonnam National University Hospital, Gwangju, Republic of Korea

Correspondence: J. Lee

Intensive Care Medicine Experimental 2023, **11(Suppl 1)**:000206

Introduction. Croup is a common respiratory inflammation of the trachea, larynx, and bronchi that can lead to inspiratory stridor and barking cough. For diagnosis and evaluation of severity for the croup, the Westley score based on clinical symptoms is most commonly used. Factors that determine this include stridor, retractions, cyanosis, level of consciousness, and air entry. Since the evaluation of these physiological factors is subjective, there are many limitations in scoring.

Methods. This retrospective observational study included patients with croup who visited our emergency department between January 2019 and December 2021. Croup is defined as acute obstructive laryngitis, J05.0 in the International Classification of Diseases 10th Revision, based on information entered by the pediatrician at discharge. The primary outcome was hospitalization for longer than a short stay.

Results. In total, 110 patients were included. The longer hospital stay rate was 41.8% (n = 46). In the multivariable analysis, oxygen demand (OR, 1.13; 95% CI, 1.02–1.25), sex (OR, 2.74; 95% CI, 1.08–6.96), and potassium level (OR, 5.13; 95% CI, 1.72–15.26) were independently associated with a longer hospitalization. The areas under the curve (AUCs) of potassium level, oxygen demand, and sex for admission were 0.697 (95% CI, 0.596–0.798), 0.631 (95% CI, 0.552–0.710), and 0.611 (95% CI, 0.522–0.701), respectively. The AUC value of the three-factor prognostic model was 0.771 (95% CI, 0.681–0.861), which was higher than potassium level, oxygen demand, and sex alone.

Conclusions. Potassium level, sex, and oxygen demand were independently associated with a longer hospital stay for croup. The combination of potassium level, sex, and oxygen demand demonstrated a fair predictive performance of the length of hospital stay.

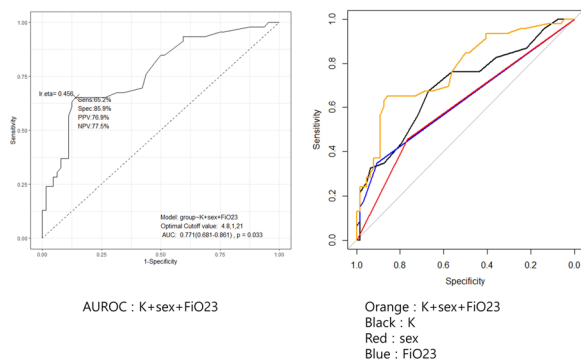

Figure 1 (abstract 000206) Receiver operating characteristics curve analyses of potassium, sex, and oxygen demand for predicting

a longer hospital stay in patients with croup. The AUCs of potassium, sex, and oxygen demand were 0.697 (95% CI, 0.596–0.798), 0.631 (95% CI, 0.552–0.710), and 0.611 (95% CI, 0.522–0.701), respectively; AUC, area under the curve; CI, confidence intervals

Fig. 2 The receiver operating characteristics curve analysis of the three factors combined was 0.771 (95% CI, 0.681–0.861)

References

- Hopper SM, Archer P, Breene R, Bolt P, Sarmmartino L. Paediatric short stay unit in a community hospital: effective, efficient and popular. *Emerg Med Australas.* 2008 Oct;20(5):431–6.
- Kwong K, Hoa M, Coticchia JM. Recurrent croup presentation, diagnosis, and management. *Am J Otolaryngol* 2007;28:401–7)
- Lin SC, Lin HW, Chiang BL. Association of croup with asthma in children: A cohort study. *Medicine (Baltimore).* 2017 Sep;96(35):e7667.

Topic: Infections and prevention.

000208

Role of AKI biomarkers for predicting AKI development, initiation of kidney replacement therapy, and prognosis in critically ill COVID-19 patients

R. Kuzumi¹, A. Tsuruoka¹, D. Fujita¹, T. Yamashita¹, K. Shigemitsu¹, H. Rinka¹

¹Emergency and Critical Care Medical Center, Osaka City General Hospital, Osaka, Japan

Correspondence: R. Kuzumi

Intensive Care Medicine Experimental 2023, **11(Suppl 1)**:000208

Introduction. Acute kidney injury (AKI) biomarkers, such as NGAL and L-FABP, have been reported to be useful for early AKI diagnosis and prognostic prediction in critically ill patients admitted to the ICU, post-operative patients following cardiovascular surgery, and patients with sepsis. Few studies have used AKI biomarkers to predict prognosis in patients with severe COVID-19, and there have been no reports examining both NGAL and L-FABP.

Objectives. To investigate whether urinary NGAL (uNGAL) and urinary L-FABP (uL-FABP) can predict AKI development, initiation of kidney replacement therapy (KRT), and prognosis of critically ill COVID-19 patients admitted to the ICU.

Methods. This was a single-center, retrospective cohort study including 357 critically ill COVID-19 patients admitted to our ICU between February 2020 and January 2023. A total of 287 patients were divided into two groups based on median values of uNGAL and uL-FABP levels measured at ICU admission. Levels of uNGAL \leq 33.3 μ g/gCr and $>$ 33.3 μ g/gCr were defined as the N–L and N–H groups, respectively. Levels of uL-FABP \leq 59.7 μ g/gCr and $>$ 59.7 μ g/gCr were defined as the L–L and L–H groups, respectively. Fisher’s exact test was used to determine AKI development and initiation of KRT. The Logrank test was performed for 28-day mortality.

Results. Median age, BMI, P/F ratio, CRE, APACHE II score, and ICU stay were 68 years, 25.2, 159, 0.79 mg/dL, 11, and 8 days, respectively; 281 patients (78.7%) were male, 310 (86.8%) required mechanical ventilation, and 17 (4.8%) required ECMO. A total of 62 patients (21%) had CKD, 173 (48.4%) developed AKI (defined by KDIGO classification), 78 (21.8%), 49 (13.7%), and 46 patients (12.9%) were staged 1, 2, and 3, respectively, and 27 (7.6%) required KRT. The incidence of AKI was significantly higher in the N–H and L–H groups than in the N–L ($p < 0.01$) and L–L groups ($p < 0.01$), respectively. Initiation of KRT was significantly more frequent in the N–H group than in the N–L group ($p < 0.01$), but there was no significant difference between the L–L and L–H groups ($p = 0.08$). Rates of 28-day mortality were significantly higher in the N–H group than in the N–L group (Logrank $p < 0.01$), but there was no significant difference between the L–L and L–H groups (Logrank $p = 0.52$). The Kaplan–Meier curves are shown in Fig. 1 and 2.

Conclusions. While both uNGAL and uL-FABP are useful in predicting AKI development, uNGAL may be more useful than uL-FABP in predicting outcomes, such as requirement for KRT and 28-day mortality in patients with severe COVID-19. In critically ill COVID-19 patients

with hypercytokinemia and multiple organ failure, uNGAL, which is upregulated by inflammation associated with infection in addition to ischemia, may be more useful than uL-FABP, which is upregulated by oxidative stress and ischemia.

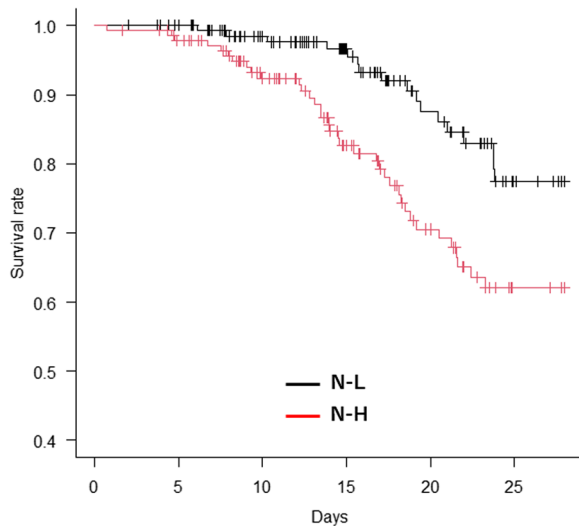

Figure 1 (abstract 000208) .
The difference in 28-day mortality rate between the N-L and N-H groups.

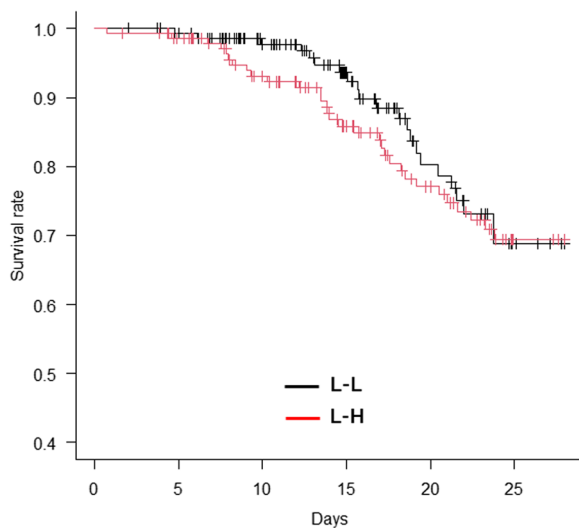

Figure 2 (abstract 000208) .
The difference in 28-day mortality rate between the L-L and L-H groups.

References

- Hjortrup PB, et al. Clinical review: Predictive value of neutrophil gelatinase-associated lipocalin for acute kidney injury in intensive care patients. *Crit Care* 2013; 17: 211.
- Nickolas TL, et al. Diagnostic and prognostic stratification in the emergency department using urinary biomarkers of nephron damage: a multicenter prospective cohort study. *J Am Coll Cardiol* 2012; 59: 246–55.

- Haase M, et al. Accuracy of neutrophil gelatinase-associated lipocalin(NGAL) in diagnosis and prognosis in acute kidney injury: a systematic review and meta-analysis. *Am J Kidney Dis* 2009; 54: 1012–24.
- Ho J, et al. Urinary, Plasma, and Serum Biomarkers' Utility for Predicting Acute Kidney Injury Associated With Cardiac Surgery in Adults: A Meta-analysis. *Am J Kidney Dis* 2015; 66: 993–1005.
- Susantitaphong P, et al. Performance of urinary liver-type fatty acid-binding protein in acute kidney injury: a meta-analysis. *Am J Kidney Dis* 2013; 61: 430–9.
- Hong Si Nga, et al. Sepsis and AKI in Clinical Emergency Room Patients: The Role of Urinary NGAL. *Biomed Res Int* 2015; 2015: 413,751.
- Schrezenmeier EV, et al. Biomarkers in acute kidney injury—pathophysiological basis and clinical performance. *Acta Physiol (Oxf)* 2017; 219: 554–72.
- None.

Topic: Acute Kidney Injury and haemofiltration.

000209

Pneumocystis jiroveci pneumonia associated with malnutrition in immunocompetent but malnourished children

J. Kang¹, H. Eunha¹, K. Younga¹

¹Pediatrics, Pusan National University Yangsan Hospital, Yangsan, Republic of Korea

Correspondence: J. Kang

Intensive Care Medicine Experimental 2023, **11(Suppl 1)**:000209

Introduction. Malnutrition is associated with opportunistic infections, and *Pneumocystis jiroveci* has been occasionally reported as one of the causative pathogens in malnourished patients. We herein report two cases of *Pneumocystis jiroveci* pneumonia (PCP) in immunocompetent but malnourished children.

Methods. Patient 1 was a 4-month-old girl with maple syrup urine disease, who had been fed low branched-chain amino acid formula and underwent intermittent peritoneal dialysis. She had a mild dry cough for a month, and a chest X-ray three weeks ago before presentation showed diffuse haziness on both lung field.

Patient 2 was a 5-month-old male born at 28 weeks of gestation. He was transferred to our hospital because of mechanical ventilator weaning failure, despite being treated for pneumonia for three weeks. He was found to have rickets after four months of feeding only hypoallergenic formula for suspected gastroesophageal reflux, which is known as "Neocate rickets".

Results. In both patients, *Pneumocystis jiroveci* was detected in sputum aspirates using Polymerase Chain Reaction tests. They required mechanical ventilator support due to hypoxemic respiratory failure caused by PCP, and could be weaned from mechanical ventilator after treatment with trimethoprim/sulfamethoxazole.

Conclusions. These cases suggest that PCP should be considered as an opportunistic infection in malnourished children who shows prolonged unexplained respiratory symptoms and radiologic abnormalities, regardless of their immune status.

A letter of consent has been received for identifiable patient(s) in this abstract. IRB has been approved.

Topic: Infections and prevention.

000210

Brain computer tomography perfusion in patients with suspected ischemic cerebral conditions after cardiac surgery

H. Liu¹, M. H. Luo¹, J. C. Luo¹, Y. J. Zhang¹, G. W. Hao¹, J. Y. Hou¹, Y. Su¹, G. G. Ma¹, C. S. Wang², G. W. Tu¹, Z. Luo¹

¹Cardiac Intensive Care Center, Zhongshan Hospital, Fudan University, Shanghai, China; ²Department of Cardiac Surgery, Zhongshan Hospital, Fudan University, Shanghai, China

Correspondence: M.H. Luo

Introduction. Non-contrast CT (NCCT) imaging of the head is widely accepted in evaluating acute stroke. However, its sensitivity in identifying the ischemic regions is low. Current guidelines only recommend using NCCT to exclude hemorrhage [1]. To assess the extent of brain ischemia, CT perfusion (CTP) helps to evaluate the hemodynamic status of brain with quantified perfusion values. Several randomized controlled trials have also used CTP results to guide thrombectomy [2]. Unfortunately, the advantages of CTP imaging in the assessment of patients, who have undergone cardiac surgery, are largely unknown.

Objectives. To investigate the association between CTP results and neurological outcomes, and to compare NCCT and CTP in terms of their correlation with clinical outcomes in patients with suspected ischemic cerebral conditions after cardiac surgery.

Methods. Data of patients undergoing cardiac surgery presenting with postoperative neurological symptoms were prospectively collected from June 2020 to July 2022. NCCT was used to exclude those with cerebral hemorrhage. Patients with suspected ischemic cerebral conditions examined by both NCCT and CTP were included. ASPECT score was calculated. Volume of CBF < 30%, volume of Tmax > 6.0 s and mismatch volume were determined based on CTP images to reflect ischemic core and penumbra. The primary outcome was the Modified Rankin Scale (mRS) on discharge from hospital. Secondary outcomes included in-hospital mortality, length of hospital and intensive care unit stay, and tracheotomy. The area under the receiver operating characteristic (AUROC) curve was used to evaluate the predictive power.

Results. 9134 patients were screened. Among them, 132 presented with postoperative neurological symptoms. 45 patients were included for the analysis. There was no statistically significant difference in mRs on discharge between patients with a positive initial NCCT result and those with a negative result (4.00 vs 3.00, P = 0.062). There was also no significant difference in all the secondary outcomes stratified by NCCT results. Patients with unfavorable neurological outcomes (mRs > 3) had significantly lower ASPECT score (P = 0.034), higher volume of ischemic core (P < 0.001) and penumbra (P < 0.002) (Table). The ASPECT score, volume of ischaemic core and penumbra correlated with the mRS on discharge. The AUROC of the ASPECT score, volume of ischemic core and penumbra in predicting unfavorable neurological outcomes were 0.679 (0.523–0.810), 0.792 (0.644–0.898) and 0.696 (0.541–0.824) respectively (Fig. 2).

	Overall	mRs ≤ 3	mRs > 3	p value
ASPECT	9.00 [8.00, 9.00]	9.00 [8.00, 10.00]	8.00 [7.50, 9.00]	0.034
Positive initial NCCT, n	20 (44.4)	7 (31.8)	13 (56.5)	0.136
Volume of CBF < 30%, ml	0.00 [0.00, 19.80]	0.00 [0.00, 0.00]	16.30 [0.00, 43.50]	< 0.001
Volume of Tmax > 6 s, ml	33.60 [0.00, 176.90]	0.00 [0.00, 67.12]	129.90 [6.90, 239.75]	0.020
Tracheostomy, n	16 (35.6)	4 (18.2)	12 (52.2)	0.029
LOHS, days	17.00 [14.00, 28.00]	15.00 [13.25, 24.75]	20.00 [14.50, 29.00]	0.387
LOICU, days	11.00 [7.00, 19.00]	8.00 [6.00, 11.75]	14.00 [9.00, 23.50]	0.038

Conclusions. NCCT result was not associated with the neurological outcome in patients with suspected ischemic cerebral conditions after cardiac surgery. Patients with unfavorable neurological outcomes presented significantly worse markers on CTP. Volume of ischemic core on CTP may be better to predict the neurological outcomes in patients with suspected ischemic cerebral conditions after cardiac surgery.

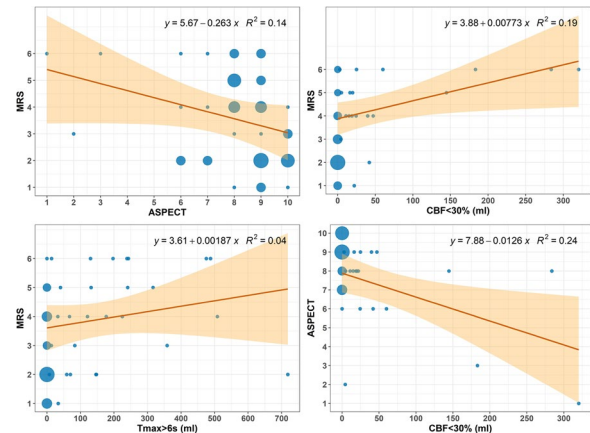

Figure 1 (abstract 000210) Relationship between NCCT and CTP variables

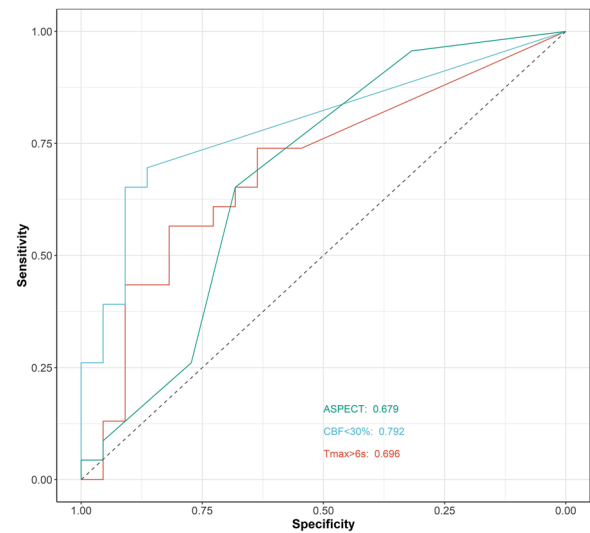

Figure 2 (abstract 000210) Receiver operating characteristic curves of 4 NCCT and CTP variables for poor neurological outcomes (mRs > 3)

References

- [2] Albers GW, Marks MP, Kemp S, et al. Thrombectomy for Stroke at 6 to 16 Hours with Selection by Perfusion Imaging. *N Engl J Med.* 2018;378(8):708–718. <https://doi.org/10.1056/NEJMoa1713973>
- [1] Powers WJ, Rabinstein AA, Ackerson T, et al. Guidelines for the Early Management of Patients With Acute Ischemic Stroke: 2019 Update to the 2018 Guidelines for the Early Management of Acute Ischemic Stroke:

A Guideline for Healthcare Professionals From the American Heart Association/American Stroke Association [published correction appears in Stroke. 2019 Dec;50(12):e440-e441]. Stroke. 2019;50(12):e344-e418. <https://doi.org/10.1161/STR.0000000000000211>

3. This research was funded by the the National Natural Science Foundation of China (82070085), the Research Project of Shanghai Municipal Health Commission (20214Y0136) and the Clinical Research Project of Zhongshan Hospital (2020ZSLC38 and 2020ZSLC27).

Topic: Perioperative care.

000214

Comparison of SAPS 3 and SOFA in patients with sepsis according to Sepsis-3 criteria: A Nationwide Multicenter Retrospective Cohort Study

C. Dae Hong¹, A. Jee Hwan¹, J. W. Huh¹, H. Sang-Bum¹, K. Younsuck¹, D. K. Oh¹, L. Su Yeon¹, C. M. Lim¹

¹Department of pulmonary and critical care medicine, Asan Medical Center, Seoul, Republic of Korea

Correspondence: C. Dae Hong

Intensive Care Medicine Experimental 2023, 11(Suppl 1):000214

Introduction. The Simplified Acute Physiology Score 3 (SAPS 3), and the Sequential Organ Failure Assessment (SOFA) score are models that predict the mortality rate of patients admitted to intensive care units. Because there are differences in the parameters used to calculate the scores of SAPS3 and SOFA, there may be differences in the expected prognosis of the two models for the same patient. We aimed to compare the in-hospital mortality prediction of SAPS3, Korean SAPS3, a first-level customization of SAPS3, and SOFA scores in sepsis patients. We also evaluated the predicting performance of the three scoring systems in pulmonary sepsis versus non-pulmonary sepsis.

Methods. This retrospective cohort study analysed the prospectively collected national database of the Korea Sepsis Association from September 2019 to December 2021. Adult patients who were diagnosed with sepsis based on the sepsis-3 definition were included. To compare the ability of three predictive models, calibration and discrimination were determined by the Hosmer–Lemeshow test and the area under the receiver operating characteristic (aROC) curve, respectively. In addition, comparison between models according to the site of infection was also performed (pulmonary sepsis patients vs. non-pulmonary sepsis patients).

Results. The study included 4,673 patients. The hospital mortality rate was 36.4%(1,703 patients). The 1748 patients with pulmonary sepsis had higher hospital mortality rates than the 2,925 patient with non-pulmonary sepsis (41.8% vs. 33.3%; $P < 0.001$). The SAPS 3 score was significantly higher for the pulmonary sepsis patients compared with non-pulmonary sepsis patients (74.0 vs. 70.0; $P < 0.001$). However, there was no significant difference in the SOFA score, which did not reflect the severity of patients with pulmonary sepsis relatively well (10.0 vs. 10.0; $P = 0.894$). The discriminative performance in all patients was fair with SAPS-3 and SOFA while lower with SOFA (aROC: 0.741 vs. 0.725; $P = 0.0159$). In the pulmonary sepsis patients, the discrimination of SOFA was poor, and significantly lower than that of the SAPS 3 and K-SAPS 3 (aROC: 0.686 vs. 0.719; $P < 0.001$). The general equation of SAPS3 and Korean SAPS3 showed good calibration in all analyses, while SOFA exhibited poor calibration in all patients ($\hat{C} = 20.11$, $P = 0.01$) and non-pulmonary sepsis patients. ($\hat{C} = 19.30$, $P = 0.023$). All prognostic models significantly overestimated the observed mortality ($SMR < 1.0$).

Conclusions. In patients with sepsis admitted to the ICU, SAPS3 was superior to the SOFA score in predicting prognosis. The regional customization of SAPS also improved the quality of prediction for patients with sepsis, and this tendency was more prominent in patients with pulmonary sepsis.

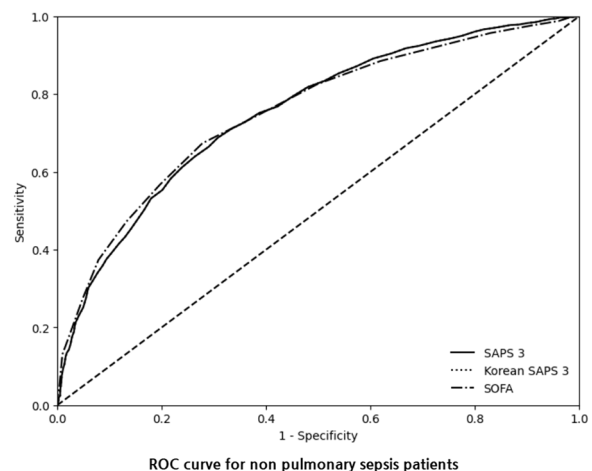
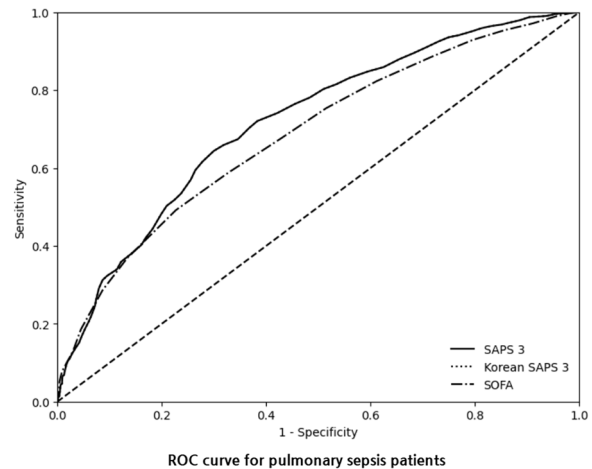
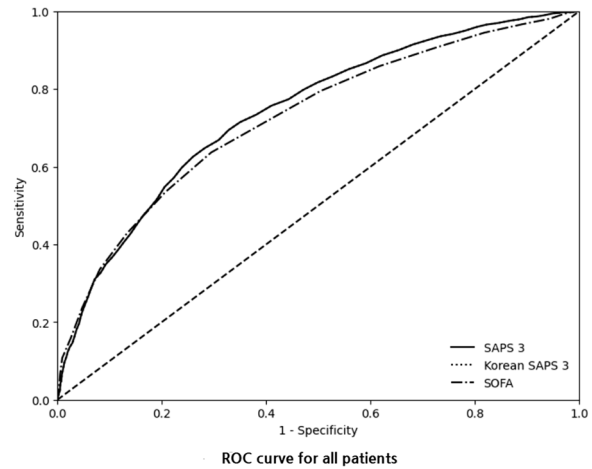

Table 1 (abstract 000214) Table. Performance of the predicting models

	Predicted mortality (% mean ± SD)	aROC (95% CI)	DeLong p value	GOF \hat{c} test	GOF P value	SMR (95% CI)
All patients						
SAPS3	58.4 ± 23.9	0.741 (0.727-0.756)		7.80	0.452	0.62 (0.59-0.65)
K-SAPS3	47.9 ± 25.3	0.741 (0.727-0.756)		4.74	0.784	0.76 (0.73-0.80)
SOFA	67.3 ± 16.7	0.725 (0.710-0.740)	0.016	20.11	0.01	0.54 (0.52-0.57)
Pulmonary sepsis						
SAPS3	60.9 ± 24.0	0.719 (0.695-0.743)		9.25	0.321	0.69 (0.64-0.74)
K-SAPS3	50.7 ± 25.8	0.719 (0.695-0.743)		6.66	0.573	0.82 (0.76-0.89)
SOFA	60.0 ± 14.2	0.686 (0.660-0.711)	0.002	7.23	0.613	0.70 (0.65-0.75)
Non-pulmonary sepsis						
SAPS3	56.9 ± 23.7	0.752 (0.734-0.771)		5.75	0.676	0.58 (0.55-0.62)
K-SAPS3	46.2 ± 24.9	0.752 (0.734-0.771)		4.12	0.846	0.72 (0.66-0.77)
SOFA	69.0 ± 17.6	0.754 (0.735-0.773)	0.892	19.30	0.023	0.48 (0.46-0.51)

Topic: Sepsis.

000215

Creating an automated audit and quality improvement system for referrals to Critical Care at the Royal Infirmary of Edinburgh

G. Passerello¹, A. Taylor¹, P. Barron¹, S. Rhode², R. McLaren¹, M. Blayney¹, B. Ordys¹, N. Lone², D. Philp³

¹Intensive Care, Royal Infirmary of Edinburgh, Edinburgh, United Kingdom; ²Usher institute, The University of Edinburgh, Edinburgh, United Kingdom; ³Intensive Care, Western General Hospital, Edinburgh, United Kingdom

Correspondence: G. Passerello

Intensive Care Medicine Experimental 2023, **11(Suppl 1)**:000215

Introduction. The Faculty of Intensive Care Medicine (FICM) and the Intensive Care Society specify standards of care for patients referred to ICU: documentation of a discussion with a consultant, time of assessment, and time of decision to admit (1). In addition, accepted patients should be admitted within 4 h of decision. Furthermore, documentation should include of Treatment Escalation Plan (TEP) detailing consideration of benefits and burdens of therapies. Most units have access to a local audit system, but this is limited to recording activity occurring within an ICU. Furthermore, identifying referrals and evaluating processes of care entails burdensome manual data collection. Therefore, FICM guidelines recommend that the ICU community should develop a methodology to review referrals and evaluate decision making processes.

Objectives. We aimed to establish an innovative, data-driven programme in order to develop the data infrastructure required to identify referrals to critical care across a region in Scotland (NHS Lothian) in order to support a data-driven quality improvement (QI) programme of work so that performance could be benchmarked against national standards. Here, we report the process to establish the infrastructure and initial baseline data for the QI programme.

Methods. We worked with local NHS informatics teams to use free text recognition tools to scan electronic health records (EHR) in order to automate the identification of ICU referrals. Structured and unstructured data fields were extracted from EHR and transferred on a weekly basis to automate collection of key data items. For patients subsequently admitted to ICU, additional data fields were extracted from the local ICU audit database. This was supplemented by manual case note review in a subset to extract a limited set of fields that could not be automated (e.g. documented patient-centred discussions for TEP; past medical history; organ dysfunction at the time of referral). We automated data wrangling and reporting using R statistical package(3) to import, code and clean routine data flows and report in a standardised format (Fig. 1).

Results. During the period 05/07/2022 to 22/01/2023, there were a total of 625 ICU referrals averaging 3 per day (Fig. 2). For the subset with manual data extraction (n = 107), 41% of referred patients were admitted to ICU. These patients were younger (mean age 53 vs 63), less frail (27% vs 33%) and had higher number of organ dysfunction (median 2 vs 1). Benchmarking performance against FICM standards, >90% of referrals were seen within one hour, and >75% were admitted within 4 h of decision-to-admit. (Fig. 3) Consultant involvement was documented in EHR in only 47% of referrals. In the group of patients for whom ICU was deemed not to be of overall benefit, TEP discussion was documented in 79%.

Conclusions. We have established a data-driven system to efficiently identify and report the key aspects of ICU referrals. Limitations include not identifying referrals in cases when the free-text recognition does not perform. Whilst manual extraction is currently required, we plan to automate collection of other fields through linkage to other routinely collected and administrative datasets available regionally. A programme of QI work is underway using this newly established data platform to efficiently measure processes to continuously drive improvement.



Figure 1 (abstract 000215) Flow diagram illustrating the data extraction, review and quality improvement process

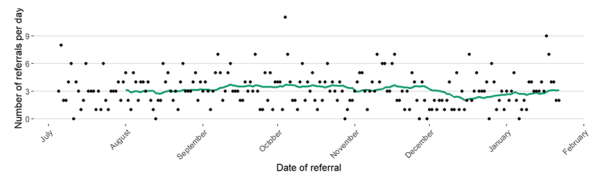

Figure 2 (abstract 000215) Rolling 28 day average of referrals plotted with referrals per day between 07/05/2022–22/01/2023

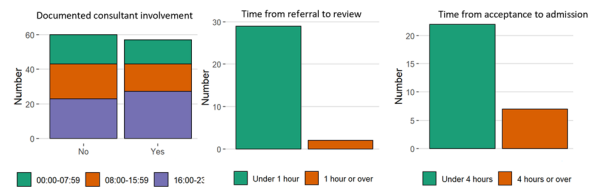

Figure 3 (abstract 000215) Graphs showing documented consultant involvement depending on time of day (left); time of referral to time of review (middle); and time of decision to admit to time of admission to ICU (right)

References

1. R Development Core Team. R: a language and environment for statistical computing. R Foundation for Statistical Computing, Vienna, Austria 2022. <https://www.R-project.org/>
2. Faculty of Intensive Care Medicine, Intensive Care Society. Version 2.1 GUIDELINES FOR THE PROVISION OF INTENSIVE CARE SERVICES 2. 2022.
3. NHS Performs. Royal Infirmary of Edinburgh [Internet]. NHS Scotland. 2023 [cited 2023 Feb 22]. Available from: <https://www.nhsperforms.scot/hospital-data?hospitalid=37>

Topic: Critical care organisation, quality management, information systems, outcomes.

000218

Automated data extraction from electronic health records versus manual data curation for case report forms: re-evaluating the association between ventilatory dead space and mortality in intubated COVID-19 patients

L. Lijovic¹, Z. Gavranovic², H. J. De grooth¹, P. J. Thorai¹, L. Bos³, T. Radocaj², P. Elbers¹

¹Intensive care adults, Amsterdam UMC, locatie VUmc, Amsterdam, Netherlands; ²Department of anaesthesiology, reanimatology and intensive care, Sisters of Charity Hospital, Zagreb, Croatia; ³Department of intensive care, Amsterdam UMC, locatie AMC, Amsterdam, Netherlands

Correspondence: L. Lijovic

Intensive Care Medicine Experimental 2023, **11(Suppl 1)**:000218

Introduction. Manual data abstraction from electronic health records (EHRs) is the golden standard of data collection for observational research, but it is time-consuming and requires extensive review by highly trained personnel. The COVID-19 pandemic gave rise to initiatives collecting multicentre data, including the ProVent-COVID collaboration using manual data abstraction and the COVID-Predict collaboration using automated data collection, both from similar patients receiving similar standard of care, presenting an opportunity to compare the fitness of use of both methods for observational research.

Objectives. We aimed to replicate the ProVent-COVID investigation of association of ventilatory dead space (Vd/Vt) with 28-day mortality using automatically extracted data from COVID-Predict to confirm or challenge their findings.

Methods. Data was obtained from the COVID-Predict Dutch Data Warehouse containing full-admission data from critically ill COVID-19 patients from 25 Dutch hospitals. The database contains 200 million data points from 3464 adult COVID-19 patients. Patients intubated for longer than 2 days were included. We analyzed ventilation parameters at the first hour of invasive ventilation and every 8 h thereafter for the first 4 days. Mean for each day was taken into analysis. Exposure variables were Harris-Benedict Vd/Vt fraction, direct estimation of Vd/Vt, end-tidal-to-arterial PaCO₂ ratio and ventilatory ratio. The primary outcome was 28-day mortality. A multivariable generalized mixed-effects model with hospital as a random effect and fixed effects: age, gender, BMI, PaO₂/FiO₂, creatinine, hypertension, diabetes, use of ACE inhibitors or ARBs, vasopressor or inotropic support, fluid balance, pH, mean arterial pressure, heart rate, respiratory system compliance and PEEP were used in the base model, and in further models each ventilatory exposure variable was added to check for improvement in predictive accuracy.

Results. Final cohort consisted of 1515 patients, 1157 survivors and 358 non-survivors. Non-survivors were typically older, male, with higher BMI, more severe ARDS, and suffered more often from diabetes, immunosuppression, and higher baseline creatinine values. Vd/Vt calculated were consistently higher in non-survivors and increased subsequently (Fig. 1), but after adjustment for the base risk model (AUC 0.795), none of the markers of impaired ventilation measured at the start of ventilation or the following day was significantly associated with 28-day mortality ($p = 0.096-0.787$, AUC 0.793-0.813). The inclusion of these variables did not improve the AUC-ROC compared to the base model (Fig. 2).

Conclusions. Using automated data extraction from EHRs, we confirmed findings of ProVent-collaboration and found no association between Vd/Vt estimation and 28-day mortality when controlling for confounding factors. Concordance of our results adds credibility to the notion that automatically extracted data from EHRs may provide a high quality and reliable resource circumventing the need for manual data curation. Given the significant time and resource costs associated with manual data extraction, these findings could have significant implications for the development of more efficient and effective ways of extracting data from large datasets, even beyond the COVID-19 crisis, saving intensivists time and resources.

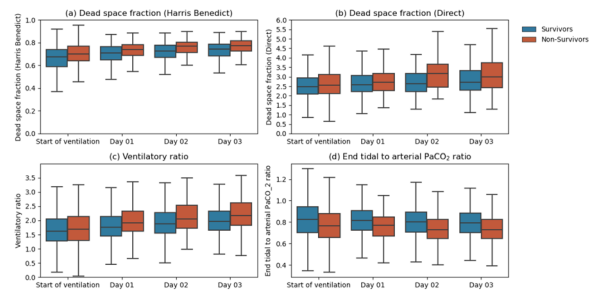

Figure 1 (abstract 000218) Lung-specific physiological variables over the first four days of ventilation

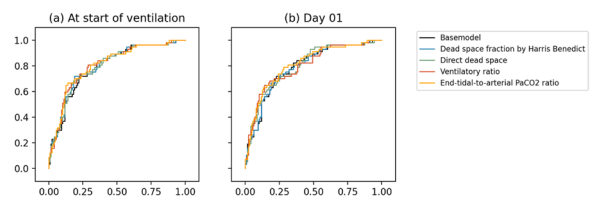

Figure 2 (abstract 000218) Receiver operating characteristics curve of the base model and with the inclusion of lung-specific physiological variables, obtained through general linear mixed-effects model

References

1. Fleuren LM, Dam TA, Tonutti M, de Bruin DP, Lalisang RCA, Gommers D, et al. The Dutch Data Warehouse, a multicenter and full-admission electronic health records database for critically ill COVID-19 patients. *Crit Care.* 2021;25(1):304.
2. Morales-Quinteros L, Neto AS, Artigas A, Blanch L, Botta M, Kaufman DA, et al. Dead space estimates may not be independently associated with 28-day mortality in COVID-19 ARDS. *Crit Care.* 2021;25(1):171.

Topic: Critical care organisation, quality management, information systems, outcomes.

000219

Association of gender with post-arrest care and outcome after out-of-hospital cardiac arrest of ventricular fibrillation: a nationwide cohort study

S. Hosomi¹, T. Kitamura¹, T. Irisawa², H. Ogura¹, J. Oda¹

¹Department of Traumatology And Acute Critical Medicine, Osaka University Graduate School of Medicine, Suita, Japan; ²Department of Traumatology and Acute Critical Medicine, Osaka University Hospital, Suita, Japan

Correspondence: S. Hosomi

Intensive Care Medicine Experimental 2023, **11(Suppl 1)**:000219

Introduction. Previous research has described differences in the provision of prehospital treatment for women who experience out-of-hospital cardiac arrest (OHCA). However, some studies have reported conflicting results regarding survival outcomes or in-hospital interventions between the sexes.

Objectives. The aim of this study was to investigate the association of gender with survival outcomes and in-hospital treatments, such as post-resuscitation care, in Japan.

Methods. This was a retrospective analysis of data from the Japanese Association for Acute Medicine (JAAM)-OHCA Registry, a multicenter nationwide prospective database in Japan in which 137 institutions providing emergency care participated. We included OHCA patients aged ≥ 18 years who presented with a shockable rhythm at the scene

between June 2014 and December 2020. The outcome measure was 30-day survival and in-hospital interventions. We compared the outcomes between gender groups using multivariable logistic regression. **Results.** A total of 5926 adult OHCA patients were eligible for our analysis. Of these patients, 4270 were men and 1026 were women. The proportions of patients with 30-day survival outcomes were 39.5% (1685/4270) and 37.4% (384/1026) in the men and women groups, respectively [crude odds ratio 0.92, 95% confidence interval (CI) 0.80–1.06]. Although there was no significant difference, survival outcomes tended to be better in women than men in the multiple regression analysis [adjusted odds ratio (AOR) 1.38, 95% CI 0.82–2.33]. Furthermore, there was no significant difference between the sexes in terms of patients who received ECPR (AOR, 0.81; 95% CI, 0.49–1.33) or TTM (AOR, 0.99; 95% CI, 0.68–1.46).

Conclusions. After adjusting for prognostic factors, there was no difference in survival rates and in-hospital interventions between men and women.

References

- This work was supported by a Grant-in-Aid for Scientific Research from the Japan Society for the Promotion of Science [grant number 21K09016] and the Ministry of Education, Culture, Sports, Science and Technology of Japan [grant number 22K09139].

Topic: Cardiac arrest.

000220

Effect of rigorous fluid management using real-time monitoring of ECW ratio by bioelectrical impedance analysis in critically ill postoperative patients: A prospective, single-labelled, randomized controlled study

Y. J. Chung¹, K. Hyesung¹, G. R. Lee¹, E. Y. Kim¹

¹Division of Trauma and Surgical Critical Care, Department of Surgery, The Catholic University of Korea Seoul St. Mary's Hospital, Seoul, Republic of Korea

Correspondence: Y.J. Chung

Intensive Care Medicine Experimental 2023, 11(Suppl 1):000220

Introduction. Postoperative fluid management is known to influence outcomes of postoperative patients who are prone to hemodynamic instability. However, the national guidelines for proper postoperative fluid strategy have not been recommended yet. We have previously reported that the overhydration status with extracellular water (ECW) ratio above 0.390 could affect postoperative outcomes. Based on this, we aimed to determine whether aggressive fluid control using ECW ratio could improve clinical outcomes through a randomized controlled trial.

Methods. From November 2021 to December 2022, intensive care unit (ICU) patients admitted after surgery were randomly assigned to an intervention group or a control group whether postoperative fluid management was controlled via bioelectrical impedance analysis (BIA). Among patients in the intervention group, dehydrated patients received a bolus infusion with crystalloid fluid whereas diuretics were administered to overhydrated patients until the value of ECW ratio fell within its normal setting range (0.390–0.406). Contrarily, BIA was performed once a day for the control group. Patients in the control group received liberal fluid treatment regardless of BIA results.

Results. Based on enrollment criteria, 77 patients of the intervention group and 90 patients of the control group were finally analyzed. There were no significant differences in demographic characteristics between the two groups. The length of hospitalization and 28-day mortality were significantly lower in the intervention group than in the control group. In multivariate analysis, the overhydrated status [odds ratio (OR): 2.731, 95% confidence interval (CI): 1.001–7.663, $p=0.049$] and high CLI value at D0 (OR: 1.024, 95% CI: 1.008–1.039,

$p=0.002$) were risk factors of postoperative morbidities. Regarding the 28-day mortality, high CLI value at D0 (OR: 1.024, 95% CI: 1.001–1.047, $p=0.037$) and liberal fluid strategy without BIA monitoring (OR: 10.979, 95% CI: 1.243–96.991, $p=0.031$) were the significant predisposing factors.

Conclusions. Rigorous fluid treatment with volume control based on ECW ratio by BIA could improve postoperative morbidities and 28-day mortality of ICU patients. Real-time monitoring of ECW ratio will help establish optimal fluid treatment strategies for postoperative ICU patients who are prone to fluid imbalance.

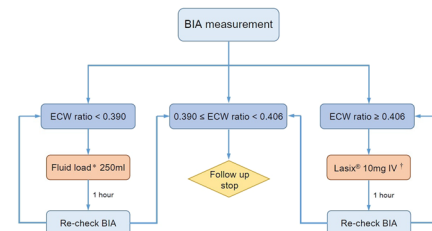
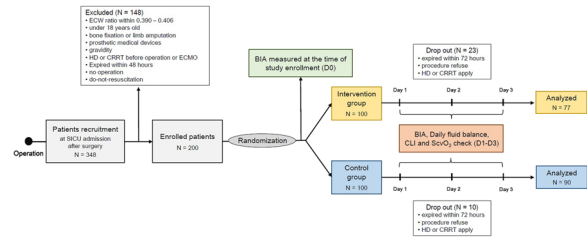

* Crystalloid fluid (Plasma Solution-A inj., HK-ims: N Corp.) via vechus infusion or increase amount of main fluid administered, if necessary.

* Lasix®, furosemide; Handok Inc., via IV side or decrease amount of main fluid administered, if necessary.

(A) Dehydrated status at D0**

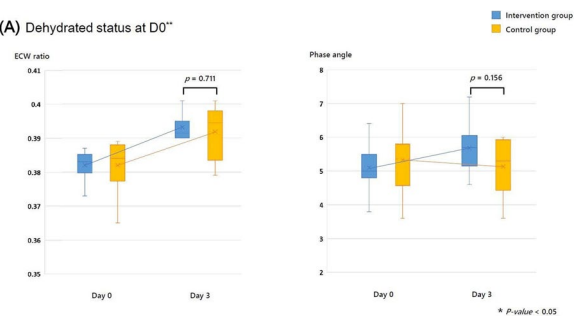

** Dehydration means as the case where the value of ECW ratio is under 0.390 measured at the time of study enrollment (D0).

(B) Overhydrated status at D0†

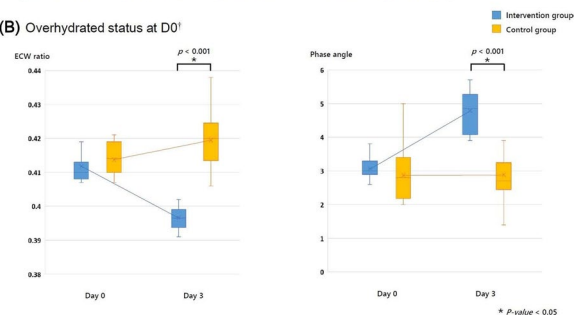

† Overhydration means as the case where the value of ECW ratio is above 0.406 measured at the time of study enrollment (D0).

References

- Zengin S, Al B, Genc S, Yildirim C, Ercan S, Dogan M, et al. Role of inferior vena cava and right ventricular diameter in assessment of volume status: a comparative study: ultrasound and hypovolemia. *Am J Emerg Med.* 2013;31(5):763–7.
- Bloos F, Zhang Z, Boulain T. Lactate-guided resuscitation saves lives: yes. *Intensive Care Med.* 2016;42(3):466–9.
- Murphy CV, Schramm GE, Doherty JA, Reichley RM, Gajic O, Afessa B, et al. The importance of fluid management in acute lung injury secondary to septic shock. *Chest.* 2009;136(1):102–9.
- Kayilioglu SI, Dinc T, Sozen I, Bostanoglu A, Cete M, Coskun F. Postoperative fluid management. *World J Crit Care Med.* 2015;4(3):192–201.
- Hjortrup PB, Haase N, Bundgaard H, Thomsen SL, Winding R, Pettila V, et al. Restricting volumes of resuscitation fluid in adults with septic shock after initial management: the CLASSIC randomised, parallel-group, multi-centre feasibility trial. *Intensive Care Med.* 2016;42(11):1695–705.
- The authors thank all participants and the staff of intensive care unit team for their invaluable cooperation to this study.

Topic: Perioperative care.

000224

The prognostic capacity of a test of Awake Prone Positioning and Associations with Need for Early Intubation in Patients with Acute Hypoxemic Respiratory Failure Related to COVID-19—an international prospective observational study

L. Morales-Quinteros¹, N. A. Fuentes², M. Olmos², M. Busico³, A. Vitali⁴, A. Gallardo⁵, A. Artigas⁶, M. Esperatti⁷

¹Intensive care, Hospital Universitario de Sant Pau. CIBERES, Barcelona, Spain; ²Intensive care unit, Community Private Hospital, Mar del Plata, Argentina; ³Intensive Care Unit, Clínica Olivos, ABQ, Argentina; ⁴Intensive Care Unit, Sanatorio de La Trinidad Palermo, Buenos Aires, Argentina; ⁵Intensive care unit, Sanatorio Clínica Modelo de Moron, Buenos Aires, Argentina; ⁶Instituto de Investigación e Innovación Parc Taulí (I3PT), CIBERES, Hospital Universitario de Sabadell, Barcelona, Spain; ⁷Intensive care medicine, Hospital Privado de Comunidad, Mar del Plata, Argentina

Correspondence: L. Morales-Quinteros

Intensive Care Medicine Experimental 2023, **11(Suppl 1)**:000224

Introduction. During the SARS-CoV-2 pandemic, the awake prone position (APP) strategy has been implemented as a rescue therapy because of the overwhelming surge of cases and the shortage of invasive mechanical ventilation (IMV). APP may prevent IMV in spontaneously breathing, critically ill patients with acute hypoxemic respiratory failure. It is central to predicting which patient population will benefit from this technique in order to avoid delaying further actions.

Objectives. We aimed to determine whether 24 h test of awake prone positioning could identify patients needing tracheal intubation in the first 72 h after hospital admission.

Methods. A total of 523 consecutive adult patients admitted to the ICU under high-flow oxygen therapy (HFO) were eligible for participation with COVID-19 acute hypoxemic respiratory failure. Exclusion criteria were any contraindications to APP and acute hypercapnic respiratory failure.

Results. 522 patients were analyzed.

96 patients (18.4%) were intubated for invasive ventilation within 3 days hours after the start of awake-prone positioning.

Intubated patients were more tachypneic and hypoxemic (Figure 1). Otherwise, there were no differences between the two groups, neither concerning patient characteristics nor other ventilatory parameters and hemodynamic parameters (Table).

Baseline characteristics that had an independent association with intubation within 3 days were a baseline age > 61 years old, BMI ≥ 35 kg/m², and respiratory rate ≥ 27 breaths/min. The AUC-ROC for the multivariable model using these baseline characteristics was 0.75 (95%CI 0.69 to 0.80) (Fig. 1A). Responses to awake prone positioning that had an independent association with intubation were failure to increase PaO₂ > 16 mmHg, and failure to increase the ROX index > 1.64 (Fig. 1B).

Conclusions. In this cohort, one out of five patients needed intubation for invasive ventilation within 3 days after the first session of awake proning.

The effects of awake prone positioning on oxygenation and respiratory rate in patients with acute hypoxemic respiratory failure due to COVID-19 had moderate prognostic capacity for intubation within the first 72 h.

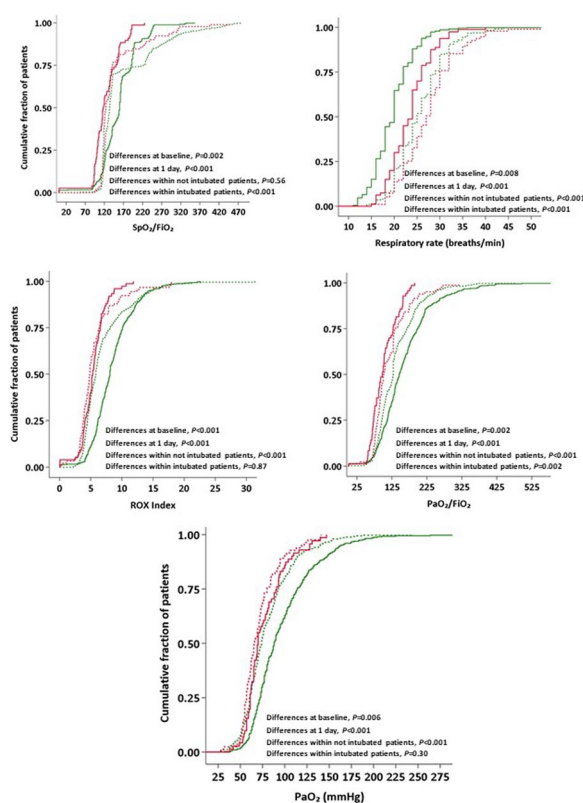

Cumulative frequency distribution of the study variables SpO₂/FiO₂, respiratory rate, ROX index, PaO₂/FiO₂ and respiratory rate.

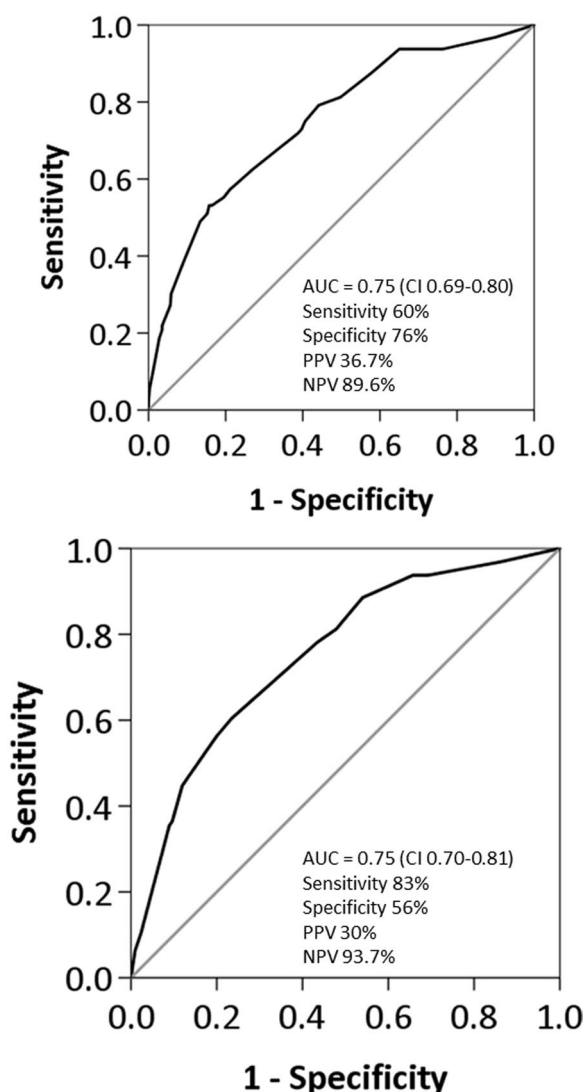

(A) ROC curve for the multivariable model of baseline variables associated with intubation on day 3 and independent predictors of intubation on day 3, based on age > 61 years/old, respiratory rate, BMI ≥ 35 kg/m² and respiratory rate ≥ 27/min at baseline. (B) ROC curve for the multivariable model, based on age > 61 years/old, BMI ≥ 35 kg/m², change in respiratory PaO₂, and ROX index from after 1 day from supine to prone.

Table 1 (abstract) Demographic and clinical characteristics between intubated and non-intubated patients during the first day of prone position

Variable	No Intubation [N = 426]	Intubation [N = 96]	P
Age, years*	55 [45; 64]	63.5 [54.5; 69.5]	<0.001
Gender, female**	103 [24.2%]	28 [29.2%]	0.31
BMI [kg/m ²]	30 [27.54; 33.24]	30.3 [27.7; 35.92]	0.25
Flow [L/min]*	60 [60; 60]	60 [60; 70]	0.07
Total time of the first day of prone position [hours]*	12 [8-16]	12 [6-16]	0.16
Days in prone position [days]	5 [3-8]	3 [2-5]	<0.001
Time from admission to first prone position [hours]*	2 [1; 3]	6 [4; 7]	<0.001

*median, interquartile range [IQR]; ** n [%]

Demographic and clinical characteristics of the studied population.

References

1. Ibarra-Estrada M, Li J, Pavlov I, Perez Y, Roca O, Tavernier E, et al. Factors for success of awake prone positioning in patients with COVID-19-induced acute hypoxemic respiratory failure: analysis of a randomized controlled trial. Crit Care. 2022;26:84.
2. This study is part of the PRONELIFE study which is supported from the ESICM

Topic: Acute respiratory failure and mechanical ventilation.

000225

Electrical impedance tomography during weaning from mechanical ventilation: an observational study during the spontaneous breathing trial

J. Wisse-Smit¹, T. Goos², A. Jonkman¹, H. E. Endeman¹, I. Reiss², D. Gommers¹

¹Adult Intensive Care, Erasmus University Medical Center, Rotterdam, Netherlands; ²Neonatology and Paediatrics, Division of Neonatology, Erasmus MC Sophia Kinderziekenhuis, Rotterdam, Netherlands

Correspondence: J. Wisse-Smit

Intensive Care Medicine Experimental 2023, 11(Suppl 1):000225.

Introduction. Ventilator liberation should be initiated as early as feasible and safe to limit the detrimental effects from prolonged mechanical ventilation and sedation [1,2]. However, though essential, choosing the right moment for weaning and extubation is still challenging. We hypothesized that electrical impedance tomography (EIT) could be a promising non-invasive lung imaging modality to support weaning decisions [3].

Objectives. The aim of this study was to describe 1) the detailed evolution of EIT parameters during a spontaneous breathing trial (SBT), and 2) the relation between EIT parameters and SBT success or failure.

Methods. Adult patients receiving invasive mechanical ventilation (more than 72 h) were eligible for inclusion. Continuous EIT monitoring was performed around a T-piece SBT. EIT parameters, (end-expiratory lung impedance (EELI), tidal impedance (dZ) and global inhomogeneity index (GI)), were computed on a breath-by-breath basis. Trends and between-group differences (SBT success vs. failure) were analyzed using linear mixed-effects models.

Results. Twenty-four patients were included (58% male; age: 62.0 ± 10.2 y, BMI: 26.7 ± 5.0 kg/m², 11.2 ± 6.1 days of ventilation). Figure 1A shows a significant drop in EELI after the start of the SBT, which did not recover to its baseline value after restarting mechanical ventilation. Other trends were a significant drop in dZ and a significant increase in the GI after the start of the SBT. These changes continued during the full length of the SBT, but (contrary to the EELI) restored to their baseline value after restarting mechanical ventilation.

Significant differences between patients with a successful (n = 19) and a failed (n = 5) SBT were found, with a higher GI in patients who failed the SBT. The distinction in GI between the two groups was present at all time points including the timepoint before initiation of the SBT (Fig. 1B).

Conclusions. Insight in physiological trends for the individual patient can be obtained with EIT during weaning from mechanical ventilation. De-recruitment during the SBT is common, observed by a drop in EELI without loss of tidal volume (dZ). An elevated GI might be a predictor for weaning failure, but this requires further study in a larger cohort.

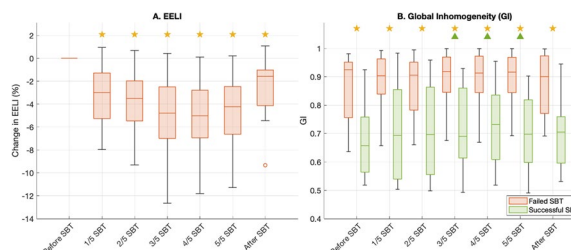

Figure 1 (abstract 000225) A. Detailed description of % change in EELI during the SBT. Parameters were extracted at 5 moments during the SBT and compared to the baseline value (before SBT). Yellow stars

indicate significant differences compared to the baseline value. B. GI index of patients with a failed and successful SBT. Yellow stars indicate significant differences between the two groups. The green triangles indicate a significant trend compared to baseline for the successful patients

References

1. The study received financial support from Sentec AG.
2. [3] J. Lima et al. Electrical impedance tomography monitoring during spontaneous breathing trial: Physiological description and potential clinical utility. *Acta Anaesthesiol Scand.* 2019;63(8):1019–27.
3. [2] J.Hall et al. Liberation of the Patient From Mechanical Ventilation. *JAMA.* 1987;257(12):1621–8.
4. [1] G.Beduneau et al. Epidemiology of weaning outcome according to a new definition the WIND study. *Am J Respir Crit Care Med.* 2017;195(6):772–83.

Topic: Acute respiratory failure and mechanical ventilation.

000226

Delirium during intensive care unit admission and perceived quality of life

B. Lobo Valbuena¹, R. Molina¹, A. Abella¹, L. Lopez De La Oliva Calvo¹, M. M. Garcia-Arias¹, I. Salinas¹, R. Castañeda Vozmediano², F. Gordo Vidal¹

¹Intensive Care Unit, H. U del Henares, Madrid, Spain; ²Research Support Unit, Medical School, Universidad Francisco de Vitoria, Madrid, Spain

Correspondence: B. Lobo Valbuena

Intensive Care Medicine Experimental 2023, **11(Suppl 1)**:000226

Introduction. Survivors of critical illness are frequently left with a long-lasting disability. Moreover, delirium or acute confusional syndrome is a severe neuropsychiatric disorder associated with multiple complications and a worse short- and long-term prognosis. We hypothesised that patients who developed delirium during ICU stay, compared with patients who did not, would have worse health-related quality of life following a critical illness.

Methods. Prospective longitudinal observational and analytical study assessing perceived quality of life measured with the Barthel Index, the Clinical Frailty Scale, and the SF-36, comparing patients who developed delirium during ICU stay and patients who did not.

Results. In a cohort of 1462 patients, we selected controls for the 93 patients who developed delirium. Of 156 completed questionnaires (84,7%), we observed that (a) in each of the two groups of patients, the scores related to the physical aspect of quality of life tended to improve over time ($p < 0,001$), being consistently less favourable in the group of patients who developed delirium compared to the group of controls ($p < 0,001$); (b) the patients who developed delirium also presented lower scores on the SF-36 scale, these differences being statistically significant, and therefore evidencing a worse quality of life, with impact on both the psychological and social spheres ($p < 0,001$).

Conclusions. Patients who developed delirium had significantly lower scores two years after hospital discharge on the three used questionnaires, displaying a clear negative impact on the physical, psychological, and social dimensions. The study's results reinforce the need to support and strengthen the care of ICU survivors. Moreover, this study has contributed to the improvement of the Protocol for the prevention and early detection of post-intensive care syndrome, initiated in our hospital center in 2018.

References

1. Goldberg TE, Chen C, Wang Y, Jung E, Swanson A, Ing C, et al. Association of Delirium With Long-term Cognitive Decline: A Meta-analysis. *JAMA Neurol.* 2020;77(11):1373–81.
2. van den Boogaard M, Schoonhoven L, Evers AW, van der Hoeven JG, van Achterberg T, Pickkers P. Delirium in critically ill patients: impact on long-term health-related quality of life and cognitive functioning. *Crit Care Med.* 2012;40(1):112–8

3. Lobo-Valbuena B, Gordo F, Abella A, Garcia-Manzanedo S, Garcia-Arias MM, Torrejón I, et al. Risk factors associated with the development of delirium in general ICU patients. A prospective observational study. *PLoS One.* 2021;16(9):e0255522.
4. Wolters AE, van Dijk D, Pasma W, Cremer OL, Looije MF, de Lange DW, et al. Long-term outcome of delirium during intensive care unit stay in survivors of critical illness: a prospective cohort study. *Crit Care.* 2014;18(3):R125.
5. Estrup S, Kjer CKW, Vilhelmsen F, Poulsen LM, Gøgenur I, Mathiesen O. Cognitive Function 3 and 12 Months After ICU Discharge-A Prospective Cohort Study. *Crit Care Med.* 2018;46(12):e1121–e7.
6. Salluh JI, Wang H, Schneider EB, Nagaraja N, Yenokyan G, Damluji A, et al. Outcome of delirium in critically ill patients: systematic review and meta-analysis. *Bmj.* 2015;350:h2538.

Topic: Sedation, analgesia and delirium.

000227

The impact of macronutrient restriction in critically ill patients with and without relative hypophosphatemia: a secondary analysis of the EPaNIC RCT

C. Lauwers¹, L. Langouche¹, G. Van den Berghe¹, A. Wilmer², P. Wouters¹, J. Gunst¹, M. Casaer¹

¹Laboratory of Intensive Care Medicine, Academic Department Of Cellular And Molecular Medicine, KU Leuven, Leuven, Belgium; ²Medical intensive care, KU Leuven, Leuven, Belgium

Correspondence: C. Lauwers

Intensive Care Medicine Experimental 2023, **11(Suppl 1)**:000227

Introduction. Hypophosphatemia may be a hallmark of refeeding-related metabolic complications. In the refeeding syndrome trial (1), standard nutrition as compared to nutrient restriction increased mortality in patients who developed hypophosphatemia upon feeding, despite adequate phosphate and micronutrient provision. As such, a decline of phosphate upon feeding may signal a metabolism unfit for proper substrate oxidation and may predict potential harm by enhanced feeding.

Objectives. We aimed to assess the differential impact of early versus delayed administration of Parenteral Nutrition (PN) in patients whose phosphate levels declined early after intensive care unit (ICU) admission and in patients with stable phosphatemia.

Methods. This is a secondary analysis of the randomised controlled EPaNIC trial (2) that studied the impact of withholding PN (Late PN) versus early full feeding (Early PN) in critically ill patients during the first week in ICU (n=4640). Relative hypophosphatemia (RHP) was defined as a decrease of >0.16 mmol/l between the first and second ICU days. Patients with an available phosphate measurement on both days were included. The effect of Early versus Late PN on outcome in groups with and without RHP was assessed by adjusted logistic and Cox regression models. These analyses were repeated with an interaction term combining the feeding intervention and occurrence of RHP, and in propensity score-matched groups of RHP patients to correct for RHP occurring eventually more in one study arm.

Results. RHP occurred overall in 23.7% (834 out of the 3520 included patients) and was more frequent in patients on Late PN (26.3% n=471) than Early PN (21.0% n=363, $p=0.0002$). Among patients with RHP, patients randomised to Late PN as compared to Early PN had a shorter ICU stay (4d vs 6d, $p < 0.0001$), a higher likelihood of an earlier alive ICU discharge (HR 1.26 (1.09–1.46)) and definite weaning from mechanical ventilation (MV)(HR 1.26(1.09–1.46)), a lower hospital mortality (12.1% vs 17.4%, $p=0.03$), a lower rate of infections (26.1% vs 38.0%, $p=0.0002$) and a shorter duration of kidney replacement therapy (KRT) (7.5d vs 15d, $p=0.01$), which was not the case in the group with stable phosphatemia. For ICU stay, alive ICU discharge and definite weaning of MV, RHP significantly interacted with the randomised feeding intervention. In the matched subgroups (two groups

of 356 patients) of RHP patients, patients randomised to Late PN as compared to Early PN had a shorter ICU stay (3d vs 6d, $p < 0.0001$), a higher likelihood of an earlier alive ICU discharge (HR 1.77(1.50–2.08)) and definite weaning from MV (HR 1.54(1.31–1.80)), a lower ICU, hospital and 90-day mortality (5.6% vs 10.1%, 11.5% vs 17.1%, 11.1% vs 16.7%, resp., $p = 0.03$ for all), a lower rate of infections (21.4% vs 38.8%, $p < 0.0001$) and a shorter duration of KRT (8d vs 16d, $p = 0.005$).

Conclusions. Patients with RHP randomised to Late PN as compared to Early PN experienced better outcomes. Monitoring phosphate levels and reducing macronutrient intake in patients developing RHP may improve outcome.

References

- Doig GS, Simpson F, Heighes PT, Bellomo R, Chesher D, Caterson ID, Reade MC, Harrigan PW; Refeeding Syndrome Trial Investigators Group. Restricted versus continued standard caloric intake during the management of refeeding syndrome in critically ill adults: a randomised, parallel-group, multicentre, single-blind controlled trial. *Lancet Respir Med.* 2015 Dec;3(12):943–52.
- Casaer MP, Mesotten D, Hermans G, Wouters PJ, Schetz M, Meyfroidt G, Van Cromphaut S, Ingels C, Meersseman P, Muller J, Vlasselaers D, Debavay Y, Desmet L, Dubois J, Van Assche A, Vanderheyden S, Wilmer A, Van den Berghe G. Early versus late parenteral nutrition in critically ill adults. *N Engl J Med.* 2011 Aug 11;365(6):506–17.
- M.P. Casaer holds a postdoctoral research fellowship granted by the Research Foundation, Flanders. J. Gunst holds a postdoctoral research fellowship granted by the University Hospitals Leuven. J. Gunst and M.P. Casaer receive C2 project funding by KU Leuven. G. Van den Berghe and L. Langouche receive structural research financing by the Methusalem programme of the Flemish Government through the University of Leuven (METH14/06), and a European Research Council (ERC) Advanced Grant from the Horizon 2020 Program of the EU (AdvG-2017-785809).

Topic: Metabolism, endocrinology, liver failure and nutrition.

000228

Does reinforcement learning improve outcomes for critically ill patients? A systematic review and level-of-readiness assessment

M. Otten¹, A. Jagesar¹, T. A. Dam¹, LA. Biesheuvel¹, F. Hengst², KA. Ziesemer³, P. J. Thoral¹, H. J. De grooth¹, A. Girbes¹, V. François-Lavet², M. Hoogendoorn², P. Elbers¹

¹Intensive Care Adults, Amsterdam UMC, locatie VUmc, Amsterdam, Netherlands; ²Computational Intelligence, Vrije Universiteit Amsterdam, Amsterdam, Netherlands; ³University Library, Amsterdam UMC, locatie VUmc, Amsterdam, Netherlands

Correspondence: M. Otten

Intensive Care Medicine Experimental 2023, **11(Suppl 1)**:000228

Introduction. Reinforcement learning (RL) is a machine learning technique uniquely effective at sequential decision making [1], which makes it potentially relevant to intensive care unit (ICU) treatment challenges. We set out to systematically review, assess level-of-readiness and meta-analyze the effect of RL on outcomes for critically ill patients.

Methods. A systematic search was performed in 5 relevant databases from inception to March 25th 2022, with subsequent citation tracking. Journal articles that used any reinforcement learning technique in an ICU population and reported on patient health related outcomes were included for full analysis. Conference papers were included for level-of-readiness assessment only [2]. Descriptive statistics, characteristics of the models, outcome compared to clinician’s policy and level-of-readiness were collected. RL-health risk of bias and applicability assessment was performed.

Results. A total of 1033 articles were screened, of which 18 journal articles and 20 of conference papers were included (Fig. 1) [3]. Thirty of the included articles were prototyping or modelling articles and six were validation articles (Fig. 2). Applications of RL in the ICU in the included articles were related to sepsis treatment with vasopressors and intra-venous fluids, heparin dosing, dosing of propofol and fentanyl, blood glucose control, ventilator setting optimization, all medication dosing, insulin dosing and antibiotic treatment. All articles reported RL-algorithms to outperform clinical decision making by intensive care professionals in retrospective data with off-policy evaluation. The modelling techniques for the state-space, action-space, reward function, RL model training and evaluation varied widely. The risk of bias was high in all articles, mainly due to the evaluation procedure. A meta-analysis on outcomes relevant to critically ill patients proved unfeasible given the heterogeneity of clinical focus and reporting amongst studies.

Conclusions. In this first systematic review on the application of RL in intensive care medicine we found no studies that demonstrated improved patient outcomes from RL-based technologies. All studies reported that RL-agent policies outperformed clinician policies, but such assessments were all based on retrospective off-policy evaluation.

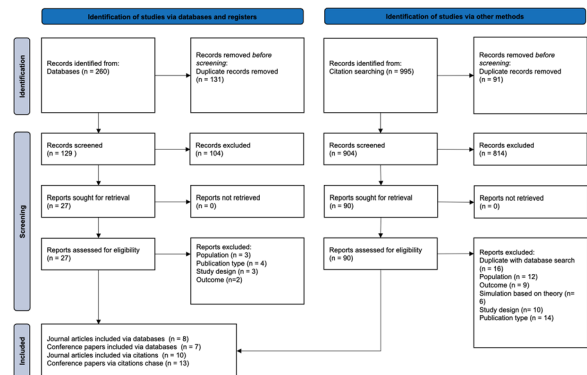

Figure 1 (abstract 000228) Flowchart of article inclusion

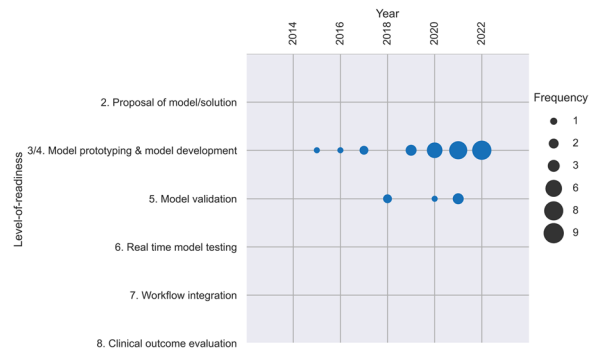

Figure 2 (abstract 000228) Level-of-readiness over time

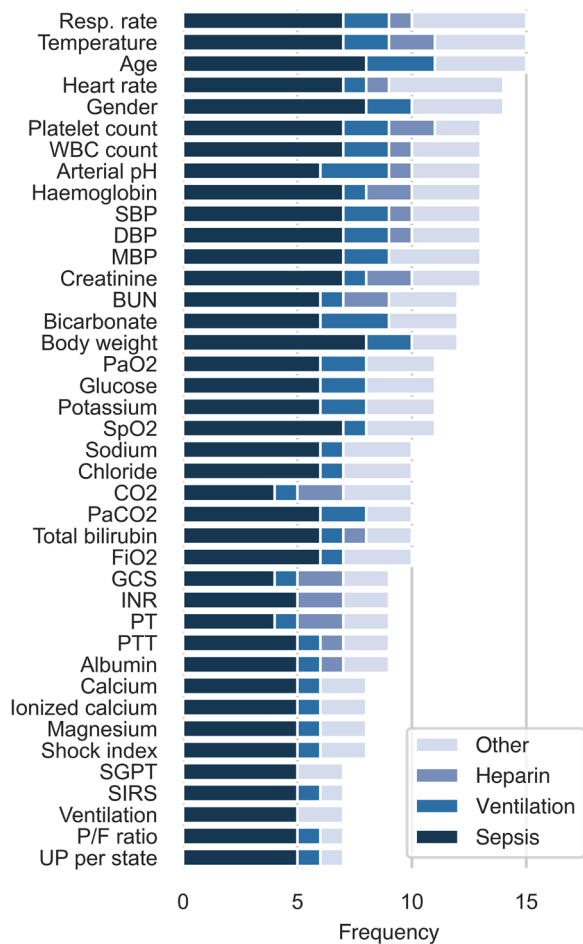

Figure 3 (abstract 000228) Frequency of included variables for state-space per application
 Resp., respiratory; SpO2, oxygen saturation pulse oximetry; MBP, mean blood pressure; SBP, systolic blood pressure; DBP, diastolic blood pressure; WBC, white blood cell; BUN, blood urea nitrogen; PaO2, partial pressure of oxygen; PaCO2, partial pressure of carbon dioxide; GCS, Glasgow coma scale; INR, international normalized ratio; PT, prothrombin time; FiO2, inspired oxygen fraction; CO2, carbon dioxide; PTT, partial thromboplastin time; SGPT, serum glutamic pyruvic transaminase; P/F, PaO2/FiO2 Ratio; SIRS, Systemic Inflammatory Response Syndrome; UP, urine product.

References

- Sutton RS, Barto AG (2018) Reinforcement learning: An introduction, 2nd ed. The MIT Press, Cambridge, MA, US
- Fleuren LM, Thorat P, Shillan D, et al. (2020) Machine learning in intensive care medicine: ready for take-off? *Intensive Care Med* 46:1486–1488. <https://doi.org/10.1007/s00134-020-06045-y>
- Page MJ, McKenzie JE, Bossuyt PM, et al. (2021) The PRISMA 2020 statement: an updated guideline for reporting systematic reviews. *BMJ* 372:n71. <https://doi.org/10.1136/bmj.n71>

Topic: Data Science.

000229

Exploring the anticholinergic burden (ACB) in elderly patients with a subdural haematoma (SDH) admission to a Neurointensive Care Unit (NICU)

D. Young¹, S. Virdee¹, R. Beecham², K. Ibrahim³, T. Nicholson-Roberts², C. McKenzie¹

¹Pharmacy department, Southampton General Hospital, Southampton, United Kingdom; ²Critical care department, Southampton General Hospital, Southampton, United Kingdom; ³Faculty of Medicine, University of Southampton, Southampton, United Kingdom

Correspondence: D. Young

Intensive Care Medicine Experimental 2023, **11(Suppl 1)**:000229

Introduction. A high anticholinergic burden (ACB) occurs after exposure to certain medications, including antimuscarinics, antihistamines and selected antipsychotics. In older people (> 65 years), a high ACB could lead to falls, confusion, delirium and dementia. A subdural haematoma (SDH) presentation to a Neurointensive Care Unit (NICU) in > 65 years is devastating as it is associated with a high risk of death and loss of independent living (1). Our aim was to explore the prevalence of medications with anticholinergic effects among older inpatients with a SDH presentations in NICU admission in a tertiary referral teaching hospital.

Objectives. To explore the prevalence of ACB in older patients admitted to NICU with diagnosis of SDH on admission; establish any changes/exposure to medications with anticholinergic effects and whether these were documented on discharge.

Methods. Retrospective cohort review of older patients admitted to NICU during 2021–2022 with a diagnosis of SDH was conducted. ACB was estimated using a validated tool (the Anticholinergic Effect on Cognition (AEC) scale) with significant exposure defined as at least one medicine with an AEC score ≥ 2 or total AEC score > 3 (2).

Results. Of 59 older patients admitted to NICU with a SDH, 50 (84.7%) had a pharmacy-verified medication history and thus were suitable for inclusion. The median [IQR] age was 74 [69–79] years and 34 (68%) admitted with a traumatic SDH. 13 of 50 (26%) had documentation of anticholinergic medications on NICU admission; 9 of 50 (18%) had a significant AEC score. Ten patients (20%) died during admission (9 taking no medications with an AEC score > 0). The median hospital stay was 28 [6–38] days. Of the 13 patients taking AEC medicines before hospitalisation, half had at least one anticholinergic medicine discontinued during admission, however only one discharge summary had documentation of either anticholinergic medicine presence or changes to these medications.

Conclusions. Approximately a quarter of older patients admitted with SDH were taking medications with anticholinergic properties; 18% had a significant AEC score that may have contributed to their NICU admission. AEC medications were frequently stopped during admission although documentation of this to community healthcare teams was poor. Future research should focus on a larger dataset series with linear regression analysis to assess relative risk of significant AEC score in this devastating condition.

References

- Manivannan S, Spencer R, Marei O, Mayo I, Elalfy O, Martin J, et al. Acute subdural haematoma in the elderly: to operate or not to operate? A systematic review and meta-analysis of outcomes following surgery. *BMJ Open*. 2021 Dec;11(12):e050786.

2. Bishara D, Harwood D, Sauer J, Taylor DM. Anticholinergic effect on cognition (AEC) of drugs commonly used in older people. *Int J Geriatr Psychiatry*. 2017 Jun;32(6):650–6.

Topic: Neurointensive care.

000230

When are alarms most relevant: a temporal analysis of alarm relevance in the intensive care setting

M. Prendke¹, A. R. Flint¹, K. Rubarth¹, F. Balzer¹, A. S. Poncette¹

¹Institute of Medical Informatics, Charité-Universitätsmedizin Berlin, Berlin, Germany

Correspondence: M. Prendke

Intensive Care Medicine Experimental 2023, **11(Suppl 1)**:000230

Introduction. Alarm fatigue, the desensitization to too many, often irrelevant alarms, is highly common on modern ICUs and endangers patient safety [1]. To counteract alarm fatigue and alleviate alarm load, it is crucial to be aware of irrelevant and therefore avoidable alarms. It has been shown that the number of alarms is influenced by time of day, being highest in the morning and declining throughout the day and that many avoidable technical alarms worsen the alarm load [2]. For a better understanding of avoidable alarms relevance-annotated alarm data is necessary [3]. If the alarm relevance for certain time intervals is known, medical staff can act accordingly, e.g., adjusting alarm thresholds and alarm pauses.

Objectives. Investigate the temporal perspective of alarm relevance, analyzing patterns during the course of a day as well as on different weekdays.

Methods. Following IRB approval (Ethics vote no. EA1/127/18), retrospective analysis of annotated alarm data [4] from 07–09/2022 (one 21-bed ICU, 92 days, 210 patients, 175,804 alarms). An alarm is annotated as actionable and considered relevant if followed by related medical intervention. Metrics: Mean number (M), standard deviation (SD) of alarms per minute (I) and per weekday (II) in the ICU investigated. Positive predictive value (PPV) as the probability of alarm being actionable. Binomial generalized linear mixed-effects models with shift (I) and day of the week (II) as predictors, patient id as random effect, rate of actionable alarms as response to analyze differences in alarm relevance between shifts (I) and weekdays (II) by Odds Ratios (OR) with 95% Wald-Confidence Intervals (CI). Due to exploratory nature of study, we abstain from using Bonferroni correction of significance level.

Results. The number of alarms decreases during the day, while PPV increases. The two curves seem reversely related (Fig. 1). Mean PPV per shift is 0.115 (SD = 0.042) for morning, 0.140 (SD = 0.047) for afternoon and 0.150 (SD = 0.061) for night shift. There was a significant difference in alarm relevance between morning and night shift (OR: 1.559, CI [1.204, 2.020], $p = 0.001$), while the difference between morning and afternoon (OR: 1.278, CI [0.961, 1.700], $p = 0.091$) as well as between afternoon and night shift (OR: 1.217, CI [0.914, 1.621], $p = 0.179$) were not statistically significant. The mean number of alarms increases during the workweek and decreases from Friday through the weekend. PPV is highest at beginning of the week (maximum on Mon $M = 0.155$, $SD = 0.049$), decreases in the second half of the week starting on Thursday (minimum on Saturday $M = 1.121$, $SD = 0.041$) and is on average lower on the weekend (PPV $M = 0.123$, $SD = 0.037$) than during the week (PPV $M = 0.137$, $SD = 0.046$) (Fig. 2). The difference in alarm relevance between weekend and workweek is significant (OR: 1.848, CI [1.365, 2.501], $p < 0.001$).

Conclusions. This research confirms the known pattern of declining alarm load during the day [2] for relevant as well as irrelevant alarms. From a temporal perspective, alarm relevance is reversely related to the total number of alarms. This can be explained by more irrelevant alarms when patients are more active, staff are interacting with the patient or manipulating equipment. Data interpretation is limited by data being collected in a routine clinical setting, including e.g., stress, handover situations, which influence alarm occurrence and management. Further research is needed to confirm this study's findings

depending on alarm-issuing device, alarm type, set alarm threshold and patient characteristics.

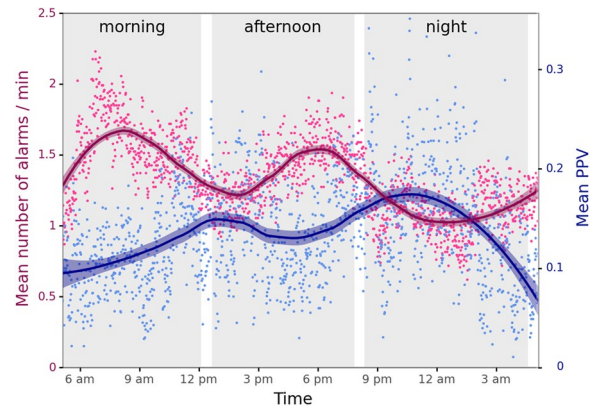

Figure 1 (abstract 000230) Mean number of alarms (pink) and PPV (blue) per each one-minute time interval of a 24 h day. The grey bars visualize the morning, afternoon, and night shifts, while the white spaces inbetween represent handover periods. The lines are calculated by a LOESS smoothing function, the less intensely colored band width shows the respective 99% CI

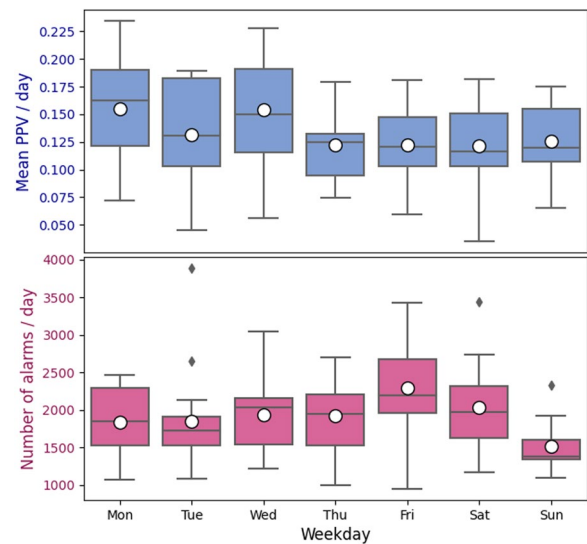

Figure 2 (abstract 000230) Distribution of number of alarms (pink) and PPV (blue) per weekday as boxplots. Arithmetic mean of values for each weekday as white dot in box. The investigated time interval does not include national holidays

References

- [1] Sendelbach S, Funk M. Alarm fatigue: a patient safety concern. *AACN Adv Crit Care*. 2013;24(4):378–388. <https://doi.org/10.1097/NCI.0b013e3182a903f9>
- [2] Poncette AS, Wunderlich MM, Spies C, et al. Patient Monitoring Alarms in an Intensive Care Unit: Observational Study With Do-It-Yourself Instructions. *J Med Internet Res*. 2021;23(5):e26494. Published 2021 May 28. <https://doi.org/10.2196/26494>
- [3] Winters BD, Cvach MM, Bonafide CP, et al. Technological Distractions (Part 2): A Summary of Approaches to Manage Clinical Alarms With Intent to Reduce Alarm Fatigue. *Crit Care Med*. 2018;46(1):130–137. <https://doi.org/10.1097/CCM.0000000000002803>

4. [4] Klopfenstein SAI, Flint AR, Heeren P et al. How to Annotate Patient Monitoring Alarms in Intensive Care Medicine for Machine Learning, 14 February 2023, PREPRINT (Version 1) available at Research Square [<https://doi.org/10.21203/rs.3.rs-2514969/v1>]. Accessed 07/04/2023.
5. INALO project (grant 16SV8559, German Federal Ministry of Education and Research)

Topic: Critical care organisation, quality management, information systems, outcomes.

000232

Evaluating deprescribing opportunities in the intensive care

A. Lagrotteria¹, M. Geromella,² C. Hamielec³
¹Critical Care Medicine, Queen's University, University Avenue, Kingston, ON, Canada, Kingston, Canada; ²Applied Health Sciences, Brock University, Sir Isaac Brock Way, St. Catharines, ON, Canada, St. Catharines, Canada; ³Critical Care Medicine, McMaster University, Main Street West, Hamilton, ON, Canada, Hamilton, Canada

Correspondence: A. Lagrotteria
Intensive Care Medicine Experimental 2023, **11(Suppl 1)**:000232

Introduction. The prevalence of potentially inappropriate medications (PIMs) in older adults is a pervasive public health concern. Admission to an intensive care unit (ICU) affords an opportunity to review and reduce prescribing harm.

Objectives. The objective of this study was to evaluate the deprescribing practices of PIMs in an ICU setting.

Methods. We evaluated deprescribing practices of PIMs following admission to ICU. A retrospective chart review was conducted on patients who were 60 years or older, hospitalized between June 1, 2013 and June 1, 2015, at a tertiary hospital in Hamilton, Ontario. Medications listed in the 2015 Beer's Criteria and opioids without a cancer diagnosis were marked as PIMs. Discharge records were used to identify PIMs that were deprescribed.

Results. Seventy-two patients with a mean age of 72.3 and an average of 2.6 co-morbidities were included in the study. The majority of patients admitted and discharged from ICU (88.8% and 81.9%, respectively) were found to be taking at least one PIM. Of the total medications at ICU admission, 30.6% were identified as PIMs, and half of these (50.5%) were successfully deprescribed. The mean number of PIMs prescribed at ICU admission was 2.64, which decreased to 1.92 at ICU discharge ($p = 0.01$). The most frequently deprescribed PIMs were opioids (26%), antipsychotics (26%), anti-hypertensives (17%), and NSAIDs (17%). The number of patients with zero PIMs increased from 11.1% to 18% at ICU discharge and 37.5% at hospital discharge. Overall, 31.2% of the study population were successfully deprescribed all PIMs by time of discharge from hospital.

Conclusions. The results of this study highlight the prevalence of PIMs among older adults admitted to the ICU and the potential benefits of deprescribing practices in this setting. The high success rate of PIMs deprescribed per patient subsequent to their ICU stay underscores the opportunity this setting presents to healthcare professionals to initiate deprescribing and improve medication use and outcomes for this particularly vulnerable patient population.

Topic: Critical care organisation, quality management, information systems, outcomes.

000236

Coping strategies, modifiers and supports that allow intensivists to flourish in the ICU setting

D. Dennis¹, P. Vernon Van Heerden², C. Knott³, A. Calhoun⁴, R. Khanna⁵
¹Departments of Intensive Care and Physiotherapy, Sir Charles Gairdner Hospital, Perth, Australia; ²Department of anesthesiology, critical care and pain medicine, Hadassah Medical Center, The Hebrew University of Jerusalem, Jerusalem, Israel; ³Department of Intensive Care, Bendigo Health; Monash Rural Health; Monash University; Austin Health; University of Melbourne, Melbourne, Australia; ⁴Department of Pediatrics, Division of Critical Care, and Norton Children's Medical Group, University

of Louisville, Louisville, United States of America; ⁵Phoenix Australia, Australian National Centre of Excellence in Posttraumatic Mental Health, Melbourne, Australia

Correspondence: D. Dennis
Intensive Care Medicine Experimental 2023, **11(Suppl 1)**:000263

Introduction. The intensive care unit (ICU) environment is by nature a highly stressful one for all who navigate the space. Patients are often gravely unwell; relatives and friends encounter noisy and often chaotic conditions; staff work with a consistent need to function at their best both as individuals and as part of a closely articulated team. Aligned to their inevitable high acuity, poor patient outcomes may add to the hostility of the specialty for healthcare providers. Little research has examined the impact of this environment on clinicians, and how they manage these stressors.

Objectives. This study aimed to explore the coping strategies employed by experienced intensivists and the things that moderated their response positively to the stressors within the ICU environment. It also aimed to identify support pathways available.

Methods. Experienced intensivists from seven centres in three countries were interviewed in this prospective qualitative study. In a semi-scripted iterative interview, participants were asked how they managed their emotions in the ICU. Audio-recordings were transcribed, and thematically analysed, and emerging themes and sub-themes are described.

Results. Participants reported a wide range of strategies, including normalising and contextualising the stressful event; compartmentalising stressors; separating work and home life; and having a level of acceptance that things do not always go in the way they are anticipated. Most endorsed the utility of professional support, but few disclosed accessing such services personally, which may reflect a perceived stigma attached to doing so. Many described a sense of responsibility for the wellbeing of other staff. Factors that mitigated stressors included positive and mutual respectful relationships with colleagues, patients and their families; and taking away new knowledge from episodes involving poor patient outcome.

Conclusions. Intensivists described several ways that they managed and mitigated the effect of ICU environmental stressors. They perceived a level of stigma in seeking professional help for themselves. They also expressed a need to provide support to other team members within the ICU, however acknowledged limited training to do so.

References

1. Hall LH, Johnson J, Watt I, Tsipa A, O'Connor DB. Healthcare Staff Wellbeing, Burnout, and Patient Safety: A Systematic Review. *PLoS One*. 2016;11(7):e0159015.
2. Burghi G, Lambert J, Chaize M, Goinheix K, Quiroga C, Fariña G, et al. Prevalence, risk factors and consequences of severe burnout syndrome in ICU. *Intensive Care Med*. 2014;40(11):1785-6.
3. U.S. Department of Health and Human Services (DHHS). A Guide to Managing Stress in Crisis Response Professions. Rockville, Maryland, USA: Center for Mental Health Services, Substance Abuse and Mental Health Services Administration; 2005 [Available from: <https://www.theschwartzcenter.org/media/SAMHSA.-Guide-to-Managing-Stress-in-Crisis-Response-Professions.pdf>].
4. Gale NK, Heath G, Cameron E, Rashid S, Redwood S. Using the framework method for the analysis of qualitative data in multi-disciplinary health research. *BMC Medical Research Methodology*. 2013;13(1):117.
5. Fox S, Lydon S, Byrne D, Madden C, Connolly F, O'Connor P. A systematic review of interventions to foster physician resilience. *Postgrad Med J*. 2018;94(1109):162-70.
6. O'Dowd E, O'Connor P, Lydon S, Mongan O, Connolly F, Diskin C, et al. Stress, coping, and psychological resilience among physicians. *BMC Health Serv Res*. 2018;18(1):730.
7. McKenna AM, Straus SE. Charting a professional course: a review of mentorship in medicine. *J Am Coll Radiol*. 2011;8(2):109-12.
8. Sambunjak D, Straus SE, Marusic A. A systematic review of qualitative research on the meaning and characteristics of mentoring in academic medicine. *J Gen Intern Med*. 2010;25(1):72-8.

9. 2018 Cockell Grant from the Raine Medical Research Foundation (Perth, Australia)
10. 2021 North Metropolitan Health Service Building Allied Health Research Capacity Grant (Perth, Australia)
11. 2021 Sir Charles Gairdner Osborne Park Care Group Research Advisory Committee Charlies Research Foundation Grant (Perth, Australia)

Topic: Critical care organisation, quality management, information systems, outcomes.

000237

Constructing the persona of the intensivist: a qualitative study

D. Dennis¹, R. Khanna², C. Knott³, A. Calhoun⁴, P. Vernon Van Heerden⁵
¹Departments of Intensive Care and Physiotherapy, Sir Charles Gairdner Hospital, Perth, Australia; ²Phoenix Australia, Australian National Centre of Excellence in Posttraumatic Mental Health, Melbourne, Australia; ³Department of Intensive Care, Bendigo Health; Monash Rural Health; Monash University; Austin Health; University of Melbourne, Melbourne, Australia; ⁴Department of Pediatrics, Division of Critical Care, and Norton Children's Medical Group, University of Louisville, Louisville, United States of America; ⁵Department of anesthesiology, critical care and pain medicine, Hadassah Medical Center, The Hebrew University of Jerusalem, Jerusalem, Israel

Correspondence: D. Dennis

Intensive Care Medicine Experimental 2023, 11(Suppl 1):000237

Introduction. Intensivists are a distinctive subset of the medical profession who work within a persistently high-acuity high-stakes environment that defines an intensive care unit. They require a unique set of clinical and human skills, and an understanding of these attributes may be useful for both the people they work with as well as those considering future specialisation in the field.

Objectives. The aim of this study was to explore the self-perceived characteristics of Intensivists and in doing so, define and assemble the 'Intensivist persona' that might provide useful insight for the entire healthcare team.

Methods. This prospective qualitative study involved face-to-face interviews with 42 Intensivists in Australia, Israel and the USA who each had more than four year's clinical experience at a Consultant level. Participants were asked to describe typical personality traits of 'flourishing' Intensivists. They were also asked how they thought Intensivists were viewed by other healthcare providers external to the intensive care specialty. Interviews were audio recorded and transcribed; data were coded within a thematic framework using NVivo software. Authors then agreed upon and constructed personas of the contemporary Intensivist that reflected these themes.

Results. Seven personas were built according to how Intensivists saw themselves. These were the 'Fixer'; the 'Retriever'; the 'Diplomat'; the 'Negotiator'; the 'Pragmatist'; the 'Neurotic'; and the 'Duck'. A further three personas were created relating to how they perceived they were viewed by others. These were the 'Superhero'; the 'Naysayer'; and the 'Dictator'.

Conclusions. This study describes the personality traits of modern-day Intensivists as perceived by a subset of the group. These may or may not match the perceptions of other healthcare professional's perceptions but add to a better understanding of how intensivists see themselves.

References

1. Grenvik A, Pinsky MR. Evolution of the intensive care unit as a clinical center and critical care medicine as a discipline. *Crit Care Clin.* 2009;25(1):239–50.
2. Baker AB. Genesis of the College of Intensive Care Medicine of Australia and New Zealand. *Anaesth Intensive Care.* 2018;46(7):35–51.
3. Thompson K, Taylor C, Forde K, Hammond N. The evolution of Australian intensive care and its related costs: A narrative review. *Aust Crit Care.* 2018;31(5):325–30.
4. Borges NJ, Savickas ML. Personality and Medical Specialty Choice: A Literature Review and Integration. *Journal of Career Assessment.* 2002;10(3):362–80.

5. Zeldow PB, Daugherty SR. Personality profiles and specialty choices of students from two medical school classes. *Academic Medicine* 1991;66(5):283–7.
6. Reeve PE. Personality characteristics of a sample of anaesthetists. *Anaesthesia.* 1980;35(6):559–68.
7. Chowdhury JR, Channabasavanna SM, Prabhu GG, Sarmukaddam S. Personality and mental health of psychiatry residents. *Indian J Psychiatry.* 1987;29(3):221–7.
8. Borges NJ, Osmon WR. Personality and Medical Specialty Choice: Technique Orientation versus People Orientation. *Journal of Vocational Behavior.* 2001;58(1):22–35.
9. Bhattacharyya O, Mossman K, Gustafsson L, Schneider E. Using Human-Centered Design to Build a Digital Health Advisor for Patients With Complex Needs: Persona and Prototype Development. *Journal of medical internet research.* 2019;21(5):e10318-e.
10. Simpson N, Knott C. Stress and burnout in intensive care medicine: an Australian perspective. *Medical Journal of Australia.* 2017;206(3):107–8.
11. 2018 Cockell Grant from the Raine Medical Research Foundation (Perth, Australia)
12. 2021 North Metropolitan Health Service Building Allied Health Research Capacity Grant (Perth, Australia)
13. 2021 Sir Charles Gairdner Osborne Park Care Group Research Advisory Committee Charlies Research Foundation Grant (Perth, Australia)

Topic: Critical care organisation, quality management, information systems, outcomes.

000238

Advice for intensivists from intensivists: summation of a qualitative study

D. Dennis¹, R. Khanna², C. Knott³, A. Calhoun⁴, P. Vernon Van Heerden⁵
¹Departments of Intensive Care and Physiotherapy, Sir Charles Gairdner Hospital, Perth, Australia; ²Phoenix Australia, Australian National Centre of Excellence in Posttraumatic Mental Health, Melbourne, Australia; ³Department of Intensive Care, Bendigo Health; Monash Rural Health; Monash University; Austin Health; University of Melbourne, Melbourne, Australia; ⁴Department of Pediatrics, Division of Critical Care, and Norton Children's Medical Group, University of Louisville, Louisville, United States of America; ⁵Department of anesthesiology, critical care and pain medicine, Hadassah Medical Center, The Hebrew University of Jerusalem, Jerusalem, Israel

Correspondence: D. Dennis

Intensive Care Medicine Experimental 2023, 11(Suppl 1):000238

Introduction. As a healthcare professional, reflection upon one's own idiosyncrasies, behaviours, and attitudes that moderate performance and endurance is important. In synergy, the experiences of others also offer opportunities to gain insight and understanding. This study analysed the views of veteran intensive care medicine specialist doctors (Intensivists) as valued peer mentors on several issues affecting their day-to-day performance, mental wellbeing and burnout within the intensive care medicine specialty.

Objectives. The aim was to distil the anecdotes of experienced Intensivists into some pragmatic advice for doctors intending to work in the speciality in the future.

Methods. This was a prospective qualitative study involving face-to-face interview with Intensivists who had a minimum of 4 years of experience working at a consultant level at one of seven urban tertiary hospitals (Australian, n=3; Israeli, n=1, United States of America, n=3). Participants were asked as to the advice they would give if they could step back in time to mentor a younger version of themselves. Data was audio-recorded, transcribed and coded thematically. Verbatim quotations are presented to support coding choices.

Results. Forty-two participants (Australian, n=15; Israeli, n=6, United States of America, n=21) contributed to the dataset. The themes of advice that emerged were that it was better to have systems and processes in place to prevent certain events from happening; death and adverse events were inevitable; and that there should be a level of preparedness in terms of developing personal strategies and networks to manage these traumas.

Conclusions. The collated wisdom of expert Intensivists might guide the Intensivists of the future to improve practice.

References

- Moss, M., et al., An Official Critical Care Societies Collaborative Statement: Burnout Syndrome in Critical Care Health Care Professionals: A Call for Action. *Am J Crit Care*, 2016. 25(4): p. 368–76. <https://doi.org/10.4037/ajcc2016133>
- Vargas, M., et al., Burnout Among Anesthesiologists and Intensive Care Physicians: Results From an Italian National Survey. *Inquiry*, 2020. 57: p. 46,958,020,919,263. <https://doi.org/10.1177/0046958020919263>
- Chuang, C.H., et al., Burnout in the intensive care unit professionals: A systematic review. *Medicine (Baltimore)*, 2016. 95(50): p. e5629. <https://doi.org/10.1097/MD.0000000000005629>
- Simpson, N. and C. Knott, Stress and burnout in intensive care medicine: an Australian perspective. *Medical Journal of Australia*, 2017. 206(3): p. 107–108. <https://doi.org/10.5694/mja16.00626>
- Burgess, A., C. van Diggele, and C. Mellis, Mentorship in the health professions: a review. *Clin Teach*, 2018. 15(3): p. 197–202. <https://doi.org/10.1111/tct.12756>
- Sprung, C., R. Cohen, and J. Marini, Excellence in Intensive Care Medicine. *Critical Care Medicine*, 2016. 44(1): p. 202–206. <https://doi.org/10.1097/CCM.0000000000001435>
- Taylor, C.A., J.C. Taylor, and J.K. Stoller, The Influence of Mentorship and Role Modeling on Developing Physician–Leaders: Views of Aspiring and Established Physician–Leaders. *J Gen Intern Med*, 2009. 24(10): p. 1130–1134. <https://doi.org/10.1007/s11606-009-1091-9>
- Gale, N.K., et al., Using the framework method for the analysis of qualitative data in multi-disciplinary health research. *BMC Medical Research Methodology*, 2013. 13(1): p. 117. <https://doi.org/10.1186/1471-2288-13-117>
- Hollnagel, E., R.L. Wears, and J. Braithwaite, From Safety-I to Safety-II: A White Paper. 2015: The Resilient Health Care Net: Published simultaneously by the University of Southern Denmark, University of Florida, USA, and Macquarie University, Australia.
- 2018 Cockell Grant from the Raine Medical Research Foundation (Perth, Australia)
- 2021 North Metropolitan Health Service Building Allied Health Research Capacity Grant (Perth, Australia)
- 2021 Sir Charles Gairdner Osborne Park Care Group Research Advisory Committee Charles Research Foundation Grant (Perth, Australia)

Topic: Critical care organisation, quality management, information systems, outcomes.

000239

Prognostic performance of initial clinical examination in predicting good neurologic outcome in cardiac arrest patients treated with targeted temperature management

JS. Lee¹, HJ. Bang¹, CS. Youn¹, SH. Kim², S. Park³, HJ. Kim¹, KN. Park¹, S. Oh¹
¹Emergency Medicine, Seoul St. Mary Hospital, College of Medicine, The Catholic University of Korea, Seoul, Republic of Korea; ²Emergency Medicine, Eunpyeong St. Mary Hospital, College of Medicine, The Catholic University of Korea, Seoul, Republic of Korea; ³Emergency Medicine, Yeouido St. Mary Hospital, College of Medicine, The Catholic University of Korea, Seoul, Republic of Korea

Correspondence: J.S. Lee

Intensive Care Medicine Experimental 2023, **11(Suppl 1)**:000239

Introduction. Prediction of good neurological outcome after cardiac arrest is tantamount to the prediction of a patient's quality of life upon return of spontaneous circulation (ROSC), yet research on time and cost-efficient neuroprognostication tests is insufficient.

Objectives. The aim of the study was to evaluate the utility of clinical examinations performed after ROSC in predicting good neurological

outcomes in out-of-hospital cardiac arrest (OHCA) patients treated with targeted temperature management (TTM).

Methods. This retrospective study included OHCA patients treated with TTM from 2009 to 2021. Initial clinical examination findings related to the Glasgow Coma Scale (GCS) motor score, pupillary light reflex (PLR), corneal reflex (CR) and breathing above the set ventilator rate were assessed immediately after ROSC and before the initiation of TTM. The primary outcome was good neurologic outcome at 6 months after cardiac arrest.

Results. Of 350 patients included in the analysis, 119 (34%) experienced a good neurologic outcome at 6 months after cardiac arrest. Among the parameters of the initial clinical examinations, specificity was the highest for the GCS motor score, and sensitivity was the highest for breathing above the set ventilator rate. A GCS motor score of > 2 had a sensitivity of 42.0% (95% CI 33.0–51.4) and a specificity of 96.5% (95% CI 93.3–98.5). Breathing above the set ventilator rate had a sensitivity of 84.0% (95% CI 76.2–90.1) and a specificity of 69.7% (95% CI 63.3–75.6). As the number of positive responses increased, the proportion of patients with good outcomes increased. Consequently, 87.0% of patients for whom all four examinations were positive experienced good outcomes.

Conclusions. The initial clinical examinations predicted good neurological outcomes with a sensitivity of 42.0–84.0% and a specificity of 69.7–96.5%. When more examinations with positive results are achieved, a good neurologic outcome can be expected.

Table 1 (abstract 000239) Demographic characteristics of subjects according to neurologic outcome

	Good n=119	Poor n=231	p-value
Age, median (IQR)	50 (39–61)	59 (46–72)	< 0.001
Male, n (%)	91 (76.5)	162 (70.1)	0.257
Comorbidities			
HTN, n (%)	30 (25.2)	88 (38.1)	0.017
DM, n (%)	12 (10.1)	69 (29.9)	< 0.001
Witnessed arrest, n (%)	95 (79.8)	139 (60.4)	< 0.001
Bystander CPR, n (%)	80 (67.2)	128 (55.7)	0.039
Shockable rhythm, n (%)	90 (75.6)	41 (17.7)	< 0.001
Cardiac cause of arrest, n (%)	107 (89.9)	101 (43.7)	< 0.001
Time from collapse to ROSC, median (IQR)	17.0 (10.0–28.5)	36.0 (26.0–46.5)	< 0.001
Initial lactate, mmol/L	9.6 (6.4–13.3)	13.1 (10.2–17.0)	< 0.001
Initial glucose, mg/dl	252.0 (197.5–288.8)	288.0 (229.5–363.5)	0.001
GCS motor score > 1, n (%)	60 (50.4)	15 (6.5)	< 0.001
GCS motor score > 2, n (%)	50 (42.0)	8 (3.5)	< 0.001
Reactive pupillary light reflex, n (%)	86 (72.3)	38 (16.5)	< 0.001
Reactive corneal reflex, n (%)	66 (55.5)	15 (6.5)	< 0.001
Reactive in both PLR and CR, n (%)	100 (84.0)	70 (30.3)	< 0.001
Reactive PLR or CR, n (%)	66 (55.5)	15 (6.5)	< 0.001
Breathing above set ventilator rate, n (%)	86 (72.3)	38 (16.5)	< 0.001

Data presented as n (%) for categorical variables and as means ± standard deviations for continuous variables.

Abbreviations: HTN, hypertension; DM, diabetes mellitus; CPR, cardiopulmonary resuscitation; ROSC, return of spontaneous circulation; GCS, Glasgow coma scale; PLR, pupillary light reflex; CR, corneal reflex

Table 2 (abstract 239) Prognostic performance of single prognostic methods for predicting good neurologic outcomes

	AUC (95% CI)	Sensitivity % (95% CI)	Specificity % (95% CI)	TP	TN	FP	FN
GCS motor score > 1	0.720 (0.658–0.781)	50.4 (41.1–59.7)	93.5 (89.5–96.3)	60	216	15	59
GCS motor score > 2	0.693 (0.629–0.756)	42 (33.0–51.4)	96.5 (93.3–98.5)	50	223	8	69
Reactive pupillary light reflex	0.779 (0.725–0.834)	72.3 (63.3–80.1)	83.6 (78.1–88.1)	86	193	38	33
Reactive corneal reflex	0.745 (0.685–0.805)	55.5 (46.1–64.6)	93.5 (89.5–96.3)	66	216	15	33
Reactive in both PLR and CR	0.745 (0.685–0.805)	55.5 (46.1–64.6)	93.5 (89.5–96.3)	66	216	15	53
Reactive PLR or CR	0.779 (0.725–0.834)	72.3 (63.3–80.1)	83.6 (78.1–88.1)	86	193	38	33
Breathing above set ventilator rate	0.769 (0.717–0.821)	84.0 (76.2–90.1)	69.7 (63.3–75.6)	100	161	70	19

Data presented as n for TP, TN, FP and FN.

Abbreviations: AUC, area under the curve; CI, confidence interval; TP, true positive; TN, true negative; FP, false positive; FN, false negative; GCS, Glasgow coma scale; PLR, pupillary light reflex; CR, corneal reflex

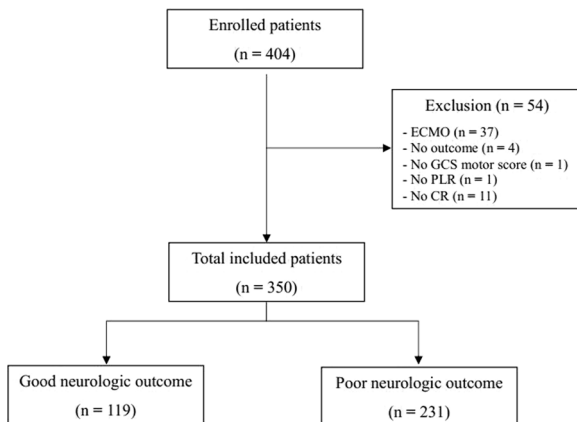

Figure 1 (abstract 000239) Flowchart for study inclusion

Abbreviations: ECMO, extracorporeal membrane oxygenation; GCS, Glasgow coma scale; PLR, pupillary light reflex; CR, corneal reflex

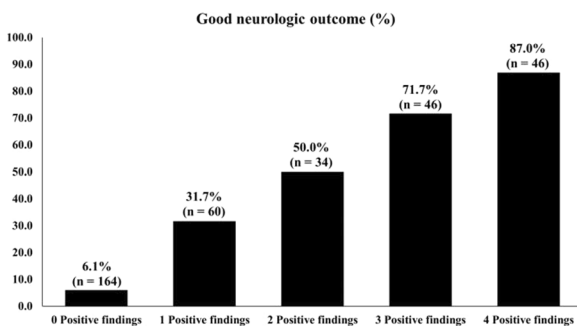

Figure 2 (abstract 000239) Association between clinical examinations and neurological outcomes at 6 months after cardiac arrest

Positive findings mean GCS motor score > 1, reactive pupillary light reflex, reactive corneal reflex and breathing above set ventilator rate.

Topic: Cardiac arrest.

000240

Changes in myocardial operational stiffness in mechanically ventilated sheep can be detected by measuring natural shear wave propagation speed

B. Jacobs¹, A. Caenen¹, S. Bézy¹, L. Wouters¹, P. Claus¹, B. Meyns¹, L. Langouche², J. D'hooge¹

¹Department of Cardiovascular Sciences, Katholieke Universiteit Leuven, Leuven, Belgium; ²Department of cellular and molecular medicine, laboratory of intensive care medicine, Katholieke Universiteit Leuven, Leuven, Belgium

Correspondence: B. Jacobs

Intensive Care Medicine Experimental 2023, 11(Suppl 1):000240

Introduction. Shear wave elastography (SWE) has the potential to non-invasively measure intrinsic myocardial stiffness, based on the propagation speed of shear waves traveling through the myocardium after valve closure. However, recent work has shown that shear wave propagation speed (SWS) is related to the myocardial operational stiffness, which is defined by the slope of the end-diastolic stress-strain relationship (EDSSR) at the operating volume/pressure. Therefore, operational stiffness can be altered by both changes in intrinsic myocardial stiffness and myocardial loading conditions.

Objectives. We aimed to investigate whether SWE can detect differences in operational stiffness induced by alterations in myocardial loading during mechanical ventilation, and whether this technique could also detect changes in intrinsic stiffness in ischemic cardiomyopathy (ICM).

Methods. We assessed SWS in 8 sedated and mechanically ventilated sheep: 5 healthy controls and 3 sheep with ICM after at least 16 weeks following left coronary artery ligation. Left ventricular parasternal long-axis views were acquired with a state-of-the-art ultrasound scanner with high frame rate technology (> 1100 Hz). SWS after mitral valve closure was measured in the basal septum during an inspiratory hold at 30 cmH2O and 15 cmH2O and expiratory hold at 0 cmH2O (atmospheric pressure) to change myocardial loading conditions in a non-invasive manner. We used linear regression to assess the trend of the SWS during ventilation manoeuvres per animal and repeated measures ANOVA and Student's T-test to assess differences between groups.

Results. In all sheep, SWS declined with higher inspiratory pressures (p=0.0025, Fig. 1), consistent with a reduction in left ventricular preload resulting in a shift towards a flatter part on the EDSSR. SWS during expiratory hold at atmospheric pressure was significantly lower in the control group vs. the ICM group (mean ± SE 5.3 ± 0.6 vs. 8.6 ± 1.1 m/s; p=0.03). Furthermore, the change in SWS with higher inspiratory pressures was larger in the ICM group vs. the control group (slope of the regression line -0.18 vs. -0.07 m/s/cmH2O; p=0.03). These observations suggest loading changes on a steeper part of the EDSSR in the ICM group.

Conclusions. In conclusion, our results suggest that SWE is able to detect differences in operational stiffness due to altered myocardial loading conditions induced by mechanical ventilation. Secondly, SWE appears to differentiate healthy controls from sheep with ICM based on the magnitude of the SWS during expiratory hold at atmospheric pressure, but also on the magnitude of the SWS change during loading alterations with higher inspiratory pressures. Further work should assess whether SWE combined with respiratory hold manoeuvres could contribute to differentiate intrinsic stiffening from altered loading conditions, and to exploit its full potential as a non-invasive bedside method for the assessment of operational stiffness in the mechanically ventilated critical care patient.

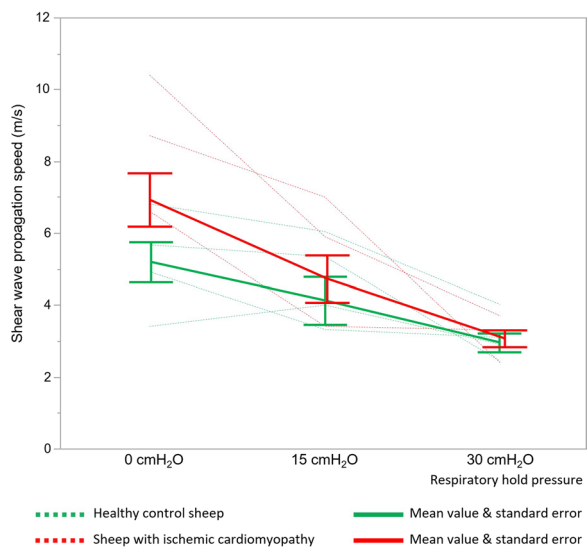

Figure 1 (abstract 000240) Shear wave propagation speed at different respiratory hold pressures for all sheep

Topic: Cardiovascular issues in ICU.

000241

Fugitive medical and patient derived aerosol particle distribution following heparin nebulization via high flow nasal oxygen, non-invasive ventilation and invasive mechanical ventilation for patients with COVID-19 acute hypoxemic respiratory failure

B. A. McNicholas¹, R. Macloughlin², M. Mac Giolla Eain³, C. Masterson¹, D. Cosgrave³, D. O’toole¹, J. Laffey¹

¹Anaesthesia and Intensive Care Medicine, School of Medicine, University of Galway, Galway, Ireland; ²R&D, Science and Emerging Technologies, Aerogen, Galway, Ireland; ³Department of Anesthesia and Intensive Care Medicine, University Hospital Galway, Galway, Ireland

Correspondence: B.A. McNicholas

Intensive Care Medicine Experimental 2023, **11(Suppl 1)**:000241

Introduction. Drug delivery directly into the lung via nebulisation has the potential to reduce systemic side effects, and to focus the therapeutic effect within the lung. With this, the environmental contamination associated with aerosolisation (drug and infectious agents) needs to be determined, particularly whether this is influenced by oxygen delivery devices. Experimental and laboratory-based studies have provided information on the distribution of fugitive and exhaled aerosols in controlled settings. However, real world data on fugitive medical and patient derived aerosol particle distribution is sparse.

Objectives. In this study, we examined the aerosol particle distribution of fugitive medical and patient derived aerosols in the bed spaces of patients undergoing the management of COVID-19 pneumonia. These patients were participating in a randomised inhaled heparin study.

Methods. Patients randomised in the ‘Can Nebulised HepArin Reduce acuTE lung injury in Patients with SARSCoV-2 Requiring Mechanical Ventilation in Ireland’ (CHARTER) Trial, a randomised controlled study on the effect of nebulised unfractionated heparin in ICU patients with SARS- CoV-2 requiring advanced respiratory support, were enrolled in

this study. An optical particle sizer (OPS 3300, TSI, Inc., USA) was placed on a metal tray and an inflow hose was attached from the sampling port to the nurses station at the patients bed space. Measurements were taken at one-minute intervals for a period of 24 h. Data on particle mass concentration (µg/m³) was analysed using GraphPad Prism (USA).

Results. A total of 20 separate periods of air sampling collection was recorded on 12 patients, of which n=14 were randomised to the heparin treatment and n=6 to standard respiratory care. All patients underwent advanced respiratory support with n=10 managed with high flow nasal cannula oxygen (HFNO), n=7 managed with non-invasive ventilation (NIV) and n=3 managed with invasive mechanical ventilation (IMV).

Peak particle mass concentration during nebulisation with heparin was significantly higher for patients managed with HFNO than patients undergoing NIV or IMV (34.4 ± 5.0 vs. 6.9 ± 14.0 vs. 1.6 ± 1.4 µg/m³, p=0.01, Fig. 1). Average peak particle mass concentration for 24h period was higher for patient undergoing HFNO compared to NIV and IMV. (31.4 ± 24.3 vs. 6.2 ± 10.8 vs. 4.0 ± 2.9 µg/m³, p=0.02). There was no difference in average peak particle concentration over a 24h period in those receiving aerosolized heparin vs no heparin (39.9 ± 34.7 vs 14.8 ± 10.7 µg/m³, p=0.1) or during period of heparin nebulisation compared to non-heparin nebulisation (34.3 ± 44.8 vs 20.7 ± 7.7 µg/m³, p=0.7).

Conclusions. Patients who received HFNO generated larger quantities of fugitive medical and patient derived bio-aerosols than patients who received IMV and NIV. However, there was no statistically significant difference in the mass concentration levels between patients who did and didn’t receive heparin.

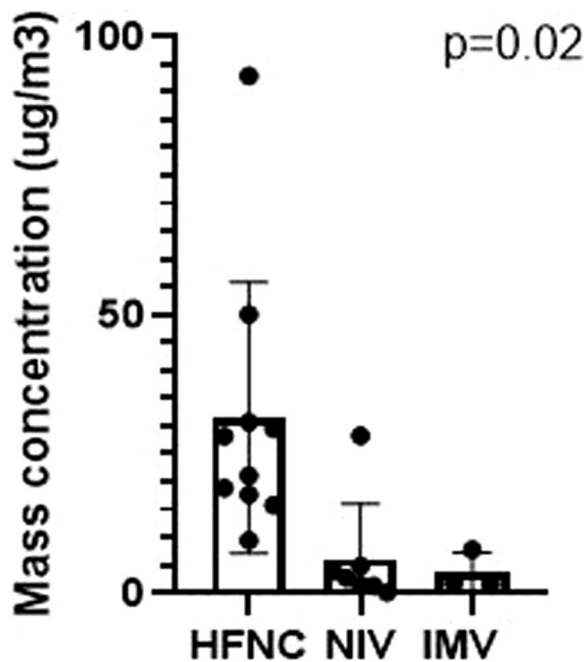

Figure 1 (abstract 000241) Peak mass concentration detected during heparin nebulisation for patients undergoing heparin nebulisation with high flow nasal oxygen (HFNO), non-invasive ventilation (NIV) and invasive mechanical ventilation (IMV)

References

- Academic jointly funded research programme by CURAM/SFI and Aero-gen Inc (Galway, Ireland)

Topic: Acute respiratory failure and mechanical ventilation.

000242

Serum myoglobin is a better parameter for diagnosing post-operative rhabdomyolysis in patients with type A aortic dissection

M. H. Luo¹, J. C. Luo¹, C. Chen², Y. J. Zhang¹, Y. Su¹, C. S. Wang³, H. Lai³, Y. X. Sun³, J. Li³, G. W. Tu¹, Z. Luo¹

¹Cardiac Intensive Care Center, Zhongshan Hospital, Fudan University, Shanghai, China; ²Department of Critical Care Medicine, Zhongshan Hospital Xiamen, Xia Men Shi, China; ³Department of Cardiac Surgery, Zhongshan Hospital, Fudan University, Shanghai, China

Correspondence: M.H. Luo

Intensive Care Medicine Experimental 2023, **11(Suppl 1)**:000242

Introduction. Rhabdomyolysis (RM) is a common postoperative complication of type A aortic dissection (TAAD) and is primarily diagnosed by creatine kinase (CK) levels. However, controversy remains regarding which biomarker may be more appropriate to diagnose RM and reflects clinical outcomes. Compared with CK, serum myoglobin has a shorter half-life, making it an early marker of RM [1]. Previously, in traumatic RM, serum myoglobin was a more sensitive and specific test than serum CK, for predicting acute kidney injury (AKI) [2]. The clinical value of serum myoglobin in assessing patients with TAAD developing RM after surgery is unclear.

Objectives. This study aimed at assessing whether myoglobin would be superior in the diagnosis of postoperative RM in patients with TAAD.

Methods. For TAAD patients undergoing surgical repair, CK, muscle-type CK (CKMM), and myoglobin were recorded for the first three days postoperatively. Renal function parameters were followed up until death or discharge. The primary endpoint was a composite outcome comprising of death and persistent AKI (meeting AKI criteria but not completely resolved by discharge). The relationship among RM parameters were assessed using linear regression. The impact of different diagnostic thresholds on risk stratification and clinical decision making was investigated using receiver operator characteristic (ROC) and decision curve analysis (DCA).

Results. Of the 373 patients in the study cohort, 40 died and 104 met the composite outcome. CKMM ($R^2=1.00$) was much more closely correlated with CK than with myoglobin ($R^2=0.29$) (Fig. 1). The density distribution of myoglobin varied more markedly in patients with different outcomes (Fig. 2). Myoglobin (AUROC: 0.755 and 0.841), but not CKMM (AUROC: 0.652 and 0.0746), was more accurate than CK (AUROC: 0.653 and 0.751) in predicting the composite outcome and death (Fig. 3). A threshold of 1500 ng/ml for myoglobin (approximately equals to 2000 IU/L of CK) had a sensitivity of 65(54–75) and specificity of 77(70–83) for the composite outcome, and a sensitivity of 85(69–95) and specificity of 71(65–77) for death. In addition, DCA showed that higher clinical net benefits can be achieved with myoglobin-based interventions.

Conclusions. The use of myoglobin as a diagnostic parameter for post-operative RM in patients with TAAD could better reflect the severity of the patient and provide greater clinical net benefit.

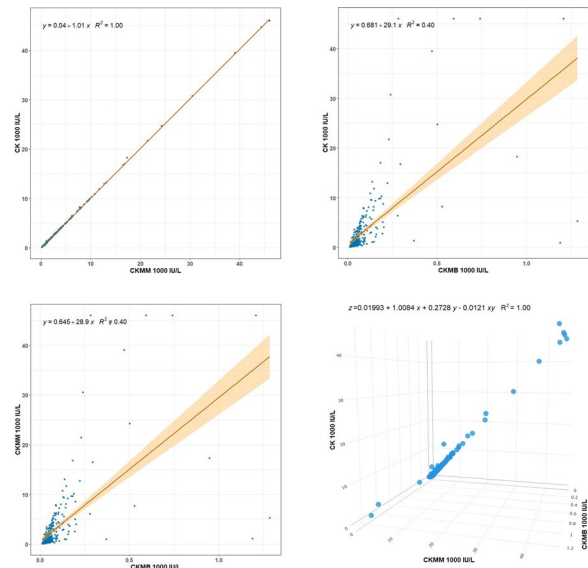

Figure 1 (abstract 000242) Correlation between different biomarker indicating rhabdomyolysis

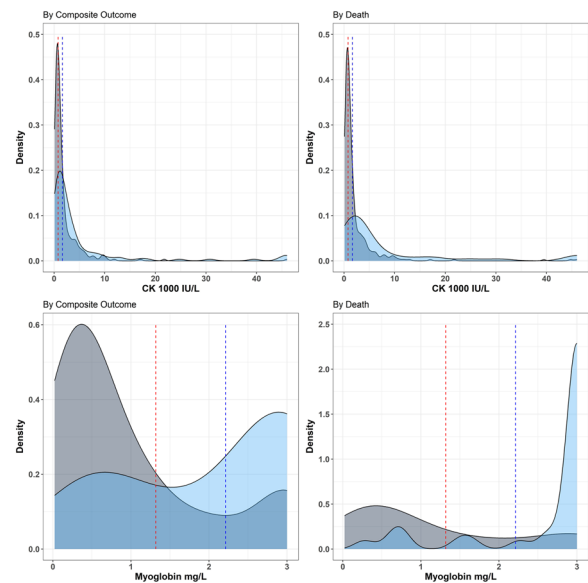

Figure 2 (abstract 000242) Density plots of biomarkers reflecting rhabdomyolysis

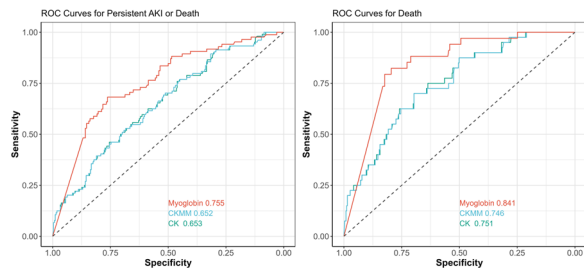

Figure 3 (abstract 000242) Receiver operating characteristic curves of CK, CKMM and myoglobin for the primary outcome and in-hospital mortality

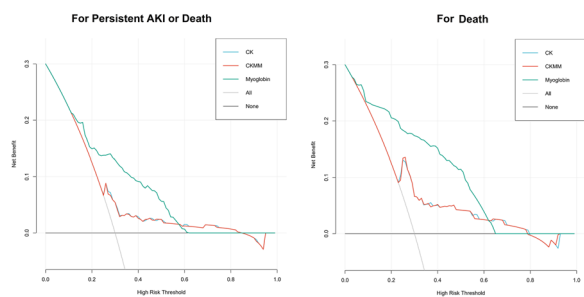

Figure 2 (abstract 000242) Decision Curve Analysis of CK, CKMM and myoglobin for the primary outcome and in-hospital mortality

References

- [1] Petejova N, Martinek A. Acute kidney injury due to rhabdomyolysis and renal replacement therapy: a critical review. Crit Care. 2014;18(3):224. Published 2014 May 28. <https://doi.org/10.1186/cc13897>
- [2] Raju NA, Rao SV, Joel JC, et al. Predictive Value of Serum Myoglobin and Creatine Phosphokinase for Development of Acute Kidney Injury in Traumatic Rhabdomyolysis. Indian J Crit Care Med. 2017;21(12):852–856. https://doi.org/10.4103/ijccm.IJCCM_186_17
- This research was funded by the the National Natural Science Foundation of China (82070085), the Research Project of Shanghai Municipal Health Commission (20214Y0136) and the Clinical Research Project of Zhongshan Hospital (2020ZSLC38 and 2020ZSLC27).

Topic: Perioperative care.

000245

D-dimer levels at the time of admission as a predictor of outcome in trauma patients? A prospective observational study

A. Hazarika¹, D. Kant¹, N. Bhatia¹, N. Naik², M. Tundak², J. Ahluwalia³, D. Negi⁴

¹Anaesthesia and intensive care, Post Graduate Institute of Medical Education & Research, Chandigarh, Chandigarh, India; ²Anaesthesia & intensive care, Post Graduate Institute of Medical Education & Research, Chandigarh, Chandigarh, India; ³Hematology, Post Graduate Institute of Medical Education & Research, Chandigarh, Chandigarh, India; ⁴Orthopaedic, Post Graduate Institute of Medical Education & Research, Chandigarh, Chandigarh, India

Correspondence: A. Hazarika

Intensive Care Medicine Experimental 2023, 11(Suppl 1):000245

Introduction. Trauma causes a state of hypercoagulability, and its presence is common early in the injury course. D-dimer (DD) easily

measured and considered a good screening tool of coagulation activation. Its increase amount in plasma is a reflection of the extent of coagulation and fibrinolysis activation and hence are elevated in hypercoagulable states. Hence, in trauma, measuring DD levels may be helpful in providing useful prognostic information in absence of overt haemorrhagic manifestations. So, our study will try to find prospectively whether D-dimer levels at the point of admission can be a predictor to the outcome of patients with trauma.

Methods. This prospective observational study involved 105 adult patients of age group 18-60yrs coming to trauma emergency within 24 h of injury and blood samples collected within this period. The primary outcome was to assess whether D-dimer levels at the time of admission in hospital predicts outcome in these patients. Association of D-dimer levels with injury severity score (ISS), with blunt or penetrating trauma, time duration from injury to admission, and its contribution to hospital stay were secondary outcomes. Value of D Dimer above 250 ng/ml were considered elevated. For ease of statistical analysis, patients were be divided into two groups—ISS score less then 16 and ISS score more or equal to 16. Patients demographic variables were noted. We also recorded the time from injury to time of admission and divided the patients into two groups-patient reaching emergency within 6 h of injury and those reaching emergency more than 6 h but less then 24 h of injury.

Results. The D-dimer level at admission was significantly high in patient who died then those who were discharged [1316.28 (384.5,3331.18) vs 498.03 (140,693) , p=0.041]. There was a significant difference in d-dimer levels between blunt and penetrating trauma [1280 (565,3377) vs 162(82,526), p=0.001] (Fig. 1). 5 patients with ISS < 16 and 6 patients with ISS > 16 died in the study period. Plotting a ROC of D-dimer values, a cut-off value of 1793.35 was calculated (sensitivity-0.72; specificity-0.4) and on its basis hospital stay was compared. There was no statistically significant difference [8 (4,17) vs 10 (5,19); p=0.396].

Conclusions. In our study, we found that admission levels of d-dimer was significantly more in patient who died then who were discharged from the hospital. Patient with blunt trauma had significantly higher d-dimer values then penetrating trauma victims. Injury severity score, time from injury, and hospital stay had no significant relation with d-dimer values. D-dimer values at admission can be a useful screening tool in trauma patients to predict outcome.

Table1: Shows D-dimer levels among death and discharge patients, in relations to ISS, type of injury, time to injury and hospital stay.		
D-dimer levels	Median (Q ₁ , Q ₃)	p-value
Outcome		
Death (n-11)	1316.28 (384.5,3331.18)	0.041
Discharge (n-94)	498.03 (140,693)	
Injury severity score (ISS)		
<16 (n-71)	1001 (304,2337)	0.105
>16 (n-34)	1438 (458,10936)	
Type of Injury		
Blunt(n-94)	1280 (565,3377)	0.001
Penetrating(n-11)	162 (82,526)	
Time to injury		
< 6hours(n-55)	900 (209,4963)	0.561
>= 6 hours(n-50)	1353 (571,3010)	
Hospital stay		
< 1793.35 (n-)	8 (4,17)	0.396
>= 1793.35(n-)	10 (5,19)	

Shows D-dimer levels among death and discharge patients, in relations to ISS, type of injury, time to injury and hospital stay.

Topic: Trauma.

000246

Assessment of post-COVID-19 muscular strength and respiratory function

S. Koukias¹, G. Briassoulis¹, E. Bachlitzanaki¹, M. Detoraki¹, E. Kondyli², N. Papanikolaou³, S. Ili¹

¹Postgraduate Program "Emergency and Intensive care in children, adolescents, and young adults", School of Medicine, University of Crete, Heraklion, Greece; ²ICU, University Hospital, School of Medicine, University of Crete, Heraklion, Greece; ³First Department of Internal Medicine, Venizeleio-Pananeio General Hospital, Heraklion, Greece

Correspondence: S. Koukias

Intensive Care Medicine Experimental 2023, 11(Suppl 1):000246

Introduction. A large proportion of patients infected with SARS-CoV-2 virus, complaint of symptoms even 12 weeks after the acute phase of the infection. Shortness of breath and weakness are reported to be the most common. Risk factors and the pathogenic mechanism and are not well understood. Follow-up and management of post-COVID-19 patients requires a multidisciplinary approach. Their assessment and monitoring is of vital importance for recognizing and addressing symptoms and improving the patients' quality of life.

Objectives. The purpose of this study is to assess muscular strength and respiratory function 1 to 6 months after COVID-19 infection in patients with mild, moderate, severe, or critical illness.

Methods. In this prospective cohort study, patients with laboratory-confirmed COVID-19 were enrolled and evaluated 1 to 6 months after the disease during the period June 2022 to December 2022. Demographic data, past medical history, vaccination status, duration of illness, chest imaging and post-COVID-19 symptoms were recorded. Respiratory function was evaluated using spirometry and muscular strength by using hand dynamometer.

Results. A total of 250 patients, who recovered from COVID-19, were included. The patients had a mean \pm SD age of 50.4 ± 16.3 years and 137 (54.8%) were women. In the first month of the evaluation, most patients (84.4%) reported post-COVID-19 symptoms. More critically ill patients reported dyspnea (3rd month 100 vs. 48% vs, $p=0.037$) and fatigue (6th month 100 vs. 70%, $p=0.04$) compared to patients with severe disease. The observed/predicted ratios of FEV1 ($p=0.006$), FVC ($p=0.001$) and MMEF25-75% ($p=0.05$), were significantly lower the 1st month in patients with critical illness (Fig. 1A). Patients with moderate to critical disease severity ($p=0.014$), as well as patients who needed to be hospitalized in a COVID-19 medical ward or Intensive care unit ($p<0.001$), had significantly higher risk rates of obstructive or restrictive lung disease. Hand grip strength was found significantly reduced in patients with comorbidities ($p=0.001$) and in patients reporting post-COVID symptoms at 6 months after illness ($p=0.047$) (Fig. 1B).

Conclusions. Impairment in respiratory function and muscular weakness are frequently found in patients infected with the SARS-CoV-2 virus, related to the severity of illness and the presence of comorbidities. Further research is needed on the long-term consequences of post-COVID-19 syndrome, as well as on the management of these patients, with the aim of improving their quality of life.

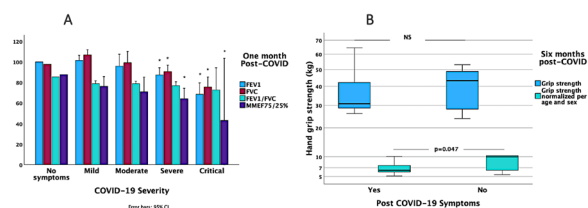

Figure 1 (abstract 000246) A. Lower FEV1, FVC, and MMEF25-75% the 1st post-COVID month in patients with critical illness; B. Decreased

hand-grip strength 6 months after COVID-19 disease in patients reporting post-COVID symptoms

References

- Shah W, Hillman T, Playford ED, Hishmeh L. Managing the long term effects of covid-19: summary of NICE, SIGN, and RCGP rapid guideline. *BMJ*. 2021 Jan 22;372:n136
- Soriano JB, Murthy S, Marshall JC, Relan P, Diaz JV. A clinical case definition of post-COVID-19 condition by a Delphi consensus. *Lancet Infect Dis*. 2022 Apr 1;22(4):e102-7

Topic: Sepsis.

000250

Sepsis bundle compliance and mortality according to body temperature of sepsis patients in general wards identified through the rapid response system

J. W. Kang¹, S. H. Choi¹, J. S. Son¹, S. H. Lee¹, J. H. Ahn², H. R. Choi³

¹Medical Emergency Team, Asan medical center, Seoul, Republic of Korea;

²Department of Pulmonary and Critical Care Medicine, ASAN Medical Center, Seoul, Republic of Korea;

³University of Ulsan College of Medicine, Asan medical center, Seoul, Republic of Korea

Correspondence: J. Kang

Intensive Care Medicine Experimental 2023, 11(Suppl 1):000250

Introduction. Body temperature is a vital sign that is routinely measured, and fever is used as a means to evaluate infection. Therefore, patients with high fever sepsis are recognized and treated promptly, but sepsis patients with low body temperature or normal body temperature experience delayed recognition and treatment of sepsis. The early treatment of sepsis patients is associated with improved outcomes, and Rapid Response System(RRS) can provide optimal treatment for sepsis in general ward. Although studies on sepsis bundle compliance and mortality according to body temperature are often performed in emergency departments, there is little published data on sepsis based on the temperature of patients in the general ward.

Objectives. To investigate the difference in sepsis bundle compliance and 28-day mortality rates according to body temperature of patients with sepsis in general wards identified through a rapid response system.

Methods. A retrospective observational study of 1083 patients with sepsis in general wards identified through the rapid response system from July 2018 to December 2022 performed at a tertiary care hospital in South Korea. The patients were divided into three groups based on their body temperature at the time of RRS activation(i.e., hypothermia [$< 36^{\circ}\text{C}$] vs normothermia [$36-38^{\circ}\text{C}$] vs hyperthermia [$> 38^{\circ}\text{C}$]).

Results. We analyzed 1,083 sepsis patients by dividing them into three groups based on their body temperature (17 cases of hypothermia, 624 cases of normothermia, and 442 cases of hyperthermia). The rate of total 1-h sepsis bundle compliance was significantly difference each temperature group (64.7% in hypothermia vs. 49.5% in normothermia vs. 60.4% in hyperthermia, $p=0.010$). Also the rate of compliance with overall sepsis bundle including lactate re-measurement was significantly difference each temperature group (64.7% vs. 49.5% vs. 60.4%, $p=0.001$), and blood culture rate was significantly difference each temperature group (94.1% vs. 85.9% vs. 92.8%, $p=0.002$). The 28-day mortality rates in the hypothermia, normothermia, and hyperthermia groups were 29.4%, 32.4%, and 16.5%, respectively ($p<0.001$).

Conclusions. Sepsis patient with normothermia in general wards identified through the rapid response system was significantly lower compliance with the sepsis bundle and higher 28-day mortality rates than other body temperature group.

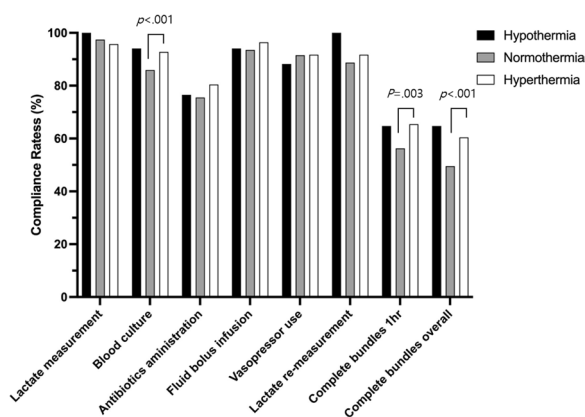

Figure 1 (abstract 000250) Comparison of the rates compliance with 1-hour bundle among the three body temperature groups

Table 1 (abstract 000250) Comparison of clinical outcome by body temperature groups

Variable	All (n=1083)	Hypothermia (n=17)	Normothermia (n=624)	Hyperthermia (n=442)	χ^2 (p)
ICU admission	496 (43.0)	6 (35.3)	267 (42.8)	193 (43.7)	0.503 (1.778)
28-day mortality	280 (25.9)	5 (29.4)	202 (32.4)	73 (16.5)	34.047 (<.001)
Hospital mortality	344 (31.8)	5 (29.4)	241 (38.6)	98 (22.2)	32.346 (<.001)

(N=1083)

References

- Choi, S. H., Son, J. S., Oh, D. K., Huh, J. W., Lim, C. M., & Hong, S. B. (2021). Rapid response system improves sepsis bundle compliances and survival in hospital wards for 10 Years. *Journal of Clinical Medicine*, 10(18), 4244.
- Park, S. H., Jeon, K. M., Oh, D. K., Choi, E. Y., Seong, G. M., Heo, J. W., et al., (2020). Normothermia in patients with sepsis who present to emergency departments is associated with low compliance with sepsis bundles and increased in-hospital mortality rate. *Critical Care Medicine*, 48(10), 1462–1470.

Topic: Sepsis.

000251

Toward general-purpose ICU predictive model: without task-specific feature selection and infinite observation windows

J. Kim¹, C. Sim², E. Choi¹, H. G. Jeong³

¹Kim Jaechul Graduate School of AI, Korea Advanced Institute of Science & Technology (KAIST), Seongnam-si, Republic of Korea; ²Division of Mechanical and Biomedical Engineering, Ewha Womans University, Seoul, Republic of Korea; ³Division of Neurocritical Care, Department of Neurosurgery and Neurology, Seoul National University Bundang Hospital, Seongnam-si, Republic of Korea

Correspondence: H.G. Jeong, E. Choi

Intensive Care Medicine Experimental 2023, **11(Suppl 1)**:000251

Introduction. To build predictive machine learning (ML) models using Electronic Healthcare Record (EHR) data from ICU, clinicians should choose relevant features and the observation window specifically for the target task. However, when building a general-purpose model, repeating this process for every task is hardly scalable. One potential solution is to put the entire events of a patient and let the model process them comprehensively. This solution, however, is infeasible with the current technology, because the modern machine learning algorithm (i.e. Transformer [1]) requires computations that increase quadratically by the number of input events.

Objectives. We propose a novel machine learning approach that can handle, theoretically, an infinite amount of events. This method has three key features: 1) it does not require task-specific feature selection, 2) it can handle an infinite observation window, and 3) it can make predictions for multiple tasks simultaneously.

Methods. Our key idea is to treat the EHR as free text [2] and automatically select task-related events (Fig. 1). We start by representing all EHR events as linearized text and individually encode them with a pre-trained neural text encoder. Then, the retriever module learns which events are important for each task and selects the top-k most significant events automatically. This eliminates the need for manual task-specific feature selection and determining the observation window. Finally, the aggregator module, built with Transformer layers, makes multi-task predictions.

Results. A total of 68,118 ICU stays of adult patients (n = 49,168) was collected from the MIMIC-IV dataset [3]. The performance was evaluated for nine clinical tasks related to administrative outputs and sepsis-related lab values. For all tasks, our method achieved an average AUROC of 0.91 (0.70–0.99 for each task), indicating that this successfully addressed all the tasks simultaneously. Notably, in the ongoing experiment on eICU database [4], our method could handle the longest case where a patient had 284,282 events without requiring feature selection or a fixed observation window. The fact that our model automatically selects important events means, conversely, that the selected events are crucial. For instance, our model frequently selected “Lactic Acid” and “Pulse Oxymetry Alarm” events, which indirectly demonstrates the model has learned clinical knowledge.

Conclusions. The general-purpose ICU prediction model must not rely on task-specific preprocessing or task-specific models, and we provide a practical solution to this challenge. However, the current evaluation of our model is limited to a small number of tasks, and some of these are of limited clinical importance. To increase the clinical impact of our system, we plan to expand to incorporate a vast array of clinical tasks, such as sepsis and AKI.

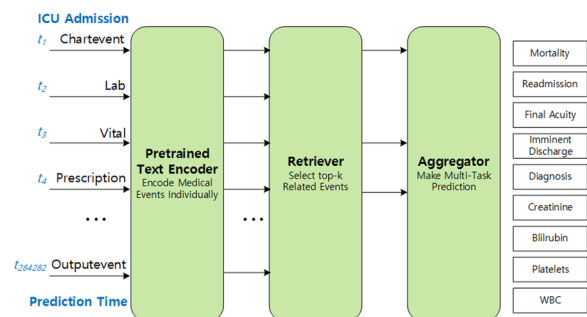

Figure 1 (abstract 000251) Visualization of Our Model Architecture

References

- Johnson, A., Bulgarelli, L., Pollard, T., Horng, S., Celi, L. A., & Mark, R. (2020). MIMIC-IV. *PhysioNet*. Available online at: <https://physionet.org/content/mimiciv/1.0/> (accessed August 23, 2021).
- Hur, K., Oh, J., Kim, J., Kim, J., Lee, M. J., Cho, E., ... & Choi, E. (2022). UniHPF: Universal Healthcare Predictive Framework with Zero Domain Knowledge. *arXiv preprint arXiv:2211.08082*.
- Vaswani, A., Shazeer, N., Parmar, N., Uszkoreit, J., Jones, L., Gomez, A. N., ... & Polosukhin, I. (2017). Attention is all you need. *Advances in neural information processing systems*, 30.
- Pollard, T. J., Johnson, A. E., Raffa, J. D., Celi, L. A., Mark, R. G., & Badawi, O. (2018). The eICU Collaborative Research Database, a freely available multi-center database for critical care research. *Scientific data*, 5(1), 1–13.
- This research was supported by the Institute of Information & Communications Technology Planning & Evaluation (IITP) grant (No.2019-0-00075) and Korea Medical Device Development Fund grant (Project Number: 1711138160, KMDF_PR_20200901_0097) funded by the Korea government (MSIT, MOTIE, MOHW, MFDS), and SNUBH-KAIST Joint

Graduate Research Project on AI and Cloud TPUs from Google's TPU Research Cloud (TRC).

Topic: Data Science.

000253

Comparison of the impact of three inspiratory muscle training programs on diaphragm strength and endurance in intubated and mechanically ventilated patients in difficult weaning: a multicentric controlled randomized parallel trial

T. Reginault¹, R. Martínez Alejos², B. Jean-François³, C. Roxane⁴, F. Eric⁴, V. Frédéric⁵

¹Réanimation Médicale, Chu Pellegrin, Bordeaux, France; ²Research methodology and respiratory physiotherapy, Training Institute Physiotherapy, Montpellier, France; ³Réanimation Médicale, Hôpital de la Croix-Rousse—HCL, Lyon, France; ⁴Methodologie en recherche clinique, Chu Pellegrin, Bordeaux, France; ⁵Réanimation Médicale, Hospital Center University De Bordeaux, Bordeaux, France

Correspondence: T. Reginault

Intensive Care Medicine Experimental 2023, **11(Suppl 1)**:000253

Introduction. Inspiratory muscle training (IMT) consists of a resistive inspiratory maneuver through a pressure device comprising a unidirectional valve that hinders inspiration. IMT was found to significantly increase inspiratory muscle strength in adults undergoing invasive Mechanical ventilation (MV). Despite, we observe an important heterogeneity of IMT protocols, and it is unclear if it reduces MV duration. Furthermore, inspiratory muscles endurance is scantily evaluated while the assessment of this function may be fundamental for a successful weaning. In this multicentric controlled randomized parallel trial, we compared the effects of three different IMT protocols (CADER, MARTIN, and EDRIC) on inspiratory muscle strength and endurance in difficult to wean patients in two intensive care units (ICU).

Methods. 92 subjects presenting difficult weaning (after first spontaneous breathing trial failure or extubation failure) were randomized in 3 groups to perform one of the three different IMT protocols twice daily. The primary outcome was the Maximal Inspiratory Pressure (MIP) increase in each group during weaning. Secondary outcomes were Pressure peak increase (Ppk), as endurance marker, weaning duration, and safety.

Results. During the weaning process, the observed increase of MIP was 12.2 ± 11.2 cmH₂O in EDRIC group, 5.3 ± 15.5 cmH₂O in CADER group, and 6.8 ± 15.1 cmH₂O in MARTIN group. There was a non-statistically significant difference between EDRIC group and CADER group (mean adjusted difference: -6.65 [-14.35 ; 1.04], $p=0.052$), neither between EDRIC group and MARTIN group (mean adjusted difference: -3.67 [-11.52 ; 4.18], $p=0.289$).

No significant difference in Ppk increase were observed between the three groups. Over 356 IMT sessions, only 3 serious adverse events were considered possibly related to the study. All events were spontaneously reversible bradycardia.

Conclusions. Independently of IMT protocol applied, MIP and Ppk seemed to improve in our cohort of difficult to wean patients. Ppk could be a helpful tool to assess diaphragm function exhaustively. EDRIC group showed a slightly higher efficacy.

Programs	MARTIN	CADER	EDRIC
Description	4 sets x 6 breaths against maximal load tolerated Twice daily, 7days/week	5' against a load of 30% initial MIP with an increment of 10%/day when the session is fully completed Twice daily, 7days/week	4 sets x 20 breaths against an increasing load at each set from 30% to 60% of daily's MIP Twice daily, 7days/week

Figure 2 (abstract 000253) Description of the 3 IMT programs

References

- Carlucci A, Ceriana P, Prinianakis G, Fanfulla F, Colombo R, Nava S.- Determinants of weaning success in patients with prolonged mechanical ventilation.- Crit Care 2009;13(3):R97
- Powers SK, Kavazis AN, Levine S—Prolonged mechanical ventilation alters diaphragmatic structure and function—Crit Care Med 2009 Oct;37(10 Suppl):S347-53
- Epstein SK, Ciubotaru RL. Independent effects of etiology of failure and time to reintubation on outcome for patients failing extubation. Am J Respir Crit Care Med 1998;158:489–493
- Gosselink R, Bott J, Johnson M, Dean E, Nava S, Norrenberg M et al. () Physiotherapy for adult patients with critical illness: recommendations of the European Respiratory Society and European Society of Intensive Care Medicine Task Force on Physiotherapy for Critically Ill Patients. Intensive Care Medicine 2008; 34: 1188–1199
- Choi J, Tasota FJ, Hoffman LA- Mobility interventions to improve outcomes in patients undergoing prolonged mechanical ventilation: a review of the literature. Biological Research for Nursing 2008; 10: 21–33
- Boles J.M., Bion J., Connors A., Herridge M., Marsh B., Melot C., et al. Weaning from mechanical ventilation. Eur Respir J. 2007;29:1033–1056
- Esteban A, Anzueto A, Frutos F, Alia I, Brochard L, Stewart TE, Benito S, Epstein SK, Apezteguia C, Nightingale P, et al. Characteristics and outcomes in adult patients receiving mechanical ventilation: a 28-day international study. JAMA 2002;287:345R355
- Lefrant JY, Guarrigues B, Pribil C, Bardoulat I, Courtial F, Maurel F, Bazin JE, CRREA study group, AzuRea group. The daily cost of ICU patients: A micro-costing study in 23 French Intensive Care Units. Anaesth Crit Care Pain Med 2015 Jun;34(3):151–7
- Tobin MJ. Mechanical Ventilation. New Engl J Med 1994 Apr 14;330(15):1056–61
- Tonnellier A, Tonnellier JM, Nowak E, Gut-Gobert C, Prat G, Renault A, Boles JM, L'Her E. Clinical Relevance of Classification According to Weaning Difficulty. Respir Care May 2011, 56 (5) 583–590
- We want to espially thank the physiotherpists Philippe Wibart, Margarita Garcia Fontan, Berangere Barbrel, Gonzalo Garcia de Carellan and Thomas Gallice for their implication practicasing IMT sessions, the all medical team and the clinical research associate, Nicolas Bourgoin, for his precious help all over the study.

Topic: Nursing care and physiotherapy.

000255

The utility of electrical impedance tomography (EIT)-guided positive end-expiratory pressure (PEEP) titration in acute respiratory distress syndrome (ARDS): a systematic review and meta-analysis of randomized control trials

P. Khanna¹, S. Sarkar², Y. Bharat¹

¹Anaesthesia,Pain Medicine & Critical Care, All India Institute Of Medical Sciences, New Delhi, New Delhi, India; ²Anaesthesia,Pain Medicine & Critical Care, All India Institute of Medical Sciences, Kalyani, Kalyani, India

Correspondence: P. Khanna

Intensive Care Medicine Experimental 2023, **11(Suppl 1)**:000255

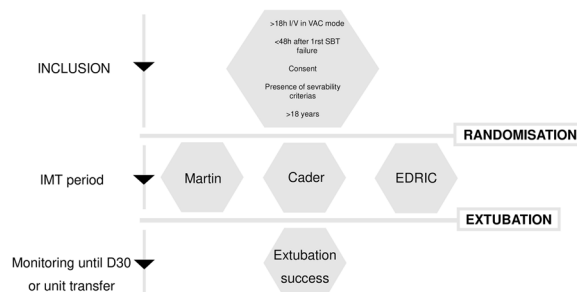

Figure 1 (abstract 000253) Study design

Introduction. Electrical Impedance Tomography (EIT) is a non-invasive imaging technique that uses changes in electrical conductivity to create images of the lungs. The utility of Electrical Impedance Tomography (EIT)-guided Positive End-Expiratory Pressure (PEEP) titration in improving outcomes in with Acute Respiratory Distress Syndrome (ARDS) patients in comparison to traditional PEEP titration methods.

Methods. Extensive electronic database screening was done until 1st April 2023. Randomized Controlled Trials (RCT) evaluating the impact of the EIT-guided PEEP titration were included in this meta-analysis.

Results. Our search retrieved six RCTs with a total of 475 patients. No significant difference in P/F ratio [MD = -6.35; 95% CI -19.32 to -6.6; I² = 0%], driving pressure requirement [MD = -0.29; 95% CI -0.84 to 0.25; I² = 0%], PEEP optimization [MD = 0.05; 95% CI -0.46 to 0.56; I² = 87%], and successful weaning [OR = 1.35; 95% CI 0.8–2.2, I² = 51%] with the application of EIT-guided PEEP titration.

Conclusions. EIT-guided PEEP titration is a novel alternative, further well designed studies are needed for substantiating its utility.

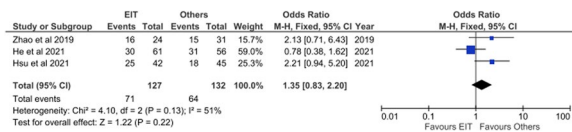

Weaning.

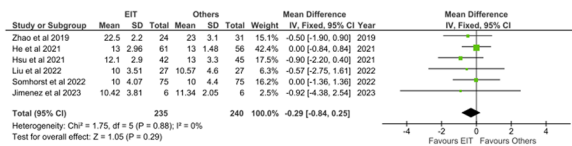

Driving pressure.

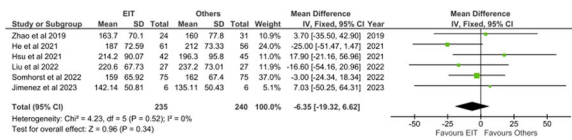

P/F ratio.

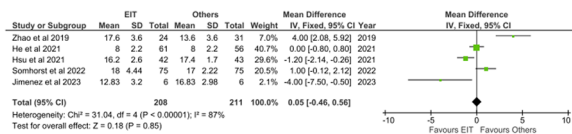

PEEP

References

- Electrical Impedance Tomography in Mechanically Ventilated Children: Will It Impact Clinical Care? *Respiratory Care* April 2022, 67 (4) 494–495; <https://doi.org/10.4187/respcare.10077>
- None

Topic: Acute respiratory failure and mechanical ventilation.

000257

The effect of epinephrine on augmentation of blood pressures during advanced life support

K. C. Cha¹, Y. I. Roh¹, S. O. Hwang¹

¹Department of Emergency Medicine, Yonsei University Wonju College of Medicine, Wonju-si, Republic of Korea

Correspondence: K.C. Cha

Intensive Care Medicine Experimental 2023, **11(Suppl 1)**:000257

Introduction. Epinephrine has been used for increasing coronary perfusion pressure during advanced life support (ALS) and promoting short-term survival (1, 2). A 3–5 min dosing interval of epinephrine during resuscitation is recommended in recent cardiopulmonary resuscitation (CPR) guidelines, but the recommendations lack scientific evidence. This study was aimed to verify the effect of epinephrine on augmenting blood pressures and effect duration of epinephrine during ALS.

Methods. This is a secondary analysis study using data from a previously published study with swine cardiac arrest model (3). In the study, the epinephrine dose was fixed as 1 mg and the first dose of epinephrine was administered after no flow time of 2 min and low flow time of 8 min and then administered every 4 min. We defined 4 cycles of the dosing interval because a previous study was terminated at 26 min after induction of ventricular fibrillation. Augmented blood pressures and corresponding timeline were derived. Trend of augmented blood pressures following cycles and effect duration of epinephrine were also collected.

Results. Total 180 cycles were analyzed. The augmented blood pressures were the highest in the 1st cycle and gradually decreased as the cycles repeated. However, the effect duration of epinephrine was not different as the cycles repeated. Time achieving maximum blood pressures was about 90 s after epinephrine administration and it was not accordant with timing of defibrillation.

Conclusions. Augmented blood pressures after epinephrine administration during ALS was gradually decreased as the CPR cycles repeated. However, the effect duration of epinephrine during CPR was not different. Modification of epinephrine dosing interval might promote probability of successful defibrillation.

References

- Kim S, Jung WJ, Roh YI, Kim TY, Hwang SO, Cha KC. Comparison of Resuscitation Outcomes Between 2- or 3-Stacked Defibrillation Strategies With Minimally Interrupted Chest Compression and the Single Defibrillation Strategy: A Swine Cardiac Arrest Model. *J Am Heart Assoc* 2021;10:e021250.
- Perkins GD, Ji C, Deakin CD, et al. A Randomized Trial of Epinephrine in Out-of-Hospital Cardiac Arrest. *N Engl J Med* 2018;379:711–21.
- Callaway CW. Epinephrine for cardiac arrest. *Curr Opin Cardiol* 2013;28:36–42.
- This work was supported by a National Research Foundation of Korea grant from the Korean government Ministry of Science, Information & Communications Technology (ICT) and Future Planning (MSIP) (NRF-2020R1A2C2013954).

Topic: Cardiac arrest.

000258

Development of an automatic device performing chest compression and external defibrillation

Y. I. Roh¹, W. J. Jung¹, K. C. Cha¹, S. O. Hwang¹

¹Department of Emergency Medicine, Yonsei University Wonju College of Medicine, Wonju-si, Republic of Korea

Correspondence: K.C. Cha

Intensive Care Medicine Experimental 2023, **11(Suppl 1)**:000258

Introduction. Automatic chest compression device (ACCD) can promote high quality of cardiopulmonary resuscitation (CPR) and it spreads worldwide recently. Early application of automated external defibrillator (AED) along with high quality CPR is crucial for favorable outcomes in patients with cardiac arrest. We developed an automated CPR apparatus (A-CPR) that combines ACCD and AED in a device and evaluated the performance of the A-CPR through a pilot animal experiment.

Methods. 11 pigs (5 in A-CPR group and 6 in ACCD CPR and AED [C-CPR] group) were enrolled in the study. After 2 min of observation without any treatment after ventricular fibrillation (VF) induction, CPR with 30:2 compression/ventilation ratio was performed for 6 min, mimicking basic life support (BLS). A-CPR or C-CPR was applied immediately after BLS and resuscitation including chest compression and defibrillation was performed following voice prompt from A-CPR device or AED. Hemodynamic parameters including aortic pressure, right atrial pressure, coronary perfusion pressure (CPP), carotid blood flow (CBF), and end-tidal carbon dioxide (ETCO₂) were monitored during resuscitation. Time variables including time to start rhythm analysis, time to charge, time to defibrillate, and time to subsequent chest compression were also measured.

Results. There were no differences in baseline characteristics except PaCO₂ [39 [35–40] in A-CPR vs 33 [31–36] in C-CPR, $p=0.034$). There were no differences in hemodynamic parameters between groups. Time to charge (28.9 ± 5.6 s in A-CPR group vs 47.2 ± 12.4 s in C-CPR group), time to defibrillate (29.1 ± 7.2 s in A-CPR group vs 50.5 ± 12.3 s in C-CPR group) and time to subsequent chest compression (32.4 ± 6.3 s in A-CPR group vs 56.3 ± 10.7 s in C-CPR group) were shorter in A-CPR group than C-CPR group ($p=0.015$, 0.034 and 0.02 respectively).

Conclusions. A-CPR can provide effective chest compressions and defibrillation, resulting in shortening the time to defibrillate.

Topic: Cardiac arrest.

000259

Early or delayed tracheostomy in critically ill patients with Covid-19 respiratory failure: a naïve vs an emulated trial approach

L. Bianchini¹, J. C. Ferreira², R. M. L. Roepke³, P. V. Mendes¹, L. U. Taniguchi¹, B. A.M. P. Besen¹

¹UTI Clínica, Disciplina de Emergências Clínicas, Hospital das Clínicas of the University of São Paulo, São Paulo, Brazil; ²UTI Respiratória, Divisão de Pneumologia, Heart Institute of the Hospital das Clínicas of FMUSP, São Paulo, Brazil; ³UTI Emergencias Cirurgicas e Trauma, Departamento de Cirurgia, Hospital das Clínicas of the University of São Paulo, São Paulo, Brazil

Correspondence: L. Bianchini

Intensive Care Medicine Experimental 2023, 11(Suppl 1):000259

Introduction. The COVID pandemic represented a major global health emergency. Patients may require prolonged mechanical ventilation and eventually a tracheostomy. The ideal tracheostomy timing remains yet to be defined. Most studies about this topic are observational and therefore vulnerable to several biases, such as immortal-time bias.

Objectives. We aimed to evaluate whether tracheostomy timing in patients who required prolonged mechanical ventilation was related to outcomes by using an emulated target trial framework.

Methods. We emulated a hypothetical target trial in which Covid-19 infected patients who required mechanical ventilation (MV) for more than ten days would be randomly assigned to an early tracheostomy (< 21 days) or delayed tracheostomy strategy, which included patients who had a late tracheostomy (> 21 days) and those who were not submitted to a tracheostomy. We used the data from a cohort of patients admitted at Hospital das Clinicas from University of Sao Paulo. In this target trial, we would exclude patients likely to be extubated in the following 72 h and also patients likely to die in the upcoming week. The primary outcome was hospital mortality; ICU and hospital length of stay were secondary outcomes. A secondary analysis was performed

evaluating the patients who received a late tracheostomy or no procedure.

Results. Between March to July of 2020, 618 were mechanically ventilated for > 10 days, of which 325 patients were included in the study after exclusions: 73 underwent early tracheostomy and 252 received a delayed tracheostomy approach. The adjusted odds ratio (OR_{adj}) of early tracheostomy for hospital mortality was 1.21 (95%CI, 0.69–2.14, $p=0.502$). The adjusted mean difference (MD_{adj}) for ICU length-of-stay was 3.9 (95%CI, 0.4–7.4, $p=0.03$) days higher, and for hospital length-of-stay it was 7.2 (95%CI, 2.1–12.2, $p=0.007$) days higher for early tracheostomy compared to a delayed tracheostomy approach. When separating patients who underwent late tracheostomy vs. those who did not undergo tracheostomy, there was no difference in hospital mortality, but ICU LOS was higher for those who actually underwent late tracheostomy compared to those who were not tracheostomized (MD_{adj} = 15.6, 95%CI 12.1–19.2, $p<0.001$) and it was also higher for those who underwent early tracheostomy compared to those who were not tracheostomized (MD_{adj} = 7.6, 95%CI 4.2–11.0, $p<0.001$).

Conclusions. This emulated trial analysis did not observe an association between early tracheostomy and better outcomes in critically ill Covid-19 patients. Studies assessing treatment timing in critical care should avoid naïve approaches that exclude patients who could have been included in a trial.

Table 1 (abstract 000259)

	Delayed approach n = 252	Early tracheostomy n = 73
Age, mean (SD)	60.7 (12.3)	62.2 (10.5)
Sex, n (%)		
Male	142 (56.3%)	40 (54.8%)
Female	110 (43.7%)	33 (45.2%)
Comorbidities, n (%)		
Diabetes mellitus	106 (42%)	33 (45.2%)
Obesity	78 (31%)	24 (32.9%)
Coronary heart disease	30 (11.9%)	7 (9.6%)
Chronic kidney disease	22 (8.7%)	4 (5.4%)
Chronic pulmonary disease (not asthma)	9 (3.6%)	4 (5.5%)
HIV/AIDS	6 (2.4%)	4 (5.5%)
SAPS 3, mean (SD)	69.2 (14.8)	67.2 (15.2)
SOFA, median (IQR)	12 (10, 15)	12 (7.5, 14.5)
Vasoactive drugs during ICU stay, n (%)	236 (93.7%)	70 (95.9%)
Renal replacement therapy during ICU stay, n (%)	131 (52.0%)	40 (54.8%)
Days of mechanical ventilation before Tracheostomy (IQR)	24.5 (22, 28.5)	17 (15, 19)
Ventilatory parameters at the day of the procedure		
Peep, median (IQR)	0.40 (0.30, 0.50)	0.50 (0.40, 0.60)
FIO ₂ , median (IQR)	8 (8, 10)	10 (8, 10)

Table 2 (abstract 000259) Early vs. delayed tracheostomy

	Delayed tracheostomy	Early tracheostomy	Non adjusted analysis	Adjusted analysis
ICU LOS (median, IQR)	24 (18.5, 31.5)	25 (20, 38)	3.89 (95% CI 0.28-7.5, $p=0.03$)	3.89 (95% CI 0.4-7.4, $p=0.03$)
Hospital LOS (median, IQR)	30 (21, 40)	31 (23, 54)	7.24 (95% CI 1.9-12.5, $p=0.009$)	7.2 (95% CI 2.1-12.2, $p=0.007$)
Hospital mortality (%)	152 (60.3%)	47 (64.4%)	1.18 (95% CI 0.69 - 2.14, $p=0.502$)	1.21 (95% CI 0.69 - 2.14, $p=0.502$)

References

- Young D, Harrison DA, Cuthbertson BH et al. Effect of early vs late tracheostomy placement on survival in patients receiving mechanical ventilation: the TracMan randomized trial. *JAMA*. 2013; 22;309(20):2121–9.
- Ji Y, Fang Y, Cheng B et al. Tracheostomy timing and clinical outcomes in ventilated COVID-19 patients: a systematic review and meta-analysis. *Crit Care*. 2022; 26, 40.
- Hernán M, Wang W, Leaf DE. Target trial emulation: a framework for causal inference from observational data. *JAMA*. 2022; 328(24):2446–2447.

Topic: Acute respiratory failure and mechanical ventilation.

000260

Catheter localization by transthoracic echocardiography during Peripherally Inserted Central Catheter: a real-time method to rule out the misplacement

Y.C. Jung¹, S. Man-Shik¹, K. Min-Woong¹

¹Cardiovascular and Thoracic Surgery, Chungnam National University Hospital, Daejeon, Republic of Korea

Correspondence: Y.C. Jung

Intensive Care Medicine Experimental 2023, **11(Suppl 1):000260**

Introduction. Catheter misplacement after a peripherally inserted central catheter (PICC) is annoying. If the catheter is found to be in an aberrant position after the procedure, the practitioner and patient should be prepared for re-insertion. A precise one-time PICC is crucial because patients who undergo PICC are mostly elderly or frail due to advanced disease. In addition, many patients may have poor peripheral access to the available central veins.

PICC placement can be achieved at the bedside without ultrasound or fluoroscopic guidance [1, 2]. However, there are concerns regarding the safety and success of PICC. If blind PICC placement is unsuccessful due to failure to advance the catheter or aberrant positioning, an imaging guidance approach is required for accurate PICC placement [3]. The wide use of real-time imaging techniques during procedures such as fluoroscopy or the C-arm are widely used by practitioners who perform PICC. Fluoroscopy is a valuable imaging tool that can provide a functional and anatomic assessment of patients in real time, as well as radiation exposure to patients and medical staff [4]. Adverse reactions can occur when contrast agents are used in fluoroscopic procedures [5]. Transthoracic echocardiography (TTE) is a reliable tool for detecting catheter misplacement and optimizing catheter tip positioning during central venous catheter insertion [6]. In an environment where ultrasound is prepared, echocardiography can be easily performed when PICC placement. Through this, it is possible to check whether the catheter is correctly located on the right side of the heart. If so, I thought it could clearly prevent the catheter from heading to the opposite arm or neck during PICC. We planned to perform PICC at bedside by this manner.

Objectives. To evaluate the feasibility of catheter detection in the right cardiac cavity using TTE during PICC.

Methods. We conducted a single-center prospective observational study (January 2022–March 2023). All consecutive patients who underwent PICC by TTE were included in this study. Puncture was performed using the landmark method or under ultrasound guidance. TTE was performed during the procedure to monitor the arrival of the catheter in the right cardiac cavity (Fig. 1). Catheter misplacement was defined as an aberrant position on a preprocedural or postprocedural chest X-ray. (CXR) The primary endpoint was the prediction of catheter misplacement based on catheter detection in the right atrial cavity. The secondary endpoint was optimization of catheter tip placement in the superior vena cava–right atrium (SVC–RA) junction at the CXR.

Results. In total, 110 patients were included. Ten patients were excluded due to poor echogenicity. One hundred patients underwent PICC using TTE. The catheter was visualized in the Rt cardiac cavity in 90 cases (Fig. 2). In 10 cases, the catheter was not seen in the right cardiac cavities and CXR showed catheter misplacement in 7 cases. Eight patients with catheter misplacement underwent the same method as the other arm. Therefore, there were a total of 108 procedures. In two patients, PICC failed due to anatomic reasons (Fig. 3). Catheter misplacement was detected by TTE with a sensitivity of 97% (CI 90–99%), a specificity of 90% (CI 55–99%), a positive predictive value of 99%, and a negative predictive value of 75%. Likelihood ratios were LR + 9.69 (CI 1.5–62.3) and LR – 0.03 (CI 0.01–0.1).

Conclusions. TTE is a reliable and feasible diagnostic tool for detecting catheter misplacement and optimizing catheter tip positioning during PICC placement.

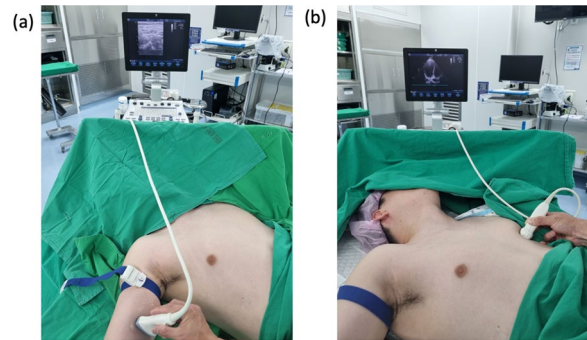

Figure 1 (abstract 000260) . Before antiseptic draping, (a) rapid assessment of peripheral vein by linear probe* (b) mark the best point which echocardiography by apical 4-chamber view or subcostal view shows clear right cardiac cavity by cardiac probe*
* linear/cardiac probe (Vivid S5 Ultrasound machine, 1–4 MHz/5–13 MHz transducer, GE).

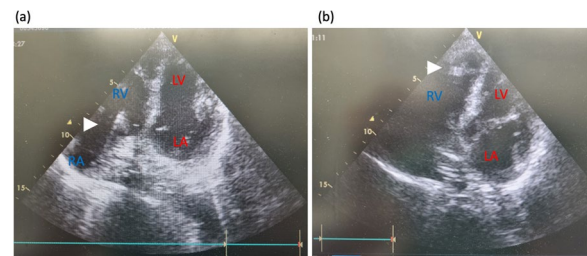

Figure 2 (abstract 000260) . Real-time echocardiography during PICC, Apical 4-chamber view. (a) Catheter heading from RA to RV. (b) Catheter tip on RV. RV; Right ventricle, RA; Right atrium, LV; Left ventricle, LA; Left atrium. Arrowhead; catheter.

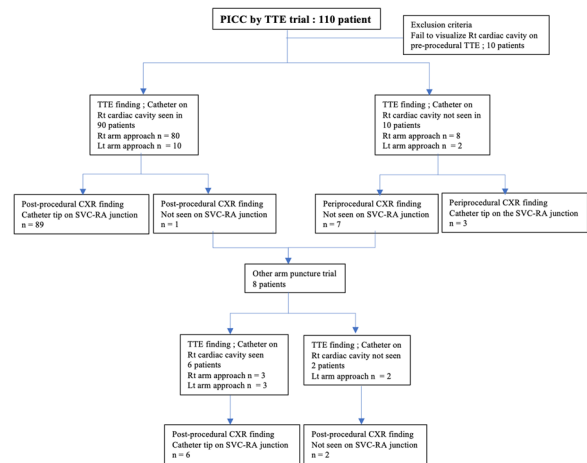

Figure 3 (abstract 000260) . PICC by TTE trial.

References

1. Bedel J, Vallee F, Mari A, Riu B, Planquette B, Geeraerts T, Genestal M, Minville V, Fourcade O, (2013) Guidewire localization by transthoracic echocardiography during central venous catheter insertion: a periprocedural method to evaluate catheter placement. *Intensive Care Med* 39: 1932–1937
2. Johansson E, Hammarskjold F, Lundberg D, Arnlinde MH, (2013) Advantages and disadvantages of peripherally inserted central venous catheters (PICC) compared to other central venous lines: a systematic review of the literature. *Acta Oncol* 52: 886–892
3. Gamulka B, Mendoza C, Connolly B, (2005) Evaluation of a unique, nurse-inserted, peripherally inserted central catheter program. *Pediatrics* 115: 1602–1606
4. Royce B, (2009) Use of C-Arm Fluoroscopy by Nurses for Placement of PICC Lines. *Journal of the Association for Vascular Access* 14: 138–141
5. Storm ES, Miller DL, Hoover LJ, Georgia JD, Bivens T, (2006) Radiation doses from venous access procedures. *Radiology* 238: 1044–1050
6. Andreucci M, Solomon R, Tasanarong A, (2014) Side effects of radiographic contrast media: pathogenesis, risk factors, and prevention. *Biomed Res Int* 2014: 741018

Topic: Cardiovascular issues in ICU.

000262

Patient and public involvement in clinical ICU research: learnings from the FICUS study

R. Naef¹, L. Verweij¹, C. De Blasio², T. Zurbrugg², T. Brühlhart², M. Filipovic³, M. M. Jeitziner⁴, J. Safford², Ficus Study Group⁵

¹Institute for Implementation Science in Health Care, University of Zurich, Zurich, Switzerland; ²FICUS Patient and Family Member Advisory Group, Patient author, n/a, Switzerland; ³Surgical Intensive Care Unit, Division of Anesthesiology, Intensive Care, Rescue and Pain Medici, Cantonal Hospital St. Gallen, St. Gallen, Switzerland; ⁴Department of Intensive Care Medicine, University Hospital Bern, Bern, Switzerland; ⁵Members, FICUS Study Group, Switzerland, Switzerland

Correspondence: R. Naef

Intensive Care Medicine Experimental 2023, **11(Suppl 1)**:000262

Introduction. Involving patients, family members and the public in clinical research helps ensure that research is relevant to those it seeks to serve, namely the healthcare services users. Recognising these potential benefits of patient and public involvement is increasingly mandated by funders. Participatory user-researcher collaborations seem likely to improve enrolment of trial participants, thus improving data quality and results obtained (Crocker et al., 2018). Practical guidance and experiences with user-researcher collaboration in the context of ICU research is, however, scant (Burns et al., 2017; Greenhalgh et al., 2019).

Objectives. We report on the approach, activities, and experiences with a user-researcher collaboration in the context of a multi-centre study investigating a nurse-led, interprofessionally delivered Family support intervention in Intensive Care UnitS (FICUS) (Naef et al., 2022).

Methods. A FICUS user group was established with a patient expert, three family members and one patient with lived experience of ICU care. The user group started work with the research team during the funding application stage of the study. The FICUS study is currently halfway into recruitment. The Critical Outcome of Research Engagement (CORE) (Dillon et al., 2017) guided the definition of the user-researcher collaboration and the development of co-production strategies across the entire research process.

Results. After funding for the study was secured, the FICUS user group structured their collaboration by defining aims, roles and responsibilities within the project, and compensation. Each user could make choices about their contribution as a listener, co-thinker, advisor, partner, or decision-maker (Smits et al., 2020) in relation to specific research activities: to co-produce study recruitment materials and instructions (e.g. video, flyers, study information pack, guidance on recruitment for clinicians), to support intervention delivery (e.g. training of study personnel), to participate in research team meetings and

study group activities, to contribute to communication and dissemination (e.g. quarterly newsletter, protocol publication) and to represent their user perspective and expertise as co-researcher (e.g. presentations at symposia).

Conclusions. Establishing relationships and trust, clarifying roles and mutual expectations, and creating choice in level of contributions has enabled a productive user-researcher collaboration and mutual learning within the FICUS study in the first three years. A group of patient experts and service users have become a valued and essential part of the FICUS study group. Formal evaluation will be needed to examine the experience with and benefit of user-researcher collaborations on participation rates, data quality, translation of findings into policy, and mutual learnings.



FICUS study video.

References

1. Burns, K. E. A., Devlin, J. W., & Hill, N. S. (2017). Patient and Family Engagement in Designing and Implementing a Weaning Trial: A Novel Research Paradigm in Critical Care. *Chest*, 152(4), 707–711. <https://doi.org/10.1016/j.chest.2017.06.028>
2. Crocker, J. C., Ricci-Cabello, I., Parker, A., Hirst, J. A., Chant, A., Petit-Zeman, S., Evans, D., & Rees, S. (2018). Impact of patient and public involvement on enrolment and retention in clinical trials: systematic review and meta-analysis. *BMJ*, 363, k4738. <https://doi.org/10.1136/bmj.k4738>
3. Dillon, E. C., Tuzzio, L., Madrid, S., Olden, H., & Greenlee, R. T. (2017). Measuring the Impact of Patient-Engaged Research: How a Methods Workshop Identified Critical Outcomes of Research Engagement. *J Patient Cent Res Rev*, 4(4), 237–246. <https://doi.org/10.17294/2330-0698.1458>
4. Greenhalgh, T., Hinton, L., Finlay, T., Macfarlane, A., Fahy, N., Clyde, B., & Chant, A. (2019). Frameworks for supporting patient and public involvement in research: Systematic review and co-design pilot. *Health Expectations*, 22(4), 785–801. <https://doi.org/https://doi.org/10.1111/hex.12888>
5. Naef, R., Filipovic, M., Jeitziner, M. M., von Felten, S., Safford, J., Riguzzi, M., & Rufer, M. (2022). A multicomponent family support intervention in intensive care units: study protocol for a multicenter cluster-randomized trial (FICUS Trial). *Trials*, 23(1), 533. <https://doi.org/10.1186/s13063-022-06454-y>
6. Smits, D.-W., van Meeteren, K., Klem, M., Alsem, M., & Ketelaar, M. (2020). Designing a tool to support patient and public involvement in research projects: the Involvement Matrix. *Research Involvement and Engagement*, 6(1), 30. <https://doi.org/10.1186/s40900-020-00188-4>
7. Supported by the Swiss Society of Intensive Care Medicine

8. Funded by the Swiss National Science Foundation

Topic: Nursing care and physiotherapy.

000264

Noninvasive respiratory support to prevent re-intubation after surgery: a systematic review and network meta-analysis

T. Pettenuzzo¹, A. Boscolo Bozza², E. Pistollato³, C. Pretto³, T. A. Giaccon³, S. Frasson³, F. M. Carbotti³, F. Medici³, G. Pettenon³, G. Carofiglio³, M. Nardelli², N. Cucci³, CL. Tuccio³, C. Schiavolin³, C. Simoni³, V. Gagliardi³, S. Crociani³, S. Congedi², F. Zarantonello¹, N. Sella¹, F. Geraldini¹, A. De Cassai¹, P. Navalesi³

¹Department of Medicine, Padova University Hospital, Padova, Italy;

²Department of Medicine, University of Padua, Padua, Italy; ³Department of Medicine, University of Padua, Padova, Italy

Correspondence: T. Pettenuzzo

Intensive Care Medicine Experimental 2023, **11(Suppl 1)**:000264

Introduction. Extubation failure after surgery may be associated with worse outcomes.¹ To prevent or treat post-extubation respiratory failure, different forms of non-invasive respiratory support (NRS), including conventional oxygen therapy (COT), high-flow nasal oxygen (HFNO), continuous positive airway pressure (CPAP), and noninvasive ventilation (NIV), have been proposed.¹

Objectives. The aim of this systematic review and network meta-analysis is assessing the effect of NRS application on the rate of re-intubation.

Methods. The review protocol was registered in PROSPERO (CRD42022377859). Medline, Embase, Scopus, CENTRAL, and Web of Science were searched from inception until March 19, 2023. All studies meeting the following criteria were included: participants were adult patients extubated after surgery; the intervention and comparison were any NRS modality; the primary outcome was re-intubation, whereas intensive care unit (ICU) and hospital mortality and length of stay, time to re-intubation, and the incidence of nosocomial pneumonia and patient discomfort were secondary outcomes; study design was randomized controlled trials (RCTs) or non-randomized controlled studies.

The risk of bias was evaluated with the Risk of Bias (RoB) 2 and the Risk Of Bias In Non-randomized Studies of Interventions (ROBINS-I) assessment tools.² Meta-analyses were performed using a random-effects model, the inverse variance method for continuous outcomes, and the Mantel-Haenszel method for dichotomous outcomes.² Statistical heterogeneity was assessed using the chi-squared test and I² statistic. Two-sided p-values < 0.05 were considered significant.

Results. Twenty-seven RCTs (9028 patients) and five non-RCTs (2193 patients) were included (Fig. 1). Supra-diaphragmatic surgery was studied in 21 studies, while 11 studies investigated infra-diaphragmatic or mixed surgery. Twenty-three studies (72%) were performed in the ICU. NRS was employed as prophylaxis in 19 studies (59%) and therapy in 11 (34%). Most studies (11, 34%) tested the comparison between COT and HFNO, 9 (28%) between COT and NIV, and 9 (28%) between COT and CPAP.

Among RCTs, six studies were considered at low risk of bias, 16 studies arose some concerns, and five studies were considered at high risk of bias. Among non-RCTs, two studies were considered at serious and three at critical risk of bias.

As compared with COT, NIV (OR 0.50, 95% CI 0.28–0.88, p=0.02, I²=62%) reduced the incidence of re-intubation (Fig. 2) and was associated with lower ICU (OR 0.39, 95% CI 0.17–0.90, p=0.03, I²=0%) and hospital mortality (OR 0.51, 95% CI 0.34–0.77, p=0.001, I²=0%). NIV and CPAP were associated with shorter ICU length of stay, CPAP with shorter hospital length of stay, and NIV with lower risk of nosocomial pneumonia. Among-group differences in discomfort were not significant.

Conclusions. NIV reduced the risk of re-intubation and mortality, as compared with COT, in adult patient extubated after surgical procedures.

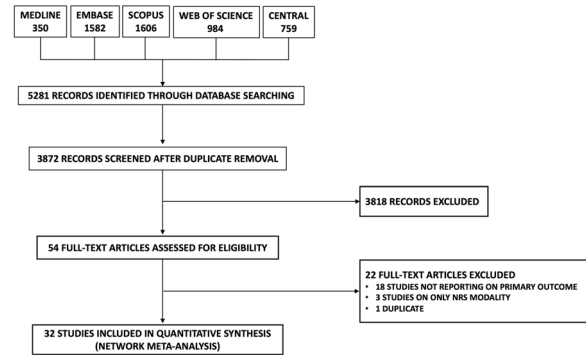

Figure 1 (abstract 000264) Study flow diagram. Abbreviations: NRS, non-invasive respiratory support

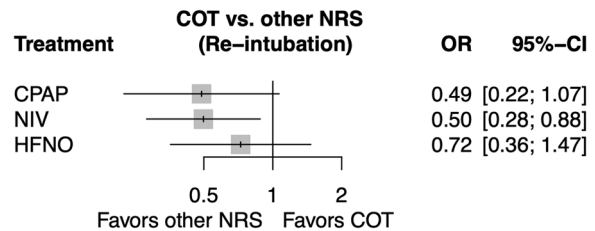

Figure 2 (abstract 000264) Forest plot of rate of re-intubation. Abbreviations: COT, conventional oxygen therapy; NRS, non-invasive respiratory support; OR, odds ratio; CI, confidence interval; CPAP, continuous positive airway pressure; NIV, non-invasive ventilation; HFNO, high-flow nasal oxygen

References

- Higgins JPT, Thomas J, Chandler J, et al. (editors). Cochrane Handbook for Systematic Reviews of Interventions version 6.3 (updated February 2022). Cochrane, 2022. Available from www.training.cochrane.org/handbook.
- Lockstone J, Denehy L, Truong D, et al. Prophylactic Postoperative Noninvasive Ventilation in Adults Undergoing Upper Abdominal

Topic: Acute respiratory failure and mechanical ventilation.

000266

Machine learning to predict when to safely stop antibiotics in the intensive care unit

T. A. Dam¹, R. Schade², J. De Steenwinkel³, P.J. Thoral⁴, A. Girbes⁴, M. Hoogendoorn⁵, P. Elbers⁴, L. Fleuren⁴

¹Intensive care medicine, Amsterdam UMC, locatie VUmc, Amsterdam, Netherlands; ²Department of Medical Microbiology and Infection Prevention, Amsterdam UMC-Location VUmc, De Boelelaan, Amsterdam, Netherlands, Amsterdam, Netherlands; ³Department of Medical Microbiology and Infectious Diseases, Erasmus University Medical Center, Rotterdam, Netherlands; ⁴Intensive care adults, Amsterdam UMC, locatie VUmc, Amsterdam, Netherlands; ⁵Computational intelligence, Vrije Universiteit Amsterdam, Amsterdam, Netherlands

Correspondence: T. A. Dam

Intensive Care Medicine Experimental 2023, **11(Suppl 1)**:000266

Introduction. Unnecessary antibiotic treatment in ICU patients can lead to an increase in side effects, antibiotic resistance, and higher costs. Early termination of antibiotics may lead to clinical deterioration or a restart of antibiotics. Using machine learning models, we aim to predict whether therapeutic antibiotics can be safely stopped in intensive care patients.

Methods. We retrospectively collected data on all adult ICU patients that were treated with antibiotics in two tertiary academic hospitals in the Netherlands. We removed all antibiotic records marked as prophylaxis and reconstructed antibiotic courses. Our primary outcome was restarting of therapeutic antibiotics within 72 h and no readmission or death within 72 h after termination. We included monitor data, laboratory data, selective decontamination strategy, and culture results as predictors. We trained logistic regression, random forest and XGBoost models to predict restarting antibiotics.

Results. A total of 10,087 patients were included, with 10,643 hospital admissions and 11,439 ICU admissions between October 2015 and December 2021, with a total of 10,982 therapeutic antibiotic series. The primary outcome of restarting therapeutic antibiotics occurred in 2,504 (16.2%) of antibiotic courses. Of these, the same antibiotic was restarted in 567 cases (36.1%), and the same therapeutic subgroup according to the Anatomical Therapeutic Chemical (ATC) was restarted in 1,713 cases (68.4%).

Conclusions. Antibiotics are frequently restarted with the exact same antibiotic, indicating potential for improvement. Advanced analytics such as machine learning models could potentially identify patients for whom antibiotics will be restarted while also identifying patients for whom antibiotics can safely be terminated. Further research will use logistic regression, random forest, and XGBoost to attempt to classify these groups. Furthermore, performance may be improved through the use of soft predictors such as delirium observation scales, the use of antipsychotics and sedatives, or increased gastric retention.

Topic: Data Science.

000268

The alveolar fibroproliferative response in COVID-19-related acute respiratory distress syndrome and one-year follow up

S. Zhang¹, L. S. Boers¹, J. Brabander, De², L. Van Den Heuvel¹, S. G. Blok¹, T. Dekker³, H. L. Abersson³, L. J. Meijboom⁴, A. P. J. Vlaar¹, L. Heunks⁵, E. Nossent⁶, T. van der Poll², L. Bos¹, J. Duitman⁶, L. Van Den Heuvel¹, B. Smids-Dierdorp⁶, R. F. J. Kullberg²

¹Department of intensive care unit, Amsterdam UMC, locatie AMC, Amsterdam, Netherlands; ²Center for experimental and molecular medicine, Amsterdam UMC, locatie AMC, Amsterdam, Netherlands; ³Experimental Immunology (EXIM), Amsterdam UMC, locatie AMC, Amsterdam, Netherlands; ⁴Radiology and Nuclear Medicine, Amsterdam UMC, locatie VUmc, Amsterdam, Netherlands; ⁵Intensive Care, Erasmus University Medical Center, Rotterdam, Netherlands; ⁶Department of pulmonary medicine, Amsterdam UMC, locatie AMC, Amsterdam, Netherlands

Correspondence: S. Zhang

Intensive Care Medicine Experimental 2023, **11**(Suppl 1):000268

Introduction. Approximately one-third of hospitalized COVID-19 patients develop acute respiratory distress syndrome (ARDS). An alveolar fibroproliferative response (FPR) during hospitalization may induce long-term pulmonary fibrotic lesions in patients who recovered from COVID-19-related ARDS. Chest computed tomography (CT) and lung function test (PFT) are used to identify the signs of pulmonary fibrosis. N-terminal of procollagen III (NT-PCP-III) is a validated biomarker for an activated FPR in ARDS.

Objectives. We aimed to 1) assess pulmonary fibrotic injury in COVID-19 ARDS patients at 3 and 12 months after hospital discharge; 2) evaluate the association between dynamic changes in alveolar FPR during hospitalization and long-term outcomes as well as 90 day mortality in these patients.

Methods. In this prospective observational cohort study, bronchoalveolar lavage (BAL) and blood samples were collected from COVID-19 ARDS patients admitted to the ICU of two academic hospitals for the measurement of 17 pulmonary fibrosis biomarkers, including NT-PCP-III. Pulmonary function and chest CT were assessed at 3 and 12 months after hospital discharge. Forced vital capacity (FVC), diffusing capacity of the lungs for carbon monoxide (DLCO) and ground-glass opacities (GGO) percentage on CT images from the first and second follow-up

visits were compared using a paired Wilcoxon test. Joint modeling was performed to assess the association between longitudinal changes in the biomarkers and mortality at day 90 after intubation. The relationship between alveolar biomarker concentrations and clinical outcomes was analyzed using linear mixed models and logistical regression models for consecutive and dichotomous independent variables, respectively.

Results. One hundred and fifty-four COVID-19 ARDS patients with 284 BAL samples were analyzed, ninety-two (59.7%) patients died within 90 days after intubation and 54 (35.1%) survivors completed the follow-up procedure. FVC and DLCO were impaired at the first follow-up and improved significantly at one year after hospital discharge ($p=0.03$ and $p=0.004$, respectively) (Fig. 1). A longitudinal increase in NT-PCP-III, along with other pulmonary fibrosis markers, was associated with increased 90-day mortality (HR 2.89, 95% CI: 2.55 to 3.28; $p<0.001$). No significant association was found between the alveolar FPR during hospitalization and signs of pulmonary fibrosis assessed by pulmonary function test or chest CT images within one-year follow-up.

Conclusions. In COVID-19-related ARDS patients, the alveolar FPR during hospitalization was associated with higher mortality, but not with the presence of long-term fibrotic lung sequelae within survivors.

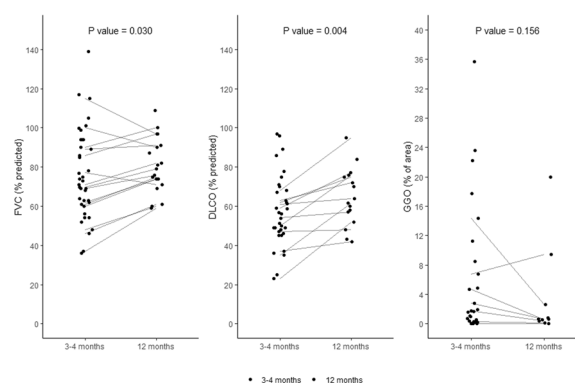

Figure 1 (abstract 000268) Comparison of lung function and CT image between the two follow-up visits. (Left) The changes of FVC % predicted value, (Middle) the changes of DLCO % predicted value, (Right) the percentage changes of GGO in the whole lung

References

- Netherlands Organization for Scientific Research (NWO) under VENI grant 016.1860.046 to JWD
- Amsterdam UMC fellowship to LDJB in 2020

Topic: Acute respiratory failure and mechanical ventilation.

000269

A novel eye-tracking platform for the continuous and automatic diagnosis of delirium in ICU

A. Al-Hindawi¹

¹Intensive Care Unit, Chelsea and Westminster Hospital, London, United Kingdom

Correspondence: A. Al-Hindawi

Intensive Care Medicine Experimental 2023, **11**(Suppl 1):000269

Introduction. Delirium is associated with increased mortality, morbidity, and long-term cognitive dysfunction [1,2]. Yet, no objective marker has been developed to automate the diagnosis and current standards rely on a manual, laborious, assessment of consciousness and attention, e.g., the Confusion Assessment Method in ICU (CAM-ICU) [3]. Visual inattention has been hypothesized to be diagnostic for delirium, however, no suitable eye-tracking platform exists [4].

Objectives.

1. To develop and deploy an eye-tracking platform suitable for use in ICU to classify delirium from eye movements
2. To develop a cognitive architecture that explains the data using established neuro-computational paradigms

Methods. Empiric requirements led to the development of a novel platform that uses specialized neural networks for the regression of eye movements in a calibration-free, non-invasive manner [5–7]. Following ethical and governance approvals, a multi-centre feasibility study was conducted. ICU patients recruited into the study underwent daily recording of eye movements for 10 min with concurrent measurement of CAM-ICU.

The data gathered were then used to train classification models to predict the conditional probability of delirium. Classification accuracy was assessed by discrimination performance using Receiver Operator Characteristics and Precision-Recall Curves alongside their summary statistics (Area under the ROC (AUROC) and mean Average Precision (mAP)).

For explainability, a novel architecture composed of multiple competing forward models of the visual processing hierarchy was built. Statistical significance was performed with an α of 0.05.

Results. A total of 210 recordings were made from 42 patients using the platform (Fig. 1a). Two models were trained (Fig. 1b); the eye-movements-only model achieved good discrimination performance (AUROC 0.67, mAP 0.68) whilst the second model, which took into consideration what the patient was looking at, further increased performance metrics (AUROC 0.76, mAP 0.81) (Fig. 2).

The novel competing forward models architecture (Fig. 1c) was able to recall internal cognitive states. Using data gathered from the study, the architecture demonstrated that patients with delirium are visually inattentive throughout the visual processing hierarchy ($p=0.044$, χ^2 , $df=4$). This finding is in keeping with the network disconnectivity hypothesis but in an automatic, non-invasive manner.

Conclusions. A novel eye-tracking platform was developed, validated, and deployed across two hospitals which could objectively and automatically diagnose delirium. Neuro-computational models of the visual processing hierarchy demonstrate that delirium is punctuated by visual inattention throughout the visual processing hierarchy.

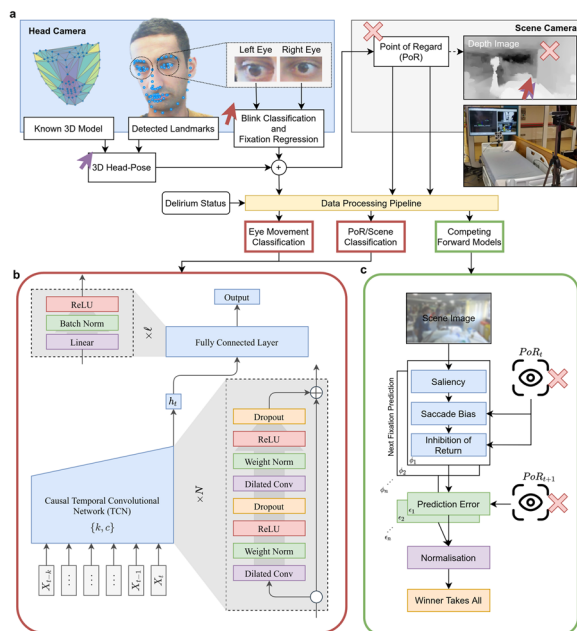

Figure 1 (abstract 000269) Data acquisition, processing, and model overview. a demonstrates the duties of the head-camera and the scene-camera pictorially. (A) The head-camera locates the patient’s

head using a face-detector followed by the extraction of pre-specified landmarks and the calculation of the 3D head-pose. The eye patches are also extracted which are used for blink classification and fixation regression. The gaze-vector, in combination with the 3D Head-Pose are then used to find the PoR of the patient from the scene-camera. Inset picture showing the setup of the cameras around a bed-space. (B) demonstrates the architecture for delirium classification using Temporal Convolutional Networks (TCNs). Time-series inputs are encoded to a fixed-sized vector using a TCN where a set of fully connected layers are used to convert the encoded vector to the probability of delirium. X_t represents the input at time point t , h_t represents the hidden latent fixed vector size that encodes previous time points. (C) demonstrates the proposed competing forward models architecture for explaining viewing behaviour; the architecture is composed of three modules, the first module predicts the next fixation in a probabilistic manner (φ_n), the next performs prediction error measurement of each forward model (ϵ_n), and the final module performs softmax normalisation. The forward models then compete for assignment in a Winner Takes All (WTA) scheme

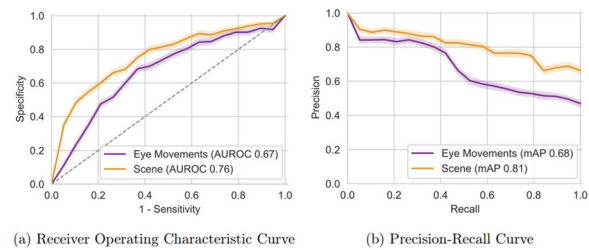

Figure 2 (abstract 000269) Performance of the models for the binary classification task of diagnosing delirium comparing an eye-movements only model against a scene model. The eye movements model classifies delirium based on time-series eye movement data, namely the horizontal and vertical eye angles of each fixation. Whereas the scene model contains time-series gaze-scene intersection data. Both classification models use the architecture in Fig. 2. Eye movements alone have good discriminatory performance for the diagnosis of delirium but are improved upon once scene information is added

References

1. Al-Hindawi, A., Vizcaychipi, M. P. & Demiris, Y. Continuous Non-Invasive Eye Tracking In Intensive Care. in 2021 43rd Annual International Conference of the IEEE Engineering in Medicine Biology Society (EMBC) 1869–1873 (2021). <https://doi.org/10.1109/EMBC46164.2021.9630999>.
2. Al-Hindawi, A., Vizcaychipi, M. P. & Demiris, Y. What Is The Patient Looking At? Robust Gaze-Scene Intersection Under Free-Viewing Conditions. in ICASSP 2022–2022 IEEE International Conference on Acoustics, Speech and Signal Processing (ICASSP) 2430–2434 (2022). <https://doi.org/10.1109/ICASSP43922.2022.9746437>.
3. Al-Hindawi, A., Vizcaychipi, M. & Demiris, Y. Faster, Better Blink Detection through Curriculum Learning by Augmentation. in 2022 Symposium on Eye Tracking Research and Applications 1–7 (Association for Computing Machinery, 2022). <https://doi.org/10.1145/3517031.3529617>.
4. A.A and M.P. would like to thank the British Medical Association (BMA) Research Fund J Moulton Prize for clinical research into mental health and CW+ charity for their funding of this project.
5. M.P. would like to thank the Westminster Medical School Research fund for their ongoing support.
6. Y.D. would like to thank the Royal Academy of Engineering for his chair in Emerging Technologies.
7. Edelstein, D. M. et al. Effect of postoperative delirium on outcome after hip fracture. Clin. Orthop. 422, 195–200 (2004).
8. Kunicki, Z. J. et al. Six-Year Cognitive Trajectory in Older Adults Following Major Surgery and Delirium. JAMA Intern. Med. (2023) <https://doi.org/10.1001/jamainternmed.2023.0144>.
9. Ely, E. W. et al. Evaluation of delirium in critically ill patients: Validation of the Confusion Assessment Method for the Intensive Care Unit (CAM-ICU). Crit. Care Med. 29, 1370 (2001).

10. Exton, C. & Leonard, M. Eye tracking technology: a fresh approach in delirium assessment? *Int. Rev. Psychiatry* 21, 8–14 (2009).

Topic: Sedation, analgesia and delirium.

000270

Reducing the number of inappropriate referrals to intensive care using a novel referral form—a quality improvement project

A. Agrawal¹

¹Intensive Care, Queen Elizabeth The Queen Mother Hospital, London, United Kingdom

Correspondence: A. Agrawal

Intensive Care Medicine Experimental 2023, **11(Suppl 1)**:000270

Introduction. The intensive treatment unit (ITU) provides a specialist service within the hospital however with a limited number of beds available, there is often a large demand for the spaces. We found in our intensive care department that there were a large proportion of referrals to ITU compared to the number of patients actually accepted for admission. There was no record being kept of the referrals which were coming in to the department. Our two fold QIP focussed on creating a referral form to keep documentation of all the referrals made to ITU. Secondly, we audited the inappropriate referrals and then put in interventions to improve this. The role of trainees in ITU was reduced significantly by multiple bleeps which were often due to inappropriate referrals.

Objectives. The first aim was to create a standardised documentation of referrals to ITU within our local centre so they can be audited in the future. Our second aim was to reduce the number of inappropriate referrals to ITU to create greater efficiency within the department and improve flow in the hospital.

Methods. We first created a referral form (picture 1) which we wanted to be sustainable so was created using the SBAR handover tool as the format, which is commonly used in the intensive care medicine setting (Shahid & Thomas, 2018). This was used by the doctor in ITU who was accepting referrals to document the referral. This was used to categorise the type of referral which we then analysed over the period of 3 months. Inappropriate referrals were further classified into categories to create themes of inappropriate referrals. This led to development of teaching for medical and surgical specialties during their departmental teaching half days.

Results. Across the first data collection period we found each month there were 50–60% inappropriate referrals made to ITU. The main themes which emerged as the reasons for inappropriate referrals were inappropriate escalation status and patients who were referred without a clear organ support indication. Following departmental teaching for medical and surgical specialties, we saw a reduction in the number of inappropriate referrals to on average 40% per month during the re-audit period.

Conclusions. This QIP provides sustainable change in terms of increasing efficiency within the department as the referral form is a tool which aids the doctor receiving referrals in ITU, instead of adding to their workload. One of the main issues was objective decision making around which referrals were considered inappropriate. This also raises the issue of a lack of guidelines around admissions to ITU (Metcalf et al., 2000). There was also a category of patients who were refused admission to ITU despite being appropriate referrals, mainly due to capacity within the unit. Further development of the project can aim to look at mortality within the appropriately referred patients who were refused admission to ITU.

The impact of this QIP on the trainees within ITU was reduction in the number of inappropriate referrals which meant during unsociable hours when resources are limited, more time can be spent on the patients within the unit. Patients were also escalated within their parent team appropriately before being referred to intensive care. This provided more effective and thorough specialty care for patients.

ITU Referral SBAR Form

Pt details:

Situation					
Background (co-morbidities?)					
Assessment (functional status?)					
Recommendation (current Mx plan?)					
DNAR?	YES <input type="checkbox"/>	NO <input type="checkbox"/>	TEP done?	YES <input type="checkbox"/>	NO <input type="checkbox"/>
Referrer details?	F1 <input type="checkbox"/>	SHO <input type="checkbox"/>	Reg <input type="checkbox"/>	Consultant <input type="checkbox"/>	
Has the patient been discussed with own team's consultant?			YES <input type="checkbox"/>	NO <input type="checkbox"/>	
Outcome: Accepted to ITU <input type="checkbox"/> Declined admission/not for ITU <input type="checkbox"/> Inappropriate referral <input type="checkbox"/>					
If declined or inappropriate please say why:					

Picture 1 (abstract 000270) Referral form for ITU

References

- Shahid, S. and Thomas, S. (2018) Situation, background, assessment, recommendation (SBAR) communication tool for handoff in Health Care – A Narrative Review—safety in health, SpringerLink. BioMed Central. Available at: <https://link.springer.com/article/10.1186/s40886-018-0073-1> (Accessed: April 11, 2023).
- Metcalf, A., Sloggett, A. and McPherson, K. (2000) Mortality among appropriately referred patients refused admission to intensive-care units, *The Lancet*. Elsevier. Available at: <https://www.sciencedirect.com/science/article/abs/pii/S0140673696100180> (Accessed: April 11, 2023).
- Nil

Topic: Critical care organisation, quality management, information systems, outcomes.

000275

Development and validation of machine learning model to predict mortality within 24 h in intensive care unit patients

L. Lim¹, U. Gim², K. Cho², D. Yoo³, Y. Lee², H. G. Ryu¹, H. C. Lee¹

¹Anesthesiology and Pain Medicine, Seoul National University Hospital, Seoul, Republic of Korea; ²R&D division, VUNO, Seoul, Republic of Korea;

³Medical division, VUNO, Seoul, Republic of Korea

Correspondence: L. Lim

Intensive Care Medicine Experimental 2023, **11(Suppl 1)**:000275

Introduction. In the intensive care unit (ICU), physicians encounter a large amount of data, various alarms and noises. Previous studies have shown that vital signs deteriorated several hours before critical events,

but too much data can rather distract physicians from instantly recognizing the deterioration of the patients. By stratifying patients into different risk categories and detecting patients at risk of physiological derangements earlier, mortality prediction models help physicians redistribute the limited resources, recognize patients at risk, and correct the deterioration properly. In this study, we developed a deep-learning based real-time prediction model for mortality within 24 h in critically ill patients by utilizing only the variables easily extractable from electronic health records in most clinical settings.

Methods. The study protocol was reviewed and approved by the Institutional Review Board (IRB No. 2111-140-1275) of Seoul National University Hospital (SNUH), and the IRB waived the requirement for informed consent. The internal cohort consisted of patients who were admitted to one of six ICUs at SNUH between May, 2007, and October, 2021. We extracted binary mortality information from the time of patient death during the ICU stay and a panel of 27 critical candidate features which were selected by clinical experts, and easily collectible from the electronic medical recording systems. Candidate features consisted of 10 vital signs, 16 laboratory variables, and age.

To develop a machine learning model predicting the mortality risk score within 24 h in real-time, we employed a model ensemble approach to improve the effectiveness of our prediction model. Several individual models with different architectures were trained using SNUH dataset. Various combinations of models were compared and the best-performing ensemble model was selected as our final model. The performance of model was assessed in two main domains: its predictive accuracy using the area under receiver operating characteristic curves (AUROC) and the ability to reduce alarm counts at the same sensitivity level using the mean alarm count per day (MACPD). Internal validation was conducted using SNUH dataset. We also performed external validation using Medical Information Mart for Intensive Care (MIMIC-III) and eICU Collaborative Research Database (eICU-CRD).

Results. During the study period, 61,954 patients were included and mortality occurred in 1,830 (2.95%). 147,187 event vital signs and 8,922,443 normal vital signs were analyzed. Our model showed better performance compared to the conventional models in the internal validation, with AUROC of 0.96 (95% CI 0.968–0.970) (Fig. 1). Considering that the highest AUROC of mortality prediction among conventional models was 0.856 (95% CI 0.853–0.859) of national early warning system (NEWS), our model significantly improved the predictive ability for mortality within 24 h ($p < 0.001$). Though the performance was slightly decreased in the external validations, AUROCs were still higher compared to conventional models (0.895 (95% CI 0.894–0.896) vs. 0.793 (0.794–0.796) in MIMIC-III, and 0.901 (0.901–0.092) vs. 0.789 (0.788–0.790) in eICU-CRD, compared to NEWS, both $p < 0.001$) (Fig. 1). With sensitivity of 0.8, our model reduced MACPD from 10,960 counts in $NEWS \geq 4$, to 978 counts (8.92%) in internal dataset. By our model MACPD was also reduced to 23.8% (11,429 in $NEWS \geq 4$ and 2715 in our model, with sensitivity of 0.715) in MIMIC-III and, to 18.9% (11,804 in $NEWS \geq 4$ and 2226 in our model, with sensitivity of 0.729) in eICU-CRD.

Conclusions. We developed a real-time and explainable ensemble model to predict mortality within 24 h for critically ill patients from a dataset of single center in Korea with more than 60,000 adult patients of 5 different ICUs. External validation was also done and performance was maintained in popular and open external dataset—MIMIC-III and eICU-CRD dataset. However, the results should be confirmed in a prospective study, before application as a decision-support tool at a real practice.

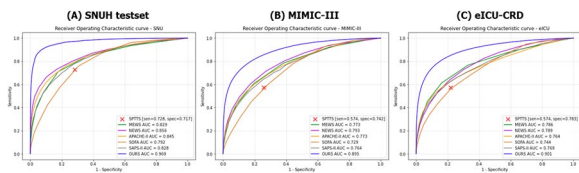

Figure 1 (abstract 000275) Comparison of area under receiver operating curve (AUROC) of our model (blue line) and conventional

prediction scoring systems to predict in-ICU mortality within 24 hours in (A) SNUH testset. (B) MIMIC-III, and (C) eICU-CRD

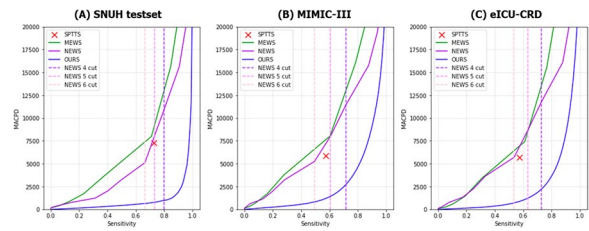

Figure 2 (abstract 000275) Comparison of mean alarm count per day of our model (blue line) and conventional prediction scoring systems to predict in-ICU mortality within 24 hours in (A) SNUH testset. (B) MIMIC-III, and (C) eICU-CRD

References

- Johnson AE, Pollard TJ, Shen L, Lehman LW, Feng M, Ghassemi M, et al. MIMIC-III, a freely accessible critical care database. *Sci Data.* 2016;3:160,035.
- Vincent JL, Moreno R. Clinical review: scoring systems in the critically ill. *Crit Care.* 2010;14(2):207.
- Moreno RP. Outcome prediction in intensive care: why we need to reinvent the wheel. *Curr Opin Crit Care.* 2008;14(5):483–4.
- This work was supported by the Ministry of Health & Welfare, Republic of Korea [grant number: HI21C1074].
- Pollard TJ, Johnson AEW, Raffa JD, Celi LA, Mark RG, Badawi O. The eICU Collaborative Research Database, a freely available multi-center database for critical care research. *Sci Data.* 2018;5:180,178.

Topic: Critical care organisation, quality management, information systems, outcomes.

000278

Deep learning based early warning score for predicting in-hospital cardiac arrest in a rapid response team with minimal manpower

S. J. kwon¹, M. Lee¹, D. Kang¹, I. B. Jeong¹, J. W. Son², W. J. Hwang³, H. J. Jeong⁴

¹Respiratory and Critical Care Medicine, Konyang University Hospital, Daejeon, Republic of Korea; ²Respiratory medicine, Konyang University Hospital, Daejeon, Republic of Korea; ³Department of General Thoracic & Cardiovascular Surgery, Konyang University Hospital, Daejeon, Republic of Korea; ⁴Rapid Response Team, Konyang University Hospital, Daejeon, Republic of Korea

Correspondence: S.J. kwon

Intensive Care Medicine Experimental 2023, **11(Suppl 1)**:000278

Introduction. In hospital cardiac arrest is an event that has a significant impact on patient safety, and recently developed deep learning based early warning scoring (DEWS) has been shown to be an effective warning system. In our hospital operating a ‘weekday only’ rapid response team (RRT) with minimal manpower, cardiac arrest was 2.3 per 1,000 hospitalizations with high false alarms in general wards in 2022.

Objectives. We investigated whether deep learning-based warning score (DEWS) would be effective to predict of cardiac arrest and to reduce false alarms.

Methods. DEWS analyzed six parameters of age, sex, SBP/DBP, heart rate, respiratory rate, and body temperature and used the already validated DeepCARSTM (VUNO Med, South Korea) product. Inpatients in the general ward, excluding patients aged 15 years or younger and admitted to the intensive care unit (ICU), emergency department, operating and delivery room, were compared with modified early warning score (MEWS) for analysis. From January 1, 2023, to January 31, 2023, major adverse events (MAEs) such as cardiac arrest, unexpected ICU transfer, do-not-resuscitation, hospital death were retrospectively analyzed.

Results. During the study period, a total of 56,155 inputted vital signs were analyzed as predictive data, and a total of 2,243 patients were hospitalized. There were 2.22 cardiac arrests per 1,000 admissions and 26 unexpected ICU admissions. AUROC was 0.832 ($p < 0.01$) in DEWS compared to 0.732 in MEWS, and the sensitivity was 38.8% under the same condition of 98% specificity, which was higher than MEWS with 22.6%. False positive alarms decreased by 43% in DCARS from 1,760 cases to 1,001 cases. MEWS has a low correlation with score distribution, but true positives increase as DEWS increases.

Conclusions. In DEWS, higher prediction rate and false positive alarm can be reduced, so it can be applied in RRT operated with minimal manpower.

References

- Lee YJ, Cho KJ, Kwon O, et al. A multicentre validation study of the deep learning-based early warning score for predicting in-hospital cardiac arrest in patients admitted to general wards. *Resuscitation*. 2021; 163: 78–85

Topic: Cardiac arrest.

000282

Is 160 mmHg a good cut-off point to start antihypertensive treatment in patients with spontaneous subarachnoid hemorrhage?

J. Camaño Fortanet¹, B. Sanchez Tomás¹, B. Bosca Martínez¹, L. Tormo Rodríguez¹, M. Bueso Navarro¹, A. Barca Fuster¹, B. Vidal Tegeador¹, E. Rodríguez Martínez¹, I. Catalán Monzón¹, L. Galarza Barrachina¹

¹Intensive Care Unit, Hospital General Universitario de Castellón, Castellón de la Plana, Spain

Correspondence: J. Camaño Fortanet

Intensive Care Medicine Experimental 2023, **11(Suppl 1)**:000282

Introduction. AHA/ASA clinical practice guidelines recommend lowering systolic blood pressure to < 160 mmHg to reduce the risk of rebleeding, however the evidence is scant and we do not know the effect on other complications or in the prognosis.

Objectives. To assess the effect of systolic blood pressure on the first medical contact, according to the cut-off point of 160 mmHg, on clinical course and outcome in patients with aneurysmal subarachnoid haemorrhage (aSAH).

Methods. Prospective cohort study that included all SAH admitted to our ICU from March 2017 to May 2021. Based on the blood pressure, patients were divided into high blood pressure (HBP) ($BP \geq 160$ mmHg) and non-HBP ($BP < 160$ mmHg). Demographic, clinical, and outcome variables were collected. Statistical analysis was performed with STATA 14.0.

Results. 121 patients were included, 77% women, with a mean age of 58 years (48.11–63.31). 41.3% were previously hypertensive and 33% received treatment. 41.3% presented HBP on admission. The differences between the HBP and non-HBP groups are described in Table 1.

Table 1 (abstract 000282) Demographic and clinical variables and complications in both groups

	No HBP (SBP < 160) 71 (58,7)	HBP (SBP \geq 160) 50 (41,3)	p
Sex (male)	22 (30,98)	22(44)	0,143
Age (years)	53,78 \pm 12,23	61,5 \pm 13,53	0,001
Previous HBP	20 (28,57)	30 (60)	0,000
Previous antihypertensive treatment	17 (24,28)	23 (46)	0,011
<i>Scales</i>			
SAPS 3	50,6 \pm 15,53	53,86 \pm 13,99	0,239
HH 4 or 5	22 (31)	17 (34)	0,72
Fischer 4	33 (47)	26 (53)	0,55
<i>Complications</i>			

	No HBP (SBP < 160) 71 (58,7)	HBP (SBP \geq 160) 50 (41,3)	p
Vasospasm	20 (28,98)	3 (6,52)	0,003
Ischemia	20 (28,98)	5 (10,86)	0,021
Rebleeding	6 (8,57)	5 (10,86)	0,679
Hydrocephalus	24 (34,28)	12 (26,08)	0,35
Troponins peak (ng/l)	112,9 \pm 216,2	103 \pm 265,1	0,826
Pro-BNP peak (pg/ml)	1213,4 \pm 1722,5	874,13 \pm 969,4	0,241

Data is displayed as mean and standard deviation or numbers and percentages.

Mortality was 28.9%, with no significant differences between both groups. Ordinal regression analysis adjusted for age and Hunt-Hess 4–5 showed no relationship with GOSE at 6 or 12 months.

Conclusions. HBP presented after SAH is more common in patients with premonitory hypertension, despite treatment. There are no differences in the presence of rebleeding, in mortality or long-term prognosis between groups, but patients without HBP presented more vasospasm and ischemia.

Topic: Neurointensive care.

000285

Economic evaluation of extensive extracorporeal membrane oxygenation (ECMO) in the COVID-19 treatment in China

Y. Lu¹, W. Huang²

¹Department of Epidemiology, Fudan University School of Public Health, Shanghai, China; ² Department of Intensive Care Medicine, The Sixth People's Hospital, Shanghai Jiao Tong University, Shanghai, China

Correspondence: Y. Lu

Intensive Care Medicine Experimental 2023, **11(Suppl 1)**:000285

Introduction. Extracorporeal membrane oxygenation (ECMO) has been developed to mainly provide continuous extracorporeal respiration and circulation for patients with severe cardiopulmonary failure. In the COVID-19 pandemic, ECMO has been extensively utilized to maintain the lives of patients with severe and critical COVID-19. It remains crucial to review the ECMO utilization and clarify its potential indications.

Objectives. This study aims to determine the clinical outcome after the ECMO practice and then perform preliminary economic evaluation.

Methods. We investigated the ECMO utilization in a certain region of China in 2022 and then followed-up the outcomes. Cost-effectiveness was estimated using the decision tree-Markov model, assuming a time period of 12 consecutive months.

Results. Number of ECMO practice increased by 109.2% in this region, particularly in designated hospitals and tertiary hospitals. Unfortunately, 36.0% of the COVID-19 patients died within the 30 days following the ECMO practice, regardless of on-ECMO / off-ECMO status, and 11.4% died in the following 2–8 months. In contrast, 52.5% remained alive. We further reviewed these patients' medical conditions at the point of ECMO. Subsequently, 17.7% of those dead and 25.5% of those alive might not be applicable to the ECMO indications. Moreover, we performed the economic evaluation. Compared with no ECMO practice, incremental QALY was estimated to be 0.6 quality-adjusted life years (QALY) in the following 12 months and increased to 1.65 QALY when those patients were redefined according to the ECMO indications. In addition, incremental cost-effectiveness ratio (ICER) was estimated to be USD 24200 per QALY that was approximately two times of local per capita GDP.

Conclusions. Extensive ECMO utilization might be cost-effective in the COVID-19 treatment; however, it primarily depends on the patients' medical conditions. ECMO indications should be further clarified to ensure the appropriate utilization and avoid potential abuse in future practice.

Topic: Translational Medicine.

000286

Advanced hemodynamic monitoring in patients with extracorporeal membrane oxygenation: femoral vs. jugular indicator injection for transpulmonary thermodilution with PiCCO® device

S. Kopp¹, J. Windschmitt¹, T. Münzel¹, L. Hobohm¹, I. Sagoschen¹, J. Wild¹
¹Department of Cardiology, University Medical Center Mainz, Mainz, Germany

Correspondence: S. Kopp

Intensive Care Medicine Experimental 2023, **11(Suppl 1)**:000286

Introduction. The use of venovenous extracorporeal membrane oxygenation (vv-ECMO) in acute lung failure increased in Germany from 2007 to 2018 by 236 percent (825 to 2,768 cases per year) [1]. An optimized advanced hemodynamic monitoring is crucial to guide treatment. The PiCCO® system, based on transpulmonary thermodilution (TPTD), is a frequently applied method in critical care and often used for this purpose.

Objectives. Our study aimed to investigate whether the site of injection—femoral vs. jugular—influences the comparability and validity of TPTD-derived measurements with the PiCCO®-device. Although several studies on managing advanced hemodynamic monitoring in patients with extracorporeal support systems were published [2–4], this topic has not been aimed yet. Therefore, we examined the site of indicator injection in the same patient with ongoing vv-ECMO therapy.

Methods. In a retrospective analysis of patients treated with vv-ECMO, we correlated extracorporeal blood flow (ECBF) with TPTD-derived measurements from jugular or femoral injections (n=28). We analyzed the deviation of the measurements for extravascular lung water index (EVLWI), global end-diastolic volume index (GEDVI), intrathoracic blood volume (ITBVI) cardiac function index (CFI) as well as underlying mean transit time (MTt) and downslope time (DSt) depending on the current ECBF.

Results. Measurements from femoral indicator injection yielded significantly higher indexes for EVLWI (factor of 1.6, $p=0.0003$), ITBVI (factor of 2.7, $p<0.0001$), and GEDVI (factor of 2.5, $p<0.0001$), than from jugular injection. The measurements with the femoral indicator injection revealed longer calculated times for MTt and DSt. The MTt was 1.5 times ($p<0.0001$) and the DSt 1.3 times ($p=0.0031$) as long as in the corresponding measurements with jugular injection (Fig. 1). A linear correlation was found between the ECBF level and the femoro-jugular deviation (Fig. 2). The correlation between the TPTD measurements of the jugular and femoral indicator injections with the underlying ECBF of the respective measurements was investigated. For this purpose, the correlation between the cardiac index (CI) measured with the femoral indicator injection and the sum of the CI of the jugular indicator injection and the ECBF indexed to the body surface area was demonstrated ($p=0.0035$ and $R^2=0.3397$, Fig. 3).

Conclusions. Femoral indicator injection leads to overestimating the parameters compared to jugular injection due to longer MTt and DSt. A linear correlation can be shown between the CI of the different injection sites, considering the ECBF indexed to the BSA. We can therefore postulate that the level of the ECBF also contributes the overestimation of the femoral parameters. Further studies are needed to investigate the interaction of ECBF, patient's cardiac output determined by other diagnostic methods, and the temperature change due to the device itself on the results of TPTD as well as the influence of the injection site.

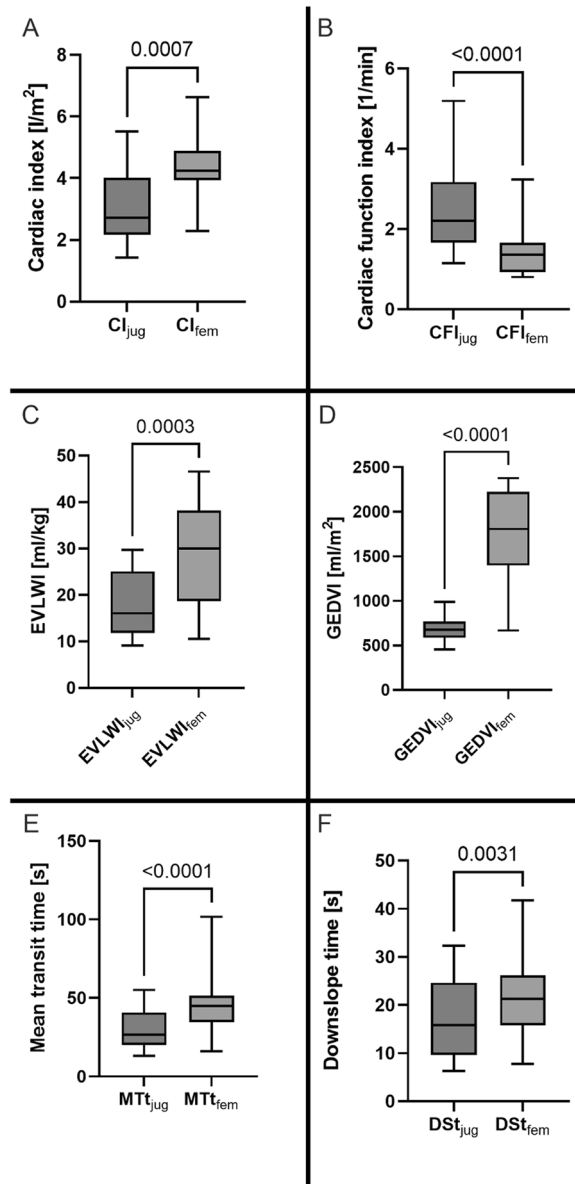

Figure 1 (abstract 000286) Comparison of TPTD-derived parameters from jugular vs. femoral indicator injection

A Cardiac index (CI, n=23), **B** Cardiac function index (CFI, n=21), **C** Extravascular lung water index (EVLWI, n=21), **D** Global end-diastolic volume index (GEDVI, n=21), **E** Mean transit time (MTt, n=20), **F** Downslope time (DSt, n=20); Paired t-tests, data are reported as mean, whiskers encompass the 95% confidence interval, p-values are shown above the brackets.

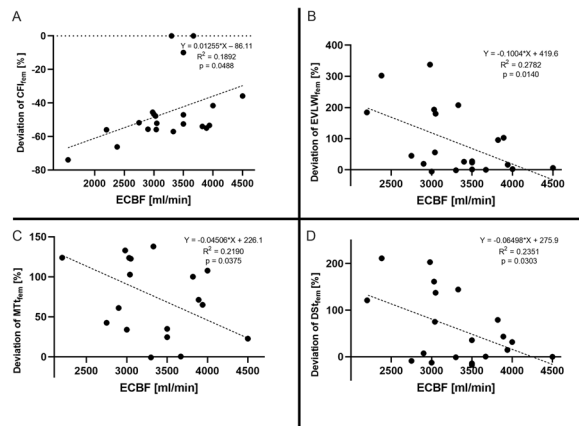

Figure 2 (abstract 000286) Simple linear regression model of the PiCCO-derived femoral deviations in percent from the PiCCO-derived jugular measurements as a function of the extracorporeal blood flow **A** Deviation of CFI (n = 21), **B** Deviation of EVLWI (n = 21), **C** Deviation of MTt (n = 20), **D** Deviation of DSt (n = 20).

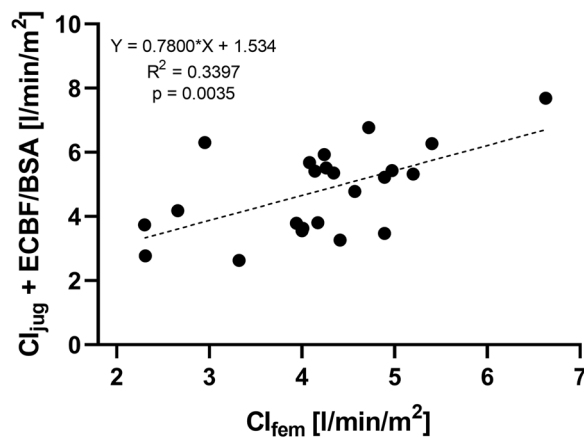

Figure 3 (abstract 000286) Simple linear regression model (n = 23) between femoral and jugular TPTD-derived cardiac index and extracorporeal blood flow indexed to bod surface area

References

- Friedrichson B, Mutlak H, Zacharowski K, Piekarski F. Insight into ECMO, mortality and ARDS: a nationwide analysis of 45,647 ECMO runs. *Critical Care*. 2021;25(1):38. <https://doi.org/10.1186/s13054-021-03463-2>.
- Herner A, Heilmaier M, Mayr U, Schmid RM, Huber W. Comparison of cardiac function index derived from femoral and jugular indicator injection for transpulmonary thermodilution with the PiCCO-device: A prospective observational study. *PLoS One*. 2018;13(7):e0200740. <https://doi.org/10.1371/journal.pone.0200740>.
- Herner A, Lahmer T, Mayr U, Rasch S, Schneider J, Schmid RM, et al. Transpulmonary thermodilution before and during veno-venous extracorporeal membrane oxygenation ECMO: an observational study on a potential loss of indicator into the extra-corporeal circuit. *J Clin Monit Comput*. 2020;34(5):923–36. <https://doi.org/10.1007/s10877-019-00398-6>.
- Minini A, Raes M, Taccone FS, Malbrain MLNG. Transpulmonary thermodilution during extracorporeal organ support (ECOS): is it worth it? A brief commentary on the effects of the extracorporeal circuit on TPTD-derived parameters. *Journal of Clinical Monitoring and Computing*. 2021;35(4):681–7. <https://doi.org/10.1007/s10877-021-00699-9>.

- Johannes Wild is supported by the German Federal Ministry for Education and Research (BMBF EDU-V24), University of Mainz ('Inneruniversitäre Forschungsförderung'), Mainz Heart Foundation and German Interdisciplinary Association for Intensive Care and Emergency Medicine ('DIVI Research Fellowship')
- This study was funded by the Boehringer Ingelheim Foundation "Novel and neglected cardiovascular risk factors: molecular mechanisms and therapeutic implications".

Topic: Acute respiratory failure and mechanical ventilation.

000287

ICP-Aid: International expert survey assessing the potential clinical impact of intracranial pressure predictions at the bedside

B. Pörteners¹, G. Carra¹, F. Guiza¹, M. Aries², G. Meyfroidt¹

¹Clinical Division and Laboratory of Intensive Care Medicine, Katholieke Universiteit Leuven, Leuven, Belgium; ²Department of Intensive Care, Maastricht UMC+, Maastricht, Netherlands

Correspondence: B. Pörteners

Intensive Care Medicine Experimental 2023, 11(Suppl 1):000287

Introduction. The introduction of artificial intelligence (AI) applications in the intensive care unit (ICU) has been scarce [1]. The vast majority of the developed AI models remain in the validation phase due to a lack of bedside testing and a lack of involvement of intensivists [1, 2]. Meanwhile, the potential impact of the use of these AI systems at the bedside remains unclear.

Objectives. The aim of this study is to gain insights into the potential clinical impact of an AI-driven decision support tool for the prediction of elevated intracranial hypertension in patients with severe traumatic brain injury (TBI). The model predicts extremely elevated intracranial pressure (ICP), defined as ICP above 30 mmHg for more than 10 min, with a forewarning of 30 min [3, 4]. Clinicians' reactions to this AI-driven tool were evaluated through a survey.

Methods. Our survey was distributed between January and March 2023 amongst the members of several international intensive care medicine societies. The target group was clinicians who regularly manage TBI patients. The survey was developed based on a literature review and in collaboration with clinical experts. The clinical response to a hypothetical AI-driven alert with an 80% probability of an event of extremely elevated ICP and a 30-min forewarning was assessed. Clinicians were asked to indicate which diagnostic or therapeutic intervention they would plan. Interventions were then grouped into Tiers according to the SIBICC guidelines [5].

Results. A total of 167 clinicians completed the survey. Most respondents were from Europe (73%), were intensivists in an ICU (89%), worked in a hospital with a specialised neuro ICU (54%) and had a protocol in place for the treatment of elevated ICP in TBI patients (60%). When presented with the hypothetical alert, 84% of respondents would plan additional diagnostic (12%) or therapeutic interventions (Tier 1 (23%), Tier 2 (35%), and Tier 3 (9%)) see Fig. 1. As shown in Fig. 2, most respondents agreed that an AI-driven decision support tool for ICP prediction in patients with TBI would help clinical staff in the treatment of TBI (83% agree, 12% neither agree nor disagree, and 5% disagree). Contrasting opinions were recorded on whether it will improve patient outcomes (51% agree, 45% neither agree nor disagree, and 4% disagree). Lastly, respondents were unsure whether there is currently enough evidence to implement such AI-driven tools in their clinical practice (19% agree, 43% neither agree nor disagree, and 38% disagree).

Conclusions. In conclusion, our survey results show that the majority of respondents would react to an AI-driven alert of intracranial hypertension in a hypothetical TBI case. Although this is a hypothetical clinical scenario that may not reflect future use at the bedside, these results show a generally open attitude from ICU clinicians toward the implementation of such an AI-driven tool in TBI patients with ICP monitoring.

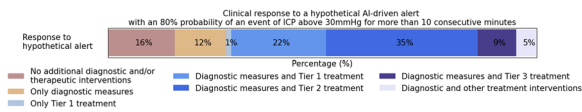

Figure 1 (abstract 000287) Clinical response of clinicians (Nresponses = 167) to a hypothetical traumatic brain injury (TBI) case. The scenario depicts a patient with isolated severe TBI with a stable intracranial pressure (ICP) (between 18–20 mmHg) and cerebral perfusion pressure (between 60–70 mmHg) for the past 24 h. The clinician is provided with a hypothetical artificial intelligence (AI) driven alert that, with an 80% probability, an event of intracranial hypertension (ICP > 30 mmHg for longer than ten consecutive minutes) will occur within 30 min. The percentage of respondents that would not act to the alert or would plan diagnostic and/or therapeutic interventions are reported in the horizontally stacked bar plot in a colour-coded way. The percentage of respondents that would take therapeutic actions were grouped in Tiers according to the SIBICC guidelines [5], also reported in colour-coded shades of blue

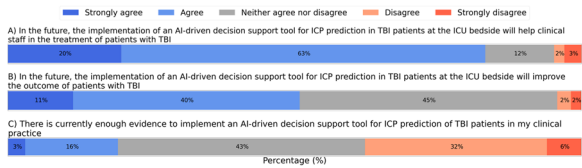

Figure 2 (abstract 000287) Clinicians' opinion on the implementation of an artificial intelligence (AI) driven decision support tool for intracranial pressure (ICP) prediction in patients with traumatic brain injury (TBI) in the intensive care unit (ICU) (Nresponses = 167). Panel A) shows the clinicians' opinion on the added benefit of AI-driven ICP predictions on the treatment of patients with TBI. Panel B) shows the clinicians' opinion on the impact of AI-driven ICP predictions on patients' outcomes. Panel C) shows the clinicians' opinion on the available evidence for the implementation of AI-driven ICP predictions in the ICU

References

- Chesnut R, Aguilera S, Buki A, Bulger E, Citerio G, Cooper DJ, et al. A management algorithm for adult patients with both brain oxygen and intracranial pressure monitoring: the Seattle International Severe Traumatic Brain Injury Consensus Conference (SIBICC). *Intensive care medicine.* 2020;46:919–29.
- Citerio G. Big Data and Artificial Intelligence for Precision Medicine in the Neuro-ICU: Bla, Bla, Bla. *Neurocritical Care.* 2022:1–3.
- van de Sande D, van Genderen ME, Huiskens J, Gommers D, van Bommel J. Moving from bytes to bedside: a systematic review on the use of artificial intelligence in the intensive care unit. *Intensive Care Med.* 2021;47(7):750–60.
- Güiza F, Depreitere B, Piper I, Van den Berghe G, Meyfroidt G. Novel methods to predict increased intracranial pressure during intensive care and long-term neurologic outcome after traumatic brain injury: development and validation in a multicenter dataset. *Critical care medicine.* 2013;41(2):554–64.
- No grants were received in the making of this work. The survey was endorsed by the European Society of Intensive Care Medicine (ESICM) and distributed by the Dutch Society of Intensive Care Medicine (NVIC) and the Belgian Society of Intensive Care Medicine (SIZ).
- Güiza F, Depreitere B, Piper I, Citerio G, Jorens PG, Maas A, et al. Early detection of increased intracranial pressure episodes in traumatic brain injury: External validation in an adult and in a pediatric cohort. *Critical care medicine.* 2017;45(3):e316–e20.

Topic: Neurointensive care.

000288

Effect of volume expansion and modification of norepinephrine infusion rate on capillary refill time in patients with septic shock

N. Fage¹, F. Moretto², D. Rosalba², R. M. Shi², C. Lai², J. L. Teboul², X. Monnet²
¹Department of Medical Intensive Care, Angers University Hospital Center, Angers, France; ²Médecine intensive—réanimation, inserm umr_s_999, fhu sepsis, groupe de recherche carmas, Bicêtre Hospital, Université Paris Saclay, Ap-HP, Le Kremlin-Bicêtre, France

Correspondence: N. Fage

Intensive Care Medicine Experimental 2023, 11(Suppl 1):000288

Introduction. The capillary refill time (CRT) is used for clinical monitoring during septic shock. However, whether CRT is influenced by macrohaemodynamic variables, such as cardiac output and vasomotor tone, is unclear, and the effects on CRT of volume expansion and norepinephrine remain uncertain.

Objectives. In septic shock patients, we investigated the determinants of the CRT and its changes during volume expansion or modification of norepinephrine infusion rate.

Methods. In patients with septic shock, cardiac index (CI, transpulmonary thermodilution), arterial pressure and five CRT measurements were recorded before and after volume expansion (500 mL saline) and before and after modification of norepinephrine infusion rate. CRT was measured in a standardized way (standardised pressure applied on the fingertip under standardized light, computer-assisted measurement of skin colour changes). Determinants of the initial value and changes of CRT (in percent change from baseline) were explored.

Results. We enrolled 69 patients with septic shock (lactate 2.7 [2.0–4.5] mmol/L, norepinephrine dose 0.43 [0.14–0.75] µg/kg/min), 33 receiving volume expansion and 36 in whom the norepinephrine dose was changed. The least significant change of CRT was 23%. In the 17 patients (51%) with fluid responsiveness (increase in CI ≥ 15% with volume expansion), CI increased from 2.34 [1.69–3.06] to 3.17 [2.28–4.03] L/min/m² (p < 0.001). Among them, CRT decreased ≥ 23% in 9 (53%) patients and changed by less than 23% in the other ones (Fig. 1A). In the 16 patients (49%) in whom CI changed < 15% with volume expansion, CRT decreased ≥ 23% in two (13%) patients and remained unchanged in the other ones (Fig. 1B). In the 28 (78%) patients in whom mean arterial pressure (MAP) increased ≥ 15% during norepinephrine changes, MAP increased from 64 (60–70) to 86 (80–103) mmHg and CRT decreased > 23% in 11 patients (Fig. 2A) and remained unchanged in the other ones (Fig. 2B).

At multivariate analysis, the absolute value of CRT at baseline was associated only with arterial lactate at baseline. Still at multivariate analysis, the fluid- and norepinephrine-induced changes in CRT were associated only with the initial value of CRT, but not with the change of the investigated macrohaemodynamic variables (CI, MAP, diastolic arterial pressure, heart rate, central venous pressure).

Conclusions. In patients with septic shock, the absolute value of CRT is related to arterial lactate but not to macrohaemodynamic variables. Fluid- and norepinephrine-induced changes of CRT are not straightforwardly associated with changes of macrohaemodynamic variables. The precision of CRT measured in a standardized way is poor.

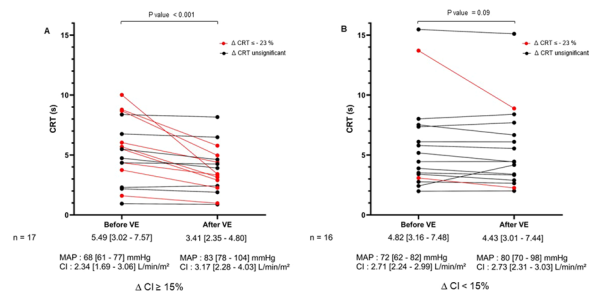

Figure 1 (abstract 000288) Evolution of capillary refill in septic shock patients with fluid responsiveness (A) and patients without fluid responsiveness (B). CI: cardiac index, CRT: capillary refill time, n = number of patients, MAP: mean arterial pressure, VE: volume expansion

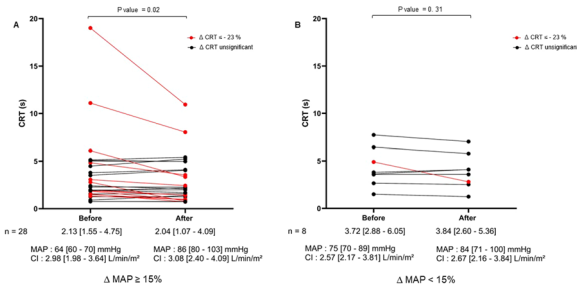

Figure 2 (abstract 000288) Evolution of the capillary refill time during modification of norepinephrine infusion rate according to the evolution of MAP: (A) increased of MAP or poor increased of MAP (B) in patients with septic shock. CRT: capillary refill time, n = number of patients, MAP: mean arterial pressure, VE: volume expansion

Topic: Cardiovascular issues in ICU.

000289

Joint latent class analysis in patients with ARDS due to Covid-19

A. Ceccato¹, C. Forne², L. Bos³, M. Camprubi⁴, E. Campaña-Duel⁴, A. Areny-Balagueró⁴, S. Quero⁵, D. Gonzalo-Calvo⁶, L. Fernandez-Barat⁷, R. Ferrer Roca⁸, J. A. Lorente⁹, A. Motos¹⁰, O. Peñuelas¹¹, J. Riera⁸, R. Menendez¹², J. F. Bermejo-Martin¹³, F. Barbé¹⁴, A. Torres¹⁰, A. Artigas¹⁵

¹Critical Care, Institut d'investigació i innovació parc tauli (i3pt)/ Hospital Universitari Sagrat Cor/ CIBERES, Barcelona, Spain; ²Department of basic medical sciences, university of lleida, Heorfy Consulting, Lleida, Spain; ³Intensive care, Academic Medical Centre, Amsterdam, Netherlands; ⁴Institut d'investigació i innovació parc tauli (i3pt), Universitat Autònoma de Barcelona, Cerdanyola del Vallès, Spain; ⁵Critical Care, Hospital Parc Taulí de Sabadell, Sabadell, Spain; ⁶Translational Research in Respiratory Medicine, IRB Barcelona—Institute for Research in Biomedicine, Barcelona, Spain; ⁷Pneumology, Hospital Clínic de Barcelona, Barcelona, Spain; ⁸Intensive care department, Vall d'Hebron University Hospital, Barcelona, Spain; ⁹Critical Care, Getafe University Hospital, Getafe, Spain; ¹⁰Servei de pneumologia, Universitat de Barcelona, Barcelona, Spain; ¹¹Intensive care medicine, Getafe University Hospital, Getafe, Spain; ¹²Pulmonology department, Hospital Universitario y Politécnico de La Fe, València, Spain; ¹³Biosepsis, Instituto de Investigación Biomédica de Salamanca, Salamanca, Spain; ¹⁴Group of traslational research in respiratory medicine. ciberes. ciberucicovid, Hospital Arnau de Vilanova and Santa Maria, IRBLleida, Lleida, Spain; ¹⁵Department of intensive care medicine, Corporación Sanitaria Universitaria Parc Tauli, Barcelona, Spain

Correspondence: A. Ceccato
Intensive Care Medicine Experimental 2023, 11(Suppl 1):000289

Introduction. Acute respiratory distress syndrome (ARDS) is a heterogeneous condition developed in patients with an acute critically-ill disease. Subphenotypes of ARDS related to baseline inflammatory status, lung morphology, and respiratory physiology have been shown to provide prognostic and predictive information (1,2). Most analyses lacked the integration of dynamic changes over time. We, therefore, aimed to identify ARDS subphenotypes using data of the first 72hs, building the longitudinal trajectories for SOFA and compliance of the respiratory system (CrS), and assessing the association with 90-day mortality.

Methods. Multicenter, observational, and prospective/retrospective study of patients admitted to 60 Spanish ICUs due to COVID-19 infection (3). We analyzed data of patients with complete clinical, physiological, and biological data on days 1 and 3. Associations between subphenotypes of early, dynamic changes in SOFA and Crs and 90-day mortality were evaluated using a multivariate joint latent class model for longitudinal and time-to-event data.

Results. Using data from 816 patients, four classes provided the best fit (Fig. 1–2). Twenty-eight percent of patients were grouped in class 1 (n = 232), 5% in class 2 (n = 37), 6% in class 3 (n = 47), and 61% in class 4 (n = 500). The highest mortality risk was observed in patients with persistent higher SOFA scores and persistently low Crs (class 1). The lowest mortality risk was observed in those patients improving SOFA scores regardless of Crs (class 4). Patients in class 4 were younger, and have fewer comorbidities. Patients in classes 2 and 3 had similar SOFA trajectories but different Crs compliance trajectories and had an intermediate risk for death. No differences in the acute phase reactants on day 1, such as CRP or ferritin, were found between classes.

Conclusions. Persistently high SOFA scores, indicative of persistent multi-organ failure drive the risk for mortality in patients with COVID-19-related ARDS. Irrespective of baseline SOFA, trajectories of resolving organ failure, with decreasing SOFA scores, are associated with the lowest mortality risk.

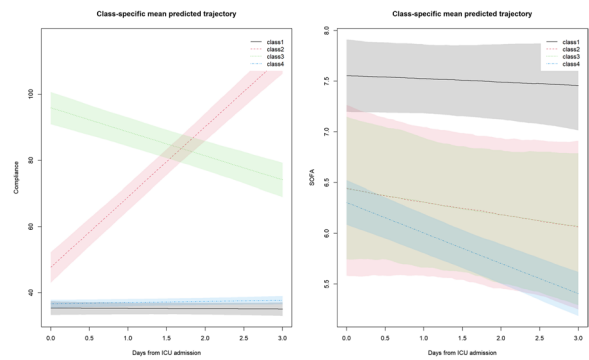

Figure 1 (abstract 000289) Class-specific mean predicted trajectory

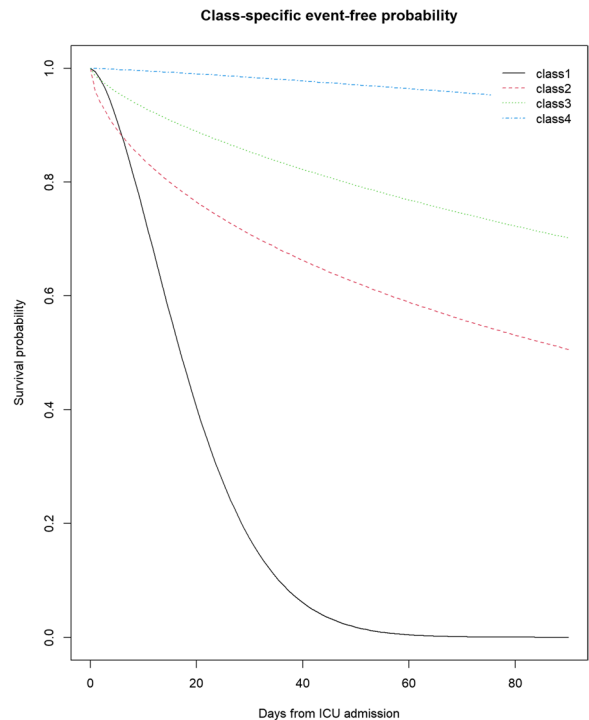

Figure 2 (abstract 000289) Survival probability according to class

References

1. ISCLL: CD21/00087, COV20/00110
2. Bos LDJ, Ware LB. Acute respiratory distress syndrome: causes, pathophysiology, and phenotypes. *Lancet*. 2022 Oct 1;400(10358):1145–56.
3. Torres A, Motos A, Ceccato A, Bermejo-Martin J, de Gonzalo-Calvo D, Pérez R, et al. Methodology of a Large Multicenter Observational Study of Patients with COVID-19 in Spanish Intensive Care Units. *Arch Bronconeumol*. 2022 Apr;58 Suppl 1:22–31
4. Calfee CS, Delucchi K, Parsons PE, Thompson BT, Ware LB, Matthay MA. Latent Class Analysis of ARDS Subphenotypes: Analysis of Data From Two Randomized Controlled Trials. *Lancet Respir Med*. 2014 Aug;2(8):611–20.

Topic: Infections and prevention.

000290

Accuracy of fluid balance estimation in critical care for COVID-19 patients

M. Masikou¹, F. Ampatzidou², C. C. Theocharidou³, M. Mpara¹, M. Gkogkou¹, Z. Kokkoni¹, C. Adamou¹
¹3rd ICU, General Hospital of Thessaloniki "George Papanikolaou", Thessaloniki, Greece; ²3rd ICU, G.Papanikolaou Hospital, Thessaloniki, Greece; ³3rd ICU, G. Papanikolaou Hospital, Thessaloniki, Greece

Correspondence: M. Masikou

Intensive Care Medicine Experimental 2023, **11(Suppl 1)**:000290

Introduction. Fluid balance can be crucial in the management of the critically ill patient, and is achieved by subtracting the recorded fluid output from input or by measuring changes in body weight. The latter can be difficult on a critically ill patient, as the input can be well known, the output, though, can be challenging to calculate, as it's affected by factors such as severity of illness, possible organ failure, etc. As hospital beds offer the ability to weigh patients in the ICU, what seems to remain unanswered is whether weight measurement is the most accurate way to monitor changes.

Objectives. The objective of this study was to investigate body weight measurements' accuracy in adult critically unwell patients who were also tested positive to COVID-19 and to assess the accuracy of conventionally recorded fluid balance charting methods to reflect any changes monitored in body weight.

Methods. This observational study was conducted at the 3rd ICU of G. Papanikolaou Hospital (Greece). During a 6 month period, (December 2022 to February 2023), 50 patients who were admitted at the unit were randomly selected to participate in the study. All participants were bed-weighed at 6 am for 2 consecutive days, in order to acquire at least 3 consecutive weight measurements. Fluid balance charts were reviewed for any calculation discrepancies. Data collected was analyzed with the use of IBM Statistics SPSS.

Results. Median value of patient age was 74 (IQR = 11) and 32 of them were male (64%). Median Apache Score was 23 (IQR = 15) and mean temperature was 36.4 oC (SD = 0.54). Documentation and calculation errors were noted and corrected at a percentage of 40%, equal to 20 out of 50 cases, ranging from -1150 ml to +3350 ml. Distribution of the adjusted fluid balance differences and body weight differences is presented in Figs. 1 and 2. We compared mean values of fluid balance and weight differences using Wilcoxon rank-sum test as we dealt with non-parametrically paired data. Fluid Balance was found to be higher when manually recorded at a mean difference of 877ml (conf. interval: 764 ml, 956 ml) with a statistical significance at $p < 0.005$. Spearman's rank correlation coefficients has also showed that an increase in Apache score may be related to higher differences between the calculated fluid balance and scale weight ($r = 0.73$). Similar positive results were noted with temperature and the needs in vasopressors and weight differences (positive correlation).

Conclusions. Fluid Balance monitoring can be time consuming and susceptible to calculating errors. Variations were observed between the calculated fluid balance by the nursing staff and the adjusted fluid balance, and also with the weight measurements on the bed scales. Assuming that body weight measurements offer a better representation of the body's fluid status, further investigation is required to establish its accuracy.

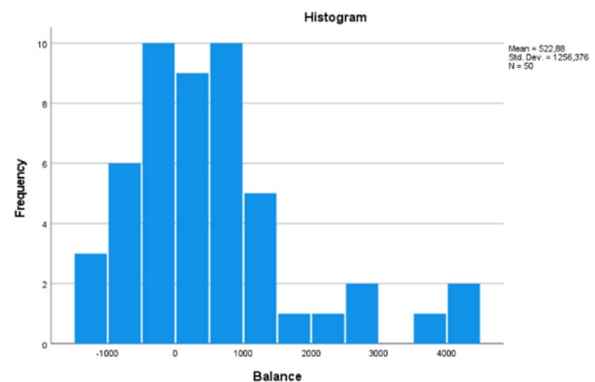

Figure 1 (abstract 000290) Distribution of the adjusted fluid balance differences

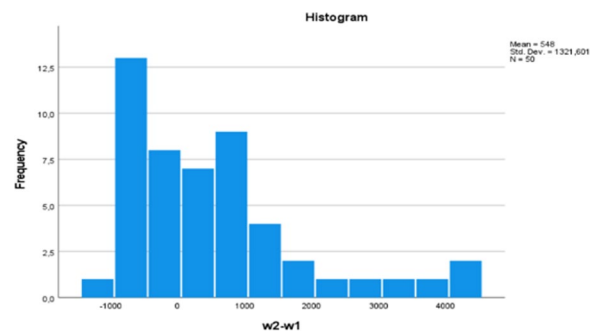

Figure 2 (abstract 000290) Distribution of body weight differences

References

1. Michelsen C. F., Svendsen M. B. S., Bagger M. L., & Konradsen H., (2022), A study on accuracy and precision of fluid volume measurements by nurses, patients and healthy persons in a clinical setting., *Nursing open*, 9(2), 1303–1310. <https://doi.org/10.1002/nop2.1173>
2. Schneider A. G., Baldwin I., Freitag E., Glassford N., & Bellomo R., (2012), Estimation of fluid status changes in critically ill patients: fluid balance chart or electronic bed weight?, *Journal of critical care*, 27(6), <https://doi.org/10.1016/j.jcrc.2011.12.017>
3. The completion of this undertaking could not have been possible without the participation and assistance of all nursing staff employed at the 3rd Intensive Care Unit of G. Papanikolaou General Hospital of Thessaloniki, Greece. Their contribution is sincerely appreciated and gratefully acknowledged

Topic: Nursing care and physiotherapy.

000291

Building a prognostic model of Covid-19 ICU mortality; an automated machine learning approach vs manual logistic regression analysis

A. Sakagianni¹, C. Koufopoulou², E. Loupelis³, V. S. Vergykios⁴, D. Kalles⁴, S. Michelidou¹, Z. Athanassa¹, V. Kaldis⁵, P. Myrianthefs⁶, Z. Rakopoulou⁷, G. Feretzakis⁴

¹Intensive Care Unit, Sismanogleio General Hospital, Marousi, Greece; ²Anaesthesiology, Aretaieion University Hospital, Athina, Greece; ³IT Department, Sismanogleio General Hospital, Marousi, Greece; ⁴School of science and technology, Hellenic Open University, Patra, Greece; ⁵Emergency department, KAT General Hospital of Attica, Kifisia, Greece;

⁶Nursing school, National and Kapodistrian University of Athens, Athens, Greece; ⁷Administration, Sismanogleio General Hospital, Marousi, Greece

Correspondence: A. Sakagianni

Intensive Care Medicine Experimental 2023, **11(Suppl 1)**:000291

Introduction. The COVID-19 infection is still recognized as a serious threat to public health and healthcare systems. Numerous predictive models have been investigated in this context to support clinical decision-making, forecast admission to the Intensive Care Unit (ICU) and final outcome.

Objectives. In this study, we evaluated an automated machine learning (ML) platform, in forecasting the mortality of critically ill COVID-19 patients in the ICU, and compared it with a binary logistic regression (LR) analysis.

Methods. We retrospectively analyzed demographics, and routine blood biomarkers from consecutive Covid-19 patients admitted to the intensive care unit (ICU) of a public tertiary hospital, during a 17-month period, in order to build a prognostic model relative to the outcome. We used the the Google Vertex AI auto ML package and compared its performance in forecasting ICU mortality, with a traditional binary LR model.

Data preprocessing

We only use the first seven measurements after admission for each monitored biomarker. In case of missing values in any of the attributes taken into consideration in this study, we replace them by calculating the average of the existing measurements that correspond to this attribute in the dataset.

Model Building

There were two classes of patients in the classification problem we had to solve: patients who were discharged alive from the ICU and patients who died. The Google Vertex AI platform was utilized for our experiments. By using AutoML, researchers can develop comprehensive and precise predictive models. Traditional ML model development is time- and resource-intensive because it takes a long time to construct and compare the performance of many models. In AutoML experiments, scaling and normalization techniques are automatically applied to all data by default. Our research paper's objective is to present a straightforward procedure that can be explained to and even used by non-technical experts, so we kept all the default parameters and avoided applying custom settings at any point. For the logistic regression analysis, we used the generalized linear model in R programming language. We trained both models using a tenfold cross-validation (CV) procedure to avoid overfitting in our analysis.

Model Evaluation

The performance metrics used to evaluate the autoML model are the Precision-Recall Area under Curve (PR AUC), the Receiver Operating Characteristic Area Under Curve (ROC AUC), the F1 score, the Log loss, the Precision, and the Recall. For the logistic regression model ROC, sensitivity and specificity, were assessed.

Results. Totally, 373 patients (140 female, 233 male) with COVID-19 pneumonia were included in the study. Among them, 102 (27.34%) died in the ICU. Non-survivors were older (mean [SD] age 70 yr [11.6 yr] vs 64.4 yr [13.5 yr]) and slightly more likely to be female (28.6% vs 26.6%). A summary of two performance metrics (ROC AUC, Sensitivity) of the AutoML and LR models is shown in Table 1, and PR curve graph in Fig. 1

Table 1 (abstract 000291) Comparison of performance metrics

	ROC AUC	SENSITIVITY
AutoML	0.955	0.906
LR	0.695	0.156

Conclusions. A growing number of disciplines now rely on ML, which has recently seen significant success. As the complexity of these tasks is frequently beyond the capabilities of non-ML experts, the demand for ready-to-use automated techniques has increased. The performance of an automated model built by Google Cloud Vertex AI package, in forecasting Covid-19 ICU mortality, surpasses the performance of a manually constructed LR statistical model. Our study highlights the empowerment given by the new techniques for fast, contextualized, feedback but also for the need for medical professionals and healthcare systems to invest in the integration of such tools.

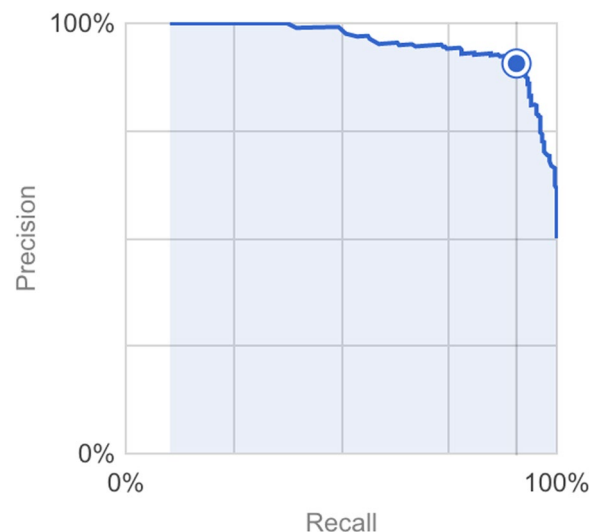

AutoML Precision-Recall curve.

References

1. <https://console.cloud.google.com> [Accessed 24th March 2023].
2. None
3. R Core Team (2020). R: A language and environment for statistical computing. R Foundation for Statistical Computing, Vienna, Austria. <http://www.r-project.org/>. [Accessed 4th March 2023].

Topic: Data Science.

000293

Development and internal validation of a prediction model for failure of high-flow nasal oxygen at initiation in patients with COVID-19

D. Sjauw¹, S. Baart², T. Janssen¹, Y. Türk³, L. Heunks¹, E. J. Wils⁴
¹Intensive Care, Erasmus University Medical Center, Rotterdam, Netherlands; ²Biostatistics, Erasmus University Medical Center, Rotterdam, Netherlands; ³Pulmonary department, Franciscus Gasthuis & Vlietland, Rotterdam, Netherlands; ⁴Intensive Care, Franciscus Gasthuis & Vlietland, Rotterdam, Netherlands

Correspondence: D. Sjauw

Intensive Care Medicine Experimental 2023, **11(Suppl 1)**:000293

Introduction. High flow nasal oxygen (HFNO) can be an effective treatment to prevent endotracheal intubation for SARS-CoV-2 positive patients suffering from hypoxemic respiratory failure (1). Timely escalation of therapy is essential, as both delayed or too early intubation

are potentially harmful (2). A model that can predict HFNO failure at HFNO initiation may thus be helpful to guide clinical decision making.

Objectives. To develop and internal validate a prediction model for HFNO failure in hospitalized hypoxemic patients with COVID-19.

Methods. Data originating from a prospective observational multi-center cohort study (NL-9067), performed from December 2020 until July 2021, was used for the development of this prediction model. Patient inclusion criteria were ≥ 18 years, with a positive SARS-CoV-2 PCR, hospitalized and who started HFNO because of hypoxemia (O2 saturation $< 92\%$ and/or breathing frequency > 30 x/min) despite oxygen therapy of at least 6 L O2 per minute. Patients were excluded if there were reasons for direct intubation, intolerance for HFNO, contraindications for HFNO and/or intubation-restrictions. The primary outcome was HFNO failure, defined as endotracheal intubation. Missing data were imputed 50 times using multiple imputation and model results were pooled after estimation. For the model estimation, a logistic regression on pre-selected variables was used, where selection was based on input from clinical experts and literature. Apparent discrimination and calibration were assessed. Internal validation to evaluate stability of the model and correct for optimism was performed using bootstrapping. A p-value of < 0.05 was considered significant.

Results. A total of 608 patients (331 not-intubated, 277 intubated) were included for this analysis. Table 1 presents variables that were statistically significant predictors of HFNO failure, as well as other used non-significant variables based on literature and clinical rationale. As preliminary performance results, the apparent model discrimination C-statistic was 0.78 [95% Confidence Interval 0.74–0.81]. The apparent calibration plot had an intercept of 0.024 and a slope of 1.028 (Fig. 1). For internal validation, bootstrapping of the dataset was performed 100 times. The optimism-corrected C-statistic was 0.761 and the calibration intercept was -0.007 with a slope of 0.906.

Table 1 (abstract 000293) Multivariable logistic regression. *denotes the variables that were statistically significant predictors for HFNO failure. FiO2 (estimated fraction of inspired oxygen) was divided into three categories (1: $> 0.21-0.40$, 2: $> 0.50-0.60$, 3: ≥ 0.66)

Variable	Odds Ratio (95% Confidence Interval)	P-value
* Age	1.021 (1.002–1.040)	0.033
Body Mass Index: Spline 1 & 2	1.086 (0.990–1.192) & 0.923 (0.817–1.043)	0.080 & 0.197
Charlson Comorbidity Index: 1 vs. 0 & 2 vs. 0	0.918 (0.590–1.428) & 0.889 (0.519–1.523)	0.704 & 0.667
* Days ill since symptom onset until HFNO initiation	0.931 (0.885–0.979)	0.005
C-reactive protein	1.000 (0.997–1.002)	0.891
Lymphocyte count	0.968 (0.869–1.079)	0.559
* Thrombocyte count	0.995 (0.993–0.997)	< 0.001
* Urea	1.053 (1.011–1.097)	0.013
* Respiratory rate before start HFNO	1.052 (1.023–1.082)	< 0.001
* O2 saturation before start HFNO	0.887 (0.841–0.936)	< 0.001
* FiO2 before start HFNO: Category 2 vs. 1 & 3 vs. 1	3.088 (1.734–5.501) & 5.362 (3.414–8.420)	< 0.001 & < 0.001

Conclusions. This novel preliminary developed model to predict HFNO failure for hospitalized hypoxemic patients with COVID-19 performed well, showing good apparent discrimination and excellent calibration. Model performance remained comparable after internal validation. Translation into clinical practice will require additional testing, such as external validation, decision curve analysis and comparison to other known prediction models.

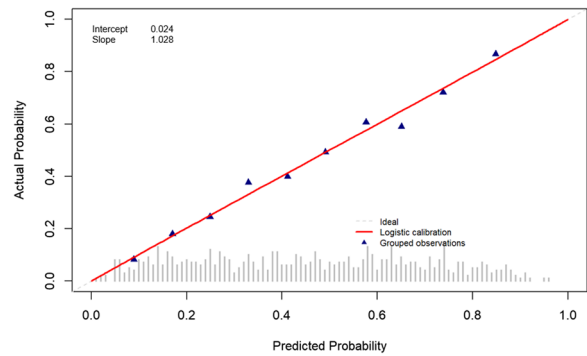

Figure 1 (abstract 000293) Apparent calibration plot

References

- Li Y, Li C, Chang W, Liu L. High-flow nasal cannula reduces intubation rate in patients with COVID-19 with acute respiratory failure: a meta-analysis and systematic review. *BMJ Open.* 2023;13(3):e067879.
- Xixi NA, Kremmydas P, Xourgia E, Giannopoulou V, Sarri K, Siempos, II. Association between timing of intubation and clinical outcomes of critically ill patients: A meta-analysis. *J Crit Care.* 2022;71:154062.

Topic: Acute respiratory failure and mechanical ventilation.

000294

Responding to patient voice: implementing a recovery clinical nurse specialist role

Z. van Willigen¹

¹Therapy Services, University Hospital Southampton, Southampton, United Kingdom

Correspondence: Z. van Willigen

Intensive Care Medicine Experimental 2023, **11(Suppl 1)**:000294

Introduction. Post Intensive Care Syndrome (PICS) encompasses the complex range of impairments (physical, cognitive and psychosocial) that can affect the recovery of survivors of intensive care (ICU) for months or even years after hospital discharge (1).

Funding for intensive care recovery services are widely reported as inadequate (2). In 2021 we won a Q community award and initially used part of this funding to deliver rehabilitation classes (EMPOWER) for survivors of critical illness in our own trust.

While we saw positive outcomes for patients who attended the classes (results published elsewhere), there was a climate of opinion from participants that much of the education and expectations around recovery after critical illness could have been addressed much earlier, while the patients were still in hospital (Fig. 1).

Objectives. So, in direct response our patients’ voice, we decided to use the remaining fund to pilot an ICU Recovery Clinical Nurse Specialist (CNS) role for 6 months. The main objectives of this role were:

- Collect length of stay data to evaluate if role could reduce bed days.
- Assess and map the needs of our patients after ICU admission
- Provide step-down ward multi-disciplinary team (MDT) education

Methods. Development of Recovery CNS Role

15 h a week were funded for an experienced ICU nurse to be seconded into the CNS role. The CNS integrated with ward MDTs and supported them to care for patients with a range of PICS symptoms. Patients were enabled to better engage with therapy teams. An information pack was created and given to patients. Basic psychological grounding-techniques were used along with reassurance and explanations about their ICU admission. By exploring predicted recovery trajectories, patients and families a realistic measure of what to expect and prepare for post-discharge.

Data collection. Patients ventilated for >48h on ICU were visited on the ward by the CNS after ICU discharge. Mean and median length of stay (LOS), PICUPS (Post Intensive Care Unit Presentation Screen) and IPAT (Intensive Care Psychological Assessment Tool) data were collected.

Results. 46 patients were visited by the recovery CNS at least once. Of the 46, 21 were surgical patients and these were chosen for comparison due to the availability of baseline data. The results are presented in Table 1.

40 patients completed an IPAT score. Our data demonstrates that there is no correlation between number of days on ICU and psychological risk in our patient group: 65% were screened as being 'at risk' (Fig. 2). The PICUPS (0 = greatest dependency and 5 = least dependency) was completed for 45 of the patients visited. The scores are also shown in Fig. 2 and show that for our group the highest dependency was for medical stability and nutritional needs.

Figure 3 describes a scenario where ward staff were not adequately trained in caring for a patient after an ICU admission. The visit by the CNS addressed these training needs.

Table 1 (abstract 000294) .

	No of Patients	Mean LOS	Median LOS
Baseline Nov 21—April 22	39	24	13
CNS Visits Nov 22—April 23	21	10.2	7

Conclusions. A recovery CNS role can reduce ward length of stay after an ICU admission. Additionally, it meets national recommendations, provides valuable education to ward teams and improves patient and family experience following critical illness. The role of the CNS in collecting data to map the needs of our patients provides vital information to prioritise limited resources to those most at risk of PICS.

"...it is not as simple as admitting to ICU, treating, saving, reacting to the immediate threat to life. By doing so you give yourselves a responsibility for what comes next...

...I went to sleep, and woke up a long time later with a different body, with different needs and abilities...

...There is a requirement for specialist care, for a joined up and holistic treatment programme, for ongoing access to services to support physical and mental recovery. This should be an integral part of Intensive Care Treatment, it should not be an add-on...

...This care and treatment plan should be in place during step down in hospital and long after discharge home and it should be overseen and facilitated by an experienced practitioner who has a thorough understanding of all the complicated facets of ICU recovery."

Figure 1 (abstract 000294) .

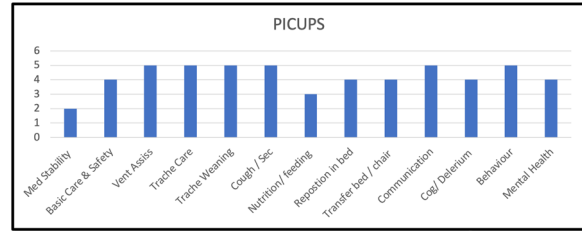
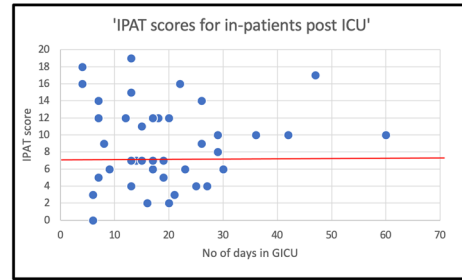

Figure 2 (abstract 000294) .

Tracheostomy-site dressing left unassessed

On visiting a long-term ICU patient on a ward, the CNS found him close to discharge but with a trache-site dressing on that had not been changed or reviewed for days. Many of the ward nurses had never cared for tracheostomy wounds. The CNS was able to support the ward staff to re-dress it and reassured the patient that all looked good. The sutures were due for removal the following day but this information was lost within ICU notes and not communicated. Informed staff and avoided the patient going home with them still in-situ.

2 weeks later at home, the patient had concerns about the wound. The wife was able to contact the CNS and send images which were identified as over-granulation. The patient was referred to the tracheostomy practitioners who cauterised with silver nitrate. This avoided GP / practice nurse visits, allowed timely treatment of the over-granulation, and provided instant reassurance to patient and his wife.

Figure 3 (abstract 000294) .

References

- Herridge MS, Tansey CM, Matte A, et al. Functional disability 5 years after acute respiratory distress syndrome. *N Engl J Med* 2011;364(14):1293–304.
- Connolly B, Milton-Cole R, Adams C, et al. Recovery, rehabilitation and follow-up services following critical illness: an updated UK national cross-sectional survey and progress report. *BMJ Open* 2021;11(10):e052214.

Topic: Nursing care and physiotherapy.

000295

Diaphragm neurostimulation results in a lower hippocampal concentration of granulocyte-monocyte colony-stimulating factor in moderate-ARDS pigs ventilated for 12 h

T. Bassi¹, E. Rohrs², F. Karl³, M. Ornowska³, W. Jessica³, M. Nicholas³, M. Gani¹, E. Doug¹, S. Reynolds²

¹Research and development, Lungpacer Medical USA Inc., Exton, United States of America; ²Critical care, Advancing Innovation in Medicine

Institute, New Westminster, Canada; ³Critical care, Fraser Healthy Authority, New Westminster, Canada

Correspondence: T. Bassi

Intensive Care Medicine Experimental 2023, **11(Suppl 1)**:000295

Introduction. Studies have associated mechanical ventilation (MV) and acute respiratory distress syndrome (ARDS) with neuroinflammation.1–3 Neuroinflammation might be triggered by inflammatory proteins crossing over the blood–brain barrier (BBB), or by inflammatory proteins released by microglia cells 3,4. Hippocampal neuronal overactivation has been linked to an increased release of inflammatory proteins during MV.5,6 Granulocyte-monocyte colony-stimulating factor (GM-CSF) is a protein that regulates and controls inflammation.7 Also, GM-CSF can freely cross over the BBB.7 S100b is often used as a surrogate marker for BBB leakage or dysfunction 8,9. Diaphragm neurostimulation has been shown to mitigate neuroinflammation in pre-clinical models 2,3.

Objectives. This study focused on investigating whether diaphragm neurostimulation in association with MV would result in different tissue and serum concentrations of GM-CSF compared to the MV alone.

Methods. Juvenile pigs (4–5 months, 50–87 kg) underwent protective MV (volume control, PEEP 5 cmH₂O, tidal volume 8 ml/kg) for 12 h, with moderate ARDS (PaO₂/FIO₂ between 100 and 200). ARDS was induced by injecting oleic acid into the pulmonary artery. Subjects were assigned to three groups (n=6 per group): lung injury with MV only (MV), lung injury with MV and with TTDN every other breath (MV+TTDN50%), and lung injury with MV and with TTDN every breath (MV+TTDN100%). Diaphragm neurostimulation was delivered according to methods published previously. After the study, the hippocampus was harvested, homogenized and marked with an enzyme-linked immunoassay (ELISA) to measure the GM-CSF tissue concentration. Blood samples were also collected to measure the serum concentration of GM-CSF and S100b at the study end. The Kruskal–Wallis test was used for statistical analyses. Data expressed as the median interquartile range in pg/ml. P-values < 0.05 are considered statistically significant.

Results. GM-CSF concentrations in the hippocampus and in the serum were respectively 15 (9–28) and 0 (0–7), and for the MV group, 16 (10–20) and 0 (0–86) for the MV+50%TTDN group, and 2 (0–8) and 12 (5–23) and for the MV+TTDN100% group, with p<0.0001 and p=0.0475 (see Table). S100b serum concentrations were respectively, 256 (158–430) for the MV group, 160 (155–342) for the MV+TTDN50% group, and 215 (210–398) for the MV+TTDN100% group, p=0.4512.

Conclusions. In a preclinical model, 12 h of moderate ARDS leads to greater hippocampal concentration of GM-CSF and lower serum concentration of GM-CSF compared to the MV+TTDN100% group. The difference between hippocampal and serum concentrations of GM-CSF might provide a clue about the neuroprotective effect of diaphragm neurostimulation, and about how neuroinflammation is triggered in this preclinical moderate ARDS model. S100b serum concentrations are not significantly different between the groups indicating that all groups had similar BBB functions at study end.

Markers (end of study)	Concentration (pg/ml)			p-value (Kruskal-Wallis test)	p-value (Dunn's multiple comparison test)						
	Median (IQR)										
	MV (n=6)	MV+TTDN50% (n=6)	MV+TTDN100% (n=6)								
GM-CSF Hippocampus	15 (9-28)	16 (10-20)	2 (0-8)	<0.0001	<table border="0"> <tr><td>MV vs MV+TTDN50%</td><td>ns</td></tr> <tr><td>MV vs MV+TTDN100%</td><td>0.0199</td></tr> <tr><td>MV+TTDN50% vs MV+TTDN100%</td><td>0.0375</td></tr> </table>	MV vs MV+TTDN50%	ns	MV vs MV+TTDN100%	0.0199	MV+TTDN50% vs MV+TTDN100%	0.0375
MV vs MV+TTDN50%	ns										
MV vs MV+TTDN100%	0.0199										
MV+TTDN50% vs MV+TTDN100%	0.0375										
GM-CSF Serum	0.0 (0-7)	0 (0-86)	12 (5-23)	0.0475	<table border="0"> <tr><td>MV vs MV+TTDN50%</td><td>ns</td></tr> <tr><td>MV vs MV+TTDN100%</td><td>0.0479</td></tr> <tr><td>MV+TTDN50% vs MV+TTDN100%</td><td>ns</td></tr> </table>	MV vs MV+TTDN50%	ns	MV vs MV+TTDN100%	0.0479	MV+TTDN50% vs MV+TTDN100%	ns
MV vs MV+TTDN50%	ns										
MV vs MV+TTDN100%	0.0479										
MV+TTDN50% vs MV+TTDN100%	ns										
S100β Serum	256 (158-431)	160 (155-342)	215 (210-398)	0.4512	n/a						

References

1. Bassi T, Rohrs E, Reynolds S. Systematic review on brain injury after mechanical ventilation. *Crit Care*. Published online 2021.

2. Bassi T, Rohrs E, Fernandez K, et al. Transvenous diaphragm neurostimulation mitigates ventilation-associated brain injury. *Am J Respir Crit Care Med*. Published online 2021.

3. Bassi T, Rohrs E, Fernandez K, et al. Diaphragm Neurostimulation Mitigates Ventilation-Associated Brain Injury in a Preclinical Acute Respiratory Distress Model. *Crit Care Explor*. 2022;4(12). <https://doi.org/10.1097/CCE.0000000000000820>

4. Giordano G, Pugliese F, Bilotta F. Neuroinflammation, neuronal damage or cognitive impairment associated with mechanical ventilation: A systematic review of evidence from animal studies. *J Crit Care*. 2021;62:246–255. <https://doi.org/10.1016/j.jcrrc.2020.12.017>

5. González-López A, López-Alonso I, Pickerodt PA, et al. Lung Purinoceptor Activation Triggers Ventilator-Induced Brain Injury. *Crit Care Med*. 2019;47(11):e911–e918. <https://doi.org/10.1097/CCM.0000000000003977>

6. Chen C, Zhang Z, Chen T, Peng M, Xu X, Wang Y. Prolonged mechanical ventilation-induced neuroinflammation affects postoperative memory dysfunction in surgical mice. *Crit Care*. 2015;19(1):1–12. <https://doi.org/10.1186/s13054-015-0882-0>

7. Kiyota T, Machhi J, Lu Y, et al. Granulocyte–macrophage colony-stimulating factor neuroprotective activities in Alzheimer’s disease mice. *J Neuroimmunol*. 2018;319:80–92. <https://doi.org/10.1016/j.jneuroim.2018.03.009>

8. Michetti F, Corvino V, Geloso MC, et al. The S100B protein in biological fluids: More than a lifelong biomarker of brain distress. *J Neurochem*. 2012;120(5):644–659. <https://doi.org/10.1111/j.1471-4159.2011.07612.x>

9. Ercole A, Thelin EP, Holst A, Bellander BM, Nelson DW. Kinetic modelling of serum S100b after traumatic brain injury. *BMC Neurol*. 2016;16(1):1–8. <https://doi.org/10.1186/s12883-016-0614-3>

10. MITACS

11. TB VETS

12. Lungpacer Medical Inc

Topic: Acute respiratory failure and mechanical ventilation.

000296

Greater serum concentration of S100β at hospital admission is associated with increased risk of developing delirium during hospitalization

T. Bassi¹, E. Rohrs², M. Nicholas³, S. Reynolds²

¹Research, Lungpacer Medical Inc., Vancouver, Canada; ²Critical care, Advancing Innovation in Medicine Institute, New Westminster, Canada;

³Critical care, Fraser Healthy Authority, New Westminster, Canada

Correspondence: T. Bassi

Intensive Care Medicine Experimental 2023, **11(Suppl 1)**:000296

Introduction. Hospitalized patients often develop delirium during hospitalization 1,2. Blood–brain barrier (BBB) dysfunction has been associated with an increased risk of developing delirium during hospitalization 3,4. S100b is a biomarker that has been associated with BBB leakage and dysfunction. The focus of our study was to investigate existing literature to determine whether, at hospital admission, serum concentration of a biomarker for BBB dysfunction, S100b, was associated with the likelihood of developing delirium during hospitalization.

Objectives. We conducted a systematic review and meta-analysis to investigate whether, at hospital admission, serum concentration of a biomarker for BBB dysfunction, S100b, was associated with the likelihood of developing delirium during hospitalization.

Methods. Our meta-analysis followed the Preferred Reporting Items for Systematic Review and Meta-Analysis (PRISMA) protocol. Independent extraction with multiple reviewers’ consensus was used to determine the studies included. The weight and heterogeneity of the manuscripts were calculated using inverse covariance with a random-effects model. The inclusion criteria were articles in English that investigated links between serum concentration of S100b at hospital admission and delirium during hospitalization. Exclusion criteria were single case reports, case series, comments, editorials, letters to the editor, articles that were clearly not relevant to the review objective, and articles concerning pediatrics.

Results. After excluding duplicates, twelve studies that investigated the role of S100b serum concentration at hospital admission were

included. Our search found evidence that patients who developed delirium during hospitalization had, at hospital admission, a mean serum concentration of S100b significantly greater than patients who did not develop delirium during hospitalization. The mean difference in S100b serum concentration was independent of other confounding variables such as the patient's severity of illness. The mean difference in serum concentration of S100b at hospital admission between patients who developed delirium and those who did not was 0.07 ng/ml, $p < 0.00001$ for Chi-square, I² of 96%, and $p < 0.00001$ for the total overall effect (Figure A). A subgroup analysis that included exclusively post-orthopedic surgical patients showed no heterogeneity between the papers and a mean difference in serum concentration of S100b at hospital admission between patients who developed delirium and those who did not was 0.04 ng/ml, $p = 0.76$ for Chi-square, I² of 0%, and $p < 0.00001$ for the total overall effect (Figure B).

Conclusions. Our findings indicate that a greater serum concentration of S100b at hospital admission is associated with an increased risk of developing delirium during hospitalization.

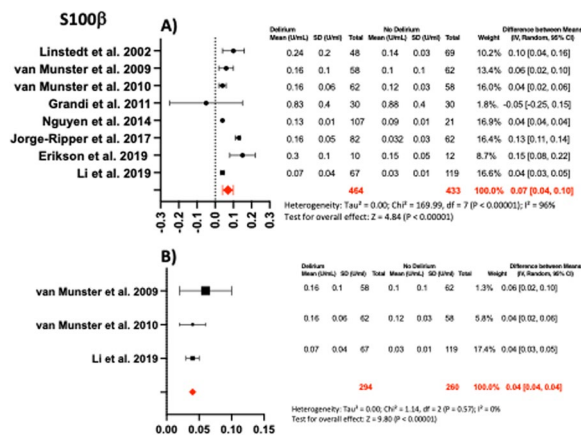

References

1. Bassi T, Rohrs E, Reynolds S. Systematic review on brain injury after mechanical ventilation. Crit Care. Published online 2021.
2. Girard TD, Ware LB, Bernard GR, et al. Associations of markers of inflammation and coagulation with delirium during critical illness. Intensive Care Med. 2012;38(12):1965–1973. <https://doi.org/10.1007/s00134-012-2678-x>
3. Koh SXT, Lee JKW. S100B as a marker for brain damage and blood–brain barrier disruption following exercise. Sports Medicine. 2014;44(3):369–385. <https://doi.org/10.1007/s40279-013-0119-9>
4. Fan S, Wang H, Yin J. Increase of plasma S100B level in patients with moderate and severe traumatic brain injury. Int J Clin Exp Pathol. 2016;9(11):12130–12135.
5. Lungpacer Medical Inc.

Topic: Neurointensive care.

000297

Family burden after critical illness: lets not forget the caregivers!

J. Tejero Aranguren¹, M. E. Poyatos Aguilera², M. T. Cruces Moreno², M. Colmenero Ruiz²

¹Intensive Care Unit, Faculty of Medicine–University of Granada, Granada, Spain; ²Intensive Care Unit, Hospital Universitario San Cecilio, Granada, Spain

Correspondence: J. Tejero Aranguren
Intensive Care Medicine Experimental 2023, 11(Suppl 1):000297

Introduction. It is increasingly recognized that the consequences of critical illness also place considerable strain on the families of ICU survivors, who often bear the burden of high levels of informal care. The term Post-Critical Care Family Syndrome (PICS-F) is considered to be

the family member's response to the stress caused by the ICU admission of a loved one. Between 1 in 4 and 1 in 2 patients who survive ICU admission will need family support for care.

Objectives. To identify patient and caregiver risk factors for caregiver burden in the setting of critical care.

Methods. Prospective observational cohort study, from 2019 to 2021. Setting: ICU of a university hospital with 20 beds and an average of 1200 admissions per year.

Sample: Primary caregiver of patients with risk factors for development of PICS, i.e. admission > one week and also at least one of the following: 3 > days of mechanical ventilation, delirium or shock during admission. Follow-up protocol: Assessment 3 months after discharge from the ICU in consultation. The scales used in the patients were Barthel, SF-12, HADS, IES-6 and in the relatives Apgar and Zarit. The questionnaires were administered by two of the investigators, each of whom had demonstrated competence in the completion of the questionnaires after a mock interview with the principal investigator.

PICS-F was considered to be the presence of caregiver overload with a Zarit test score > 46. PICS definition: PICS was considered to be the appearance of alterations in any of the three spheres. Impairment in physical sphere was defined as deterioration in one category on the Barthel dependency scale with respect to admission to the ICU; impairment in cognitive sphere a score of more than 3 points on the Pfeiffer test; and impairment in mental health sphere a score of more than 11 on the HADS test and/or 1.75 on the IES-6 score for post-traumatic stress.

Statistical analysis: As this was a descriptive study and with the aim of generating working hypotheses, the sample size is that of the number of patients included. Univariate analysis was performed using binary logistic regression and odds ratio (OR) estimation. Differences with a $p < 0.05$ were considered statistically significant. Data were anonymised for analysis. R software version 4.0.3 (R Foundation for Statistical Computing Platform, Vienna, Austria) r-commander 2.6–2 package was used. Ethical considerations: The project was approved by the centre's Research Ethics Committee and consent to participate was requested from patients and relatives.

Results. A total of 93 patients were included in the follow up. 15 relatives did not complete the follow-up questionnaires and have been excluded from the study. The incidence of SPCI-F defined by the presence of primary caregiver overload in our cohort of patients is 34.6% (n = 27), with a 95% CI of 25–45.7.

The incidence of PICS-F as defined by the presence of primary caregiver overload in our cohort of patients is 32.9%. Patient risk factors during ICU admission associated with the presence of PICS-F are days of mechanical ventilation (IC 1.01–1.06, $p < 0.008$), sedation (IC 0.99–1.10, $p < 0.06$), ICU admission (IC 1.01–1.05, $p < 0.01$) and hospital stay (IC 1.01–1.03, $p < 0.03$); in the follow-up consultation the risk factor is the presence of PICS-F in the patient in any of the 3 spheres. We did not identify in our sample family member risk factors for the development of PICS-F.

Conclusions. One in 3 family members of patients with risk factors for the development of PICS have caregiver overload at 3 months. The presence of physical deterioration, anxiety or post-traumatic stress in the patient is related to primary caregiver overload. The identification of patients with risk factors for the development of PICS during their stay in the ICU as well as the presence of PICS in the follow-up consultation should raise the alarm that the family member should also be assessed and provided with the corresponding therapeutic assistance.

References

1. Herridge MS, Tansey CM, MattéA, Tomlinson G, Diaz-Granados N, Cooper A, Guest CB, Mazer CD, Mehta S, Stewart TE, Kudlow P, Cook DJ, Slutsky AS, Cheung AM, Canadian Critical Care Trials Group. Functional disability 5 years after acute respiratory distress syndrome. N Engl J Med. 2011;364(14):1293.
2. Davidson JE, Jones C, Bienvenu OJ. Family response to critical illness: postintensive care syndrome-family. Crit Care Med. 2012 Feb;40(2):618–24.
3. Needham DM, Davidson J, Cohen H, Hopkins RO, Weinert C, Wunsch H et al. Improving long-term outcomes after discharge from intensive

care unit: report from a stakeholders' conference. Crit Care Med. 2012 Feb;40(2):502–9.

- Azoulay E, Resche-Rigon M, Megarbane B, Reuter D, Labbé V, Cariou A et al. Association of COVID-19 Acute Respiratory Distress Syndrome With Symptoms of Posttraumatic Stress Disorder in Family Members After ICU Discharge. JAMA. 2022 Mar 15;327(11):1042–1050.
- Tejero-Aranguren J, García del Moral Martín R, Poyatos-Aguilera ME, Morales-Galindo I, Cobos-Vargas A, Colmenero M. Incidence and risk factors for postintensive care syndrome in a cohort of critically ill patients. Rev Bras Ter Intensiva. 2022;34: 380–5.

Topic: Critical care organisation, quality management, information systems, outcomes.

000298

Improving the iNTEGRation between pRimary And iNtensive care after critical illness (INTEGRATE) study

N. Leggett¹, K. Emery², T. Rollinson³, A. Deane¹, C. French⁴, G. Eastwood⁵, M. Merolli⁶, B. Miles⁷, R. Bellomo⁵, J. A. Manski-Nankervis⁸, Y. Ali Abdelhamid¹, K. Haines¹

¹Department of Critical Care, University of Melbourne, Parkville, Australia;

²Department of Physiotherapy, Western Health, St Albans, Australia;

³Department of Physiotherapy, Austin Hospital, Heidelberg, Australia;

⁴Intensive Care Department, Western Health, St Albans, Australia;

⁵Intensive care unit, Austin Hospital, Heidelberg, Australia; ⁶Department of Physiotherapy, University of Melbourne, Parkville, Australia; ⁷Intensive Care Department, The Royal Melbourne Hospital, Parkville, Australia;

⁸Department of General Practice, University of Melbourne, Parkville, Australia

Correspondence: N. Leggett
Intensive Care Medicine Experimental 2023, 11(Suppl 1):000298

Introduction. Critical care survivors experience multiple care transitions (1, 2). Internationally, there is limited specialised Intensive Care Unit (ICU) follow-up service data for these patients (3). Given the relative ubiquitous nature of primary care, general practitioners (GPs) are ideally positioned to provide support post-hospital, however are rarely included in post-ICU care research (3).

Objectives. To identify unmet care needs and solutions to improve the coordination and integration of care following an ICU admission—from the perspective of patients, their caregivers, intensivists, and GPs.

Methods. Qualitative study using the Framework Analysis Method, reported using the COREQ (4) checklist. Participants were ICU patients, their caregivers and intensivists, recruited from three academic hospitals; and GPs, recruited from a state-wide, academic-affiliated network. Purposive sampling was used to achieve socio-economic diversity (using the Australian Bureau of Statistics Index for Relative Socioeconomic Advantage and Disadvantage), and differing survivorship experiences. Individual semi-structured interviews were completed, and patient demographic information was collected from medical records. Qualitative data were audio-recorded, transcribed, and coded independently by two experienced researchers to synthesise and generate themes.

Results. Forty-six interviews (15 patients, 8 caregivers, 15 intensivists, and 8 GPs) were conducted between 6 and 12 months post ICU discharge. The majority of patients were originally admitted to ICU for cardiac or respiratory failure, or COVID-19 diagnoses, and received mechanical ventilation.

Within these feedback loops, eight major themes were identified and categorised. *Feedback loop 1:* Increased linkages and collaboration between ICU and GP, ICU and GP clinician education on screening for post ICU issues and the role of ICU respectively. *Feedback loop 2:* Improved survivorship focussed communication from ICU to GP utilising digital health, Role of allied health to support across the recovery care arc, Patient information portal; and *Feedback loop 3:* Comprehensive post-ICU care pathway model akin to existing cancer pathways, Improved awareness and accessibility to community support including virtual rehabilitation, and the Role of ICU follow-up for clinician morale and contribution to ICU care through awareness of critical care outcomes.

A conceptual model (Fig. 1) was identified as foci for research and service improvement initiatives: Feedback loop 1: Between GP and ICU; Feedback loop 2: ICU to GP; and Feedback loop 3: ICU follow-up programs back to the ICU.

Conclusions. Eight major themes to improve enhanced recovery support for critical care survivors within existing healthcare system structures by leveraging existing resources and expertise were identified. Our data highlights the importance of comprehensive communication, active relationships between primary and intensive care clinicians, and the value of allied health in managing this cohort. These themes are mapped to a novel conceptual model that includes key feedback loops for health system improvements and foci for future interventional trials to improve ICU survivorship outcomes.

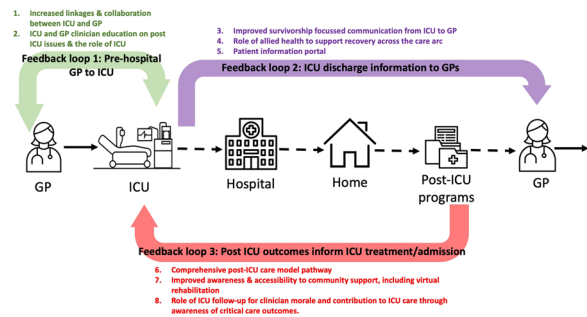

References

- 4 Tong et al. 2007 Int J Qual Health Care
- 3Admon et al. 2019 Lancet Respiratory Medicine
- 2Needham et al. 2012 CCM
- 1Mikkelsen et al. 2020 CCM

Topic: Critical care organisation, quality management, information systems, outcomes.

000299

Trends of neuro-intensive care unit admission in South Korea: a nationwide population-based cohort study

S. Kim¹, T. K. Oh², S. In-Ae², Y. T. Jeon²

¹Critical Care Medicine, Seoul National University Bundang Hospital, Seongnam-si, Republic of Korea; ²Department of Anesthesiology and Pain Medicine, Seoul National University Bundang Hospital, 성남 시, Republic of Korea

Correspondence: S. Kim

Intensive Care Medicine Experimental 2023, 11(Suppl 1):000299

Introduction. Clinical outcomes of critically ill neuroscience patients are better when treated in the neurointensive care unit (NCU). To plan how to allocate the limited resources and specialty-trained workforce of the NCU, it is important to explore the recent trends of NCU admissions and prioritize the patients in the most need.

Objectives. To study nationwide trends in NCU admissions and identify risk factors for in-hospital mortality in NCU patients.

Methods. This nationwide population-based retrospective cohort study enrolled adult patients admitted to the NCU from 2010 to 2019 extracted from The National Health Insurance Service. The primary outcome was the trends of NCU admissions, mean age, and the mean total medical expense per patient. Multivariable logistic regression models were used to identify risk factors related to in-hospital mortality among NCU patients.

Results. A total of 845,474 admissions of 679,376 patients were identified. During the 10-year period, the mean age and total cost of hospitalization per patient admitted to the NCU gradually increased. The most common diagnosis in the NCU was cerebrovascular disease (55.7%), followed by intracranial injury (16.5%), benign

neuroendocrine tumor (3.6%), and epilepsy or seizure (3.1%). Risk factors strongly associated with in-hospital mortality were the usage of mechanical ventilator (adjusted odds ratio [aOR]:19.83, 95% confidence interval [CI]: 19.42–20.26; $P < 0.001$), extracorporeal membrane oxygenation (aOR: 3.49, 95% CI: 2.42–5.02; $P < 0.001$), and continuous renal replacement therapy (aOR: 6.47, 95% CI: 6.02–6.96; $P < 0.001$).

Conclusions. Patients admitted to the ER, registered in the neurosurgery department, in need of aiding equipment, and diagnosed with malignancy are potential risk factors for in-hospital mortality. Patients with supporting equipment and cancer diagnosis require greater attention among NCU patients.

Topic: Neurointensive care.

000302

Megadose intravenous sodium ascorbate has widespread benefit in experimental and human septic shock

C. N. May¹, R. Bellomo², F. Yanase², Y. Lankadeva¹

¹Preclinical Critical Care Unit, The Florey Institute of Neuroscience and Mental Health, Parkville, Australia; ²Intensive Care, Austin Hospital, Heidelberg, Australia

Correspondence: C.N. May

Intensive Care Medicine Experimental 2023, **11(Suppl 1)**:000302

Introduction. High doses of intravenous vitamin C (ascorbic acid) have mild variable effects in experimental and human sepsis. Megadoses of intravenous vitamin C (110 g+) have been given to cancer patients without side-effects but have not been used in critically ill patients. We have shown in an ovine model of septic shock, with a similar phenotype to human sepsis, that intravenous megadose sodium ascorbate (a pH balanced formulation of the sodium salt of vitamin C) reversed sepsis-induced vasoplegia, improved vital organ function and restored a normal clinical state (1).

Objectives. (1) To determine the effect of intravenous sodium ascorbate (3.75 g/kg) on brain tissue perfusion, oxygenation, and temperature, and plasma levels of inflammatory biomarkers and ascorbate in ovine septic shock. (2) To assess the safety and physiological responses to intravenous sodium ascorbate (60 g/day) in patients with septic shock in a Phase 1a randomised controlled trial [ACTRN12620000651987p].

Methods. (1) Sepsis was induced in non-anesthetised adult Merino ewes ($n=8$) by intravenous infusion of live *Escherichia coli* obtained from a septic patient. After 23-h, fluid resuscitation was started (30 mL/kg), followed by intravenous megadose sodium ascorbate (0.5 g/kg over 30-min + 0.5 g/kg/h for 6.5-h) or fluid-matched placebo ($n=6$ /group). Noradrenaline was titrated to restore mean arterial pressure to 70–80 mmHg. (2) Patients with septic shock were randomised to receive either intravenous sodium ascorbate (30 g over 1-h, $n=15$) followed by 30 g over 5-h, or fluid-matched placebo ($n=15$).

Results. (1) At 23-h of ovine septic shock, mean arterial pressure (MAP; 85 ± 2 to 64 ± 2 mmHg; mean \pm SE), plasma ascorbate (27 ± 2 to 15 ± 1 μ mol/L) and urine flow decreased (1.2 ± 0.4 to 0.3 ± 0.1 mL/kg/h) (all $P < 0.01$). Cerebral tissue ischemia (901 ± 58 to 396 ± 40 units), hypoxia (34 ± 1 to 19 ± 3 mmHg) and hyperthermia (39.5 ± 0.1 to 40.8 ± 0.1 °C (all $P < 0.001$) developed, accompanied by malaise, lethargy, and somnolence. Sodium ascorbate rapidly restored MAP while noradrenaline was withdrawn, and urine flow increased (11.4 ± 2.6 mL/kg/h). Cerebral tissue perfusion (703 ± 121 units), and oxygenation (30 ± 2 mmHg) improved and temperature decreased (39.2 ± 0.1 °C) (all $P_{\text{Treatment}} < 0.05$), which was associated with restoration to a normal healthy behavioural state. Sodium ascorbate reduced the sepsis-induced increase in plasma interleukin-6 ($P_{\text{Group} \times \text{Time}} = 0.003$) and increased the plasma level of ascorbate (to $20,000 \pm 300$ μ mol/L; $P_{\text{Group}} < 0.001$). (2) In patients with septic shock treated with sodium ascorbate, plasma ascorbate levels increased from 28.7 ± 2.6 to 5652 ± 450.9 μ mol/L ($P < 0.0001$) and

urine output, the primary outcome for the trial, increased to 2948 (2181–3715; Mean [95% CI]) mL compared with placebo at 2056 (1520–2593) mL, an 892 mL difference (95% CI: – 2.1 to 1785.2 mL, $p = 0.051$) ($P_{\text{Group}} < 0.001$), requirement for noradrenaline decreased ($P_{\text{Group}} < 0.001$) and the Sequential Organ Failure Assessment (SOFA) score improved ($P_{\text{Group}} < 0.042$). The arterial blood sodium level, however, was higher with sodium ascorbate therapy ($P < 0.001$). There was no statistical difference in alive and vasopressor free hours, alive and ICU-free days, and alive and ventilator-free days.

Conclusions. In experimental sepsis megadose intravenous sodium ascorbate was safe and had potent effects to reverse vasoplegia, increase urine flow, restore brain microcirculatory function and tissue oxygenation, and improve the clinical state. In septic patients a lower dose of sodium ascorbate had qualitatively similar but reduced effects with increases in urine flow, decreased vasopressor requirement and improved SOFA score.

References

- Lankadeva YR, Peiris RM, Okazaki N, Birchall IE, Trask-Marino A, Dornom A, Vale TAM, Evans RG, Yanase F, Bellomo R, May CN. Reversal of the Pathophysiological Responses to Gram-Negative Sepsis by Megadose Vitamin C. *Crit Care Med.* 2021 49: e179-e190.
- These studies were supported by grants from the National Health and Medical Research Council of Australia (GNT1050672), the National Heart Foundation of Australia (VG105933) and by funding from the Victorian Government Operational Infrastructure Support Grant. YRL was supported by a Future Leader Fellowship by the National Heart Foundation of Australia (105666).

Topic: Sepsis.

000304

LPS treatment enhances the immunomodulatory effect of mesenchymal stromal cells derived extracellular vesicles

A. Areny-Balaguero¹, M. Camprubi¹, E. Campaña-Duel¹, A. Ceccato¹, D. Closa², A. Artigas³

¹Translational Research in the Critical Ill Patient, Institut d'Investigació i Innovació Parc Taulí (I3PT), Sabadell, Spain; ²Institut d'investigacions biomèdiques de barcelona (iibb), Consell Superior d'Investigacions Científiques, Barcelona, Spain; ³Department of intensive care medicine, Corporación Sanitaria Universitaria Parc Taulí, Barcelona, Spain

Correspondence: A. Areny-Balaguero

Intensive Care Medicine Experimental 2023, **11(Suppl 1)**:000304

Introduction. Sepsis is a dysregulated immune response to infection that affects principally the lungs and causes, in many cases, an acute respiratory distress syndrome (ARDS) (1). ARDS is associated with a mortality rate of 40% (2) and its biological heterogeneity is one of the main reasons why there is still a lack of a definitive treatment (3). Our group has very recently demonstrated that intratracheal instillation of Mesenchymal Stem Cells (MSCs) diminishes inflammation and improves lung damage in acute lung injury (ALI) model (4). Interestingly, there is evidence that MSCs' effect occur without significant cell engraftment to the tissues suggesting that MSCs action is mainly due to a paracrine mechanism which is mediated, in part, by extracellular vesicles (EVs) (5). EVs bring along promises for tailoring sepsis treatment, since they possess several potential advantages that could address the inherent risks associated with live-cell transplants (6).

Objectives. The main objective of this study is to determine the effect of the MSCs-derived EVs on immune response in an ALI pre-clinical model, and to study how priming MSCs with lipopolysaccharide (LPS) can affect their therapeutic potential.

Methods. The ALI model was induced in male rats by the intratracheal administration of HCl (0.1 M) and 2 h (h) later LPS (30 μ g/g body weight). Nine h after the injury, animals were administered

with Control or LPS EVs, isolated from MSCs supernatant (normal and primed conditions). Animals were scarified after 72 h. Proinflammatory and chemoattractant mediators were evaluated in lung tissue and bronchoalveolar lavage's (BAL) macrophages at mRNA levels. Flow cytometry was used to perform differential and total cell count on BAL.

Results. Regarding the inflammation in lung tissue, we observed that both control and LPS EVs reduced the expression of inflammatory cytokines (IL-1 β and IL-6) and chemoattractant mediators (CCL2 and CXCL-1) (Fig. 1 A and B), as well as, in the macrophages from BAL, which in addition, showed an increased expression of M2 phenotype markers, such as MR and Arg-1 compared to non-treated animals (Fig. 1 B). However, only rats that were treated with LPS EVs exhibited a significant reduction of the percentage of infiltrated neutrophils in the intraalveolar space (Fig. 1 C).

Conclusions. EVs secreted by MSCs reduce lung inflammation in a pre-clinical model of ALI.

- Priming MSCs with LPS enhances the immunomodulatory effect of their secreted EVs by decreasing intraalveolar neutrophil infiltration.

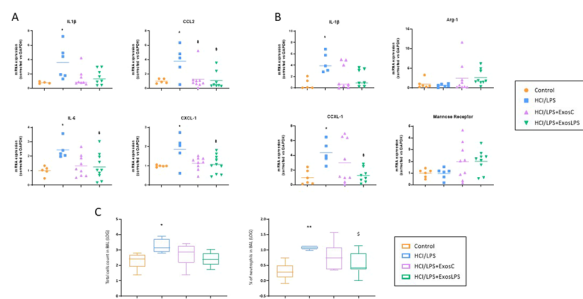

Figure 1 (abstract 000304) Results of administration of EVs from non-activated MSCs with LPS (control and LPS EVs). A) Pro-inflammatory cytokines and chemoattractant mediators in lung tissue at 72 h (mRNA expression correlated vs. GAPDH) (n = 5-10); B) Pro-inflammatory cytokines and chemoattractant mediators and M2 phenotype markers in BAL alveolar macrophages at 72 h (mRNA expression correlated vs. GAPDH) (n = 5-10). C) Total and differential cell count in BAL by flow cytometry (n = 5-10). **p, 0.01 vs. control group; \$ p < 0.05 vs. HCl/LPS group; *p < 0.05 vs. control group

References

- N. F. L. Heijnen, L. A. Hagens, M. R. Smit, M. J. Schultz, T. van der Poll, R. M. Schnabel, I. C. C. van der Horst, R. P. Dickson, D. C. J. J. Bergmans, and L. D. J. Bos, Biological subphenotypes of acute respiratory distress syndrome may not reflect differences in alveolar inflammation. *Physiol. Rep.* 2021, 9, 1–12.
- R. Guillaumat-Prats, M. Camprubí-Rimblas, F. Puig, R. Herrero, N. Tantinyà, A. Serrano-Mollar, and A. Artigas, Alveolar Type II Cells or Mesenchymal Stem Cells: Comparison of Two Different Cell Therapies for the Treatment of Acute Lung Injury in Rats. *Cells* 2020, 9, 1–15.
- N. Pillalamarri, Abdullah, G. Ren, L. Khan, A. Ullah, S. Jonnakuti, and M. Ullah, Exploring the utility of extracellular vesicles in ameliorating viral infection-associated inflammation, cytokine storm and tissue damage. *Transl. Oncol.* 2021, 14, 101,095.
- A. Areny-balagueró, A. Artigas, J. G. Laffey, and D. Closa, Cellular therapies in ARDS. *Signa Vitae* 2022.
- This project was supported by Ministerio de Economía y Competitividad—Instituto de Salud Carlos III (PI18/00677), Fundación Ramon Areces (CIVP19S8207), IBPT and CIBERes.
- M. Singer et al. The third international consensus definitions for sepsis and septic shock (sepsis-3). *JAMA—J. Am. Med. Assoc.* 2016, 315, 801–810.
- C. Sharp, A. B. Millar, and A. R. L. Medford, Advances in understanding of the pathogenesis of acute respiratory distress syndrome. *Respiration* 2015, 89, 420–434.

Topic: Sepsis.

000305

CT cannot be used to quantify fibrosis in the diaphragm of ICU patients

M. Wennen¹, Z. Shi², M. van den Berg², S. Boogaards², H. De Vries³, A. Nederveen⁴, C. Ottenheijm², L. Heunks¹

¹Intensive Care, Erasmus University Medical Center, Rotterdam, Netherlands; ²Physiology, Amsterdam University Medical Centers, location VUmc, Amsterdam, Netherlands; ³Intensive Care, Amsterdam University Medical Center, location VUmc, Amsterdam, Netherlands; ⁴Radiology and Nuclear Medicine, Amsterdam University Medical Center, Amsterdam, Netherlands

Correspondence: M. Wennen

Intensive Care Medicine Experimental 2023, **11(Suppl 1)**:000305

Introduction. Diaphragm dysfunction frequently develops in ICU patients and is associated with difficult weaning and mortality (1–3). Using muscle biopsies, we recently reported that fibrosis in the diaphragm could be one of the pathophysiological pathways contributing to diaphragm dysfunction (4, 5). As biopsies are invasive and difficult to obtain, we aimed to quantify fibrosis with imaging, specifically using density and thickness measurements on CT. If CT could serve as surrogate measure for diaphragm fibrosis this would have great impact on future research and possibly treatment strategies.

Objectives. We hypothesized that diaphragm density on CT, potentially combined with diaphragm thickness, correlates with severity of fibrosis on histological analysis of diaphragm biopsies.

Methods. Fibrosis was quantified using biopsies from the left midcostal diaphragm in diseased ICU patients and non-ICU patients using a picrosirius red staining, as described in (4). We measured diaphragm density on unenhanced thorax CT or contrast enhanced thorax CT acquired during the arterial phase in a web based DICOM-viewer. Three regions of interest were manually drawn in the same axial slice and mean Hounsfield Unit (HU) and standard deviation (std) (see Fig. 1) were computed. The regions were selected within left and right posterior diaphragm crura and the left anterior part of the diaphragm. We additionally measured diaphragm thickness in the posterior crus at the anterior border of the vertebra. The slice was selected at T12 level based on presence of the aforementioned regions in the slice. Data was acquired in the axial slice because this provided good visibility of the diaphragm in all subjects.

Results. 11 COVID-19 ICU patients, 6 non-COVID-19 ICU patients and 3 non-ICU patients were included in this study (mean \pm std age 64.5 ± 10.2 years, 5 women). There was no significant correlation between diaphragm density and fibrosis fraction (Fig. 2A), but mean diaphragm thickness showed a negative and weak correlation with fibrosis fraction (Fig. 2B, $P = 0.005$, adjusted $R^2 = 0.36$). Mean \pm std diaphragm density was 38.2 ± 13.6 , 28.3 ± 9.4 and 26.1 ± 14.1 HU for right and left posterior crus and left anterior region respectively, with a significant difference between the right posterior crus and left anterior region ($p = 0.011$, post-hoc ANOVA analysis with Tukey correction). Mean \pm std diaphragm thickness was 5.4 ± 1.2 and 4.4 ± 1.0 mm for left and right posterior crus respectively. Diaphragm density was comparable with results from previous work (6), but thickness was higher than previously reported (7).

Conclusions. Diaphragm density on CT cannot be used to estimate diaphragm fibrosis. Diaphragm thickness was weakly negatively correlated with diaphragm fibrosis, indicating that atrophy of the diaphragm might be accompanied with an increase of fibrosis. This finding supports the proposition that an increase in extracellular matrix contributes to development of diaphragm dysfunction. Lastly, diaphragm density was spatially different between anterior and posterior parts of the muscle.

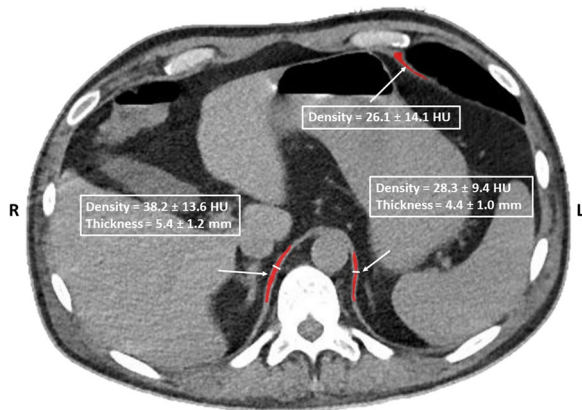

Figure 1 (abstract 000305) Example of CT slice with three regions of interest in red and two thickness measurements in the posterior part of the diaphragm. Values inside white boxes are mean values \pm standard deviation for the complete population. HU = Hounsfield Unit, Std = Standard deviation

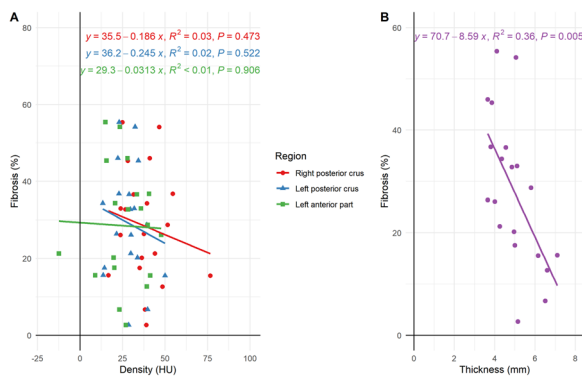

Figure 2 (abstract 000305) Association between fibrosis and diaphragm density (A) and thickness (B). Fibrosis is presented as a percentage of total field of view of the biopsy. Figure A is subdivided in the three regions that were selected. It can be appreciated that density does not significantly correlate with fibrosis, while mean thickness is negatively correlated with fibrosis

References

- Jaber S, Petrof BJ, Jung B, Chanques G, Berthet J-P, Rabuel C, Bouyabrine H, Courouble P, Koehlin-Ramonatxo C, Sebbane M, Similowski T, Scheuermann V, Mebazaa A, Capdevila X, Morinet D, Mercier J, Lacampagne A, Philips A, Matecki S. Rapidly Progressive Diaphragmatic Weakness and Injury during Mechanical Ventilation in Humans. *American Journal of Respiratory and Critical Care Medicine* 2011; 183: 364–371.
- Dres M, Goligher EC, Heunks LMA, Brochard LJ. Critical illness-associated diaphragm weakness. *Intensive Care Medicine* 2017; 43: 1441–1452.
- This work was supported by a ZonMW TOP grant (09120011910004)
- Jung B, Moury PH, Mahul M, de Jong A, Galia F, Prades A, Albaladejo P, Chanques G, Molinari N, Jaber S. Diaphragmatic dysfunction in patients with ICU-acquired weakness and its impact on extubation failure. *Intensive Care Medicine* 2016; 42: 853–861.
- Shi Z, de Vries HJ, Vlaar APJ, van der Hoeven J, Boon RA, Heunks LMA, Ottenheim CAC, Investigators DC-D. Diaphragm Pathology in Critically Ill Patients With COVID-19 and Postmortem Findings From 3 Medical Centers. *JAMA Internal Medicine* 2021; 181: 122–124.
- Shi Z, van den Berg M, Bogaards S, Conijn S, Paul M, Beishuizen A, Heunks L, Ottenheim CAC. Replacement Fibrosis in the Diaphragm of

Mechanically Ventilated Critically Ill Patients. *American Journal of Respiratory and Critical Care Medicine* 2022.

- Parlak S, Beşler MS, Gökhan MB. Association of diaphragm thickness and density measured on chest CT with disease severity in COVID-19 patients. *Am J Emerg Med* 2022; 61: 29–33.
- Gatti S, Abbruzzese C, Ippolito D, Lombardi S, De Vito A, Gandola D, Meroni V, Sala VL, Sironi S, Pesenti A, Foti G, Rezoagli E, Bellani G. Ultrasound Versus Computed Tomography for Diaphragmatic Thickness and Skeletal Muscle Index during Mechanical Ventilation. *Diagnostics* 2022; 12: 2890.

Topic: Acute respiratory failure and mechanical ventilation.

000306

Rapamycin reduces hypothalamic damage in rats with Exertional heatstroke via the mTOR signaling pathway

Y.X. Zhang¹, L. Xuan¹

¹Critical Care Medicine, The Eighth Medical Center of Chinese PLA General Hospital, Beijing, China

Correspondence: Y.X. Zhang

Intensive Care Medicine Experimental 2023, **11(Suppl 1)**:000306

Introduction. Heatstroke is a life-threatening illness typically associated with an uncontrolled rise in core body temperature above 40 °C and central nervous system (CNS) dysfunction, such as delirium, convulsions, or coma. The Paraventricular nucleus (PVN) is the important vulnerable part of the central nervous system. Small cell neurons in the PVN region are damaged after heat stress, resulting in decreased thermal tolerance and impaired thermoregulation function, which seriously affects the prognosis. Studies have shown that heat stress causes neuronal cell necrosis in the hypothalamus similar to hypoxic ischemic encephalopathy. Enhancement of autophagy can improve the survival rate of neurons in hypoxic ischemic areas. Rapamycin (Rapa) can reduce neuronal damage by regulating mTOR pathway and enhancing autophagy, which plays a role in hypoxic ischemic encephalopathy. However, its effect on hypothalamic neuron injury caused by EHS is relatively unexplored. Therefore, it is very important to study the role of Rapa in EHS and hypothalamic autophagy. This will contribute to a better understanding of the mechanism of EHS central nervous system injury and provide new ideas for the prevention and treatment of EHS.

Objectives. To investigate the protective mechanism of rapamycin on the hypothalamus of rats with exertional heat stroke by inhibiting the mammalian target of rapamycin (mTOR) signaling pathway.

Methods. Eighty male wistar rats were randomly divided into four groups: control group (CON group), control+rapamycin group (CON+Rapa group), exertional heat stroke group (EHS group) and exertional heat stroke + rapamycin group (EHS+Rapa group), with 20 rats in each group. The rats in the CON+Rapa and EHS+Rapa groups were intraperitoneally injected with Rapa (1 mg/kg, once daily for four consecutive days).before modeling, the rats in the CON and EHS groups were given the same dose of 0.9% normal saline. The general state, core temperature and the survival rate of the rats were observed. The levels of neuron-specific enolase (NSE), brain active peptide 100 β protein (S100 β), interleukin-6 (IL-6) and tumor necrosis factor- α (TNF- α) in arterial serum were detected by ELISA. The morphological changes of hypothalamus were observed by naked eye, HE and Nissl staining. Western blot was used to detect the expression of mammalian target of rapamycin (mTOR) and (pmTOR), autophagy effector protein (Beclin-1), ubiquitin-binding protein (p62) and autophagy marker microtubule-associated protein 1 light chain 3(LC3) in the hypothalamus of rats. The ratios of pmTOR/mTOR and LC3-II/LC3-I were calculated. Immunofluorescence was used to observe the apoptosis of hypothalamus.

Results. Compared with CON group, the core temperature of EHS group and EHS+Rapa group was significantly increased ($P < 0.05$). Compared with the EHS group, the 5-h survival rate of the EHS+Rapa group was increased ($P < 0.05$). HE and Nissl staining showed that the pathological damage of hypothalamic nerve cells in the EHS group was more serious, while in the EHS+Rapa group was significantly less than that in the EHS group ($P < 0.05$).Western blot results showed

that compared with the CON group, the ratio of pmTOR/mTOR, Beclin-1 expression, LC3-II/LC3-I ratio in the hypothalamus tissue of the EHS group were increased ($P < 0.05$) and p62 expression was decreased ($P < 0.05$); Compared with the EHS group, the ratio of pmTOR/mTOR and p62 expression in the hypothalamus of the EHS + Rapa group were decreased ($P < 0.05$), Beclin-1 expression and LC3-II/LC3-I ratio were increased ($P < 0.05$). The expression levels of NSE, S100 β protein and TNF- α in serum of EHS group were significantly increased ($P < 0.05$). Compared with the EHS group, the expression levels of NSE, S100 β protein, IL-6 and TNF- α in the serum of the EHS + Rapa group were significantly decreased ($P < 0.05$). The results of immunofluorescence showed that the cell apoptosis in the hypothalamus of EHS rats was significantly increased ($P < 0.05$). Compared with the EHS group, the EHS + Rapa group had significantly reduced apoptosis in the hypothalamus ($P < 0.05$).

Conclusions. Rapamycin can alleviate the hypothalamus tissue damage caused by exertional heat stroke, improve the function of brain cells, reduce the levels of inflammatory factors and the apoptosis of tissue cells, which is related to the inhibition of mTOR signaling pathway and the enhancement of hypothalamus autophagy level.

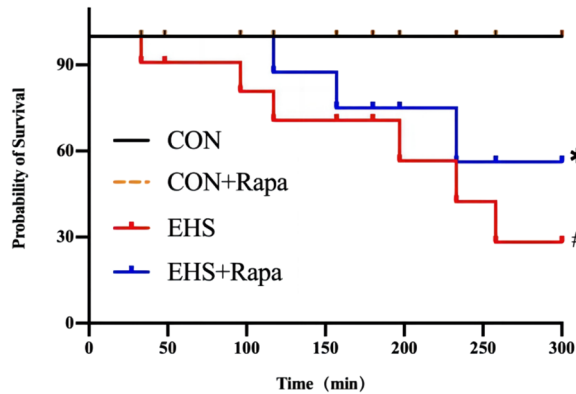

Figure 1 (abstract 000306) Fluctuations in core temperature in rats during the development of an EHS model

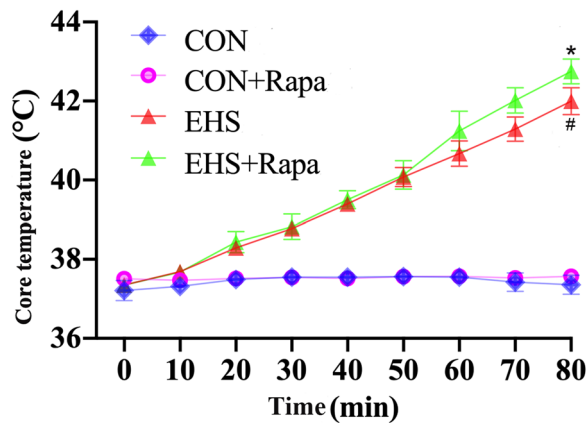

Figure 2 (abstract 000306) Rapamycin (Rapa) improved the survival rate of exertional heat stroke rats

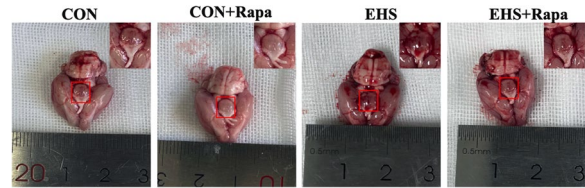

Figure 3 (abstract 000306) The morphological changes of hypothalamus were observed by naked eye. A: Normal control group; B: Normal control + Rapamycin group; C: Exertional heat stroke group; D: Exertional heat stroke + Rapamycin group

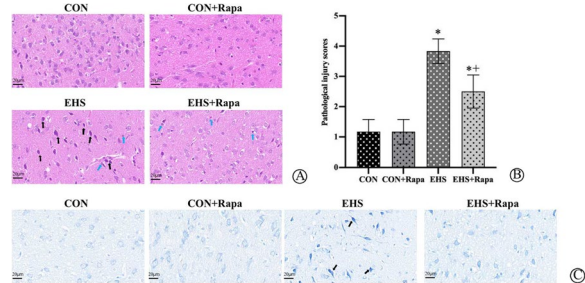

Figure 4 (abstract 000306) 4-1 (abstract 000306) The morphological changes of hypothalamus were observed by HE staining. A: Normal control group; B: Normal control + Rapamycin group; C: Exertional heat stroke group; D: Exertional heat stroke + Rapamycin group. 4-2 (abstract 000306) The pathological injury scores of hypothalamus were observed by HE staining. 4-3 (abstract 000306) The morphological changes of hypothalamus were observed by Nissl staining

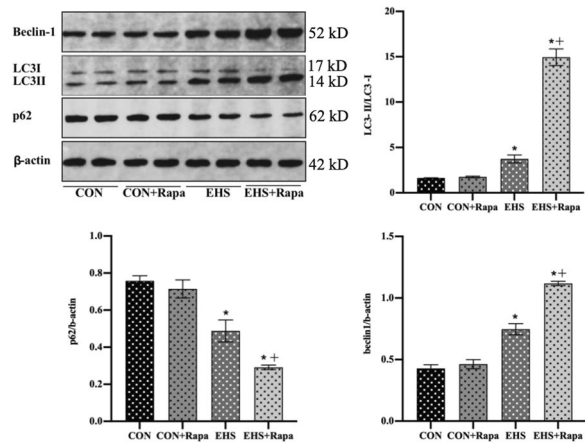

Figure 5 (abstract 000306) pmTOR/mTOR expression in rat hypothalamus tissues from each group were examined by Western blot

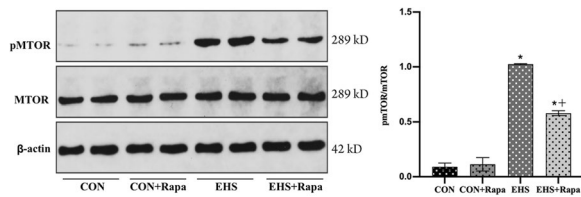

Figure 6 (abstract 000306) Rats hypothalamus tissues from each group expressed different levels of LC3, Beclin-1 and p62, examined via Western blot

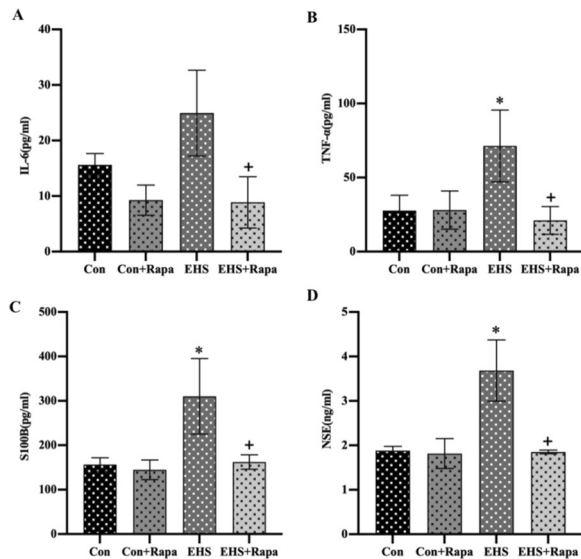

Figure 7 (abstract 000306) The expression of NSE, S100β protein, TNF-α and IL-6 in rat serum from each group

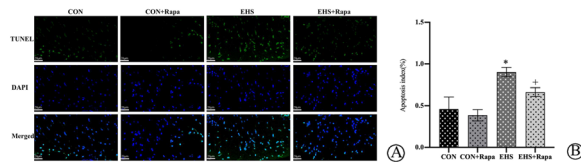

Figure 8 (abstract 000306) 8–1 (abstract 000306) The levels of apoptosis were compared among the study groups. 8–2 (abstract 000306) The levels of apoptosis were compared among the study groups.

References

- Maskrey M, Hinrichsen CF. Respiratory responses to combined hypoxia and hypothermia in rats after posterior hypothalamic lesions. *Pflügers Archiv*, 1994, 426(5): 371–377. Thoresen M, Haaland K, Løberg EM, et al. A piglet survival model of posthypoxic encephalopathy[J]. *Pediatric research*, 1996, 40(5):738–748.
- Wang C, Wang Z, Zhang X, et al. Protection by silibinin against experimental ischemic stroke: up-regulated pAkt, pmTOR, HIF-1α and Bcl-2, down-regulated Bax, NF-κB expression[J]. *Neuroscience letters*. 2012, 529(1): 45–50.
- Schlader ZJ, Davis MS, Bouchama A. Biomarkers of heatstroke-induced organ injury and repair[J]. *Experimental Physiology*, 2022, 107(10): 1159–1171.
- Brugaletta G, Greene E, Ramser A, et al. Effect of cyclic heat stress on hypothalamic oxygen homeostasis and inflammatory state in the jungle

fowl and three Broiler-Based research lines[J]. *Frontiers in Veterinary Science*, 2022, 25(9): 905,225.

- Eighth Medical Center of Chinese PLA General Hospital major Project (2021ZD002), (2016ZD-008)
- Military Medical Innovation Project (18CXZ023)
- Zhang Y, Deng Z, Li Y, et al. Mesenchymal Stem Cells Provide Neuroprotection by Regulating Heat Stroke-Induced Brain Inflammation. *Front Neurol*. 2020, 5(11): 372.
- Ji J, Hong X, Su L, et al. Proteomic identification of hippocalcin and its protective role in heatstroke-induced hypothalamic injury in mice. [J] *Cell Physiol*. 2019, 234(4): 3775–3789.
- Liu TT, Hu CH, Tsai CD, et al. Heat stroke induces autophagy as a protection mechanism against neurodegeneration in the brain[J]. *Shock*. 2010, 34(6): 643–8.
- Li L, Huang J. Rapamycin pretreatment alleviates cerebral ischemia/reperfusion injury in dose–response manner through inhibition of the autophagy and NFκB pathways in rats. *Dose Response*, 2020, 18(3):155–164.
- Alzahrani JM, Murray KO, Gambino BJ, et al. Neuromotor deficits and altered physiological responses to repeated exertional heat stroke exposures in mice. *Am J Physiol Regul Integr Comp Physiol*. 2022, 323(6):951–961.
- He SX, Li R, Yang HH, et al. Optimization of a rhabdomyolysis model in mice with exertional heat stroke mouse model of EHS-rhabdomyolysis[J]. *Front Physiol*, 2020, 11: 642. Iwaniec J, Robinson GP, Garcia CK, et al. Acute phase response to exertional heat stroke in mice[J]. *Exp Physiol*, 2021, 106(1): 222–232.

Topic: Neurointensive care.

000308

The choice of creep and maintenance fluids affects mean daily sodium intake in critically ill patients—systematic review and meta-analysis

J. Waskowski¹, S. M. Salvato¹, M. Müller², D. Hofer¹, N. Van Regenmortel³, C. A. Pfortmueller¹

¹Department of Intensive Care Medicine, Inselspital, Bern University Hospital, University of Bern, Bern, Switzerland; ²Emergency department, Inselspital, Bern University Hospital, University of Bern, Bern, Switzerland; ³Department of Intensive Care Medicine, Het Ziekenhuisnetwerk Antwerpen Vzw, Antwerpen, Belgium

Correspondence: J. Waskowski

Intensive Care Medicine Experimental 2023, **11(Suppl 1)**:000308

Introduction. “Non-resuscitation fluids” namely maintenance fluids and creep fluids are a major source of fluid, sodium and chloride intake in critical illness [1]. Currently, it is unclear whether low sodium content solutions e.g. glucose 5% might decrease the daily sodium load and improve patient outcome compared to standard high sodium content solutions, e.g. normal saline. While some research suggested an increased risk of hyponatremia and delirium with the use of low sodium versus high sodium content solutions [2, 3], others indicate a decrease in daily fluid load and hypernatremia [4, 5]. Therefore, we conducted a systematic review (SR) and meta-analysis to evaluate the impact of maintenance and creep fluids on daily sodium intake in an adult general ICU population.

Objectives. The primary objective was to assess if the choice of sodium concentration (high vs low) in maintenance and creep fluids might reduce daily ICU sodium intake. Secondary objectives were the rate of hypo-/hypernatremia and hyper-/hypochloremia and fluid balance.

Methods. Systematic literature review and meta-analysis registered on PROSPERO (CRD42022300577) including randomized controlled trials (RCTs) and observational studies investigating the influence of maintenance or creep fluid choice on sodium intake in ICU patients. We excluded studies not written in English, without control patients, evaluating resuscitation fluids only, and investigation in selected patient populations (children, patients with neurologic disease, burn

patients). The conduct of this SR was based on the Cochrane Collaboration Guidelines. We performed a systematic search on PubMed, Embase, and the Cochrane Library databases and in references of all eligible publications published until 31th December 2022. We systematically assessed the risk of bias.

For the outcomes, pooled unstandardized mean difference or odds ratios (OR) with 95% confidence intervals (CI) were obtained.

Results. We identified 21 out of 7,370 articles eligible for full-text analysis. Four studies, thereof one RCT [5] and three observational studies [3, 4, 6] (951 patients) were eligible for meta-analysis. Risk of bias was moderate across studies. Our meta-analysis showed a mean difference in daily sodium intake of -117 mmol/d (95%CI -174 ; -59 ; $p < 0.001$) with the use of low sodium versus high sodium content solutions. This corresponds to a mean reduction in sodium intake of 2.7 g on average. We observed considerable heterogeneity ($I^2 = 95%$) but no evidence of small-study effects ($p = 0.34$). We noted no differences in the incidences of hyponatremia (OR 0.85; 95% CI 0.51; 1.41) nor hyponatremia (OR 2.21; 95% CI 0.77; 6.33). Risk of hyperchloremia was lower (OR 0.26; 95%CI 0.1; 0.64) in the low sodium group. Observational data hints towards a higher fluid balance in the high sodium group.

Conclusions. The use of low sodium content maintenance and creep fluids reduces sodium burden by a relevant amount compared to the use of standard high sodium content fluids.

References

- Okada M, Egi M, Yokota Y, Shirakawa N, Fujimoto D, Taguchi S, Furushima N, Mizobuchi S, (2017) Comparison of the incidences of hyponatremia in adult postoperative critically ill patients receiving intravenous maintenance fluids with 140 mmol/L or 35 mmol/L of sodium: retrospective before/after observational study. *Journal of Anesthesia* 31: 657–663
- Nagae M, Egi M, Furushima N, Okada M, Makino S, Mizobuchi S, (2019) The impact of intravenous isotonic and hypotonic maintenance fluid on the risk of delirium in adult postoperative patients: retrospective before-after observational study. *J Anesth* 33: 287–294
- Hoste EA, Maitland K, Brudney CS, Mehta R, Vincent JL, Yates D, Kellum JA, Mythen MG, Shaw AD, (2014) Four phases of intravenous fluid therapy: a conceptual model. *British journal of anaesthesia* 113: 740–747
- Magee C, Thompson-Bastin M, Laine M, Bissell B, Moran P, Owen G, Morris P, Flannery A, (2018) Insidious harm of medication diluents as a contributor to cumulative volume and hyperchloremia. *Critical Care Medicine* 46: 6
- Van Regenmortel N, Hendrickx S, Roelant E, Baar I, Dams K, Van Vlimmeren K, Embrecht B, Wittock A, Hendriks JM, Lauwers P, Van Schil PE, Van Craenenbroeck AH, Verbrugge W, Malbrain MLNG, Van den Wyngaert T, Jorens PG, (2019) 154 compared to 54 mmol per liter of sodium in intravenous maintenance fluid therapy for adult patients undergoing major thoracic surgery (TOPMAST): a single-center randomized controlled double-blind trial. *Intensive care medicine* 45: 1422–1432
- Bihari S, Prakash S, Potts S, Matheson E, Bersten AD, (2018) Addressing the inadvertent sodium and chloride burden in critically ill patients: a prospective before-and-after study in a tertiary mixed intensive care unit population. *Crit Care Resusc* 20: 285–293

Topic: Metabolism, endocrinology, liver failure and nutrition.

000311

Does increased staffing lead to increased patient mortality?

An analysis

A. Walker¹

¹Critical Care Medicine, Surrey and Sussex Healthcare NHS Trust, Redhill, United Kingdom

Correspondence: A. Walker

Intensive Care Medicine Experimental 2023, **11(Suppl 1)**:000311

Introduction. Intensive Care Units normally have improved doctor to patient ratios compared to general hospital wards, however even ICUs have variation in staffing levels depending on the time of day. Typically, the levels are better during the daytime, whereas evening and overnight shifts rely on fewer clinicians. This analysis aimed to evaluate the impact of this discrepancy on patient mortality.

Objectives. To determine if there was a significant difference in mortality between ICU patients admitted during the fully staffed daytime period and the on-call staffed evening and overnight periods.

Methods. ICU admissions in a single district general hospital ICU were analysed, using WardWatcher software.

Inclusion criteria were all unplanned adult ICU admissions during a 16 year period (2006 to 2022). Exclusion criteria were patients < 18 years old; planned admissions and transfers from other hospitals.

The data was divided into 2 time periods based on when the patient was admitted to ICU:

In hours (08:00 to 17:30)—the period when the ICU was fully staffed.

Out of hours (17:31 to 07:59)—the period of on-call ICU staffing.

Primary outcomes were patient deaths during ICU stay and patient deaths during entire hospital stay.

One tailed Chi squared test was used for all statistical analyses with a significance level of $p < 0.05$. Microsoft Excel was used for the calculations.

Results. A total of 10,946 admissions were analysed. 3907 were in hours, 7039 were out of hours.

There were 879 ICU deaths for the in hours group (mortality 22.5%) and 1251 ICU deaths for the out of hours group (mortality 17.8%). The overall in ICU mortality of 19.5% was comparable to the national level of 18.1% (1).

Table 1 (abstract 000311) ICU mortality for in hours admissions vs out of hours admissions

	Admissions	ICU deaths	ICU Mortality (%)
In hours	3907	879	22.5
Out of hours	7039	1251	17.8
			$P < 0.0001$

There were 1150 total hospital stay deaths for the in hours group (mortality 29.4%) and 1762 total hospital stay deaths for the out of hours group (mortality 25.0%).

Table 2 (abstract 000311) Total hospital stay mortality for in hours admissions vs out of hours admissions

	Admissions	Hospital stay deaths	Hospital stay mortality (%)
In hours	3907	1150	29.4
Out of hours	7039	1762	25.0
			$P = 0.0002$

Conclusions. Both ICU and total hospital stay mortality were significantly higher for patients admitted during the fully staffed daytime period compared to the on-call staffed evening and overnight period. This is in keeping with the higher mean APACHE II score (2) for in hours ICU admissions (16.3) compared to out of hours admissions (15.3) demonstrating that these patients were more severely unwell at time of admission.

One possible explanation for this difference is that unwell patients on the hospital wards are not monitored as closely out of hours hence may not be identified and escalated during this period of reduced staffing. These patients will then only be identified and referred to ICU during the daytime and admitted once they have become more unwell.

References

- 2- Knaus WA, Draper EA et al. APACHE II: A severity of disease classification system. *Critical Care Medicine* 1985; 13(10): 818–829. Available from: <https://read.qxmd.com/read/3928249/apache-ii-a-severity-of-disease-classification-system?redirected=slug>
- Harrison D. Deaths in adult, general critical care units in England and Wales, 2007 to 2009 [Internet]. 2011 [cited April 2023]. Available from: <https://www.icnarc.org/Our-Audit/Audits/Cmp/Our-National-Analyses/Mortality>

3. Nil to acknowledge

Topic: Critical care organisation, quality management, information systems, outcomes.

000312

Health system (inpatient ward) strain and acute physiological deterioration: a retrospective observational study

K. Kohler¹, D. Stein¹, V. Sarah¹, D. Hanlon¹, T. T. W. Hla¹, S. Harris¹
¹Institute of Health Informatics, University College London, London, United Kingdom

Correspondence: K. Kohler

Intensive Care Medicine Experimental 2023, **11(Suppl 1)**:000312

Introduction. The role of the ward environment rarely features in patient-level early warning systems, despite the evidence linking ward strain to compromised patient care and outcomes. In the emergency department, patient capacity strains were associated with longer length of stay (Chiu et al., 2018), increased risk of preventable medical errors (Epstein et al., 2011) and increased in-patient mortality (Sun et al., 2013).

Patients with low acuity but high dependency may still absorb nursing time that would otherwise be spent on care processes such as vitals monitoring, medication administration, patient repositioning. Delays in such care processes put other patients on the ward at an increased risk of deterioration (Ball et al., 2014). The NEWS score defines the future risk of the individual (index) patient. Aggregating NEWS scores for the non-index patients within a ward may provide a useful metric of health system strain that affects the outcome of the index patient. Patient deterioration on wards is both a care quality and patient safety challenge.

Objectives. To measure the association between the overall burden of physiological risk (derived from NEWS/NEWS2) from the community of patients on a ward and the index patient's risk of referral to a rapid response (outreach) team (RRT).

Methods. The study was approved by NHS REC 21/LO/0437—as part of larger piece of work on managing bed demand. We used a 90-day convenience sample (August–November 2022) of all inpatients at an urban teaching hospital in the UK. We abstracted demographics (age, gender), ward location and specialty group (e.g. surgery, medicine, etc.), and all NEWS measurements during the inpatient episode.

We created a 12-h lookback table for the ward and group, and a 3-h lookback for measuring patient deterioration. We calculated ward-based aggregates (mean, maximum and median ward NEWS for each patient-hour) in addition to aggregates for physician specialty group (referred to as 'area' below). These were normalised to account for the usual level of acuity in each location. The aggregates were re-calculated to exclude the index patient. We defined future deterioration as an increase in NEWS for the index patient, or a referral to the RRT. We used Python v3.9.5 and Scikit-learn v1.0 for data preparation and analysis, and built an ensemble decision tree using XGBoost. Code is available upon request.

Results. Our model (with hyperparameter tuning via a search grid) showed a good predictive power with $R^2 = 0.757$ using a random 70/30 test-train split and a fivefold cross-validation. The most important features were the normalised ward mean NEWS in the preceding 12 h, the uncorrected area and ward mean NEWS and the number of NEWS observations recorded in the ward (perhaps a proxy for strain/busy-ness) [Fig. 1].

In Fig. 2, we should the actual and the predicted NEWS for this model with a fit line. While the model fit shows clear correlation, significant variation remains from unmodelled patient and system level effects. Health system factors at both the ward and area (specialty) levels are strongly associated with future deterioration.

Conclusions. This is the first report demonstrating that aggregate physiological risk derived from the community of patients within a ward, or managed by a specialty is associated with individual patient deterioration. The aggregate risk is derived from routinely measured data (NEWS score) and therefore readily generalizable. Future work will compare the relative contribution of individual physiological risk

in the index patient to the aggregate physiological risk from the community, and expand the range of inputs to define ward strain.

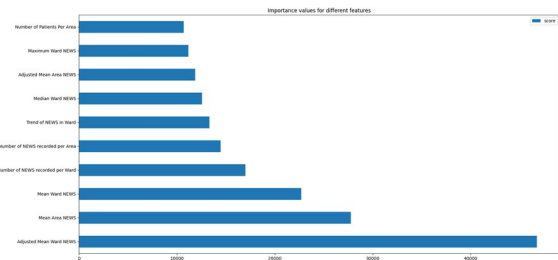

Plot of feature importance—the highest importance features implicate normalised mean NEWS in the ward and physician on-call cover areas and the the number of NEWS observations taken.

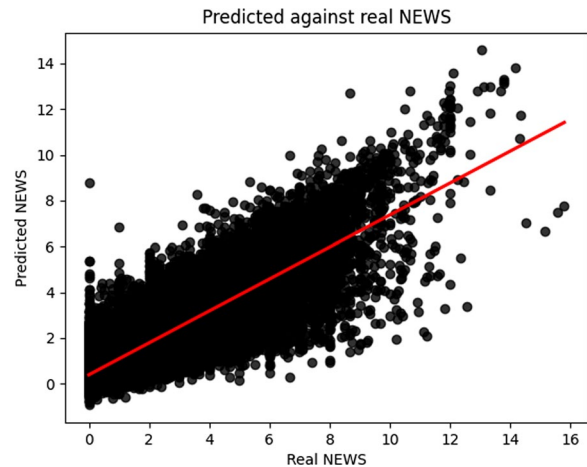

Actual patient NEWS versus predicted NEWS using the XGBoost model with only ward and area-based factors.

References

1. KK is supported by a NIHR Development and Skills Enhancement grant.
2. Chiu IM, Lin YR, Syue YJ, Kung CT, Wu KH, Li CJ. The influence of crowding on clinical practice in the emergency department. *Am J Emerg Med.* 2018;36(1):56–60. <https://doi.org/10.1016/j.ajem.2017.07.011>
3. Ball JE, Griffiths P, Rafferty AM, Lindqvist R, Murrells T, Tishelman C. A cross-sectional study of 'care left undone' on nursing shifts in hospitals. *J Adv Nurs.* 2016;72(9):2086–2097. <https://doi.org/10.1111/jan.12976>
4. Sun BC, Hsia RY, Weiss RE, et al. Effect of emergency department crowding on outcomes of admitted patients. *Ann Emerg Med.* 2013;61(6):605–611.e6. <https://doi.org/10.1016/j.annemergmed.2012.10.026>
5. Epstein SK, Huckins DS, Liu SW, et al. Emergency department crowding and risk of preventable medical errors. *Intern Emerg Med.* 2012;7(2):173–180. <https://doi.org/10.1007/s11739-011-0702-8>

Topic: Data Science.

000313

Patient and staff experience of a dedicated Thirst Bundle; can patient thirst be effectively managed in critical care?

J. Clark¹, P. Mccready², S. Archer³

¹Speech and Language Therapy and Critical Care, Guy's and St Thomas' NHS Foundation Trust, London, United Kingdom; ²Critical Care, Guy's and St Thomas' NHS Foundation Trust, London, United Kingdom; ³Speech

and Language Therapy, Guy's and St Thomas' NHS Foundation Trust, London, United Kingdom

Correspondence: J. Clark

Intensive Care Medicine Experimental 2023, **11(Suppl 1)**:000313

Introduction. Patients report thirst as one of the most distressing symptoms of critical illness (1). A dedicated thirst intervention based on the Puntillo thirst bundle (3) has been successfully piloted at our Trust (2).

Objectives. To describe the launch of a Thirst Bundle as part of routine care in critical care and examine patient outcomes and staff confidence.

Methods. The Thirst Bundle was launched in 4 mixed cohort ICU units (54 beds) through a Plan Do Study Act (PDSA) approach. Thirst Bundle contents was reviewed by an cross-specialty steering group and former patient advisors. Staff training was provided during the launch period. A reporting system was established in the electronic notes to capture outcomes. Equipment including access to ice was set up for each unit. Each unit was reviewed for one month resulting in data collection of between 100–120 applications of the Bundle. Thirst was assessed before and after application of the bundle using patient or clinician report of thirst severity via anchor word rating (none, mild, moderate, severe). The intervention included iced swabs, ice cold sprays and a menthol balm. Staff feedback was gained via anonymous questionnaires distributed across the units to explore awareness of the Thirst Bundle, perceptions of its effectiveness and confidence in its use.

Results. Data were collected from 106 patients who received 441 applications of the Thirst Bundle in the study period. Median length of stay was 12 days. 56% (n=245) of interventions were provided to nil by mouth patients and 52% (n=228) had their own airway, the remainder having tracheostomy (40%, n=179) or endotracheal (8%, n=34) tubes in-situ. Thirst was reported in 67% (n=295) of thirst assessments. Incomplete reporting led to data loss in 15% (n=67). 75% (n=171) of applications resulted in reduction in thirst following application of the bundle. Twenty-three staff feedback forms were collected during the study period and 78% (n=18) of responders had used the Thirst Bundle with patients. Of staff who had used the bundle, effectiveness and confidence were both reported as a median of 8.5/10. Results were deemed as favourable to staff and patient experience and a Thirst Bundle procedure with video guide was subsequently created and approved for local publication via local governance processes.

Conclusions. We have used existing evidence (3) to adapt a Thirst Bundle for clinical application in large critical care provision. Data examining reduction of thirst symptom burden showed effectiveness in 75% of applications. Staff feedback suggested good awareness of the bundle and high levels of perceived efficacy and confidence in usage. Production of a clinical procedure guide inclusive of a video now aims to support ongoing usage. Further work will now seek to maintain the Thirst Bundle as part of routine critical care symptom management.

References

1. J Clark, J Meyer, S Archer, Development and evaluation of a Thirst Bundle for adult critically ill patients in a tertiary UK Critical Care (CC). *J Intensive Care Soc.* 2022 Aug; 23(1 Suppl): 1–210. Published online 2022 Aug 3. <https://doi.org/10.1177/17511437221095122> PMID: PMC9358697
2. This work was supported by Guy's and St Thomas' Charity.
3. Puntillo K, Arai S, Cooper B, et al. A randomised control trial of an intervention to relieve thirst and dry mouth in intensive care unit patients. *Intensive Care Med.* 2014;40:1295–1302.
4. Puntillo KA, Arai S, Cohen NH, et al. Symptoms experienced by intensive care unit patients at high risk of dying. *Crit Care Med.* 2010;38(11):2155–2160.

Topic: Critical care organisation, quality management, information systems, outcomes.

000315

Association of CHA2DS2-VASc score with new-onset atrial fibrillation and mortality in COVID-19 patients hospitalized in ICU

P. Ioannidis¹, M. Sileli¹, E. Kerezidou¹, M. Kamaterou¹, D. Ntanos¹, C. Iasonidou¹

¹B ICU, General Hospital of Thessaloniki "George Papanikolaou", Thessaloniki, Greece

Correspondence: P. Ioannidis

Intensive Care Medicine Experimental 2023, **11(Suppl 1)**:000315

Introduction. Covid-19 is a global pandemic that does not affect respiratory system alone. Severe covid-19 cases involve multiple organs, exhibit high morbidity and mortality and are often admitted to ICU. Various cardiovascular complications have been described. Arrhythmias are found in 7% of patients and 44.4% in the ICU (1). Atrial fibrillation (AF) is the most common. Preexisting and new-onset AF is related to mortality. CHA2DS2-VASc score was designed to evaluate thromboembolic risk in AF but now is related to mortality in different pathologies, new AF episodes and AF recurrence (2).

Objectives. To investigate the association of CHA2DS2-VASc with new-onset AF, mortality and ICU stay in covid-19 patients admitted to a medical ICU.

Methods. This study is an retrospective, observational, single-center, case series study. It was conducted in a medical ICU of a tertiary hospital in northern Greece. Sample of the study included 163 patients that were admitted to the ICU between March 2020 and April 2022 with the diagnosis of covid-19 infection verified by PCR testing. In order to study new-onset AF, 12 patients with history of AF were excluded. We gathered information about demographics, medical history, clinical and laboratory presentation and outcomes.

Results. Mean age of patients was 64 (IQR 56.5–71) years and the majority of them (67.5%) were males. About half of them were hypertensive (52.15%) and obese (51.53%). Median value of APACHE II score was 15 (IQR 13–18) indicating a relatively low 15% mortality. Median value of SOFA score was 6 (IQR 4–8) that corresponds to 10% mortality. CHA2DS2-VASc score exhibited a median value of 2 (IQR 1–3). Advanced age was significantly related to new-onset AF (p<0.001, 95% CI – 11, – 4). Increased CHA2DS2-VASc was significantly associated with new-onset AF (p=0.003, p<0.05, 95%CI – 2, – 2.46e–05). Other factors that predicted new-onset AF were arterial hypertension (p=0.042, p<0.05, OR=2.29, 95%CI 1.02,5.15) and stroke (p=0.047, p<0.05) that are components of CHA2DS2-VASc score. CHA2DS2-VASc was also strongly related to ICU mortality (p=0.029, 95%CI – 1, 8.6e–5). Mortality was associated with new-onset AF (p<0.001, OR 5.87, 95% CI 2.43,14.17), ICU stay (p=0.016, p<0.05, 95%CI – 7, – 1), advanced age (p=0.001, p<0.05, 95%CI – 9, – 2), APACHE II (p=0.04, p<0.05, 95%CI – 3, – 7.67e–5) and SOFA score (p=0.033, p<0.05, 95%CI – 1, – 2.61e–5). CHA2DS2-VASc was not associated with ICU stay (p=0.842, 95%CI – 1.21,1.48).

Conclusions. In our sample of ICU covid-19 patients CHA2DS2-VASc score was significantly associated with new-onset AF and ICU mortality, but not with ICU stay.

References

1. Ooi H, Chen LH, Ni YL, Shen HT, Lee YH, Chu YC, et al. CHA2DS2-VASc scores predict major adverse cardiovascular events in patients with chronic obstructive pulmonary disease. *Clin Respir J.* 2018 Mar 1;12(3):1038–45.
2. Wang D, Hu B, Hu C, Zhu F, Liu X, Zhang J, et al. Clinical Characteristics of 138 Hospitalized Patients With 2019 Novel Coronavirus-Infected Pneumonia in Wuhan, China. *JAMA.* 2020 Mar 17;323(11):1061–9.
3. none

Topic: Cardiovascular issues in ICU.

000316

Evidence for the presence of hyper- and hypo-inflammatory subphenotypes in patients at risk of ARDS presenting to the emergency department: a secondary analysis of the LIPS-A trial

D. von Wedel¹, S. Redaelli¹, M. Fosset¹, A. Suleiman¹, G. Chen¹, J. Alingrin¹, M. N. Gong², G. Ognjen³, V. Banner-Goodspeed¹, D. Talmor¹, M. S. Schaefer¹, B. Jung¹
¹Department of Anesthesia, Critical Care, and Pain Medicine, Beth Israel Deaconess Medical Center, Harvard Medical School, Boston, United States of America; ²Division of Critical Care Medicine, Montefiore Medical Center, NYC, United States of America; ³Division of Pulmonary and Critical Care, Mayo Clinic, Rochester, United States of America

Correspondence: D. von Wedel

Intensive Care Medicine Experimental 2023, **11(Suppl 1)**:000316

Introduction. Hyper- and hypo-inflammatory subphenotypes have been described in patients with acute respiratory distress syndrome (ARDS) [1]. However, whether these subphenotypes precede the development of ARDS is unclear. We hypothesized that inflammatory subphenotypes can be identified in patients at risk of ARDS presenting to the emergency department.

Methods. LIPS-A, a double-blind, randomized, placebo-controlled trial evaluating the efficacy of aspirin in preventing ARDS, was conducted at 16 US hospitals between 2012 and 2014 [2]. Patients at risk of ARDS (Lung Injury Prediction Score [LIPS] ≥ 4) who presented to the emergency department were included. Development of ARDS by day 7 was the primary outcome. In this secondary analysis, we applied latent class analysis (LCA) to data collected in the emergency department (day 0, before treatment initiation) to test for the presence of inflammatory subphenotypes before the onset of ARDS. To assess stability of identified subphenotypes over time, we repeated LCA on day 1 and 4, respectively. Class-defining variables were selected based on published literature and availability in LIPS-A, including patient demographics, vital signs, and inflammatory biomarkers. We further explored whether outcomes and treatment effects of aspirin varied across subphenotypes.

Results. 376 (96%, 189 received aspirin) of 390 patients in the LIPS-A trial were included in this analysis after excluding patients with missing data for inflammatory biomarkers on day 0. LCA upon admission to the emergency department suggested strong evidence for the presence of two latent classes at baseline: 72 (19%) patients demonstrated characteristics of a hyper-inflammatory subphenotype and 304 (81%) had a hypo-inflammatory subphenotype (Fig. 1). The two-class model performed better than the single-class model, while additional classes did not improve model fit. Presence of the subphenotypes identified at baseline was confirmed on day 1 and 4 in a subgroup with available data (n = 244, Fig. 2A). Class assignment of patients at day 0 remained mostly stable throughout day 1 (93%). 44 (18%) patients switched class from day 1 to 4. Of these, 42 (95%) improved from the hyper-inflammatory to hypo-inflammatory class (Fig. 2B). Incidence of ARDS did not differ significantly between subphenotypes identified at baseline (Table 1). However, patients consistently assigned to the hyper-inflammatory class throughout the study period were at increased risk of ARDS compared to the rest of the cohort (32% versus 10%, p = 0.010). Patients presenting hyper-inflammatory characteristics at baseline had higher 1-year mortality, fewer ventilator-free days, and longer ICU and hospital length of stay. Baseline subphenotypes did not modify the treatment effect of aspirin (Table 1).

Table 1 (abstract 000316) Outcomes by subphenotype at baseline

Outcome	Hypo-inflammatory	Hyper-inflammatory	p-value	p-for-aspirin-interaction
ARDS	25 (8.2%)	10 (13.8%)	0.14	0.36
28-day mortality	25 (8.2%)	9 (12.5%)	0.26	0.68
1-year mortality	61 (20.0%)	25 (34.7%)	0.008	0.54
VFD (days)	28 (27 to 28)	28 (23 to 28)	0.010	0.88

Outcome	Hypo-inflammatory	Hyper-inflammatory	p-value	p-for-aspirin-interaction
ICU LOS (days)	0 (0 to 3)	3 (2 to 6)	<0.001	0.16
H LOS (days)	5 (3 to 9)	9 (6 to 18)	<0.001	0.46

Medians (IQR) or frequencies (%) with p-values for between-group comparison and p-for-interaction of baseline subphenotype with aspirin treatment regimen from logistic or negative binomial regression. Abbreviations: VFD, Ventilator-free days; LOS, Length of stay; H, Hospital.

Conclusions. Previously described hyper- and hypo-inflammatory subphenotypes precede the development of ARDS, remain stable over time, and can be identified in patients at risk of ARDS presenting to the emergency department. Patients consistently demonstrating hyper-inflammatory characteristics are at increased risk of ARDS. Early identification of inflammatory subphenotypes could be considered as potential target and predictive enrichment strategy in future trials on the prevention of ARDS.

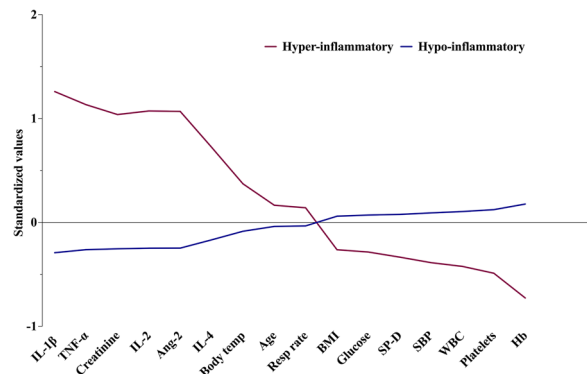

Figure 1 (abstract 000316) Subphenotypes identified in patients at risk of ARDS presenting to the emergency department. Standardized values of continuous class-defining variables upon presentation to the emergency department (day 0, before treatment initiation). Variables are ordered by degree of separation between the identified classes, with those that were highest in the hyper-inflammatory subphenotype on the left. The y-axis represents standardized variable values with a mean of 0 and a standard deviation of 1. To visualize class profiles, values of individual variables are connected by lines. Abbreviations: IL, Interleukin; TNF, Tumor necrosis factor; Ang, Angiopoietin; Temp, Temperature; Resp, Respiratory; BMI, Body mass index; SP-D, Surfactant protein D; SBP, Systolic blood pressure; WBC, White blood cells; Hb, Hemoglobin.

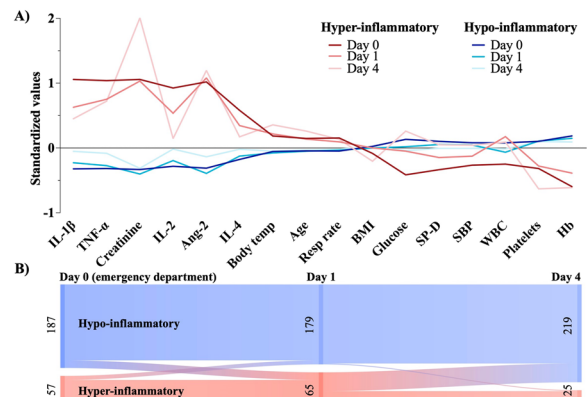

Figure 2 (abstract 000316) Stability of subphenotypes over time. Panel A shows standardized values of class-defining variables by

subphenotypes identified on day 0, 1, and 4. Latent class analysis was performed in a subgroup of patients with available data for inflammatory serum biomarkers on all reassessments (n=244). For better comparison, variables are ordered based on their degree of class separation in the full cohort on day 0 (as shown in Fig. 1). Panel B shows the number of patients assigned to the hyper- and hypo-inflammatory subphenotype for each respective time point. Connecting lines represent switching of classes. 228 (93%) patients remained in their assigned class from day 0 to day 1. 44 (18%) patients switched class from day 1 to 4. 42 (95%) of class switches during this period were improvements of patients from the hyper-inflammatory to hypo-inflammatory subphenotype. Among those consistently assigned to the hyper-inflammatory subphenotype throughout the study period, 32% developed ARDS, significantly more than in the rest of the cohort (10%, p=0.010)

Abbreviations: IL, Interleukin; TNF, Tumor necrosis factor; Ang, Angiotensin; Temp, Temperature; Resp, Respiratory; BMI, Body mass index; SP-D, Surfactant protein D; SBP, Systolic blood pressure; WBC, White blood cells; Hb, Hemoglobin.

References

1. Calfee CS et al. Acute respiratory distress syndrome subphenotypes and differential response to simvastatin: secondary analysis of a randomised controlled trial. *Lancet Respir Med*. 2018 Sep;6(9):691–698. [https://doi.org/10.1016/S2213-2600\(18\)30177-2](https://doi.org/10.1016/S2213-2600(18)30177-2).
2. Kor DJ et al. Effect of Aspirin on Development of ARDS in At-Risk Patients Presenting to the Emergency Department: The LIPS-A Randomized Clinical Trial. *JAMA*. 2016 Jun 14;315(22):2406–14. <https://doi.org/10.1001/jama.2016.6330>.

Topic: Acute respiratory failure and mechanical ventilation.

000318

Impaired metabolic pathways in experimental sepsis-induced myocardial dysfunction: impacts of mitotropes Apelin-13 and Elabela

O. Lesur¹, K. Rego¹, F. Chagnon¹, D. P. Blondin², P. Sarret³, M. Auger-Messier⁴

¹Icu, CRCHUS, Sherbrooke, Canada; ²Medicine, CRCHUS, Sherbrooke, Canada; ³Pharmacology, CRCHUS, Sherbrooke, Canada; ⁴Cardiology, CRCHUS, Sherbrooke, Canada

Correspondence: O. Lesur

Intensive Care Medicine Experimental 2023, **11(Suppl 1)**:000318

Introduction. Metabolic disturbances induced by sepsis include hyperlactatemia with enhanced glycolysis and impaired glucose homeostasis, protein hyper-catabolism, and altered fatty acid (FA) metabolism. Prevalently dysfunctional hearts during the acute phase of septic shock, with unclear preferences for energetic fuels, are usually supported by catecholamine infusions. Amongst alternative candidates to catecholamines, apelinergics apelin-13 (APL-13) and Elabela (ELA) efficiently support myocardial contractile impairment in experimental sepsis and purport to be mitotropes and energy protectors.

Objectives. To establish the impact of apelinergics on cardiac tissue & cardiomyocyte's glucose and fatty acid metabolism and associated key-limiting enzymes in an experimental model of septic shock in rats.

Methods. Sepsis-induced Myocardial dysfunction is induced by Cecal Ligation and Puncture (CLP) -vs sham- in male adult rats chronically i-v infused with saline; APL-13 (15 µg/kg/hr); or ELA (39 µg/kg/hr, respectively) for 18 h. Heart tissues are used to measure major glucose and fatty acid transporters GLUT4 and CD36 expressions by WB, as well as pyruvate dehydrogenase (PDH), carnitine palmitoyl transferase 1 (CPT1) and citrate synthase (CS) enzymatic activities. In addition, adult cardiomyocytes (acm) are isolated from CLP (vs. sham) rats and exposed to APL-13; ELA (1-3 mg/mL, 30 min⁻¹ h) for main transporters GLUT4 and CD36 expressions and associated glucose (2-NBDG) and FA (Bodipy-C16) real-time uptake assays. Oroboros respirometry is additionally studied on fresh heart fibers.

Results. Although apelin receptor (APJ) overall expression is decreased in CLP hearts, the infusion of apelinergics enhances APJ sarcolemmal-to-endosomal distribution in acm (see jpg picture), with potentially increased receptivity. Apelinergics tend to favour (increase) glucose use in normal hearts (i.e., enhanced GLUT4 expression and 2-NBDG uptake). On the opposite, APL-13 -not ELA- rather rises CD36 expression in CLP hearts (+43[27–88] %, p=0.004 vs. sham), and both apelinergics further increase amounts of FA taken up by acm isolated from CLP hearts (APL-13: +30±6%; ELA: +19±9%, p<0.0001 and =0.004 vs. control, respectively). In parallel, CPT1 (FA pathway rate-limiting enzyme) but not PDH (glucose pathway rate-limiting enzyme) activity is further increased by apelinergics (APL-13 p=0.002, ELA, p=0.03 vs. CLP-saline) in CLP hearts, and ELA more specifically reduces the effectiveness of malonyl CoA to inhibit CPT-1 in CLP heart fibers (p=0.05). CLP-induced reduction of CS activity (mitochondrial function) is restored by APL-13 (p=0.002 vs. CLP-saline).

Conclusions. Experimental sepsis shifts the apelinergic-driven dominant metabolic pathway from glucose to FA oxidation in the heart and restores mitochondrial function. Already established improvers of heart function and outcome in experimental sepsis, apelinergics confirm their status of mitotropes.

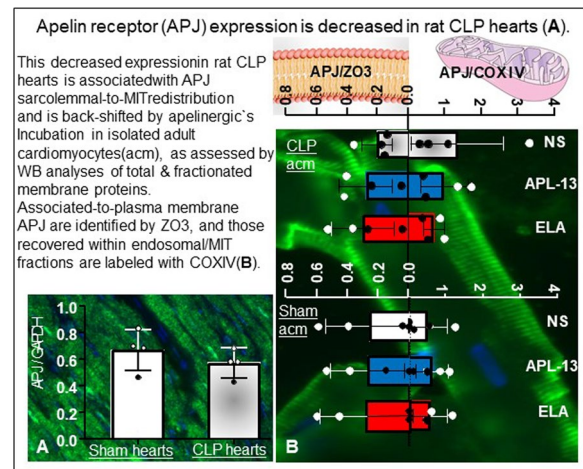

References

1. PMID: 28777197, 25914650, 33060364
2. Canadian Institutes of Health Research (CIHR)—Project Grants (376770, 389979, and 399567), Sepsis Canada CIHR-CMDO structuring project 2022, Dépt de Médecine, FMSS, CHU Sherbrooke.

Topic: Sepsis.

000320

Respiratory failure in patients with solid cancer admitted to a tertiary ICU. The Vall d'Hebron Intensive Care Department/Vall d'Hebron Institute of Oncology (VHIO) cohort

C. Díaz-Lagares¹, J. Ros², A. Garcia-Roche¹, N. Saoudi², A. Pacheco¹, E. Elez², R. Ferrer Roca¹

¹Intensive care department, Vall d'Hebron University Hospital, Barcelona, Spain; ²Oncology Department, Vall d'Hebron University Hospital. VHIO, Barcelona, Spain

Correspondence: C. Díaz-Lagares

Intensive Care Medicine Experimental 2023, **11(Suppl 1)**:000320

Introduction. The number of patients with solid cancer admitted to the ICU is growing, reaching 15% of ICU admissions in some series. Respiratory failure due to infections, lung toxicity and cancer progression is one of the leading causes of critical illness in this population.

Objectives. To describe the cohort of patients with cancer admitted to the ICU due to respiratory failure and to analyse risk factors associated with mortality.

Methods. Ten-year (2010–2019) retrospective study, including consecutive adult patients with solid cancer admitted to the ICU due to respiratory failure. Respiratory failure was defined as PaO₂ < 60 mmHg or SpO₂ < 90%, tachypnea > 30 bpm, or respiratory distress at rest. Chi-Square, Fisher's test, T test, U Mann-Whitney and logistic regression (including all variables with p < 0.1 in the univariate analysis) were employed as appropriate. Quantitative variables are reported as median (IQR) and categorical as frequency (%).

Results. One hundred and ninety-five patients were admitted for respiratory failure during the study period, 122 (62.6%) men, with a mean age of 65 (55–71) years. ECOG 0–1 was present in 137 (70.1%) of the patients. Lung 67 (34.4%), gastrointestinal 50 (25.6%), head and neck 16 (8.2%) and urologic 16 (8.2%) were the most frequently involved cancers. Metastatic disease affected to 109 (55.9%) and neutropenia was present in 13 (7%) patients. The leading cause of respiratory failure was pneumonia 94 (48%). SOFA score was 7 (3–10). On admission, 57 (29%) patients required invasive mechanical ventilation (IMV) and 138 (81%) non invasive respiratory support (low flow oxygen (LFO) 16 (82%), high flow oxygen (HFO) 116 (59.5%) and non-invasive mechanical ventilation (NIMV) 6 (3.1%). One (0.5%) patient treated with LFO and 2 (1%) treated with NIMV required HFO, so 119 (61%) were treated with HFO. Sixty-two (52% of those treated with HFO) were affected by HFO failure (14 patients were not intubated due to a do not intubate order). During the ICU course 109 (55.9%) patients required IMV. One hundred and twenty-nine (66.2%) were treated with vasoactive drugs and 26 (13.3%) required renal replacement therapy (RRT). In-ICU, in-hospital and one year mortality affected to 78 (40%), 102 (52.3%) and 151 (78.7%), respectively. Differences between in-hospital survivors and non-survivors are summarized in table 1. Patients whose performance status was ECOG 0 or 1 had a lower risk for in-hospital mortality (OR: 0.37; CI 95%: 0.18–0.76; p = 0.007) while HFO failure (OR: 6.2; 95% CI: 2.8–13.3; p < 0.001) and mechanical ventilation (OR: 6.2; 95% CI: 2.8–13.3; p < 0.001) were associated with a higher in-hospital mortality.

Table 1 (abstract 000320) Differences between in-hospital survivors and non-survivors

Variables	Survivors (n = 93)	Non-survivors (n = 102)	p-value
Age (years)	66 (55–72)	65 (56–71)	0.385
Lung cancer	27 (29)	40 (39.2)	0.225
Metastatic disease	51 (54.8)	42 (45.2)	0.776
ECOG 0–1	73 (79.4)	64 (62.8)	0.011
SOFA (day 1)	6 (3–9)	7 (3–11)	0.101
Neutropenia	7 (7.6)	6 (6.4)	0.743
Pneumonia	39 (41.9)	55 (53.9)	0.115
VAD	56 (60.2)	73 (71.6)	0.094
RRT	12 (12.9)	14 (13.7)	0.866
IMV	39 (41.9)	72 (70.6)	< 0.001
HFO	57 (56.8)	62 (60.8)	0.942
HFO failure	11 (11.8)	54 (52.9)	< 0.001
Time to IMV (HFO failure)	1 (0–3)	1 (0–5)	0.878

Conclusions. Respiratory failure is still associated with a significant in-hospital mortality, which is not associated with baseline disease, even in metastatic cancer, but with organ failure. Patients requiring invasive respiratory support and those failing on HFO had a higher mortality, so better strategies for optimizing and selecting patients under non-invasive support are needed. A good performance status (ECOG 0–1) had a protective effect.

Topic: Haematologic-oncologic issues in the ICU.

000321

Advanced organ support (ADVOS) in patients with acute-on-chronic liver failure: subgroup analysis of the Registry on Extracorporeal Multiple Organ Support

J. Weinmann-Menke¹, V. Fuhrmann², T. Bingold³, A. Perez Ruiz De Garibay³, A. Faltlhauser⁴, B. Tyczynski⁵, D. Jarczak², M. Sander⁶, S. Kluge²

¹I. Medical clinic and polyclinic, University Medical Center of the Johannes Gutenberg-University Mainz, Mainz, Germany; ²Department of intensive care medicine, University Medical Center Hamburg-Eppendorf, Hamburg, Germany; ³Medical Research, ADVITOS GmbH, München, Germany; ⁴Medical clinic I, Weiden Clinic, Weiden in der Oberpfalz, Germany; ⁵Nephrology, Essen University Hospital, Essen, Germany; ⁶Department of anesthesiology, intensive care medicine and pain therapy, University Hospital Giessen, UKGM, Justus-Liebig University Giessen, Giessen, Germany

Correspondence: A. Perez Ruiz De Garibay

Intensive Care Medicine Experimental 2023, **11(Suppl 1)**:000321

Introduction. Extracorporeal albumin dialysis (ECAD) might be indicated for acute-on-chronic liver failure (ACLF). ADVOS is an advanced ECAD system intended for multiple organ support. The EMOS-Registry (DRKS00017068) collected real world data in patients treated with ADVOS.

Objectives. This analysis of the EMOS-Registry compares the effects of ADVOS in patients with ACLF.

Methods. In this fourth analysis [1], all patients enrolled until close-out were assessed for eligibility. Patients with documented pre-existing liver disease and a complete dataset allowing the calculation of CLIF-C ACLF score were included. Demographic characteristics and surrogate markers before the 1st ADVOS treatment and after the 1st and last ADVOS sessions were analyzed for patients with ACLF 1, 2 and 3. CLIF-C ACLF Score was used to calculate the 1-month standardized mortality ratio (SMR) based on [2] and [3].

Results. 87 patients with documented ACLF before the first ADVOS treatment were included (8 with ACLF 1, 26 with ACLF 2 and 53 with ACLF 3). Significant differences were observed in vasopressor use, hepatic encephalopathy grade and presence of acidosis according to the ACLF grade. 29, 97 and 233 ADVOS sessions were documented, respectively. Median low blood (120–150 ml/min) and concentrates flows (160 ml/min) were set for treatments with a median duration of 16 h. As shown in Table 1, patients with ACLF 3 showed significantly improved values of creatinine, BUN, pH and base excess. The analysis of the CLIF-C ACLF score-standardized mortality rate (SMR) showed a trend towards improved survival in patients with ACLF 3, especially when CLIF-C ACLF score was ≥ 55 . In this group a 31% survival rate was observed, while only 9% was expected [3]. This SMR of 0.76 (0.52–1.00) can be translated into a 22% absolute risk reduction and a number needed to treat (NNT) of 4.6 (Fig. 1). In all patients, few clotting events and 1 bleeding episode were associated with the intervention.

Table 1 (abstract 000321) Course of treatment performance parameters. Median (IQR). *p < 0.05. ** p < 0.01 vs. before 1st ADVOS

Parameter	Before 1st ADVOS	After 1st ADVOS	After last ADVOS
<i>Bilirubin total [mg/dl]</i>			
ACLF 1	2.7 (1.6, 7.2)	3.3 (0.8, 8.5)	5.7 (1.25, 15.8)
ACLF 2	5.6 (2.8, 13.1)	6.1 (3.5, 14.5)	7.8 (3.6, 15.5)
ACLF 3	14.9 (4.8, 25.6)	12.6 (5.1, 22.2)	11.8 (6.1, 18.9)
<i>Creatinine [mg/dl]</i>			
ACLF 1	1.45 (0.77, 1.69)	1.35 (0.5, 2.4)	1.69 (1.69, 0.88)

Parameter	Before 1st ADVOS	After 1st ADVOS	After last ADVOS
ACLF 2	1.85 (0.71, 3.10)	0.92 (0.58, 1.61)*	0.83 (0.68, 1.60)
ACLF 3	1.93 (1.25, 3.92)	1.57 (0.86, 2.60)	1.34 (0.96, 1.80)*
BUN [mg/dl]			
ACLF 1	14 (8, 38)	9 (5, 20)	13 (5, 13)
ACLF 2	32 (18, 52)	17 (12, 28)*	24 (14, 30)
ACLF 3	36 (19, 78)	30 (15, 45)*	25 (14, 36)*
pH			
ACLF 1	7.35 (7.28, 7.45)	7.40 (7.30, 7.47)	7.44 (7.42, 7.49)
ACLF 2	7.37 (7.29, 7.44)	7.45 (7.40, 7.49)*	7.42 (7.38, 7.44)
ACLF 3	7.33 (7.25, 7.41)	7.41 (7.38, 7.46)**	7.40 (7.27, 7.44)
Base Excess [mmol/l]			
ACLF 1	-3.1 (-8.6, 3.3)	0.2 (-0.3, 2.7)	3.6 (1.2, 5.5)
ACLF 2	-2.0 (-7.5, 1.5)	2.1 (0.5, 4.5)*	1.6 (-2.7, 6.1)
ACLF 3	-7.6 (-11.2, 1.4)	0.5 (-4.4, 3.3)**	-1.2 (-8.4, 3.2)*

Conclusions. Results of this subgroup analysis of the EMOS registry are in line with a recent expert consensus reporting that ECAD may improve short-term survival, its efficacy appearing to be correlated with patient selection and intensity of treatment [4]. Patients with ACLF 3 seem to benefit most from the ADVOS therapy. Registry data must be carefully analyzed and should be validated in randomized controlled trials.

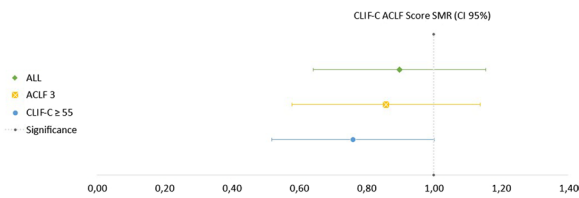

Figure 1 (abstract 000321) CLIF-C Score-standardized 28-day mortality rates. Data for ALL and ACLF 3 are based on expected mortality based on [2]. Data for CLIF-C \geq 55 are based on [3]

References

- [1] Fuhrmann V, et al. *Medicine* (Baltimore). 2021;100.
- [2] Jalan R, et al. *J. Hepatol.* 2014;61(5):1028–47.
- [3] Engelmann C, et al. *Crit Care.* 2019;22(1):254.
- [4] Saliba F, et al. *Intensive Care Med.* 2022;48(10):1352.1367.
- This project has received funding from the European Union's Horizon 2020 research and innovation programme under grant agreement No 880349.

Topic: Metabolism, endocrinology, liver failure and nutrition.

000324

Preoperative renal resistive index is associated with persistent renal dysfunction and major adverse kidney- and cardiovascular events up to 5 years after cardiac surgery

M. Renberg¹, U. Sartipy², M. Bell¹, D. Hertzberg¹

¹Department of Perioperative Medicine and Intensive Care, Karolinska University Hospital, Stockholm, Sweden; ²Department of Cardiothoracic Surgery, Karolinska University Hospital, Stockholm, Sweden

Correspondence: M. Renberg

Intensive Care Medicine Experimental 2023, 11(Suppl 1):000324

Introduction. Renal resistive index (RRI) is a bedside ultrasonographic quantification of renal perfusion obtained by using pulse waved Doppler (Fig. 1). Elevated RRI has shown promise in early prediction of acute kidney injury in critically ill patients and after major surgery, but its role for risk assessment of long-term outcomes in these settings is not known.

Objectives. To investigate the association of preoperative RRI elevation and persistent renal dysfunction, major adverse kidney events (MAKE) and major adverse cardiovascular events (MACE) after cardiac surgery.

Methods. In this observational cohort study, RRI was measured in patients the day before undergoing on-pump cardiac surgery at a Swedish University Hospital. RRI \geq 0.70 was defined as elevated. Persistent renal dysfunction was defined as a decline in estimated glomerular filtration rate \geq 25% compared to the preoperative value that sustained for more than three months. MAKE was a composite of persistent renal dysfunction, renal replacement therapy, or death. MACE was a composite of myocardial infarction, unstable angina, decompensated heart failure, stroke, or cardiovascular death. The Kaplan-Meier method and Cox proportional hazard regression was used to investigate the association between elevated RRI and the outcomes up to five years after surgery.

Results. The study included 96 patients, of which 58 (60%) had elevated preoperative RRI. Five years after surgery persistent renal dysfunction had occurred in 25 patients (26%), MAKE in 34 patients (35%), and MACE in 28 patients (29%). RRI was higher in patients developing persistent renal dysfunction (median RRI 0.78 (interquartile range (IQR) 0.74–0.82) vs 0.70 (IQR 0.66–0.77), $p=0.001$), MAKE (median RRI 0.77 (IQR 0.72–0.81) vs 0.68 (0.65–0.76), $p=0.002$), and MACE (median RRI 0.77 (IQR 0.72–0.81) vs 0.70 (IQR 0.66–0.77), $p=0.006$) compared to those not developing the outcomes. Patients with elevated RRI had higher cumulative incidences of persistent renal dysfunction (log-rank $p<0.001$), MAKE (log-rank $p<0.001$) and MACE (log-rank $p=0.007$) (Fig. 2). After adjusting for multiple preoperative risk factors, elevated RRI was associated with persistent renal dysfunction (adjusted hazard ratio (aHR) 4.73 (95% confidence interval (CI) 1.37–16.2)) and MAKE (aHR 2.83 (95% CI 1.03–7.73)), but not with MACE (aHR 2.37 (95% CI 0.80–7.03)).

Conclusions. Elevated preoperative RRI is associated with persistent renal dysfunction and MAKE after cardiac surgery, with a strong tendency for an association also with MACE. RRI may be used to tailor long-term follow-up of renal- and cardiovascular function in cardiac surgery patients.

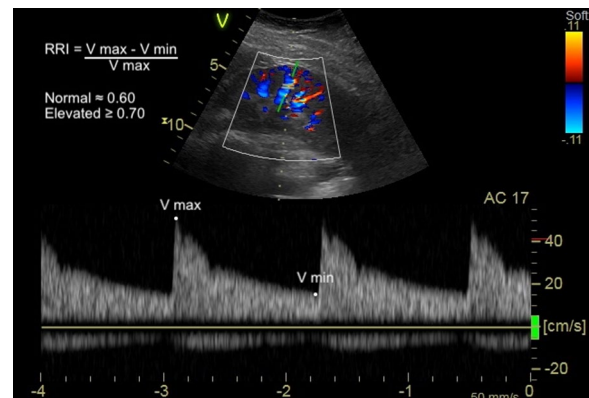

Figure 1 (abstract 000324) Example of how RRI is calculated from Doppler readings of intraparenchymal renal blood flow velocities

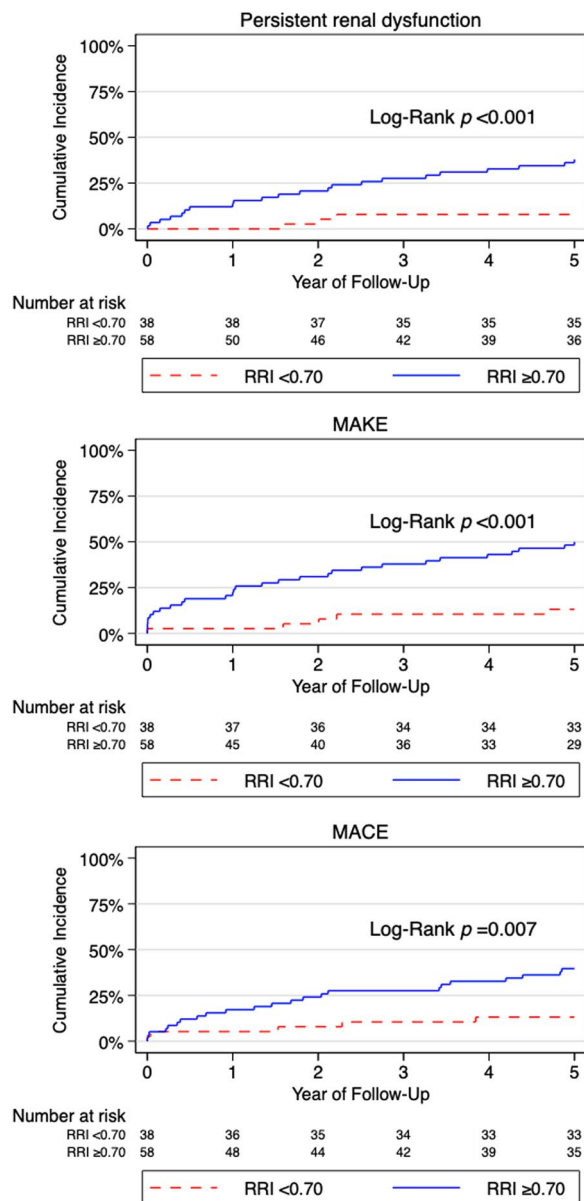

Figure 2 (abstract 000324) Cumulative incidence curves for persistent renal dysfunction, MAKE and MACE in patients with normal and elevated RRI

Topic: Acute Kidney Injury and haemofiltration.

000328

Influence of hiatus of rapid response teams due to COVID-19 pandemic on in-hospital cardiac arrest—a single center observational study

T. Morooka¹, S. Miyahara², T. Haga³, T. Kazuta³, J. Maruyama², K. Nakada⁴, H. Rinka¹

¹Emergency and Critical Care Medical Center, Osaka City General Hospital, Osaka, Japan; ²Department of Medical Security and Patient Safety, Osaka City General Hospital, Osaka, Japan; ³Department of Paediatric Critical

Care Medicine, Osaka City General Hospital, Osaka, Japan; ⁴Department of Critical Care Medicine, Osaka City General Hospital, Osaka, Japan

Correspondence: T. Morooka

Intensive Care Medicine Experimental 2023, 11(Suppl 1):000328

Introduction. Rapid response systems have been implemented with the aim of preventing patient deterioration, in-hospital cardiac arrest (CA) and related deaths. In our hospital, rapid response team (RRT) was introduced in 2012. In early April 2020, COVID-19 outbreak compelled rapid response team to pause due to insufficient staff.

Objectives. To investigate changes in unexpected CA with comparison between RRT-working period and the hiatus period.

Methods. A single center, cohort study of all unexpected CA in two periods. One is one-year period from April 2019 to March 2020 for which RRT was in operation before COVID-19 outbreak. The other is one-year period from May 2020 to April 2021 for which RRT was on hiatus after COVID-19 outbreak. Unexpected CA were identified from the rapid response systems database and patients' case histories were reviewed from their medical records.

Results. The incidence of unexpected CA increased from 24 (0.78/1000 admissions) in RRT-in-operation period to 35 (1.58/1000 admissions) in RRT-on-hiatus period. The median age was 72 (IQR45-79) with 45.8% male in RRT-in-operation period and 75 (IQR68-80.5) with 77.1% male in RRT-on-hiatus period. There were no COVID-19-related CA. The rate of death in unexpected CA was 71% (17/24) in RRT-in-operation period and 80% (28/35) in RRT-on-hiatus period. Any warning signs preceding cardiac arrest were identified in 83% (20/24) in RRT-in-operation period and 71% (25/35) in RRT-on-hiatus period. We investigated which checkpoints for preventing CA were passed from identifying warning signs to appropriate intervention. As shown in the Table, appropriate monitoring, timely recognition of warning signs, timely communication with physicians and appropriate intervention were seen in 71%, 42%, 50% and 38%, respectively in RRT-in-operation period. On the other hand, each checkpoint pass rates decreased to 57%, 31%, 26% and 11% in RRT-on-hiatus period, respectively.

Conclusions. Unexpected CA increased on the hiatus of RRT. Several checkpoints involved with afferent component including monitoring, recognition of warning signs and communication with physicians were not passed in many cases in RRT-on-hiatus period, indicating that vigorous education about afferent component for general ward staffs was necessary. Furthermore, it was suggested that RRT activity itself was critical for appropriate intervention for preventing CA.

Table (abstract 000328) Comparison of unexpected cardiac arrest between RRT-in-operation period and RRT-on-hiatus period. CA: cardiac arrest

RRT activity	in operation	on hiatus
unexpected CA	24	35
death	17 (71%)	28 (80%)
presence of warning signs preceding CA	20 (83%)	25 (71%)
appropriate monitoring	17 (71%)	20 (57%)
timely recognition of warning signs	10 (42%)	11 (31%)
timely communication with physicians	12 (50%)	9 (26%)
appropriate intervention preceding CA	9 (38%)	4 (11%)

Topic: Cardiac arrest.

000329

Kidney function parameters combined with cell cycle arrest biomarkers identify different subphenotypes of septic-shock-associated Acute Kidney Injury. A post hoc analysis (PHENAKI)

D. Titeca Beauport¹, M. Diouf², D. Daubin³, V. Ly Van⁴, G. Belliard⁵, C. Bruel⁶, Y. Zerbib¹, C. Vinsonneau⁷, K. Klouche³, J. Maizel¹

¹Medical Intensive Care Unit and EA7517, Boreal Study Group, University hospital, Amiens, France; ²Biostatistics, CHU Amiens-Picardie, Amiens,

France; ³Department of Intensive Care, PhyMedExp, University of Montpellier, INSERM, CNRS, Lapeyronie University Hospital, Montpellier, France; ⁴Intensive care unit, Groupe Hospitalier Sud Ile de France, Melun, France; ⁵Medical-Surgical Intensive Care Unit, Gh Bretagne Sud, Lorient, France; ⁶Medical and Surgical Intensive Care Unit, Hospital Paris Saint-Joseph, Paris, France; ⁷Intensive care unit, Hospital Center Of Béthune Beuvry, Beuvry, France

Correspondence: D. Titeca Beauport
Intensive Care Medicine Experimental 2023, 11(Suppl 1):000329

Introduction. Sepsis-associated acute kidney injury (SA-AKI) severity and trajectory correlated with mortality. Early recognition of different subphenotypes of SA-AKI could help to customize their management during the first stage of care. In this line, Acute Dialysis Quality Initiative (ADQI) expert panel suggest that combine kidney stress/damage biomarkers with kidney function parameters, could help to better characterize AKI and help physician to early individualize particular phenotypes of patients in view to customize their management during the first stage of care.

Methods. In this post hoc analysis of prospective multicenter study. We combined kidney function parameters: prior serum creatinine (SCr) and eGFR, SCr at inclusion (0 h) and 24 h, blood urea nitrogen at 0 h, weight-corrected urine output (UO) at 0 h, 6 h, 12 h and 24 h with serial measures of urine [TIMP-2]*[IGFBP7] at 0 h, 6 h, 12 h and 24 h; using an unsupervised hierarchical clustering of principal components approach; to identify different phenotypes of SA-AKI. We compared start of RRT and seven-day survival rates in the different subphenotypes.

Results. One hundred and eighty-four patients presenting SA-AKI within the first six hours of septic shock diagnosis were included. Three distinct subphenotypes were identified: subphenotype A (99 patients) characterized by conserved UO, low SCr and low [TIMP-2]*[IGFBP7] level, subphenotype B (74 patients) characterized by prior chronic kidney dysfunction, higher SCr, low UO, intermediate [TIMP-2]*[IGFBP7] level and subphenotype C characterized by very low UO and very high [TIMP-2]*[IGFBP7] level. Renal replacement therapy was initiated within the first seven days in four (4%), 27 (36%) and three (27%) patients of sub-phenotype A, B and C, respectively ($p < 0.001$). After adjustment for confounding factor, seven-day survival rate [95% CI] was respectively of 88% [80–96], 80% [72–88] and 75% [56–94] in the subphenotype A, B and C. With subphenotype A as reference, the adjusted hazard-ratio [95%CI] for seven-day mortality was 1.53 [0.76–3.08]; $p = 0.24$ in the subphenotype B and 5.90 [2.04–17.07]; $p = 0.001$ in the subphenotype C.

Conclusions. Combining classical kidney function indicators to a cell-cycle arrest urine biomarker, we identified three distinct subphenotypes of SA-AKI, with different short-term trajectory and survival rate. This could be useful to better stratify patients at the early phase of septic shock, but need to be confirm in an independent and larger cohort.

Topic: Acute Kidney Injury and haemofiltration.

000330

Respiratory muscle hibernation in mechanically ventilated ICU patients: Super-relaxed myosins contribute to contractile weakness of the diaphragm and novel slow and fast skeletal muscle troponin activators restore contractility

M. van den Berg¹, Z. Shi², W. Claassen¹, A. Girbes², S. Stapel², A. Beishuizen³, J. Ochala⁴, L. Heunks⁵, C. Ottenheijm¹

¹Physiology, Amsterdam UMC, location VUmc, Amsterdam, Netherlands;

²Intensive care medicine, Amsterdam UMC, location VUmc, Amsterdam, Netherlands;

³Intensive care, MST, Enschede, Netherlands; ⁴Biomedical sciences, Copenhagen University, København, Denmark; ⁵Intensive Care, Erasmus University Medical Center, Rotterdam, Netherlands

Correspondence: W. Claassen
Intensive Care Medicine Experimental 2023, 11(Suppl 1):000330

Introduction. Intensive care unit (ICU) patients frequently develop contractile weakness of the diaphragm, the main muscle of inspiration. ICU patients with diaphragm weakness are at much higher risk for difficult weaning from the mechanical ventilator, which contributes to mortality and poses a high economic burden (1). Due to a lack of knowledge regarding the molecular changes in the diaphragm, no pharmacological treatment is available to improve diaphragm contractility.

Methods. We compared diaphragm biopsies from ventilated ICU patients (N = 54) to those of non-ICU patients (N = 27) and integrated ultrastructural, biophysical, biochemical and clinical data. Furthermore, we studied quadriceps muscle biopsies of mechanically ventilated patients and the diaphragm in mechanically ventilated rats to elucidate the role of unloading due to mechanical ventilation opposed to critical illness.

Results. In diaphragm myofibers of ventilated ICU patients, the key contractile protein myosin is trapped in the energy-sparing, super-relaxed state. This state impairs the binding of myosin to actin during diaphragm contraction. Proteomics studies indicate that super-relaxed myosins in the diaphragm are evoked by dephosphorylation of myosin regulatory light chains, and studies in ventilated rats identified contractile inactivity of the diaphragm as a cause of myosin light chain dephosphorylation. Increased super-relaxed myosins were not found in myofibers of leg muscles of ICU patients. We re-activated the contractile proteins in diaphragm myofibers from ventilated ICU patients with novel small molecule compounds targeting another contractile protein, troponin, and this restored the contractile force to normal levels.

Conclusions. In conclusion, our results reveal a new pathomechanism underlying diaphragm contractile weakness in ventilated ICU patients, i.e., an increased population of SRX myosins due to hypophosphorylation of RLCs. We also show that novel small molecule compounds restore physiological force levels.

References

1. This research used resources of the Advanced Photon Source, a U.S. Department of Energy (DOE) Office of Science User Facility operated for the DOE Office of Science by Argonne National Laboratory under Contract No. DE-AC02-06CH11357
2. Carlsberg Foundation (CF20-0113)
3. Novo Nordisk Foundation (NNF0070539)
4. Medical Research Council UK (MR/S023593/1),
5. ZonMW Grant 09120011910004
6. Supported by NHLBI grant HL-121500
7. Dres, M., Goligher, E.C., Heunks, L.M.A. et al. Critical illness-associated diaphragm weakness. *Intensive Care Med* 43, 1441–1452 (2017)

Topic: Translational Medicine.

000331

Association of CT hypotension complex in early mortality in patients with traumatic Injury

H. Jang¹, J. E. Lee²

¹Division of Trauma, Department of Surgery, Chonnam National University Hospital, Gwangju, Republic of Korea; ²Department of Radiology, Chonnam National University Medical School, Gwangju, Republic of Korea

Correspondence: H. Jang
Intensive Care Medicine Experimental 2023, 11(Suppl 1):000331

Introduction. The association between CT hypotension complex findings reflected in initial contrast-enhanced CT and early mortality or prediction of massive transfusion is not well known.

Objectives. To evaluate the usefulness of initial contrast-enhanced CT findings for predicting early mortality and/or massive transfusion in patients with traumatic injury.

Methods. We retrospectively reviewed patients with traumatic injury who visited a single tertiary trauma center between January 2020 and December 2021. Patients with injury severity score under 9, patients who expired 7 days after arriving at the emergency department, or patients who did not undergo initial contrast-enhanced CT were excluded. The subjective CT hypotension complex findings values of abdominal solid organs including liver, spleen, pancreas, kidneys, adrenal glands, thickened bowel loops finding and the diameters of the abdominal aorta and inferior vena cava were used to evaluate the association with mortality.

Results. Of 432 patients with traumatic injury 250 patients were included. Twenty-one patients died within 7 days of admission and 229 patients survived until 30 days of admission. When analyzed the 8 variables by multiple regression analysis adjusting by stepwise regression, hypo-enhancement of spleen (OR 17.09, 95% CI; [4.89–62.13] $p < 0.001$) and IVC diameter (OR 0.85, 95% CI; [0.73–0.98] $p = 0.034$) were related to 7 days mortality. Of the 8 variables collected on initial contrast-enhanced CT scan, thickened bowel loops (OR 6.26, 95% CI; [1.52–26.12] $p = 0.01$), and IVC AP diameter (OR 0.85, 95% CI; [0.75–0.97] $p = 0.017$), showed the correlation with prediction of massive transfusion.

Conclusions. In patients with traumatic injury, the contrast-enhanced CT hypotension complex can help predict the patient's prognosis by reflecting the hypovolemic state as well as evaluating the extent of trauma. Among these complexes, hypo-enhancement of spleen and IVC diameter findings can predict the early mortality of trauma patients, and thickened bowel loops and IVC AP diameter can be feasible for predicting massive transfusion.

Table 1 (abstract 000331) Characteristics of patients

Death	No (N=229)	Yes (N=21)	p
Age	52.5 ± 18.3	61.8 ± 20.7	0.029
Sex			
- F	54 (23.6%)	7 (33.3%)	0.465
- M	175 (76.4%)	14 (66.7%)	
Thickened bowel loops 3mm with enhancing walls			
(-)	223 (97.4%)	16 (76.2%)	< 0.001
(+)	6 (2.6%)	5 (23.8%)	
Shock pancreas heterogeneous enhancement with peripancreatic fluid			
(-)	227 (99.1%)	17 (81.0%)	< 0.001
(+)	2 (0.9%)	4 (19.0%)	
Hypoenhancement of the spleen			
(-)	220 (96.1%)	8 (38.1%)	< 0.001
(+)	9 (3.9%)	13 (61.9%)	
Hypoenhancement of the liver 25 HU less than the spleen			
(-)	225 (98.3%)	17 (81.0%)	< 0.001
(+)	4 (1.7%)	4 (19.0%)	
Hyperenhancing kidneys			
(-)	209 (91.3%)	19 (90.5%)	1.000
(+)	20 (8.7%)	2 (9.5%)	
Bilateral adrenal gland hyperenhancement			
(-)	218 (95.2%)	15 (71.4%)	< 0.001
(+)	11 (4.8%)	6 (28.6%)	
Abdominal aorta AP diameter mm.	16.5 ± 2.7	15.8 ± 3.7	0.419
IVC AP diameter mm.	12.1 ± 4.1	7.3 ± 3.6	< 0.001
Albumin	3.5 ± 0.6	2.8 ± 0.6	< 0.001
Lactate	3.6 ± 2.6	9.5 ± 4.7	< 0.001
Inotropics			
(-)	176 (76.9%)	2 (9.5%)	< 0.001
(+)	53 (23.1%)	19 (90.5%)	
CPR			
(-)	228 (99.6%)	10 (47.6%)	< 0.001
(+)	1 (0.4%)	11 (52.4%)	
sBP	100.3 ± 26.7	71.5 ± 20.9	< 0.001
Transfusion 24hrs pRBC	2.9 ± 4.5	9.1 ± 10.7	0.015
Massive transfusion			
(-)	213 (93.0%)	13 (61.9%)	< 0.001
(+)	16 (7.0%)	8 (38.1%)	
Transfusion 24hrs FFP	2.4 ± 4.3	7.2 ± 8.9	0.024
Transfusion 24hrs PC	1.1 ± 3.2	2.7 ± 5.6	0.231
Chest AIS			
- 0	73 (31.9%)	6 (28.6%)	
- 2	34 (14.8%)	3 (14.3%)	0.657
- 3	105 (45.9%)	9 (42.9%)	
- 4	13 (5.7%)	3 (14.3%)	
- 5	4 (1.7%)	0 (0.0%)	
Abd AIS			
- 0	35 (15.2%)	5 (28.6%)	
- 2	56 (24.5%)	2 (9.5%)	0.060
- 3	80 (34.9%)	5 (23.8%)	
- 4	51 (22.3%)	6 (28.6%)	
- 5	7 (3.1%)	2 (9.5%)	
ISS	20.5 ± 7.9	28.7 ± 14.0	0.015

pRBC, packed red blood cells; sBP, systolic blood pressure; AIS, Abbreviated Injury Scale; ISS, Injury Severity Score;

Table 2 (abstract 000331) CT hypotension complex findings reflected in early mortality; multiple regression analysis and finally selected model

	univariate analysis		multivariate analysis		final selected model	
	OR(95% CI)	p	OR(95% CI)	p	OR(95% CI)	p
Thickened bowel loops 3mm with enhancing walls	11.61 (3.06-42.85)	< 0.001	2.74 (0.03-20.42)	0.340		
Shock pancreas: Heterogeneous enhancement with peripancreatic fluid	26.71 (4.86-202.93)	< 0.001	4.33 (0.27-67.91)	0.291	6.95 (0.69-83.19)	0.111
Hypoenhancement of the spleen	39.72 (13.63-126.55)	< 0.001	20.16 (5.15-86.00)	< 0.0001	17.09 (4.89-62.13)	< 0.001
Hypoenhancement of the liver 25 HU less than the spleen	13.24 (2.91-60.65)	< 0.001	0.83 (0.08-8.85)	0.862		
Hyperenhancing kidneys	1.10 (0.17-4.18)	0.903				
Bilateral adrenal gland hyperenhancement	7.93 (2.45-24.06)	< 0.001	2.87 (0.46-15.46)	0.237		
Abdominal aorta AP diameter mm.	0.92 (0.78-1.08)	0.282				
IVC AP diameter mm.	0.74 (0.64-0.84)	< 0.001	0.89 (0.75-1.04)	0.146	0.85 (0.73-0.98)	0.034

Table 3 (abstract 000331) CT hypotension complex findings reflected in massive transfusion; multiple regression analysis and finally selected model

	univariate analysis		multivariate analysis		final selected model	
	OR(95% CI)	p	OR(95% CI)	p	OR(95% CI)	p
Thickened bowel loops 3mm with enhancing walls	14.73 (4.07-55.84)	< 0.001	6.04 (1.11-33.51)	0.035	6.26 (1.52-26.12)	0.010
Shock pancreas: Heterogeneous enhancement with peripancreatic fluid	10.62 (1.87-60.60)	0.005	1.13 (0.10-10.68)	0.918		
Hypoenhancement of the spleen	7.57 (2.69-20.60)	< 0.001	2.81 (0.71-10.68)	0.132	2.73 (0.77-9.10)	0.108
Hypoenhancement of the liver 25 HU less than the spleen	6.31 (1.23-27.63)	0.016	0.79 (0.08-5.89)	0.825		
Hyperenhancing kidneys	1.56 (0.35-5.06)	0.504				
Bilateral adrenal gland hyperenhancement	4.69 (1.38-14.19)	0.008	1.13 (0.20-5.09)	0.885		
Abdominal aorta AP diameter mm.	0.83 (0.71-0.97)	0.020	0.88 (0.76-1.03)	0.112	0.89 (0.76-1.03)	0.116
IVC AP diameter mm.	0.79 (0.70-0.88)	< 0.001	0.86 (0.74-0.98)	0.024	0.85 (0.75-0.97)	0.017

Topic: Trauma.

000332

The relationship between dyspnea and respiratory effort in mechanically ventilated patients

C. Hatozaki¹, H. Sakuramoto², G. Aikawa³, S. Kobayashi⁴, T. Hoshino⁵, Y. Inoue⁶

¹Intensive care unit, University of Tsukuba Hospital, Tsukuba, Japan; ²Department of Critical care and Disaster Nursing, Japanese Red Cross Kyushu International College of Nursing, Munakata, Japan; ³Department of Adult Health Nursing, College of Nursing, Ibaraki Christian University, Hitachi, Japan; ⁴Pediatric Intensive Care Unit, University of Tsukuba Hospital, Tsukuba, Japan; ⁵Department of Emergency and Critical Care Medicine, University of Tsukuba Hospital, Tsukuba, Japan; ⁶Department of Emergency and Critical Care Medicine, Faculty of Medicine, University of Tsukuba, Tsukuba, Japan

Correspondence: C. Hatozaki

Intensive Care Medicine Experimental 2023, 11(Suppl 1):000332

Introduction. Recently, it has been suggested that patients with high respiratory effort during mechanical ventilation (MV) may induce lung injury. Therefore, proper control of respiratory effort in patients on MV is considered important for the prevention of lung injury. In addition, as a general clinical indicator, patients with high respiratory effort are often considered to be associated with dyspnea. However, the relationship between dyspnea and respiratory effort has not been clarified yet.

Objectives. The primary objective of this study was to examine the relationship between three dyspnea rating scales and respiratory effort in patients undergoing MV.

Methods. We performed a prospective observational study of patients admitted to intensive care unit (ICU) of the University Hospital in Japan between February 2020 and March 2022. Patients who were at least 20 years old and expected to require MV for more than 24 h were included in this study. Dyspnea was measured using Respiratory Distress Observation Scale (RDOS), Intensive Care Respiratory Distress Observation Scale (IC-RDOS), and Mechanical Ventilation Respiratory Observation Scale (MV-RDOS). Respiratory effort was measured using airway occlusion pressure: the negative pressure at the start of spontaneous inspiration (the first 0.1 s) (P 0.1). Measurements were performed at a maximum of 2 points between the ICU admission day and day 4. Measurements were performed independently by two investigators, who were blinded to each other's data. Pearson's correlation coefficients (r) were used to examine relationships between variables.

Results. A total of 253 patients were eligible, 122 were excluded, and finally 131 were included in the study. Of the included patients, 69 patients on MV were able to measure P 0.1 and were included in the statistical analysis. Data including total 105 observation points from the 69 patients were collected. Low negative correlation were confirmed between RDOS, IC-RDOS, MV-RDOS, and P 0.1 ($r = -0.293$, $p = 0.003$; $r = -0.240$, $p = 0.014$; $r = -0.260$, $p = 0.008$, respectively) (Fig. 1). Stratified analysis by baseline disease, severity, and depth of sedation showed that RDOS, IC-RDOS, MV-RDOS, and P 0.1 had a low negative correlation only in the deep sedation group ($r = -0.347$, $p = 0.020$; $r = -0.325$, $p = 0.029$; $r = -0.352$, $p = 0.018$, respectively) (Fig. 2). This correlation tended to be stronger compared to all patients. On the other hand, no significant correlations were demonstrated in the other stratified analyses.

Conclusions. Dyspnea and respiratory effort showed a low negative correlation in patients using MV. This correlation was stronger in the analysis of the deep sedation group only. It was suggested that depth of sedation may have affected the correlation between dyspnea and respiratory effort.

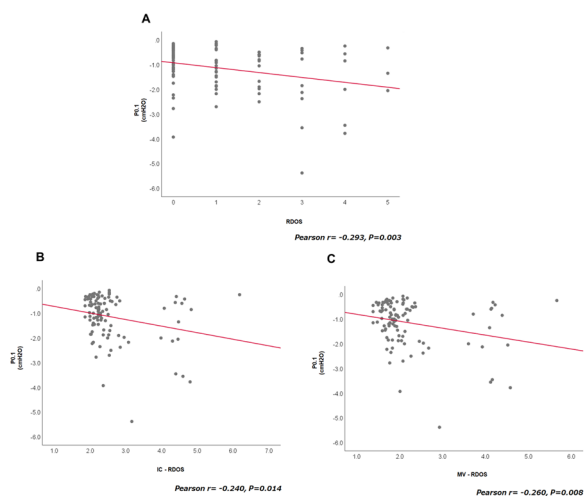

Figure 1 (abstract 000332) The correlation coefficients between three dyspnea rating scales and P0.1. A: correlation coefficients

between RDOS and P0.1; B: correlation coefficients between IC-RDOS and P0.1; C: correlation coefficients between MV-RDOS and P0.1

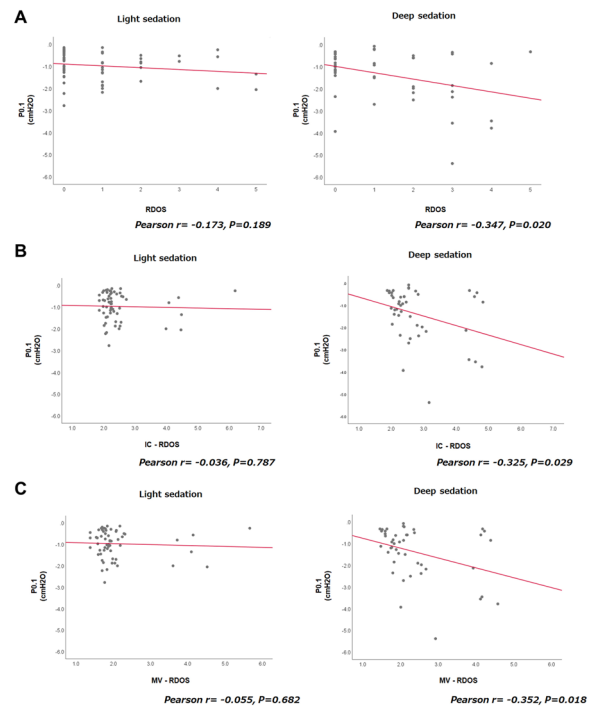

Figure (abstract 000332) The correlation coefficients between three dyspnea rating scales and P0.1 by depth of sedation. A: correlation coefficients between RDOS and P0.1; B: correlation coefficients between IC-RDOS and P0.1; C: correlation coefficients between MV-RDOS and P0.1

References

- 1) Telias I, Damiani F, Brochard L. The airway occlusion pressure (P 0.1) to monitor respiratory drive during mechanical ventilation: increasing awareness of a not—so—new problem. *Intensive Care Med* 2018 Sep;44(9):1532–1535.
- 2) Campbell ML, Templin T, Walch J. A Respiratory Distress Observation Scale for Patients Unable to Self-Report Dyspnea. *J Palliat Med* 2010 Mar;13(3):285–90.
- 3) Persichini R, Gay F, Schmidt M, et al. Diagnostic Accuracy of Respiratory Distress Observation Scales as Surrogates of Dyspnea Self-report in Intensive Care Unit Patients. *Anesthesiology* 2015 Oct;123(4):830–837.
- 4) Decavèle M, Gay F, Persichini R, et al. The Mechanical Ventilation-Respiratory Distress Observation Scale as a surrogate of self-reported dyspnoea in intubated patients. *Eur Respir J* 2018 Oct 10;52(4):1,800,598.
- 5) None

Topic: Acute respiratory failure and mechanical ventilation.

000333

Eleven years of implementation of selective digestive decontamination in a mixed ICU: impact on nosocomial multidrug-resistant infection, antibiotic consumption and colistin and tobramycin colonization

C. Sánchez Ramírez¹, S. Hipola Escalada¹, L. Lara Franco¹, M. Tout Castellano¹, L. Roldán Furelos¹, R. E. Morales Sirgado¹, M. A. Hernández Viera¹, M. D. L. Á. Sosa Durr¹, A. López Domínguez¹, M. Cabrera

Santana¹, A. Padrón Mujica¹, N. Sangil Monroy², P. Saavedra-Santana³, S. Ruiz-Santana¹

¹Intensive care medicine, University Hospital of Gran Canaria Dr. Negrin, Las Palmas de Gran Canaria, Spain; ²Pharmacy department, University Hospital of Gran Canaria Dr. Negrin, Las Palmas de Gran Canaria, Spain; ³Mathematics and informatics department, University of Las Palmas: Las Palmas de Gran Canaria, Spain

Correspondence: C. Sánchez Ramírez

Intensive Care Medicine Experimental 2023, **11(Suppl 1)**:000333

Introduction. Selective digestive decontamination (SDD) has been associated with a reduction in mortality and ICU-acquired infection (NI) rates. However, the effect SDD in areas where multidrug-resistant Gram-negative bacteria (MRGNB) are endemic is of great interest.

Objectives. To analyze the impact on MRGNB NI, antibiotic consumption and colistin and tobramycin colonization in patients with NI in an ICU after 11 years of SDD.

Methods. This study was conducted in a 30-bed-medical-surgical ICU. All consecutive patients admitted to the ICU between October 1, 2011 and September 30, 2022 who were expected to require tracheal intubation > 48 h were administered SDD (SDD study group) with a 4-day course of intravenous cefotaxime plus enteral colistin, tobramycin, nystatin in an oropharyngeal paste and digestive solution. Oropharyngeal and rectal swabs were obtained on admission and once a week. We used ENVIN NI criteria. All patients admitted to ICU with NI in ICU between October 1, 2010 and September 30, 2011 (non-SDD group) were compared with the SDD study group. A univariate and a multivariate logistic regression analysis were performed. For each of the NIs, incidences per 1000 days of exposure in each cohort and the corresponding relative risks were obtained using Poisson regression. Statistical significance was $p \leq 0.05$. Colistin- and tobramycin-resistant colonization and antibiotic consumption as defined daily doses of antibiotics (DDD) were also analyzed.

Results. The results are shown in Tables 1, 2 and 3. A total of 12,016 were admitted to ICU, 990 patients developed NI and 780 of them who received SDD. There were no statistically significant differences between the two groups in terms of admission type or demographics. SDD patients had significantly fewer Extended Spectrum Betalactamase (ESBL) infections $p = 0.015$, Gram Negative Multidrug Resistant Bacteria (GNB-MR) $p = 0.002$ and *Acinetobacter spp.* infections $p < 0.001$. There was also a significant reduction in the rates of ventilator-associated pneumonia (VAP), urinary tract infections, other secondary bacteremia and multidrug-resistant bacteria infections (MR-GNB) in the SDD group versus the non-SDD group. There was no *Clostridium difficile* infection. Colistin-resistant colonization was 18.9% and tobramycin-resistant colonization was 27.8% of samples. There was a decrease in DDD/100 ICU stays after SDD.

Conclusions. After eleven years of SDD implementation, a significant reduction in ESBL, GNB-MR and *Acinetobacter* infections was persistently observed. A significant decrease in the rates of VAP, secondary bacteremia, urinary tract infections and MRNI was also observed. A reduction in antibiotic consumption was observed after SDD. Low rates of colonization by colistin- and tobramycin-resistant bacteria were also observed throughout these years.

Table 2 (abstract 000333) Multivariate analysis SDD 11 years

	p-value	Odd-Ratio (95% CI)
VAP	< .001	0.476 (0.312,0.727)
COPD	0.012	2.560 (1.230,5.325)
Renal failure	< .001	0.387 (0.246,0.611)
Acinetobacter infections	< .001	0.092 (0.035,0.240)

SDD: Selective Digestive Decontamination; VAP: ventilator associated pneumonia; COPD: chronic obstructive pulmonary disease

Table 3 (abstract 000333) NI rates SDD 11 years

		SDD			Relative Risk (95% CI)
		No	Yes	p-value	
VAP / MV	VAP/1000 days of MV	10.31	3.88	< 0.001	0.376 (0.286 - 0.495)
Urinary infections	Infections/1000 days of catheter	3.79	2.43	0.017	0.642 (0.446 - 0.923)
Bacteremia related to catheter	Bacteremia/1000 days of CVC	3.59	3.70	0.879	1.031 (0.692 - 1.537)
Secondary bacteremia	Bacteremia /1000 ICU days	4.69	2.10	<0.001	0.488 (0.323 - 0.620)
Multiresistant germs	Multiresistant germs/1000 ICU days	9.59	2.76	<0.001	0.288 (0.227 - 0.365)

SDD: Selective Digestive Decontamination; VAP: ventilator associated pneumonia; MV: mechanical ventilation; CVC: central venous catheter.

Table 1 (abstract 000333) Univariate analysis SDD 11 years

	No SDD N = 110	SDD N = 780	p-value
Age, years	59.5 ± 15.8	61.3 ± 14.1	0.211
APACHE II score	21.2 ± 7.7	20.7 ± 7.7	0.602
Sex male	74 (67.3)	514 (68.0)	0.983
Trauma patients	17 (15.4)	77 (9.9)	0.069
Coronary artery disease patients	19 (17.3)	165 (21.1)	0.369
Emergency surgery	34 (30.9)	186 (23.9)	0.147
Immunosuppression	8 (7.3)	84 (12.2)	0.136
Neutropenia	3 (2.7)	27 (3.9)	0.787
Immunodepression	3 (2.7)	3 (0.4)	0.037
Parenteral nutrition	26 (23.6)	153 (22.1)	0.727
RRT	34 (30.9)	72 (9.2)	0.529
Malnutrition	12 (11.0)	72 (9.2)	0.529
Diabetes mellitus	34 (30.9)	239 (30.6)	0.9
COPD	9 (8.2)	131 (16.8)	0.022
Renal failure	40 (36.4)	140 (17.9)	< .001
Cirrhosis	6 (5.5)	34 (4.9)	0.792
Neoplasm	10 (9.1)	62 (9.0)	0.964
VAP	59 (53.6)	270 (34.6)	< .001
CRB	26 (23.6)	298 (38.3)	0.003
Secondary bacteremia	31 (28.2)	198 (25.4)	0.504
Urinary infection	29 (26.4)	209 (26.8)	0.967
ATB 48 hours before admission	28 (25.4)	209 (27.7)	0.657
Death	36 (32.7)	278 (35.6)	0.475
<i>Acinetobacter baumannii</i>	13 (11.8)	8 (1.0)	< .001
MRSA	4 (3.6)	12 (1.5)	0.121
ESBL	38 (34.5)	188 (24.1)	0.015
MR <i>Pseudomonas</i>	10 (9.1)	63 (8.1)	0.659
MR GNB	12 (10.9)	33 (4.2)	0.002
Admission			0.35
Medical	79 (71.8)	564 (72.3)	
Scheduled surgery	10 (9.1)	81 (13.6)	
Emergency surgery	21 (19.1)	110 (14.1)	
Inflammatory response:			0.865
Non sepsis	2 (1.8)	27 (3.5)	
Sepsis	23 (20.9)	151 (19.3)	
Septic shock	85 (77.3)	603 (77.2)	
ICU days	28 (16 : 44.8)	34.0 (21 : 54)	0.003

Data are means SD and frequencies (%). RRT: Renal replacement therapy; VAP: ventilator associated pneumonia; CRB: Catheter related bacteremia; ATB: antibiotic; COPD: chronic obstructive pulmonary disease; MRSA: methicillin resistant *Staphylococcus aureus*; ESBL: extended spectrum beta-lactamase; MR: multiresistant; GNB: gram negative bacteria.

Topic: Infections and prevention.

000334

Quantitative assessment of carotid diameter measurements in parallel versus rotated and tilted orientation using ultrasound in the operating room—a comparative analysis

E. C. de Boer¹, C. Dinis Fernandes¹, D. Van Neerven², C. Pennings², R. Joshi³, S. Manzari³, S. Shulepov⁴, L. Van Knippenberg¹, J. Van Rooij⁵, R. A. Bouwman⁶, M. Mischi¹

¹Electrical Engineering, Eindhoven University of Technology, Eindhoven, Netherlands; ²Anesthesiology, UMC+, Maastricht, Netherlands; ³Patient Care and Measurements, Philips Engineering Solutions, Eindhoven, Netherlands; ⁴Multiphysics Models of Devices, Philips Engineering Solutions, Eindhoven, Netherlands; ⁵Equipment Development, Philips Engineering Solutions, Eindhoven, Netherlands; ⁶Anesthesiology, Catharina Ziekenhuis, Eindhoven, Netherlands

Correspondence: E.C. de Boer

Intensive Care Medicine Experimental 2023, 11(Suppl 1):000334

Introduction. Hemodynamic monitoring is of utmost importance when treating critically ill patients, but the currently used techniques are invasive and related with catheter-related complications. Over the last two decades, carotid artery ultrasound (US) was investigated as a non-invasive alternative for hemodynamic monitoring, including cardiac output estimation. Both vessel diameter and blood velocity are needed to compute blood flow in a vessel. Traditionally, carotid flow measurements are performed with the US probe oriented in the long-axis (LA) view [1]. Assuming a circular cross-section of the vessel and a parabolic flow profile, the probe should be properly positioned along the mid-axis to obtain an accurate blood flow estimation. However, obtaining and maintaining this mid-axis parallel view is difficult and literature describes that operator experience may impact the reliability of carotid flow measurements [2]. While the short-axis (SA) view allows for measurement of the true diameter, it does not allow for velocity estimation as the Doppler frequency shift approaches 0 degrees. Another way of assessing the cross-section of the carotid artery is by rotating and tilting (RT) the probe, a view that is easier to visualize and assess for sonographers. Regarding velocity measurements, preliminary research showed that the RT view was more robust to motion and less operator-dependent than the LA view [3]. To our knowledge, there is no literature regarding clinical diameter estimates with the RT view.

Objectives. To evaluate the use of the RT view in a clinical setting, and to compare it with the LA and SA views using systolic diameter and spread of systolic diameter estimates per acquisition. The spread of systolic diameter values serves as a measure of robustness.

Methods. We performed 30 s US acquisitions of the carotid artery in adult cardiac surgery patients, with a LA, SA, and RT probe orientation. The 30 s US recordings were analyzed to derive a diameter waveform. From this, we computed the systolic diameter values and a measurement of spread (calculated as the IQR of the systolic diameter estimates per acquisition) and investigated for potentially significant differences between views.

Results. US acquisitions were performed in 29 patients. The median systolic diameter (IQR) per 30 s acquisition was 7.08 (1.59) mm, 7.22 (1.20) mm, and 6.95 (1.77) mm for the LA, SA, and RT views, respectively (Fig. 1). The median spread (IQR) per 30 s acquisition was 0.12 (0.13) mm, 0.10 (0.10) mm, and 0.09 (0.10) mm for the LA, SA, and RT views, respectively. Normality was checked using the Shapiro-Wilk test and Friedman tests showed no statistically significant difference between the views for either the median ($p=0.142$) or spread ($p=0.786$) of systolic diameter per 30 s acquisition.

Conclusions. It was feasible to acquire data and derive diameter estimates using the three probe orientations. The median and spread in systolic diameter values per 30 s acquisition were comparable for the LA, SA, and RT views, suggesting that the different views result in evenly robust measurements and can be used interchangeably to obtain diameter estimates. This study opens the path for further investigation of the newly introduced RT view for new applications and possibilities, such as hands-free measurements.

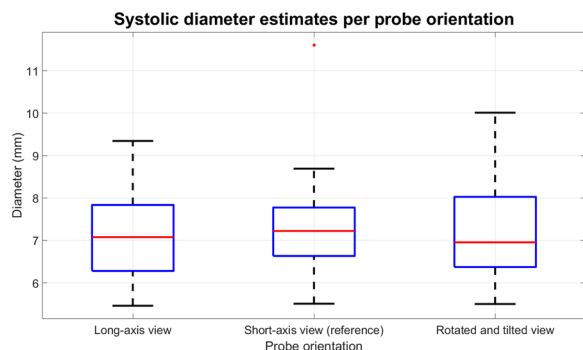

Figure (abstract 000334) Boxplot of systolic diameter estimates per 30s acquisition

References

- [1] W. Lee, General principles of carotid Doppler ultrasonography, *Ultrasonography*, vol. 33, no. 1, pp. 11–17, 2014.
- [2] R. Osgood, In training emergency physicians the carotid artery Doppler with passive leg raise, does previous sonographic experience influence scan time and competency?, *Australasian Society for Ultrasound in Medicine*, vol. 24, no. 1, pp. 20–26, 2020.
- [3] L. van Knippenberg, An angle-independent cross-sectional Doppler method for flow estimation in the common carotid artery, *IEEE Transactions on Ultrasonics, Ferroelectrics, and Frequency Control*, vol. 67, no. 8, pp. 1513–1524, 2020.
- This work was supported by the Dutch Research Council (NWO) [grant number 17878].

Topic: Cardiovascular issues in ICU.

000335

Risk factors for mortality in patients with nosocomial infection in an ICU after long-term application of Selective Digestive Decontamination

C. Sánchez Ramírez¹, S. Hipola Escalada¹, M. Tout Castellano¹, L. Roldán Furelos¹, R. E. Morales Sirgado¹, L. Lara Franco¹, M. A. Hernández Viera¹, A. López Domínguez¹, M. D. L. Á. Sosa Durr¹, M. Cabrera Santana¹, A. Padrón Mujica¹, P. Saavedra-Santana², S. Ruiz-Santana¹

¹Intensive Care Medicine, University Hospital of Gran Canaria Dr. Negrin, Las Palmas de Gran Canaria, Spain; ²Mathematics and informatics department, University of Las Palmas, Las Palmas de Gran Canaria, Spain

Correspondence: C. Sánchez Ramírez

Intensive Care Medicine Experimental 2023, **11(Suppl 1)**:000335

Introduction. Recognition of risk factors for mortality and early intervention with appropriate administration of broad-spectrum antimicrobials in patients with nosocomial infection (NI) can significantly improve outcomes. Selective digestive decontamination (SDD) has been associated with reduced ICU mortality and acquired infection rates.

Objectives. To analyze the risk factors for mortality in patients with NI in an ICU after 11 years of SDD.

Methods. Patients with NI from October 1, 2010, to September 30, 2022, in a 30-bed polyvalent ICU were prospectively included. The SDD was applied for 11 years, from October 1, 2011 to September 30, 2022. Patients who required mechanical ventilation for more than 48 h were given an enteral solution and a paste containing colistin, tobramycin and nystatin every 8 h until discharge. Intravenous cefotaxime was also administered during the first 4 days. Rectal and pharyngeal exudates were collected on admission and weekly. ENVIN NI criteria were used. Categorical variables were summarized as frequencies and percentages and numerical variables as means and standard deviations or medians and interquartile ranges. Percentages were compared with the X2 test or Fisher's exact test, means with the t-test and medians with the Wilcoxon test for independent data. A multidimensional logistic analysis was performed. It was considered significant if $p \leq 0.05$.

Results. Of the 12,016 patients admitted, 313 (35.16%) of the 890 patients with NI died. In a univariate analysis, no statistically significant differences in ICU stay were found. Multidrug-resistant (MR) *Pseudomonas* and MR Gram-negative bacteria (GNB) were significantly higher in patients who died (Table 1). Independent mortality risk factors were: renal replacement therapy Odds Ratio (OR): 4.662 (3.373; 6.444), neoplasm OR: 2.567 (1.532; 4.304), ventilator-associated pneumonia (VAP):OR: 1.980 (1.407; 2.787), parenteral nutrition OR: 1.927 (1.322; 2.809), chronic obstructive pulmonary disease (COPD) OR: 1.852 (1.223; 2.805), septic shock OR: 1.817 (1.307; 2.527) and APACHE II OR: 1.054 (1.031; 1.077). (Table 2).

Conclusions. In an ICU with SDD, the factors that were independently associated with mortality were: renal replacement therapy, neoplasm, VAP, parenteral nutrition, COPD, septic shock and APACHE II. *Pseudomonas* MRs and GNB MRs also had significantly higher mortality.

Table 1 (abstract 000335) Patients characteristics according to survival and SDD 11 years

	Alive N = 577	Deaths N = 313	p-value
Age, years	59.6 ± 14.7	63.8 ± 13.2	< .001
APACHE II	19.4 ± 7.4	23.2 ± 7.7	< .001
SDD	503 (87.2)	278 (88.8)	0.475
Sex male	380 (68.0)	208 (68.0)	0.999
Trauma patients	82 (14.2)	12 (3.8)	< .001
Coronary artery disease patient	116 (20.1)	68 (21.8)	0.553
Emergency surgery	143 (24.8)	76 (24.4)	0.909
Immunosuppression	45 (7.8)	57 (18.3)	< .001
Neutropenia	13 (2.2)	22 (7.0)	< .001
Parenteral nutrition	91 (15.8)	99 (31.7)	< .001
Ventricular device	69 (12.0)	8 (2.6)	< .001
RRT	138 (24.0)	204 (65.2)	< .001
Malnutrition	38 (6.6)	46 (14.7)	< .001
Diabetes mellitus	150 (26.0)	123 (39.3)	< .001
COPD	72 (12.5)	68 (21.7)	< .001
Renal failure	86 (14.9)	93 (29.7)	< .001
Cirrhosis	19 (3.3)	22 (7.0)	0.011
Neoplasm	35 (6.1)	48 (15.3)	< .001
VAP	182 (31.5)	146 (46.6)	< .001
CRB	222 (38.7)	102 (32.6)	0.072
Secondary bacteremia	142 (24.7)	87 (27.8)	0.32
Urinary infection	161 (27.9)	77 (24.7)	0.3
ATB 48 hr before admission	129 (23.0)	108 (35.8)	< .001
<i>Acinetobacter baumannii</i>	14 (2.4)	7 (2.2)	0.859
MRSA	11 (1.9)	5 (1.6)	0.74
ESBL	136 (23.6)	90 (28.8)	0.09
MR <i>Pseudomonas</i>	33 (5.7)	40 (12.8)	< .001
MR GNB	21 (3.6)	24 (7.7)	0.009
Admission:			< .001
Medical	392 (67.9)	250 (80.1)	
Scheduled surgery	91 (15.7)	24 (8.0)	
Emergency surgery	94 (16.3)	37 (11.9)	
Inflammatory response:			< .001
Non sepsis	20 (3.5)	9 (2.9)	
Sepsis	137 (23.7)	37 (11.8)	
Septic Shock	410 (72.8)	267 (85.3)	
ICU days	33 (20 ; 50)	36.0 (21 ; 58)	0.126

Table 2 (abstract 000335) Multivariate logistic regression analysis for death and SDD 11 years

	p-value	Odd-Ratio (95% CI)
APACHE II	< .001	1.054 (1.031 ; 1.077)
Septic shock	< .001	1.817 (1.307 ; 2.527)
Parenteral nutrition	< .001	1.927 (1.322 ; 2.809)
RRT	< .001	4.662 (3.373 ; 6.444)
COPD	0.004	1.852 (1.223 ; 2.805)
Neoplasm	< .001	2.567 (1.532 ; 4.304)
VAP	< .001	1.980 (1.407 ; 2.787)

Topic: Sepsis.

000336

Thromboelastographic characteristics of anticoagulated patients with major or clinically relevant bleeding undergoing reversal therapy in the Emergency Department

F. Gavelli¹, L. Molinari¹, S. Priora¹, V. Giai Via¹, C. Airoldi², M. Beltrame¹, C. Michelone¹, F. Russo¹, S. Piazzini¹, F. Sajeva¹, S. Masellis¹, G. Brame¹, G. Roccasalva¹, C. Foini¹, M. Baldrighi¹, M. Bellan², F. Patrucco², P. P. Sainaghi², G. C. Avanzi¹, L. M. Castello²

¹Emergency Medicine Department, Università degli Studi del Piemonte Orientale, Novara, Italy; ²Dipartimento di medicina traslazionale,

Università degli Studi del Piemonte Orientale 'Amedeo Avogadro', Novara, Italy

Correspondence: F. Gavelli

Intensive Care Medicine Experimental 2023, 11(Suppl 1):000336

Introduction. Despite the wide diffusion of oral anticoagulation in patients at risk for thromboembolism and cardioembolic stroke, major and clinically relevant bleedings remain the dominant adverse events of such therapy(1). Thromboelastography (TEG) is a point-of-care viscoelastic test that assesses coagulation throughout all phases of clot formation, allowing one to detect alterations of the coagulation cascade(2). Although its use in the emergency and critical care setting is increasing, TEG characteristics in anticoagulated patients with significant bleeding undergoing reversal therapy need to be explored.

Methods. In this preliminary evaluation of our ongoing observational prospective monocentric study, consecutive adult patients taking anti-coagulants admitted to the ED for either *major* (fatal and/or symptomatic bleeding in a critical organ with acute decrease in hemoglobin concentration ≥ 2 g/dL or transfusion of ≥ 2 units of red blood cells) or *clinically relevant* (bleeding that requires medical intervention to control) bleeding and for whom reversal therapy with prothrombin concentrated complex was required were enrolled. Demographic, clinical and blood tests data were collected at ED admission (T0) and a TEG analysis through 4 reagents (kaolin, kaolin + heparinase, tissue factor, platelet inhibitor GPIIb/IIIa) was performed. At 48 h (T1) possible failure of reversal therapy (namely recurrent bleeding despite any associated therapy with hemostatic intent or death) was assessed.

Results. Between November 2022 and March 2023, 35 patients were enrolled, of 71% which were male. The median age of the population was 83[75–90] years and the BMI was 26[24–28]. 69% of patients came from home and the 94% was hospitalized. The most represented anticoagulant was Apixaban (31%), followed by Rivaroxaban (23%). The most common type of bleeding was muscle/soft tissue arterial hematoma (51%) followed by gastrointestinal bleeding (26%). 34% of patients underwent angioembolization and 20% endoscopic intervention. Red blood cells transfusion was performed in 51% (2 [1–3] units), fresh frozen plasma was administered in 60% (400 [400–600] mL). Table 1 summarizes vital signs, laboratory tests and TEG parameters. Three patients failed the reversal therapy: one had an increased intracranial bleeding at the control CT scan, one needed a new embolization attempt and another patient died for hemorrhagic shock.

Table 1 (abstract 000336)

Kaolin TEG	
Reaction time, min	6.9 [5.4–9.8]
K, min	1.25 [0.9–5.15]
α -angle	73.55 [38.65–77.2]
Maximum amplitude, mm	64.55 [60.7–67.1]
LY30, %	0 [0–0.3]
Kaolin TEG with heparinase	
Reaction time, min	6 [5.5–8.2]
K, min	1.1 [0.9–1.3]
α -angle	75.55 [72.5–77.5]
Maximum amplitude, mm	67.25 [64.2–68.9]
Rapid TEG (with tissue factor)	
Reaction time, min	0.4 [0.3–1.1]
K, min	1.1 [0.8–2.2]
α -angle	76.8 [63.6–78.5]
Maximum amplitude, mm	66.7 [61.6–68.9]
LY30, %	0 [0–0.1]
Functional fibrinogen (with platelet inhibitor GPIIb/IIIa)	
Maximum amplitude, mm	29.05 [23.1–35.05]

Conclusions. The preliminary data of our ongoing study describe the main TEG characteristics of bleeding patients, in which the failure of reversal therapy appeared to be low. By increasing patient enrollment we aim at identifying those parameters that may predict such adverse outcome.

References

1. Tyler PD, Yang LM, Snider SB, Lerner AB, Aird WC, Shapiro NI. New Uses for Thromboelastography and Other Forms of Viscoelastic Monitoring in the Emergency Department: A Narrative Review. *Ann Emerg Med.* 2021;77(3):357–66.
2. Piran S, Schulman S. Treatment of bleeding complications in patients on anticoagulant therapy. *Blood.* 2019;133(5):425–35.
3. Not available.

Topic: Transfusion and haemostasis disorders.

000338

Continuous monitoring of left ventricular function in intensive care using transesophageal echocardiography and artificial intelligence

J. Yu¹, A. Taskén², EA. Berg³, T. Tannvik⁴, I. Kirkeby-Garstad¹, B. Grenne³, G. Kiss², S. Aakhus¹

¹Department of Circulation and Medical Imaging, Norwegian University of Science and Technology, Trondheim, Norway; ²Department of Computer Science, Norwegian University of Science and Technology, Trondheim, Norway; ³Clinic of Cardiology, St. Olavs Hospital, Trondheim University Hospital, Tromsø, Norway; ⁴Department of Anesthesia and Intensive Care Medicine, St. Olavs Hospital, Trondheim University Hospital, Tromsø, Norway

Correspondence: J. Yu

Intensive Care Medicine Experimental 2023, **11(Suppl 1)**:000338

Introduction. During hemodynamic monitoring, a blind spot appears when a fall in left ventricular (LV) function precedes the fall in either cardiac output or blood pressure. Yet, LV dysfunction is common and detrimental (1). Thus, to continuously monitor LV systolic function and thereby uncover this blind spot, we have developed a method that automatically obtains mitral annular plane systolic excursion (MAPSE) using artificial intelligence and hands-free transesophageal echocardiography (autoMAPSE, Fig. 1) (2).

Objectives. Our objectives were 1) to assess the feasibility of continuous autoMAPSE using hands-free transesophageal echocardiography and 2) to compare autoMAPSE with manual measurements.

Methods. We monitored 50 intensive care patients for two hours immediately after cardiac surgery. We recorded a set of hands-free images every five minutes. Each set comprised 10 heartbeats of midesophageal two-chamber (2C) and four-chamber (4C) views. Next, we used autoMAPSE to obtain MAPSE of four walls and of every heartbeat. Thus, when we finally report MAPSE, we report the average of every heartbeat from a specific wall in a specific set of images. We categorized *monitoring feasibility* as ‘excellent’ if the same wall for the same patient could be monitored $\geq 90\%$ of the time. Likewise, we categorized monitoring feasibility as ‘good’ and ‘poor’ when the same wall could be monitored 50–90% and $\leq 50\%$ of the time, respectively. During hemodynamic stability, we recorded three sets of 2C and 4C images in rapid succession; only in these images did we also measure MAPSE manually. As our measurements were not independent, we used a linear mixed model to assess bias and agreement (3). From the same model, we used the residual standard deviations of each measurement method to estimate the precision of that particular method. We report bias and agreement as a modified Bland–Altman analysis with limits of agreement and report precision as the least significant change.

Results. AutoMAPSE had excellent monitoring feasibility in almost all patients (88%), good in three patients (6%) and poor in three patients (6%). Of note, we did not exclude any images due to poor quality.

Compared with manual measurements, autoMAPSE had no significant bias (-0.2 mm, $p=0.1$) and had good agreement (limits of agreement -3.4 to 2.9 mm, Fig. 2). Even when manually measuring and averaging the MAPSE of 10 heartbeats, manual measurements could not detect smaller changes than autoMAPSE ($p=0.24$, Fig. 3). On the other hand, by averaging more measurements, autoMAPSE can easily detect even smaller changes in MAPSE (Fig. 3).

Conclusions. Continuous monitoring of LV function in intensive care had excellent feasibility. When we compared autoMAPSE with manual measurements, autoMAPSE was more precise, had no bias and had good agreement.

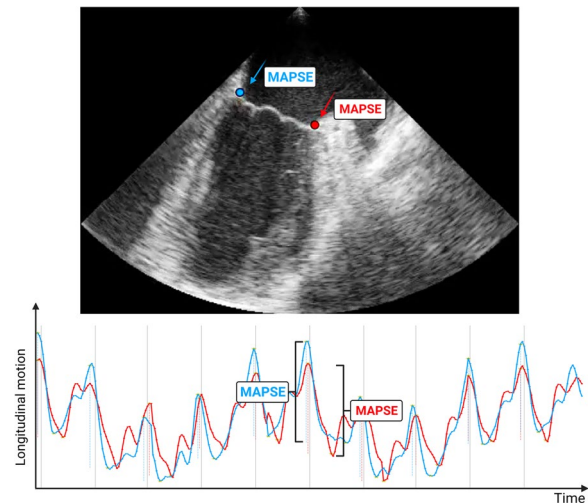

Figure 1 (abstract 000338) Automatic measurement of mitral annular plane systolic excursion (autoMAPSE) on a hands-free image. Top panel: The mitral annulus is detected automatically using artificial intelligence (red and blue dots). Bottom panel: The longitudinal motion of the mitral annulus for 10 heartbeats. For each heartbeat (vertical lines), MAPSE is the distance between the highest and the lowest point. Brackets, demonstrating the MAPSE of one particular heartbeat; MAPSE, mitral annular plane systolic excursion

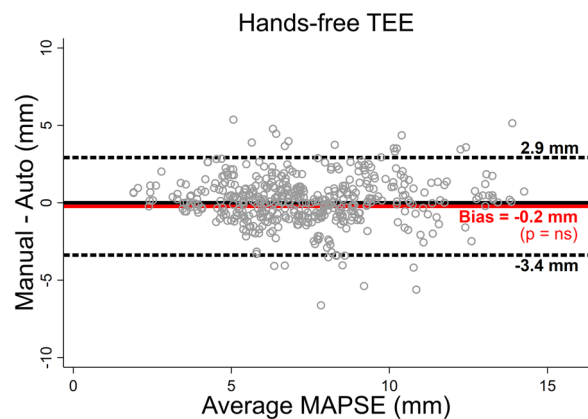

Figure 2 (abstract 000338) Bland–Altman plot of automatic vs. manual measurements on hands-free images. Red line, bias; dashed lines, limits of agreement; MAPSE, mitral annular plane systolic excursion; ns, non-significant; TEE, transesophageal echocardiography

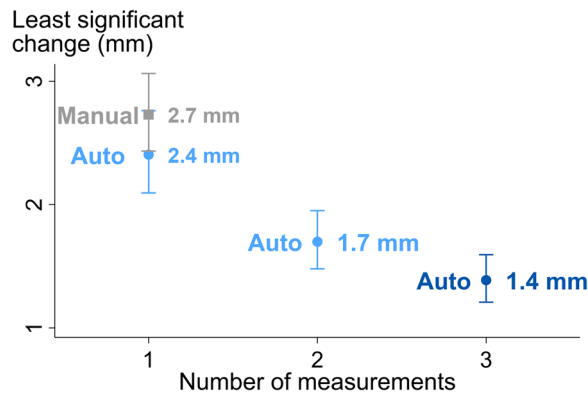

Figure 3 (abstract 000338) Least significant change of automatic vs. manual measurement. Lower least significant change equals better precision. Each measurement is the average mitral annular plane systolic excursion of a recording that consisted of 10 heartbeats

References

- Dugar S, Sato R, Chawla S, Young J, Wang X, Grimm R, et al. Is left ventricular systolic dysfunction associated with increased mortality among patients with sepsis and septic shock? [published online ahead of print, 2023 Jan 14]. *Chest*. 2023;S0012-3692(23)00111-3. <https://doi.org/10.1016/j.chest.2023.01.010>
- Nordal T. Automatic detection of mitral annular plane systolic excursion from transesophageal echocardiography using deep learning [thesis]. Norwegian University of Science and Technology; 2019. Available from: <https://ntnuopen.ntnu.no/ntnu-xmlui/handle/11250/2625719>
- Carstensen B. Comparing Clinical Measurement Methods: A Practical Guide. John Wiley & Sons, Ltd; 2010.
- Samarbeidsorganet, Helse Midt-Norge, Norway.

Topic: Cardiovascular issues in ICU.

000339

Assessment of V/Q mismatch during pressure support ventilation with electrical impedance tomography: a prospective physiological study

M. Ippolito¹, A. Federico¹, G. Grasselli², A. Giarratano¹, A. Cortegiani³
¹Anestesia e Rianimazione, Azienda Ospedaliera Universitaria Policlinico Paolo Giaccone, Palermo, Italy; ²Intensive care unit, Policlinico of Milan, Milan, Italy; ³Anestesia e Rianimazione, Palermo, Italy

Correspondence: M. Ippolito

Intensive Care Medicine Experimental 2023, **11(Suppl 1)**:000339

Introduction. Spontaneous breathing in patients with ARDS may have both protective and negative effects, that have been attributed according to the severity of lung injury [1–3].

Objectives. This study aimed at describing the effects of different levels of pressure support on V/Q matching in patients recovering from ARDS, using electrical impedance tomography (EIT).

Methods. We performed a single-centre prospective observational cohort study (EC Palermo I 14/09/22), including adult mechanically ventilated patients admitted to the ICU with a diagnosis of ARDS and reaching clinical stability and pressure support ventilation. Patients with contraindications to the use of EIT, other causes

of acute respiratory failure, neuro-muscular disease, or limitation of care were excluded. Patients were evaluated in two different conditions sequentially, using Pulmovista 500 Draeger. The first observation condition was identified within the first 24 h of PSV ventilation, at a clinically selected level of pressure support under stable clinical conditions. This condition was labeled according to P0.1: pressure support level determining a P0.1 < 2, was considered "High", and the one determining a P0.1 > 2 was considered "Low". After data collection at a clinically selected level of pressure support, the pressure support level was transiently increased or decreased (i.e. from "high" to "low"/ from "low" to "high") to the lowest/highest clinically tolerated level, aiming at the predefined P0.1 thresholds, and then kept for 20 min at stable clinical conditions. Data collection was repeated and then the clinically selected level of pressure support was restored. Data collection consisted of 180 s of EIT recording, and the performance of a 3 s inspiratory hold pause during which a 10 ml of 5% hypertonic saline bolus was administered to evaluate lung perfusion [4,5]. Offline analyses on ventilation and perfusion distribution were conducted using Pulmovista 500 Draeger dedicated software. Data on arterial blood gas analysis and ventilatory parameters were also recorded. No changes in analgo-sedation were performed during the observations. The primary outcome was V/Q matching at the two different conditions. Statistical analysis was conducted using descriptive statistics, Wilcoxon signed-rank test, and Pearson correlation. Data are presented as median [IQR] or percentages. [Clinicaltrials.gov:NCT05781802](https://clinicaltrials.gov/NCT05781802).

Results. We present preliminary data on 5 patients, undergoing PSV ventilation after a median of 48 h of protective controlled ventilation. The median age was 70 y.o and P/F at ICU admission was 151 [151;155] mmHg. The first PSV observation was conducted at a clinical pressure support, which was "low" in 2 patients and "high" in 3 patients, and then in the other condition. The high ΔP_{support} was 15 [12;17] cmH₂O, and the low was 5 [5;10] cmH₂O. The respiratory rate (14 [10;14] bpm at high support; 14 [14;17] bpm at low support) and pCO₂ (40 [37;50] mmHg at high support; 43 [42;49] mmHg at low support) remained stable at the two conditions. Vt/IBW decreased from high to low support (10.3 [9.3;13.7] ml/kg high; 8.4 [7;10.2] ml/kg low). V/Q matching improved from high-pressure support to low-pressure support (50.5% [47.1; 68.8] high; 71.4% [68.6; 72.1] low; Fig. 1), despite not significantly (P = 0.188). Interestingly, the difference in V/Q matching showed a trend of correlation with the difference in pressure support level (ρ = 0.866; P = 0.058; Fig. 2).

	High PSV	Low PSV	P value
P/F, mmHg	220 [220;260]	224 [214;258]	0.881
ΔP _{support} , cmH ₂ O	15 [12;17]	5 [5;10]	0.003
PEEP, cmH ₂ O	12 [10;12]	12 [10;12]	-
Respiratory rate, bpm	14 [10;14]	14 [14;17]	0.111
P _{driving} , cmH ₂ O	13 [10;14]	11.5 [9;16]	0.904
Vt/IBW, ml/kg	10.3 [9.3;13.7]	8.4 [7;10.2]	0.006
P0.1, mbar	1.5 [1.1;1.6]	3.1 [2.7;3.1]	<0.001
PMI, cmH ₂ O	-2 [-6;-2]	6 [4;6]	0.004
ΔP _{occ} , cmH ₂ O	-8 [-9.8;-6]	-15.8 [-16;-13]	0.004
V/Q Matching, %	50.5 [47.1; 68.8]	71.4 [68.6; 72.1]	0.149

Conclusions. Preliminary data show a trend towards improved V/Q matching using low pressure support. Data from a larger cohort of patients are needed to adequately test this hypothesis.

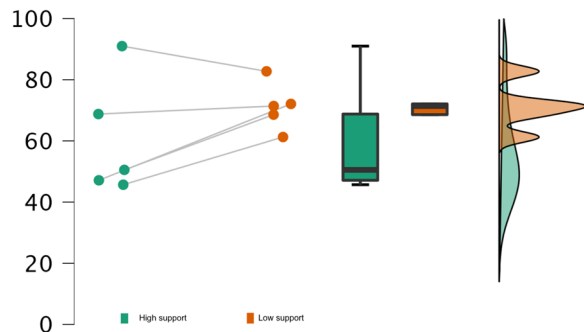

Figure 1 (abstract 000339) Raincloud plot showing V/Q matching at the two observation conditions

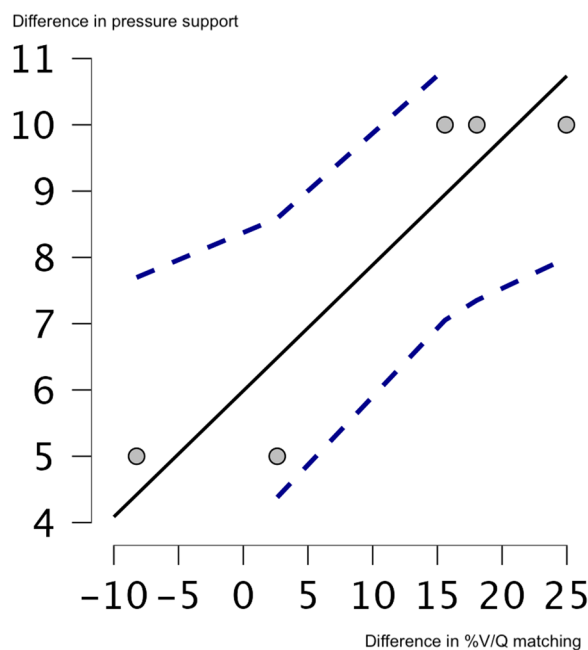

Figure 2 (abstract 000339) Correlation plot between difference in V/Q matching and difference in pressure support at the two observation conditions

References

1. Yoshida, T., Fujino, Y., Amato, M. B. P. & Kavanagh, B. P. Fifty years of research in ards spontaneous breathing during mechanical ventilation risks, mechanisms, and management. *Am. J. Respir. Crit. Care Med.* 195, 985–992 (2017).
2. Mauri, T. et al. Topographic distribution of tidal ventilation in acute respiratory distress syndrome: Effects of positive end-expiratory pressure and pressure support. *Crit. Care Med.* 41, 1664–1673 (2013).
3. Carvalho, A. R. et al. Distribution of regional lung aeration and perfusion during conventional and noisy pressure support ventilation in experimental lung injury. *J. Appl. Physiol.* 110, 1083–1092 (2011).
4. Spinelli, E. et al. Unmatched ventilation and perfusion measured by electrical impedance tomography predicts the outcome of ARDS. *Crit. Care* 25, 1–12 (2021).

5. Frerichs, I. et al. Regional lung perfusion as determined by electrical impedance tomography in comparison with electron beam CT imaging. *IEEE Trans. Med. Imaging* 21, 646–652 (2002).

Topic: Acute respiratory failure and mechanical ventilation.

000341

Early predictors of prolonged mechanical ventilation in severe blunt chest trauma patients: a retrospective cohort study

A. Gilad¹, N. Shorbaji², O. Katzir³, S. Ankol⁴, K. Badarni⁵, E. Andrawus⁵, M. Roimi⁵, A. Katz¹, Y. Bar-lavie⁵, A. Raz⁶, D. Epstein⁵

¹Department of General Thoracic Surgery, Rambam Healthcare Campus, Haifa, Israel; ²Department of Diagnostic Imaging, Rambam Healthcare Campus, Haifa, Israel; ³Faculty of medicine, The Hebrew University of Jerusalem, Jerusalem, Israel; ⁴Faculty of medicine, Technion—Israel Institute of Technology, Haifa, Israel; ⁵Critical Care Division, Rambam Healthcare Campus, Haifa, Israel; ⁶Department of Anesthesiology, Rambam Healthcare Campus, Haifa, Israel

Correspondence: D. Epstein

Intensive Care Medicine Experimental 2023, **11(Suppl 1)**:000341

Introduction. Chest trauma is a significant cause of morbidity and mortality, especially among the young. A significant proportion of patients with severe chest trauma require mechanical ventilation (MV). Early prediction of the duration of MV may influence clinical decisions and interventions.

Objectives. We aimed to determine early risk factors for prolonged MV among adults suffering from severe blunt thoracic trauma.

Methods. This was a retrospective, single-center, cohort study of all patients admitted between January 2014 and December 2020 due to severe blunt chest trauma, which was defined as a chest abbreviated injury score ≥ 3 . The primary outcome was prolonged MV defined as invasive MV lasting more than 14 days. Multivariable logistic regression was performed to determine independent risk factors for prolonged respiratory support.

Results. The final analysis included 378 patients (Fig. 1). The median duration of MV was 9.7 (IQR 3.0–18.0) days. 221 (58.5%) patients required MV for more than seven days and 143 (37.8%) for more than 14 days. In the entire cohort, male gender (aOR 2.55, 95% CI 1.41–4.58, $p=0.02$), age (aOR 1.43, 95% CI 1.24–1.66, $p<0.001$), and the presence of severe head trauma (aOR 3.37 95% CI 2.03–5.58, $p<0.001$) were independently associated with prolonged MV. The number of fractured ribs and the extent of lung contusion were associated with MV lasting for seven, but not 14 days. The probability of prolonged MV (> 14 days) by age and presence of concomitant severe head injury, is presented in Fig. 2. In the subgroup of 134 patients without concomitant head trauma, age (aOR 2.08, 95% CI 1.50–2.89, $p<0.001$), presence of abdominal trauma (aOR 3.33, 95% CI 1.22–9.12, $p=0.02$), and a spinal injury (aOR 3.83, 95% CI 1.17–12.50, $p=0.03$) were independently associated with MV for more than 14 days. The probability of prolonged MV by age and the presence of concomitant injuries is presented in Fig. 3.

Conclusions. Among patients with severe blunt thoracic injury, older age, male gender, and concomitant severe neurotrauma are independently associated with prolonged MV. Among patients without concomitant head injury, age and abdominal-pelvic and spinal injuries were associated with prolonged MV. Patients fulfilling these criteria are at high for prolonged MV and should be considered for interventions potentially shortening MV duration and its complications. Young patients suffering from isolated severe thoracic trauma, including those with extensive lung contusions and ribs fractures, have a benign course and a low risk of prolonged MV.

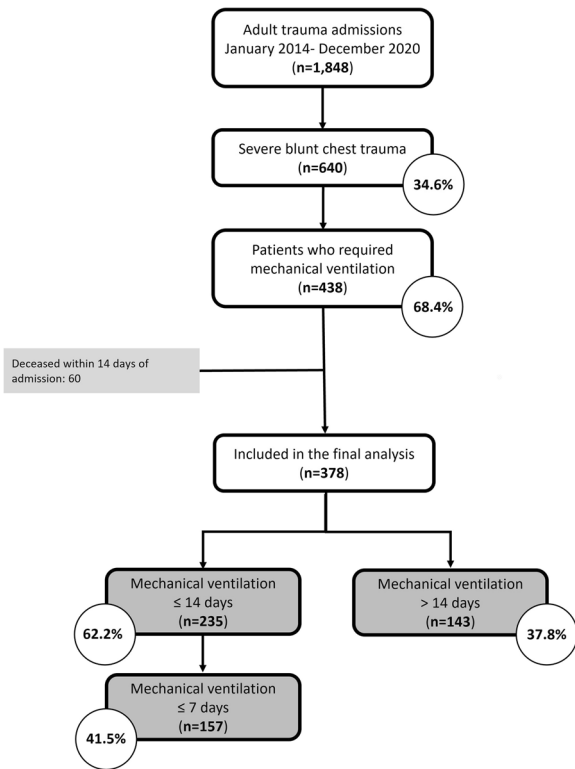

Figure 1 (abstract 000341) Study flow chart

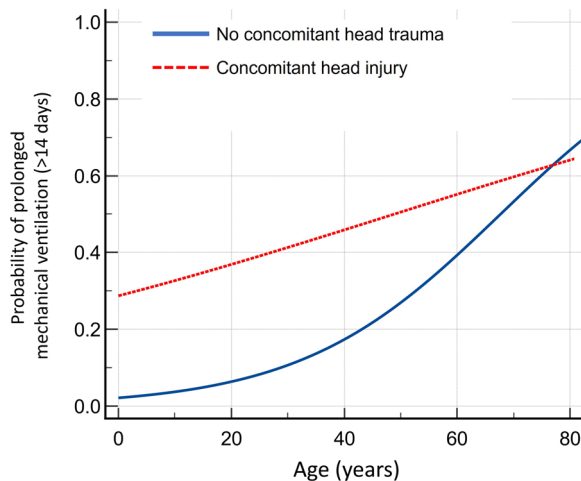

Figure 2 (abstract 000341) Probability of prolonged mechanical ventilation by age and presence of concomitant severe head injury

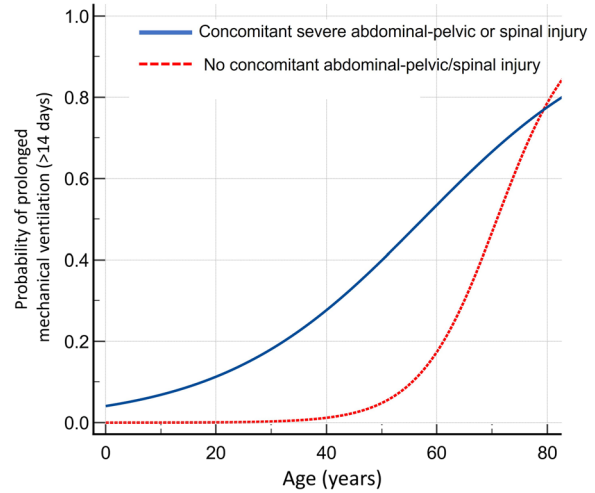

Figure 3 (abstract 000341) Probability of prolonged mechanical ventilation by age and presence of concomitant severe abdominal-pelvic or spinal injury among 134 patients without head injury

References

1. Figueroa-Casas JB, Connery SM, Montoya R, Dwivedi AK, Lee S. Accuracy of Early Prediction of Duration of Mechanical Ventilation by Intensivists. *Ann Am Thorac Soc.* 2014;11(2):182–5.
2. Craxford S, Owyang D, Marson B, Rowlinson K, Coughlin T, Forward D, Ollivier B. Surgical management of rib fractures after blunt trauma: a systematic review and meta-analysis of randomised controlled trials. *Ann R Coll Surg Engl.* 2022 Apr 1;104(4):249–56.
3. Schuurmans J, Goslings JC, Schepers T. Operative management versus non-operative management of rib fractures in flail chest injuries: a systematic review. *Eur J Trauma Emerg Surg.* 2017 Apr 1;43(2):163–8.
4. Okabe Y. Risk factors for prolonged mechanical ventilation in patients with severe multiple injuries and blunt chest trauma: a single center retrospective case-control study. *Acute Med Surg.* 2018 Apr;5(2):166–72.
5. None

Topic: Trauma.

000342

Development and validation of a diagnostic model for acute respiratory distress syndrome based on volatile organic compounds in exhaled breath

S. Zhang¹, L. Hagens¹, N. Heijnen², M. Smit¹, P. Brinkman³, D. Fenn³, T. van der Poll⁴, M. J. Schultz¹, D. Bergmans², R. Schnabel², L. Bos¹
¹Department of intensive care, Amsterdam UMC, locatie AMC, Amsterdam, Netherlands; ²Department of intensive care, Maastricht UMC+, Maastricht, Netherlands; ³Department of Respiratory Medicine, Amsterdam UMC, locatie AMC, Amsterdam, Netherlands; ⁴Center for experimental and molecular medicine, Amsterdam UMC, locatie AMC, Amsterdam, Netherlands

Correspondence: S. Zhang

Intensive Care Medicine Experimental 2023, 11(Suppl 1):000342

Introduction. Acute respiratory distress syndrome (ARDS) is a common cause of acute hypoxemic respiratory failure that is difficult to recognize. The clinical diagnosis for ARDS may be improved by means of objective biological markers. Exhaled breath contains volatile metabolites that can reflect pulmonary pathophysiological process. Changes of the composition of exhaled metabolic biomarkers have been associated with the diagnosis of different respiratory diseases. Gas chromatography-mass spectrometry (GC-MS) is regarded as a gold standard for volatile organic compounds (VOCs) identification.

Objectives. We aim to develop and validate a diagnostic model for ARDS patients based on exhaled VOCs.

Methods. In this prospective two-center observational study in unselected critically ill patients receiving invasive ventilation, breath metabolites were captured on sorbent material and quantified using GC-MS [Hagens, ATM 2021]. ARDS was diagnosed by three experts using the Berlin definition. All patients were labeled as "certain ARDS", "certain no ARDS" and "uncertain ARDS" ("likely ARDS" or "likely no ARDS") based on the experts' assessment. The patients with "certain" labels from one hospital (Amsterdam UMC, AMC) were used as derivation cohort to train a classifier, the "VOC-ARDS score", which is built based on the five most significant breath metabolites selected by a random forest model. The diagnostic accuracy of the VOC-ARDS score was assessed in all patients in the second hospital (Maastricht University Medical Center, MUMC), and combined with the lung injury prediction score (LIPS).

Results. In total, 499 patients were included in the study. 357 patients were included in the AMC cohort (60 with certain ARDS (*i.e.* derivation cohort); 17%), and 142 patients in the MUMC cohort (47 with certain ARDS (*i.e.* validation cohort); 33%). The metabolites 1-methylpyrrole (Mey), 1,3,5-trifluorobenzene (Tri), methoxyacetic acid (Mea), 2-methylfuran (Fur) and 2-methyl-1-propanol (Mep) were included in the classifier. The VOC-ARDS score had an area under the receiver operating characteristics curve (AUROCC) of 0.71 (CI: 0.63–0.78) in the derivation cohort and 0.63 (CI: 0.52–0.74) in the validation cohort. Combining the breath test with the LIPS increased the AUROCC to 0.75 (CI: 0.68–0.82) and 0.64 (CI: 0.53–0.75) respectively (Fig. 1). When patients who had uncertain labels were also considered, the diagnostic accuracy of VOC-ARDS score decreased, both in AMC (AUROCC of 0.67, CI 0.61–0.73) and MUMC (AUROCC of 0.58, CI 0.48–0.67) cohort.

Conclusions. An exhaled breath metabolomics-based classifier has moderate diagnostic accuracy for ARDS, but is not sufficiently accurate for clinical use, even after combination with LIPS.

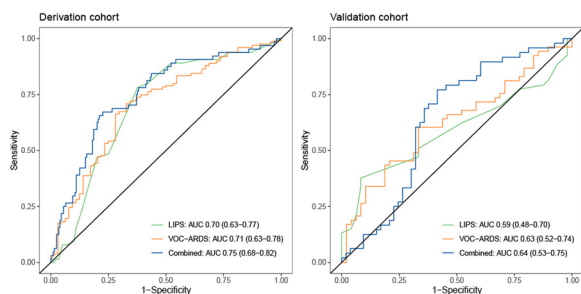

Figure 1 (abstract 000342) Receiver operating characteristics (ROC) curve of the classifier (VOC-ARDS score) and combined the classifier with the lung injury prediction score (LIPS) in the different cohorts. AUC = Area Under Curve

References

- Hagens LA, Heijnen NFL, Smit MR, et al. Diagnosis of acute respiratory distress syndrome (DARTS) by bedside exhaled breath octane measurements in invasively ventilated patients: protocol of a multicentre observational cohort study. *Ann Transl Med.* Aug 2021;9(15):1262.
- This research was funded by an Amsterdam UMC fellowship to LDJB

Topic: Acute respiratory failure and mechanical ventilation.

000343

Usefulness of the Cell Index in the diagnosis and therapeutic management of infections related to external ventricular drainage

M. C. Climent Company¹, M. Campano Garcia¹, A. Vázquez Sánchez¹, A. Zapatero-Ferrandiz², L. Picazo Moreno¹, M. Acer Puig¹, J. Ravelo Barba¹, Y. Díaz Buendía¹, J. R. Masclans Enviz², M. P. Gracia Arnillas², R. Munoz-Bermudez¹

¹Critical Care Department, Hospital del Mar, IMIM-GREPAC, Barcelona, Spain; ²Critical Care Department, Hospital del Mar, IMIM-GREPAC, Pompeu Fabra University, Barcelona, Spain

Correspondence: M.C. Climent Company

Intensive Care Medicine Experimental 2023, **11(Suppl 1)**:000343

Introduction. Critically ill patients are characterized by a baseline situation of extreme severity and by the high number of device implantations. That carries risks and complications where infectious complications are those that produce the most serious adverse effects and the highest rates of morbidity and mortality.

Ventriculitis associated with external ventricular drainage (EVD) is a serious complication related to the use of these devices. The importance lies in its difficult diagnosis, interfered on many occasions by the pathology itself that motivated the placement of the EVD.

Some studies propose the calculation of the "Cell Index" (CI), based on the relationship between leukocytes and erythrocytes in CSF and peripheral blood as a diagnosis of ventriculitis.

It is based on the fact that neurocritical patients with intraventricular hemorrhage, since the CSF is contaminated with blood, it is assumed that erythrocytes and leukocytes will be present in the CSF in a proportion similar to that of peripheral blood. Any change in the CSF leukocyte count can be detected by altering this ratio and may be an earlier tool than the usual confirmatory method (microbiological culture).

Studies have shown good results with the increase in CI and the incidence of ventriculitis but it has not been possible to specify an absolute value.

Objectives. To study and compare the Cell Index value between different groups on the day ventriculitis is suspected in neurocritical patients with EVD.

Methods. Retrospective study of a polyvalent ICU where 208 patients were analyzed and, 191 neurocritical patients admitted to the ICU were included between January 2007 and December 2018 with the need for EVD and CSF and blood samples were obtained. Patients < 18 years of age, with active central nervous system (CNS) neoplasia, previous ventriculoperitoneal drainage, CNS infection at the time of EVD placement, without intraventricular hemorrhage or who did not obtain a CSF/blood sample were excluded. They were classified into 2 groups according to whether they presented CDC/NHSN criteria for ventriculitis: ventriculitis group and control group. Different variables are analyzed, such as epidemiological data, evolution variables during the ICU stay and analysis of biological sample variables such as CSF and blood. From the CSF and blood samples extracted for clinical purposes, the CI and glucose ratio CSF/PB (peripheral blood) is calculated in the ventriculitis group the day when ventriculitis clinically manifests, and the result is compared with the control group, in this case the CSF sample analyzed is the closest to the EVD placement.

Results. Of the 198 patients included in the study, 29 (15.2%) evolved to ventriculitis and 162 (84.8%) patients had no suspicion of ventriculitis (control group). Of the patients who developed ventriculitis, 17 (58.6%) were female, with a mean age of 53 years. The reason for admission that predominated in all groups was subarachnoid hemorrhage, with 112 patients in the control group (69.1%) and 24 (82.8%) in the ventriculitis group.

Subjects with ventriculitis had a significantly higher CI value of 5.1 [3–9.5] compared to the control group 0.2 [0–0.8] $p < 0.01$. They also had more proteins in CSF (median ventriculitis group 59.4 [35.1–185.4]

vs 50,3 [23,2–86,9] $p < 0.03$) and low glucose ratio CSF/PB levels (median ventriculitis group 0.2 [0.1–0.4] vs 0.6 [0.5–0.7] group control, $p < 0.01$). The greater number of days of EVD ($p < 0.01$) and the greater number of exchanges ($p < 0.02$) have also been found as risk factors for developing ventriculitis. Other variables such as the lactate value have not obtained statistically significant results. Neither were acute phase reagents found in peripheral blood, such as C-reactive protein (CRP) or leukocytosis. Patients with ventriculitis have higher readmission rates and prolonged hospital stay.

Conclusions. The value of the CI and glucose ratio CSF/PB could be useful for the diagnosis of ventriculitis. The greater number of days of EVD and the greater number of replacements of the same are associated as risk factors for the development of ventriculitis. Further studies are needed to further establish the role of CI for diagnostic and prognostic value.

	Control (n = 162)	Ventriculitis (n = 29)	p
Cerebrospinal fluid			
White Cell count, mm ³	88,5 [10,0-446,0]	396,0 [129,0-2105,5]	0,001
Neutrophils, %	65,4 [0-79,2]	80,0 [60,1-91,9]	0,001
Lymphocytes, %	21,0 [0,0-34,9]	20,0 [7,6-39,1]	0,431
Erythrocytes, mm ³	27950,0 [7900,0-100475,0]	4700,0 [2580,0-20150,0]	0,001
Glucose, mg/dL	86,5 [73,0-106,2]	48,0 [7,5-72,0]	0,001
Proteins, mg/dL	50,3 [23,2-86,9]	59,4 [35,1-185,4]	0,034
Lactate, mmol/L	3,7 [2,8-4,7]	4,7 [3,0-8,9]	0,168
Peripheral blood			
Leukocytes, mm ³	12600,0 [9275,0-16922,0]	13810,0 [10865,0-17025,0]	0,186
Neutrophils, %	82,0 [76,3-87,6]	83,8 [79,2-87,6]	0,207
Erythrocytes, mm ³	3,6 [3,2-4,2]	3,6 [3,2-4,3]	0,775
Glucose, mg/dL	147,0 [120-172,0]	162,0 [140,0-188,5]	0,042
Lactate, mmol/L	1,4 [1,1-1,8]	1,1 [2,4-9,5]	0,203
Reactive C protein, mg/dL	4,3 [1,6-10,5]	6,5 [2,4-9,5]	0,423
Calculated variables			
Cell Index	0,2 [0-0,8]	5,1 [3-9,5]	0,001
Glucose ratio CSF/PB	0,6 [0,5-0,7]	0,2 [0,1-0,4]	0,001

Values of quantitative variables are expressed as mean [interquartile range]. CSF: cerebrospinal fluid, PB: peripheral blood.

References

- Montes K et al. "Corrected white blood cell count, cell index, and validation of a clinical model for the diagnosis of health care-associated ventriculitis and meningitis in adults with intracranial hemorrhage". Clin Neurol Neurosurg. 2019
- Grille P et al. "Diagnosis of ventriculostomy-related infection: Is cerebrospinal fluid lactate measurement a useful tool?" Journal of Clinical Neuroscience. 2017
- Lunardi LW et al. "Cell Index in the Diagnosis of External Ventricular Drain-Related Infections." World Neurosurg. 2017
- Pfaußler et al. "Cell index—A new parameter for the early diagnosis of ventriculostomy (external ventricular drainage)-related ventriculitis in patients with intraventricular hemorrhage?" Acta Neurochir. 2004
- Wiegand J et al. "Indicators of external ventricular drainage-related infections—a retrospective observational study." Acta Neurochir 2016
- Liew S, et al. "Utility of the Cell Index in Predicting External Ventricular Drain-Related Ventriculo-Meningitis." Neurocrit Care. 2020

Topic: Infections and prevention.

000344

Pilot study to evaluate the role of molecular markers to predict organ failure in patients with sepsis using "gene set" approach

L. P. Emerson¹

¹Department of Critical care, Christian Medical College, Vellore, India

Correspondence: L. P. Emerson

Intensive Care Medicine Experimental 2023, 11(Suppl 1):000344

Introduction. Transcriptomic profile of septic patients who progress to organ failure.

Objectives. The aim of this study is to generate predictive models of organ failure from the transcriptomic profile of patients with sepsis at presentation.

Methods. In this study, critically ill patients who met consensus criteria for sepsis were included. We chose 21 patients with proven sepsis and one volunteer with no known comorbidities to provide control values for mRNA expression. Blood samples were collected within 6 h and 72 h and genomic response was evaluated using microarrays. Whole blood samples approximately 10 ml was collected and RNA was extracted from the whole blood using QiAmp blood mini kit (Qiagen). A quantitative PCR for a panel of number 44 genes already implicated in sepsis was performed using a custom R2 PCR array (Qiagen) in our institute using ABI quant gene instrument. The "Gene set" was selected from literature based on the canonical pathways for predicting organ dysfunction in patients with proven sepsis. The Acute Physiology and Chronic Health Evaluation II (APACHE II) scores on admission and the Sequential Organ Failure Assessment (SOFA) scores on days 1, 3, were calculated. Gene expression profiles of sepsis patients across the two time points, grouped by septic status with a 1.5 to twofold expression of genes with respect to normal was considered as significant. We categorised patients depending on the SOFA score into < 4, 5–8, 9–12, > 13. One patient had SOFA score of 2 (survivor), and 2 patients had SOFA score of > 13 (non-survivors). Mean of Fold change of the genes were compared between survivors and non survivors in SOFA score of 5–8 and 9–12.

Results. 15 patients were selected, complete data was available for 14 patients. Principal sources of infection were the abdomen (42.85%) and NSTI (35.71%). Trauma, fungal sinusitis and blood infections constituted the rest (7.41% each). Of the septic patients, 78.5% had a confirmed microbial diagnosis. In 14.2% of the cases, the infection was caused by Gram-positive bacteria and 42.8% of the cases were caused by Gram-negative bacteria. Fungal infection was seen in one patient. 14.28% of the patients had a polymicrobial infection. (Table-1) The analysis of individual components of SOFA score revealed that mortality was associated with organ dysfunction in lungs, cardiovascular, renal and coagulation profile (Table-2). Transcriptomic analysis showed significant fold change in sepsis patient compared with the control. This increased expression was noted in Genes encoding for neutrophil-mediated response and innate pro-inflammatory response (ELANE, ADORA3, MPO, MMP8, CTSG and IL-1 and IL-18) Genes participating in cell cycle viz, HIST1H1C, CKS2, CCNA2, CDK1, CCNB2, CIT, CCNB1, AURKA, RAD51 showed significant increase in fold change which indicates response to severity of sepsis in increasing the cells involved in innate immunity. Mean expression of GENES showed significant fold change between survivors and non-survivors which increased as SOFA score increased. (Fig. 1,2). For diagnosing Abdominal sepsis, a sepsis NLRP1, IDNK, and PLAC8 gene expression score [sNIP score, equation: (NLRP1-IDNK)/PLAC8] was defined with a threshold at -0.12. Abdominal sepsis (perforation) showed a (median = 0.02; IQR = -0.63) score with other infections (median = 0.41; IQR = 2.19), demonstrating the utility of the score in diagnosing patients. 'Septi-Score' using a 4-gene signature (Septicyte™ LAB) was validated in both survivors and non survivors with an average score of 5 and above.

Conclusions. In this Pilot study "Gene set approach" was used to assess the severity of sepsis and predict the progression of organ dysfunction and improvement. The transcriptomic response of genes encoding for neutrophil-mediated response and innate pro-inflammatory response along with "GENE SET'S" encoding for ARDS and AKI, showed ability to predict organ dysfunction in Lung, Kidney, cardiomyopathy and coagulopathy. Further study is ongoing in standardising the expression of Genes/"SET'S" i.e. the threshold (cut off value) at which organ failure can be predicted and to include this approach along with other biomarkers in routine evaluation of patients Sepsis.

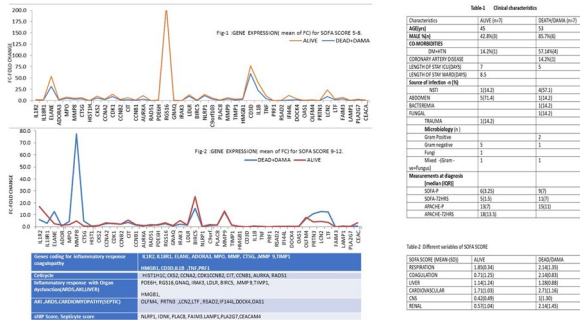

Clinical characteristics and Transcriptomic profile.

References

- Scicluna BP, et al. A Molecular Biomarker to Diagnose Community-acquired Pneumonia on Intensive Care Unit Admission. *Am J Respir Crit Care Med.* 2015 [PubMed]
- IRB Christian Medical College Vellore
- Almansa R, et al. Transcriptomic correlates of organ failure extent in sepsis. *J Infect.* 2015; 70:445–456. [PubMed: 25557485]
- Wu D, Lim E, Vaillant F, Asselin-Labat ML, Visvader JE, Smyth GK. ROAST: rotation gene set tests for complex microarray experiments. *Bioinformatics.* 2010 Sep 1;26(17):2176–82. <https://doi.org/10.1093/bioinformatics/btq401>. Epub 2010 Jul 7. PMID: 20610611; PMCID: PMC2922896
- Nesselser N, Launey Y, Aninat C, Morel F, Mallédant Y, Seguin P. Clinical review: The liver in sepsis. *Crit Care.* 2012 Oct 30;16(5):235. <https://doi.org/10.1186/cc11381>. PMID: 23134597; PMCID: PMC3682239
- Basu RK, Standage SW, Cvijanovich NZ, et al. Identification of candidate serum biomarkers for severe septic shock-associated kidney injury via microarray. *Crit Care Lond Engl* 2011; 15:R273
- Kangelaris, Kirsten Neudorffer et al. "Increased expression of neutrophil-related genes in patients with early sepsis-induced ARDS." *American journal of physiology. Lung cellular and molecular physiology* vol. 308,11 (2015): L1102-13. <https://doi.org/10.1152/ajplung.00380.2014>
- Miller RR 3rd, Lopansri BK, Burke JP, et al. Validation of a Host Response Assay, SeptiCyte LAB, for Discriminating Sepsis from Systemic Inflammatory Response Syndrome in the ICU. *Am J Respir Crit Care Med.* 2018 Oct 1;198(7):903–913. <https://doi.org/10.1164/rccm.201712-2472OC>. Erratum in: *Am J Respir Crit Care Med.* 2020 Jul 1;202(1):155. PMID: 29624409; PMCID: PMC6835074.
- Hinrichs C, Kotsch K, Buchwald S, Habicher M, Saak N, Gerlach H, Volk HD, Keh D. Perioperative gene expression analysis for prediction of postoperative sepsis. *Clin Chem.* 2010 Apr;56(4):613–22. <https://doi.org/10.1373/clinchem.2009.133876>. Epub 2010 Feb 4. PMID: 20133891

Topic: Sepsis.

000345

A new technology for the comprehensive assessment of microcirculation: the VASCOVID project

E. Prieto¹, A. Sellas¹, M. Zanoletti², M. Yakub², L. Cortese², D. Contini³, A. Caballer¹, T. Durduran², J. Mesquida¹

¹Àrea de crítics, Parc Tauli Hospital Universitari, Sabadell, Spain; ²Medical optics group, ICFO—The Institute of Photonic Sciences, Castelldefels, Spain; ³Dipartimento di fisica, Politecnico di Milano, Milano, Italy

Correspondence: E. Prieto

Intensive Care Medicine Experimental 2023, 11(Suppl 1):000345

Introduction. In the last 15 years, monitoring of peripheral tissue oxygenation by near-infrared spectroscopy (NIRS) systems has demonstrated prognostic value in different critical pathology scenarios. In addition to the baseline tissue oxygen saturation (StO₂) value, informative parameters of the individual’s metabolic state and microvascular reactivity (endothelial function) can be obtained from a transient vascular occlusion (TOV) test. However, commercial NIRS systems use continuous wave (CW)-NIRS technology, associated to much variability and unreliability in obtaining actual oxy- and deoxy-hemoglobin values. The VASCOVID project is a European framework project, financed by Horizon2020 funds from the European Commission, and born from the association of different academic, research, clinical and industry actors, to develop a new, more robust and reliable NIRS system for application in the critical care setting. The VASCOVID project is based on time resolved (TR)-NIRS technology, with improved performance in the quantification of hemoglobin oxygenation, and incorporates Diffuse Correlation Spectroscopy (DCS), which allows to obtain values of hemoglobin movement in the tissue, deriving microvascular flow [1]. The first clinical work of VASCOVID has been aimed at characterizing the microcirculatory state with the new technology in healthy population and patients admitted to the ICU.

Methods. Prospective observational study in a 30-bed general ICU. The microcirculatory status was analyzed using the VASCOVID system, placed on the brachioradialis muscle, in healthy population and in critical, septic and non-septic patients, during the first days of admission. A baseline measurement of StO₂ and blood flow index (BFI) was performed, followed by TOV, from which local metabolism (nirVO₂), reoxygenation rate (ReO₂), and hyperemia in oxygenation (AUCH) and flow (AUCBFI) in response to ischemia were derived. A comparative analysis was performed with t-Student test for independent samples of the populations studied.

Results. A total of 20 healthy individuals and 60 critically ill patients, 13 septic and 47 non-septic, were included. The critical patient population presented significant alterations with respect to the healthy population in all microcirculatory parameters with the exception of microvascular flow (Fig. 1). When the septic population and the non-septic critically ill patient population were compared, significant differences were found in basal microvascular flow (septic BFI 0.32 ± 0.18 cm²/sec vs non-septic 0.46 ± 0.37 cm²/sec) and metabolic rate (septic nirVO₂ $- 12.2 \pm 10.7$ U vs non-septic $- 19.1 \pm 11.3$ U).

Conclusions. The VASCOVID project aims to validate TR-NIRS/DCS technology as an evolution of traditional CW-NIRS systems, incorporating the possibility of quantifying microcirculatory flow at the bedside. Preliminary results of the project show that the system can detect differences between healthy and impaired microcirculation, as well as detect alterations specific to septic patients. This new technology may be a useful tool for the assessment of the microcirculatory status of the critically ill patient.

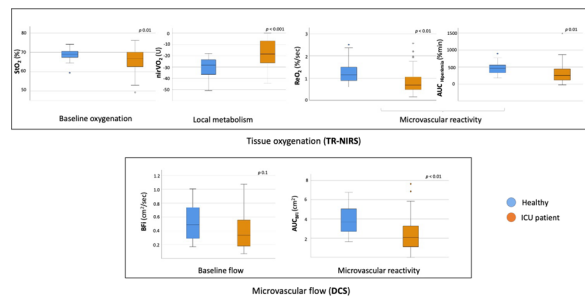

Figure 1 (abstract 000345) .

References

- [1] Giovannella M, Spinelli L, Pagliuzzi M, Contini D, Greisen G, Weigel UM, Torricelli A, Durduran T. Accuracy and precision of tissue optical properties and hemodynamic parameters estimated by the BabyLux device: a hybrid time-resolved near-infrared and diffuse correlation spectroscopy neuro-monitor. *Biomed Opt Express* 2019;10(5):2556–2579
- All the VASCOVID consortium: Parc Taulí; ICFO; Politecnico di Milano, Milano; PIONIRS, Milano; ASPHALION, Barcelona; SPLENDO, The Netherlands; BioPixS-Biophotonics, Ireland

Topic: Cardiovascular issues in ICU.

000346

Institutional risk factors associated with ventilator-associated pneumonia: IMPACTO-MR platform prospective cohort study

B. Tomazini¹, L. C. P. D. Azevedo², R. R. De Mattos², C. Dietrich², C. Impacto-Mr³, B. Besen²

¹Critical Care, Hospital Sirio Libanes, São Paulo, Brazil; ²Diretoria de compromisso social, Hospital Sirio-Libanês, São Paulo, Brazil; ³PROADI-SUS, IMPACTO-MR, São Paulo, Brazil

Correspondence: B. Besen

Intensive Care Medicine Experimental 2023, **11(Suppl 1)**:000346

Introduction. There have been many studies evaluating different strategies for ventilator-associated pneumonia (VAP) prevention, including single interventions and devices, bundles and protocols. However, other institutional risk factors that could be associated with the risk of VAP have not been deeply explored, especially in low and middle-income countries.

Objectives. To evaluate institutional risk factors (from the perspective of ICU staffing and protocols and infection control services) for ventilator-associated pneumonia (VAP) in a middle-income country.

Methods. This observational prospective cohort study was nested on the IMPACTO-MR platform, which comprised 51 centers in Brazil, from September 2019 to December 2021. Individual patients' data was prospectively collected and institutional data was collected with surveys. VAP diagnosis was prospectively reported by each center. We fit Cox models with institutional risk factors modelled as fixed effects accounting for patients' confounding variables at baseline. We explored two sets of institutional risk factors: ICU staffing patterns and protocols and infection control services protocols. For ICU staffing, we included an interaction term to allow for their possible dependencies. Results are presented as hazard ratios (HR) with respective 95% confidence intervals (95%CI).

Results. Of 17,027 patients at risk, 1958 patients (with 198,980 patient-days) were diagnosed with VAP. 43 (84.3%) hospitals had a VAP prevention protocol and 27 (52.9%) had a mechanical ventilator weaning protocol. Staff and infection control services factors associated with a lower risk of VAP were respiratory therapists empowerment to wean invasive mechanical ventilation (HR 0.43, 95%CI 0.37–0.50, $p < 0.001$), annual or semiannual hand hygiene training (both $p < 0.001$ compared to never training), single use protective gowns (HR 0.78, 95%CI 0.69–0.87, $p < 0.001$), personal protective equipment use training (HR 0.68, 95%CI 0.59–0.78, $p < 0.001$) and a VAP prevention protocol (HR 0.21, 95%CI 0.16–0.28, $p < 0.001$). Risk factors for VAP were a higher number of patients per physician (HR 1.20, 95%CI 1.11–1.30, $p < 0.001$), a higher number of patients per bedside-health professional team (nurses and respiratory therapists) member (HR 6.91, 95% 3.85–12.40, $p < 0.001$), which negatively interacted (HR 0.76, 95%CI 0.70–0.83, $p < 0.001$), and a higher proportion of single-bed rooms in ICU (HR 1.50, 95%CI 1.26–1.77, $p < 0.001$). Family visitation duration (hours) was not associated with higher risk of VAP.

Conclusions. VAP prevention may be better accomplished if institutional processes and structure are considered. Avoiding a high number

of patients per physician and bedside-health professionals, along with empowering the team towards faster weaning may reduce the risk of VAP. Infection control services could further reduce the risk of VAP by routine institutional training.

References

- Oliveira RD, Bustamante PFO, Besen BAMP. Tackling healthcare-associated infections in Brazilian intensive care units: we need more than collaboration. *Rev Bras Ter Intensiva*. 2022;34(3):313–315. Published 2022 Nov 4.
- Zampieri FG, Soares M, Borges LP, Salluh JIF, Ranzani OT. The Epimed Monitor ICU Database: a cloud-based national registry for adult intensive care unit patients in Brazil. *Rev Bras Ter Intensiva*. 2017;29(4):418–426.
- Tomazini BM, Nassar AP Jr, Lisboa TC, et al. IMPACTO-MR: a Brazilian nationwide platform study to assess infections and multidrug resistance in intensive care units. *Rev Bras Ter Intensiva*. 2022;34(4):418–425.
- Bardossy AC, Zervos J, Zervos M. Preventing Hospital-acquired Infections in Low-income and Middle-income Countries: Impact, Gaps, and Opportunities. *Infect Dis Clin North Am*. 2016;30(3):805–18.
- This study was funded by the Program to Support Institutional Development of Universal Health System (Programa de Apoio ao Desenvolvimento Institucional do Sistema Único de Saúde—PROADI-SUS), a nationwide program aimed at strengthening and qualifying the Brazilian Universal Health System (SUS) throughout the country. It has been sponsored by the Sociedade Beneficente de Senhoras – Hospital Sirio-Libanês.

Topic: Infections and prevention.

000347

Comparing lung mechanics of patients with COVID related respiratory distress syndrome versus non-COVID acute respiratory distress syndrome: a retrospective observational study

F. Chacón Lozán¹, P. Tamasi¹

¹Anesthesia and Intensive Care Unit, Péeterfy Sándor Hospital, Budapest, Hungary

Correspondence: F. Chacón Lozán

Intensive Care Medicine Experimental 2023, **11(Suppl 1)**:000347

Introduction. Most patients admitted to the intensive care unit with coronavirus disease (COVID-19) develop severe respiratory failure. Understanding lung mechanics helps to guide protective mechanical ventilation, improve oxygenation, and reduce the ventilator induce lung injury.

Objectives. This study aims to describe lung mechanics characteristics of patients with COVID-19 related acute respiratory distress syndrome (ARDS) and to compare them with non-COVID-19 associated ARDS.

Methods. We performed a retrospective observational study of lung mechanics: plateau pressure (Pplat), Driving pressure (DP), Mechanical power (MPw), Elastic (dynamic) power (EdPw), Total ventilatory power (TPw), and oxygenation parameters (ratio of arterial oxygen partial pressure to fractional inspired oxygen (PaO₂/FiO₂), the ratio of arterial oxygen partial pressure to fractional inspired oxygen multiplied by PEEP [PaO₂/(FiO₂ × PEEP)], arterial and venous carbon dioxide partial pressure (PaCO₂, PvCO₂), and Ventilation dead space (VD) were measured and compared between the two groups after initiation of mechanical ventilation.

Results. 30 CARDS and 10 ARDS patients fulfilled the study requirements. We observed a significant higher MPw in the CARDS group (29.17 ± 8.29 J/min vs 15.78 ± 4.45 J/min, $P 0.007$), similarly observed with EdPw (256.7 ± 84.06 mJ/min vs 138.1 ± 39.15 mJ/min, $P 0.01$) and TPw (289.1 ± 84.51 mJ/min vs 161.5 ± 45.51, $P 0.007$). Inside the CARDS group, we found 2 subgroups, a low shunt subgroup and a higher shunt (Qs/Qt (%): 6.61 ± 2.46 for vs 40.3 ± 20.6, $P 0.0009$), however,

between these two subgroups we didn't find statistical differences on lung mechanic parameters but only in oxygenation parameters (PaO₂/FiO₂ and PaO₂/FiO₂*PEEP). When comparing these two subgroups with ARDS patients, we found more similarity between the low shunt CARDS and the ARDS patients on MP (R2 0.99, P 0.001), EdPw (R2 0.89, P 0.05) and TPw (R2 0.99, P 0.0009).

Conclusions. Our study suggests important differences between CARDS and ARDS regarding mechanical parameters that could lead to more complicated management of CARDS patients and a higher prevalence of VILI. However due to the study limitations, a bigger study is necessary to corroborate our findings.

Topic: Acute respiratory failure and mechanical ventilation.

000348

Risk factors associated with disability and mortality in patients admitted to a neurotraumatic ICU with decompressive craniectomy after discharge. A nine-year prospective study

C. Sánchez Ramírez¹, C. F. Lúbbe Vázquez¹, L. D. M. Díaz Suárez¹, M. Cabrera Sánchez¹, A. Padrón Mujica¹, P. Saavedra-Santana², S. Ruiz-Santana¹

¹Intensive care medicine, University Hospital of Gran Canaria Dr. Negrín, Las Palmas de Gran Canaria, Spain; ²Mathematics and informatics department, University of Las Palmas, Las Palmas de Gran Canaria, Spain

Correspondence: C. Sánchez Ramírez

Intensive Care Medicine Experimental 2023, 11(Suppl 1):000348

Introduction. Second-level therapeutic actions to control intracranial hypertension (ICH) proposed by the European Brain Trauma Foundation include barbiturates, moderate hypothermia, and decompressive craniectomy (DC), but the results are controversial. Our aim was to evaluate factors associated with disability and mortality after ICU discharge in patients undergoing DC.

Objectives. To evaluate factors associated with disability and mortality, after ICU discharge, in patients with DC after 9 years.

Methods. Prospective study of patients admitted between January 1, 2013 and December 1, 2022 who required DC. The DC was performed for ICH refractory to medical treatment. The following were analyzed: main admission diagnosis; demographic data; neurological data (clinical examination and Glasgow Coma Score: GCS); hypotension; type of craniectomy and DC complications; Rankin scale and Glasgow Outcome Scale (GOS) at 30 and 60 days after ICU admission, at ICU discharge and 6 months after ICU discharge; preoperative serum lactate levels; hypo- and hyperglycemia; application of mannitol or hypertonic saline before and after DC; leukocytes and platelets before and after DC and other factors related to prognosis. Univariate analysis was performed for disability (Rankin \geq 3) and ICU mortality, 60 days after ICU admission and 6 months after ICU discharge. Statistical significance was set at $p \leq 0.05$. Data were analyzed using the R package version 4.2.1 (R Development Core Team, 2022).

Results. Fifty-five patients with DC were collected. Demographic data and types of admission are shown in Table 1. The majority of the DC were subarachnoid hemorrhage (SAH) 26 (47.3%), and traumatic brain injury (TBI) 20 (37.0%). The most frequent complications were hydrocephalus 22 (40.7%) and reoperation for complications 18 (34.6% of them). Ten patients died at ICU discharge (18.5%), 7 (41.2%) of them due to SAH. Of the 20 (37.0%) patients with TBI 6 (35.3%) patients with DC died, 3 of them at ICU discharge. Rankin score at ICU discharge was 5 and GOS was 3. Rankin score 6 months after ICU discharge was 4 and GOS was 3. No significant risk factors associated with disability after ICU discharge were found. Mortality at 6 months after discharge was significantly associated with bilateral pupillary reactivity prior to DC (Table 2).

Conclusions. DC patients had a low mortality rate in the ICU (18.5%). The DC patients with TBI also had a low mortality rate of 15% at ICU discharge. Rankin and GOS reflected moderate/severe disability in these patients, in the ICU and 6 months after ICU discharge. Mortality, 6 months after discharge, was significantly associated with bilateral pupillary reactivity before DC.

Table 1 (abstract 000348) Univariate analysis of DC disability at ICU discharge 9 years

	Rankin at ICU discharge		
	< 3 N = 10	\geq 3 N = 45	
Age (years)	43.7 \pm 16.1	46.9 \pm 13.6	0.517
Sex female	4 (40.0)	15 (33.3)	0.723
APACHE-II	24 (21 - 26)	22 (18 - 26)	0.319
GCS at admission	10 (6 - 13)	8 (5 - 14)	0.935
GCS at ICU admission	4 (3 - 10)	3 (3 - 7)	0.401
ICU-Deaths	0	10 (22.2)	0.183
Hospital-Deaths	0	5 (11.9)	0.571
Discharge of the Hospital-Deaths	0	6 (16.2)	0.572
Deaths	0	17 (37.8)	0.022
Diabetes mellitus	1 (10.0)	6 (13.3)	1
Arterial hypertension	3 (30.0)	7 (15.6)	0.365
Disypemia	2 (20.0)	8 (17.8)	1
Tumor	1 (11.1)	3 (6.7)	0.529
SAH	5 (50.0)	21 (46.7)	1
Stroke Malignant middle cerebral artery	1 (10.0)	11 (24.4)	0.43
Acute subdural hematoma	3 (33.3)	14 (31.1)	1
Obiteration of base cisterns	2 (22.2)	19 (42.2)	0.456
Focal contusion with edema and expansivity	5 (55.6)	17 (37.8)	0.461
Evacuated Injury	2 (22.2)	10 (22.2)	1
TBI	5 (50.0)	15 (34.1)	0.471
OTI previous hospital admission	4 (40.0)	11 (24.4)	0.434
OTI Emergency	2 (20.0)	20 (44.4)	0.284
OTI on Surgery	3 (30.0)	8 (17.8)	0.4
Transfusion prior to DC	1 (11.1)	9 (20.4)	0.726
Pre-craniectomy seizures	1 (11.1)	7 (15.9)	1
Hydrocephalus	2 (22.2)	20 (44.4)	0.283
Reoperation for complications	1 (12.5)	17 (38.5)	0.236
Bilateral areactive mydriasis prior to DC	0	5 (11.4)	0
Both reactive pupils prior to DC	7 (87.5)	29 (64.4)	0.412
One reactive pupil prior to DC	0	8 (17.8)	0.578
None-reactive pupils prior to DC	1 (12.5)	5 (11.1)	1
Midline shift on CT at admission	2 (0 - 10)	6 (1 - 10)	0.558
Number of Platelets prior to DC	263 (249 - 291)	214 (172 - 262)	0.09
Rankin ICU discharge	1 (1 - 1)	5 (4 - 5)	< .001
Rankin Hospital discharge	1 (1 - 1)	5 (4 - 6)	< .001
GOS ICU discharge	5 (4 - 5)	3 (2 - 3)	< .001
GOS Hospital discharge	5 (5 - 5)	3 (1 - 4)	< .001

Data are means and medians (IQR) and frequencies (%). SAH: subarachnoid hemorrhage; TBI: trauma brain injury; OTI: orotracheal intubation; DC: decompressive craniectomy.

Table 2 (abstract 000348) Univariate analysis of DC mortality six months after ICU discharge 9 years

	Overall N = 38	Alive N = 38	Deaths N = 17	P
Age (years)	46.3 \pm 14.0	45.9 \pm 14.4	47.4 \pm 13.4	0.729
Sex female	19 (34.5)	11 (28.9)	8 (47.1)	0.192
APACHE-II	22 (18 - 25)	22 (18 - 25)	22 (20 - 24)	0.68
Diabetes Mellitus	7 (12.7)	4 (10.5)	3 (17.6)	0.664
Arterial hypertension	10 (18.2)	7 (18.4)	3 (17.6)	1
Disypemia	10 (18.2)	7 (18.4)	3 (17.6)	1
Tumor	4 (7.4)	2 (5.4)	2 (11.8)	0.582
SAH	26 (47.3)	19 (50.0)	7 (41.2)	0.545
Stroke Malignant middle cerebral artery	12 (21.8)	6 (15.8)	6 (35.3)	0.158
Acute subdural hematoma	17 (31.5)	13 (35.1)	4 (23.5)	0.394
Obiteration of base cisterns	21 (38.9)	14 (37.8)	7 (41.2)	0.815
Non-evacuated hematoma	9 (16.7)	8 (21.6)	1 (5.9)	0.244
Focal contusion with edema and expansivity	22 (40.7)	18 (48.6)	4 (23.5)	0.081
Evacuated Injury	12 (22.2)	8 (21.6)	4 (23.5)	1
TBI	20 (37.0)	14 (37.8)	6 (35.3)	0.857
None-reactive pupils prior to DC	6 (11.3)	3 (8.3)	3 (17.6)	0.372
OTI previous hospital admission	15 (27.3)	11 (28.9)	4 (23.5)	0.754
OTI Emergency	22 (40.0)	14 (36.8)	8 (47.1)	0.475
OTI on Surgery	11 (20.0)	8 (21.1)	3 (17.6)	1
Transfusion prior to DC	10 (18.9)	7 (18.9)	3 (18.8)	0.477
Pre-craniectomy seizures	8 (15.1)	5 (13.5)	3 (18.8)	0.685
Hydrocephalus	22 (40.7)	13 (35.1)	9 (52.9)	0.216
Reoperation for complications	18 (34.6)	12 (33.3)	6 (37.5)	0.771
Bilateral areactive mydriasis prior to DC	5 (9.4)	3 (8.1)	2 (12.5)	0.632
Both reactive pupils prior to DC	36 (67.9)	28 (77.8)	8 (47.1)	0.025
One reactive pupil prior to DC	8 (15.4)	4 (11.4)	4 (23.5)	0.413
None-reactive pupils prior to DC	6 (11.3)	3 (8.3)	3 (17.6)	0.372
ICU-Deaths	10 (18.5)	0	10 (58.8)	< .001
Hospital-Deaths	5 (9.8)	0	5 (29.4)	0.003
Discharge of the Hospital-Deaths	6 (13.3)	0	6 (35.3)	0.002
Midline shift on CT at admission	6 (1 - 10)	5 (0 - 10)	7 (3 - 10)	0.369
GCS on admission	8 (5 - 14)	8 (5 - 14)	8 (6 - 13)	1
GCS at ICU admission	3 (3 - 7)	3 (3 - 7)	3 (3 - 5)	0.898
Rankin ICU discharge	5 (4 - 5)	4 (2 - 5)	6 (5 - 6)	< .001
Rankin Hospital discharge	4 (2 - 5)	4 (1 - 5)	6 (6 - 6)	< .001
Number of Platelets prior to DC	224 (182 - 271)	224 (183 - 265)	228 (180 - 326)	0.515

Data are means and medians (IQR) and frequencies (%). SAH: subarachnoid hemorrhage; TBI: trauma brain trauma injury; OTI: orotracheal intubation; DC: decompressive craniectomy.

Topic: Neurointensive care.

000349

Association of vital sign alerts and rapid response system notifications at the general wards with the outcomes of patients who returned to the ICU: a retrospective restrictive cubic spline analysis in Taiwan

J. S. Jerng¹, C. K. Lin², L. C. Chen², P. Y. Chuang³, S. Y. Chen⁴

¹Department of Internal Medicine, National Taiwan University Hospital, Taipei, Taiwan; ²Center for Quality Management, National Taiwan University Hospital, Taipei, Taiwan; ³Department of Nursing, National Taiwan University Hospital, Taipei, Taiwan; ⁴Department of Emergency Medicine, National Taiwan University Hospital, Taipei, Taiwan

Correspondence: J.S. Jerng

Intensive Care Medicine Experimental 2023, **11(Suppl 1)**:000349

Introduction. Unplanned return to the intensive care units (ICUs) is an important quality indicator for the care continuum across critical care and general care settings. Detection and timely management of physiologic deterioration in patients transferred to the general wards from the ICUs might be of prognostic importance.

Objectives. To investigate whether the detection and alerts of vital signs deterioration and the notifications to the rapid response system (RRS) of physiologic abnormalities are of prognostic importance in patients who returned to the ICUs.

Methods. We retrospectively analyzed the demographic and clinical data of the patients who returned to the ICUs within 7 days of stay of their transfer to the general wards in 2019–2021. The hospital established a healthcare information system (HIS)-based automated alert system for vital sign abnormalities by immediate screening after the nurses' entry of vital sign data. The nurses were provided with decision support pop-ups to notify the rapid response system of the hospital for timely patient management. Relevant information regarding the occurrence of vital sign alerts automatically generated by the hospital's healthcare information system and the notifications to the hospital's rapid response system were retrieved and analyzed for association with the outcomes of those patients in the hospital. The restrictive cubic spline method was applied to assess the probability of the non-linear relationship between the variables and the in-hospital mortality rate.

Results. During the study period, 474 patients returned to the ICU within 7 days at wards, of whom 59.7% were male, 53.6% were from medical ICUs, and 27.4% and 25.5% had the main diagnosis of cardiovascular diseases and malignancies, respectively. Their medium stay at the general ward was 3.1 [Interquartile, 1.3–4.9] days, and their medium hospital stay after the returned ICU was 25.2 [11.6–48.6] days. Male (13.8% vs. 7.3%, $p=0.029$) and medical patients ($p<0.001$) had poorer in-hospital outcomes (in-hospital mortality). Patients with early (<72 h) returns ($p=0.014$) and early occurrence of vital sign alerts ($p=0.011$) had higher mortality rates. Restrictive cubic spline analyses for a non-linear relationship showed that the in-hospital mortality rate was the lowest for those patients with the interval between transfer to the general ward and first vital sign alert. An interval shorter than 48 or longer than 72 h indicated a trend of increased risk of in-hospital mortality, with a U-shaped relationship (Fig. 1). In contrast, the relationship between general ward stay time, and mortality remained more linear, with a gradually reduced mortality rate when the ward stays time was longer (Fig. 2).

Conclusions. The detection and alerts of vital sign abnormalities after the transfer to the general wards of ICU patients are associated with in-hospital mortality by a non-linear relationship.

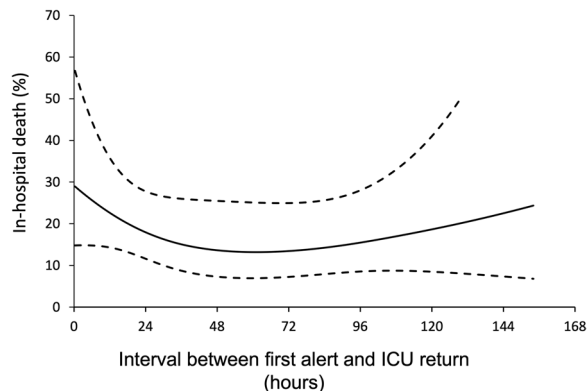

Figure 1 (abstract 000349) .

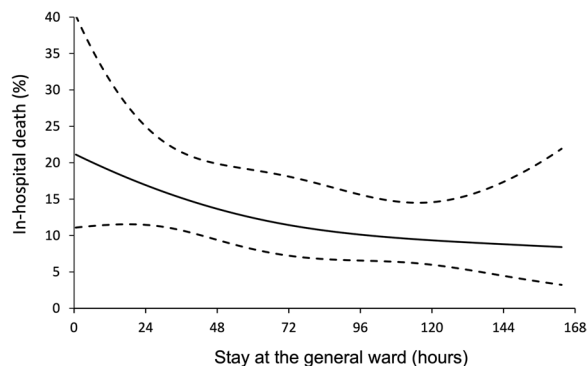

Figure 2 (abstract 000349) .

Topic: Cardiac arrest.

000350

Association between fluid balance and clinical outcomes in pediatric acute respiratory distress syndrome: a single-center retrospective cohort study

J. E. Yoo¹, H. Kim¹, Y. Y. Roh¹, M. R. Park¹, J. D. Kim¹, M. J. Kim¹, Y. J. Lee¹, Y. H. Kim¹, K. W. Kim¹, M. H. Sohn¹, S. Y. Kim¹

¹Department of Pediatrics, Yonsei University College of Medicine, Seoul, Republic of Korea

Correspondence: J.E. Yoo

Intensive Care Medicine Experimental 2023, **11(Suppl 1)**:000350

Introduction. Positive fluid balance is correlated with worse outcomes in pediatric acute respiratory distress syndrome (PARDS). However, there are scarce data on particularly 'when' in the illness time-course significantly affects prognosis. We aimed to determine the trend of daily and cumulative fluid management practices and the relationship between the timing of fluid overload and clinical outcomes in PARDS.

Methods. The study included 320 children who required invasive mechanical ventilation and were diagnosed with PARDS according to the oxygenation index of Pediatric Acute Lung Injury Consensus

Conference definition from June 2009 to March 2021. Daily and cumulative total intake, output, and balance data were retrospectively collected from days 1 to 7 after PARDS onset. Association between fluid metrics and clinical outcomes of PARDS were tested.

Results. Daily and cumulative total intake show a decrease over time during the study period. In multivariable analysis, fluid intake on day 6 and 7 was significantly associated with increased mortality (OR [95% CI]; 1.019 [1.006–1.031], $P=0.003$, and 1.022 [1.009–1.035], $P=0.001$, respectively). The fluid intake on day 1 was significantly associated with decreased ventilator-free days (VFDs) ($\beta = -0.030$, $P=0.002$). Cumulative fluid balance in the early period (through day 4 and day 3, respectively) was significantly associated with risk of increased mortality (OR [95% CI]; 1.007 [1.002–1.012], $P=0.005$) and decreased VFDs ($\beta = -0.026$, $P=0.002$).

Conclusions. Positive fluid balance in the acute phase is associated with risk of increased mortality and decreased VFDs in PARDS. Moreover, increased fluid intake itself is significantly associated with adverse outcomes in PARDS.

References

1. Pediatric acute respiratory distress syndrome: consensus recommendations from the Pediatric Acute Lung Injury Consensus Conference. *Pediatr Crit Care Med.* 2015;16(5):428–39. 2. Valentine SL, Sapru A, Higginson RA, Spinella PC, Flori HR, Graham DA, et al. Fluid balance in critically ill children with acute lung injury. *Crit Care Med.* 2012;40(10):2883–9. 3. Lima L, Menon S, Goldstein SL, Basu RK. Timing of Fluid Overload and Association With Patient Outcome. *Pediatr Crit Care Med.* 2021;22(1):114–24. 4. van Mourik N, Metske HA, Hofstra JJ, Binnekade JM, Geerts BF, Schultz MJ, et al. Cumulative fluid balance predicts mortality and increases time on mechanical ventilation in ARDS patients: An observational cohort study. *PLoS One.* 2019;14(10):e0224563. 5. Silversides JA, Ferguson AJ, McAuley DF, Blackwood B, Marshall JC, Fan E. Fluid strategies and outcomes in patients with acute respiratory distress syndrome, systemic inflammatory response syndrome and sepsis: a protocol for a systematic review and meta-analysis. *Syst Rev.* 2015;4:162. 6. Flori HR, Church G, Liu KD, Gildengorin G, Matthay MA. Positive fluid balance is associated with higher mortality and prolonged mechanical ventilation in pediatric patients with acute lung injury. *Crit Care Res Pract.* 2011;2011:854142. 7. Black CG, Thomas NJ, Yehya N. Timing and Clinical Significance of Fluid Overload in Pediatric Acute Respiratory Distress Syndrome. *Pediatr Crit Care Med.* 2021;22(9):795–805. 8. Malbrain MLNG, Van Regenmortel N, Saugel B, De Tavernier B, Van Gaal P-J, Joannes-Boyau O, et al. Principles of fluid management and stewardship in septic shock: it is time to consider the four D's and the four phases of fluid therapy. *Annals of Intensive Care.* 2018;8(1):66. 9. Willson DF, Thomas NJ, Tamburro R, Truempel E, Truweit J, Conaway M, et al. The relationship of fluid administration to outcome in the pediatric calfactant in acute respiratory distress syndrome trial. *Pediatr Crit Care Med.* 2013;14(7):666–72. 10. Zinter MS, Spicer AC, Liu KD, Orwoll BE, Alkhouli MF, Brakeman PR, et al. Positive Cumulative Fluid Balance Is Associated With Mortality in Pediatric Acute Respiratory Distress Syndrome in the Setting of Acute Kidney Injury. *Pediatr Crit Care Med.* 2019;20(4):323–31. 11. Unki P, Save S. Analysis of Fluid Balance as Predictor of Length of Assisted Mechanical Ventilation in Children Admitted to Pediatric Intensive Care Unit (PICU). *Int J Pediatr.* 2022;2022:2090323. 12. Wiedemann HP. A perspective on the fluids and catheters treatment trial (FACTT). Fluid restriction is superior in acute lung injury and ARDS. *Cleve Clin J Med.* 2008;75(1):42–8. 13. Seitz KP, Caldwell ES, Hough CL. Fluid management in ARDS: an evaluation of current practice and the association between early diuretic use and hospital mortality. *Journal of Intensive Care.* 2020;8(1):78.

Topic: Acute respiratory failure and mechanical ventilation.

000352

Early prediction of neurological outcomes with automatically computed gray-white matter ratio of early brain CT scan images in cardiac arrest

H. H. Tsai¹, C. Chi², L. W. Wang², Y. J. Su², M. S. Tsai², C. Hsu³, C. H. Huang², W. Wang⁴

¹Computer Science and Information Engineering, National Taiwan University, Taipei, Taiwan; ²Emergency medicine, National Taiwan University Hospital, Taipei, Taiwan; ³Oncology, National Taiwan University Hospital, Taipei, Taiwan; ⁴Institute of Applied Mathematical Sciences, National Taiwan University, Taipei, Taiwan

Correspondence: C.H. Huang

Intensive Care Medicine Experimental 2023, **11(Suppl 1)**:000352

Introduction. The gray-white matter ratio (GWR) obtained from brain CT scans is a crucial factor in the early prediction of cardiac arrest patient outcomes. However, manual annotation by physicians is impractical in emergency and critical care situations.

Objectives. To develop an automatic method which can rapidly compute the GWR and predict outcomes, aiding physicians in decision making.

Methods. A retrospective study of 684 patients who underwent brain CT imaging within 12 h after return of spontaneous circulation (ROSC) was conducted. The primary outcomes were favorable neurological outcome and survival to hospital discharge. Physicians manually annotated 16 regions of interest (ROIs) on each CT image. In addition, an automatic method derived the ROIs by registering the brain CT image to the Eve template. The performance of the automatic method was compared with that of manual annotation to evaluate its accuracy.

Results. After removing outliers, we examined the data from 525 CT scans of the brain as shown in Fig. 1. The proposed method for calculating the GWR yielded better results for patients with the favorable neurological outcome (1.140 [SD 0.046] vs. 1.100 [0.054], $p < 0.0001$), and Fig. 2 showed a strong correlation with manual calculation (0.872 [95% CI 0.849 to 0.891], $p < 0.0001$). Additionally, compared with the manual method (0.679), the proposed method gave a higher AUROC (0.729) for outcome prediction as shown in Fig. 3(A). The automatic method was a significant independent predictor for favorable neurological outcome in multiple logistic regression analysis ($P < 0.001$) with a high AUROC (0.841) for the model (Fig. 3B).

Conclusions. The study revealed that the incorporation of the automatically computed GWR led to a significant enhancement in the prediction of favorable neurological outcomes. These findings suggest that the proposed method could efficiently and accurately determine the GWR, providing valuable information for predicting patient outcomes.

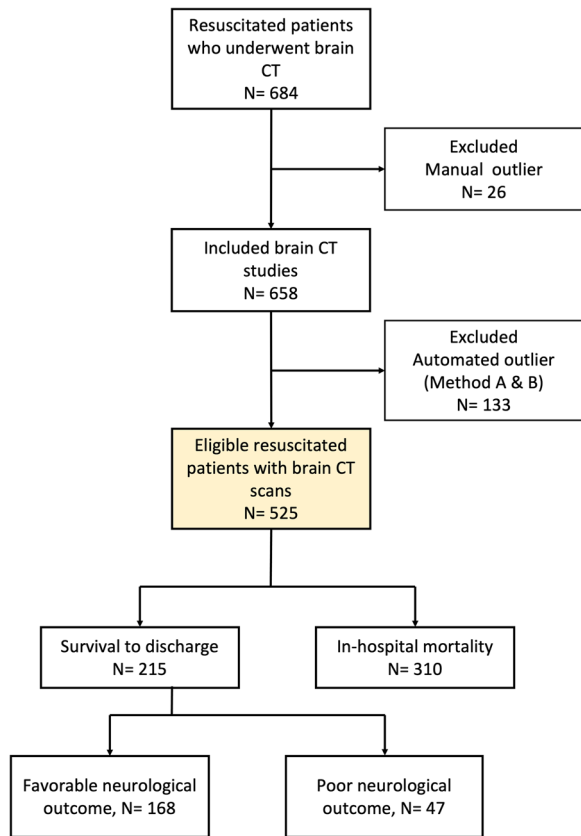

Figure 1 (abstract 000352) Patient flow chart

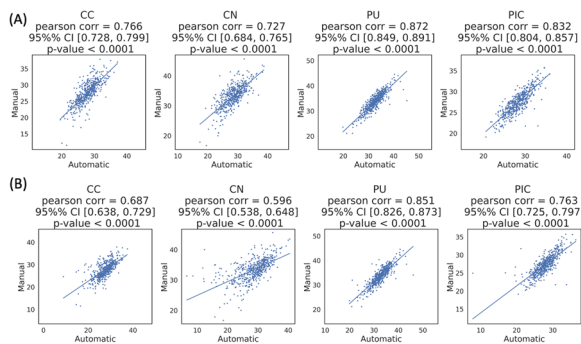

Figure 2 (abstract 000352) HU density of the manual and automatic methods in the caudate nuclei, corpus callosum, putamen, and posterior internal capsule. (A) Correlation between the manual and Auto A methods. (B). Correlation between the manual and Auto B methods

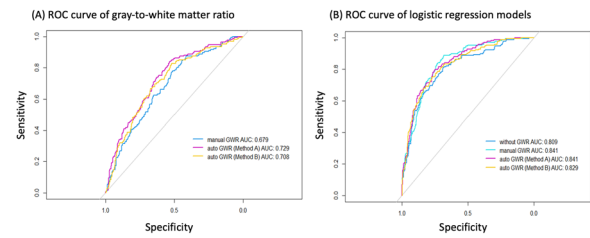

Figure 3 (abstract 000352) ROC curves and AUROCs for predicting favorable neurological outcome. (A) GWRs measured using the manual, Auto A, and Auto B methods. (B) Multiple logistic regression models with the manual, Auto A, and Auto B GWRs

References

1. This study was supported by the Taiwan Ministry of Science and Technology (MOST 111-2634-F-002-015-, Capstone project). The authors thank Tsung-Yu Huang for assistance in statistical analysis.

Topic: Cardiac arrest.

000353

The relationship between level of Piezo2 in BALF and prognosis of ARDS patients

H. Xiong¹, G. Jun¹, X. Yu², H. Xiangjun¹, P. Feng¹, W. Bo¹
¹intensive care unit, West China Hospital, Sichuan University, Cheng Du Shi, China; ²School of nursing, Qingdao University Medical College, Qing Dao Shi, China

Correspondence: H. Xiong

Intensive Care Medicine Experimental 2023, 11(Suppl 1):000353

Introduction. Mechanosensing and mechanotransduction are important processes that regulate pulmonary motility. Piezo2, as a mechanosensitive ion channel, was reported to be involved in the regulation of respiratory function in mice. However, it is unclear whether Piezo2 expression plays a role in disease progression in pulmonary dysfunction patients (such as ARDS patients).

Objectives. The aim of this study was to compare the expression of Piezo2 in the bronchoalveolar lavage fluid (BALF) of ARDS patients and the association between Piezo2 and the prognosis of ARDS patients.

Methods. This study was approved by the Biomedical Ethics Review Committee of West China Hospital of Sichuan University. Patients diagnosed with ARDS from May 2022 to December 2022 in the Department of Critical Care Medicine, West China Hospital, Sichuan University were prospectively included. Then BALF was collected from every patient. The BALF was centrifuged and the supernatant was taken for ELISA analysis. Basic information of the patients was recorded through the electronic medical record information system.

Results. We finally included 80 patients in this study. Compared with mild ARDS group, the level of piezo2 in BALF was significantly higher in moderate ARDS group (54.11 ± 8.113, 95%CI 37.75–70.48, P < 0.0001) and severe ARDS group (84.10 ± 15.44, 95%CI 53–115.2, P < 0.0001). To assess the Piezo2 value in predicting the development of ARDS patients, we graphed the ROC curve. It is revealed that Piezo2 in BALF could distinguish ARDS patients of different severity with areas under the curve (AUC) 0.9358 (95%CI 0.8667–1.00, P < 0.0001). Patients with higher level of Piezo2 had higher APACHE II score (16 ± 6.517 vs 24.4 ± 6.845, 95%CI 4.983–11.81, P < 0.0001), longer length of ICU stays

(16.71 ± 9.717 vs 28.21 ± 13.78 , 95%CI 4.84–18.15, $P=0.001$). There was no significant difference in mortality with two groups (OR 1.42, 95%CI 0.43–4.66, $P=0.57$).

Conclusions. Higher level of Piezo2 was correlated to worse progression of ARDS patients.

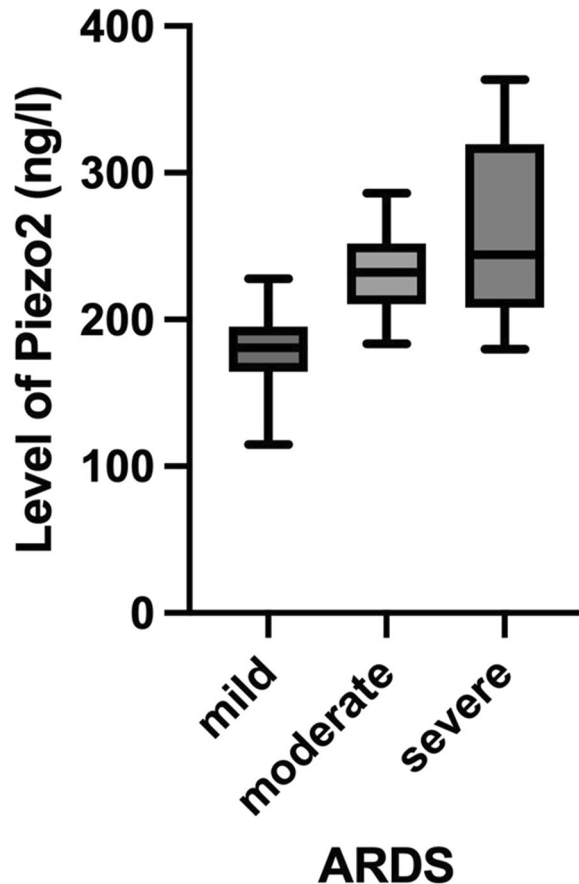

Figure 1 (abstract 000353) Differences in Piezo2 expression in alveolar lavage fluid of ARDS patients

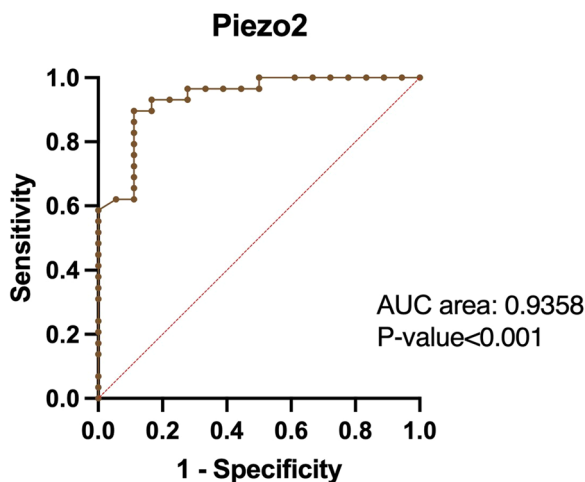

Figure 2 (abstract 000353) Area under curve (AUC) for Piezo2 and the severity of ARDS

Topic: Acute respiratory failure and mechanical ventilation.

000354

Delirium and Subsyndromal delirium in the step-down unit in Japan; Incidence, risk factors and outcomes

T. Kamo¹

¹Critical Care Medicine, Tokyo Metropolitan Bokutoh Hospital, Sumida City, Japan

Correspondence: T. Kamo

Intensive Care Medicine Experimental 2023, **11(Suppl 1)**:000354

Introduction. ICU acquired delirium is a spectrum of illnesses associated with prolonged ventilator use and increased mortality. Subsyndromal delirium (SSD) is considered a pre-delirium state and has received recent attention in terms of early prevention. There have been many studies of delirium in ICUs and SSD, but few studies in step down unit (SDU) and none in Asian populations.

Objectives. To investigate the incidence of delirium, SSD or both in the SDU, as well as their respective risk factors and clinical outcomes.

Methods. Medical records of patients admitted to an SDU in a tertiary care facility between April 1, 2021 and March 31, 2022, and whose length of stay was at least 4 days, were retrospectively reviewed from an electronic database. The Intensive Care Delirium Screening Checklist (ICDSC) was used for the diagnosis of delirium and SSD. The following data were recorded: patient characteristics, severity score (SOFA), reason for admission, duration of admission, time to discharge, Barthel index at discharge, and antipsychotic medications used.

Results. A total of 470 patients were screened and 326 were finally analyzed. Of these, 73 and 86 had SSD and delirium, respectively, and 65 had both. Age 70 or older and a SOFA score of at least 2 points were independent risk factors for each (SSD; Age > 70 OR 2.97, 95%CI: 1.49–5.91, SOFA > 2 OR 2.54, 95% CI: 1.27–5.60; Delirium; Age > 70 2.84, 95% CI 1.35–6.0, SOFA > 2 OR 2.39 95%CI 1.12–5.10).

As for in-hospital deaths, there was only one death in the SSD group (1.3%), whereas there were seven deaths in the delirium group (8.1%), a significant difference.

The length of hospital stay was longer for each group compared with patients who did not develop psychiatric symptoms, but only in the delirium group. With regard to the duration of SDU admission, the SSD and Delirium groups were significantly longer than the group that did not develop psychiatric symptoms.

Conclusions. Elderly individual and higher SOFA score were independent risk factors to develop SSD and delirium, with longer days to discharge and higher mortality in the delirium group. SSD has a lower mortality rate, but may result in longer hospital stays and requires early and appropriate action.

Topic: Sedation, analgesia and delirium.

000358

Circadian rhythms in critically ill patients during continuous versus daytime enteral nutrition: protocol for a randomized controlled trial

F. W. Hiemstra¹, E. de Jonge², J. Meijer³, D. J. Van Westerloo², L. Kervezee³

¹Department of Intensive Care & Department of Neurophysiology, Leiden University Medical Center, Leiden, Netherlands; ²Department of Intensive Care, Leiden University Medical Center, Leiden, Netherlands; ³Department of Neurophysiology, Leiden University Medical Center, Leiden, Netherlands

Correspondence: F.W. Hiemstra

Intensive Care Medicine Experimental 2023, **11(Suppl 1)**:000358

Introduction. Critically ill patients in the intensive care unit (ICU) commonly experience severe disruptions in their circadian rhythms, which have been associated with unfavorable clinical outcomes [Knauer et al. (2023), Felten et al. (2023)]. The administration of enteral nutrition, typically provided around the clock, may be a contributing factor to this disruption. Evidence suggests that rhythmic feeding-fasting cycles may provide a powerful synchronizing cue for the circadian

clock, indicating that optimizing feeding-fasting cycles in the ICU could potentially enhance circadian rhythms.

Objectives. The aim of the CIRCLES study is to investigate the effect of cyclic daytime enteral nutrition compared to continuous enteral nutrition on circadian rhythms in critical illness.

Methods. The CIRCLES study is an investigator-initiated randomized controlled trial and is conducted in a tertiary care ICU in the Netherlands. Critically ill patients aged 18 years or older with an expected ICU stay ≥ 48 h who are receiving or intended to receive enteral nutrition are eligible for inclusion. A total of 60 patients will be included in the study and randomized to either the *continuous enteral nutrition* (control) group or the *cyclic daytime enteral nutrition* (intervention). In the *continuous enteral nutrition* group, nutrition will be administered 24 h a day, according to the local standard of care protocol. In the *cyclic daytime enteral nutrition* group, administration of nutrition will be restricted to a 12-h period during daytime hours (between 8 AM and 8 PM). In both groups, similar daily nutrition goals are pursued. The study intervention will be followed until the enteral nutrition is stopped or discharge from the ICU. On the third day after the initiation of enteral nutrition, seven 4-hourly blood samples will be collected. These samples will be used to determine the plasma melatonin levels and expression levels of peripheral clock genes (blood monocytes). Additionally, a 24-h electroencephalography recording will be conducted on the same day, using a headband sleep wearable (ZMax Lite, Hypnodyne Corp., Sofia, Bulgaria), from which depth of sleep will be assessed using spectral analysis. High-resolution waveform and numerical data are captured from the patient monitor (Philips IntelliVue, Philips, Eindhoven, The Netherlands) throughout the whole study period to obtain vital sign time series (core body temperature, heart rate variability, heart rate, blood pressure). 24-h rhythms in vital signs are assessed using cosinor analysis. Additional data will be collected from the electronic patient record. Primary outcomes are amplitude of 24-h rhythms in melatonin and vital signs. Secondary outcomes include peripheral clock gene expression, sleep quality, glucose regulation, insulin administration, caloric intake, feeding intolerance and clinically relevant outcome measures.

Results. The study was approved by the Dutch national ethical review board in December 2022 and is registered at ClinicalTrials.gov in April 2023 (identifier NCT05795881). Inclusion of patients is planned to start in May 2023.

Conclusions. Increasing evidence shows that misalignment of circadian rhythms in ICU patients are linked to poor clinical outcomes. Next, it is well-known that the timing of nutrition is a crucial circadian timing cue, suggesting that cyclic daytime feeding may be more optimal than a continuous feeding schedule. However, to date, to what extent the timing of enteral nutrition influences circadian rhythms in critically ill patients is unknown. The current study aims to shed light on strategies for enhancing circadian rhythms in the ICU setting.

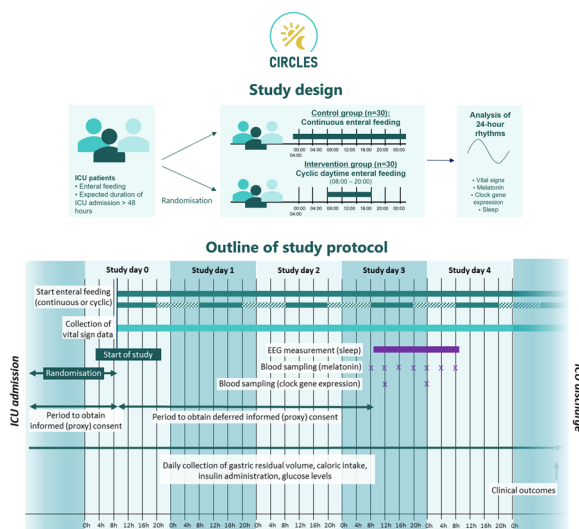

Study design and outline of study protocol of CIRCLES trial. ICU = intensive care unit, EEG = electro-encephalography.

References

- Felten, M., Dame, C., Lachmann, G., Spies, C., Rubarth, K., Balzer, F., Kramer, A., & Witzernath, M. (2023). Circadian rhythm disruption in critically ill patients. *Acta physiologica* (Oxford, England), e13962. Advance online publication. <https://doi.org/10.1111/apha.13962>
- Knauer, M. P., Ayas, N. T., Bosma, K. J., Drouot, X., Heavner, M. S., Owens, R. L., Watson, P. L., Wilcox, M. E., Anderson, B. J., Cordoza, M. L., Devlin, J. W., Elliott, R., Gehlbach, B. K., Girard, T. D., Kamdar, B. B., Korwin, A. S., Luscsek, E. R., Parthasarathy, S., Spies, C., Sunderram, J., ... Zee, P. C. (2023). Causes, Consequences, and Treatments of Sleep and Circadian Disruption in the ICU: An Official American Thoracic Society Research Statement. *American journal of respiratory and critical care medicine*, 207(7), e49–e68. <https://doi.org/10.1164/rccm.202301-0184ST>
- This work is supported by a VENI grant (09150161910128) from the Netherlands Organization for Health Research and Development (ZonMw) and an institutional project grant from the Leiden University Medical Center.
- A preliminary version of this protocol was presented at the 2023 meeting of the European Biological Rhythms Society in Zurich.

Topic: Metabolism, endocrinology, liver failure and nutrition.

000360

Contribution of dynamic versus static component of lung strain by electrical impedance tomography to lung stress and lung overdistension in ARDS patients

P.Theerawit¹, Y. Sutherland¹

¹Medicine, Ramathibodi Hospital, Bangkok, Thailand

Correspondence: P. Theerawit

Intensive Care Medicine Experimental 2023, **11**(Suppl 1):000360

Introduction. At a given lung strain, a proportion of static greater than dynamic components demonstrated its potential benefit in terms of protective effect on lung edema in healthy animal research (1). However, this hypothesis has not been tested in humans, especially ARDS. Therefore, from a different point of view, we hypothesized that excessive static components might be harmful. In addition, a suitable proportion of dynamic and static components of lung strain could be obtained in terms of lung protective ventilation.

Objectives. Our study aimed to identify the relationship between the proportion of dynamic and static component of lung strain with lung stress and percentage of overdistension area, and the suitable proportion to protect the ARDS lungs.

Methods. We conducted this study in adult ARDS patients. Those patients received mechanical ventilation and recruitment maneuver followed by decremental PEEP titration. The esophageal balloon catheter was inserted to calculate elastance-derived lung stress (DTP_{ed}). The dynamic and static components of lung strain, including overdistension (%OD) and collapse (%Col), were assessed by electrical impedance tomography (EIT). All data were recorded during each PEEP step.

Results. Data from 105 events were analyzed. The most common cause of ARDS in our study was pneumonia. The mean PaO₂/FiO₂ was 103.6 ± 32.01 mm Hg. The increased proportion of static components was significantly associated with that of DTP_{ed} (P < 0.001) and %OD (P < 0.001). The higher proportion of the static component was significantly related to the decrease in %Col (P < 0.001). We divided all events into eight groups regarding a similar value of DTP_{ed}. The ratio of dynamic to static lung strain showed a significant inverse correlation to the %OD in 5 of 8 groups with Spearman's rho of - 0.896 (P = 0.003), - 0.929 (P = 0.003), - 0.807 (P = 0.015), - 0.944 (P < 0.001), and - 0.833 (P = 0.005). The overall relationship (8 groups) also showed a significant correlation (Spearman's rho of -0.852, P < 0.001). The suitable dynamic to static lung strain ratio regarding DTP_{ed}, %OD, and %Col was 1.007, 0.861, and 0.908, respectively.

Conclusions. The proportion of static greater than the dynamic component of lung strain was not associated with lung protection in ARDS. The excessive contribution of static components was related to the risk

of overdistension, including in groups with lung stress equivalence. Regarding lung protection, the static component should approximate the dynamic component.

References

1. Protti A, Andreis DT, Monti M, Santini A, Sparacino CC, Langer T, et al. Lung stress and strain during mechanical ventilation: any difference between statics and dynamics? *Crit Care Med.* 2013;41(4):1046–55.

Topic: Acute respiratory failure and mechanical ventilation.

000361

Delay between ICU admission of patients with severe community-acquired pneumonia and prognosis at discharge

S. Altaba Tena¹, J. Camañez Fortanet¹, A. B. González Núñez², C. Viana Marco¹, J. H. Rodríguez Portillo¹

¹ICU, Hospital General Universitari de Castelló, Castelló de la Plana, Spain;

²ICU, Hospital General Universitario de Castellón, Castellón de la Plana, Spain

Correspondence: S. Altaba Tena

Intensive Care Medicine Experimental 2023, **11(Suppl 1)**:000361

Introduction. Despite advances in the diagnosis and treatment of severe infectious processes, the morbidity and mortality of severe community-acquired pneumonia remains high. In the United States, an estimated 500,000 adults are admitted each year for community-acquired pneumonia (CAP), 10–20% of whom will require admission to an Intensive Care Unit. 1–2.

Despite the existence of many tools to predict which patients would benefit from early admission to the ICU3-4, it has been shown that there is still a delay in the admission of these patients to the ICU and consequently higher mortality. 5–8.

Direct admission of these patients to the ICU is conditioned by the need for vasoactive support when admitted for septic shock and those patients requiring orotracheal intubation (OTI) and connection to non-invasive and invasive mechanical ventilation (NIV and IMV), but there is a group of patients who are not admitted directly to the ICU, who are initially admitted to hospital wards or receive more prolonged management in the ED and whose delayed admission to the ICU entails a higher rate of complications and mortality. 6,8,9

Objectives. The primary objective of the study was to determine whether delayed admission to the ICU of patients suffering from severe community-acquired pneumonia leads to higher 30-day mortality compared to patients admitted directly to the ICU.

Secondary objectives included determining whether there is a higher rate of associated complications during admission (need for RRT, mechanical ventilation, tracheostomy, use of vasopressors, infectious complications) in patients with delayed ICU admission.

Methods. Retrospective cohort study of patients admitted to the ICU of a third level reference hospital with a diagnosis of severe community-acquired pneumonia.

Patients admitted between January 2018 and December 2021 with a diagnosis of severe community-acquired pneumonia (CAP) were included. Patients admitted with a non-intubation order and with a diagnosis of SARS-CoV-2 Pneumonia were excluded.

Data were obtained on demographic variables (age, sex), history of illness prior to admission, date and time of admission to ICU and hospital, place of origin (emergency department or ward), laboratory and microbiology data, as well as the use of antibiotics and the time of initiation of their administration. For data analysis, patients were assigned to two groups, differentiating two admission times (<6 h and <24 h after arrival in the ED). The rate of complications during admission was also analyzed in both groups.

Statistical analysis was performed with Stata for Mac, version 14.2. Continuous variables with normal distribution were expressed as mean ± standard deviation, or median with interquartile range (IQR) when the distribution was not normal; and qualitative variables were expressed as numbers and percentages. Qualitative variables were analyzed using the Chi2 test (or Fisher's exact test depending on

the number of cases). Quantitative variables were evaluated using the t test (or a nonparametric test according to the normality of the distribution).

Results. A total of 45 patients with diagnosis of CAP were included in the study period. 77.8% of the patients were admitted within the first 24 h after contact with the Hospital and within this group, 85.7% were admitted within the first 6 h. In 26.7% of the cases the germ was not identified, the most frequent germ identified was *Streptococcus pneumoniae* (35.6%). The 85.3% of patients received correct empirical antibiotic therapy on admission.

There were no differences in the baseline characteristics of the two groups, except for pO₂ and CRP values on admission to the ICU (Table I).

Regarding the primary endpoint of the study, a higher 30-day mortality was observed in the group of patients with delayed admission (OR 5.17 [95% CI 1.004–26.6; p=0.05]). As for the secondary endpoints, there was a greater need for both invasive and noninvasive mechanical ventilation in the group admitted for more than 24 h, as well as a longer stay in the ICU and in hospital, with no significant differences between the two groups.

Conclusions. Delayed ICU admission in patients diagnosed with severe community-acquired pneumonia leads to higher 30-day mortality, as well as a greater need for invasive and noninvasive ventilatory support and longer ICU and hospital stay.

	ADMITTED <24 HOURS (n=35)	ADMITTED >24 HOURS (n=10)	OR [CI 95%]	p
Gender (male)	16 (45,7%)	7 (70%)	0,36 [0,08-1,63]	0,170
Age (years)	66 [50-79]	62 [55-71]	0,99 [0,94-1,04]	0,657
SAPS 3	55 [45-64]	60,5 [53-75]	1,03 [0,98-1,08]	0,229
Mortality for SAPS 3	26 [11-40]	37 [22-66]	1,02 [0,99-1,05]	0,172
HBP	18 (51,4%)	4 (40%)	0,63 [0,15-2,63]	0,522
Type 2 Diabetes Mellitus	11 (31,4%)	1 (10%)	0,24 [0,03-2,16]	0,146
COPD	8 (22,9%)	5 (50%)	3,38 [0,78-14,7]	0,11
Asthma	1 (2,9%)	0		
Smoking habit	13 (37,1%)	4 (40%)	1,13 [0,27-4,76]	0,869
Temperature (°C)**	36,7 [36-37,5]	37,3 [36,5-38,5]	1,48 [0,78-2,79]	0,222
HR (bpm)**	110 [90-125]	98 [90-112]	0,98 [0,96-1,01]	0,248
SBP(mmHg)**	100 [92-124]	120,5 [110-136]	1,03 [0,99-1,06]	0,07
DBP (mmHg)**	65 [55-75]	69 [60-76]	1,03 [0,99-1,07]	0,188
RR (bpm) **	35 [28-37]	33,5 [27-36]	0,99 [0,91-1,08]	0,915
SatO2 **	91 [85-95]	93 [90-96]	1,09 [0,97-1,25]	0,09
pO2 (mmHg) **	60 [50-60]	83 [70-113]	1,05 [1,01-1,09]	0,005
pCO2 (mmHg) **	36,5 [33-44]	36,5 [33-44]	1,01 [0,95-1,07]	0,834
pH **	7,41 [7,32-7,40]	7,46 [7,39-7,51]	25,2 [0,14-44703]	0,385
pO2/FiO2 (mmHg) **	135 [93-170]	118,5 [103-155]	0,99 [0,98-1,01]	0,339
CRP(mg/l) **	340,5 [166,5-418,5]	104 [38-177]	0,99 [0,98-0,99]	0,008
Procalcitonin (ng/ml) **	3,08 [0,7-12,8]	0,22 [0,18-3,33]	0,96 [0,88-1,05]	0,197
Leucocytes (x10 ³)	12,3 [7,2-15,7]	13,4 [8,5-16,4]	13,5 [0,93-1,12]	0,673

*Median and IQR values for quantitative variables

**Values at ICU admission

References

1. 2.Ewig S, Torres A: Severe community-acquired pneumonia. *Clin Chest Med.* 1999, 20:575–587.
2. Fine MJ, Auble TE, Yealy DM, Hanusa BH, Weissfeld LA, Singer DE, Coley CM, Marrie TJ, Kapoor WN: A prediction rule to identify low-risk patients with community-acquired pneumonia. *N Engl J Med* 1997, 336:243–250.
3. Christophe Martin, Nicolas Garin, Olivier Groscurin, Antoine Poncet, Christophe Combescurie, Sebastian Carballo, and Arnaud Perrier. Prediction of severe community-acquired pneumonia: a systematic review and meta-analysis. *Critical Care* 2012, 16: R141.
4. Chalfin DB, Trzeciak S, Likourezos A, Baumann BM, Dellinger RP: Impact of delayed transfer of critically ill patients from the emergency department to the intensive care unit. *Crit Care Med* 2007, 35:1477–1483.

- Restrepo MI, Mortensen EM, Velez JA, Frei C, Anzueto A: A comparative study of community-acquired pneumonia patients admitted to the ward and the ICU. *Chest* 2008, 133:610–617.
- Renaud B, Santin A, Coma E, Camus N, Van Pelt D, Hayon J, Gurgui M, Roupie E, Herve J, Fine MJ, Brun-Buisson C, Labarere J: Association between timing of intensive care unit admission and outcomes for emergency department patients with community-acquired pneumonia. *Crit Care Med* 2009, 37:2867–2874.
- Restrepo M.I., Mortensen E.M., Rello J., et al. Late admission to the ICU in patients with community-acquired pneumonia is associated with higher mortality. *Chest*. 2010; 137:552–557. <https://doi.org/10.1378/chest.09-1547>.
- Leroy O, Santré C, Beuscart C, et al. A five-year study of severe community-acquired pneumonia with emphasis on prognosis in patients admitted to an intensive care unit. *Intensive Care Med.* 1995; 21(1): 24– 31.
- Marston BJ, Plouffe JF, File TM Jr, Hackman BA, Salstrom SJ, Lipman HB, Kolczak MS, Breiman RF: Incidence of community-acquired pneumoniarequiring hospitalization: results of a population-based active surveillance study in Ohio: The Community-Based Pneumonia Incidence Study Group. *Arch Intern Med* 1997, 157:1709–1718.

Topic: Infections and prevention.

000363

Post-rewarming low body temperature is associated with poor prognosis in out-of-hospital cardiac arrest patients

S. Baik¹, H. Park¹, K. S. Kim¹, G. J. Suh²

¹Department of Emergency Medicine, Seoul National University Hospital, Seoul, Republic of Korea; ²Emergency Medicine, Seoul National University Hospital, Seoul, Republic of Korea

Correspondence: H. Park

Intensive Care Medicine Experimental 2023, **11(Suppl 1)**:000363

Introduction. The relationship between post-rewarming body temperature after targeted temperature management (TTM) and prognosis remains controversial yet in cardiac arrest patients. We hypothesized that low body temperature after rewarming may be associated with poor prognosis in patients with out-of-hospital cardiac arrest (OHCA) who received TTM.

Objectives. This study aimed to identify the relationship between post-rewarming body temperature and the neurological outcome and mortality through multicenter OHCA registry in South Korea.

Methods. We retrospectively reviewed the 3SNU-PCAS registry which prospectively obtained from 3 urban hospital EDs from December 2013 to May 2021. Patients with sustained ROSC after out-of-hospital cardiac arrest were enrolled. Patients who received TTM were included. Primary outcome was relationship between body temperature at 72 h after TTM initiation and clinical outcomes including 1-year favorable neurological outcome (Cerebral Performance Categories Scale, CPC 1–2) and 1-year mortality.

Results. Among 1599 patients enrolled in the registry, 596 met inclusion criteria and 311 were excluded, 285 were analyzed. Of 285, 74 had favorable 1-year neurological outcome while 211 were not. Favorable 1-year neurological outcome group was younger (52.0 vs 62.0, $P=0.001$), more witnessed (85.1% vs 65.4%, $P=0.002$), more bystander cardiopulmonary resuscitation provided (68.9% vs 50.2%, $P=0.004$), showed more initial shockable rhythm (87.1% vs 25.1%, $P<0.001$), and was more presumed as cardiac etiology (89.2% vs 28.9) whereas no difference between two groups were presented about TTM information including time interval from collapse to TTM, targeted temperature, duration of induction and maintenance phase, and use and location of feedback device. Favorable 1-year neurological outcome group showed higher body temperature than unfavorable neurological outcome group at emergency department and after initiation of TTM until 4 h, and there was no difference between the two groups from 8 to 44 h after TTM, and then again favorable

neurological outcome group had significantly higher body temperature from 48 h onwards. Low body temperature at 72 h after TTM was independently associated with 1-year mortality (adjusted OR 0.51, CI 0.37–0.87, $P=0.011$) while Body temperature at 72 h was not associated with 1-year favorable neurological outcome (adjusted OR 1.10, CI 0.77–1.56, $P=0.573$).

Conclusions. In conclusion, low body temperature after rewarming was independently associated with 1-year mortality. Post-rewarming body temperature tends to be higher in favorable neurological outcome patients although there was no significant association between body temperature after rewarming and neurological outcome.

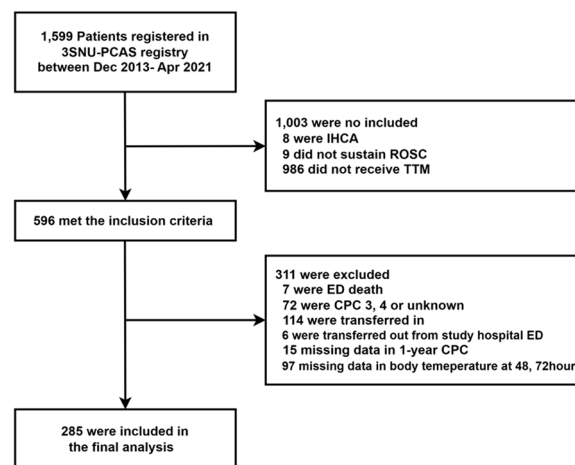

Figure 1 (abstract 000363) Patient flow diagram

Table 2 (abstract 000363) Body temperature according to the 1-year neurological outcomes

	Unfavorable (N= 211)	Favorable (N= 74)	P-value
Body temperature (°C)			
at ED	35.5 [35.0;36.1]	36.0 [35.1;36.5]	0.075
TTM 0h	35.5 [34.7;36.1]	35.8 [35.0;36.2]	0.023
TTM 4h	34.7 [33.2;36.2]	36.0 [34.7;36.7]	0
TTM 8h	33.6 [33.0;35.3]	33.7 [33.0;35.5]	0.454
TTM 12h	33.1 [32.9;34.1]	33.4 [33.0;34.5]	0.082
TTM 16h	33.2 [33.0;34.5]	33.2 [32.9;34.2]	0.216
TTM 20h	33.2 [33.0;34.6]	33.2 [32.9;34.0]	0.412
TTM 24h	33.2 [33.0;34.2]	33.4 [33.1;34.2]	0.149
TTM 28h	33.6 [33.0;34.5]	33.6 [33.2;34.1]	0.484
TTM 32h	34.2 [33.4;35.4]	34.0 [33.3;35.0]	0.296
TTM 36h	35.2 [34.2;35.9]	34.9 [33.9;35.8]	0.366
TTM 40h	35.7 [34.7;36.2]	35.6 [34.6;36.2]	0.664
TTM 44h	36.0 [35.2;36.4]	36.0 [35.3;36.7]	0.377
TTM 48h	36.0 [35.5;36.5]	36.3 [35.8;36.9]	0.002
TTM 52h	36.0 [35.8;36.5]	36.6 [36.0;37.1]	0.003
TTM 56h	36.1 [35.8;36.6]	36.6 [36.1;37.4]	0
TTM 60h	36.2 [35.9;36.6]	37.0 [36.4;37.3]	0
TTM 64h	36.2 [35.9;36.7]	36.9 [36.3;37.5]	0
TTM 68h	36.3 [36.0;36.7]	37.1 [36.7;37.5]	0
TTM 72h	36.3 [35.9;36.9]	37.1 [36.5;37.5]	0

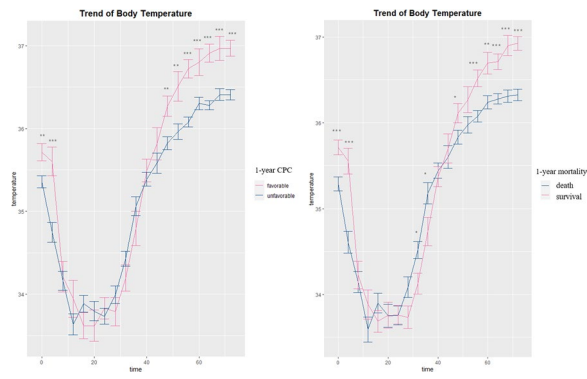

Figure 2 (abstract 000363) Trend of body temperature after TTM initiation

Table 3 (abstract 000363) Crude and adjusted odd ratio of body temperature at 72 h and 48 h after TTM initiation for predicting favorable neurological outcome and mortality

	Body temperature at 72hr				Body temperature at 48hr			
	crude OR (95% CI)	p-value	aOR (95% CI)	p-value	crude OR (95% CI)	p-value	aOR (95% CI)	p-value
CPC 1-2								
at ICU discharge	2.44 (1.74-3.53)	0.000	2.12 (1.19-3.97)	0.013	1.66 (1.25-2.25)	0.001	1.24 (0.81-1.93)	0.327
28-day	2.89 (1.76-4.71)	0.000	1.73 (0.98-3.23)	0.067	1.64 (1.26-2.10)	0.000	1.24 (0.77-2.00)	0.383
6-month	2.13 (1.36-3.99)	0.000	1.27 (0.74-2.23)	0.381	1.60 (1.23-2.14)	0.001	1.18 (0.75-1.92)	0.468
1-year	2.67 (1.49-4.87)	0.000	1.09 (0.61-1.97)	0.760	1.49 (1.15-1.98)	0.003	1.08 (0.67-1.76)	0.740
mortality								
at ICU discharge	0.18 (0.02-1.977)	0.000	0.81 (0.35-1.17)	0.369	0.87 (0.70-1.10)	0.249	1.08 (0.79-1.48)	0.619
28-day	0.35 (0.41-0.73)	0.000	0.74 (0.51-1.07)	0.114	0.86 (0.70-1.07)	0.195	1.07 (0.78-1.46)	0.665
6-month	0.41 (0.29-0.56)	0.000	0.84 (0.35-0.28)	0.004	0.76 (0.60-0.95)	0.019	1.06 (0.75-1.49)	0.713
1-year	0.44 (0.32-0.60)	0.000	0.57 (0.37-0.87)	0.011	0.78 (0.62-0.98)	0.040	1.10 (0.77-1.56)	0.573

OR, odd ratio; aOR, adjusted OR; CPC, cerebral performance category; ICU, intensive care unit

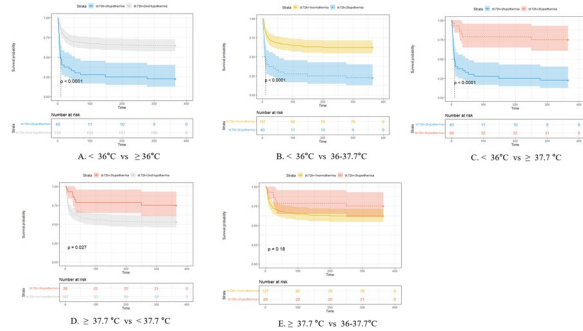

Figure 3 (abstract 000363) Survival analysis in Log-rank test according to body temperature at 72h after TTM initiation

Table 1 (abstract 000363) Demographics and clinical characteristics according to 1-year neurological outcome

	Unfavorable (N=211)	Favorable (N=74)	P-value		Unfavorable (N=211)	Favorable (N=74)	P-value
Demographic characteristics				In hospital management information			
Age (mean)	42.0 (16.7-71.0)	52.6 (13.0-83.0)	0.001	conscious sedation	63 (29.9%)	37 (50.0%)	0
Female gender	72 (34.1%)	15 (17.0%)	0.011	pericardial catheter intervention	32 (15.2%)	31 (41.9%)	0
BMI (Body mass index, kg/m²)	22.9 (20.6-25.2)	24.3 (22.5-28.1)	0.001	continuous renal replacement therapy	32 (15.2%)	2 (2.7%)	0.008
Preexisting factors				Severity index			
hypertension	81 (38.4%)	27 (36.5%)	0.309	SOFA score at ICU admission	10.0 (7.5-12.0)	8.0 (4.0-10.0)	0
diabetic mellitus	45 (21.3%)	2 (2.7%)	0.004	TTM information			
Prehospital CPC information				Time interval from collapse to TTM (h)	5.4 (3.6-8.3)	5.1 (3.3-7.3)	0.685
intubated arrival	138 (65.4%)	45 (60.8%)	0.002	targeted temperature			
ventilator CPC prearrival	106 (50.2%)	51 (68.8%)	0.004	32°C	1 (0.5%)	61 (82.4%)	0.51
initial shockable rhythm	48 (22.8%)	54 (72.9%)	0	33°C	146 (68.9%)	53 (71.6%)	
AED use by bystander	4 (2.0%)	3 (4.1%)	0.9	34°C	21 (10.0%)	12 (16.2%)	
AED use by EMS prearrival	50 (23.7%)	39 (52.7%)	0	35°C	7 (3.3%)	1 (1.4%)	
AED use by EMS prearrival	131 (62.1%)	48 (64.8%)	0.369	36°C	20 (9.5%)	8 (10.8%)	
ROSC before EMS prearrival	9 (4.3%)	2 (2.7%)	0.803	duration of infection/recessing temperature (h)	24.2 (24.0-27.4)	24.4 (24.0-28.9)	0.734
ROSC by EMS prearrival	39 (18.5%)	54 (72.9%)	0	use of TTM feedback device	199 (93.7%)	74 (100.0%)	0.19
ROSC by EMS prearrival	39 (18.5%)	54 (72.9%)	0	location of body temperature monitor			
Time interval from collapse to ED arrival	26.0 (11.0-53.0)	23.5 (11.0-50.0)	0.112	esophageal	143 (68.0%)	52 (70.3%)	
prevented cardiac cause	61 (28.9%)	66 (89.2%)	0	bladder	30 (14.2%)	10 (13.5%)	
				rectum	26 (12.3%)	5 (6.8%)	
				other	3 (1.5%)	2 (2.7%)	

References

- Bro-Jeppesen J, Hassager C, Wanscher M, Søholm H, Thomsen JH, Lippert FK, Møller JE, Køber L, Kjaergaard J. Post-hypothermia fever is associated with increased mortality after out-of-hospital cardiac arrest. *Resuscitation*. 2013 Dec;84(12):1734–40.
- Winters SA, Wolf KH, Kettinger SA, Seif EK, Jones JS, Bacon-Baguley T. Assessment of risk factors for post-rewarming "rebound hyperthermia" in cardiac arrest patients undergoing therapeutic hypothermia. *Resuscitation*. 2013 Sep;84(9):1245–9.
- Grossestreuer AV, Gaieski DF, Donnino MW, Wiebe DJ, Abella BS. Magnitude of temperature elevation is associated with neurologic and survival outcomes in resuscitated cardiac arrest patients with postrewarming pyrexia. *J Crit Care*. 2017 Apr;38:78–83.
- Lee BK, Song KH, Jung YH, Lee DH, Youn CS, Lee SM, Cho YS, Jeung KW. The influence of post-rewarming temperature management on post-rewarming fever development after cardiac arrest. *Resuscitation*. 2015 Dec;97:20–6.
- Lee HY, Lee DH, Lee BK, Jeung KW, Jung YH, Choi SP, Park JS, Lee JH, Han KS, Min YI. Early Post-Rewarming Fever Is Associated with Favorable 6-Month Neurologic Outcomes in Patients with Out-Of-Hospital Cardiac Arrest: A Multicenter Registry Study. *J Clin Med*. 2020 Sep 10;9(9):2927.
- Nolan JP, Sandroni C, Böttiger BW, et al. European Resuscitation Council and European Society of Intensive Care Medicine guidelines 2021: post-resuscitation care. *Intensive Care Med*. Apr 2021;47(4):369–421. <https://doi.org/10.1007/s00134-021-06368-4>
- Guo G, Ma Y, Xu S, Zhang H, Sun P. Clinical Effect of Post-rewarming Fever after Targeted Temperature Management in Cardiac Arrest Patients: A Systematic Review and Meta-Analysis. *Research Square*; 2022.
- Makker P, Kanei Y, Misra D. Clinical Effect of Rebound Hyperthermia After Cooling Postcardiac Arrest: A Meta-Analysis. *Ther Hypothermia Temp Manag*. 2017 Dec;7(4):206–209. <https://doi.org/10.1089/ther.2017.0009>. Epub 2017 Jul 21. PMID: 28731840.
- Leary M, Grossestreuer AV, Iannacone S, Gonzalez M, Shofer FS, Povey C, Wendell G, Archer SE, Gaieski DF, Abella BS. Pyrexia and neurologic outcomes after therapeutic hypothermia for cardiac arrest. *Resuscitation*. 2013 Aug;84(8):1056–61.

000364

Videolaryngoscope and PPE as the “New Normal” for intubation in Trauma bay

S. Sethi¹, S. Tanvir², A. Aditya³, A. Porur³, K. Jain⁴
¹Anaesthesiology, Post Graduate Institute of Medical Education & Research, Chandigarh, Chandigarh, India; ²Trauma Anaesthesia and Intensive Care, Post Graduate Institute of Medical Education & Research, Chandigarh, Chandigarh, India; ³Anaesthesiology, Post Graduate Institute of Medical Education & Research, Chandigarh, Chandigarh, India; ⁴Anaesthesiology and Intensive Care, Post Graduate Institute of Medical Education & Research, Chandigarh, Chandigarh, India

Correspondence: S. Sethi

Intensive Care Medicine Experimental 2023, **11(Suppl 1)**:000364

Introduction: A major change in the airway management practices during the COVID-19 pandemic has been the recommendation for the use of videolaryngoscope (VL) and PPE for protected intubation. Laryngoscopy after donning PPE labelled as “protected intubation” is a major change from the conventional techniques and so various manikin-based studies have been conducted to assess time to intubation, number of laryngoscopy attempts and first-pass success rate.

Objectives: In this retrospective study, we assessed the applicability and efficiency of this new airway management algorithm in untested trauma victims on arrival to hospital requiring immediate airway intervention.

Methods: The present study was conducted from April 2020 to September 2020. All proformas are filled by the anaesthesiology residents who are members of the trauma airway management response team (TART). The approach to airway management in COVID times was based on three principles; (1) all TART members to be in PPE; (2) drug assisted intubation; (3) VL to be preferred over DL even for first laryngoscopy attempt. Patients who arrived intubated were excluded. Study end points were the feasibility of use of VL for “protected intubation”

and comparison of the time to intubation, number of laryngoscopy attempts and first-pass success rate with VL and DL in trauma centre in COVID times. It is to be noted that all patients included were untested for severe acute respiratory syndrome coronavirus 2 (SARS-CoV-2) at time of airway management in trauma centre and were considered as COVID "suspects."

Results: Data from 296 intubations performed by TART members in level C PPE in different resuscitation areas of trauma centre during different duty hours was compiled.

A GCS score of less than 8 was the reason for intubation in 72% of cases followed by type 1 respiratory distress in the remaining. Majority were males (230) and 84.8% were aged between (18–60 years). Road side accident (n = 243), fall from height (n = 19), assault (n = 13), trauma with thermal burns (n = 10) and others (animal injury, trivial fall, etc. n = 11) were the mechanisms of trauma.

Videolaryngoscope was used in 87.2% of patients (258); direct laryngoscopy (DL) was used in the remaining. Time taken for intubation in first attempt was 28.95 ± 14.51 s in 24 patients with DL and 27.14 ± 14.61 s with 35 randomly chosen intubations in VL group and the difference was statistically non significant (p value = 0.6402; t-test). The laryngeal view during airway management with the two devices was compared using Cormack-Lehane (CL) classification. 7 Maximum glottis visualization is in CL grade I and was 57.14% in VL vs 50% in DL; 42.86% patients intubated with VL had CL grade II whereas 50% patients had CL grade 2 in DL group. The difference was nonsignificant with p value of 0.589. The difference in first attempt success rate; 92% in VL and 79% in DL was also not statistically significant.

Conclusions: We conclude that use of VL with PPE by TART members for drug assisted intubations in untested trauma patients in COVID times is feasible and safe as the time taken for intubation is 27.14 ± 14.61 s.

References

1. Brewster DJ. Consensus statement: safe Airway Society principles of airway management and tracheal intubation specific to the COVID-19 adult patient group. *Med. J. Aust.* 2020;162. Cook T. Consensus guidelines for managing the airway in patients with COVID-19: guidelines from the difficult airway society, the association of anaesthetists the intensive care society, the faculty of intensive care medicine and the royal college of anaesthetists. *Anaesthesia.* 2020;75:785–799. 3. Bhatia N, Jain K, Samra T, Aditya AS, Kumar M, Kumar P, Kaur Jeetinder. Transforming airway management practices in a Level I trauma centre during COVID Crisis. *Journal of Trauma and Acute Care Surgery* 2021. Publish Ahead of Print <https://doi.org/10.1097/TA.0000000000003096> 4. Louro J, Dudaryk R, Rodriguez Y, Dutton RP, Epstein RH. Airway management at Level 1 trauma center in the era of video laryngoscopy. *Int J Crit Illn Inj Sci.* 2020;10:20–24. 5. Pantazopoulos I, Kolonia K, Laou E, Mermiri M, Tsolaki V, Koutsovasilis A, Zakynthinos G, Gourgoulis K, Arnaoutoglou E, Chalkias A. Video Laryngoscopy Improves Intubation Times With Level C Personal Protective Equipment in Novice Physicians: A Randomized Cross-Over Manikin Study. *J Emerg Med.* 2021;S0736-4679(21)00001-9. 6. Kannaujia A, Haldar R, Shamim R, Mishra P, Agarwal A. Comparative evaluation of intubation performances using two different barrier devices used in the COVID-19 era: A manikin based pilot study. *Saudi J Anaesth* 2021;15:86–92
2. NONE

Topic: Trauma

000366

Ultra-low tidal volume without extracorporeal circulation for COVID-19 ARDS. A randomized controlled trial

J. C. Richard¹, N. Terzi², H. Yonis¹, F. Chorfa³, F. Wallet⁴, C. Dupuis⁵, L. Argaud⁶, B. Delannoy⁷, G. Thiery⁸, C. Pommier⁹, P. Abraham¹⁰, M. Muller¹¹, F. Sigaud², G. Rigault², E. Joffredo⁴, M. Mezidi¹, B. Souweine⁵, L. Baboi¹², H. Serrier¹³, M. Rabilloud³, L. Bitker¹

¹Medical Intensive Care Unit, Hôpital de la Croix-Rousse - HCL, Lyon, France; ²Médecine Intensive réanimation, C.H.U de Grenoble, La Tronche, France; ³Pôle Santé Publique, Service de Biostatistique et Bioinformatique, Hospices Civils de Lyon - HCL, Lyon, France; ⁴Service de Réanimation CHLS, Hospices Civils de Lyon - HCL, Lyon, France; ⁵Médecine Intensive -

réanimation, CHU Gabriel-Montpied, Clermont-Ferrand, France; ⁶Service de médecine intensive-réanimation, Hôpital Édouard Herriot, Lyon, France; ⁷Service de réanimation, Clinical De La Sauvegarde - Ramsay Santé, Lyon, France; ⁸Intensive Care Unit, Chu Nord Saint-Étienne, Saint-Priest-en-Jarez, France; ⁹Service de réanimation, Saint-Joseph and Saint-Luke Hospital Centre, Lyon, France; ¹⁰Service de réanimation chirurgicale, Edouard Herriot Hospital, Lyon, France; ¹¹Icu, C.H. Annecy Genevois, Metz-Tessy, France; ¹²Medical Intensive Care Unit, Hospital La Croix-Rousse - HCL, Lyon, France; ¹³Cellule Innovation, Délégation à la Recherche Clinique et à l'Innovation, Hospices Civils de Lyon - HCL, Lyon, France

Correspondence: J. C. Richard

Intensive Care Medicine Experimental 2023, **11(Suppl 1)**:000366

Introduction: Acute respiratory distress syndrome (ARDS) related to COVID-19 is associated with a high mortality rate and prolonged mechanical ventilation duration. We hypothesized that ultra-low tidal volume ventilation (ULTV) without extracorporeal circulation would minimize ventilator-induced lung injury.

Objectives: To determine whether ULTV, compared with protective ventilation, could improve COVID-19 ARDS 90-day all-cause mortality the number of ventilator-free days (VFD).

Methods: The study is a multicenter open-label randomized controlled superiority trial performed in 10 intensive care units. The study was performed in France from April 15th, 2020 to April 13th, 2021, and final follow-up occurred on July 17, 2021. Patients with COVID-19 ARDS and a $\text{PaO}_2/\text{FiO}_2 \leq 150$ mmHg were included, and randomly assigned to receive ULTV aiming for $\text{VT } 4 \text{ mL kg}^{-1}$ predicted body weight (PBW, n = 106) or protective ventilation (i.e., $\text{VT } 6 \text{ mL kg}^{-1}$ PBW, n = 109).

The primary outcome was a composite score based on 90-day all-cause mortality as prioritized criterion and the number of VFD as a secondary criterion.

Results: Two hundred and fifteen patients were included (median age [interquartile range (IQR)], 68 [60–74]; 58 women [27%]). The primary endpoint was not significantly different between arms (win ratio of the ULTV arm amounting to 0.85 [95% confidence interval (CI95%), 0.60 to 1.19]; p = 0.38). Forty-six patients [43%] in the ULTV arm and 43 [39%] in the protective ventilation arm died by day-90 (absolute risk difference: 4 [CI95%, -9 to 18] %; p = 0.52). VFD were not significantly different between the ULTV and the protective ventilation arms (median [IQR]: 7 [0–45] vs. 31 [0–48] days; median of the differences between arms, 0 [CI95%, -2 to 0] days, p = 0.3). The rate of severe respiratory acidosis was significantly higher in the ULTV arm (35 patients [33%] vs. 14 patients [13%], absolute risk difference: 20 [CI95%, 9 to 31%], p < 0.001). Subgroup prespecified exploratory analysis suggested harm of the ULTV strategy in patients with renal SOFA subscore³2.

Conclusions: In patients with moderate-to-severe COVID-19 ARDS, ULTV compared with protective ventilation resulted in no significant difference of a composite score based on 90-day mortality and VFD. These findings do not support the systematic use of ULTV in COVID-19 ARDS.

References

1. Funding/Support The study was funded by the French Ministry of Solidarity and Health (PHRC interregional 2020) and the Hospices Civils de Lyon.

Topic: Acute respiratory failure and mechanical ventilation

000367

Improved nutritional management and outcomes in critically ill patients: a randomized, controlled study comparing novel automated technology to standard of care

I. Kagan¹, M. Hellerman Itzhaki¹, G. Fishman¹, L. Statlender¹, I. Bendavid¹, P. Singer¹

¹Intensive Care Unit, Rabin Medical Center, Beilinson Campus, Petah Tikva, Israel

Correspondence: I. Kagan

Intensive Care Medicine Experimental 2023, **11(Suppl 1)**:000367

Introduction: Nasogastric tube malposition, underfeeding, frequent feeding interruption and reflux are frequent complications related to enteral nutrition (1, 2). SmART+ robot feeding system (ART MEDICAL, Natania, Israel) is a new platform trying to overcome all these limitations and improve feeding efficacy.

Methods: Mechanically ventilated patients were prospectively randomized to receive enteral nutrition using standard protocol through an usual nasogastric tube vs study group supported by SmART+ platform composed of a nasogastric tube with sensors detecting reflux and preventing aspiration through an inflated balloon. Energy administration was based on indirect calorimetry (REE). Primary endpoint was feeding efficacy. Length of ICU stay and Length of ventilation were also analyzed. Parametric independent samples t-test and non-parametric Wilcoxon rank sum test were applied. All tests were two-tailed, with a p-value significance level of <0.05.

Results: 50 patients in control group and 50 patients in study group were included. There were no differences between groups except height and REE. No side effects were observed. Primary endpoint (feeding efficiency between days 2 to 14 for control and study group was $37.9 \pm 19.9\%$ and $89.9 \pm 12.2\%$, respectively, $p < 0.0001$). Cumulative energy balance was $-8,839 \pm 7,897$ kcal; range $-1,332$ – $31,849$ kcal in control group and $-6,554 \pm 3,315$ kcal; range $-2,006$ – $13,642$ kcal in study group ($p < 0.07$). LOS was low significantly lower in the study group (HR 1.53, 95% CI 1.027–2.29, $p < 0.04$) and LOV was near to significant (HR 1.45, 95% CI 0.977–2.164, $p = 0.06$). ICU mortality was similar in both groups.

Conclusions: No adverse events were report during the study. SmART+ robot system improved feeding efficiency and reduced LOS of mechanically ventilated patients in general ICU. This new technology may significantly improve the enteral feeding routine in critically ill patients.

References

1. White H, King L. Enteral feeding pumps: efficacy, safety, and patient acceptability. *Med Devices (Auckl)* 2014;7:291–8. <https://doi.org/10.2147/MDER.S50050>.
2. Murthy TA, Chapple LAS, Jlange K, Marathe CS. Gastrointestinal dysfunction during enteral nutrition delivery in intensive care unit (ICU) patients: Risk factors, natural history, and clinical implications. A post-hoc analysis of The Augmented versus Routine approach to Giving Energy Trial (TARGET). *Am J Clin Nutr* 2022;166(2):589–598. <https://doi.org/10.1093/ajcn/nqac113>

Topic: Metabolism, endocrinology, liver failure and nutrition

000369

Arterial carbon dioxide tension and outcomes in out-of-hospital cardiac arrest patients on extracorporeal membrane oxygenation: a registry-based cohort study

J. Izawa¹, S. Kimata², A. Sakai¹, T. Kitamura³, Y. Yamaguchi²
¹Division of Intensive Care Medicine, Department of Medicine, Okinawa Chubu Hospital, Uruma, Japan; ²Department of Emergency Medicine, Okinawa Chubu Hospital, Uruma, Japan; ³Department of Social and Environmental Medicine, Graduate School of Medicine and Faculty of Medicine, Osaka University, Suita, Japan

Correspondence: J. Izawa

Intensive Care Medicine Experimental 2023, **11(Suppl 1)**:000369

Introduction: The partial pressure of arterial carbon dioxide (PaCO₂) is a crucial factor in determining cerebral blood flow after brain injury. While deviations in PaCO₂ have been linked to worse outcomes in out-of-hospital cardiac arrest (OHCA) patients [1], little is known about the association between PaCO₂ and outcomes in patients undergoing extracorporeal membrane oxygenation (ECMO) after OHCA. Therefore, this observational study aimed to investigate the relationship between PaCO₂ levels and outcomes in patients on ECMO after OHCA using meticulously classified PaCO₂ levels.

Methods: We used a registry database of OHCA cases between 2014 and 2020 in Japan. We included adult, non-traumatic OHCA patients who underwent ECMO before or after the return of spontaneous circulation and whose PaCO₂ levels were measured after ECMO initiation. The main exposure was PaCO₂ levels, which were divided into eight categories: PaCO₂ < 30; 30–<35; 35–<40; 40–<45; 45–<50; 50–<55; 55–<60; ≥ 60 mmHg. The non-linear relationship between PaCO₂ levels as a continuous variable and the predicted probability of favorable functional survival was visually described using restricted cubic splines in univariable logistic regression. The primary outcome was favorable functional survival at one month or hospital discharge, whichever came first. Multivariable logistic regression was performed to adjust for clinically relevant variables.

Results: Among 1503 patients who met the eligibility criteria, the proportion of favorable functional survival was highest in the PaCO₂ category of 40–<45 mmHg: 12.0% (36/300) in < 30; 13.7% (36/262) in 30–<35; 11.2% (23/205) in 35–<40; 20.4% (38/186) in 40–<45; 18.6% (21/113) in 45–<50; 14.7% (14/95) in 50–<55; 7.3% (6/82) in 55–<60; and 11.9% (31/260) in ≥ 60. When using restricted cubic splines in univariable logistic regression, the relationship between PaCO₂ levels and the primary outcome followed an inverted-U-shaped form (Figure). Only the PaCO₂ category of 40–<45 mmHg was associated with favorable functional survival, and the adjusted odds ratio was 1.07 (95% CI 1.01–1.14) when compared to the category of < 30 as a reference. For patients whose outcomes at 90 days after resuscitation were available, the association between the category of 40–<45 mmHg and favorable functional survival remained.

Conclusions: This study demonstrated that high normocapnia (40–<45 mmHg), but not low normocapnia (35–<40 mmHg), was associated with better functional survival in adult OHCA patients undergoing ECMO. This finding highlights the importance of meticulous PaCO₂ level management in the post-cardiac arrest phase.

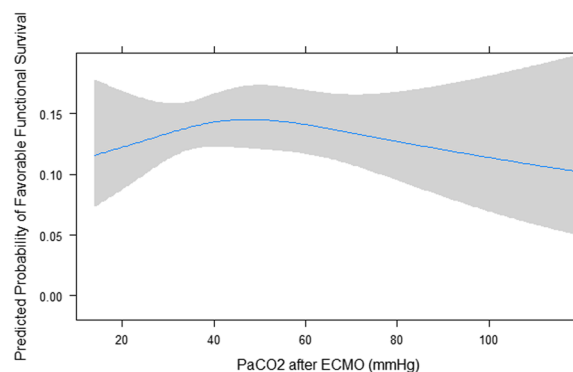

Figure (abstract 000369) PaCO₂ levels and predicted probability of favorable functional survival

References

1. [1] B. W. Roberts, J. H. Kilgannon, M. E. Chansky, N. Mittal, J. Wooden and S. Trzeciak. Association between postresuscitation partial pressure of arterial carbon dioxide and neurological outcome in patients with post-cardiac arrest syndrome. *Circulation*. 2013;127:2107–13.

Topic: Cardiac arrest

000370

Prolonged intensive care therapy in critically ill patients ≥ 90 years—clinical characteristics and outcomes

K. Roedel¹, M. Haar¹, R. Daniels¹, P. Theile¹, S. Kluge¹, J. Müller²
¹Department of Intensive Care Medicine, University Medical Center Hamburg-Eppendorf, Hamburg, Germany; ²Department of Anaesthesiology, Tabea Hospital Hamburg, Hamburg, Germany

Correspondence: K. Roedel

Intensive Care Medicine Experimental 2023, 11(Suppl 1):000370

Introduction: Intensive care unit (ICU) admission of very elderly patients (≥ 90 years) have increased in recent years. To date, it remains unclear if prolonged ICU treatment (≥ 7 days) is justified regarding outcome. Yet, factors associated with prolonged ICU stay remain unknown in the very elderly critically ill population.

Objectives: Identify factors associated with prolonged ICU stay and clinical outcome in very elderly patients.

Methods: Retrospective analysis of all consecutive critically ill patients ≥ 90 years admitted to the Department of Intensive Care Medicine of the Medical University Centre Hamburg-Eppendorf (Hamburg, Germany) during an 11-year period. Clinical and laboratory course were analyzed from all patients. Prolonged ICU therapy was defined as ICU stay ≥ 7 days. Occurrence, clinical characteristics and outcome were assessed and compared between patients with and without prolonged stay.

Results: During the study period 1091 critically ill very elderly patients could be identified. Of those, 10% ($n=110$) had a prolonged ICU stay ≥ 7 days. Demographic characteristics including age, gender and BMI were comparable in patients with and without prolonged stay. The median CCI was 1 (0–3) points compared to 1 (1–2) points in patients with and without prolonged ICU stay ($p=0.933$). Disease severity represented by SAPS II (47 vs. 35 points, $p<0.001$) score on admission was higher in patients with prolonged ICU stay. Invasive mechanical ventilation was required in 78% ($n=86$) and 30% ($n=296$) ($p<0.001$). Renal replacement therapy (RRT) during the ICU stay was applied in 12% ($n=13$) and 2% ($n=17$) ($p<0.001$). Multivariate regression analysis identified mechanical ventilation [OR 3.873, 95% CI (2.026–7.406); $p<0.001$], vasopressors during ICU stay [OR 2.921, 95% CI (1.466–5.821); $p=0.002$], RRT [OR 4.299, 95% CI (1.513–12.212); $p=0.006$] and SAPS II [OR 1.023, 95% CI (1.004–1.043); $p=0.020$] as independent factors associated with prolonged ICU stay. In patients with prolonged ICU stay we observed an ICU-mortality of 32% ($n=35$) as compared to 17% ($n=164$) in patients without prolonged ICU stay ($p<0.001$).

Conclusions: About 10% of critically ill ≥ 90 -years suffer from a prolonged ICU stay, which was significantly associated with increased mortality. However, ICU therapy in this cohort seems justified.

Topic: Critical care organisation, quality management, information systems, outcomes

000371

HYPE-2—efficacy of the hypotension prediction index with diagnostic guidance on hypotension during elective cardiac surgery and postoperative intensive care unit admission—a randomised clinical trial

J. Schuurmans¹, S. R. Rellum¹, J. Schenk², B. J. P. Van Der Ster², W. H. Van Der Ven², B. F. Geerts³, M. W. Hollmann², T. G. V. Cherpanath¹, W. K. Lagrand¹, P. Wynandts², F. Paulus¹, A. H. G. Driessen⁴, L. E. Terwindt², S. Eberl², H. Hermanns², D. P. Veelo², A. P. J. Vlaar¹

¹Adult Intensive Care, Amsterdam UMC location University of Amsterdam, Amsterdam, Netherlands; ²Anesthesiology, Amsterdam UMC Location

University of Amsterdam, Amsterdam, Netherlands; ³AI, Healthplus.ai, Amsterdam, Netherlands; ⁴Cardiothoracic Surgery, Amsterdam UMC Location University of Amsterdam, Amsterdam, Netherlands

Correspondence: J. Schuurmans

Intensive Care Medicine Experimental 2023, 11(Suppl 1):000371

Introduction: Maintaining adequate perfusion is a pivotal aspect of intraoperative and critical care. Mean arterial blood pressure (MAP) is often used as a surrogate for perfusion pressure [1, 2]. The Hypotension Prediction Index (HPI) is a machine learning-derived algorithm that enables clinicians to initiate hemodynamic interventions prior to the onset of hypotension [3]. The use of HPI in combination with a diagnostic guidance protocol led to a significant reduction in the severity of hypotension in five out of six non-cardiac surgery trials [4–9], but its efficacy during cardiac surgery and intensive care unit (ICU) stay is to be determined.

Objectives: Our primary objective was to test in a randomised trial the efficacy of HPI with a diagnostic guidance protocol on top of standard of care on reducing the severity of hypotension during elective on-pump coronary artery bypass grafting (CABG) procedures and postoperative ICU stay. The secondary objectives were to assess differences in the severity of hypertension and the total dosage of administered fluids and medication.

Methods: Single-centre, single-blinded randomised clinical trial conducted at the Amsterdam University Medical Centres, the Netherlands. Adult patients scheduled for an elective on-pump CABG procedure with or without additional single heart valve surgery were eligible if a MAP of ≥ 65 mmHg was the set target during the off-pump phases of the procedure and the subsequent ICU admission. After providing informed consent, the participants were randomised in a 1:1 allocation ratio to the HPI-guided or standard care arm. An Acumen IQ sensor connected to a HemoSphere monitor was attached to the arterial catheter in all patients (Edwards Lifesciences, Irvine, CA, USA). However, clinicians were only provided with HPI and the additional diagnostic guidance protocol in the HPI-guided arm. In the standard care group, HPI was measured, but the HemoSphere was covered, and alerts were silenced. Once HPI was ≥ 75 for at least one minute, treatment within two minutes was suggested to the clinician (Figure 1). In the operating room, treatment type and dosage were left to the anaesthesiologist's discretion. A nurse-driven hypotension treatment protocol was created for use in the ICU to minimise treatment delay.

Results: Between May 2021 and March 2023, 142 out of 450 eligible patients were enrolled, with 130 included in the final analysis (Figure 2). The patients' baseline characteristics were well-balanced in the two groups. The overall time-weighted average of hypotension was significantly lower in the HPI-guided arm, with a median of differences of 0.40 mmHg (95% CI 0.26–0.65 mmHg; $P \leq 0.0001$) (Figure 3). An overview of the secondary endpoint results is available in Table 1.

Conclusions: The use of HPI in combination with a diagnostic guidance protocol and nurse-driven treatment protocol on top of standard of care significantly decreased the severity of hypotension in elective CABG patients without increasing the severity of hypertension compared to standard care alone.

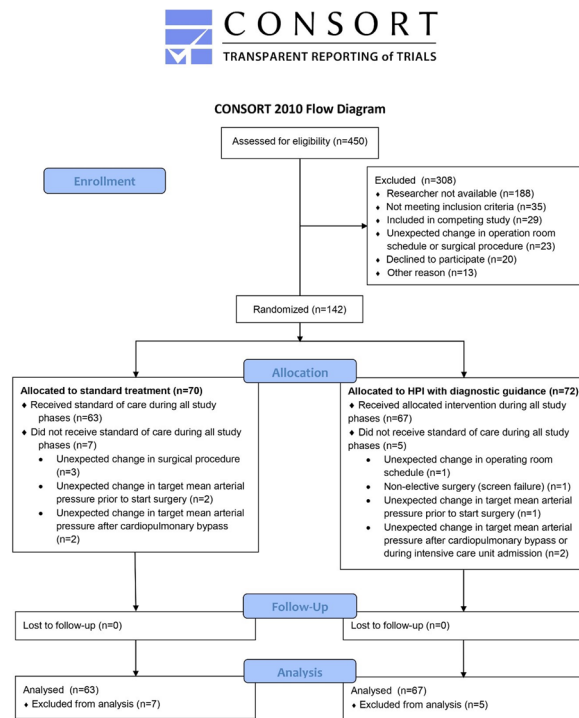

Figure 1 (abstract 000371) Participant flow in the hypotension prediction 2 (HYPE 2) trial

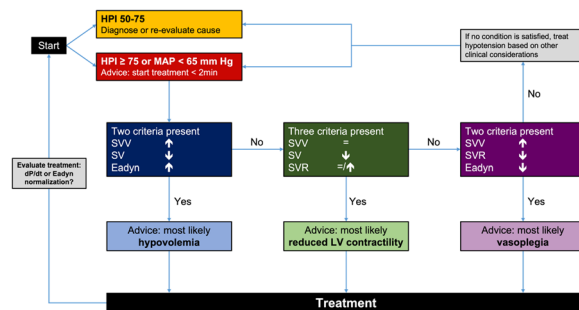

Figure 2 (abstract 000371) Diagnostic guidance protocol. Adapted with permission from Wijnberge et al., JAMA 2020. dP/dt: derivative of arterial pressure; Eadyd: dynamic arterial elastance; HPI: Hypotension Prediction Index; LV: left ventricle; MAP: mean arterial pressure; SV: stroke volume; SVR: systemic vascular resistance; SVV: stroke volume variation. Advice is provided every five minutes if HPI remains above and/or MAP remains below the threshold. For Eadyd, the reference value is set at 0.8

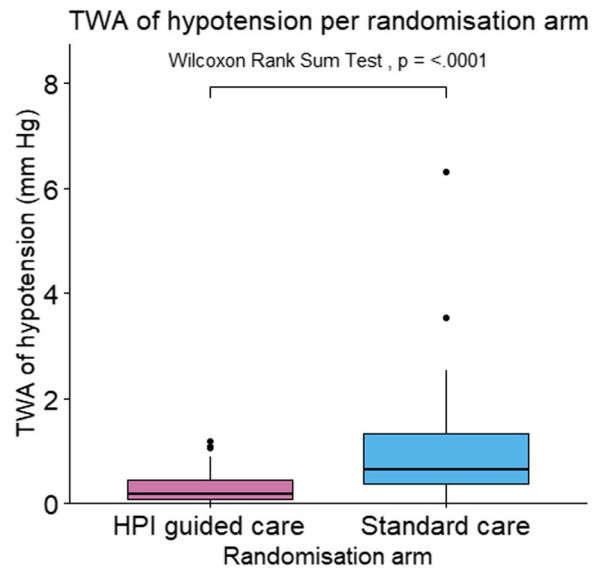

Figure 3 (abstract 000371) Overall time-weighted average of hypotension in mmHg per study arm. TWA, time-weighted average

Table 1 (abstract 000371) Secondary endpoints

Secondary endpoints	HPI guided care (N = 67)	Standard care (N = 63)	Median of differences or difference in proportion (95% CI)
Hemodynamic			
Hypotension			
AUT, mm Hg*min	69 [23, 161]	230 [102, 465]	-129 (-213 to -75)
Number of events per patient	4.0 [2.0, 7.0]	8.0 [4.0, 12.5]	-3.0 (-5.0 to -2.0)
Total time in, min	14 [6, 35]	46 [22, 90]	-28 (-44 to -17)
Percentage of time in, %	4.0 [2.0, 9.0]	14 [8.0, 29]	-9.4 (-13.7 to -6.1)
Hypertension			
Time-weighted average, mm Hg	0.03 [0.00, 0.16]	0.06 [0.00, 0.38]	0.00 (-0.05 to 0.00)
AAT, mm Hg*min	6 [0, 50]	23 [0, 100]	0 (-22 to 0)
Number of events per patient	1.0 [0.0, 2.0]	1.0 [0.0, 2.0]	0.0 (0.0 to 0.0)
Total time in, min	2.0 [0.0, 8.8]	3.3 [0.0, 13]	0 (-2 to 0)
Percentage of time in, %	1.0 [0.0, 3.0]	1.0 [0.0, 4.0]	0.0 (-0.5 to 0.2)
Treatment			
Dobutamine, N (%)	7 (10.4)	6 (9.5)	0.01 (-0.10 to 0.12)
End-tidal sevoflurane, %	0.35 [0.03, 1.21]	0.11 [0.00, 1.12]	0.02 (-0.03 to 0.15)
Epinephrine, N (%)	0 (0.0)	2 (3.2)	-0.03 (-0.11 to 0.02)
Ephedrine, mg	5.0 [0.0, 11.0]	6.0 [0.0, 12.0]	0.0 (-2.5 to 0.0)
Milrinone, N (%)	8 (11.9)	7 (11.1)	0.01 (-0.11 to 0.12)
Morphine, mg	4.0 [0.0, 10.0]	2.0 [0.0, 10.0]	0.0 (0.0 to 2.0)
Nitroglycerin, N (%)	7 (10.4)	5 (7.9)	0.03 (-0.08 to 0.13)
Nitroprusside, N (%)	1 (1.5)	1 (1.6)	0.0 (-0.07 to 0.07)
Norepinephrine, µg	2,525 [1,399, 4,674]	2,087 [1,187, 3,083]	661 (117 to 1327)
Norepinephrine, µg/kg/min	0.06 [0.03, 0.09]	0.04 [0.03, 0.07]	0.01 (0.00 to 0.03)
Phenylephrine, µg	800 [400, 1,000]	700 [325, 1,125]	0.0 (-150 to 200)
Propofol, mg	2,047 [764, 3,232]	2,206 [986, 2,867]	-17 (-511 to 447)
Remifentanyl, µg	0.0 [0.0, 0.0]	0.0 [0.0, 0.0]	0.0 (0.0 to 0.0)
Sufentanil µg	215 [179, 284]	223 [185, 261]	2 (-24 to 29)
Vasopressin analogue, N (%)	2 (3.0)	3 (4.8)	-0.02 (-0.11 to 0.06)
Fluid balance after study phases, ml	3,124 [2,151, 4,046]	2,631 [1,735, 3,502]	366 (-150 to 891)
Study characteristics			
Cardiopulmonary bypass duration, min	112 [91, 132]	97 [82, 121]	-
Total duration of included study phases, min	335 [256, 441]	344 [241, 413]	-

AAT, area above threshold; AUT, area under threshold; vasopressin analogue is terlipressin or vasopressin

References

- [1] van der Ven WH, Schuurmans J, Schenk J, et al. Monitoring, management, and outcome of hypotension in Intensive Care Unit patients, an international survey of the European Society of Intensive Care Medicine. *Journal of Critical Care* 2022;67:118–125. (In English). DOI: <https://dx.doi.org/10.1016/j.jccr.2021.10.008>.
- [2] Saugel B, Vincent J-L, Wagner JY. Personalized hemodynamic management. *Current Opinion in Critical Care* 2017;23(4):334–341. <https://doi.org/10.1097/mcc.0000000000000422>.
- [3] Hatib F, Jian Z, Buddi S, et al. Machine-learning Algorithm to Predict Hypotension Based on High-fidelity Arterial Pressure Waveform Analysis. *Anesthesiology* 2018;129(4):663–674. (In eng). <https://doi.org/10.1097/aln.0000000000002300>.
- [4] Wijnberge M, Geerts BF, Hol L, et al. Effect of a Machine Learning-Derived Early Warning System for Intraoperative Hypotension vs Standard Care on Depth and Duration of Intraoperative Hypotension During Elective Noncardiac Surgery: The HYPE Randomized Clinical Trial. *Jama* 2020;323(11):1052–1060. (In eng). <https://doi.org/10.1001/jama.2020.0592>.
- [5] Schneck E, Schulte D, Habig L, et al. Hypotension Prediction Index based protocolized haemodynamic management reduces the incidence and duration of intraoperative hypotension in primary total hip arthroplasty: a single centre feasibility randomised blinded prospective interventional trial. *Journal of Clinical Monitoring and Computing* 2019. <https://doi.org/10.1007/s10877-019-00433-6>.
- [6] Tsoumpa M, Kytteri A, Matiatou S, et al. The Use of the Hypotension Prediction Index Integrated in an Algorithm of Goal Directed Hemodynamic Treatment during Moderate and High-Risk Surgery. *Journal of Clinical Medicine* 2021;10(24):5884. (<https://www.mdpi.com/2077-0383/10/24/5884>).
- [7] Murabito P, Astuto M, Sanfilippo F, et al. Proactive Management of Intraoperative Hypotension Reduces Biomarkers of Organ Injury and Oxidative Stress during Elective Non-Cardiac Surgery: A Pilot Randomized Controlled Trial. *J Clin Med* 2022;11(2) (In eng). <https://doi.org/10.3390/jcm11020392>.
- [8] Maheshwari K, Shimada T, Yang D, et al. Hypotension Prediction Index for Prevention of Hypotension during Moderate- to High-risk Noncardiac Surgery. *Anesthesiology* 2020;133(6):1214–1222. (In eng). <https://doi.org/10.1097/aln.0000000000003557>.
- [9] Šribar A, Jurinjak IS, Almahariq H, et al. Hypotension prediction index guided versus conventional goal directed therapy to reduce intraoperative hypotension during thoracic surgery: a randomized trial. *BMC Anesthesiol* 2023;23(1):101. (In eng). <https://doi.org/10.1186/s12871-023-02069-1>.
- Alexander PJ, Vlaar and Denise P. Veelo received an unrestricted grant from Edwards Lifesciences. Edwards Lifesciences was not involved in the design of this trial protocol or the draft of this abstract.

Topic: Perioperative care

000372

Impact of recruitment imbalance and site stratification on PANAMO, a phase 3 RCT of vilobelimab in critically ill, COVID-19 patients

A. P. J. Vlaar¹, M. Witzenzrath², V. P. Pieter³, L. Heunks⁴, B. Mourvillier⁵, S. de Bruin¹, E. Lim¹, M. Brouwer⁶, P. R. Tuinman⁷, J. Saraiva⁸, G. Marx⁹, S. Lobo¹⁰, R. Boldo¹¹, J. Simon-Campos¹², A. D. Cornet¹³, J. Grebenyuk¹⁴, J. Engelbrecht¹⁵, M. Mukansi¹⁶, P. Jorens¹⁷, R. Zerib¹⁸, S. Ruckinger¹⁹, K. Pilz¹⁸, R. Guo¹⁸, D. Van De Beek⁶, N. Riedemann²⁰

¹Department of Intensive Care Medicine, Academic Medical Centre, Amsterdam, Netherlands; ²Department of Infectious Diseases and Respiratory Medicine, Charite University Medicine-Campus Mitte, Berlin, Germany; ³Immunology, UMC+, Maastricht, Netherlands; ⁴Intensive Care, Erasmus University Medical Center, Rotterdam, Netherlands; ⁵Médecine Intensive et réanimation polyvalente, CHU Reims - Champagne Clinic, Reims, France; ⁶Neurology, Amsterdam UMC Location University of Amsterdam, Amsterdam, Netherlands; ⁷Intensive

Care, Vrije Universiteit Amsterdam, Amsterdam, Netherlands; ⁸Instituto de Pesquisa Clínica de Campinas, Ipecc Instituto De Pesquisa Clínica de Campinas, Campinas, Brazil; ⁹Intensive Care, University Hospital RWTH Aachen, Aachen, Germany; ¹⁰Hospital de Base, Hospital de Base, Hospital de Base, Brazil; ¹¹Associação Educadora São Carlos AESC - Hospital Mãe de Deus - Centro de Pesquisa, Associação Educadora São Carlos AESC - Hospital Mãe de Deus - Centro de Pesquisa, São Paulo, Brazil; ¹²Intensive Care, General Hospital "Dr Aurelio Valdivieso", Juárez, Mexico; ¹³Department of Intensive Care Medicine, MST, Enschede, Netherlands; ¹⁴Intensive Care, City Clinical Hospital #5, Altayskiy kray, Ukraine; ¹⁵Intensive Care, Dr J. M. Engelbrecht Trial Site, Western Cape, South Africa; ¹⁶Intensive Care, Helen Joseph Hospital, University of the Witwatersrand - Helen Joseph Hospital, Johannesburg, South Africa; ¹⁷Department of Intensive Care Medicine, University Hospital, Antwerp, Belgium; ¹⁸Medical Affairs, Inflarx GmbH, Jena, Germany; ¹⁹Statistics, Metronomia Clinical Research GmbH, München, Germany; ²⁰Board, Inflarx GmbH, Jena, Germany

Correspondence: A. P. J. Vlaar

Intensive Care Medicine Experimental 2023, **11(Suppl 1)**:000372

Introduction: Vilobelimab (Vilo), a first-in-class anti-C5a monoclonal antibody, in a phase 3 adaptively designed multicenter, double-blind, placebo (Plc)-controlled study (N=369; Vilo n=177, Plc n=191) improved survival in invasive mechanically ventilated COVID-19 patients. The primary endpoint of 28-day (d) all-cause mortality was not met (HR 0.73; 95% CI 0.50–1.06; P=0.094) using site stratification within the Cox regression analysis. The prespecified, non-site stratified per protocol analysis, however, showed that Vilo statistically reduced 28-d all-cause mortality compared to Plc (HR 0.67; 95% CI 0.48–0.96; P=0.027).

Objectives: Additional statistical analysis was performed to confirm the efficacy of vilobelimab in critically ill, COVID-19 patients and to determine if other factors may have contributed to not meeting the primary endpoint.

Methods: Recruitment in each country was analyzed for random effects due to age. Using Cox regression, the primary outcome data for 28-d all-cause mortality was stratified by region, country, pooled sites with 1–3 patients, pooled sites with 1–4 patients and pooled sites with < 10 patients. In addition, a Frailty model was used to evaluate another possibility to adjust for site effects.

Results: Due to missing the primary endpoint using site stratification, a post-hoc analysis was undertaken and found that 61 patients from sites with no death or having enrolled only one patient could not contribute to the Cox regression analysis decreasing the trial's power using site stratification (Fig 1). In addition, the Plc group recruited in Brazil was a median of 9 years younger than the Vilo group and had very low mortality: 25% for 28-d and 32.5% for 60-d mortality. Adjusting the Cox regression for age-groups in Brazil changed the HR from 0.96 (60-d) to 0.77, close to the HR for the entire study, suggesting a similar survival benefit of Vilo in Brazil. Post-hoc analyses of the primary outcome using Cox regression stratified by country (age-adjusted HR 0.61; 95% CI 0.43–0.87; P=0.0067) and an analysis using a Frailty model (assigning random effects per site; age-adjusted HR 0.65, 0.45–0.93; P=0.018) both showed that Vilo significantly reduced all-cause mortality at d 28 (Fig 2). Additional post-hoc analysis pooling sites which had 1–3, 1–4 and < 10 patients also demonstrated significantly reduced all-cause mortality at d 28 with HRs of 0.68 (95% CI 0.47–0.98, P=0.040), 0.68 (95% CI 0.47–0.98, P=0.041) and 0.65 (95% CI 0.46–0.93, P=0.019), respectively. Treatment-emergent adverse events (AEs) were well balanced between treatment groups; Vilo 90.9% and Plc 91.0%. Serious AEs occurred in 58.9% of Vilo and 63.5% of Plc patients.

Conclusion: Multiple statistical analyses of PANAMO demonstrate that Vilo significantly reduces 28-d all-cause mortality despite lack of events (deaths) in smaller recruitment sites and age imbalances in one large recruiting country.

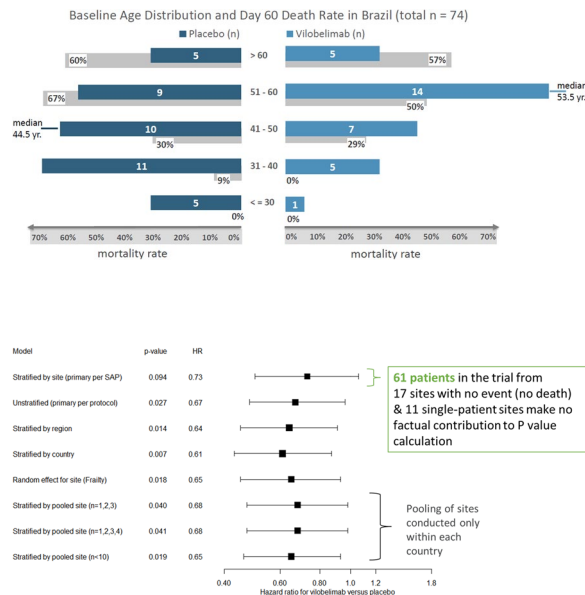

References

1. Vlaar APJ, Witenrath M, van Paassen P, et al. Anti-C5a antibody (vilobelimab) therapy for critically ill, invasively mechanically ventilated patients with COVID-19 (PANAMO): a multicentre, double-blind, randomised, placebo-controlled, phase 3 trial. *Lancet Respir Med*. 2022;10(12):1137–1146.
2. The trial is sponsored by InflaRx GmbH and partly funded by the German Federal Government through grant number 16LW0113 (Vilo-Covid).

Topic: Acute respiratory failure and mechanical ventilation

000375

Implementation and long-term effectiveness of a multifaceted CUSP intervention to reduce central line-associated bloodstream infections in intensive care units of a low middle-income country

W. Ali¹, S. Haleem², F. Mahmood³, T. Munir¹, N. Virani⁴, H. Khan¹, R. Roshan⁴, K. Hooda⁵, N. Khan⁶, A. Zafar⁷, A. Latif⁸, P. Pronovost⁹

¹Anesthesiology, Aga Khan University Hospital, Karachi, Pakistan; ²Spencer Center for Vision Research, Byers Eye Institute, Stanford University, Palo Alto, United States of America; ³Internal Medicine, Aga Khan University Hospital, Karachi, Pakistan; ⁴Infection Prevention and Hospital Epidemiology, Aga Khan University Hospital, Karachi, Pakistan; ⁵School of Nursing and Midwifery, Aga Khan University Hospital, Karachi, Pakistan; ⁶Office of the VP, Health services, Aga Khan University Hospital, Karachi, Pakistan; ⁷Pathology and Laboratory medicine, Aga Khan University Hospital, Karachi, Pakistan; ⁸Anaesthesia, Johns Hopkins University, Baltimore, United States of America; ⁹Leadership and Clinical Transformation, University Hospitals Cleveland Medical Center, Cleveland, United States of America

Correspondence: W. Ali

Intensive Care Medicine Experimental 2023, **11(Suppl 1)**:000375

Introduction: Central lines are crucial in managing critically ill ICU patients, providing access for monitoring, medications, and nutrition. The use of central lines, however, carries the risk of central line associated bloodstream infections (CLABSIs). CLABSIs are considered the third most common type of healthcare-associated infections (HAIs) accounting for almost a quarter of all hospital-acquired infections with a mortality rate up to 37%. We sought to determine whether a multifaceted intervention to reduce CLABSIs could be implemented in a low middle income (LMIC) setting in a sustainable manner.

Objectives:

1. To determine whether implementation of a multifaceted intervention would significantly reduce the incidence of central line-associated bloodstream infections
2. To assess the long-term effects of such an intervention and correlate CLABSI rates to the efficacy of the CUSP program intervention.

Methods: The study used a bundled intervention approach to prevent CLABSIs, consisting of the comprehensive unit-based safety program (CUSP) intervention pioneered by the Johns Hopkins University and the Agency for Healthcare Research and Quality (AHRQ). This included clinician education on evidence-based infection prevention, tools for identifying local barriers to implementing these practices, and ideas for ensuring patients received the necessary care. The intervention took place in 3 ICUs which were followed over a period of more than 9 years (May 2009–October 2018). The study had three phases: pre-intervention (6 quarters), intervention (16 quarters), and post-intervention (16 quarters). Each unit was tasked with assembling a multidisciplinary CUSP team to improve safety culture and teamwork. The CUSP team was further divided into 4 sub-groups; the executive group (EG), the physician group (PG), the nursing group (NG), and the CUSP implementation group (CG). Monthly team meetings were held between the CUSP teams where data was shared with the team for further action as needed. Attendance rates during these meetings for each sub-group were recorded. The primary outcome measure to assess the relationship between time since the implementation of the multifaceted program and CLABSI rates was explored by reporting the incidence rate ratios (IRR) using a Poisson regression model. Individual subgroup analysis was conducted to examine the correlation between CUSP meeting attendance percentage and the difference in CLABSI rates pre-intervention and during the intervention phase using the Wilcoxon rank sum test.

Results: The three intervention ICUs combined, where the multifaceted approach using CUSP was implemented achieved an overall 53% reduction (IRR = 0.53, p = 0.001 95% CI 0.36–0.77) in their CLABSI rates. The NICU experienced a decrease of 78% (IRR 0.23, p = 0.0006 95% CI 0.11–0.42) in CLABSI rates during the intervention phase and demonstrated a lasting effect of 1 year (4 quarters) during the post-intervention phase. The attendance rates for the CUSP sub-groups in the NICU were 88% (PG), 100% (NG), 91% (EG), and 97% (CG). The MICU demonstrated a reduction of 28% (IRR 0.72, p = 0.17 95% CI 0.44–1.18) in CLABSI rates during the intervention phase. Attendance in the MICU were 96% (PG), 100% (NG), 43% (EG) and 96% (CG). A 10% reduction in CLABSI rates in the SICU (IRR 0.92, p = 0.71 95% CI 0.56–1.49) was observed during the intervention phase with attendance rates of the subgroups being 71% (PG), 100% (NG), 75% (EG) and 54% (CG). When assessing differences in unit performance to reduce CLABSI rates, an attendance rate above 85% across all sub-groups during the CUSP meetings including senior leadership involvement in each CUSP meeting, correlated with a better infection reduction. This was demonstrated in the NICU with all four CUSP sub groups achieving an attendance rate above 85% (p < 0.05). Only 3 sub groups (p > 0.05) in the MICU and 2 sub groups (p > 0.05) in the SICU had an attendance rate above 85%.

Conclusions: The multi-faceted approach using the CUSP model can reduce the morbidity and mortality associated with CLABSIs in resource limited settings. We noted that in order to achieve sustained effects lasting for at least one-year post-intervention, a minimum attendance rate of 85% from each sub group is imperative.

References

1. Rosenthal VD. Central line-associated bloodstream infections in limited-resource countries: a review of the literature. *Clin Infect Dis*. 2009;49(12):1899–907.
2. Rosenthal VD, Guzman S, Migone O, Crnich CJ. The attributable cost, length of hospital stay, and mortality of central line-associated bloodstream infection in intensive care departments in Argentina: A prospective, matched analysis. *Am J Infect Control*. 2003;31(8):475–80.
3. Higuera F, Rangel-Frausto MS, Rosenthal VD, Soto JM, Castañón J, Franco G, et al. Attributable cost and length of stay for patients with central venous catheter-associated bloodstream infection in Mexico City

- intensive care units: a prospective, matched analysis. *Infect Control Hosp Epidemiol.* 2007;28(1):31–5.
- Chovanec K, Arsene C, Gomez C, Brixey M, Tolles D, Galliers JW, et al. Association of CLABSI With Hospital Length of Stay, Readmission Rates, and Mortality: A Retrospective Review. *Worldviews Evid Based Nurs.* 2021;18(6):332–8.
 - Network NHS. National Healthcare Safety Network (NHSN) Patient Safety Component Manual 2023.
 - Weiner LM, Webb AK, Limbago B, Dudeck MA, Patel J, Kallen AJ, et al. Antimicrobial-Resistant Pathogens Associated With Healthcare-Associated Infections: Summary of Data Reported to the National Healthcare Safety Network at the Centers for Disease Control and Prevention, 2011–2014. *Infect Control Hosp Epidemiol.* 2016;37(11):1288–301.
 - Allegranzi B, Bagheri Nejad S, Combescurre C, Graafmans W, Attar H, Donaldson L, et al. Burden of endemic health-care-associated infection in developing countries: systematic review and meta-analysis. *Lancet.* 2011;377(9761):228–41.
 - Olaechea PM, Palomar M, Álvarez-Lerma F, Otal JJ, Insausti J, López-Pueyo MJ. Morbidity and mortality associated with primary and catheter-related bloodstream infections in critically ill patients. *Rev Esp Quimioter.* 2013;26(1):21–9.
 - Ziegler MJ, Pellegrini DC, Safdar N. Attributable mortality of central line associated bloodstream infection: systematic review and meta-analysis. *Infection.* 2015;43(1):29–36.
 - Sarma JB, Ahmed GU. Infection control with limited resources: why and how to make it possible? *Indian J Med Microbiol.* 2010;28(1):11–6.
 - Pronovost PJ, Cleeman JJ, Wright D, Srinivasan A. Fifteen years after To Err is Human: a success story to learn from. *BMJ Qual Saf.* 2016;25(6):396–9.
 - This project was supported by a Faculty Pilot Grant from the Johns Hopkins Center for Global Health in 2011

Topic: Infections and prevention

000377

A machine learning approach to predict weaning success based on biosignal recordings and biomarkers

R. Lombardi¹, M. Jozwiak¹, J. Dellamonica¹, A. Iborra², C. Pasquier³
¹Intensive Care Unit, CHU de Nice, Nice, France; ²Data Intelligence Solutions, Talan Lyon, Lyon, France; ³SPARKS team, I3S, Sophia Antipolis, France

Correspondence: R. Lombardi

Intensive Care Medicine Experimental 2023, **11(Suppl 1)**:000377

Introduction: Several authors have been interested in applying Artificial Intelligence (AI) to medicine, using various Machine Learning (ML) techniques: managing septic shock, predicting renal failure... [1, 2] AI has an important place in decision support for clinicians [3].

The weaning period is a really important time in the management of a patient on mechanical ventilation and can take up to half of the time spent in intensive care unit. The first weaning attempt is unsuccessful in 20% of patients. However, mortality can be as high as 38% in patients with the most difficult weaning [4]. Only a few studies have looked at the application of machine learning in this area, and only one has looked at the use of biosignals (cardiac rate, ECG, ventilatory parameters...) [5–7]. To improve morbidity, mortality and reduce length of stay, it is essential to predict the success of the spontaneous breathing test and extubation.

Objectives: We propose to develop a predictive algorithm for the success of a ventilatory weaning test based on biosignal records and other features.

Methods: It is a critical care, oligo-centric and retrospective study.

We included biosignal variables extracted from the electronic medical record, such as respiratory (RR, minute volume...), cardiac (systolic pressure, heart rate...), ventilator parameters and other discrete variables (age, comorbidity...). Most biosignal variables are minute-by-minute records. Recording starts 48 h before the test and stops at the start of the weaning test.

We extracted features from these records, combined them with other biomarkers, and applied several machine learning algorithms: Logistic Regression, Random Forest Classifier, Support Vector Classifier (SVC),

XGBoost, and Light Gradient Boosting Method (LGBM)... To maximise prediction and minimise the risk of overfitting, we computed different methods: multiple imputation, oversampling and K-fold cross validation. The results are expressed in terms of AUC and AUC precision/recall (a variant of AUC, interpreted in a similar way, that is better suited to imbalanced data sets).

Results: The cohort included 133 patients (85 successful and 48 unsuccessful). The best results were obtained with the SVC algorithm with AUC-PR 0.9379 (AUC: 0.8857, F1 score: 0.8684). The other algorithms are slightly less efficient (Random Forest: 0.9104, Logistic Regression: 0.8765, KNN: 0.8708). The most important features for the prediction were weight gain since the admission, VAP presence, respiratory rate, systolic arterial pressure, PEP value...

Despite the small number of patients, all the techniques used allow good prediction and reproducibility. The main features are consistent with previous findings. In addition, the use of continuous and discrete data is new in this field. The cohort will continue to grow until the congress.

Conclusions: Machine learning applied to ventilator weaning is effective, especially when biosignal is used.

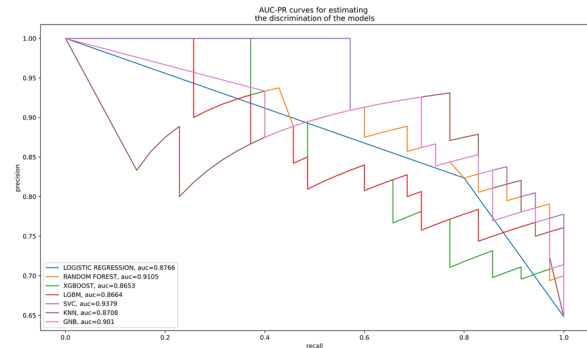

Figure 1 (abstract 000377) AUC Precision/Recall curves of the different machine learning algorithms

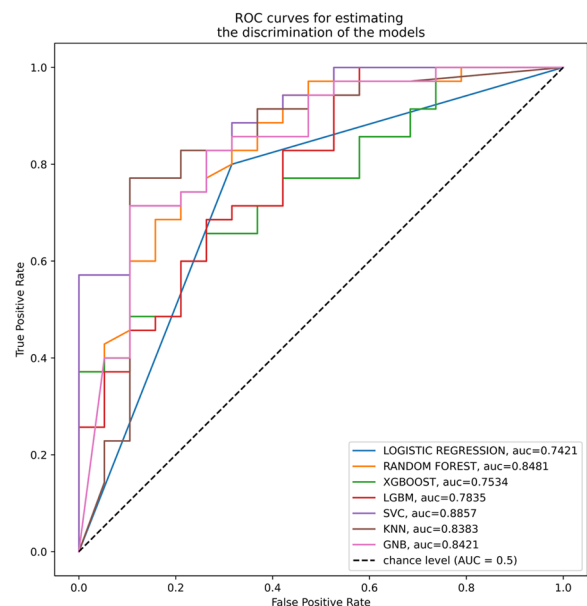

Figure 2 (abstract 000377) ROC-AUC curves of the different machine learning algorithms

References

3. Peiffer-Smadja N, Rawson TM, Ahmad R, et al. (2020) Machine learning for clinical decision support in infectious diseases: a narrative review of current applications. *Clin Microbiol Infect* 26:584–595. <https://doi.org/10.1016/j.cmi.2019.09.009>
4. Béduneau G, Pham T, Schortgen F, et al. (2017) Epidemiology of Weaning Outcome according to a New Definition. The WIND Study. *Am J Respir Crit Care Med* 195:772–783. <https://doi.org/10.1164/rccm.201602-0320OC>
5. Lin M-Y, Li C-C, Lin P-H, et al. (2021) Explainable Machine Learning to Predict Successful Weaning Among Patients Requiring Prolonged Mechanical Ventilation: A Retrospective Cohort Study in Central Taiwan. *Front Med* 8:663739. <https://doi.org/10.3389/fmed.2021.663739>
6. Liu W, Tao G, Zhang Y, et al. (2022) A Simple Weaning Model Based on Interpretable Machine Learning Algorithm for Patients With Sepsis: A Research of MIMIC-IV and eICU Databases. *Front Med* 8:814566. <https://doi.org/10.3389/fmed.2021.814566>
7. Park JE, Kim TY, Jung YJ, et al. (2021) Biosignal-Based Digital Biomarkers for Prediction of Ventilator Weaning Success. *Int J Environ Res Public Health* 18:9229. <https://doi.org/10.3390/ijerph18179229>
1. Komorowski M, Celi LA, Badawi O, et al. (2018) The Artificial Intelligence Clinician learns optimal treatment strategies for sepsis in intensive care. *Nat Med* 24:1716–1720. <https://doi.org/10.1038/s41591-018-0213-5>
2. Zhang Z, Ho KM, Hong Y (2019) Machine learning for the prediction of volume responsiveness in patients with oliguric acute kidney injury in critical care. *Crit Care* 23:112. <https://doi.org/10.1186/s13054-019-2411-z>

Topic: Data Science

000378

Training ChatGPT models in assisting critical care decision-making in routine practice

A. Sakagianni¹, C. Koufopoulou², I. Z. Boufeas³, P. Koufopoulos⁴, D. Kalles⁵, V. Kaldis⁶, V. S. Vergykios⁵, G. Feretzakis⁵¹Intensive Care Unit, Sismanogleio General Hospital, Marousi, Greece;²Anaesthesiology, Aretaieion University Hospital, Athina, Greece; ³Medical School, Barts and The London School of Medicine and Dentistry, London, United Kingdom; ⁴Medical School, National and Kapodistrian University of Athens, Athens, Greece; ⁵School of Science and Technology, Hellenic Open University, Patra, Greece; ⁶Emergency Department, KAT General Hospital of Attica, Kifisia, Greece

Correspondence: A. Sakagianni

Intensive Care Medicine Experimental 2023, 11(Suppl 1):000378

Introduction: Artificial intelligence (AI) has the potential to improve the precision and the effectiveness of the professional medical practice. An AI chatbot named ChatGPT (generative pre-trained transformer) can communicate with people online via text. It is trained by machine learning algorithms using large datasets.

Objectives: In this study, we compare the performance of a ChatGPT API 3.5 Turbo model to a general model, in obtaining accurate, valid, medical information, on critical care topics.

Methods: In this study, we used ChatGPT API 3.5 Turbo, which is a language model developed by OpenAI that can generate natural language text based on prompts provided by the user. The API was accessed through a Python script that was developed specifically for this study. We utilised the ERS/ESICM/ESCMID/ALAT 2023 guidelines [1]. We also used a PDF parsing tool, PyMuPDF [2], which is a collection of enhanced Python bindings for MuPDF to extract data from PDF files. We process embeddings using the OpenAI tokenizer tiktoken, as demonstrated by OpenAI [3]. As the pdf document used in our study contains 25,557 tokens and 98,663 characters, which cannot be handled all at once by OpenAI's GPT3.5-turbo, we segmented the source document into multiple sentences, of at most 300 tokens each.

Results: The ChatGPT models were handed with the same specific questions regarding the management of severe community-acquired pneumonia (sCAP). However, the custom model was trained with more specialized content on the given subject (the pdf file of ERS/ESICM/ESCMID/ALAT 2023 guidelines), while the general ChatGPT model replied to our questions, based on public datasets it was already

trained on. For example, some of the answers we received were: Question 1: "When using initial empirical therapy for sCAP, should a macrolide or fluoroquinolone be used as part of combination therapy, to reduce mortality and adverse clinical outcomes?"

Answer to Question 1 of Chat GPT: "For the initial empirical therapy of community-acquired pneumonia (CAP) in adults, the choice of antibiotics depends on various factors. The choice between a macrolide and a fluoroquinolone as part of combination therapy for CAP should be made based on local antibiotic resistance patterns, patient-specific factors such as allergies, potential drug interactions, and the severity of the infection. The decision should be made in consultation with a qualified healthcare professional who can consider the individual patient's condition and provide personalized medical advice."

Answer to Question 1 by using Chat GPT API 3.5 Turbo: "We suggest the addition of macrolides, not fluoroquinolones, to beta-lactams as empirical antibiotic therapy in hospitalised patients with sCAP. Conditional recommendation, very low quality of evidence."

Question 2: "When is the use of PCT recommended in patients with sCAP?"

Answer to Question 2 of Chat GPT: "...It's important to note that the use of PCT should be considered as part of a comprehensive clinical assessment, and should not replace clinical judgment. PCT levels should be interpreted in the context of the individual patient's clinical presentation, other laboratory results, and local antibiotic stewardship guidelines."

Answer to Question 2 by using Chat GPT API 3.5 Turbo: "The use of PCT is recommended to reduce the duration of antibiotic treatment in patients with sCAP, according to a conditional recommendation with low quality evidence. However, PCT levels may not be useful when clinical stability is achieved and the duration of antibiotic therapy is between 5 and 7 days, and must be considered together with clinical assessment".

The organization of these responses makes it abundantly clear that the trained model provides more accurate, and updated recommendations, on the topic. Further training of the model on specific anonymized patient information derived from the electronic health record, may provide more personalized medical advice.

Conclusions: By giving doctors more succinct, prompt responses about particular critical care topics, this specially trained model enables them to provide better patient care, making specific medical recommendations based on the latest clinical guidelines.

References

- None
- PyMuPDF, J. X. McKie, Pymupdf: Python bindings for mupdf's rendering library. <https://github.com/pymupdf/PyMuPDF>, 2012. (accessed on 4 March 2023)
- Martin-Loeches I, Torres A, Nagavci B, Aliberti S, Antonelli M, Bassetti M, et al. ERS/ESICM/ESCMID/ALAT guidelines for the management of severe community-acquired pneumonia. *Intensive Care Med*. 2023 Apr 4:1–18. <https://doi.org/10.1007/s00134-023-07033-8>.
- <https://github.com/openai/tiktoken> (accessed on 4 March 2023)
- https://github.com/openai/openai-cookbook/blob/main/examples/Question_answering_using_embeddings.ipynb (accessed on 4 March 2023)

Topic: Data Science

000381

Propafenone versus amiodarone for supraventricular arrhythmias in septic shock: a randomised controlled trial

M. Balik¹, M. Maly¹, E. Svobodova¹, M. Porizka¹, T. Brozek¹, M. Otáhal¹, J. Rulisek¹, R. Sachl¹, P. Brestovansky¹, J. Horejssek¹, Z. Stach¹, I. Jurisinova¹, M. Flaksa¹, A. Novotny¹, P. Trachta¹, P. Kopecky¹, J. Kunstyr¹, T. Tencer², J. Pazout², J. Belohlavek³, F. Duska², A. Krajcova², P. Waldauf²¹Anesthesiology and Intensive Care, General University Hospital,Prague, Czech Republic; ²Anesthesiology and Intensive Care, UniversityHospital Kralovske Vinohrady, Prague, Czech Republic; ³2nd Department

of Medicine, General University Hospital, Prague, Czech Republic

Correspondence: M. Balik

Intensive Care Medicine Experimental 2023, 11(Suppl 1):000381

Introduction: Acute onset supraventricular arrhythmias contribute to haemodynamic compromise in septic shock. Both amiodarone and propafenone are drugs of choice but their clinical effects have not been directly compared yet.

Objectives: To test the hypothesis that propafenone is superior to amiodarone in restoring and sustaining sinus rhythm (SR) in patients in septic shock complicated by acute onset supraventricular arrhythmias.

Methods: Randomized prospective controlled parallel group double blind trial (1), ClinicalTrials.gov NCT03029169, was performed in ICUs of two university hospitals.

209 septic shock patients fulfilling the JAMA 2016 criteria with new-onset arrhythmia and left ventricular ejection fraction above 35% were enrolled between October 2018 and July 2022. The patients were randomly assigned in 1:1 ratio to receive intravenous propafenone (70 mg bolus followed by 400–840 mg/24 h) or amiodarone (300 mg bolus followed by a maintenance dose of 600–1800 mg/24 h).

The primary outcomes were the proportion of patients who were in SR at 24 h after the start of the infusion, time to restoration of the first SR and proportion of patients with arrhythmia recurrence that occurred until hospital discharge or death.

The secondary outcomes were rates of electric cardioversions, need for unblinding, cross over, courses of vasopressors and patient outcomes.

Results: Out of 209 randomized patients (105 propafenone and 104 amiodarone), 200 (96%) received the study drug. After 24 h, 77 (72.8%) and 71 (67.3%) were in SR ($p=0.40$), restored after a median of 4.3 h (95% CI 2.8; 7.3) and 7.8 h (95% CI 5.9; 11), $p=0.03$, with propafenone and amiodarone, respectively. The arrhythmia recurred at least once in 54 (52%) patients treated with propafenone and in 80 (76%) with amiodarone, $p<0.001$. Patients with dilated left atrium had better rhythm control in amiodarone (6.4 h (95% CI 3.5; 14.1) until cardioversion vs 14.1 h (95% CI 2.8; 24.7) in propafenone, $p=0.05$).

40.4% in propafenone vs 32.4% ($p=0.2$) in amiodarone required electric cardioversion, courses of vasopressors did not differ. 15 (7.2%) patients had to be unblinded. The ICU mortality was not significantly lower in the propafenone group (38% vs 43% in amiodarone, $p=0.06$) as well as the long-term outcomes.

Conclusions: The administration of propafenone in septic shock does not provide a better rhythm control at 24 h yet offers faster cardioversion with less arrhythmia recurrences than with amiodarone, especially in patients with a non-dilated left atrium. Both drugs did not differ in their impacts on the short- (ICU, hospital) and long-term (90-day, 12 months) outcomes.

References

1. Balik M, Waldauf P, Maly M, et al. Efficacy and safety of 1C class antiarrhythmic agent (propafenone) for supraventricular arrhythmias in septic shock compared to amiodarone: protocol of a prospective randomised double-blind study. *BMJ open*. 2019;9(9):e031678.
2. Czech Health Research Council, NV18-06-00417

Topic: Cardiovascular issues in ICU

000383

Pulse wave characteristics and arterial wave reflections alteration in a long-term swine experiment of sepsis and resuscitation

M. Carrara¹, D. Guberti¹, S. M. Jakob², M. Ferrario¹

¹Department of Electronics, Information and Bioengineering, Politecnico di Milano, Milan, Italy; ²Department of Intensive Care Medicine, Bern University Hospital, Bern, Switzerland

Correspondence: M. Carrara

Intensive Care Medicine Experimental 2023, 11(Suppl 1):000383

Introduction: Sepsis is known to severely alter arterial blood pressure (ABP) waveform and cardiovascular function (1, 2). Previous studies have shown that the recommended therapy is not able to restore the hemodynamic profile of ABP waveform, although resuscitation was considered successful on the basis of standard parameters (3), suggesting a persistent hidden vascular disorder leading to impaired pulse wave reflections (2).

Objectives: The objective of this study is to investigate the changes in ABP waveform and wave reflections during a long-term swine experiment of polymicrobial sepsis and resuscitation.

Methods: 9 pigs underwent a protocol of polymicrobial sepsis followed by standard resuscitation. 5 pigs were treated as sham controls. Septic animals were studied at baseline (T1), after sepsis development (T2), after 24 h (T3) and 48 h (T4) of therapy administration, and sham controls at the same time points. ABP and arterial blood flow (ABF) were measured in the left and right carotid artery, respectively. We estimated the arterial input impedance (Zin) and the carotid characteristic impedance (Zc) by using frequency domain techniques based on Fourier series decomposition. The first harmonic of normalized Zin modulus, computed as the ratio between the modulus of Zin and Zc, was taken as an indicator of the global amount of reflections in the system (4). Augmentation index (AIx) was computed on ABP as $AIx = \Delta P / PP$, where ΔP is the systolic augmented pressure and PP is the pulse pressure, and it was taken as another surrogate of wave reflections (5).

Results: Table 1 reports the values of Zc for both populations. At T2 septic pigs showed a significantly higher value than sham pigs, which gradually decreased afterwards to values similar to baseline and sham pigs. Zc depends on vessel size, wall stiffness and blood properties, i.e. the stiffer the vessel and the smaller its diameter, the higher Zc. We can hypothesize that carotid stiffening may have played a crucial role in Zc increase following sepsis (2); moreover, the increased blood viscosity due to capillary leakage may have also contributed.

Table 1 (abstract 000383) Characteristic impedance [mmHg/mL/s] values (Zc)

	T1	T2	T3	T4
Septic	0.07 (0.06, 0.08)	0.1 (0.08, 0.1)	0.07 (0.05, 0.08)	0.06 (0.04, 0.07) n=8
Sham	0.07 (0.05, 0.08)	0.06 (0.05, 0.06)**	0.05 (0.05, 0.06) n=4	0.05 (0.04, 0.06) n=3

The values of AIx and the first harmonic of normalized Zin modulus are reported in Figure 1. Both indices were significantly reduced at T2 in septic pigs, highlighting a reduction of wave reflections probably due to the severe peripheral vasodilation induced by sepsis, as also reported in other studies (6). Accordingly, the shape of ABP waveform highly changed after sepsis development passing from a type A to a type C pulse (Figure 2). After therapy administration (T3 and T4), AIx was restored to values very similar to sham pigs and baseline; on the contrary, normalized Zin still showed significantly lower values in the septic population, hinting that a persistent arterial vascular disorder was still present despite the reaching of the overall hemodynamic targets according to guidelines (3). In support of this, an example of ABP waveform is shown in Figure 3: the ABP morphological characteristics in a sham pig after 72 h of resuscitation (T5) are similar to baseline, on the contrary, the ABP waveform in a septic pig is completely different from baseline and SH pig, despite the shape of the waveform has returned to a type A pulse as at baseline. This highlights some

weaknesses of Alx index when applied in critical care settings. Indeed, Alx reflects complex interactions: we know that it is influenced by HR changes (7), peripheral vasodilation (8), and pharmacological actions such as β 1-adrenergic stimulation (9) or noradrenaline (10). In critical condition, such as sepsis, several factors are changing at the same time, and this may lead to erroneous interpretations of Alx values and trends. **Conclusions:** Despite resuscitation was able to restore the overall morphology of ABP pulse, the computed indices highlighted that wave reflections may be still altered after 48 h of successful hemodynamic resuscitation, suggesting a persistent alteration of the arterial vasculature. We propose that a complex pathological condition like sepsis mandates an extensive monitoring including additional important information from commonly measured signals like ABP.

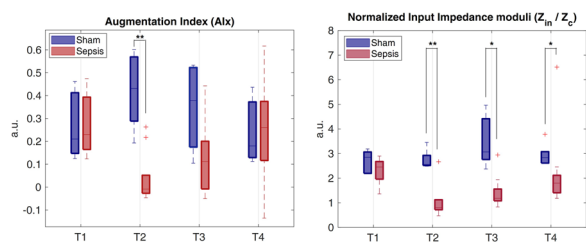

Figure 1 (abstract 000383) Distributions of values of augmentation index (Alx) and first harmonic of normalized input impedance (Z_{in}) modulus. Wilcoxon rank sum test: * $p < 0.05$, ** $p < 0.01$

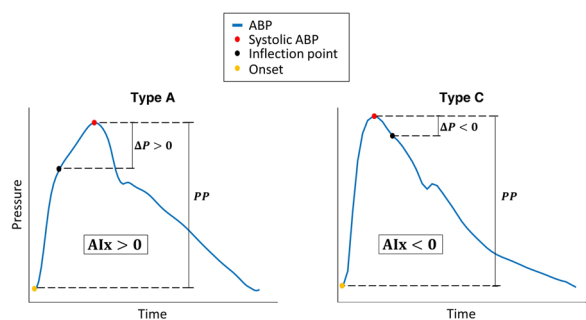

Figure 2 (abstract 000383) Examples of different types of arterial waveform. ABP=arterial blood pressure [mmHg]; ΔP =augmented pressure [mmHg]; PP=pulse pressure [mmHg], Alx=augmentation index [a.u]

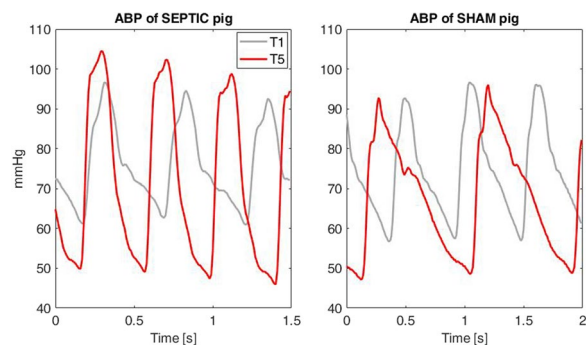

Figure 3 (abstract 000383) Example of carotid arterial blood pressure waveform (ABP) of a septic pig and a sham pig, at T1 (baseline) and T5 (72 h after the start of resuscitation)

References

1. Hatib F, Jansen JRC, Pinsky MR: Peripheral vascular decoupling in porcine endotoxic shock. *J Appl Physiol* 2011; 111:853–860
2. 4. Murgo JP, Westerhof N, Giolma JP, et al.: Aortic input impedance in normal man: Relationship to pressure wave forms. *Circulation* 1980; 62:105–116
3. 5. Torjesen A, Wang N, Larson MG, et al.: Forward and backward wave morphology and central pressure augmentation in men and women in the Framingham Heart Study. *Hypertension* 2015; 64:259–265
4. 6. Schroeder EC, Lefferts WK, Hilgenkamp TIM, et al.: Acute systemic inflammation reduces both carotid and aortic wave reflection in healthy adults. *Physiol Rep* 2019; 7
5. 7. Wilkinson IB, Mohammad NH, Tyrrell S, et al.: Heart rate dependency of pulse pressure amplification and arterial stiffness. *Am J Hypertens* 2002; 15:24–30
6. 9. Sharman JE, Davies JE, Jenkins C, et al.: Augmentation Index, Left Ventricular Contractility, and Wave Reflection. *Hypertension* 2009; 54:1099–1105
7. 8. Pauca AL, Kon ND, O'Rourke MF: Benefit of glyceryl trinitrate on arterial stiffness is directly due to effects on peripheral arteries. *Heart* 2005; 91:1428–143
8. 10. Monge García MI, Santos A, Díez Del Corral B, et al.: Noradrenaline modifies arterial reflection phenomena and left ventricular efficiency in septic shock patients: A prospective observational study. *J Crit Care* 2018; 47:280–286
9. 2. Carrara M, Antenucci P, Liu S, et al.: Autonomic and circulatory alterations persist despite adequate resuscitation in a 5-day sepsis swine experiment. *Sci Rep* 2022; 12:1–14
10. 3. Evans L, Rhodes A, Alhazzani W, et al.: Surviving sepsis campaign: international guidelines for management of sepsis and septic shock 2021. *Intensive Care Med* 2021; 47:1181–1247

Topic: Sepsis

000384

Echocardiography predictors of cardioversion of a supraventricular arrhythmia in septic shock

M. Balik¹, M. Maly¹, E. Svobodova¹, M. Porizka¹, T. Brozek¹, M. Otáhal¹, J. Rulisek¹, R. Sachl¹, P. Brestovansky¹, J. Horejsek¹, Z. Stach¹, I. Jurisinova¹, M. Flaksa¹, A. Novotny¹, P. Trachta¹, P. Kopecky¹, J. Kunstyr¹, T. Tencer², J. Pazout², F. Duska², A. Krajcova², P. Waldauf²

¹Anesthesiology and Intensive Care, General University Hospital, Prague, Czech Republic; ²Anesthesiology and Intensive Care, University Hospital Kralovske Vinohrady, Prague, Czech Republic

Correspondence: M. Balik

Intensive Care Medicine Experimental 2023, **11(Suppl 1)**:000384

Introduction: Supraventricular arrhythmias (SVA) contribute to haemodynamic compromise in septic shock and associate with two to five times worse survival.

Objectives: To propose echocardiography parameters which may help in the decision on rhythm versus rate control approach.

Methods: Exploratory analysis of a prospective controlled randomized trial (1), ClinicalTrials.gov Identifier NCT03029169, performed in ICUs of two university hospitals. Included were adult patients in septic shock according to JAMA 2016 criteria with a new onset or known paroxysmal SVA, excluded were with severe LV systolic dysfunction (EF_{LV} < 35%) or on a continuous noradrenaline > 1.0 $\mu\text{g}/\text{kg}$ min. Patients were assessed with echocardiography at the arrhythmia onset, +1 h and +4 h post cardioversion on an infusion of propafenone or amiodarone. There were no limits to electric cardioversions. The arrhythmia recurrences were analysed in relation to left atrial end-systolic diameter (LA_ESD), indexed biplanar volume (LAVI), left atrial active emptying (LA_emptying), transmitral A-wave and its velocity–time integral (Avti), transmitral E-wave and its deceleration time (DTe), pulmonary artery systolic pressure (PAPs) and a categorical parameter of a history of SVA.

Results: 209 patients were included between 2018 and 2022, of those 173 were analysed in sinus rhythm at 1 h and 187 at 4 h. With cardioversion, the heart rate slowed from a median of 130 (111; 146)/min to 84 (78; 100)/min at +1 h and 85 (77; 94)/min at +4 h, $p < 0.001$, accompanied by an increase of stroke volume from 50 (42; 60) ml to 66 (58; 78) ml at +1 h and 69 (60; 79) at +4 h, $p < 0.001$. The LA_ESD (40 (35; 44) mm) and LAVI (31 (26; 39) ml/m²) did not change with cardioversion, the LA_emptying (35.07 (33.12; 37.02)% at +1 h vs 37.6 (35.7; 39.5)% at +4 h, $p = 0.005$), a wave (0.67 (0.64; 0.71) m/s at +1 h vs 0.71 (0.67; 0.75) m/s at +4 h, $p = 0.002$) and the Avti (7.17 (6.81; 7.54) cm at +1 h vs 8.03 (7.68; 8.39) cm at +4 h were stepwise rising between +1 h and +4 h. The E-wave decreased ($p < 0.001$), DTe increased ($p < 0.001$), PAPs did not change while the TAPSE and RV_FAC increased with cardioversion (all $p < 0.001$). The best predictors of arrhythmia recurrences were LA_emptying at +4 h with the cut off 38.4%, AUC 0.69, $p < 0.001$, and Avti at +4 h with the cut off 6.8 cm, AUC 0.65, $p = 0.001$. The PAPs 51 mmHg at +4 h, AUC 0.63, $p = 0.007$, predicted only multiple recurrences (>3) as well as the LA_ESD at arrhythmia onset ($p = 0.04$). The LAVI ($p = 0.06$) and arrhythmia history ($p = 0.09$) were not useful.

Conclusions: Simple 2D left atrial and transmitral Doppler parameters at 4 h post cardioversion may help to decide on a rhythm control strategy in septic shock.

References

1. Balik M, Waldauf P, Maly M, et al. Efficacy and safety of 1C class antiarrhythmic agent (propafenone) for supraventricular arrhythmias in septic shock compared to amiodarone: protocol of a prospective randomised double-blind study. *BMJ open*. 2019;9(9):e031678.
2. Czech Health Research Council, NV18-06-00417

Topic: Cardiovascular issues in ICU

000385

Prognostic value of serum ferritin levels in COVID-19 ICU patients with septicemia

F. Ampatzidou¹, C. C. Theocharidou¹, K. Armentzioiou-Tasiopoulou², M. Endiaroglou¹, I. Gourlomat¹, A. Dimaki¹, G. Zapsi¹, A. Lionta¹
¹3rd ICU, General Hospital of Thessaloniki "George Papanikolaou", Thessaloniki, Greece; ²Nephrology Department, General Hospital of Thessaloniki "George Papanikolaou", Thessaloniki, Greece

Correspondence: C. C. Theocharidou

Intensive Care Medicine Experimental 2023, **11(Suppl 1)**:000385

Introduction: Serum ferritin is elevated during infectious diseases as part of normal host response. On the other hand, severe hyperferritinemia is a marker of injurious hyper-inflammation. Recent studies have investigated the connection between hyperferritinemic sepsis and multiple organ dysfunction syndrome (MODS).

Objectives: Our aim was to investigate the prognostic value of serum ferritin levels in COVID-19 ICU patients with septicemia. We also assessed the role of other inflammation markers such as procalcitonin (PCT), interleukin-6 (IL-6), c-reactive protein (CRP) and white blood cell count (WBC).

Methods: From January 2022 to February 2023, a total of 194 patients were admitted to our ICU. All patients with confirmed septicemia were included in our study. Ferritin, PCT, IL-6, CRP and WBC values were measured from samples collected within 24 to 48 h from the timepoint of a positive blood culture. We investigated all inflammation markers as prognostic markers for death and need for renal replacement therapy (RRT). We used t-test for parametrical data and Mann-Whitney U test for non-parametrical data. We also performed receiver operating characteristic (ROC) analysis for significant results. Statistical significance was set at $p = 0.05$.

Results: Seventy-five patients were included in the analysis. Median age was 69 years (interquartile range—IQR=58, 75) and 45 of the patients were male (60%). Twenty-one patients died in the ICU (28%) and 23 patients needed RRT. Patient characteristics are described in Table 1. Deceased patients presented with significantly higher ferritin and IL-6 ($p < 0.0001$ and $p = 0.018$ respectively). Serum ferritin was also higher in the RRT group ($p = 0.049$) whereas CRP was lower ($p = 0.037$). Regarding death, no significant differences were found for PCT, CRP and WBC. In ROC analysis for ferritin and the outcome of death the area under the curve (AUC) was 0.889 (confidence interval—CI: 0.783, 0.994) with $p < 0.001$. For IL-6 the AUC was 0.785 (CI: 0.643, 0.927) with $p = 0.002$. A cut-off value of 1514 ng/mL for ferritin yielded 92.9% sensitivity and 85.3% specificity for the prediction of death.

Table 1 (abstract 000385) Description of patient characteristics (non-parametrical data)

	Median	IQR (25th, 75th)	N
Age (years)	69	(58, 75)	75
Total days in ICU	17	(9, 32)	75
IL-6 (pg/mL)	93	(50, 1831)	52
PCT (ng/mL)	0.49	(0.18, 1.65)	75
Ferritin (ng/mL)	997	(432, 1927)	75
CRP (mg/dL)	9.05	(4.44, 17.49)	75
WBC (per μ L)	13,500	(8800, 17,600)	75

Conclusions: Our study revealed that serum ferritin values within 24 to 48 h from the timepoint of a positive blood culture have a statistically significant relationship with mortality in COVID-19 ICU patients with septicemia. High ferritin could be an early indicator of worse outcome. IL-6 levels were the only other inflammatory marker with statistically significant relationship with mortality. Also, there is statistically significant relationship between high ferritin levels and the need for RRT.

References

1. Fang YP, Zhang HJ, Guo Z, Ren CH, Zhang YF, Liu Q, Wang Z, Zhang X. Effect of Serum Ferritin on the Prognosis of Patients with Sepsis: Data from the MIMIC-IV Database. *Emerg Med Int*. 2022 Dec 6;2022:2104755. <https://doi.org/10.1155/2022/2104755>
2. Salomão R, Ferreira BL, Salomão MC, Santos SS, Azevedo LCP, Brunialti MKC. Sepsis: evolving concepts and challenges. *Braz J Med Biol Res*. 2019;52(4):e8595. <https://doi.org/10.1590/1414-431X20198595>. Epub 2019 Apr 15

Topic: Sepsis

000391

Early rehabilitation: bridging the gap. Enhanced ward-based rehabilitation for survivors of critical illness

R. Corbett¹, E. Cairney², J. Coulbeck²

¹Physiotherapy, University Hospital Southampton Foundation Trust, Southampton, United Kingdom; ²Therapies, University Hospital Southampton Foundation Trust, Southampton, United Kingdom

Correspondence: R. Corbett

Intensive Care Medicine Experimental 2023, **11(Suppl 1)**:000391

Introduction: An Early Mobilisation Project (EMP) was introduced at University Hospital Southampton (UHS) in 2012, consisting of two

therapy technicians delivering additional therapy sessions for medical patients who required mechanical ventilation for > 24 h and a preceding hospital stay < 1 week. In 2016 we successfully bid for a further two Band 4 generic therapy technicians to continue enhanced therapy on the medical wards; our programme began in 2017. Since then, the team have worked through the introduction of Post Intensive Care Syndrome (PICs) related outcome measures, staff vacancies, a pause during the pandemic and a relaunch in 2023.

Objectives: To reduce the ward length of stay (LOS) and collect PICs related outcome measures for patients enrolled on the ICU EMP.

Methods: Patients receive individually tailored daily rehabilitation programmes (Monday–Friday); in addition to usual ward therapy. Rehabilitation options include ward activities, gym sessions, home visits, hydrotherapy, wellbeing discussions and visits to shops or restaurants within the hospital. In addition to collecting ward length of stay data, we also record the following: Chelsea Critical Care Physical Assessment Tool (CPAx), Barthel, timed up and go (TUG) and the Intensive Care Psychological Assessment Tool (IPAT).

Results:

	(Base- line) Janu- ary– March 2016	Janu- ary– March 2017	Janu- ary– March 2018	Janu- ary– March 2019	Janu- ary– March 2020	2021/22 EMP Data Not Collected (COVID/ Staffing)	Janu- ary– March 2023
Total number of patients	13	25	24	15	8		13
Male:female	7:6	15:10	16:8	10:5	4:4		6:7
Age	64.7	69	58	58	64.9		53
Ward LOS	27.2	11.5	12.2	9.5	19.8		6.8
Hospital LOS	33.6	25.6	24.8	26.7	29.2		14.3
Barthel improvement	–	–	49.8%	37.7%	35%		50.8%
CPAx improvement	–	–	–	42.8%	44.4%		19.2%
TUG improvement	–	–	–	–	–		6.2 Secs
IPAT average score	–	–	–	5.75	10.8		3.7

Conclusions: There has been a reduction in both ward and hospital LOS since the introduction of our ward-based rehabilitation program. The functional outcome measures utilised have demonstrated an improvement in scores and the IPAT results are below the threshold for concern. However, we are aware that we have no baseline data to compare. The start of the global pandemic in early 2020 may explain the elevated LOS and IPAT scores in Jan–March 2020. Employing generic therapy technicians means patients benefit from clinicians with both physiotherapy and occupational therapy skills. Our project has highlighted the need for a variety of outcome measures sensitive to identifying the signs and symptoms of PICs; beyond the physical and psychological. From 2023 we have begun using the Montreal Cognitive Assessment (MOCA); this will be recorded at ward admission and discharge home. All patients who were in employment prior to admission will receive follow-up calls at 1 week, 1 month and 3-month post hospital discharge to ascertain if they have returned to employment and if not—what the barriers are. We intend to investigate relevant treatment options for patients with PICs.

Topic: Nursing care and physiotherapy

000392

Risk factors associated with disability in patients with subarachnoid hemorrhage in a neurotraumatic ICU: a nine-year study

C. Sánchez Ramírez¹, C. F. Lübbe Vázquez¹, M. Cabrera Sánchez¹, M. San Martín Bragado¹, L. Lara Franco¹, F. J. Lapi Cerezo¹, A. Padrón Mujica¹, P. Saavedra-Santana², S. Ruiz-Santana¹

¹Intensive Care Medicine, University Hospital of Gran Canaria Dr. Negrin, Las Palmas de Gran Canaria, Spain; ²Mathematics and Informatics Department, University of Las Palmas, Las Palmas de Gran Canaria, Spain

Correspondence: C. Sánchez Ramírez

Intensive Care Medicine Experimental 2023, 11(Suppl 1):000392

Introduction: Aneurysmal subarachnoid hemorrhage (SAH) is a global health burden with serious consequences such as permanent disability. It is important to know the risk factors for disability and to identify those that can be prevented in order to reduce them.

Objectives: To evaluate risk factors for disability in patients admitted with subarachnoid hemorrhage (SAH) admitted to a neurotraumatic ICU.

Methods: Prospectively collected data from patients admitted from October 2013 to December 2022 in a 10-bed Neurotrauma ICU. We analyzed: main diagnosis on admission; demographics, including sex and race; neurological data (clinical examination, pupil reactivity and size, and Glasgow Coma Score (GCS); aneurysm location and size; presence of intracranial hematoma (ICH); presence and volume of intraventricular hemorrhage; days to develop vasospasm; development of acute cerebral ischemia (ACI) and delayed cerebral ischemia (DCI); Fisher scale, modified Fisher scale, Hunt and Hess scale, World Federation of Neurosurgeons (WFNS) scale; presence of vasospasm on Doppler or arteriography; delayed ICU admission; treatment of the aneurysm; complications, including infections; Glasgow Outcome Scale (GOS) at ICU discharge and 6 months after ICU discharge and several other risk factors. Disability was defined as GOS ≤ 3. To identify those factors that maintained an independent association with disability, multivariate logistic regression analysis was performed. It was considered significant if $p \leq 0.05$. To determine the discriminatory ability of the Score, a receiver operating characteristic (ROC) analysis was performed. The diagnostic ability of the Score was assessed by the area under the ROC curve, which was estimated using a 95% confidence interval. For the chosen cutoff point, sensitivity, specificity, positive predictive value (PPV) and negative predictive value (NPV) were calculated.

Results: Among the 246 patients admitted for SAH, 90 (37.67%) had a GOS ≤ 3. DCI was not significantly different between the groups studied (Table 1). Fifty-one patients died, 36 at ICU discharge and 16 in hospital. Decompressive craniectomy was performed in 12 (5.4%) patients with SAH, all with GOS ≤ 3. Independent risk factors associated with disability were: mechanical ventilation (MV) > 7 days OR: 5.696 (2.535; 12.798). ACI OR: 5.012 (1.374; 18.286); Hunt and Hess score OR: 1.449 (1.099; 1.911) and Apache II on ICU admission per unit OR: 1.164 (1.090; 1.243) (Table 2).

The following Score was derived from the logistic model: $0.152 \times \text{Apache II} + 1.740 \times \text{MV} > 7 \text{ days} + 1.612 \times \text{ACI} + 0.371 \times \text{Hunt and Hess score}$.

Here, $\text{MV} > 7 \text{ days} = 1/0$ according to $\text{MV} > 7 \text{ days}$ or not.

The area under the curve (AUC) was 0.92 IC 95% IC (0.873; 0.951) (Figure 1). Cut-off point: 0.4757; specificity: 86.2 [79.7; 91.2]; sensitivity 83.3 [74.0; 90.4]; NPV: 89.7 [83.6; 94.1]; PPV: 78.1 [68.5; 85.9] (Table 3).

Conclusions: In our study, 37.67% of SAH patients had severe disability at ICU discharge. In SAH patients admitted to a neurotraumatic ICU, the risk factors that were independently associated with disability were: score: $\text{MV} > 7 \text{ days}$, ACI, Hunt and Hess score and Apache II at ICU admission per unit. A predictive score was obtained.

Table 1a (abstract 000392) Univariate analysis of SAH disability 9 years

Table 1. Characteristics of the patients: overall and according to the presence or absence of disability (GOS ≤ 3)

Table 1.a	Overall N = 246	No N = 156	Yes N = 90	P
Age (years)	56.6 ± 14.7	53.9 ± 13.1	61.2 ± 16.1	< .001
Sex female	160 (65.0)	102 (65.4)	58 (64.4)	0.882
Apache-II at admission	14.0 ± 7.7	10.4 ± 5.8	20.2 ± 6.7	< .001
SOFA at admission	2 (0 - 6)	1 (0 - 3)	7.0 (3.2 - 9.0)	< .001
Deaths	51 (20.7)	3 (1.9)	48 (53.3)	< .001
ICU-Deaths	36 (14.6)	0	36 (40.0)	< .001
Hospital-Deaths	16 (6.5)	3 (1.9)	13 (14.4)	< .001
Arterial hypertension	111 (45.1)	60 (38.5)	51 (56.7)	0.006
Diabetes	26 (10.6)	11 (7.0)	15 (16.7)	0.018
Dislipemia	57 (23.2)	33 (21.1)	24 (26.7)	0.324
Number of platelets at ICU admission	22 (8.9)	10 (6.4)	12 (13.3)	0.067
Urgent surgery at ICU admission	39 (15.8)	19 (12.2)	20 (22.2)	0.038
Oriented	123 (50.2)	105 (67.7)	18 (20.0)	< .001
Alert	135 (54.9)	108 (69.2)	27 (30.0)	< .001
Confused	37 (15.0)	18 (11.5)	19 (21.1)	0.043
Stuporous	62 (25.2)	22 (14.1)	40 (44.4)	< .001
Bilateral mydriasis	9 (3.7)	1 (0.6)	8 (8.9)	0.002
Anisochoric pupils	28 (11.4)	11 (7.0)	17 (18.9)	0.005
Isochoric pupils	211 (85.8)	143 (91.7)	68 (75.6)	< .001
Both Isochoric pupils	213 (86.6)	144 (92.3)	69 (76.7)	< .001
None Isochoric pupils	15 (6.1)	4 (2.6)	11 (12.2)	0.002
Midline artery aneurysm	68 (27.6)	44 (28.2)	24 (26.7)	0.795
Anterior Cerebral artery aneurysm	19 (7.7)	9 (5.8)	10 (11.1)	0.131
Anterior Communicating artery aneurysm	73 (29.7)	42 (26.9)	31 (34.4)	0.214
Posterior inferior cerebellar artery aneurysm	10 (4.1)	4 (2.6)	6 (6.7)	0.177
Aneurysm clipping	49 (19.9)	24 (15.4)	25 (27.8)	0.019
Trombolysis	4 (1.6)	1 (0.6)	3 (3.3)	0.14
Decompressive craniectomy	13 (5.3)	1 (0.6)	12 (13.3)	< .001
Death after treatment	4 (1.6)	0	4 (4.4)	0.017
External ventricular device	120 (48.8)	50 (32.0)	70 (77.8)	< .001
Stroke	69 (28.1)	29 (18.6)	40 (44.4)	< .001
Hydrocephalus	100 (40.6)	39 (25.0)	61 (67.8)	< .001
MV>7 days	78 (31.7)	16 (10.3)	62 (68.9)	< .001
ICH	64 (26.0)	26 (16.7)	38 (42.2)	< .001
Frontal ICH	40 (16.3)	11 (7.0)	29 (32.2)	< .001
Temporal ICH	32 (13.0)	14 (9.0)	18 (20.0)	0.013

MV: mechanical ventilation;
ICH: intracranial hematoma

Table 2 (abstract 000392) Multivariate logistic regression of SAH disability at ICU discharge 9 years

	P	Odd-Ratio (95% IC)
Apache-II at admission (per unit)	< 0.001	1.164 (1.090 ; 1.243)
Mechanical ventilation >7 days	< 0.001	5.696 (2.535 ; 12.798)
ACI	0.012	5.012 (1.374 ; 18.286)
Hunt y Hess score	0.009	1.449 (1.099 ; 1.911)

ACI: acute cerebral ischemia

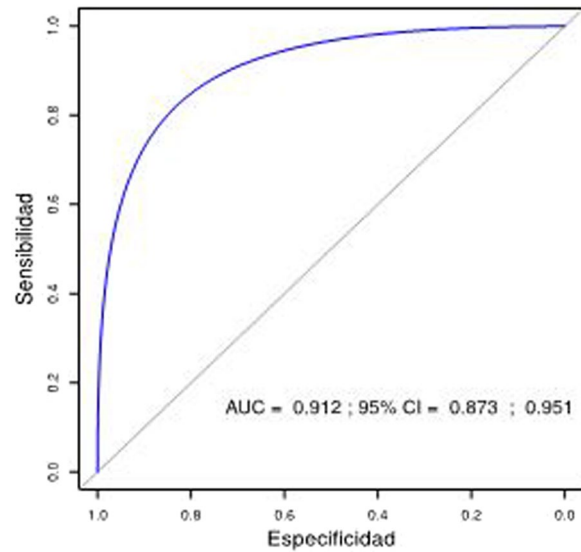

Figure 1 (abstract 000392) ROC curve SAH and disability 9 years

Table 1b (abstract 000392) Univariate analysis SAH and disability

Table 1. Characteristics of the patients: overall and according to the presence or absence of disability (GOS ≤ 3)

Table 1.b	Overall N = 246	No N = 156	Yes N = 90	P
Acute Cerebral Ischemia	21 (8.5)	6 (3.9)	15 (16.7)	< .001
Delayed Cerebral Ischemia	55 (22.4)	30 (19.2)	25 (27.8)	0.121
Resangrado a 72 h	11 (4.5)	2 (1.3)	9 (10.0)	0.002
Ventriculitis	20 (8.1)	10 (6.4)	10 (11.1)	0.194
Fisher scale	4 (3 - 4)	3 (2 - 4)	4 (4 - 4)	< .001
Fisher modified scale	4 (3 - 4)	3 (2 - 4)	4 (4 - 4)	< .001
Hunt and Hess scale	2 (1 - 4)	1 (1 - 2)	4 (2 - 5)	< .001
WFNS scale	2 (1 - 4)	1 (1 - 2)	4 (2 - 5)	< .001
APACHE- Vasoospasm	14 (6 - 18)	12 (7 - 16)	18 (14 - 23)	< .001
SOFA- Vasoospasm	4 (1 - 6)	2 (1 - 4)	6 (4 - 9)	< .001
Delayed admission after bleeding	10 (2 - 24)	8 (2 - 21)	12 (4 - 24)	0.223
GCS on site	15 (12 - 15)	15 (14 - 15)	13 (6 - 15)	< .001
GCS in emergency room	14 (9 - 15)	15 (13 - 15)	9 (6 - 14)	< .001
GCS at ICU admission	14 (4 - 15)	15 (11 - 15)	6 (3 - 10)	< .001

MV: mechanical ventilation; ICH: intracranial hematoma.

Table 3 (abstract 000392) Diagnostic value for the score taking as cut-off 0.4757 (closest to the top-left corner)

Sensitivity	Specificity	Predictive values	
		Positive	Negative
83.3 [74.0 ; 90.4]	86.2 [79.7 ; 91.2]	78.1 [68.5 ; 85.9]	89.7 [83.6 ; 94.1]

Data are estimates (95% CI)
Parameters are shown as percentages

Topic: Neurointensive care

000393

Risk factors associated with delayed cerebral ischemia in patients with subarachnoid hemorrhage in a neurotraumatic ICU: a nine-year study

C. Sánchez Ramírez¹, C. F. Lübbe Vázquez¹, M. Cabrera Sánchez¹, M. San Martín Bragado¹, L. Lara Franco¹, F. J. Lapi Cerezo¹, P. Saavedra-Santana², S. Ruiz-Santana¹

¹Intensive Care Medicine, University Hospital of Gran Canaria Dr. Negrin, Las Palmas de Gran Canaria, Spain; ²Mathematics and Informatics Department, University of Las Palmas, Las Palmas de Gran Canaria, Spain

Correspondence: C. Sánchez Ramírez

Intensive Care Medicine Experimental 2023, 11(Suppl 1):000393

Introduction: Delayed cerebral ischemia (DCI) is a major contributor to the high morbidity and mortality rates of aneurysmal subarachnoid hemorrhage (SAH). About 30% of patients with SAH have DCI, but it is difficult to predict which patients will develop it.

Objectives: To prospectively assess risk factors for DCI in patients with SAH admitted to a neurotraumatic ICU.

Methods: Prospectively collected data of patients admitted from October 2013 to December 2022 to a 10-bed Neurotraumatic ICU. We analyzed: main diagnosis at admission; demographics, including sex and race; neurological data (clinical examination, pupil reactivity and size, and Glasgow Coma Score: GCS; aneurysm localization and size; presence of intracranial hematoma (ICH); presence and volume of intraventricular bleeding; days to develop vasospasm; development of DCI; Fisher scale, Modified Fisher Scale (MFS), Hunt and Hess scale (HHS), Word Federation of Neurosurgeons scale (WFNS); presence of vasospasm in doppler or arteriography; delayed ICU admission; aneurysm treatment; complications, including infections; Glasgow Outcome Scale (GOS) at ICU discharge and 6 months after ICU discharge and several other risk factors. A univariate analysis of DCI was performed. To obtain an DCI prediction rule, a prediction model was obtained using the classification and regression trees (CART) procedure [1]. CART classifies data using a sequence of if-then rules. The basis of decision tree algorithms is the recursive binary partitioning of the data. First the most discriminative variable is selected to split the data set into child nodes. The partitioning continues until some stopping criterion is reached. At each terminal node, the probability of DCI was estimated as the proportion of patients belonging to that node who developed the event. The tree was constructed according to the following algorithm: in the first stage, the tree grows until all cases are correctly classified, and in the second stage, we used the tenfold cross-validation method of successive pruning [1]. Finally, the tree that minimized the error measurement (deviance) was chosen. For this predictor, the corresponding ROC curve was obtained and the AUC was estimated using a 95% CI.

Results: A total of 246 patients with SAH were collected, of whom 55 (22.35%) developed DCI. Demographic data and types of admission are shown in Tables 1a and 1b. Anterior communicating artery (Aco) aneurysms were the most frequently encountered. The most frequent complications of patients with DCI were stroke 39 (70.9%) and hydrocephalus 28 (50.9%). Thirty-six (14.6%) of the patients with SAH died at ICU discharge. Eleven (20%) of the patients with SAH and DCI died at ICU discharge. There was no statistically significant difference in mortality in patients with DCI vs. patients with SAH. The classification tree showed that: $MFS \leq 2$ had 94.5% odds of no DCI (Figure 1). The AUC was 0.645 (0.577–0.713), a high negative prediction of DCI (Figure 2).

Conclusions: Our data show that 22.35% of the patients studied had DCI. The classification tree showed a high negative predictive value for DCI. Finally, mortality was not significantly higher in the patients studied than in the total patients with SAH.

Table 1a (abstract 000393) Univariate analysis SAH and DCI 9 years

Table 1 a. Characteristics of the patients: overall and according to DCI				
	Overall N = 246	No DCI N = 191	DCI N = 55	P
Age (years)	56.6 ± 14.7	57.4 ± 15.0	53.6 ± 13.4	0.092
Sex female	160 (65.0)	118 (61.8)	42 (76.4)	0.046
Apache-II at admission	14.0 ± 7.7	13.5 ± 7.8	15.9 ± 7.2	0.05
SOFA ICU admission	2 (0 - 6)	2 (0 - 5.5)	4 (1 - 8)	0.034
Death	51 (20.7)	37 (19.4)	14 (25.4)	0.327
Death at ICU discharge	36 (14.6)	25 (13.1)	11 (20.0)	0.201
Hospital death	16 (6.5)	12 (6.3)	4 (7.3)	0.761
Arterial hypertension	111 (45.1)	84 (44.0)	27 (49.1)	0.502
Diabetes	26 (10.6)	20 (10.5)	6 (10.9)	0.926
Dyslipemia	57 (23.2)	44 (23.0)	13 (23.6)	0.926
Smoker	98 (39.8)	73 (38.2)	25 (45.5)	0.334
Platelet inhibitors	39 (15.8)	26 (13.6)	13 (23.6)	0.073
Emergency surgery at admission	20 (8.1)	18 (9.4)	2 (3.6)	0.261
Oriented	123 (50.2)	108 (56.8)	15 (27.3)	< .001
Alert	135 (54.9)	115 (60.2)	20 (36.4)	0.002
Confused	37 (15.0)	27 (14.1)	10 (18.2)	0.46
Stuporous	62 (25.2)	38 (19.9)	24 (43.6)	< .001
Bilateral mydriasis	9 (3.7)	7 (3.7)	2 (3.6)	1
Anisochoric pupils	28 (11.4)	16 (8.4)	12 (21.8)	0.006
Isochoric pupils	211 (85.8)	168 (88.0)	43 (78.2)	0.067
Bilateral aneurysm	213 (86.6)	169 (88.5)	44 (80.0)	0.104
No reactive pupil	15 (6.1)	11 (5.8)	4 (7.3)	0.749
Anterior communicating artery aneurysm	73 (29.7)	57 (29.8)	16 (29.1)	0.914
Posterior communicating artery aneurysm	36 (14.6)	24 (12.6)	12 (21.8)	0.087
Aneurysm clipping	49 (19.9)	31 (16.2)	18 (32.7)	0.007
Intraventricular thrombolysis	4 (1.6)	4 (2.1)	0	0.578
Embolization of the aneurysm	143 (58.1)	109 (57.1)	34 (61.8)	0.529
Decompressive craniectomy	13 (5.3)	8 (4.2)	5 (9.1)	0.173
Intraoperative aneurysm rupture	17 (6.9)	11 (5.8)	6 (10.9)	0.225
Died after treatment	4 (1.6)	3 (1.6)	1 (1.8)	1
External ventricular device	120 (48.8)	84 (44.0)	36 (65.5)	0.005
Hydrocephalus	100 (40.6)	72 (37.7)	28 (50.9)	0.079

(%)Values are frequencies (%), means ± SD and medians (IQR). MV: mechanical ventilation, ICH: intracerebral hematoma, DCI: delayed cerebral ischemia, GOS: Glasgow outcome score, WFNS: World Federation Neurosurgical Societies.

Table 1b (abstract 000393) Univariate analysis SAH and DCI 9 years

Table 1 b.				
	Overall N = 246	No DCI N = 191	DCI N = 55	P
Stroke	69 (28.1)	30 (15.7)	39 (70.9)	< .001
MV > 7 days	78 (31.7)	52 (27.2)	26 (47.3)	0.001
Frontal ICH	40 (16.3)	32 (16.8)	8 (14.6)	0.696
Temporal ICH	32 (13.0)	27 (14.1)	5 (9.1)	0.327
Vasospasm doppler	55 (25.7)	30 (18.4)	25 (49.0)	< .001
Vasospasm Arteriography	49 (21.2)	18 (10.0)	31 (60.8)	< .001
Acute cerebral ischemia	21 (8.5)	18 (9.4)	3 (5.5)	0.426
Rebleeding 72 hours	11 (4.5)	7 (3.7)	4 (7.3)	11 (4.1)
Ventriculitis	20 (8.1)	12 (6.3)	8 (14.6)	20 (8.1)
Fisher scale	4 (3 - 4)	4 (3 - 4)	4 (3 - 4)	0.285
Fisher modified scale	4 (3 - 4)	3 (2 - 4)	4 (3 - 4)	0.001
Hunt and Hess scale	2 (1 - 4)	2 (1 - 3)	3 (1.2 - 4)	0.003
WFNS scale	2 (1 - 4)	2 (1 - 4)	3.5 (1 - 4)	0.007
APACHE vasospasm	14 (8 - 18)	13 (8 - 17)	16 (8 - 20)	0.14
SOFA vasospasm	4 (1 - 6)	3 (1 - 5)	4 (2 - 8)	0.257
ICU re-admission by vasospasm	10 (2 - 24)	8 (2 - 24)	12 (6 - 24)	0.056
GCS on site	15 (12 - 15)	15 (13 - 15)	14 (10 - 15)	0.16
GCS in emergency room	14 (9 - 15)	14 (10 - 15)	12 (7 - 15)	0.027
GCS at ICU admission	14 (4 - 15)	14 (5 - 15)	9 (4 - 15)	0.03

Values are frequencies (%), means ± SD and medians (IQR). MV: mechanical ventilation, ICH: intracerebral hematoma, DCI: delayed cerebral ischemia, GOS: Glasgow outcome score, WFNS: World Federation Neurosurgical Societies.

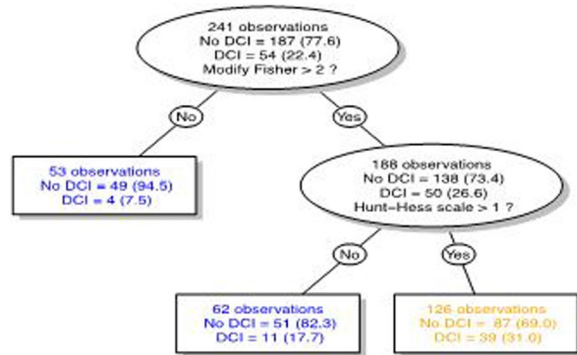

Figure 1 (abstract 000393) Decision tree DCI 9 years

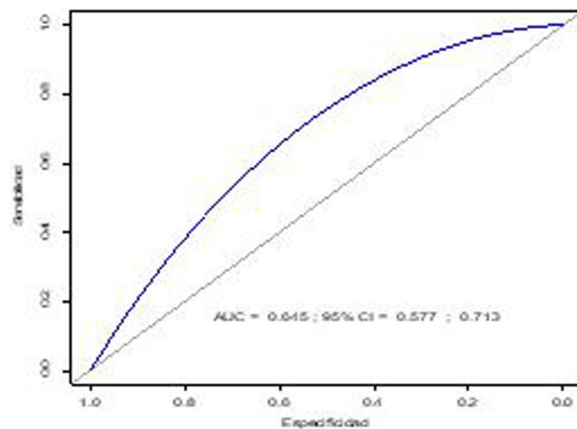

Figure 2 (abstract 000393) ROC curve for the diagnosis rule based on the decision tree; for a cutoff of 0.2435, the rule has a sensitivity of the 72.2% and specificity of 53.5%

Topic: Neurointensive care

000395

Evaluating Bispectral Index monitoring in paralysed adult critical care patients

G. Shattock¹, J. Hanison¹, A. Parker¹, A. Wilson¹, M. Azzawi²

¹Adult Critical Care Unit, Manchester Royal Infirmary, Manchester University NHS Foundation Trust, Manchester, United Kingdom;

²Department of Life Sciences, Manchester Metropolitan University, Manchester, United Kingdom

Correspondence: G. Shattock

Intensive Care Medicine Experimental 2023, **11(Suppl 1)**:000395

Introduction: Adequate sedation of critically ill patients receiving neuromuscular blocking agents (NMBA) is vital for preventing awareness (1).

Bispectral Index monitoring (BIS) is a method of assessing depth of sedation but data supporting BIS and target values comes from experience in the operating theatre and there is insufficient evidence about BIS in critically ill patients and whether this changes sedation use (2).

Objectives: To evaluate BIS use in critically ill patients receiving NMBA infusions in a large adult general critical care unit, evaluate compliance with BIS and assess sedation change in response to BIS values.

Methods: Data was collected retrospectively from patients admitted to the Adult Critical Care Unit at Manchester Royal Infirmary between 1st June 2020 and 31st December 2021. We extracted data on BIS, sedation, heart rate (HR), mean arterial blood pressure (MAP) and noradrenaline requirements. BIS values were grouped into >60, 40 to 60 and <40. We assessed differences between groups at set time points after commencing NMBA.

Results: 451 episodes of NMBA infusion were identified in 241 patient encounters. 224 episodes (49.7%) had BIS data recorded at least once in the five hours following NMBA infusion commencement. Of 756 BIS values recorded in ≤ 5 h, 96.7% were ≤ 60 of which 51.1% were between 40 and 60, and 45.6% were <40. Of 235 BIS values recorded at 12 h, 97.0% were ≤ 60 of which 48.1% were between 40 and 60, and 48.9% were <40.

During the first 5 h of NMBA infusion, in 46.4% (104/224) of episodes, the mean BIS value was <40, whilst in 53.6% (120/224) the mean BIS value was ≥ 40. There was no significant difference in the mean volumes of propofol, midazolam or alfentanil infused in this time between the two groups ($p=0.09$, $p=0.12$, $p=0.78$ respectively). Similarly, there was no difference in mean HR, MAP or noradrenaline dosing between the groups ($p=0.93$, $p=0.32$, $p=0.38$ respectively). In episodes with BIS ≥ 40 in the first hour, the median change in BIS at 12 h was -7 (IQR -11 to 0) whilst episodes with BIS <40, the median change was +3 (IQR -2.5 to 11), ($p<0.001$). There was no difference in the rate of propofol, midazolam and alfentanil infusions between these groups at hour one and hour twelve ($p=0.08$, $p=0.85$, $p=0.98$, respectively).

Conclusions: We found BIS was only recorded in the first five hours for half of the patients receiving NMBA infusion. This may partly reflect insufficient resources, particularly during the COVID-19 pandemic when the need for NMBA infusions was high (3). Reassuringly, most patients had BIS ≤ 60 which provides some confidence of a lack of awareness in these patients.

Approximately half of the patients may have had excessively low BIS values (<40) which may represent unnecessary over sedation with a similar proportion still having BIS values <40 at 12 h. This may suggest insufficient adjustment of sedation in response to low BIS values, lack of awareness of appropriate BIS values or a lack of confidence in the output of BIS monitoring.

References

3. Parker AJ, Mishra M, Tiwary P, Sharman M, Priya-Sharma M, Duncan A, et al. A Tale of Two Waves: Changes in the Use of Noninvasive Ventilation and Prone Positioning in Critical Care Management of Coronavirus Disease 2019. *Crit Care Explor.* 2021;3(12):e0587.
2. Shetty RM, Bellini A, Wijayatilake DS, Hamilton MA, Jain R, Karanth S, et al. BIS monitoring versus clinical assessment for sedation in mechanically ventilated adults in the intensive care unit and its impact on clinical outcomes and resource utilization. *Cochrane Database Syst Rev.* 2018;2:CD011240.
1. Warr J, Thiboutot Z, Rose L, Mehta S, Burry LD. Current therapeutic uses, pharmacology, and clinical considerations of neuromuscular blocking agents for critically ill adults. *Ann Pharmacother.* 2011;45(9):1116-26.

Topic: Sedation, analgesia and delirium

000396

Effect of restrictive cumulative fluid balance on 28-day survival in invasively ventilated patients with ARDS due to COVID-19

F. Hohmann¹, R. Tremel², T. Caldonazo³, P. Andrade⁴, A. Carvalho⁴, J. Silva Jr¹

¹Department of Critical Care Medicine, Albert Einstein Israelita Hospital, São Paulo, Brazil;

²Department of Anesthesiology and Intensive Care Medicine, Friedrich-Schiller-University, Jena, Germany;

³Department of Cardiothoracic Surgery, Friedrich-Schiller-Universität, Jena, Germany;

⁴Department of Anesthesiology, Servidor Público Estadual de São Paulo Hospital, São Paulo, Brazil

Correspondence: F. Hohmann

Intensive Care Medicine Experimental 2023, 11(Suppl 1):000396

Introduction: Patients with SARS-CoV-2 infection can express a broad spectrum of clinical manifestations, from asymptomatic to severe coronavirus disease 2019 (severe COVID-19) marked by a prominent acute respiratory distress syndrome (ARDS) [1]. Recently, it has been shown that both a daily positive fluid balance in the intensive care unit (ICU), as well as a positive cumulative fluid balance (CFB) at discharge from the ICU are associated with high mortality in patients with sepsis [2, 3]. Tissue edema due to fluid overload is a well-known mechanism of pulmonary function worsening [4].

Objectives: To evaluate the effect of two restrictive cumulative fluid balance (CFB) trends on 28-day survival in the Intensive Care Unit (ICU) in invasively ventilated patients with moderate and severe respiratory distress syndrome (ARDS) due to SARS-CoV-2.

Methods: Prospective observational single-center cohort study in the ICU of a tertiary hospital. The selected patients were older than 18 years old with confirmed infection due to SARS-CoV-2 who required endotracheal intubation and mechanical ventilation immediately at the admission at the intensive care unit. None of the patients included in this study was vaccinated against SARS CoV-2.

Results: It was enrolled 171 patients (Figure 1) in the study and divided according to their CFB trends during seven days of follow-up using model-based clustering, median restrictive CFB negative trend [n=89] -279 ml (-664 to 203) and [n=82] median restrictive CFB positive trend 1362 ml (619 to 2026). The group with CFB negative trend showed a higher chance of surviving 28-day in the ICU ([Figure 2 and 3] unadjusted Hazard Ratio: 0.62, 95% CI, 0.41-0.94, p=0.038). Moreover, this group had a reduced length of stay in the ICU, 11 (8-19) days versus 16.5 (9-29) days, p=0.004, and presented higher odds (OR=0.22; 95% CI 0.09 to 0.52) of not being invasively ventilated after 28-days in the ICU. Length of mechanical ventilator stay was lower in CFB negative trend group 12 (9-19) versus 14.5 (9-25.5), p=0.04.

Conclusions: In patients invasively ventilated with moderate-severe ARDS due to COVID-19, the collective who showed a negative trend inside the restrictive CFB after seven days of invasive ventilation had a higher chance of surviving 28 days in the ICU and lower length of stay in the ICU.

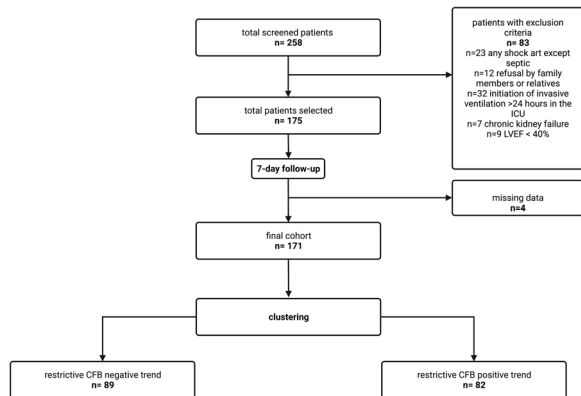

Figure 1 (abstract 000396) Study design and overview of the patient inclusion and analytical cohorts. Cumulative Fluid Balance (CFB), Intensive Care Unit (ICU), Left Ventricle Ejection Fraction (LVEF)

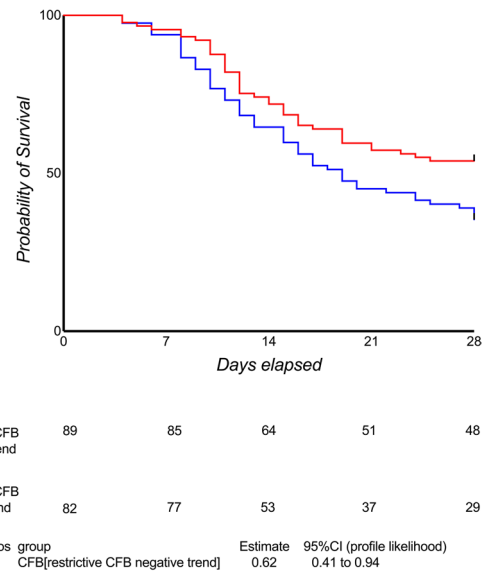

Figure 2 (abstract 000396) Kaplan–Meier with the estimated cumulative probability of 28-day survival. Cumulative Fluid Balance (CFB), 95% Confidence Interval (95% CI)

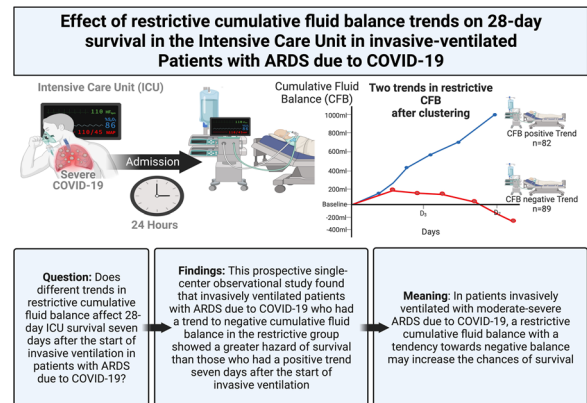

Figure 3 (abstract 000396) Graphical abstract summarizing the main findings

References

3. Yoo MS, Zhu S, Lu Y, Greene JD, Hammer HL, Iberti CT, Nemazie S, Ananias MP, McCarthy CM, O'Malley RM et al.: Association of Positive Fluid Balance at Discharge After Sepsis Management With 30-Day Readmission. JAMA Network Open 2021, 4(6):e216105–e216105.
2. Acheampong A, Vincent JL: A positive fluid balance is an independent prognostic factor in patients with sepsis. Critical care (London, England) 2015, 19(1):251.
1. Zhu N, Zhang D, Wang W, Li X, Yang B, Song J, Zhao X, Huang B, Shi W, Lu R et al.: A Novel Coronavirus from Patients with Pneumonia in China, 2019. New England Journal of Medicine 2020, 382(8):727–733.

- Ricardo Esper Trembl and Tulio Caldonazo are supported by the Clinical Scientist Program (Jena University Hospital). The authors thank all patients and healthcare personnel involved in the study.
- Jaffee W, Hodgins S, McGee WT: Tissue Edema, Fluid Balance, and Patient Outcomes in Severe Sepsis: An Organ Systems Review. *Journal of intensive care medicine* 2018, 33(9):502–509.

Topic: Acute respiratory failure and mechanical ventilation

000397

Serum LDH levels may predict poor neurological outcome after aneurysmal subarachnoid hemorrhage

E. Bogossian¹, J. Cantos¹, A. Farinella², M. Anderloni³, G. Coppalini⁴, A. Diosdado⁵, F. Oliveira¹, F. S. Taccone¹

¹Soins intensif, ULB Erasme, Anderlecht, Belgium; ²Anaesthesia and Intensive Care, Università degli studi di Ferrara, Ferrara, France; ³Anesthesia and Intensive Care B BR Unit, University of Verona, AOUI-University Hospital Integrated Trust of Verona, Verona, Italy; ⁴Anaesthesia and Intensive Care, Humanitas Research Hospital, Milan, Italy; ⁵Anesthesiology, Hospital del Mar, Barcelona, Spain

Correspondence: E. Bogossian

Intensive Care Medicine Experimental 2023, **11(Suppl 1)**:000397

Introduction: Cerebral hypoxia is an important cause of secondary brain injury. Improving systemic oxygenation may increase brain tissue oxygenation (PbtO₂). The effects of PEEP on PbtO₂ and intracranial pressure (ICP) needs to be further elucidated.

Objectives: To study the effects of PEEP increments on brain tissue oxygenation and intracranial pressure.

Methods: This is a single center retrospective cohort study (2016–2021) conducted in the intensive care unit of Erasme University Hospital, Brussels, Belgium. All patients with acute brain injury under mechanical ventilation who were monitored with intracranial pressure and brain tissue oxygenation (PbtO₂) catheters and underwent at least one PEEP increment were included in the study. Primary outcome was the rate of PbtO₂ and ICP increases after PEEP increase.

Results: We included 115 patients who underwent 295 episodes of PEEP increase. Overall, PEEP increased from 6 (5–8) cmH₂O to 10 (8–12) cmH₂O, PbtO₂ increased from 21 (16–29) mmHg to 23 (18–30) mmHg while ICP remained statistically unchanged from 12 (7–18) mmHg to 12 (7–17) mmHg. ICP increased in 142/295 episodes of PEEP increments (58%) and no baseline variable was able to identify this response. Of 163 episodes of PEEP increments with concomitant PbtO₂ monitoring, PbtO₂ increased in 102 (63%). A higher baseline PaO₂ (OR 1.02 [1.01–1.03]) and a lower baseline PbtO₂ (OR 0.92 [0.91–0.94]) were associated with PbtO₂ increase.

Conclusions: The response in PbtO₂ and ICP to PEEP elevations in brain injury patients is highly variable. Lower PbtO₂ values and higher PaO₂ at baseline could predict an increase in brain oxygenation after PEEP increments.

References

- Nemer, S. N. et al. Effects of positive end-expiratory pressure on brain tissue oxygen pressure of severe traumatic brain injury patients with acute respiratory distress syndrome: A pilot study. *J Crit Care* 30, 1263–1266, <https://doi.org/10.1016/j.jcrc.2015.07.019> (2015).
- Wolf, S., Plev, D. V., Trost, H. A. & Lumenta, C. B. Open lung ventilation in neurosurgery: an update on brain tissue oxygenation. *Acta Neurochir Suppl* 95, 103–105, https://doi.org/10.1007/3-211-32318-x_22 (2005).
- Muench, E. et al. Effects of positive end-expiratory pressure on regional cerebral blood flow, intracranial pressure, and brain tissue oxygenation. *Crit Care Med* 33, 2367–2372, <https://doi.org/10.1097/01.ccm.0000181732.37319.df> (2005)

Topic: Neurointensive care

000398

Can we use eosinophils to predict survival successfully in COVID-19 ICU patients? A retrospective study

C. C. Theocharidou¹, F. Ampatzidou¹, M. Endiaroglou¹, I. Gourlomat¹, S. Pontikidou¹, M. Triantafyllou¹, E. Bellou¹, A. Dimaki¹

¹3rd ICU, General Hospital of Thessaloniki “George Papanikolaou”, Thessaloniki, Greece

Correspondence: C. C. Theocharidou

Intensive Care Medicine Experimental 2023, **11(Suppl 1)**:000398

Introduction: During the various waves of the COVID19 pandemic, a lot of biomarkers and inflammation markers, expensive or inexpensive, have been investigated in order to assess possible outcome in COVID-19 patients. There are few publications regarding eosinophil count or eosinophil to neutrophil ratio as a mortality prognostic marker.

Objectives: Our main aim was to assess the prognostic value of eosinophil count and eosinophil to neutrophil ratio in COVID-19 ICU patients.

Methods: We collected data from patients who were admitted to our COVID-19 ICU from April 2021 to March 2023. We recorded sex, age, ICU stay duration, outcome, maximum eosinophil count, day of maximum eosinophils (Dmax) and neutrophil count on Dmax. We tested the eosinophil to neutrophil ratio (E/N), multiplied by 1000 for readability, as a prognostic marker for death. We used the Mann–Whitney U test as we dealt with non-parametrical data. We performed receiver operating characteristic (ROC) analysis for significant results. We also performed logistic regression analysis for the outcome of death depending on age, sex, and E/N ratio. Statistical significance was set at p=0.05.

Results: A total of 290 patients were included in the study. Ninety-nine of them were female (34%) and 149 of them died in the ICU (51.4%). We compared two groups of patients, those who died in the ICU and those who survived. Characteristics of the two groups are described in Table 1. Statistically significant differences were found for age, maximum eosinophil count, neutrophils at Dmax and E/N. In ROC analysis for E/N and the outcome of survival the area under the curve (AUC) was 0.854 (confidence interval—CI: 0.809, 0.898). A cut-off value of 19.23 for E/N yielded 85% sensitivity and 74% specificity for the outcome of survival. Logistic regression for the outcome of death depending on age, sex and E/N revealed that a higher value of E/N decreased the likelihood of the patient dying.

Table 1 (abstract 000398) Characteristics of the two groups of patients according to outcome

Outcome	Discharged alive (N = 141)		Died in ICU (N = 149)		
	Median	IQR	Median	IQR	p
Age (years)	66	(55, 75)	71	(62.5, 77)	0.007
ICU stay duration (days)	9	(2.5, 19)	9	(5, 20)	0.5
Maximum eosinophil count (cells/ μ L)	310	(165, 555)	90	(20, 270)	<0.0001
Day of max eosinophils (Dmax)	7	(2, 15.5)	6	(2, 12)	0.278

Outcome	Discharged alive (N = 141)		Died in ICU (N = 149)		p
	Median	IQR	Median	IQR	
Neutrophils on Dmax (cells/ μ L)	6500	(4550, 9150)	13,800	(8500, 20,000)	< 0.0001
Eosino-philisX1000/Neutrophils	49.5	(24.69, 92.28)	5.58	(1.27, 20.17)	< 0.0001

Conclusions: During a COVID-19 patient’s stay in the ICU, the eosinophil to neutrophil ratio can prove to be quite useful as it is a sensitive marker for survival. Moreover, the absolute maximum eosinophil count is higher in COVID-19 ICU patients who are discharged alive from the ICU. Using a cheap test, such as complete blood count, we can predict the outcome of COVID-19 ICU patients.

References

- Palladino M. Complete blood count alterations in COVID-19 patients: A narrative review. *Biochem Med (Zagreb)*. 2021 Oct 15;31(3):030501. <https://doi.org/10.11613/BM.2021.030501>
- Koc I, Unalli Ozmen S. Eosinophil Levels, Neutrophil–Lymphocyte Ratio, and Platelet-Lymphocyte Ratio in the Cytokine Storm Period of Patients with COVID-19. *Int J Clin Pract*. 2022 Aug 3;2022:7450739. <https://doi.org/10.1155/2022/7450739>

Topic: Infections and prevention

000399

Outcomes comparison between the first and the subsequent SARS-CoV-2 waves—a systematic review and meta-analysis

F. Vianna¹, F. Hohmann¹, T. Caldonazo², R. Trem³, P. Tasoudis⁴, H. Kirov², J. Silva Jr¹

¹Department of Critical Care Medicine, Albert Einstein Israelita Hospital, São Paulo, Brazil; ²Department of Cardiothoracic Surgery, Friedrich-Schiller-Universität, Jena, Germany; ³Department of Anesthesiology and Intensive Care Medicine, Friedrich-Schiller-University, Jena, Germany; ⁴Department of Cardiothoracic Surgery, University of North Carolina at Chapel Hill, Chapel Hill, United States of America

Correspondence: F. Hohmann

Intensive Care Medicine Experimental 2023, **11(Suppl 1)**:000399

Introduction: In the beginning of the SARS-CoV-2 pandemic, patients with COVID-19 were treated with general supportive measures, as specific treatments were unknown [1]. National and societies guidelines released initially advised against the administration of systemic corticosteroids and limited the use of non-invasive ventilation to specific populations or clinical scenarios [1, 2]. The subsequent waves could be faced with new diagnostic and therapy tools (e.g., anti-viral medications and vaccines) [3, 4–9].

Objectives: Assess and describe differences in the clinical and demographic features, treatments and outcomes of COVID-19 adult patients admitted in the first and subsequent waves of the pandemic.

Methods: We performed a systematic review and meta-analysis with three databases. The primary outcome was in-hospital mortality. The secondary outcomes were intensive care unit (ICU) mortality, ICU length of stay (LOS), acute renal failure, extracorporeal membrane oxygenation (ECMO) implantation, mechanical ventilation time, hospital LOS, systemic thromboembolism, myocarditis and ventilator associated pneumonia.

Results: A total of 25 studies (Figure 1) with 126,153 patients were included. There was no significant difference for the primary endpoint ((Figure 2) OR = 0.94, 95% CI 0.83–1.07, p = 0.35). The first wave group presented higher rates of ICU LOS (SMD = 0.23, 95% CI 0.11–0.35, p < 0.01), acute renal failure (OR = 1.71, 95% CI 1.36–2.15, p < 0.01) and ECMO implantation (OR = 1.64, 95% CI 1.06–2.52, p = 0.03). The other endpoints did not show significant differences.

Conclusions: The analysis suggests that the first wave group when compared with the subsequent waves group presented higher rates of ICU LOS, acute renal failure and ECMO implantation, without significant difference in in-hospital or ICU mortality, mechanical ventilation time, hospital LOS, systemic thromboembolism, myocarditis or ventilator associated pneumonia (Figure 3).

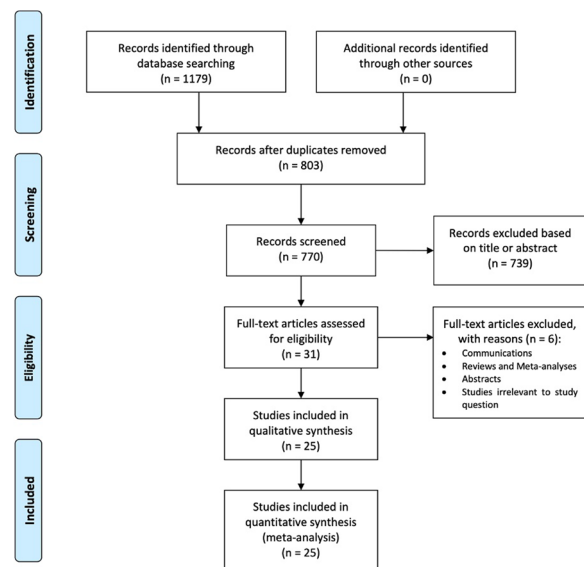

Figure 1 (abstract 000399) Preferred reporting items for systematic reviews and meta-analyses (PRISMA) flow diagram

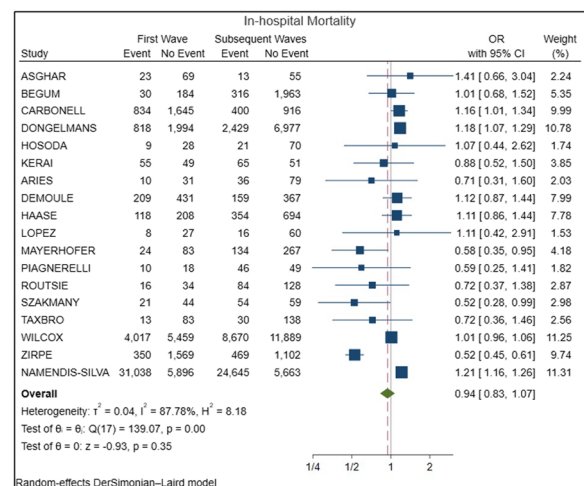

Figure 2 (abstract 000399) Forest plot for in-hospital mortality. CI = confidence interval; OR = odds ratio

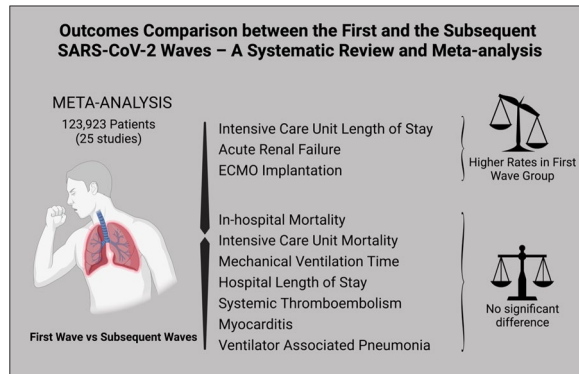

Figure 3 (abstract 000399) Graphical abstract showing the main findings of the analysis

References

- [9] Gordon AC, Mouncey PR, Al-Beidh F, Rowan KM, Nichol AD, Arabi YM et al. Interleukin-6 Receptor Antagonists in Critically Ill Patients with Covid-19. *N Engl J Med* 2021;384:1491–502.
- [8] Perkins GD, Ji C, Connolly BA, Couper K, Lall R, Baillie JK et al. An adaptive randomized controlled trial of non-invasive respiratory strategies in acute respiratory failure patients with COVID-19. *medRxiv* 2021:2021.08.02.21261379.
- [7] Grieco DL, Menga LS, Cesarano M, Rosà T, Spadaro S, Bitondo MM et al. Effect of Helmet Noninvasive Ventilation vs High-Flow Nasal Oxygen on Days Free of Respiratory Support in Patients With COVID-19 and Moderate to Severe Hypoxemic Respiratory Failure: The HENIVOT Randomized Clinical Trial. *Jama* 2021;325:1731–43.
- [6] Beigel JH, Tomashek KM, Dodd LE, Mehta AK, Zingman BS, Kalil AC et al. Remdesivir for the Treatment of Covid-19—Final Report. *N Engl J Med* 2020;383:1813–26.
- [5] Horby P, Lim WS, Emberson JR, Mafham M, Bell JL, Linsell L et al. Dexamethasone in Hospitalized Patients with Covid-19. *N Engl J Med* 2021;384:693–704.
- [4] Tocilizumab in patients admitted to hospital with COVID-19 (RECOVERY): a randomised, controlled, open-label, platform trial. *Lancet* 2021;397:1637–45.
- [3] Ospina-Tascón GA, Calderón-Tapia LE, García AF, Zarama V, Gómez-Álvarez F, Álvarez-Saa T et al. Effect of High-Flow Oxygen Therapy vs Conventional Oxygen Therapy on Invasive Mechanical Ventilation and Clinical Recovery in Patients With Severe COVID-19: A Randomized Clinical Trial. *Jama* 2021;326:2161–71.
- [2] Cinesí Gómez C, Peñuelas Rodríguez Ó, Luján Torné M, Egea Santaolalla C, Masa Jiménez JF, García Fernández J et al. Clinical consensus recommendations regarding non-invasive respiratory support in the adult patient with acute respiratory failure secondary to SARS-CoV-2 infection. *Med Intensiva (Engl Ed)* 2020;44:429–38.
- [1] Wang D, Hu B, Hu C, Zhu F, Liu X, Zhang J et al. Clinical Characteristics of 138 Hospitalized Patients With 2019 Novel Coronavirus-Infected Pneumonia in Wuhan, China. *Jama* 2020;323:1061–69.
- The authors would like to thank the authors of the papers included in this systematic review and meta-analysis, as well as all the people who helped in some way in its elaboration.

Topic: Infections and prevention

000401

Association of chest computed tomography and respiratory outcomes in COVID-19 patients

F. Hohmann¹, R. Tremil², D. Rocha¹, T. Caldonazo³, P. Andrade⁴, A. Carvalho⁴, J. Silva Jr¹

¹Department of Critical Care Medicine, Albert Einstein Israelita Hospital, São Paulo, Brazil; ²Department of Anesthesiology and Intensive Care

Medicine, Friedrich-Schiller-University, Jena, Germany; ³Department of Cardiothoracic Surgery, Friedrich-Schiller-Universität, Jena, Germany; ⁴Department of Anesthesiology, Servidor Público Estadual de São Paulo Hospital, São Paulo, Brazil

Correspondence: F. Hohmann

Intensive Care Medicine Experimental 2023, **11(Suppl 1)**:000401

Introduction: Chest CT scans of patients with Covid-19 most commonly show ground-glass lesions, consolidations or mosaic-type lesions (1–3), predominantly distributed in basal and peripheral regions and with bilateral involvement (4). The greater the pulmonary involvement, the greater the need for ICU admission and the use of invasive mechanical ventilation (5–7).

Objectives: To verify the association of the initial assessment of chest computed tomography in cases of COVID 19 infection with respiratory outcomes in the ICU, using the classification of the Radiological Society of North America and an automatic software.

Methods: A single-center, retrospective study that evaluated patients with positive RT-PCR for COVID-19, who underwent chest computed tomography and had a final COVID-19 clinical diagnosis. The visual tomographic classification was evaluated according to the Consensus of the Radiological Society of North America and software developed for detection of chance estimation of COVID-19. According to the percentage of pulmonary involvement in > 50% and ≤ 50%, patients were compared regarding respiratory clinical and laboratory outcomes.

Results: A total of 121 patients were clustered into the >50% lung involvement group and 105 patients into the ≤50% lung involvement group. Patients ≤ 50% lung involvement group presented lower PEEP levels and FiO₂ values, respectively P = 0.09 and P = 0.04. The adjusted COX model found high hazard ratio for > 50% lung involvement group HR: 1.69, 95% CI, 1.02–2.80, p = 0.042 and the adjusted logistic regression model showed increased risk ventilator-associated pneumonia OR = 1.85 95% CI 1.01–3.39.

Conclusions: COVID-19 infection patient's with >50% lung involvement present association to longer mechanical ventilator time (Figure 1) and more ventilator-associated pneumonia rate.

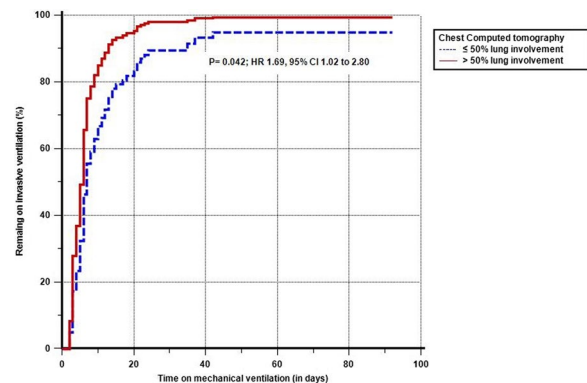

Figure 1 (abstract 000401) Kaplan–Meier curve showing chest computed tomography involvement and time on mechanical ventilation

References

- The authors thank all patients and healthcare personnel involved in the study.
1. Chen Z, Fan H, Cai J, Li Y, Wu B, Hou Y, et al. High-resolution computed tomography manifestations of COVID-19 infections in patients of different ages. *Eur J Radiol.* 2020;126:108972.
2. Chung M, Bernheim A, Mei X, Zhang N, Huang M, Zeng X, et al. CT Imaging Features of 2019 Novel Coronavirus (2019-nCoV). *Radiology.* 2020;295(1):202–7.
3. Ye Z, Zhang Y, Wang Y, Huang Z, Song B. Chest CT manifestations of new coronavirus disease 2019 (COVID-19): a pictorial review. *Eur Radiol.* 2020;30(8):4381–9.

5. 4. Yuan M, Yin W, Tao Z, Tan W, Hu Y. Association of radiologic findings with mortality of patients infected with 2019 novel coronavirus in Wuhan, China. *PLoS One*. 2020;15(3):e0230548.
6. 5. Buttner L, Aigner A, Fleckenstein FN, Hamper CM, Jonczyk M, Hamm B, et al. Diagnostic Value of Initial Chest CT Findings for the Need of ICU Treatment/Intubation in Patients with COVID-19. *Diagnostics (Basel)*. 2020;10(11).
7. 6. Wang D, Hu B, Hu C, Zhu F, Liu X, Zhang J, et al. Clinical Characteristics of 138 Hospitalized Patients With 2019 Novel Coronavirus-Infected Pneumonia in Wuhan, China. *JAMA*. 2020;323(11):1061–9.
8. 7. Yang X, Yu Y, Xu J, Shu H, Xia J, Liu H, et al. Clinical course and outcomes of critically ill patients with SARS-CoV-2 pneumonia in Wuhan, China: a single-centered, retrospective, observational study. *Lancet Respir Med*. 2020;8(5):475–81.

Topic: Acute respiratory failure and mechanical ventilation

000402

Functional outcomes after severe traumatic brain injury treated with decompressive craniectomy as a management of intracranial hypertension

M. Fernández Caro¹, M. Gascón Castillo¹, M. García Marín², R. Amaya Villar¹

¹Medicina Intensiva, Virgen del Rocío University Hospital, Sevilla, Spain;

²Medicina intensiva, Hospital Universitario Virgen del Rocío, Sevilla, Spain

Correspondence: M. Fernández Caro

Intensive Care Medicine Experimental 2023, **11(Suppl 1)**:000402

Introduction: Traumatic brain trauma (TBI) is one of the main causes of mortality and disability in patients, mostly young, admitted to intensive care units (ICU) and require early diagnosis and proper management to prevent secondary brain injury and treatment of intracranial hypertension (ICHT). In this study we will analyze the functional outcome and mortality in patients admitted after a severe ITB undergoing different lines of ICHT treatment.

Methods: Data was collected from a total of 182 patients admitted to the neurotraumatologic ICU after a pure TBI, with no other associated severe trauma, from 2019 to 2022, inclusive. Demographic variables, TBI prognostic assessment scales (APACHE II), treatment steps, functional outcomes (GOSE scale), and ICU mortality at 6 months and 1 year were analyzed. It was treated as a retrospective analytical study. Data were analyzed with the SPSS computer program, collecting descriptive data, frequency tables, normality tests, and statistical significance values.

Results: The 75% of the sample were men, with the mean age of the sample being 49 years. The mean APACHE was 14 points at the admission. Regarding the main injury mechanisms, 55% are made up of falls at own height and traffic accidents (16%) (Figure 1).

50% of the sample had a severe TBI (GCS < 9 points). 52% of the patients had an evacuated mass TBI (TCDB 6) and 27% type 2 (injuries less than 25 cc). Neuromonitoring was indicated in 38% (severe TBI with lesions on CT or normal CT in those over 40 years of age, abnormal motor response or hypotension).

Patients received three tiers of measures against intracranial hypertension (intracranial pressure > 22 mmHg), 50% with general measures (elevated headrest, sedation, normothermia); 38% with first tier measures (external ventricular drainage, hyperventilation, osmolar therapy and neuromuscular blockers) and 11% with second tier measures (barbiturates, decompressive craniectomy and hypothermia). In 9% of the patients (24% of those under neuromonitoring), decompressive craniectomy was performed.

Survival in the ICU was 80%. The factors that were associated with higher mortality with statistically significance were: being a man (p < 0.012), age over 60 years (p < 0.001), APACHE II > 20 (p < 0.001), GCS < 8 (p < 0.009), presence of unreactive anisocoria (p < 0.001) and progress to first tier measures (p < 0.001).

The 48% of the sample had a favorable functional outcomes (GOSE < 5) 1 year after de TBI.

The first tier measures were associated with both higher mortality and worse functional outcome (p < 0.001), probably since these patients intrinsically have poor prognostic factors such as GCS, APACHE II and TCDB (Figures 2 and 3). No significant differences were found in relation to mortality nor functional outcome among patients who underwent decompressive craniectomy (Figure 4).

The limitations of our study were that we could not complete mortality at 6 months and one year in patients who had not yet reached this estimated time. Likewise, despite the fact that we collected more than 180 patients over 4 years, finally the sample size of patients with decompressive craniectomy was insufficient in our hospital probably due to performing a good ABCDE strategy in emergency management, early control of extracranial factors and a proactive neurosurgery service with use of early neuromonitoring, external ventricular drainage or surgical evacuation, which decreases the volume of patients requiring barbiturate coma or decompressive craniectomy.

Conclusions:

- There is no relation between performing decompressive craniectomy and the functional outcomes and mortality, probably due to the small sample size.
- Patients treated with first tier measures have a worse outcomes.
- A good initial ABCDE strategy, good control of extracranial factors and a proactive neurosurgery service reduce the need for decompressive craniectomy.

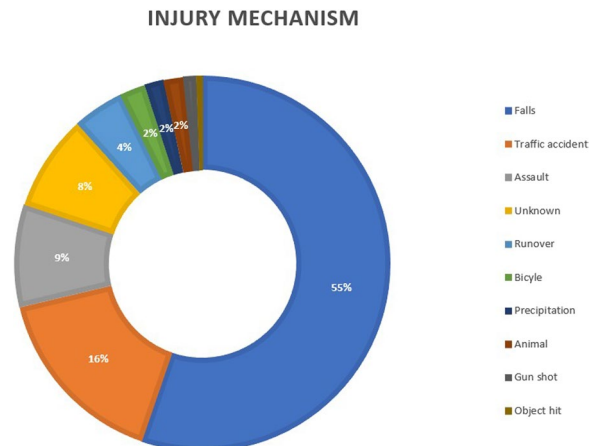

Figure 1 (abstract 000402) Circular diagram of injury mechanism

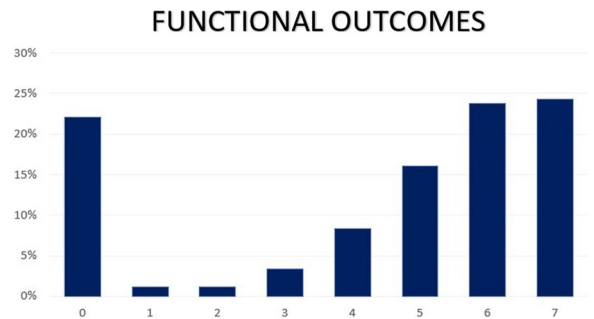

Figure 2 (abstract 000402) Bar graph of functional outcome according to the Glasgow Coma Outcome Scale Extended (GOSE) scale at 1 year

2022 Jul;39(13–14):944–953. <https://doi.org/10.1089/neu.2021.0378>. PMID: 34877889; PMCID: PMC9248344.

2. UCI HRT HUVR

Cross table

Treatment	General measures: raised headboard, sedation, euvoolemia, normothermia	Recount	RESULT		Total
			UNFAVOURABLE	FAVOURABLE	
		27 _a	64 _b		91
		% within RESULT	29,0%	73,6%	50,6%
	first level measures: DVE, hyperventilation, osmolar therapy, NMB	Recount	52 _a	18 _b	70
		% within RESULT	55,9%	20,7%	38,9%
	Second-level measures: barbiturates/thiopental, decompressive craniectomy, hypothermia	Recount	14 _a	5 _b	19
		% within RESULT	15,1%	5,7%	10,6%
Total		Recount	93	87	180
		% within RESULT	100,0%	100,0%	100,0%

Chi-square tests

	Value	Gl	Asymptotic significance (bilateral)
Pearson's Chi-square	35,661	2	<,001
Likelihood ratio	36,961	2	<,001
Linear association by linear	28,721	1	<,001
Number of valid cases	180		

Figure 3 (abstract 000402) Table of crossed data between the data of therapeutic step and functional outcomes with results of statistical significance

Cross table

Treatment	General measures: raised headboard, sedation, euvoolemia, normothermia	Recount	MORT IN ICU		Total
			alive	dead	
		83 _a	7 _b		90
		% within MORT IN ICU	57,2%	20,0%	50,0%
	first level measures: DVE, hyperventilation, osmolar therapy, NMB	Recount	47 _a	23 _b	70
		% within MORT IN ICU	32,4%	65,7%	38,9%
	Second-level measures: barbiturates/thiopental, decompressive craniectomy, hypothermia	Recount	15 _a	5 _b	20
		% within MORT IN ICU	10,3%	14,3%	11,1%
Total		Recount	145	35	180
		% within MORT IN ICU	100,0%	100,0%	100,0%

Chi-square tests

	Value	Gl	Asymptotic significance (bilateral)
Pearson's Chi-square	16,254	2	<,001
Likelihood ratio	17,006	2	<,001
Linear association by linear	10,340	1	,001
Number of valid cases	180		

Figure 4 (abstract 000402) Table of crossed data between the data of therapeutic step and mortality in the ICU with results of statistical significance

References

1. Rankothkumbura J, Gunathilaka H, Wadanamby S. Decompressive Craniectomy for Traumatic Brain Injury: Outcomes and their Determinants. *Ceylon Med J.* 2021 Mar 31;66(1):32–37. <https://doi.org/10.4038/cmj.v66i1.9353>. PMID: 34984894. 2. Sahuquillo J, Dennis JA. Decompressive craniectomy for the treatment of high intracranial pressure in closed traumatic brain injury. *Cochrane Database Syst Rev.* 2019 Dec 31;12(12):CD003983. <https://doi.org/10.1002/14651858.CD003983.pub3>. PMID: 31887790; PMCID: PMC6953357. 3. Abouhashem S, Eldawoody H. Functional Outcome After Primary Decompressive Craniectomy for Acute Subdural Hematoma in Severe Traumatic Brain Injury. *Turk Neurosurg.* 2022;32(2):211–220. <https://doi.org/10.5137/1019-5149.JTN.33970-21.2>. PMID: 34859822. 4. Bruns N, Kamp O, Lange K, Lefering R, Felderhoff-Müser U, Dudda M, Dohna-Schwake C. Functional Short-Term Outcomes and Mortality in Children with Severe Traumatic Brain Injury: Comparing Decompressive Craniectomy and Medical Management. *J Neurotrauma.*

Topic: Trauma

000403

Prevalence of coma in critical and coronary care units: a cross-sectional study in Chile

A. Giglio¹, A. Reccius¹, T. Regueira², C. Carvajal³, M. Pino⁴, C. Pedreros¹, A. Ferre¹

¹Programa de Medicina Intensiva, Universidad Finis Terrae - Postgrado, Providencia, Chile; ²Unidad de Paciente Crítico, Clínica Santa María, Providencia, Chile; ³Informática Médica - Plataforma REDCap, Universidad Finis Terrae, Providencia, Chile; ⁴Centro de Paciente Crítico, Clínica Las Condes, Las Condes, Chile

Correspondence: A. Giglio

Intensive Care Medicine Experimental 2023, **11(Suppl 1)**:000403

Introduction: Coma and associated disturbances in consciousness are significant challenges in neurocritical care. Understanding the prevalence of coma and its characteristics is essential for resource allocation and targeted interventions. This study aims to determine the prevalence of coma in critical and coronary care units in Chile and provide insights into demographics, etiology, complications, and support requirements of affected patients.

Chile, with a length of 4270 km (2653 miles) and an average width of 177 km (110 miles), has a mixed public and private healthcare system, presenting unique challenges when addressing treatment of coma and its associated complications.

Objectives: Our cross-sectional study aimed to investigate the prevalence of coma in critical care and coronary care units in Chile. Our primary objectives were to (1) determine the prevalence of coma within the Chilean population, (2) identify demographic data for these patients, and (3) determine the regional distribution of coma in Chile.

Methods: A cross-sectional study was conducted through a national survey of 105 out of 125 public and private hospitals with critical and coronary care units in Chile, representing 84% of such facilities. Data were collected via an online questionnaire, capturing bed occupancy, coma patient demographics, etiology, complications, and support requirements on March 22, 2023.

The definition of coma used in our study corresponds to the consensus definition established by the Neurocritical Care Society in the COME TOGETHER study.

Results: The total prevalence of coma in the surveyed units was 2.9%. The prevalence in intermediate care units was 0.7%, while it was 6.5% in intensive care units and 0.7% in coronary units. With an average response rate of 84%, no region reported data from less than 67% of its beds, and several regions even reported information from all of their facilities. The point prevalence of coma at the regional level ranged from 0 to 15.2% on the day of the survey, warranting further investigation.

Demographic data revealed a median age of 61 years, a male predominance of 66.2%, and a median coma duration of 5 days with interquartile ranges of 2 to 9 days.

Cerebral hemorrhage was the most frequent cause of coma (16%), followed by hypoxic cerebral disease (11%), cerebral infarction (10%), and traumatic brain injury (8%). At the time of the national survey, 48.1% of patients experienced coma-related complications, with 35.1% having coma-associated pneumonia. Support requirements were identified in 97.4% of patients, and the decision was made to adjust the therapeutic effort to 35% of the total number of patients.

Conclusions: This nationwide cross-sectional study provides valuable data on coma prevalence in Chilean critical care and coronary care units, highlighting the need for further research and targeted

interventions to improve patient outcomes in this unique healthcare context. The study's detailed information on coma etiologies offers insights into the causes of coma in Chile, which may inform targeted prevention and intervention strategies in the country's critical care and coronary care units.

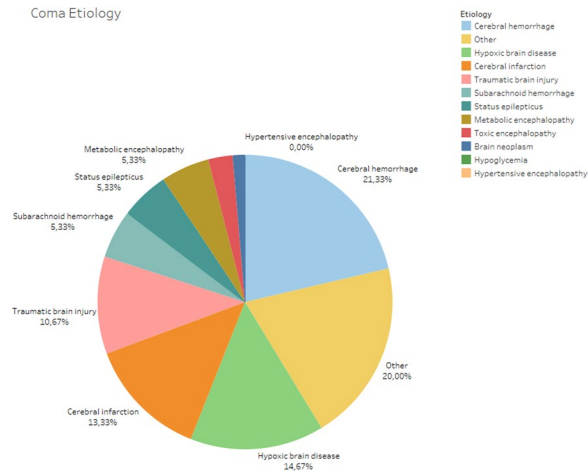

Coma etiologies.

References

- Masson, F., Thicoipe, M., Mokni, T., Aye, P., Erny, P., Dabadie, P., Petitjean, M. E., Léger, A., Melon, B., Saint-Martin, J., Galiacy, J. L., Martinot, F., Cornut, J. J., Ben Saad, F., Senjean, P., Touchard, P., Lapebie, A., Litalien, D., Gauche, B., ... Pettini, R. (2003). Epidemiology of traumatic comas: A prospective population-based study. *Brain Injury*, 17(4), 279–293. <https://doi.org/10.1080/0269905021000030805>
- Kondziella, D., Amiri, M., Othman, M. H., Beghi, E., Bodien, Y. G., Citerio, G., Giacino, J. T., Mayer, S. A., Lawson, T. N., Menon, D. K., Rass, V., Sharshar, T., Stevens, R. D., Tinti, L., Vespa, P., McNett, M., Venkatasubba Rao, C. P., Helbok, R., Akbari, Y., ... Ziai, W. (2022). Incidence and prevalence of coma in the UK and the USA. *Brain Communications*, 4(5). <https://doi.org/10.1093/braincomms/fcac188>
- Helbok, R., Rass, V., Beghi, E., Bodien, Y. G., Citerio, G., Giacino, J. T., Kondziella, D., Mayer, S. A., Menon, D., Sharshar, T., Stevens, R. D., Ulmer, H., Venkatasubba Rao, C. P., Vespa, P., McNett, M., & Frontera, J. (2022). The Curing Coma Campaign International Survey on Coma Epidemiology, Evaluation, and Therapy (COME TOGETHER). *Neurocritical Care*, 37(1), 47–59. <https://doi.org/10.1007/s12028-021-01425-8>
- We would like to express our gratitude to all the hospitals, both public and private, throughout Chile for their support in conducting this national prevalence study.

Topic: Neurointensive care

000405

Introducing a tracheostomy study day

L. Jenions¹, R. Riding², J. Mcevoy³, C. Whitehead⁴

¹Critical Care Outreach, Wrightington, Wigan & Leigh NHS Foundation Trust, Appley Bridge, United Kingdom; ²Critical Care, Wrightington, Wigan & Leigh NHS Foundation Trust, Appley Bridge, United Kingdom; ³Physiotherapy, Wrightington, Wigan & Leigh NHS Foundation Trust, Appley Bridge, United Kingdom; ⁴ENT, Wrightington, Wigan & Leigh NHS Foundation Trust, Appley Bridge, United Kingdom

Correspondence: L. Jenions

Intensive Care Medicine Experimental 2023, 11(Suppl 1):000405

Introduction: Approximately 15,000 tracheostomies are performed annually in the UK (McGrath et al., 2020). Historically, patients with a tracheostomy would be under the care of specialist teams such as ear, nose, and throat (ENT) or intensive care (ICU). But more recently, patients with a tracheostomy often have significant, complex medical conditions alongside their artificial airway, and are being cared for outside of critical care. Staff on general hospital wards may lack the knowledge and skills to care for this vulnerable population, resulting in significant patient harm (McGrath and Thomas, 2010). National guidance from groups such as the National Tracheostomy Safety Project, the Global Tracheostomy Collaborative and the Intensive Care Society all suggest the introduction of regular mandatory training for staff caring for patients with altered airways.

Methods: A multidisciplinary team consisting of staff from the critical care outreach team, physiotherapy and ENT devised a study day for staff on the wards who would be caring for patients with an altered airway. This included trained nurses and auxiliary staff based on the ward as well as physiotherapists, occupational therapists and speech and language therapists.

The study day consisted of a mixture of theoretical and practical sessions with the opportunity to practice key skills. Pre course questionnaires were submitted to participants asking them to assess confidence levels on a scale of 1–5 on 12 subjects related to the care of patients with an altered airway. The questionnaire was repeated after the study day to assess effectiveness of the teaching and participants' confidence.

Questions asked included: define the term tracheostomy, discuss the difference between a tracheostomy and a laryngectomy, discuss the indications for a tracheostomy, identify the essential bedside equipment, discuss the different types of tracheostomy tube used within the trust, explain the function of the inner tube, explain the function of the cuff, explain why a patient with a tracheostomy may not be able to speak, discuss the methods of achieving effective communication, discuss the signs and symptoms of respiratory distress in a patient with a tracheostomy, identify complications that may occur immediately after insertion, identify complications that may occur within 3 days of insertion.

Results: Scores were obtained for each participant before and after the teaching session. The table below shows the mean score for each question.

	Sept Pre	Sept Post	Oct Pre	Oct Post	Nov Pre	Nov Post	Dec Pre	Dec Post	Jan Pre	Jan Post	Feb Pre	Feb Post	Mar Pre	Mar Post
1	2.18	4.54	3.25	4.92	2.33	4.67	2.75	4.5	1.86	4.71	3.0	4.71	3.00	4.79
2	1.63	4.45	2.67	5.0	1.56	4.67	2.63	4.63	1.71	4.57	2.57	4.71	2.93	4.86
3	1.55	4.54	2.42	4.92	1.56	4.22	2.75	4.75	1.29	4.57	2.43	4.43	3.07	4.71
4	1.45	4.54	2.75	4.75	1.56	4.22	2.38	4.75	1.71	4.57	2.57	4.29	2.57	4.5
5	1.18	4.45	1.92	4.42	1.22	4.22	2.25	4.38	1.57	4.29	1.86	4.43	1.64	4.36
6	1.63	4.54	1.75	4.83	1.67	4.67	2.38	4.75	1.14	4.71	2.29	4.43	2.07	4.79
7	1.63	4.82	1.75	4.58	1.78	4.67	2.13	4.75	1.14	4.71	1.71	4.57	2.64	4.71
8	2.09	4.82	2.5	4.75	2.11	4.78	2.75	5.0	1.57	4.71	2.43	4.71	2.43	4.86
9	2.18	4.54	2.58	4.92	2.22	4.89	2.75	4.88	2.0	4.71	2.86	4.43	2.36	4.79
10	1.55	4.73	2.42	4.83	1.56	4.56	2.38	4.88	1.71	4.71	3.00	4.86	2.57	4.79

	Sept Pre	Sept Post	Oct Pre	Oct Post	Nov Pre	Nov Post	Dec Pre	Dec Post	Jan Pre	Jan Post	Feb Pre	Feb Post	Mar Pre	Mar Post
11	1.18	4.73	2.42	4.67	1.22	4.44	1.25	4.88	3.00	4.86	1.00	4.43	2.43	4.64
12	1.18	4.64	2.17	4.75	1.22	4.44	1.00	4.75	2.71	5.00	1.00	4.43	2.00	4.5

Conclusions: All scores showed an improvement following the study day indicating an improvement in the knowledge and skills of the staff attending. There were a couple of areas where confidence was still slightly lower despite the study day, and these were the bedside equipment and the different types of tracheostomy tubes used within the trust. Changes were made to the study day to improve focus on these areas during the practical sessions. Scores will continue to be monitored after each study day to check that these areas are improving.

References

1. The National Tracheostomy Safety Project, Faculty of Intensive Care Medicine and Intensive Care Society (2020) Guidance for Tracheostomy Care. [Online] Available from file:///C:/Users/jenions_1/Downloads/2020-08-TracheostomyguidanceFinal.pdf
2. McGrath, B.A., Wallace, S., Lynch, J., Bonvento, B., Coe, B. and Atkinson, D. (2020) Guidance For: Tracheostomy Care. [Online] Available From: https://www.ficm.ac.uk/sites/ficm/files/documents/2021-11/2020-08%20Tracheostomy_care_guidance_Final.pdf.
3. The National Tracheostomy Safety Project (2013) Comprehensive Tracheostomy care. [Online] Available from: <https://www.tracheostomy.org.uk/storage/files/Comprehensive%20Tracheostomy%20Care.pdf>. [Accessed 22nd March 2022].
4. McGrath, B.A. and Thomas, A.N. (2010) Patient safety incidents associated with tracheostomies occurring in hospital wards: a review of reports to the UK National Patient Safety Agency. Postgraduate medical journal, [Online] 86 (1019), pp. 522–91 Available from: https://members.globa.lt/rach.org/wp-content/uploads/2014/04/Trach_Safety_McGrath.pdf

Topic: Nursing care and physiotherapy

000406

Infection by multi-resistant gram negative in hematological patients: characterization in Latin America

D. Molano¹, V. Nieto², J. Mendoza², H. Rodríguez², T. Jimenez², D. Corzoz²
¹Medicina crítica y cuidado intensivo, Fundación University of Health Sciences, Bogotá, Colombia; ²Intensive care Medicine, Centro de tratamiento e investigación sobre Cáncer Luis Carlos Sarmiento Angulo, Bogotá, Colombia

Correspondence: D. Molano

Intensive Care Medicine Experimental 2023, 11(Suppl 1):000406

Introduction: Critically ill patients often harbor risk factors for colonization and infection with multidrug-resistant (MDR) bacteria and are frequently exposed to antibiotics, leading to sustained selection pressure. Immunocompromised patients are particularly at risk of developing healthcare-associated infections (HAIs). We describe in this study the prevalence of infections by MDR microorganisms in hematological patients and their association with prognosis.

Objectives: To describe the multi-resistance profile of gram-negative germs in patients with septic shock admitted to a reference oncology ICU in Latin America.

Methods: We carried out an observational prospective cohort study in ICU of Center Treatment and Investigation in Cancer en Bogota-Colombia. All consecutive patients with an ICU stay >24 h were included and followed for 28 days. Patients admitted exclusively with Immunosuppression for cancer or hematologic malignancy, neutropenia, solid-organ transplant, use of steroids or immunosuppressive drugs. The primary endpoint was the diagnosis of sepsis and the presence of infection in ICU for MDR microorganism.

Results: 210 patients were included, with 26 patients with shock septic for gram-negative MDR (12.3%). (58.9% males, median age

65 years) were included. The scores of severity its similar in groups of septic shock for MDR vs no- MDR.

The most frequently isolated germ was K pneumoniae with 46%, followed by E. coli with 30%. 46% of the isolates presented extended-spectrum beta-lactamase resistance, followed by 39% resistance to carbapenems, with 27% KPC and 12% NMD, and finally 15% with cAMP resistance. MDR isolation was more frequent in patients with hemato-oncology cancer (61%) vs solid organ cancer (39%), as well as secondary etiology to febrile neutropenia with bacteremia in 53%. Mortality in the ICU was higher in the gram-negative MDR group with 39% vs. non-MDR septic shock in 25%.

Conclusions: Cancer patients admitted to the ICU reported in this series in Latin America have a higher percentage of isolates due to MDR gram-negative germs than reported in other series. The highest percentage of these microorganisms are resistant to third generation cephalosporins with a significant increase in the isolates of germs resistant to carbapenemase. This finding points to the role of contact precautions and isolation measures, and could have important implications on antibiotic stewardship and treatment empirical antibiotics in this population.

PROFILE RESISTANCE MDR GRAM-NEGATIVE

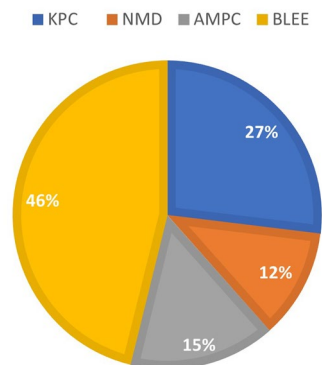

Figure 1 (abstract 000406) Profile resistance MDR Gram negative

Microorganism Gram Negative isolated

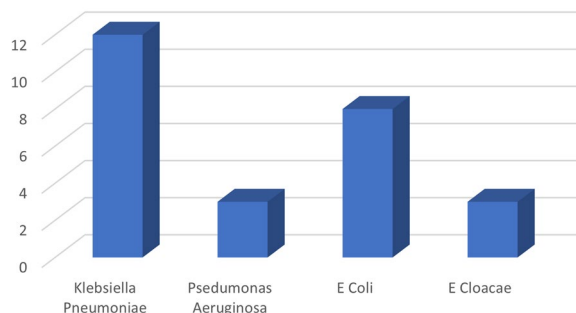

Figure 2 (abstract 000406) Microorganism isolated with profile of MDR

References

1. Kreitmann L, Vasseur M, Jermoumi S, et al. Relationship between immunosuppression and intensive care unit-acquired colonization and infection related to multidrug-resistant bacteria: a prospective multicenter cohort study. *Intensive Care Medicine*. 2023 Feb;49(2):154–165. <https://doi.org/10.1007/s00134-022-06954-0>.
2. Nseir S, Di Pompeo C, Diarra M, Brisson H, Tissier S, Boulo M, Durocher A. Relationship between immunosuppression and intensive care unit-acquired multidrug-resistant bacteria: a case-control study. *Crit Care Med*. 2007 May;35(5):1318–23. <https://doi.org/10.1097/01.CCM.0000261885.50604.20>.

Topic: Haematologic-oncologic issues in the ICU

000407

Effect of high flow nasal cannula on expiratory time constants in patients with acute hypoxemic respiratory failure

K. Matsumoto¹, A. Shono¹, S. Yawata¹, N. Katayama¹, T. Mihara¹, A. Waldmann², T. Nikai¹

¹Department of Anesthesiology, Shimane University Hospital, Izumo-shi, Japan; ²Anesthesiology and Intensive Care Medicine, University of Rostock, Rostock, Germany

Correspondence: K. Matsumoto

Intensive Care Medicine Experimental 2023, **11(Suppl 1)**:000407

Introduction: High flow nasal cannula (HFNC) can reduce respiratory rate (RR) and work of breathing and increase end-expiratory lung volume with increasing flow rates. It is unclear these benefits can be related to increasing in expiratory resistance generated by high airflow.

Objectives: The objective of this study was to examine expiratory time constants using electrical impedance tomography (EIT) with increasing flow rates of HFNC. In addition, the associations between the expiratory time constant and RR, and end-expiratory lung volume were also investigated.

Methods: A prospective randomized cross-over study was performed in patients with acute hypoxemic respiratory failure (AHRF) and PaO₂/FIO₂ ratio of less than 300 were included. A standard non-occlusive facial mask (FM) and HFNC at rates of 10 L/min (LF) and 50 L/min (HF) were randomly applied for 15 min. At the end of each phase, RR, Borg dyspnea scale, and arterial blood gases were measured. EIT data were recorded at each phase and more than 20 recorded breaths were analyzed offline. Expiratory time constant in each pixel was determined from the expiratory flow-impedance curve and its average in the whole lung area (Tau) was calculated. In addition, impedance value at end-expiration (EELI) and impedance change during inspiration (TIV), which are corresponding to end-expiratory lung volume and tidal volume, were also examined. Changes in EELI during HFNC were expressed as a percentage of TIV at FM (Δ EELI%). The comparisons of measurements between each study phase were analyzed by one-way analysis of variance with repeated measures. Correlations were tested with Pearson's product moment correlation coefficient.

Results: Fourteen patients with AHRF (mean age 67, BMI 24) were included in this study. Mean RR and Borg dyspnea scale decreased with increasing flow rates (RR: FM 21 ± 5 /min, LF 18 ± 4 /min, HF 16 ± 4 /min, $p = 0.007$, Borg scale: FM 4 ± 3 , LF 3 ± 3 , HF 2 ± 2 , $p = 0.324$). Mean Tau was gradually elongated with increasing flow rates (FM 0.61 ± 0.17 s, LF 0.63 ± 0.19 s, and HF 0.73 ± 0.17 s). However, the results reached no significant differences between each study phase ($p = 0.168$). Δ EELI% were $-4.8 \pm 59\%$ and $-4.6 \pm 45\%$ in LF and HF respectively, indicating that EELI did not increase during HFNC compared to that of FM. On the other hand, TIV reduced with increasing flow rates. A weak correlation between Tau and RR ($R = -0.32$, $p = 0.04$) was found.

Conclusions: Delivered airflow during HFNC could prolong the expiratory time constant, indicating increased expiratory resistance with increasing flow rates. Elevated airway resistance during expiration might reduce respiratory rate and tidal volume leading to improvement of patient discomfort, regardless of increase or decrease in end-expiratory lung volume.

References

1. Optimum support by high-flow nasal cannula in acute hypoxemic respiratory failure: effects of increasing flow rates *Intensive Care Med* (2017) 43:1453–1463
2. Regional expiratory time constants in severe respiratory failure estimated by electrical impedance tomography: a feasibility study *Crit Care*. 2018 Sep 21;22(1):221.

Topic: Acute respiratory failure and mechanical ventilation

000408

Longitudinal metabolic phenotypes in the critically ill: a metabolomics subtyping cohort study

H. Kobayashi¹, K. Amrein², J. Lasky-Su³, K. Christopher⁴

¹Department of Critical Care Medicine, Sunnybrook Health Sciences Centre, Toronto, Canada; ²Division of Endocrinology and Diabetology, Medical University of Graz, Graz, Austria; ³Channing Division of Network Medicine, Brigham and Women's Hospital, Boston, United States of America; ⁴Division of Renal Medicine, Brigham and Women's Hospital, Boston, United States of America

Correspondence: H. Kobayashi

Intensive Care Medicine Experimental 2023, **11(Suppl 1)**:000408

Introduction: Recent metabolomic studies demonstrated the different metabolomic profiles in patients with sepsis, trauma, and cardiac surgery. However, longitudinal metabolic phenotypes have not been described in the heterogeneous critically ill.

Objectives: To identify longitudinal metabolic phenotypes using unsupervised machine learning clustering method to the Vitamin D Deficiency in Critically Ill Patients (VITdAL-ICU) trial data and explore the relationships with outcome and meaningful biological pathways in phenotypes.

Methods: We determined the relative abundance of 659 metabolites in 1107 plasma samples from 369 patients on trial day 0, 3, and 7. We applied unsupervised longitudinal k-means clustering algorithm with joint trajectories to the metabolite abundance data. The optimal number of clusters was determined by Callinski and Harabatz criterion and biological plausibility. The primary outcome was 180-day mortality. To determine the association between longitudinal metabolic phenotypes and 180-day mortality we performed logistic regression adjusted for age, sex, Simplified Acute Physiology Score (SAPS) II, admission diagnosis, baseline 25(OH)D value, and absolute increase in 25(OH)D at day 3. Furthermore, we determined the associations between individual metabolites and phenotypes via logistic mixed-effects models with adjusting potential confounders.

Results: In the cohort, the median of age (IQR) was 66 (54, 75) years, 35% were female, 55% were surgical patients, the median SAPS II (IQR) was 30 (22, 42), and the median of baseline 25(OH)D (IQR) was 13.0 (9.5, 16.4) ng/mL. Eventually, 28-day, 90-day, and 180-day mortality were 18%, 28%, and 33%, respectively. We identified two distinctive longitudinal phenotypes: (A) amino acid-low-stable, lipid-low-stable, and xenobiotics-low-stable (65%); (B) amino acid-high-increase, lipid-high-increase, and xenobiotics-high-decrease (35%). Among the two phenotypes, major clinical characteristics were significantly different. Briefly, phenotype A was characterized by younger, high baseline 25(OH)D, low bilirubin, low creatinine, low procalcitonin, and low pro-B-type natriuretic peptide (BNP). Patients with phenotype B were characterized by a high proportion of cardiac surgery patients, low baseline 25(OH)D, high bilirubin, high creatinine, high procalcitonin, and high pro-BNP. Phenotype B was significantly associated with higher 180-day mortality compared to metabolite A (adjusted odds ratio, 6.14; 95% CI, 3.12–12.09; $p < 0.001$). In the logistic mixed-effects models, 153 metabolites had significant associations with phenotype B. The metabolites were dominated by increases in glutamate metabolism, histidine metabolism, branched-chain amino acid metabolism, tyrosine metabolism, tryptophan metabolism, acylcarnitine metabolism, dicarboxylate metabolism, and polyamine metabolism. These metabolites were lower abundance and had decreasing trend in phenotype A, though the same metabolites were higher and trend increasing in phenotype B.

Conclusions: In this post-hoc metabolomic cohort study of the VITdAL-ICU trial, we identified two distinct biological longitudinal metabolic phenotypes using clustering analysis of longitudinal plasma metabolome data. The two longitudinal phenotypes have significant differences in 180-day mortality and distinct individual metabolite abundance patterns. Our findings are the first step towards identifying specific longitudinal phenotypes with optimal long term responses to critical illness.

References

1. This work was supported by the National Institutes of Health [R01 GM115774].
2. Amrein K, Schmehl C, Holl A, et al. Effect of high-dose vitamin D3 on hospital length of stay in critically ill patients with vitamin D deficiency: the VITdAL-ICU randomized clinical trial. *JAMA*. 2014;312(15):1520–1530.

Topic: Metabolism, endocrinology, liver failure and nutrition

000410

Prognostic value of a biomarker in ARDS—a prospective study

U. Jithendran¹, T. P. Madhusudan¹

¹Critical Care Medicine, GG Hospital, Thiruvananthapuram, India

Correspondence: U. Jithendran

Intensive Care Medicine Experimental 2023, **11(Suppl 1)**:000410

Introduction: ARDS is common in patients admitted to ICU and is associated with multi-organ dysfunction and mortality. It is diagnosed based on a combination of clinical and physiological variables. The lack of a specific biomarker for ARDS is arguably one of the main obstacles to developing novel treatments for ARDS. It is anticipated that shortly, using biomarkers for defining ARDS, or for determining those patients who are more likely to benefit from a given therapy will have a major effect on clinical practice. B-type natriuretic peptide (BNP) was first described in the porcine brain, but BNP in humans originates primarily from the heart's ventricular myocardium. The biologically active BNP and the remaining part of the prohormone, N-Terminal-proBNP (76 amino acids) can be measured by immunoassay in human blood. Both BNP and NT-proBNP are secreted in response to ventricular muscle stretch. These are well validated as prognostic markers in heart failure. Recently, several studies have reported that BNP or NT-proBNP was elevated in patients with ARDS. We investigated whether the level of NT-proBNP is a precise predictor of the prognosis in patients with ARDS.

Objectives: The primary objective was to estimate the 28 days mortality rate and new organ dysfunction in patients presenting with ARDS in ICU and to determine plasma NT-proBNP levels in patients presenting with ARDS in ICU. The secondary objectives were to determine whether elevated plasma NT-proBNP level is associated with 28 days mortality and new organ dysfunction and to get a cut-off plasma NT-proBNP value to prognosticate mortality in patients presenting with ARDS.

Methods: A prospective observational study including all adult patients (18 years) with clinically confirmed ARDS (as per Berlin Definition) consecutively admitted in the ICU of a tertiary care hospital in Thiruvananthapuram between February 2022 and December 2022.

Results: Out of 80 ARDS patients included in the study, 38 died during the study period. The 28-day mortality rate was 47.5%. Non-survivors had higher APACHE II and SOFA scores than the survivors.

Non-survivors had a strong association with severe ARDS. They were also associated with comorbidities like Type 2 diabetes mellitus and CKD.

The median NT-proBNP of survivors was 995.50 with IQR 654–2729.25, and that of non-survivors was 4330.50 with IQR 3140.25–8240.75. The NT-proBNP levels were significantly higher among non-survivors ($p < 0.001$). The results of the ROC analysis demonstrated an area under the curve (AUC) of 0.868 with 95% confidence intervals of 0.790–0.947 (p -value < 0.001). The optimal NT-proBNP cut-off point for predicting mortality was 2491.50 pg/ml. It had 86.5% sensitivity and 76.7% specificity. New onset cardiovascular and renal dysfunctions were significantly associated with 28-day mortality ($p < 0.001$).

Conclusions: Our study was a prospective observational study of 80 ARDS patients admitted to ICU whose NT-proBNP levels were measured within 24 h. The 28-day mortality rate was 47.5%. New onset of cardiovascular and renal dysfunctions had significant association with elevated NT-proBNP. The optimal NT-proBNP cut off point for predicting 28-day mortality was 2491.50 pg/ml. It had 86.5% sensitivity and 76.7% specificity. A value of serum NT-proBNP above the optimal value was seen strongly associated with 28-day mortality.

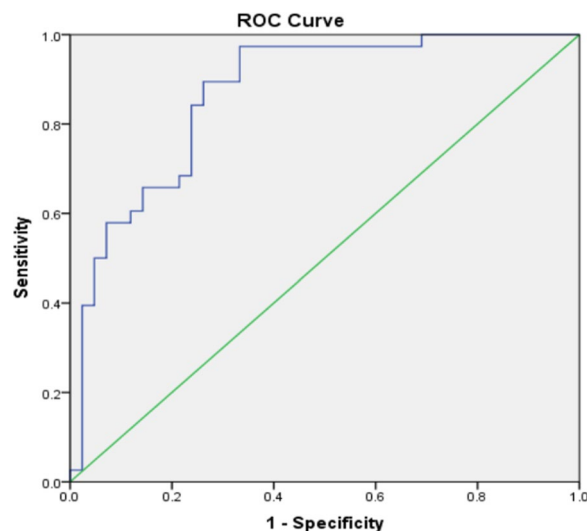

Figure 4 (abstract 000410) ROC curve showing the AUC for NT-proBNP

References

1. No grants has been received for conducting this study
2. Determann RM, Royakkers AA, Schaeffers J, de Boer AM, Binnekade JM, van Straalen JP, Schultz MJ. Serum levels of N-terminal proB-type natriuretic peptide in mechanically ventilated critically ill patients—relation to tidal volume size and development of acute respiratory distress syndrome. *BMC Pulmonary Medicine*. 2013 Dec;13(1):1–7.
3. Bajwa EK, Januzzi JL, Gong MN, Thompson BT, Christiani DC. Prognostic value of plasma N-terminal probrain natriuretic peptide levels in the acute respiratory distress syndrome. *Critical care medicine*. 2008 Aug;36(8):2322.
4. Jayasimhan D, Foster S, Chang CL, Hancox RJ. Cardiac biomarkers in acute respiratory distress syndrome: a systematic review and meta-analysis. *Journal of intensive care*. 2021 Dec;9(1):1–1
5. Ni Q, Li C, Lin H. Prognostic value of N-terminal probrain natriuretic peptide for patients with acute respiratory distress syndrome: a systematic review and meta-analysis. *BioMed research international*. 2020 Apr 5;2020.
6. Lai CC, Sung MI, Ho CH, Liu HH, Chen CM, Chiang SR, Chao CM, Liu WL, Hsing SC, Cheng KC. The prognostic value of N-terminal proB-type natriuretic peptide in patients with acute respiratory distress syndrome. *Scientific reports*. 2017 Mar 21;7(1):1–6.

Topic: Acute respiratory failure and mechanical ventilation

000411

Energy expenditure measured by indirect calorimetry versus predictive equation in a neuroscience intensive care unit

C. Liew¹, W. M. Koh², N. Shahrir², P. S. Ng³, K. W. Wong³, Y. H. Lau¹

¹Anaesthesiology, Intensive Care and Pain Medicine, Tan Tock Seng Hospital, Singapore, Singapore; ²Lee Kong Chian School of Medicine, Nanyang Technological University, Singapore, Singapore; ³Nutrition and Dietetics, Tan Tock Seng Hospital, Singapore, Singapore

Correspondence: C. Liew

Intensive Care Medicine Experimental 2023, 11(Suppl 1):000411

Introduction: Predictive equations in measuring energy expenditure (EE) in the critically ill patients have been associated with over or underfeeding [1]. Major guidelines recommend Indirect Calorimetry (IC) to determine EE [2]. With proprietary metabolic cart modules in the GE CareScape R860 invasive ventilators, an IC-guided nutritional protocol was implemented in Tan Tock Seng Hospital, Singapore.

Objectives: The objectives were to compare EE measured by IC versus the Harris-Benedict Equation (HBE) and the implementation of the IC-directed nutritional protocol in a retrospective observational cohort.

Methods: The study included all adult patients of age at least 21 years old admitted to the Neuroscience Intensive Care Unit (NICU) of Tan Tock Seng Hospital, Singapore, between 1 June 2020 and 30 June 2021 with an IC reading.

We excluded patients who were likely to be extubated within 24 h, imminent death within 24 h, known pneumothorax, presence of a chest tube, fraction of inspired oxygen requirements ≥ 30.6 and those on renal replacement therapy, which could entail peritoneal dialysis, haemodialysis or continuous renal replacement therapy.

The IC readings were obtained by the dietitians as part of their routine clinical work and the HBE was chosen as a comparison.

Results: A total of 108 patients admitted to the NICU had an IC measurement during the study period. Of these, their median age was 62 years and they were predominantly male (60.2%). The median BMI was 23.2 kg/m². The median APACHE II score was 18.0, SOFA score was 5.0 and NUTRIC score was 1.0. The most common admission diagnosis is that of an intracerebral haemorrhage (37%). The median NICU stay was 10 days with a mortality of 10.2%.

The median time from admission to an IC reading was 3 days. On the day of the IC assessment, 35.2% of the patients had fever and the recorded median GCS was 6 and median RASS was -4. The median daily calories based on HBE and IC reading was 1722.4 kcal and 1278 kcal respectively.

Analysis of the daily calories prescribed based on HBE versus IC reading demonstrated a significant difference of mean 465.3 kcal (95% CI 408.1–522.5, $p=0.000$). There is a positive correlation between HBE and IC with coefficient $r=0.565$ (p -value <0.001).

Conclusions: Using predictive equation to estimate EE will confer significant overfeeding in the patients. With an IC-directed nutritional protocol, intensive care units will be able to deliver appropriate calories to the critically ill patients.

References

1. 1. Zusman O, Kagan I, Bendavid I, Theilla M, Cohen J, Singer P. Predictive equations versus measured energy expenditure by indirect calorimetry: A retrospective validation. *Clin Nutr*. 2019;38(3):1206–1210. <https://doi.org/10.1016/j.clnu.2018.04.020>
2. 2. Singer P, Blaser AR, Berger MM, et al. ESPEN guideline on clinical nutrition in the intensive care unit. *Clin Nutr*. 2019;38(1):48–79. <https://doi.org/10.1016/j.clnu.2018.08.037>
3. This research did not receive any specific grant from funding agencies in the public, commercial, or not-for-profit sectors.

Topic: Metabolism, endocrinology, liver failure and nutrition

000412

Association between out-of-hospital resuscitation duration and outcomes in children with cardiac arrest caused by drowning

A. Komori¹, H. Iriyama¹, T. Abe¹¹Department of Emergency and Critical Care Medicine, Tsukuba Memorial Hospital, Tsukuba, Japan**Correspondence:** A. Komori

Intensive Care Medicine Experimental 2023, 11(Suppl 1):000412

Introduction: As little useful information is available to aid in the decision to discontinue resuscitation efforts, clinicians often perform prolonged cardiopulmonary resuscitation (CPR) in children who have drowned [1].

Objectives: We aimed to describe the association between CPR duration and outcomes in children with cardiac arrest caused by drowning using a national database in Japan.

Methods: This retrospective cohort study was conducted between 2013 and 2017 using the All-Japan Utstein Registry. We included patients (aged ≤ 18 years) with cardiac arrest caused by drowning. To investigate the association between CPR duration and outcomes, we calculated the dynamic proportion of 1-month outcomes as a function of CPR duration as follows: dynamic proportion of 1-month outcomes = $\frac{(\text{number of all patients who had the outcome}) - N_x}{\text{number of patients}}$. N_x was the number of patients who underwent CPR from 0 to x min and had the outcome. CPR duration was defined as the time from CPR initiation by emergency medical service (EMS) personnel to the time of return of spontaneous circulation (ROSC) or, when patients did not achieve ROSC at prehospital EMS-initiated CPR, it was defined as the time from CPR initiation by EMS personnel to the time of hospital arrival. Additionally, we calculated the sensitivity, specificity, and positive predictive value of CPR beyond 30 min, which was the time that predicts unfavorable neurological outcome [2]. The primary outcome was favorable neurological outcome (Cerebral Performance Category score of 1 or 2) at 1 month.

Results: Of 8629 children in the registry, 611 patients with cardiac arrest caused by drowning were identified. Of these, 53 (8.7%), 185 (30.3%), 146 (23.9%), and 227 (37.2%) patients were aged <1 , 1–5, 6–11, and 12–18 years, respectively, and 418 (68.4%) were boys. The median duration of out-of-hospital CPR was 20 (13–28) min, and 137 (22.4%) patients received CPR by EMS personnel beyond 30 min. One-month favorable neurologic outcomes and survival were detected in 30 (4.3%) and 101 (16.5%) patients, respectively. After 19 min of out-of-hospital CPR, the rate of favorable neurologic outcomes decreased to $<1\%$ of the total patients. After 30 min of out-of-hospital CPR, the rate decreased to 0.3%. After 34 min of out-of-hospital CPR, no patients with favorable neurological outcomes were noted. After 144 min of out-of-hospital CPR, 1-month survival decreased to 0%. For predicting unfavorable neurological outcomes, CPR beyond 30 min provided a sensitivity of 0.23 (95% CI: 0.23–0.24), specificity of 0.93 (95% CI: 0.89–0.98), and positive predictive value of 0.99 (95% CI: 0.96–1.00).

Conclusions: In pediatric patients with cardiac arrest caused by drowning, the duration of prehospital EMS-initiated CPR that decreased the likelihood of favorable neurological outcome was 34 min. At 30 min, these patients may still have a chance to survive with a favorable outcome.

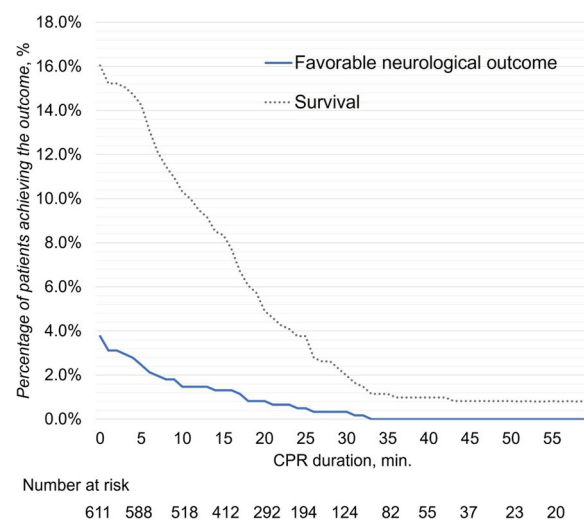

Figure (abstract 000412) Dynamic proportion of 1-month favorable neurological outcomes and survival

References

1. Lott C, Truhlář A, et al. Resuscitation. 2021;161:152–219.
2. None.
3. Kieboom JK, et al. BMJ. 2015;350:h418.

Topic: Cardiac arrest

000413

The performance of SOFA score as a predictor of 30-day mortality over time and in different patient groups, a retrospective cohort study

J. Helleberg¹, A. Sundelin², J. Martensson³, O. Rooyackers⁴

¹Perioperative Medicine and Intensive Care, Karolinska University Hospital, Stockholm, Sweden; ²Perioperative Medicine and Intensive Care, Nya Karolinska, Stockholm, Sweden; ³Department of Clinical Science and Education, Södersjukhuset, Karolinska Institute, Stockholm, Sweden; ⁴Department of Clinical Science, Intervention And Technology, Karolinska Institute, Stockholm, Sweden

Correspondence: J. Helleberg

Intensive Care Medicine Experimental 2023, **11(Suppl 1)**:000413

Introduction: SOFA score is commonly used to quantify severity of illness in the ICU and as outcome parameter in clinical trials. Furthermore, it has been suggested to be used to guide clinical decision making. However, the standard of care has changed since SOFA was developed, both in the ICU in general but also in specific patient groups such as Sepsis, Trauma and Acute Respiratory Distress syndrome. It is also known that the predictive performance of other scoring systems such as APACHE II decrease over time in the ICU. Thus, whether SOFA score accurately reflects illness severity equally in these patient groups, and if SOFA score is equally valid as measurement throughout the stay in the ICU remains uncertain.

Methods: A computer algorithm for calculating SOFA score accurately and objectively according to recent guidelines directly from data extracted from a Patient Data Management System (PDMS) was developed and validated. In a separate cohort, consisting of 5076 adult patients admitted to any ICU at the Karolinska University Hospital between 2015 and 2018, SOFA score was calculated using the algorithm for each day from admission to day 7 was used as predictor in a univariable logistic regression analysis with 30-day mortality as outcome parameter, and ROC-curves were constructed. DeLong's test was used for pairwise comparison of the area under ROC-curves. R version 4.2 was used for all analyses.

Results: In the 5076 patients, SOFA score could be calculated on a total of 30,883 out of 31,889 ICU days. Overall, 953 patients (18.7%) died within 30 days.

Patient characteristics at admission

Age (years)	62 (47–72)
Female/male (N/%)	2000 (39.4%)/3076 (60.6%)
SAPS3 points (mean/SD)	57.87 (± 17.38)
Surgery prior to admission (N/%)	1752 (34.5%)
Invasive mechanical ventilation (N/%)	2810 (55.4%)
Vasoactive therapy (N/%)	1320 (26.0%)
Death at 30 days (N/%)	953 (18.7%)

The AUC was highest on ICU day 2 at 0.786 (95% confidence interval 0.769–0.803) (Figure 1). In pairwise testing of day 2 vs all other days, the difference in AUC was significant in every test except vs day 1 ($p=0.12$).

In a subgroup analysis of some common causes for admission in this patient population [Intracranial mass effect ($n=876$), Trauma ($n=807$), Acute Respiratory Failure ($n=376$) and Septic Shock ($n=360$)], the AUC of SOFA on the second ICU day ranged from 0.692

(0.633–0.751) in acute respiratory failure, 0.751 (0.712–0.790) in Intracranial volume effect, 0.751 (0.712–0.790) in Intracranial volume effect, 0.762 (0.707–0.818) in septic shock, to 0.817 (0.775–0.859) in Trauma (Figure 2).

Conclusions: SOFA score can be used for risk stratification in the ICU, with the best performance on ICU day 2. The predictive performance differs significantly across patient groups and decreases as time progresses in the ICU. This suggests that other factors than the level of multiorgan failure as described by SOFA score could be useful to stratify the severity of illness later in the ICU stay and in specific patient groups.

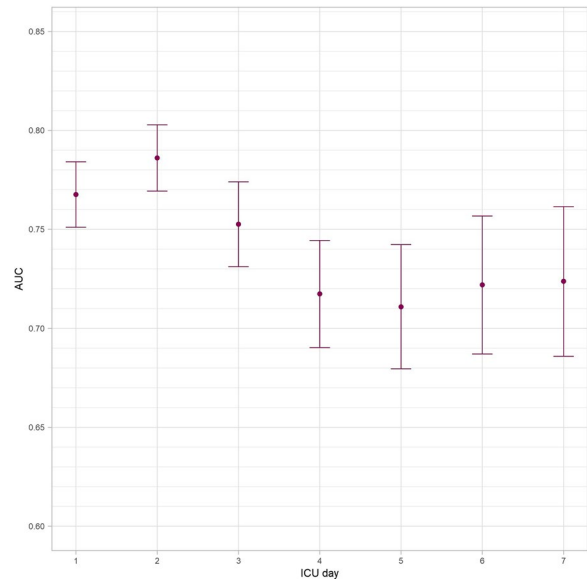

Figure 1 (abstract 000413) AUC (with 95% CI) of SOFA score as predictor for 30-day mortality, per ICU day

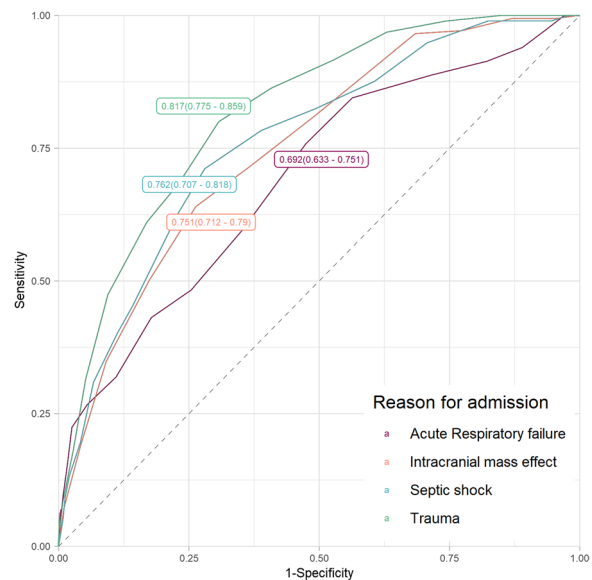

Figure 2 (abstract 000413) ROC curves of SOFA score on day 2 versus 30-day mortality, by subgroup

References

1. DeLong ER, DeLong DM, Clarke-Pearson DL. Comparing the areas under two or more correlated receiver operating characteristic curves: a non-parametric approach. *Biometrics*. Sep 1988;44(3):837–45.
2. Lambden S, Laterre PF, Levy MM, Francois B. The SOFA score—development, utility and challenges of accurate assessment in clinical trials. *Crit Care*. Nov 27 2019;23(11):374. <https://doi.org/10.1186/s13054-019-2663-7>
3. Vincent JL, Moreno R, Takala J, Willatts S, De Mendonça A, Bruining H, Reinhart CK, Suter PM, Thijs LG. The SOFA (Sepsis-related Organ Failure Assessment) score to describe organ dysfunction/failure. On behalf of the Working Group on Sepsis-Related Problems of the European Society of Intensive Care Medicine. *Intensive Care Med*. 1996 Jul;22(7):707–10. <https://doi.org/10.1007/BF01709751>. PMID: 8844239.
4. R Core Team (2022). R: A language and environment for statistical computing. R Foundation for Statistical Computing, Vienna, Austria. URL <https://www.R-project.org/>.
5. Meiring C, Dixit A, Harris S, MacCallum NS, Brealey DA, Watkinson PJ, Jones A, Ashworth S, Beale R, Brett SJ, Singer M, Ercole A. Optimal intensive care outcome prediction over time using machine learning. *PLoS One*. 2018 Nov 14;13(11):e0206862. <https://doi.org/10.1371/journal.pone.0206862>. PMID: 30427913; PMCID: PMC6241126.

Topic: Critical care organisation, quality management, information systems, outcomes

000414

ICU outcomes in CAR-T patients: a four-year tertiary centre experience

L. Scourfield¹, T. Pirani¹, N. Singh¹, R. Saha¹, A. Kuhn¹, R. Sanderson², V. Metaxa¹

¹Critical Care, King’s College Hospital NHS Foundation Trust, London, United Kingdom; ²Haematology, King’s College Hospital NHS Foundation Trust, London, United Kingdom

Correspondence: L. Scourfield

Intensive Care Medicine Experimental 2023, **11(Suppl 1)**:000414

Introduction: Chimeric antigen receptor-modified T (CAR-T) cells are a targeted treatment for patients with advanced haematological malignancy. A proportion of these patients will develop significant CAR-T-related toxicity, namely cytokine release syndrome (CRS) and Immune Effector Cell Associated Neurotoxicity Syndrome (ICANS), with some requiring intensive care unit (ICU) admission [1]. There are limited data and consensus on the management of critically ill patients with CAR T-cell therapy toxicities in ICU, especially in the UK [2, 3].

Objectives: To describe our experience with managing patients admitted to ICU after CAR-T CD19 administration.

Methods: A retrospective analysis between January 2019 and December 2022 of patients who received CAR-T cell therapy in our tertiary hospital, one of the largest immune cell centres in the UK. Patients with diffuse large B cell lymphoma, transformed follicular lymphoma, primary mediastinal B-cell lymphoma, acute lymphoblastic leukaemia or mantle cell lymphoma, who required ICU admission after treatment were included. Patient demographics, disease characteristics and ICU management information were collected.

Results: CAR-T therapy was administered to 137 patients during the study period, with 35 (25.6%) requiring ICU admission. Patient information and the reason for ICU admission are shown in Table 1 and *Fig.* 1. Grade 2 CRS was documented in 19/35 patients (54.3%) for a median duration of 1.5 (range 0–6) days. Grade 3 CRS was seen in 9/35 patients (29%). Grade 4 CRS was documented in 1 patient. Neurological toxicity was documented in 20/35 patients (57.1%), with the majority (65%) having grade 2 ICANS.

During their ICU stay, 14/35 patients (40%) required vasopressors for a mean duration of 2.9 (1–12) days. 7 patients (20%) needed mechanical ventilation with a mean duration of 5 (4–9) days and 2 patients needed renal replacement therapy. Siltuximab was administered to 4/35

(11.4%) and anakinra to 13 (37.1%) ICU patients. Four patients (11.4%) died in ICU, all in multi-organ failure. A further 8 patients who were discharged from ICU, died before hospital discharge, all from disease progression (34.3% hospital mortality for this ICU cohort).

Conclusions: A significant number of patients receiving CAR-T therapy needed ICU admission, requiring various levels of organ support, mainly for neurotoxicity. Observed ICU mortality (11.4%) was in accordance with that reported in international literature (2, 3) and no deaths were attributed to treatment toxicity. The expanding use of CAR-T therapy in other malignancies may increase the need for ICU admissions and close collaboration between haematology and ICU is warranted for the optimal management of these patients.

Table 1 (abstract 000414) Patient information

Parameter	
Age median (range)	56 (21-69)
Gender (% female)	31.4
Median Length of stay (range) (days)	4 (1-49)
Haematological Malignancy (%)	
DLBCL	64.6
tFL	14.3
PMBCL	14.3
ALL	2.9

DLBCL: diffuse large B cell lymphoma, tFL: transformed follicular lymphoma, PMBCL: primary mediastinal B-cell lymphoma, ALL: acute lymphoblastic leukaemia

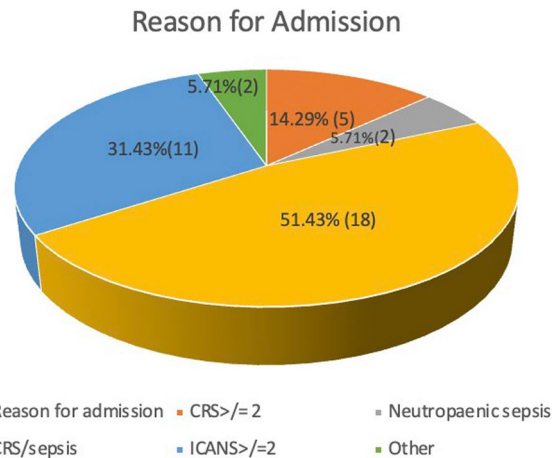

Figure 1 (abstract 000414) CAR-T cell therapy patients by reason for ICU admission

References

- 1) Lee DW, et al. ASTCT Consensus Grading for Cytokine Release Syndrome and Neurologic Toxicity Associated with Immune Effector Cells. *Biol Blood Marrow Transplant*. 2019 Apr;25(4):625–638
- 2) Gutierrez C, et al. The chimeric antigen receptor-intensive care unit (CAR-ICU) initiative: Surveying intensive care unit practices in the management of CAR-T-cell associated toxicities. *Journal of critical care* 2020; 58:58–64.
- 3) Azoulay É, et al.; Nine-I investigators. Outcomes in patients treated with chimeric antigen receptor T-cell therapy who were admitted to intensive care (CARTTAS): an international, multicentre, observational cohort study. *Lancet Haematol*. 2021 May;8(5):e355–e364.

Topic: Haematologic-oncologic issues in the ICU

000417

Impact of COVID vaccines on COVID mortality rate in ICU

I. Princess¹, E. Rabindrarajan²

¹Microbiology, Apollo Hospitals, Chennai, India; ²Critical Care Medicine, Apollo Hospitals, Chennai, India

Correspondence: E. Rabindrarajan

Intensive Care Medicine Experimental 2023, **11(Suppl 1)**:000417

Introduction: COVID vaccines were phased out for use among general population as early as March 2021. Vaccine hesitancy however remains the hurdle which India as a nation struggles to overcome. Although data from the World Health Organization supports COVID vaccines for preventing severe COVID, data from India is limited and almost negligible.

Methods: This retrospective cross sectional study was conducted at a tertiary care COVID center in Chennai, Tamilnadu—South India from March 2020 to March 2022. Data of all COVID inpatients confirmed by Reverse Transcriptase Polymerase Chain Reaction (RT PCR) were analyzed for clinical outcomes. All severe COVID 19 patients were admitted to the Intensive Care Unit based on the ICU admission criteria and managed appropriately using national as well as institutional guidelines. Patients' demographic details, category of COVID 19, vaccination details, comorbidities were generated real time upon patient admission and tabulated on an Excel sheet. Patients who succumbed to the disease were further categorized based on vaccination status and dose of vaccine administered. Mortality rate analysis was done for patients after segregating as pre-vaccination and post-vaccination period.

A comparative analysis among deceased patients with available data was done between vaccinated and unvaccinated individuals. Among vaccinated deceased individuals, details about type of vaccine, doses of vaccine received, mean age among vaccinated and unvaccinated individuals were analyzed. Among vaccinated deceased individuals, further analysis was performed to determine time to positivity after receiving vaccination. The cause of death among these patients along with comorbidities and contributing factors to their mortality were determined.

Results: A total of 4512 RT-PCR confirmed COVID 19 positive cases were admitted to our hospital since the beginning of the COVID pandemic; of which 4167 recovered and 345 COVID 19 positive deaths were reported. Therefore the overall mortality rate was 7.6% in our study. Mean age of all individuals who succumbed to the infection was 63.3 years. Out of 2387 patients in post vaccine era, 197 patients (8.2%) who had severe COVID 19 pneumonia and respiratory distress succumbed to the infection. Among these 197 patients, 146 (74.1%) were not vaccinated, 51 (25.8%) were vaccinated [Figure 1]. Mean age of vaccinated individuals who succumbed to the virus was 70.2 years. Upon analysing vaccine eligibility of deceased individuals, all 197 patients were eligible for vaccination. Date of vaccination and time to positivity were analysed. During second wave, the median time to positivity after receiving vaccine was 28 (9–90) days. Whereas, during third wave, the median time to positivity was 171.6 (8–328) days. Major comorbidities among vaccinated individuals were systemic hypertension (94.2%), type II diabetes mellitus (82.7%), heart disease (40.4%), chronic kidney disease (23%), and lung diseases (28.8%) [Figure 2]. Many patients succumbed to the disease complicated by sepsis and septic shock. Few patients suffered from conditions such as acute kidney injury, pyelonephritis, chronic liver disease, Parkinsonism and rheumatoid arthritis.

Conclusions: This study showed that in spite of vaccine availability and eligibility, many COVID deaths in India could not be prevented during the second wave. This catastrophic effect was contributed by the huge pool of unvaccinated population. Although available, hesitancy and reluctance are major stumbling blocks for vaccine coverage among Indian population. Therefore, data from such studies can be used as awareness tools to delineate major differences in outcome of vaccinated and unvaccinated COVID infected patients. The next hurdle for our nation is compliance to precaution/booster doses by fully vaccinated individuals to tackle newer evolving variants and sub variants. Good vaccine coverage will help in reducing ICU admissions and burn-outs among healthcare workers caring for COVID patients in ICUs.

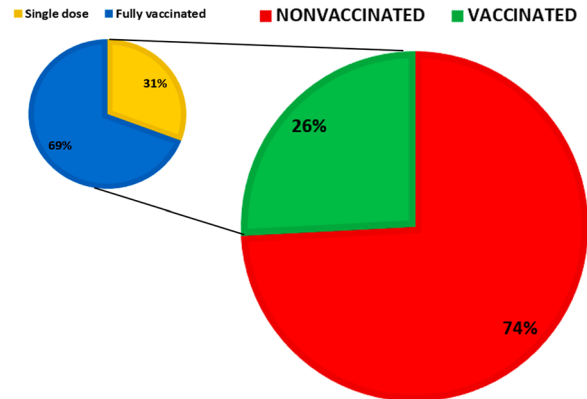

Figure 1 (abstract 000417) Distribution of vaccine status of deceased COVID patients (n = 197)

Comorbidities	Percentage of vaccinated patients
Systemic hypertension	94.2%
Type II Diabetes mellitus	82.7%
Heart disease	40.4%
Chronic Kidney Disease	23.0%
Airway diseases (Bronchial Asthma/COPD)	17.3%
Interstitial lung disease	11.5%

Figure 2 (abstract 000417) Contributing factors to mortality among vaccinated individuals (n = 52)

References

1. Transmission of SARS-CoV-2: implications for infection prevention precautions. Accessed from: <https://www.who.int/news-room/commentaries/detail/transmission-of-sars-cov-2-implications-for-infection-prevention-precautions.2020>. Accessed on: 14/07/2022.
2. Ying L, Rocklöv J. The reproductive number of the delta variant of SARS-CoV-2 is far higher compared to the ancestral SARS-CoV-2 virus. *J Travel Med.*; 2020;28(7).
3. Ying L, Rocklöv J. The effective reproductive number of the Omicron variant of SARS-CoV-2 is several times relative to Delta. *J Travel Med.*; 2022;29(3).
4. Tracking SARS-CoV-2 variants. World Health Organization. Accessed from: <https://www.who.int/activities/tracking-SARS-CoV-2-variants>. Accessed on: 22/07/2022.
5. Guidelines for COVID-19 vaccination for children between 12-14 years of age. Accessed from: https://static.mygov.in/rest/s3fs-public/mygov_164792921497519711.pdf. Accessed on: 22/07/2022.
6. Martinez IL, Llinás DT, Romero MB, Salaza LM. High Mutation Rate in SARS-CoV-2: Will It Hit Us the Same Way Forever? *J Infect Dis Epidemiol* 2020, 6:176.
7. Victor PJ, Mathews KP, Paul H, Mammen JJ, Murugesan M. Protective Effect of COVID-19 Vaccine Among Health Care Workers During the Second Wave of the Pandemic in India. *Mayo Clin Proc.* 2021;96:2493-4.
8. Jaiswal A, Subbaraj V, Thangaraj JWV, Murhekar MV, Muliyl J. COVID-19 vaccine effectiveness in preventing deaths among high-risk groups in Tamil Nadu, India. *Indian J Med Res* 2021;1671:21.
9. Tyagi K, Ghosh A, Nair D, Dutta K, Singh Bhandari P, Ahmed Ansari I, Misra A. Breakthrough COVID-19 infections after vaccinations in healthcare and other workers in a chronic care medical facility in New Delhi, India. *Diabetes & Metabolic Syndrome: Clinical Research & Reviews.* 2021;15:1007-8.
10. Coronavirus (COVID-19) Vaccinations – Our World in Data. Accessed from: <https://ourworldindata.org/covid-vaccinations?country=IND>. Accessed on: 25/07/2022.
11. COVID-19 vaccines. Accessed from: <https://www.who.int/emergencies/diseases/novel-coronavirus-2019/covid-19-vaccines>. Accessed on: 25/07/2022.
12. Koya SF, Ebrahim SH, Bhat LD, Vijayan B, Khan S, Jose SD, Pilakkadavath Z, Rajeev P, Azariah JL. COVID-19 and Comorbidities: Audit

of 2,000 COVID-19 Deaths in India. *J Epidemiol Glob Health.* 2021;11:230-2. 13. Djaharuddin I, Munawwarah S, Nurulita A, Ilyas M, Tabri NA, Lihawa N. Comorbidities and mortality in COVID-19 patients. *Gac Sanit.* 2021;35 Suppl 2:S530-S532. <https://doi.org/10.1016/j.gaceta.2021.10.085>. PMID: 34929892; PMCID: PMC8677356. 14. Tendulkar P, Pandey P, Panda PK, Bhadoria AS, Kulshreshtha P. Descriptive epidemiology of COVID-19 deaths during the first wave of pandemic in India: a single-center experience. *Indian J Crit Care Med* 2022;26(1):71–75. <https://doi.org/10.5005/jp-journals-10071-24085>. 15. Common Side Effects (AEFI): Some common ailments that can be expected after vaccination. Accessed from: https://www.mohfw.gov.in/covid_vaccination/vaccination/common-side-effects-aeafi. Accessed on: 02/12/2022. 16. Coronavirus Disease (COVID-19): Vaccines. Accessed from: [https://www.who.int/emergencies/diseases/novel-coronavirus-2019/question-and-answers-hub/q-a-detail/coronavirus-disease-\(covid-19\)-vaccines?](https://www.who.int/emergencies/diseases/novel-coronavirus-2019/question-and-answers-hub/q-a-detail/coronavirus-disease-(covid-19)-vaccines?). Accessed on: 02/12/2022. 17. Ganapathiram RN, Hudson S. Multisystem Inflammatory Syndrome in Adult Following COVID-19 Vaccination (MIS-AV). *Indian J Crit Care Med* 2022;26(5):647–8. 18. Tiwari AM, Zirpe KG, Gurav SK, Bhirud LB, Suryawan-shi RS, Kulkarni SS. Case of Suspected SARS-CoV-2 Vaccine-induced Immune Thrombotic Thrombocytopenia: Dilemma for Organ Donation. *Indian J Crit Care Med* 2022;26(4):516–9.

Topic: Infections and prevention

000418

Reduced anticoagulation strategy is associated with a lower incidence of intracerebral hemorrhage in COVID-19 patients on extracorporeal membrane oxygenation

D. A. Hofmaenner¹, D. Furfaro², L. C. Wild³, P. D. Wendel Garcia¹, E. Baedorf-Kassis⁴, A. Pannu⁵, T. Welte⁶, R. Erlebach¹, K. Stahl⁷, E. W. Grandin⁸, C. Putensen⁹, R. Schuepbach¹⁰, S. Shaeff⁵, S. David¹¹, B. Seeliger⁶, C. Bode⁹
¹Institute of Intensive Care Medicine, University Hospital of Zurich, Zurich, Switzerland; ²Division of Pulmonary, Critical Care, and Sleep Medicine, Harvard Medical School, Boston, United States of America; ³Department of Anaesthesiology and Intensive Care Medicine, University Hospital Bonn, Bonn, Germany; ⁴Department of Pulmonary, Critical Care & Sleep Medicine, Beth Israel Deaconess Medical Center (BIDMC), Boston, United States of America; ⁵Department of Anesthesia, Critical Care and Pain Medicine, Harvard Medical School, Boston, United States of America; ⁶Department of Respiratory Medicine, Hannover Medical School, Hannover, Germany; ⁷Department of Gastroenterology, Hepatology and Endocrinology, Hannover Medical School, Hannover, Germany; ⁸Division of Cardiovascular Medicine, Harvard Medical School, Boston, United States of America; ⁹Department of Anaesthesiology and Critical Care Medicine, University of Bonn, Bonn, Germany; ¹⁰Institute of Intensive Care Medicine, University Hospital of Zurich, Zurich, Switzerland; ¹¹Institute of Intensive Care Medicine, University Hospital Zurich, Zurich, Switzerland

Correspondence: D. A. Hofmaenner
Intensive Care Medicine Experimental 2023, **11(Suppl 1):**000418

Introduction: Optimal anticoagulation strategies for COVID-19 patients with the acute respiratory distress syndrome (ARDS) on venovenous extracorporeal membrane oxygenation (VV ECMO) remain uncertain. A higher incidence of intracerebral hemorrhage (ICH) during VV ECMO support compared to non-COVID-19 viral ARDS patients has been reported, with increased bleeding rates in COVID-19 attributed to both intensified anticoagulation and a disease-specific endotheliopathy (1). We hypothesized that lowering the intensity of anticoagulation during VV ECMO would reduce the risk of ICH.

Methods: In a retrospective, multicenter study from three academic tertiary intensive care units, we included patients with confirmed COVID-19 ARDS requiring VV ECMO support from March 2020 to January 2022. Patients were grouped by anticoagulation exposure into higher intensity, targeting anti-factor Xa activity (anti-Xa) of 0.3–0.4 U/mL, versus lower intensity, targeting anti-Xa 0.15–0.3 U/mL, cohorts. Mean daily doses of unfractionated heparin (UFH) per kg bodyweight and effectively measured daily anti-factor Xa activities were compared between the groups over the first seven days on ECMO support. The primary outcome was the rate of ICH during VV ECMO support.

Results: 141 critically ill COVID-19 patients were included in the study. Patients with lower anticoagulation targets had consistently lower anti-Xa activity values over the first 7 ECMO days ($p < 0.001$). ICH incidence was lower in patients in the lower anti-Xa group: 4 (8%) vs 32 (34%) events. Accounting for death as a competing event, the adjusted subhazard ratio for the occurrence of ICH was 0.28 (97.5% CI 0.1–0.8, $p = 0.023$) for the lower anti-Xa compared to the higher anti-Xa group (Figure 1). 90-day ICU survival was higher in patients in the lower anti-Xa group, and ICH was the strongest risk factor associated with mortality (odds ratio [OR] 6.62 [CI 2–21.4], $p = 0.002$) (Figure 2).

Conclusions: For COVID-19 patients on VV ECMO support anticoagulated with heparin, a lower anticoagulation target was associated with a significant reduction in ICH incidence and increased survival.

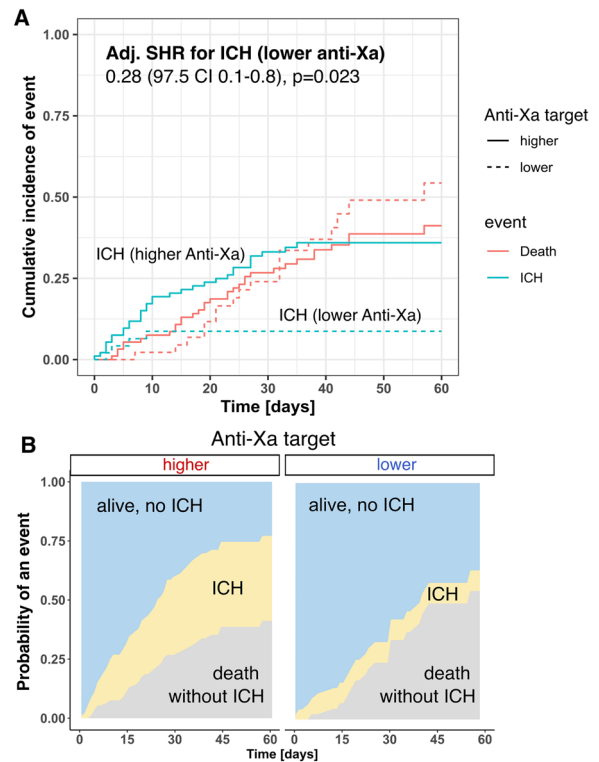

Figure 1 (abstract 000418) Competing risk regression model demonstrating incidences of intracranial hemorrhages (ICH) according to anticoagulation target group (A). Cumulative incidence of ICH and death as multistate comparison is shown in (B)

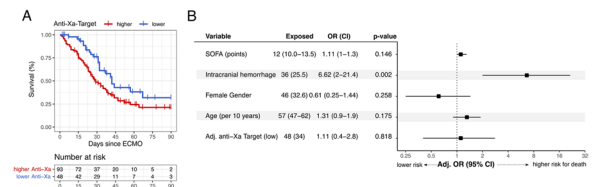

Figure 2 (abstract 000418) Generalized linear mixed effects model. Kaplan–Meier survival curves stratified by high and low anti-Xa targets demonstrating survival differences between the two anticoagulation groups (log-rank test, $p = 0.022$) (A). Occurrence of ICH was the main factor associated with mortality (adjusted odds ratio 6.62 [CI 2–21.4], $p = 0.002$) (B)

References

1. Seeliger B, Doeblner M, Hofmaenner DA, Wendel-Garcia PD, Schuepbach RA, Schmidt JJ, Welte T, Hoepfer MM, Gillmann HJ, Kuehn C, Ehrentraut SF, Schewe JC, Putensen C, Stahl K, Bode C, David S. Intracranial Hemorrhages on Extracorporeal Membrane Oxygenation: Differences Between COVID-19 and Other Viral Acute Respiratory Distress Syndrome. Crit Care Med. 2022 Jun 1;50(6):e526-e538. <https://doi.org/10.1097/CCM.0000000000005441>.
2. no funding

Topic: Acute respiratory failure and mechanical ventilation

000422

Effects of video support tool on family members' preference and understanding in life-sustaining treatments: a randomized controlled trial in intensive care unit

T.Y. Park¹, H.J. Lee²

¹Division of Respiratory and Critical Care, Department of Internal Medicine, Seoul Metropolitan Government-Seoul National University Boramae Medical Center, Seoul, Republic of Korea; ²Internal Medicine, Seoul National University Hospital, Seoul, Republic of Korea

Correspondence: T. Y. Park

Intensive Care Medicine Experimental 2023, 11(Suppl 1):000422

Introduction: Families' preference and knowledge about end of life care may act as important factors in intensive care unit (ICU).

Objectives: We performed a randomized trial to find out the effects of video education materials on preference and knowledge of on life sustaining treatment among families of ICU patients in Korea.

Methods: Family members of ICU patients aged >18 years were randomized into to either verbal arm listening to a recorded verbal narration or the video arm watching video regarding life-sustaining treatments.

Results: Among a total of 209 participants, 168 participants enrolled, and were randomly assigned to the verbal (n=84) or the video arm (n=84). The proportion of participant in the verbal group and video group wanting to receive each life sustaining treatments was similar before randomization. Each 84 participants want to receive the life sustaining treatment after intervention as follows; CPR [30 (35.7%) vs. 31 (36.9%), p=1.000]; intubation [26 (31.0%) vs. 29 (34.5%), p=0.7425]; tracheostomy [20 (23.8%) vs. 20 (23.8%), p=1.000]; CRRT [18 (21.4%) vs. 20 (23.8%), p=0.8539]. When analyzing all participants, the preference for life-sustaining treatment also did not change after education except tracheostomy (16.9% vs. 24.1%, P=0.014). The mean of life-sustaining treatments assessment questionnaire scores (range 0–10) were significantly increased after intervention in all participants (8.46 vs. 7.55, P<0.0001).

Conclusions: Our study suggests that the preference of life sustaining treatments was not impacted by each intervention. However, total of participants who viewed video and listened verbal narration more likely desire to undergo tracheostomy after intervention. Moreover, participants were more informed after intervention.

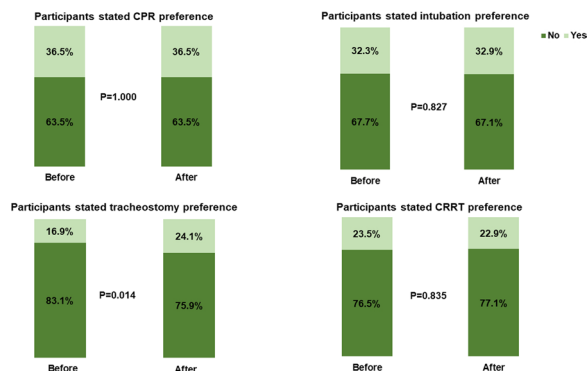
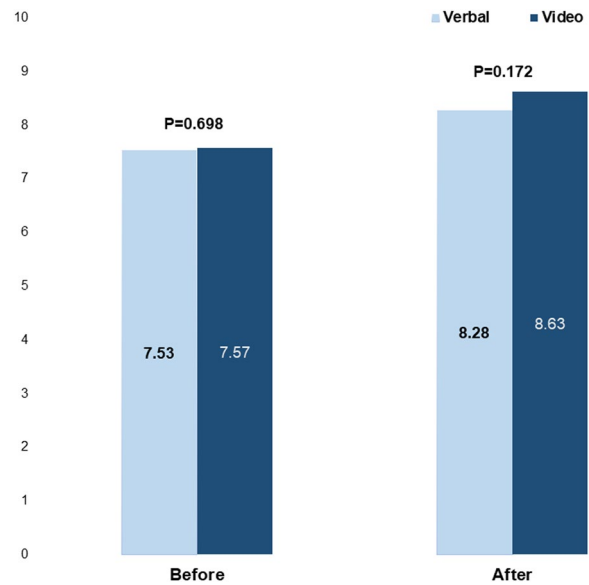
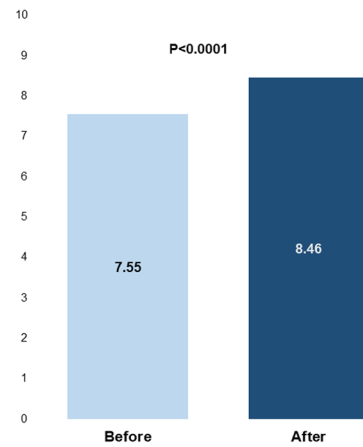

Figure 1 (abstract 000422) Life-sustaining treatments preferences in total participants



Pre-post intervention knowledge assessment comparison between the verbal and video arms



	Before education	After education	P-value
Knowledge score	7.55 ± 1.60	8.46 ± 1.64	<0.0001

Knowledge score of total participants before and after intervention

References

1. Richardson-Royer C, Naqvi I, Riffel C, Harvey L, Smith D, Ayalew D, et al. A video depicting resuscitation did not impact upon patients' decision-making. Int J Gen Med. 2018;11:73–7.
2. Volandes AE, Paasche-Orlow MK, Mitchell SL, El-Jawahri A, Davis AD, Barry MJ, et al. Randomized controlled trial of a video decision support tool for cardiopulmonary resuscitation decision making in advanced cancer. Journal of Clinical Oncology. 2013;31(3):380.
3. Volandes AE, Paasche-Orlow MK, Barry MJ, Gillick MR, Minaker KL, Chang Y, et al. Video decision support tool for advance care planning in dementia: randomised controlled trial. Bmj. 2009;338:b2159.

Topic: Ethics and end of life care

000424

Carotid artery corrected flow time detects stroke volume change measured by transesophageal echocardiography

J. E. Kenny¹, G. Clarke², I. Kerrebijn³, T. Savery², M. Knott⁴, C. Munding³, M. Elfarnawany³, A. Eibl¹, J. Eibl⁵, B. Nalla⁶, R. Atoui⁷

¹Clinical Research, Health Sciences North Research Institute Walford Site, Greater Sudbury, Canada; ²Engineering, Flosonics Medical, Greater Sudbury, Canada; ³Engineering, Flosonics Medical, Toronto, Canada; ⁴Nursing, NOSM University, Greater Sudbury, Canada; ⁵Biomolecular Science, Laurentian University, Greater Sudbury, Canada; ⁶Anesthesiology, NOSM University, Greater Sudbury, Canada; ⁷Cardiovascular Surgery, NOSM University, Greater Sudbury, Canada

Correspondence: R. Atoui

Intensive Care Medicine Experimental 2023, 11(Suppl 1):000424

Introduction: As a measure of preload responsiveness, change in the corrected flow time of the carotid artery (ccFTΔ) is a surrogate for stroke volume change (SVΔ). However, the reported optimal threshold and accuracy of ccFTΔ to detect SVΔ are inconsistent. Conflicting data likely have 3 sources: (1) human measurement variability, (2) temporal discordance between carotid Doppler and the reference standard and (3) sampling too few cardiac cycles.

We hypothesized that the area under the receiver operator curve (AUROC) for ccFTΔ to detect a +10% SVΔ would improve with synchronization between the carotid artery and left ventricular outflow tract (LVOT) with temporal resolution of a single cardiac cycle and as a function of consecutively-averaged cardiac cycles.

Objectives: (1) Describe sources of error when comparing hand-held Doppler SVΔ surrogates with a reference standard.

(2) Describe a paradigm where human measurement variability and temporal discordance between peripheral Doppler and SVΔ reference standard are minimized.

(3) Explore the effect of cardiac cycle sample size on the diagnostic accuracy of ccFTΔ for detecting a +10% SVΔ

Methods: The Research Ethics Board of Health Sciences North approved the study. A convenience sample of adult patients comprise this analysis. Exclusion criteria were history of severe carotid stenosis, lack of informed consent and contraindication to transesophageal echocardiography (TEE).

Anesthesia was induced with 0.5 mg/kg propofol, 1.2 mg/kg rocuronium, 1.0 µg/kg sufentanil and maintained with sevoflurane of 0.5 to 0.7 minimum alveolar concentration and 0.2 µg/kg/h sufentanil IV. Ventilation was volume-controlled with tidal volume 8 mL/kg of lean body weight, respiratory rate 15 breaths/min, PEEP 5 cmH₂O and FiO₂ 0.5.

The wearable Doppler patch (Flosonics Medical, Sudbury, ON, Canada) is a continuous-wave 4 MHz ultrasound placed over the carotid artery and calculates ccFT by Wodey's equation. LVOT velocity time integral (VTI) from TEE was measured by a cardiac anesthesiologist using a Phillips Epiq (Cambridge, MA, USA) 2.9 MHz probe in the trans-gastric window; the insonation angle was 0 degrees and sample window 4 mm.

Synchronized Doppler data from the carotid artery and TEE were recorded during a 60 s baseline and throughout an entire 90 s Trendelenburg maneuver following CABG with the chest open.

For each subject, both ccFTΔ from the ultrasound patch and LVOT VTI change (LVOTΔ) from TEE were calculated using 1-to-30 consecutively-averaged, synchronous cardiac cycles between supine and Trendelenburg positions. Consecutive beats were selected randomly for 1000 iterations per patient. Comparisons were dichotomized into LVOTΔ (i.e., SVΔ, assuming constant LVOT diameter) of ≥ +10% or < +10%. From the 1000 iterations, distributions of optimal ccFTΔ and its sensitivity, specificity and AUROC were determined for each of 1-to-30-cycle averages. The mean and standard deviations of the distributions were calculated.

Results: Data from 23 patients and preload challenges comprising 2310 cardiac cycles are included. Figure 1 shows the baseline patient characteristics and results.

When 1 cardiac cycle was compared from baseline to Trendelenburg position, the mean AUROC, sensitivity, specificity and optimal ccFTΔ threshold were: 0.65, 76%, 67% and 8.2 ms (ms), respectively. For 6 and 24 consecutively-averaged cardiac cycles, these values were 0.76, 85%, 73%, 8.6 ms and 0.84, 91%, 84% and 7.2 ms, respectively.

Conclusions: The clinical relevance of our findings are as follows: (1) ccFTΔ obtained by wireless, wearable Doppler ultrasound accurately detects TEE-measured SVΔ when synchronized with single-beat temporal resolution, (2) the accuracy of ccFTΔ to detect SVΔ depends on the number of consecutively-averaged cardiac cycles. (3) the optimal ccFTΔ threshold is less influenced by the number of averaged-beats but the standard deviation decreases with more cardiac cycles (i.e., confidence increases). (4) AUROC plateaued at 0.84 with 24 consecutively-averaged cardiac cycles (sensitivity 91%, specificity 84%); the optimal ccFTΔ to detect a 10% SVΔ with this number of beats was 7.2 ms.

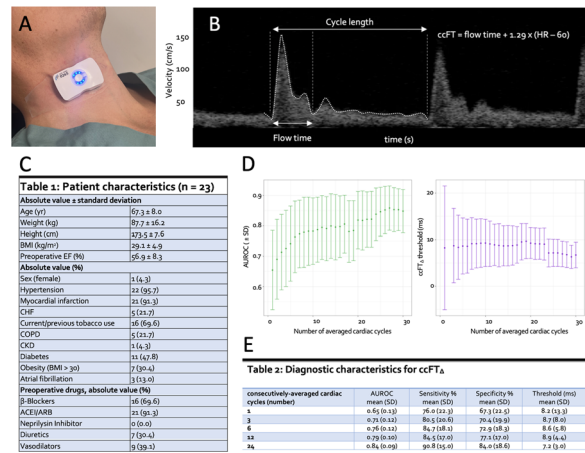

Figure 1 (abstract 000424) (A) Wearable Doppler ultrasound on a volunteer. (B) Carotid Doppler spectrogram, flow time and equation of Wodey. (C) characteristics of patients. (D) relationship between number of averaged cardiac cycles (x-axis) and the area under the receiver operator curve (AUROC) and optimal corrected flow time change (ccFT?) threshold for identifying a +10% change in stroke volume (SV?). (E) AUROC, sensitivity, specificity and optimal ccFT? Threshold for increasing numbers of averaged cardiac cycles. Abbreviations: yr, year; kg, kilogram; cm, centimeter; EF, ejection fraction; CHF, congestive heart failure; COPD, chronic obstructive pulmonary disease; CKD, chronic kidney disease; BMI, body mass index; ACEI/ARB, angiotensin converting enzyme inhibitor/angiotensin receptor blocker

References

- Kenny JS, Barjaktarevic I, Mackenzie DC, Elfarnawany M, Yang Z, Eibl AM, Eibl JK, Kim CH, Johnson BD. Carotid Doppler ultrasonography correlates with stroke volume in a human model of hypovolaemia and resuscitation: analysis of 48 570 cardiac cycles. *Br J Anaesth.* 2021 Aug;127(2):e60-e63. <https://doi.org/10.1016/j.bja.2021.05.007>
- Kenny JS, Munding CE, Eibl AM, Eibl JK. Wearable ultrasound and provocative hemodynamics: a view of the future. *Crit Care.* 2022 Oct 25;26(1):329. <https://doi.org/10.1186/s13054-022-04206-7>
- Barjaktarevic I, Toppen WE, Hu S, Aquije Montoya E, Ong S, Buhr R, David IJ, Wang T, Rezayat T, Chang SY, Elashoff D, Markovici D, Berlin D, Cannesson M. Ultrasound Assessment of the Change in Carotid Corrected Flow Time in Fluid Responsiveness in Undifferentiated Shock. *Crit Care Med.* 2018 Nov;46(11):e1040-e1046. <https://doi.org/10.1097/CCM.00000000000003356>
- Beier L, Davis J, Esener D, Grant C, and Fields J.M. (2020), Carotid Ultrasound to Predict Fluid Responsiveness. *J Ultrasound Med*, 39: 1965–1976. <https://doi.org/10.1002/jum.15301>
- Christine Horner for data analysis
- Amber Tooley for patient consent

7. Singla D, Gupta B, Varshney P, Mangla M, Walikar BN, Jamir T. Role of carotid corrected flow time and peak velocity variation in predicting fluid responsiveness: a systematic review and meta-analysis. Korean J Anesthesiol. 2022 Nov 15. <https://doi.org/10.4097/kja.22385>
8. Serena Saini for patient consent
9. Grant number: NOAMA-A-21-01

Topic: Cardiovascular issues in ICU

000426

Ventilator associated pneumonia: epidemiological evolution and bundle compliance at a primary hospital ICU during a 5-year period

R. Passos¹, F. Cardoso², D. Alves², F. Teixeira Silva¹, R. Corga Da Silva³, J. Caldeiro⁴

¹Intensive Care Medicine, Hospital Santa Luzia - Ulsam, Viana do Castelo, Viana do Castelo, Portugal; ²Intensive Medicine, Hospital Santa Luzia - Ulsam, Viana do Castelo, Viana do Castelo, Portugal; ³Intensive Care Medicine, Unidade Local de Saude do Alto Minho, Viana do Castelo, Portugal; ⁴Departamento de medicina crítica, Unidade Local de Saude do Alto Minho, Viana do Castelo, Portugal

Correspondence: R. Passos

Intensive Care Medicine Experimental 2023, 11(Suppl 1):000426

Introduction: Ventilator associated pneumoniae (VAP) is defined as a nosocomial pneumonia that develops 48 h after intubation in patients receiving mechanical ventilation (IMV). VAP is the second most common nosocomial infection in ICU, affecting 5–40% of patients with an incidence ranging from 5 to 20 cases per 1000 ventilator days. It increases the duration of hospitalization and mortality, with a VAP-related mortality of 30–50%. During the last decades there have been great scientific concern about implementing the best strategies to reduce its incidence and it is consensual that general preventive measures, if implemented together—as bundle, might result in better outcomes.

Objectives: The aim of this study was to describe the epidemiological evolution of VAP and to evaluate bundle compliance during the last 5 years.

Methods: We performed a retrospective analysis of sociodemographic, clinical data and VAP-bundle compliance of patients admitted to our ICU between march 2019 and march 2023.

Results: A total of 61 patients were diagnosed with VAP, corresponding to a prevalence of 16.5% (24 per 1000 ventilator days), with an increasing pattern from 2019 to 2021 (16.7% vs 17.1% vs 20.2%) and decreasing since then (13% vs 4.35% in 2023). Table 1 summarizes the baseline sociodemographic and clinical data of the overall VAP population and the particular analysis through the 5 years of study. There were no significant differences between years in the 24-h SOFA, SAPS II and APACHE II scores. The mean age was 64.9 ± 11.8, with significant older patients in 2020 (F (4, 56) = 2.98; p = 0.03). 39 patients (63.9%) were male, with no differences regarding gender between years (χ² (4) = 3.03; p = 0.55). The mean ICU length of stay was 21.9 ± 14.8 days and 28-days mortality 39.3%. The time of onset of VAP was 9.61 ± 5.66 days since intubation. 29 patients (47.5%) had COVID-19 at admission and the peak of cases occurred in 2020, despite there were no significant differences between years (χ² (4) = 9.20; p = 0.06). Data regarding bundle compliance are reported in Table 2. Stress ulcer prophylaxis was performed in every patient (all considered high risk)—in 55 patients (90.2%) with i.v. pantoprazol and in 6 (9.84%) with omeprazol. 41 patients (67.2%) started enteral feeding in the first 48 h and readiness to wean and early spontaneous breathing trial (SBT) was performed in 57 patients (93%).

Conclusions: The prevalence of VAP was coincident with the reported in the literature. Regarding the evolution along the years, the peak of cases in 2020 and 2021 might be related with the reported increased incidence of COVID-19 cases in those years and the absence of significant differences might be explained by the small sample size. To date there is an increasing number of studies reporting a higher incidence of VAP in COVID-19 patients. Besides that, the compliance of SBT was also lower in 2020, which might also have predisposed to

the increased risk to VAP. It is consensual that the implementation of measures among ICU personnel regarding to VAP preventive strategies is fundamental to reduce its incidence. Some standard measures included in the VAP bundle, as early SBT and restriction of stress ulcer prophylaxis to the high-risk patients appear to be consensual in the scientific community. However, there are measures that are still not certain such as oral care with chlorhexidine or the increased risk of VAP with the early initiation of enteral nutrition. In this context it is fundamental that randomized controlled trials are performed to compare different measures efficacy and find the best combination of interventions to create a gold standard VAP bundle.

Table 1 (abstract 000426) Baseline characteristics and clinical data during the study period

Variables	Overall population (n=61)	Patients admitted in 2019 (n=4)	Patients admitted in 2020 (n=24)	Patients admitted in 2021 (n=23)	Patients admitted in 2022 (n=9)	Patients admitted in 2023 (n=1)	Statistics
Prevalence, %	16.5%	16.7%	17.1%	20.2%	13%	4.35%	-
Incidence, (n/1000 ventilator days)	24	28	25	29	26	7	-
Gender, n (%)							χ ² (4) = 3.03; p=0.55;
Female	22 (36.1%)	2 (50%)	8 (33.3%)	9 (39.1%)	2 (22.2%)	1 (100%)	
Male	39 (63.9%)	2 (50%)	16 (66.7%)	14 (60.9%)	7 (77.8%)	-	
Age, years	64.9 ± 11.8	67.5 ± 4.67	70.5 ± 2.62	60.9 ± 2.70	60.4 ± 3.38	-	F (4, 56) = 2.98; p = 0.03
SOFA at 24h	7.59 ± 3.95	4.75 ± 2.78	7.88 ± 0.78	7.26 ± 0.83	8.33±1.20	-	F (4, 56) = 1.13; p = 0.35
APACHE II	19.0 ± 7.80	15.5 ± 4.56	20.0 ± 1.54	17.6 ± 1.72	20.3±2.10	-	F (4, 56) = 1.14; p = 0.35
SAPS II	44.5 ± 17.5	37.8 ± 12.7	48.4 ± 3.53	39.2 ± 3.78	48.9 ± 3.03	-	F (4, 56) = 1.44; p = 0.23
28-day mortality, n (%)	24 (39.3%)	1 (25%)	13 (54.2%)	6 (26.1%)	4 (44.4%)	-	χ ² (4) = 5.00; p = 0.29;
ICU length of stay, days	21.9 ± 14.8	36 ± 12.2	20.6 ± 2.32	22.6 ± 3.56	17.2 ± 3.38	-	F (4, 56) = 1.21; p = 0.32
IMV at VAP diagnosis, days	9.61 ± 5.66	7.25 ± 2.59	9.38 ± 0.74	11.0±1.64	7.78±1.09	-	F (4, 56) = 0.733; p = 0.57
COVID-19 at admission, n (%)	29 (47.5%)	-	15 (62.5%)	12 (52.2%)	2 (22.2%)	-	χ ² (4) = 9.20; p = 0.06;
Trauma at admission, n (%)	10 (16.4%)	2 (50%)	5 (20.8%)	1 (4.35%)	2 (22.2%)	-	χ ² (4) = 6.50; p = 0.17;

Table 2 (abstract 000426) VAP bundle compliance during the study period

Variables	Overall population (n=61)	Patients admitted in 2019 (n=4)	Patients admitted in 2020 (n=24)	Patients admitted in 2021 (n=23)	Patients admitted in 2022 (n=9)	Patients admitted in 2023 (n=1)	Statistics
Early spontaneous breathing trial, n (%)	57 (93%)	4 (100%)	22 (91.7%)	22 (95.7%)	8 (88.9%)	1 (100%)	χ ² (4) = 0.96; p=0.92;
Enteral nutrition at 48 hours, n (%)	41 (67.2%)	3 (75%)	19 (79.2%)	12 (52.2%)	7 (77.8%)	-	χ ² (4) = 6.53; p=0.16;
Tracheostomy	19 (31.1%)	1 (25%)	6 (25%)	10 (43.5%)	2 (22.2%)	-	χ ² (4) = 2.91; p=0.57;
Oral care with chlorhexidine	61 (100%)	4 (100%)	24 (100%)	23 (100%)	9 (100%)	1 (100%)	-
Stress ulcer prophylaxis	61 (100%)	4 (100%)	24 (100%)	23 (100%)	9 (100%)	1 (100%)	-
Semirecumbent position of head	61 (100%)	4 (100%)	24 (100%)	23 (100%)	9 (100%)	1 (100%)	-

References

1. Mastrogianni M, Katsoulas T, Galanis P. The Impact of Care Bundles on VAP Prevention in adult ICUs: A. systematic Review. Antibiotics. 2023; 12 (227)
2. Klompas M. Prevention of Intensive Care Unit-Acquired Pneumonia. Seminars in Respiratory and Critical Care Medicine. 2019; 40 (4).

Topic: Infections and prevention

000427

Trophic nutrition in ICU patients undergoing high-flow oxygen therapy and/or noninvasive mechanical ventilation. The nutri-trophic study

S. Ruiz-Santana¹, O. Reta Pérez², J. Moreno López³, S. F. Maichle⁴, E. Portugal Rodríguez², M. Cerezo Arias⁵, L. Sánchez Amo Alés⁷, J.

Martinez-Carmona⁸, L. Mateu Campos⁹, C. Lorencio Cárdenas¹⁰, A. García Miguez¹¹, M. Sosa Durr², M. San Martín Bragado², P. Saavedra-Santana¹²
¹Intensive Care Unit, University Hospital of Gran Canaria Dr. Negrín, Las Palmas de Gran Canaria, Spain; ²Intensive Care Unit, University Hospital of Gran Canaria Dr. Negrín, Las Palmas de Gran Canaria, Spain; ³Intensive Care Unit, Hospital Universitario San Cecilio, Granada, Spain; ⁴Intensive Care Unit, Hospital Clínico Universitario San Carlos, Madrid, Spain; ⁵Intensive Care Unit, Hospital Clínico Universitario Valladolid, Burgos, Spain; ⁶Intensive Care Unit, Infanta Cristina Hospital, Badajoz, Spain; ⁷Intensive Care Unit, Hospital Consorci Sanitari de Terrassa, Barcelona, Spain; ⁸Intensive Care Unit, Hospital Regional Universitario de Málaga, Málaga, Spain; ⁹Intensive Care Unit, Hospital General Universitari de Castellón, Castellón de la Plana, Spain; ¹⁰Intensive Care Unit, Hospital Universitari de Girona Dr Josep Trueta, Girona, Spain; ¹¹Intensive Care Unit, Marqués de Valdecilla University Hospital, Santander, Spain; ¹²Mathematics and Informatics Department, Universidad de Las Palmas de Gran Canaria, Las Palmas de Gran Canaria, Spain

Correspondence: S. Ruiz-Santana

Intensive Care Medicine Experimental 2023, **11(Suppl 1)**:000427

Introduction: The decision on the initiation of enteral nutrition therapy in patients admitted to the ICU who require oxygen therapy with high-flow nasal oxygen therapy (HFNO) and/or noninvasive mechanical ventilation (NIV) is currently the subject of debate. Despite the benefits associated with this practice, the scarcity of clinical studies with sufficient methodological quality, as well as the absence of specific recommendations on enteral nutrition therapy in this type of patient generates controversy.

Objectives: Prospective, observational, multicenter study to analyze: 90-day mortality, tolerance and side effects of trophic enteral nutrition (TEN) in a cohort of critically ill patients with HFNO and/or NIV.

Methods: Patients requiring 24 or more hours of oxygen therapy with HFNO and/or NIV with expected ICU stay and survival greater than 72 h. BMI < 18 and absolute contraindication to start TEN or non-functioning GI tract were excluded.

Energy target: 20–30% caloric needs (oral: decaffeinated coffee flavored diet or NG tube); protein intake: corresponding diet used: hyperproteic (100 g/1000 ml); caloric intake 1.2 kcal/ml and ratio non-protein kcal/g nitrogen: 52:1 (Fresubin Intensive, Fresenius-kabi, Germany).

Variables: age, sex, weight, height, BMI, severity scales, reason for admission, type of patient, days HFNO/NIV; days of stay and ICU/hospital mortality: 90 days. Protein levels, renal and liver biochemistry: admission/discharge. Nosocomial infectious complications. Variables related to efficacy and safety of TEN, including gastric residuals (> 500 ml/day). Follow-up: from start of oxygen therapy until 3 days after the end of TEN.

Categorical variables are expressed as frequencies and percentages and continuous as mean and standard deviation (SD) when data followed a normal distribution, or as median and interquartile range (IQR = 25th–75th percentile) when distribution departed from normality. The percentages were compared, as appropriate, using the Chi-square (χ^2) test or the exact Fisher test, the means by the t-test, and the medians by the Wilcoxon test for independent data. Data were analyzed using the R package, version 4.2.1 (R Development Core Team, 2022). (clinicaltrials.gov: NCT03728452).

Results: One hundred and seven patients were recruited. Mean age, Apache II and Sofa score, tracheobronchitis, UTI and antibiotic treatment were significantly higher in dead versus alive patients. There were no significant differences in the volume of diet administered and kilocalories between alive and dead. However, the dead received significantly less protein than the alive. Episodes of feeding intolerance were scarce, but feeding interruptions were significantly higher in death versus alive patients. None of them had aspiration episodes, but 15.6% received prokinetics. Mortality was 14.9%, but at 90 days was 43.8% (Table 1).

Conclusions: Trophic enteral nutrition appears feasible and safe in this cohort of ICU patients. Sixteen patients died, although nearly half of them between 60 and 90 days.

Table 1 (abstract 000427) Patient characteristics according to survival

	Total n = 107	Alive n = 91	Death n = 16	P-value
Age (years)	61.3 ± 14.5	59.7 ± 14.5	70.7 ± 11.0	0.004
Sex, male	79 (73.8)	68 (74.7)	11 (68.8)	0.758
BMI (Kg/m ²)	28.5 ± 5.1	28.9 ± 5.1	26.1 ± 4.6	0.038
Apache-II score	14 (10 ; 19)	13 (9 ; 18)	18 (13.5 ; 24.8)	0.01
Sofa score (admission)	3 (2 ; 6)	3 (2 ; 5.5)	6 (3 ; 8)	0.025
Sofa score (3 rd day)	3 (2 ; 5.2)	3 (2 ; 4.2)	5.5 (3 ; 7.8)	0.012
Tracheobronchitis	8 (10.5)	4 (6.3)	4 (30.8)	0.025
VAP	6 (7.9)	5 (7.9)	1 (7.7)	1
Bacteremia	8 (10.5)	5 (7.9)	3 (23.1)	0.132
UTI	6 (7.9)	2 (3.2)	4 (30.8)	0.007
Infections (other)	8 (10.5)	6 (9.5)	2 (15.4)	0.619
Antibiotics	47 (49.0)	32 (40.0)	15 (93.8)	< .001
Prokinetics	15 (15.6)	11 (13.8)	4 (25.0)	0.269
HFNO/NIV (days)	4 (2 ; 6)	4 (2.8 ; 6)	4 (2 ; 6)	0.585
28 days-mortality	6 (5.6)	0	6 (37.5)	
60 days-mortality	3 (2.8)	0	3 (18.8)	
90 days-mortality	7 (6.5)	0	7 (43.8)	...
ICU (days)	10 (7 ; 16)	9 (7 ; 14.5)	16.5 (6.8 ; 29.2)	0.187
Hospital (days)	15 (8 ; 23)	15.5 (9.2 ; 23)	13 (6 ; 20)	0.404
Energy expenditure (kcal)	1850 (1600 ; 2288)	1875 (1600 ; 2288)	1775 (1515 ; 2182)	0.387
Volume administered (ml)	450 (250 ; 500)	475 (284 ; 500)	306 (248 ; 452)	0.065
Kcal given, enteral	456 (300 ; 600)	504 (300 ; 600)	355 (283 ; 435)	0.058
Proteins given, enteral (g)	45 (24.9 ; 50)	50 (25 ; 50)	27.5 (22.9 ; 41.4)	0.031
Diarrhea	9 (8.7)	8 (9.1)	1 (6.2)	1
Abdominal distention	2 (1.9)	1 (1.1)	1 (6.2)	0.285
Gastric residual	1 (1.1)	1 (1.1)	0 (0)	1
NG tube displacement	2 (1.9)	2 (2.3)	0	1
NG tube obstruction	1 (1.0)	1 (1.1)	0	1
Feeding interruptions	13 (12.5)	8 (9.1)	5 (31.2)	0.028
On admission:				
Albumin (g/dL)	3.1 (2.8 ; 3.4)	3.1 (2.9 ; 3.4)	2.9 (2.7 ; 3.3)	0.125
Bilirubin (mg/dL)	0.5 (0.3 ; 0.7)	0.5 (0.3 ; 0.7)	0.5 (0.3 ; 0.8)	0.942
AST (U/L)	35.5 (20.2 ; 58.2)	36 (21 ; 56)	33 (14.5 ; 72.5)	0.434
ALT (U/L)	32 (17.5 ; 55.2)	33 (18 ; 56)	21.5 (14.8 ; 48)	0.22
AP (U/L)	70 (54 ; 93)	71 (53 ; 93)	67 (55 ; 91)	0.818
GGT (U/L)	61 (29 ; 109)	62 (30 ; 129)	53 (20 ; 66)	0.159
Urea (mg/dL)	48 (38.7 ; 74.5)	47 (37.9 ; 67)	67 (42.5 ; 86)	0.229
Creatinine (mg/dL)	0.8 (0.7 ; 1.1)	0.8 (0.7 ; 1.1)	1.0 (0.5 ; 1.9)	0.972

Data: means (SD), frequencies (%) and medians (IQR); BMI: body mass index; VAP: ventilator-associated pneumonia; UTI: urinary tract infections; HFNO: high-flow nasal oxygen; NIV: non-invasive ventilation; NG: nasogastric; AST: aspartate transaminase; ALT: alanine transaminase; AP: alkaline phosphatase; GGT: gamma-glutamyl transferase

References

- Terzi N, Darmon M, Reigner J, Ruckly S, Garrouste-Orgeas M, Lautrette A, Azoulay E, Mourvillier B, Argaud L, Papazian L, Gannier M, Goldgran-Toledano D, Jamali S, Dumenil AS, Schwebel C, Timsit JF; OUTCOM-EREA study group. Initial nutritional management during noninvasive ventilation and outcomes: a retrospective cohort study. *Crit Care*. 2017 Nov 29;21(1):293. <https://doi.org/10.1186/s13054-017-1867-y>. PMID: 29187261; PMCID: PMC5707783. Copy Download.nbib Format:

Topic: Metabolism, endocrinology, liver failure and nutrition

000428

Red blood cell transfusion does not improve brain tissue oxygenation in post-cardiac arrest patients with hypoxic-ischemic brain injury

J. Bird¹, J. Cooper², D. Cardim³, C. Wellington⁴, S. Stukas⁴, S. Thiera⁵, D. Foster⁶, P. Gooderham⁷, P. Ainslie⁸, D. Griesdale⁹, M. Sekhon¹⁰, R. Hoiland¹¹
¹Department of Medicine, The University of British Columbia, Vancouver, Canada; ²Department of Pathology and Laboratory Medicine, The University of British Columbia, Vancouver, Canada; ³Brain Physics Laboratory, Division of Neurosurgery, Department of Clinical Neurosciences, addenb, University of Cambridge, Cambridge, United Kingdom; ⁴Pathology, The University of British Columbia, Vancouver,

Canada; ⁵Division of Critical Care Medicine, Department of Medicine, The University of British Columbia, Vancouver, Canada; ⁶Division of Critical Care, Vancouver General Hospital, Vancouver, Canada; ⁷Department of Neurosurgery, Vancouver General Hospital, Vancouver, Canada; ⁸School of Health and Exercise Sciences, The University of British Columbia - Okanagan Campus, Kelowna, Canada; ⁹Department of Anesthesiology, Pharmacology & Therapeutics, The University of British Columbia, Vancouver, Canada; ¹⁰Division of Critical Care Medicine, Department of Medicine, Vancouver General Hospital, The University of British Columbia, Vancouver, Canada; ¹¹Department of Anaesthesiology, Pharmacology and Therapeutics, Faculty of Medicine, The University of British Columbia, Vancouver, Canada

Correspondence: J. Bird

Intensive Care Medicine Experimental 2023, **11(Suppl 1)**:000428

Introduction: Following cardiac arrest and return of spontaneous circulation, persistent brain hypoxia leads to ongoing hypoxic-ischemic brain injury (HIBI). Red blood cell (RBC) transfusions have been explored as a method to improve brain oxygenation, but studies from the neurocritical care setting have not demonstrated a consistent ability for RBC transfusion to improve brain oxygenation.

Objectives: Determine the impact of RBC transfusion on brain oxygenation in post-cardiac arrest patients with HIBI.

Methods: We performed a single center prospective interventional study on 23 post-cardiac arrest patients with HIBI that were enrolled into one of two groups: (1) invasive neuromonitoring of the intraparenchymal partial pressure of brain tissue oxygen (PbtO₂; n = 9), and (2) non-invasive neuromonitoring with jugular venous oximetry and near-infrared spectroscopy (NIRS; n = 14). Pre-transfusion and 12–24 h following transfusion, paired arterial and jugular venous blood samples were collected to determine the arterial-to-venous differences of brain injury biomarkers. These markers included glial fibrillary acidic protein (a marker of astroglial injury and activation) as well as neurofilament light (a marker of axonal injury).

Results: Neither the NIRS-derived regional saturation of oxygen (P = 0.08) or PbtO₂ (P = 0.19) were altered by RBC transfusion. Following RBC transfusion there was cerebral release of glial fibrillary acidic protein (−91.0 [−325.9–20.9] pg/mL; P = 0.045) and neurofilament-light (−39.5 [−499.3–7.1] pg/mL; P = 0.040) indicating ongoing neuroglial injury.

Conclusions: RBC transfusions may lack efficacy in mitigating secondary brain hypoxia in post-cardiac arrest patients with HIBI. Future work investigating the physiologic consequences of RBC transfusion is needed to determine the mechanisms underlying this potential lack of efficacy.

References

1. This study was funded by the Canadian Institutes of Health Research (#437644) and Vancouver General Hospital Foundation.

Topic: Neurointensive care

000433

Effects of tele-yoga on physical and psychological outcomes in patients with long-term critical illness—a randomised controlled trial

L. Orvelius¹, L. Klompstra², M. Papageorgiou², T. Hedbom², M. Lundberg², I. Thylén³, T. Jaarsma², A. Strömberg³

¹Department of Anaesthesia and Intensive Care, Department of Clinical and Experimental Medicine, Linköping University, Linköping, Sweden;

²Department of Health, Medicine and Caring Sciences, Linköping University, Linköping, Sweden;

³Department of Health, Medicine and Caring sciences, Department of Cardiology, Linköping University, Linköping, Sweden

Correspondence: L. Orvelius

Intensive Care Medicine Experimental 2023, **11(Suppl 1)**:000433

Introduction: Patients with long-term critical illness, after a period of intensive care, deterioration of heart failure, or arrhythmias in need of implantable cardioverter-defibrillator often have an impaired physical function, decreased health-related quality of life (HRQoL) and symptoms of anxiety and depression. Yoga, as a mind-body intervention, may improve these outcomes. Further a tele-yoga intervention can potentially increase accessibility and facilitate participation for highly symptomatic patients that have problems leaving their home.

Objectives: To determine effects of tele-yoga on exercise capacity and patient-reported outcome measures.

Methods: Participants were recruited from four hospitals (university and county hospitals) in Sweden. Inclusion criteria were patients > 18 years, hospitalised at intensive care units (ICU) or cardiology units > 48 h during the last 36 months and now clinically stable. The participants were randomised to a control group receiving individual exercise advice or to the intervention group (tele-yoga). The intervention included performing live-streamed group-yoga for 60 min twice/week for 3 months and practicing yoga individually for a minimum of 10 min/day using an application. The group-sessions were led by certified mediayoga-instructors via a virtual video-platform. The yogaform was Kundalini adapted to individuals with health conditions (mediayoga) including different postures, breathing exercises and meditations. The primary endpoint of the study was a combined endpoint consisting of minimal clinically important difference in functional capacity measured by 6-min walk test (6MWT), HRQoL (EQ-5D index/VAS) and symptoms of anxiety and depression (HADS). The used cut offs for comparison between baseline and follow-up after 3 months were > 30 m for 6MWT, a score > 0.08/> 11 for EQ-5D index/VAS and ≥ 8 for HADS. The primary combined end-point analysis after 3 months follow-up compared the change in the combined endpoint between the participants in the tele-yoga and control group. Secondary endpoints included separate analysis of functional capacity, HRQoL and symptoms of anxiety/depression.

Results: A total of 311 participants were randomized to tele-yoga (n = 156) and control (n = 155), mean age 65,8 years, 30% women, 16% being cared for in an ICU. There was a significant improvement in favour of the tele-yoga group in the combined primary endpoint (p = 0.006). When analysing them separately, there was a significant improvement in 6MWT (p = 0.008) and HRQoL in EQ-5D VAS (p = 0.014), but not in EQ-5D index (p = 0.12), and a significant difference between the groups in symptoms of anxiety and depression (p = 0.03).

Conclusions: The tele-yoga intervention showed a significant improvement in the combined endpoint consisting of physical function, HRQoL and mental health. Tele-yoga may be a promising new form of rehabilitation for patients with long-term critical illness.

References

1. Azoulay, E., et al., Recovery after critical illness: putting the puzzle together—a consensus of 29. *Crit Care*, 2017. 21(1): p. 296 Desveaux L, Lee A, Goldstein R, Brooks D, (2015) Yoga in the Management of Chronic Disease: A Systematic Review and Meta-analysis. *Med Care* 53: 653–661 Donesky D, Selman L, McDermott K, Citron T, Howie-Esquivel J, (2017) Evaluation of the Feasibility of a Home-Based TeleYoga Intervention in Participants with Both Chronic Obstructive Pulmonary Disease and Heart Failure. *J Altern Complement Med* 23: 713–721 Garcia-Sesnich JN, Flores MG, Rios MH, Aravena JG, (2017) Longitudinal and Immediate Effect of Kundalini Yoga on Salivary Levels of Cortisol and Activity of Alpha-Amylase and Its Effect on Perceived Stress. *Int J Yoga* 10: 73–80 Strömberg, A.; Thylén, I.; Orvelius, L.; Klompstra, L.; Jaarsma, T. Tele-Yoga in Long Term Illness—Protocol for a Randomised Controlled Trial Including a Process Evaluation and Results from a Pilot Study. *Int. J. Environ. Res. Public Health* 2021, 18, 11343. <https://doi.org/10.3390/ijerph182111343>
2. This work is supported through the Swedish Research Council (VR) 2018 02719 and 2022–01089, The Swedish Heart–Lung Foundation 20170766 and 20210473, Swedish Research Council for health, working life and welfare (FORTE) 2018-00650 and Medical Research Council of Southeast Sweden (FORSS) and Region Östergötland.

Topic: Critical care organisation, quality management, information systems, outcomes

000434

Association of dynamic high-density lipoprotein trajectory with clinical outcomes in critically ill children

J. Fu¹, X. Zhang¹, G. Zhang¹, Y. Ji², S. Chen¹

¹Department of Critical Care Medicine, West China Hospital, Sichuan University, Chengdu, China; ²Department of pediatric surgery, West China Hospital, Chengdu, China

Correspondence: J. Fu

Intensive Care Medicine Experimental 2023, **11(Suppl 1)**:000434.

Introduction: Extremely low lipid levels are considered a sign of debilitation and illness. Previous reports on the association between lipid levels and mortality in critically ill patients have been inconsistent, and there have been few detailed reports for critically ill children.

Objectives: The objective of the study was to characterize the longitudinal, dynamic high-density lipoprotein (HDL) trajectory in critically ill children admitted to the pediatric intensive care unit (PICU) and explore the relationship between the groups stratified by different trajectories and clinical outcomes.

Methods: All critically ill children admitted to PICU between 2016 and 2021 were included. Group-based trajectory modeling was applied to characterize the HDL trajectories in days 0–6 post-PICU admission and develop HDL trajectory subgroups. Then, multivariate logistic regression and multiple linear regression were used to compare clinical outcomes across distinct groups. In addition, a sensitivity analysis was performed in critically ill children with the age less than 1 year. The primary outcome indicator was in-hospital mortality; the length of stay (LOS) in the PICU was the secondary outcome.

Results: A total of 4384 eligible critically ill children were ultimately enrolled in the study, and 6 HDL trajectory subgroups were developed by GBTM analyses, differing in the initial HDL, evolution pattern. Group 1 (n = 758), “the lowest HDL subgroup”, was characterized by starting with the lowest HDL and maintaining stable after slightly declining. Group 2 (n = 1413), the “lower HDL subgroup”, was the same trend as Group 1 but the whole trajectory was higher than Group 1. Group 3 (n = 74), the “low-to-high subgroup”, was characterized by starting with low HDL (lower than Group 2 but higher than Group 1), then rose slowly to the highest. Group 4 (n = 621), “the medium HDL subgroup”, was the same trend as Group 2, but the whole trajectory was higher than Group 2 and lower than Group 5. Group 6 (n = 147), the highest HDL subgroup, started with the highest HDL and then slowly descended. Group 5 (n = 1371), the “higher HDL subgroup”, was the same trend as Group 6, but the whole trajectory was lower than Group 6. Compared with critically ill children in Group 1, those belonging to Group 2, Group 3, Group 4, Group 5, and Group 6 were at lower risks of in-hospital mortality with (odds ratio[OR] 0.475; 95% confidence interval [CI] 0.352–0.641, P < 0.001), (OR 0.093; 95% CI 0.013–0.679, P = 0.019), (OR 0.322; 95% CI 0.208–0.479, P < 0.001), (OR 0.263; 95% CI 0.185–0.374, P < 0.001), (OR 0.142; 95% CI 0.044–0.454, P = 0.001), respectively. Multiple linear regression analysis was performed to evaluate the effect of HDL trajectory subgroups on the LOS of PICU. Compared with critically ill children in Group 1, those belonging to Group 2, Group 3, Group 4, Group 5, and Group 6 had the trend of shorter LOS of PICU, and the β value and 95% CI were (β - 0.744; 95% CI - 1.494 to - 0.007, P = 0.052), (β - 1.497; 95% CI - 3.530–0.537, P = 0.149),

(β - 4.332; 95% CI - 5.238 to - 3.426, P < 0.001), (β - 3.053; 95% CI - 3.809 to - 2.297, P < 0.001), (β - 6.28; 95% CI - 7.842 to - 4.721, P < 0.001), respectively. Similar results performed by sensitivity analysis were observed in critically ill children with the age less than 1 year.

Conclusions: This study developed six HDL trajectory subgroups for critically ill children with distinct clinical outcomes. GBTM is a granular method for describing HDL evolution, which may add to the current knowledge of lipid metabolism in critically ill children.

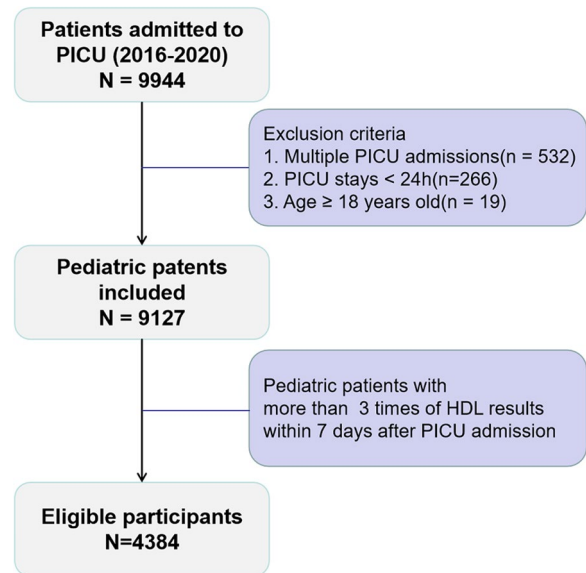

Figure 1 (abstract 000434) Flowchart of eligible participants

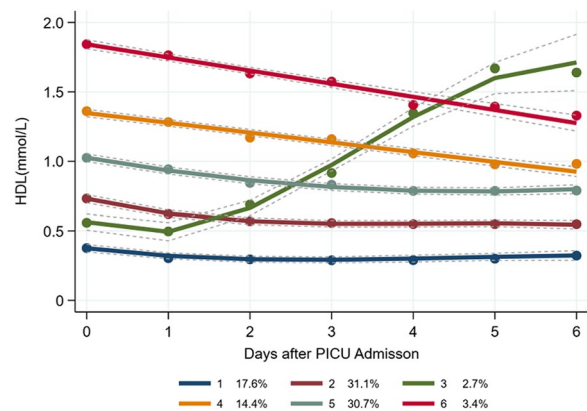

Figure 2 (abstract 000434) HDL trajectory group characteristics in total participants

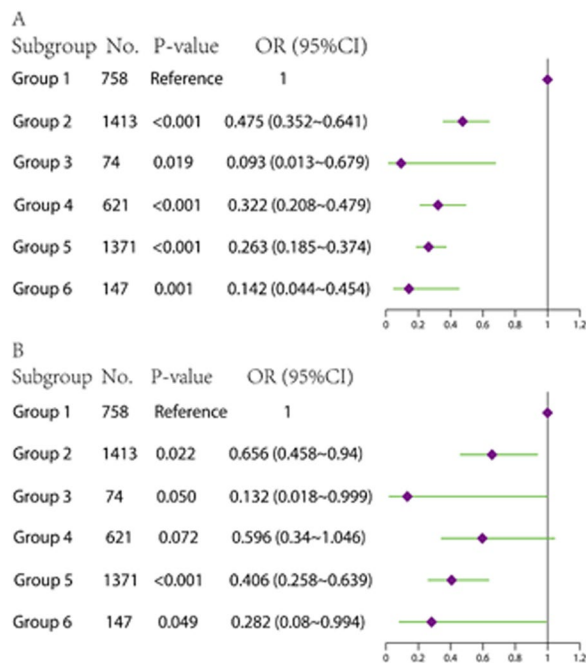

Figure 3 (abstract 000434) Analysis for the association between HDL trajectory subgroups and In-hospital mortality

References

- Tanaka S, Couret D, Tran-Dinh A, et al. High-density lipoproteins during sepsis: from bench to bedside. *Crit Care*. 2020;24(1):134. Published 2020 Apr 7. <https://doi.org/10.1186/s13054-020-02860-3>
- Tanaka S, Diallo D, Delbosc S, et al. High-density lipoprotein (HDL) particle size and concentration changes in septic shock patients. *Ann Intensive Care*. 2019;9(1):68. Published 2019 Jun 13. <https://doi.org/10.1186/s13613-019-0541-8>
- Liu SH, Liang HY, Li HY, Ding XF, Sun TW, Wang J. Effect of low high-density lipoprotein levels on mortality of septic patients: A systematic review and meta-analysis of cohort studies. *World J Emerg Med*. 2020;11(2):109–116. <https://doi.org/10.5847/wjem.j.1920-8642.2020.02.008>
- Guirgis FW, Black LP, Henson M, et al. A hypolipoprotein sepsis phenotype indicates reduced lipoprotein antioxidant capacity, increased endothelial dysfunction and organ failure, and worse clinical outcomes. *Crit Care*. 2021;25(1):341. Published 2021 Sep 17. <https://doi.org/10.1186/s13054-021-03757-5>
- Changaripour S, Sarvazad H, Barghi M, Sajadi E, Sadeghian MH, Roozbahani NE. Lipid profile changes in patients with COVID-19 referred to medical centers in Kermanshah, Iran; a case–control study. *J Int Med Res*. 2022;50(2):3000605221078699. <https://doi.org/10.1177/03000605221078699>
- First of all, thank the organization for providing such an opportunity to share our ideas, and over the course of our research and writing this abstract, I would like to express my thanks to all those who have helped us. I also wish the 36th Annual Congress of ESICM a smooth convening.

Topic: Sepsis

000435

Differences of ventilation distribution between PCV and VCV on EIT during decremental PEEP titration in patients with ARDS: An interim report

T. Nakazawa¹, Y. Shimotani¹, T. Okazaki¹, M. Konaka¹, M. Nabeshima¹, T. Santanda¹, Y. Norisue¹

¹Emergency & Critical Care Medicine, Tokyo Bay Urayasu Ichikawa Medical Center, Urayasu, Japan

Correspondence: T. Nakazawa

Intensive Care Medicine Experimental 2023, **11(Suppl 1)**:000435

Introduction: Electrical impedance tomography (EIT) can detect collapsed and overdistended lung regions and is currently used for PEEP titration. We hypothesized that the results of ventilation distribution on EIT during PEEP titration would be different between pressure control ventilation (PCV) and volume control ventilation (VCV) mainly because of heterogeneity in time-constant among lung regions in a same patient and the difference between individual alveolar inflation as a result of a preset airway pressure and time with less interaction among lung regions, and that as a result of a preset flow rate and volume as a whole lung with more interaction among different lung regions.

Objectives: The aim of this study is to investigate the hypothesis that the transition point of anterior to posterior ventilation ratio (A/P ventilation ratio) from less than 1.0 to greater than 1.0 would be different between PCV and VCV on EIT during PEEP titration.

Methods: Mechanically ventilated patients with ARDS were enrolled in the study. We performed decremental PEEP titration with PCV, VCV with constant flow rate of 50 L/min and/or VCV with decelerating flow with a peak flow rate of 50 L/min during intensive care unit admission. We compared the transition point of A/P ventilation ratio from less than 1.0 to greater than 1.0 detected by EIT with each ventilation mode.

Results: So far, a total of 6 mechanically ventilated patients with ARDS were included. Median age was 71.5 [IQR 68.3–77.6] and median BMI was 24.7 [IQR 23.9–25.9]. Median P/F ratio was 159 [IQR 99.0–213] and median respiratory system compliance was 30.0 [IQR 27.0–40.5] ml/cmH₂O before PEEP titration. Decremental PEEP titration was performed with PCV in all patients, 4 with VCV-constant flow and 3 with VCV-decelerating flow in addition. The transition point was 7.00 [7.00–9.25] cmH₂O with PCV, 10.0 [9.30–11.50] cmH₂O with VCV-constant flow and 7.00 [7.00–8.50] cmH₂O with VCV-decelerating flow. Mean difference of the transition point between PCV and VCV-constant flow was –3.0 cmH₂O (p value=0.07) and 0 cmH₂O (p value=1.0) between PCV and VCV-decelerating flow.

Conclusions: This interim report indicates that ventilation distribution with VCV-constant flow might be more ventrally at the same PEEP compared to PCV in ARDS patients and that the “Best PEEP” determined by EIT might vary among ventilation modes.

References

- None

Topic: Acute respiratory failure and mechanical ventilation

000437

Long-term outcomes of patients who received extracorporeal cardiopulmonary resuscitation (E-CPR) following in-hospital cardiac arrest—an analysis of EXCEL registry data

G. Pound¹, D. Jones¹, G. Eastwood¹, E. Paul¹, C. Hodgson¹

¹School of Public Health and Preventive Medicine, Monash University, Faculty of Medicine, Nursing and Health Sciences, Clayton, Australia

Correspondence: G. Pound

Intensive Care Medicine Experimental 2023, **11(Suppl 1)**:000437

Introduction: The estimated frequency of in-hospital cardiac arrests (IHCA) in Australia and New Zealand is 1.3–6.0 per 1000 hospital admissions [1]. Despite treatment advances, survival rates have only marginally improved, and in-hospital mortality is approximately 75–80% [2]. As such, there is growing interest in the use of novel therapies to improve outcomes of patients who experience IHCA. There has been a tenfold increase in the utilisation of extracorporeal cardiopulmonary resuscitation during cardiac arrests (E-CPR) that are refractory to conventional CPR [3]. Although E-CPR may be associated with increased survival and improved neurological outcomes at hospital discharge [4], there is limited data regarding the long-term outcomes of patients who receive E-CPR following IHCA.

Objectives: To evaluate the functional outcomes of patients who received E-CPR following IHCA at 180-days.

Methods: Secondary analysis of prospectively collected EXCEL registry data. EXCEL is a high-quality, prospective, binational registry of adult

patients who receive extracorporeal membrane oxygenation (ECMO) in Australia and New Zealand. Patients reported to the EXCEL registry who were ≥ 18 years old, received E-CPR following an IHCA and who have 180-day outcome data available were included in this study.

Results: Between 15th February 2019 and 31st August 2022, 113 patients received E-CPR following IHCA (mean age 50.7 ± 13.7 years; 79/113 [69.9%] males). Approximately one third had a shockable arrest rhythm (39/113 [34.5%]), and almost all were witnessed (110/113 [97.3%]) with resuscitation commencing immediately (median no flow time 0 [0, 0] minutes). The median time from IHCA to E-CPR implementation was 40 (29, 56) minutes. Thirty-nine (34.5%) patients survived to hospital discharge and 36 (31.9%) to 180-days. At follow-up, most patients were living at home (29/36 [80.6%]) and had a good functional outcome (modified Rankin Scale (mRS) score ≤ 3 ; 25/36 [69.4%]). However, patients reported higher levels of disability and a worse health-related quality of life (HRQoL) at 180-day follow-up compared to baseline (median WHODAS total disability % score 0.0 [0.0, 8.3] vs. 20.0 [6.0, 35.0], $p < 0.0001$; median EQ5D index 1.000 [0.787, 1.000] vs. 0.773 [0.623, 0.893], $p = 0.003$; median EQ5D VAS 85 [75, 90] vs. 70 [60, 85], $p = 0.027$). In addition, there was a high prevalence of complications reported at 180-days, including reduced lower limb sensation (23/26 [63.9%]), lower limb weakness (19/36 [52.8%]) and memory problems (18/36 [50.0%]).

Conclusions: Approximately one third of patients who received E-CPR following IHCA were alive at 180 days, and most had a good functional outcome. However, patients reported higher levels of disability and a worse HRQoL at 180-days compared to baseline and complications were highly prevalent.

References

4. Gravestiejn BY, Schlupe M, Disli M, et al. Neurological outcome after extracorporeal cardiopulmonary resuscitation for in-hospital cardiac arrest: a systematic review and meta-analysis. *Crit Care*. 2020;24(1):505.
- None
1. Fennessy G, Hilton A, Radford S, Bellomo R, Jones D. The epidemiology of in-hospital cardiac arrests in Australia and New Zealand. *Int Med J* 2016;46:1172–81.
2. Thompson LE, Chan PS, Tang F, et al. Long-Term Survival Trends of Medicare Patients After In-Hospital Cardiac Arrest: Insights from Get With The Guidelines-Resuscitation((R)). *Resuscitation*. 2018;123:58–64.
3. Richardson AS, Schmidt M, Bailey M, et al. ECMO Cardio-Pulmonary Resuscitation (ECPR), trends in survival from an international multicentre cohort study over 12-years. *Resuscitation*. 2017;112:34–40.

Topic: Cardiac arrest

000438

The efficacy and safety of automatic modes during respiratory support after cardiac surgery

R. Komnov¹, A. Eremenko¹, P. Titov¹, S. Gerasimenko¹, A. Urbanov¹, O. Vasileva¹, M. Fominykh¹, E. Koshek¹, A. Goncharova¹, E. Balakin²
¹Cardiac Intensive Care Unit, Petrovsky National Research Center of Surgery, Moscow, Russia; ²Department of Heart Valve Surgery, Petrovsky National Research Center of Surgery, Moscow, Russia

Correspondence: R. Komnov

Intensive Care Medicine Experimental 2023, **11(Suppl 1)**:000438

Introduction: In recent years, there is an active automation of processes in medicine and robotic (Intellectual) ventilation modes are being actively introduced into the daily practice of intensive care units. These modes allow for automated respiratory support, minimizing clinician's involvement. Currently, the most automated mode is INTELLiVENT-ASV (Adaptive Support Ventilation)[®].

Objectives: To compare the effect(s) and safety of full closed loop ventilation and oxygenation INTELLiVENT-ASV mode with closed loop ASV

mode and conventional ventilation modes during respiratory support after uncomplicated cardiac surgery.

Methods: In this randomized controlled trial 40 adult patients were ventilated with INTELLiVENT-ASV[®], 40 with ASV mode and 40 with conventional ventilation modes. Hamilton G5 ventilators were used and 8 physicians were involved into the study. Care of groups were standardized, except modes of postoperative ventilation.

We compared: (1) the physician's workload, through accounting number of manual ventilator settings and time they spent near the ventilator in every group;

(2) evaluation of ventilation safety by considering driving pressure (ΔP), mechanical power, PEEP, tidal volume (Vt) and FiO₂ level;

(3) duration of tracheal intubation in the ICU.

Results: In INTELLiVENT-ASV[®] group the number of manual ventilator settings and physician's time spent near the ventilator before tracheal extubation were significantly lower: 0 (0–0) vs 2 (2–3) (ASV) and 4 (3–5) (control group), and 35 (27–45) sec vs 99 \pm 35 s (ASV) vs 164 \pm 69 s (control group) respectively (median (25%-75% quartile), $p < 0.0001$ in all cases).

Duration of respiratory support in the ICU were significantly shorter in the INTELLiVENT-ASV group: 226 \pm 31 vs 259 \pm 66 (ASV) and 271 \pm 78 min (control) (mean \pm SD, $p = 0.0042$) and time on spontaneous ventilation (without any mandatory breaths) were significantly longer in INTELLiVENT-ASV[®] group: 90 (75–103) vs 80 (60–110) (ASV) vs 60 (60–105) (control) min ($p = 0.0462$).

INTELLiVENT-ASV[®] provided a significantly more protective ventilation through reduction in the driving pressure, tidal volume, FiO₂ and PEEP levels, but without differences between paO₂/FiO₂ ratio and mechanical power. ΔP and Vt on mechanical ventilation were significantly lower in INTELLiVENT group: ΔP was 6 (6–7) cmH₂O vs 6 (6–7) (ASV) and 7 (7–9) (control) cmH₂O ($p < 0.0001$ in all cases); Vt was 6 (6–7) vs 7 (6–7) (ASV) and 7 (7–8) (control) ml/kg/PBW ($p < 0.0001$ in all cases). PEEP and FiO₂ level on mechanical ventilation were also significantly lower in INTELLiVENT group: PEEP was 5 (5–7) cmH₂O vs 8 (7–10) (ASV) and 7 (6.5–9) (control) cmH₂O and FiO₂ level was 26 (24–30) vs 34 (30–35) (ASV) and 34 (30–38) (control) %, respectively ($p < 0.0001$ in all cases).

There were no significant differences between the groups in paO₂/FiO₂ ratio during all the phases of respiratory support and after extubation of trachea, and also there were no differences in mechanical power level, frequency of undesirable events (patient–ventilator asynchrony, patient's anxiety) during respiratory support and duration of ICU stay.

Conclusions: Application of intellectual technologies after uncomplicated cardiac surgery gives the opportunity for interactive personalization of respiratory support and provides more protective mechanical ventilation and reduces the physician's workload without compromising the quality of respiratory support and safety of patients.

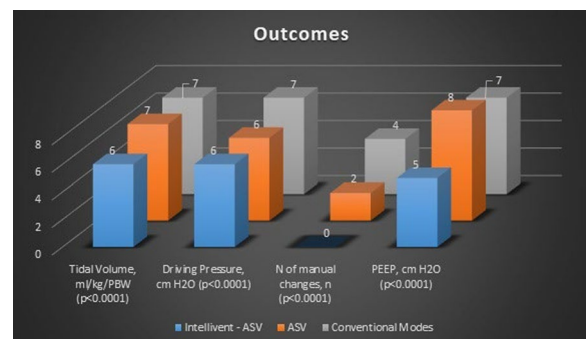

Topic: Acute respiratory failure and mechanical ventilation

000440

The role of CD39-A2aR pathway in mediating the crosstalk between endothelial cells and natural killer cells in sepsis-associated lung

Y. Tang¹

¹Jiangsu Provincial Key Laboratory of Critical Care Medicine, Department of Critical Care Medicine, Zhongda Hospital, School of Medicine, Southeast University, Nanjing, China

Correspondence: Y. Tang

Intensive Care Medicine Experimental 2023, **11(Suppl 1)**:000440.

Introduction: Sepsis is a common clinical critical care disease, and the lung is the most vulnerable organ during sepsis. How to reduce sepsis-associated lung injury is a clinical problem that needs to be solved urgently. While the contribution of neutrophils or macrophages to sepsis is well documented, the role of NK cells, which are critical innate immune cells, remains controversial. Some studies demonstrated that increasing the number of NK cells or enhancing their function was beneficial for controlling infection and reducing mortality in sepsis, while other studies showed that removing NK cells could reduce septic mortality. Furthermore, the function of NK cells in sepsis-associated lung injury needs exploration.

Objectives: Our study aimed to confirm the role of NK cells in sepsis-associated lung injury and the underlying mechanisms.

Methods: We conducted a monocentric, retrospective, and observational study to clarify the impact of NK cell count on the prognosis of sepsis. Mice were administered with α NK1.1 (PK136) to deplete NK cells. Single-Cell RNA Sequencing was used to explore the interaction between each cell type and NK cells in septic mice. Mouse pulmonary microvascular endothelial cells were stimulated with LPS or not to produce inflammatory extracellular vesicles (LPS-EVs) or control extracellular vesicles (Con-EVs). A lentiviral vector selectively expressing NTPDase-1 (CD39) (LV-*Entpd1*) and its control (LV-Con) were generated. Mouse pulmonary microvascular endothelial cells were treated with LV-*Entpd1* or LV-Con to produce CD39-overexpressing EVs or Control EVs. Mice were intravenously injected with LPS-EVs/Con-EVs or CD39-overexpressing EVs/Control EVs. Western blot or qRT-PCR was applied to assess the expression level of CD39. Multicolor flow cytometry was used to evaluate the amount of activating receptors or inhibitory receptors on NK cells. The lung injury was scored by hematoxylin–eosin (H&E) staining.

Results: Septic patients with low NK cell counts had significantly higher mortality than those with high NK cell counts, and that patients with sepsis associated acute respiratory distress syndrome (ARDS) had significantly lower NK cell counts than those without ARDS, suggesting that low NK cell counts in sepsis may aggravate lung injury. To confirm the role of NK cells in sepsis, we applied α NK1.1 (PK136) to deplete NK cells 24 h after cecum ligation and puncture (CLP). Depletion of NK cells after CLP significantly reduced survival rate. Then, we used single cell sequencing to explore the interaction between each cell type and NK cells in sepsis, and found that the NTPDase-1 (CD39)-A2aR pathway between lung endothelial cells and natural killer cells was significantly upregulated after CLP. Further studies showed that the septic pulmonary microvascular endothelial cells could release CD39+ small extracellular vesicles (sEVs) to target NK cells and damage their functions.

Conclusions: In conclusion, we found that pulmonary vascular endothelial cells could release CD39+ sEVs to target A2aR of NK cells, thus damage the functions of NK cells to aggravate lung injury in sepsis-associated lung injury. Our studies discover a crosstalk between endothelial cells and natural killer cells, and provide prospective approaches for evaluating the prognosis of sepsis and exploring therapeutic strategies of sepsis-associated lung injury.

References

1. The present study was supported by grants from National Natural Science Foundation of China (82003735).

Topic: Sepsis

000443

Pendelluft in patients with acute respiratory distress syndrome during trigger and reverse triggering breaths

C. W. Chen¹, W. C. Lin¹

¹Division of Critical Care Medicine, Department of Internal Medicine, National Cheng Kung University Hospital, Tainan, Taiwan

Correspondence: C. W. Chen

Intensive Care Medicine Experimental 2023, **11(Suppl 1)**:000443

Introduction: Pendelluft occurs in patients with acute respiratory distress syndrome (ARDS) during spontaneous breaths. Quantifying pendelluft in ARDS patients has not been performed before. We combined electrical impedance tomography (EIT) and respiratory mechanics monitoring to quantitatively examine pendelluft in trigger and reverse triggering breaths in mechanically ventilated patients with ARDS.

Methods: EIT and respiratory mechanics measurements were analyzed in 20 mechanically ventilated patients with ARDS during transitioning from controlled to spontaneous breaths following discontinuance of neuromuscular blocking agents under volume-cycled ventilation. Breath selection was based on 4 levels of esophageal pressure swing (Δ Pes). These were rest (0 cmH₂O, breaths=200), low (<5 cmH₂O, breaths=471), moderate (\geq 5, <10 cmH₂O, breaths=906), and high effort (\geq 10 cmH₂O, breaths=565). A total of 2142 breaths were analyzed (around 20% of a total of 5155 trigger breaths and 3518 reverse triggering breaths counted besides rest breaths). Quantitation of pendelluft was calculated according to the method proposed by Coppadoro et al¹.

Results: The pendelluft response to breathing efforts varied and was significantly greater in trigger versus reverse triggering breaths (3.9 ± 6.8 vs 1.9 ± 2.8 ml, respectively, $p < 0.0001$). There were two distinct patterns of effort-related pendelluft (high vs. low pendelluft group) in trigger and reverse triggering breaths based on pendelluft- Δ Pes slope (ml/cmH₂O). For trigger breaths, high pendelluft group ($n=9$, slope 0.7 to 2.4 ml/cmH₂O) was significantly associated with lower peak airway/plateau pressure (30.5 ± 3.2 vs $36.5 \pm 1.8/20.8 \pm 2.6$ vs 25.2 ± 2.0 cmH₂O; $p < 0.01$) and lower lung elastance (19.4 ± 7.9 vs 31.8 ± 8.6 cmH₂O/L; $p < 0.01$) than low pendelluft group ($n=11$, slope -0.1 to 0.3 ml/cmH₂O). For reverse triggering breaths, there was no difference in respiratory mechanics between high ($n=4$, 0.49 to 2.53 ml/cmH₂O) and low pendelluft ($n=12$, -0.22 to 0.25 ml/cmH₂O) groups. The prediction of pendelluft by Δ Pes was characterized by a low positive predictive value. ARDS cases with high effort-related pendelluft were uncommon. The prediction of pendelluft was not significant in reverse triggering breaths.

Conclusions: Effort-related pendelluft should be individualized. Pendelluft is higher in trigger breaths than reverse triggering breaths. For trigger breaths, high pendelluft is likely to occur in ARDS patients with lower lung elastance and lower peak airway/plateau pressure. However, ARDS cases with high effort-related pendelluft were uncommon in our study population.

References

1. MOST 108-2314-B-006-069
2. Coppadoro A, Grassi A, Giovannoni C, Rabbioni F, Eronia N, Bronco A, Foti G, Fumagalli R, Bellani G: Occurrence of pendelluft under pressure support ventilation in patients who failed a spontaneous breathing trial: an observational study. *Ann Intensive Care* 2020, **10**(1):39.

Topic: Acute respiratory failure and mechanical ventilation

000445

Role of urinary biomarkers TIMP-2 and IGFBP7 in predicting acute kidney injury in critically ill trauma patients—a prospective observational study

M. Parthiban¹, A. Cherian², P. Kundra², M. Senthilnathan², P. S. Priyamvada³, Z. Bobby⁴

¹Critical Care Medicine, Kovai Medical Centre and Hospital, Coimbatore, India; ²Anaesthesiology and Critical Care, Jawaharlal Institute of Postgraduate Medical Education and Research, Puducherry, India;

³Nephrology, Jawaharlal institute of Postgraduate Medical Education and Research, Puducherry, India; ⁴Biochemistry, Jawaharlal Institute of Postgraduate Medical Education and Research, Puducherry, India

Correspondence: M. Parthiban

Intensive Care Medicine Experimental 2023, **11(Suppl 1)**:000445

Introduction: The incidence of Acute Kidney Injury (AKI) among trauma patients ranges from 15 to 50%. Hence, early identification of trauma patients who are at risk of developing AKI and implementation of appropriate reno-protective strategies may improve their outcomes. Urinary TIMP-2 and IGFBP7 have been studied in varying clinical scenarios to predict AKI with reasonable accuracy. However, their role has not been validated in critically ill trauma patients. Hence, this study was designed to evaluate the product of urinary markers (TIMP-2) × (IGFBP7) to accurately detect the sub-group of critically ill trauma patients at high risk for developing AKI.

Methods: This trial was designed as a prospective observational study at JIPMER, India. All critically ill trauma patients admitted to the critical care unit (CCU), with age > 18 years and < 65 years were screened for eligibility. Patients who met eligibility were observed for the occurrence of AKI throughout the hospital stay. Injury severity score (ISS), Acute Physiology and chronic health evaluation score (APACHE II) of all patients were calculated at admission and noted. At admission, and 24 h post CCU admission, urine samples were collected for analysis. The urinary levels of TIMP-2 and IGFBP-7 were estimated using commercially available ELISA-based kits (Abbkine Scientific Co; Ltd. China, and BioAssay laboratory technology, China). These values were used to predict AKI within 12 h of the last measurement and the need for RRT in those patients. During the first 24 h, details regarding total fluid intake, blood product transfusions, blood loss, and urine output were collected. Lowest blood pressure (systolic, diastolic, and mean arterial pressure), the need for vasopressors, mechanical ventilation, cardiopulmonary resuscitation (CPR), co-morbidities within the first 24 h were also noted.

Results: A total of 79 patients were enrolled in the study, of them 14 developed AKI (as per KDIGO criteria). The median APACHE II scores for those with AKI and without AKI were 11 (7–18) and 9 (7–11), respectively. While ISS score for AKI and without AKI were 34 (25–34) and 25 (25–34), respectively. The ROC-AUC for urinary (TIMP-2) × (IGFBP-7) were 0.49 (95% CI: 0.32 to 0.67) and 0.57 (95% CI: 0.42 to 0.71) at 0 and 24 h, respectively. As only the levels at 24 h showed discriminating power, a cut-off of 0.008 (ng/ml) 2/1000 was chosen, which had a sensitivity and specificity of 85.71% (95% CI: 57.19% to 98.22%) and 27.69% (95% CI: 17.31% to 40.19%), respectively. (Figure 1) The negative predictive value (NPV) and positive predictive value (PPV) were 90% (95% CI: 70.17% to 97.18%) and 20.34% (95% CI: 16.43% to 24.90%), respectively. All other variables were similar in patients with or without AKI.

Conclusions: We hereby conclude that Urinary [TIMP-2] × [IGFBP7] measured 24 h post admission in critically ill trauma patients can predict patients at risk of AKI with sufficient sensitivity.

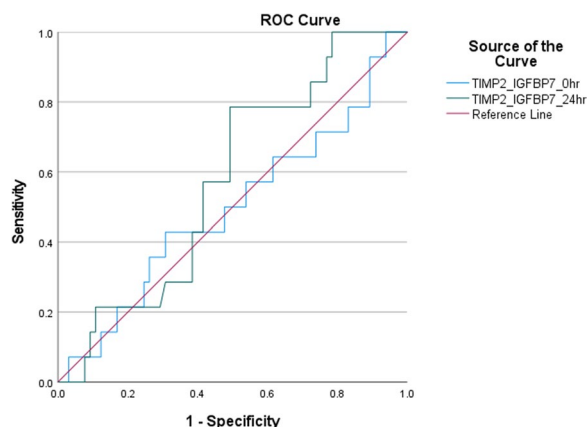

Figure 1 (abstract 000445) ROC-AUC for (TIMP-2) × (IGFBP-7) at 0 and 24 h of admission

References

- Gunnerson KJ, Shaw AD, Chawla LS, Bihorac A, Al-Khafaji A, Kashani K, et al. TIMP2-IGFBP7 biomarker panel accurately predicts acute kidney injury in high-risk surgical patients. *J Trauma Acute Care Surg.* 2016;80:243–9.
- Bihorac A, Chawla LS, Shaw AD, Al-Khafaji A, Davison DL, Demuth GE, et al. Validation of cell-cycle arrest biomarkers for acute kidney injury using clinical adjudication. *Am J Respir Crit Care Med.* 2014;189:932–9.
- Intramural fund for postgraduate research at Jawaharlal Institute of Postgraduate Medical Education and Research, Puducherry, India

Topic: Acute Kidney Injury and haemofiltration

000447

The role of the United Kingdom National Poisons Information Service (NPIS) in the diagnosis of death according to neurological criteria in poisoned and non-poisoned patients

L. Cohen¹, J. Worthington², I. Thomas², L. Gray³

¹Intensive Care, University Hospital of Wales, Cardiff, United Kingdom;

²Intensive Care, North Bristol NHS Trust, Bristol, United Kingdom;

³National Poisons Information Unit (Cardiff Unit), University Hospital Llandough, Llandough, United Kingdom

Correspondence: J. Worthington

Intensive Care Medicine Experimental 2023, **11(Suppl 1)**:000447

Introduction: The United Kingdom (UK) National Poisons Information Service (NPIS) is a 24-h service led by consultant clinical toxicologists, offering advice and guidance for healthcare professionals on the management of poisoning including access to the poisons information database, TOXBASE. (1) The diagnosis of death has important medical, legal and societal implications, making it imperative that its determination is accurate, reliable and certain. The Academy of the Medical Royal Colleges (AoMRC) Code of Practice for the Diagnosis of Death requires that when confirming death according to neurological criteria the exclusion of reversible causes of apnoea and coma prior to undertaking clinical tests to determine if brainstem function is present is required (2). Specifically, it requires the exclusion of any clinical effect attributable to a wide range of drugs including narcotics, hypnotics, sedatives and tranquilisers. Data summarising enquiries made to NPIS relating to the diagnosis of death in poisoned and non-poisoned patients has previously been published. (3) We undertook a retrospective analysis of the NPIS database to examine as to why the NPIS was contacted with reference to confounding factors affecting the ability to undertake neurological death testing.

Objectives: To examine the reasons why the NPIS was contacted for guidance where neurological death testing was being planned in poisoned and non-poisoned patients.

Methods: Using the database, enquiries to the NPIS in the preceding 10 years (01/01/2013–31/12/2022) were collated retrospectively using the search terms 'brain dead', 'brain death', 'brain stem', 'brainstem' or 'stem testing'. The data was analysed and any duplications or incongruous cases were deleted from the data set. Toxicological injury was defined as a case where the exposure to a xenobiotic was the cause of the current morbidity. This included direct effects of the xenobiotic and sequelae of the poisoning such as hypoxic ischaemic encephalopathy (HIE). Non-toxicological injury was defined as a case where the primary cause was not due to exposure to a xenobiotic; contact with the NPIS was made in regard to medications being used therapeutically and their potential effect on brain-stem function.

Results: The original search retrieved 136 enquiries of which 96 were deemed relevant. Enquiries were toxicological in 85 patients and non-toxicological in 11. Reasons for consulting the NPIS (more than one were allowed per case) were regarding: how the presence of agents affected brainstem reflex tests (n=37); kinetics and metabolism of drugs (n=26); toxicological causes of brainstem signs (n=17); requests for laboratory analysis (n=14); interpretation of quantitative analytical results (n=4); suitability for organ donation (n=4); and advice regarding withdrawal of active treatment (n=4). The median age of the toxicological group was 35.5 years (IQR 24–44), 49% were male. Agents involved were: single drug of abuse (n=12), single

prescribed drug (n = 18), mixed prescription drugs (n = 16), toxic alcohol (n = 12), multiple drugs of abuse (n = 7), combination of prescription drugs and drugs of abuse (n = 6), other (n = 7), and unknown (n = 7). Cocaine (n = 7), and Heroin (n = 5) were the most commonly implicated drugs of abuse, whilst in the prescribed drug group, antidepressants: Amitriptyline (n = 8), Citalopram (n = 4), Sertraline (n = 3), Venlafaxine (n = 2), and Mirtazepine (n = 2) were the most common. The median age of the non-toxicological group was 43.5 years IQR (25.25–57.5); 44% were male. The causes of brainstem injury were: traumatic brain injury (n = 5), stroke (n = 1), subarachnoid haemorrhage (n = 1), status epilepticus (n = 1), hypoxic ischaemic encephalopathy (n = 2), and meningitis (n = 1).

Conclusions: The NPIS remains a valuable centralised resource of expert advice regarding management of the poisoned and non-poisoned patient in the context of severe neurological injury and in the diagnosis of death using neurological criteria. The frequency and nature of such enquiries varied over time. The reasons for this are likely multifactorial and may take into account a number of socioeconomic, legal and health care related factors.

The introduction of cerebral CT angiography as an ancillary investigation to support the diagnosis of death using neurological criteria may change the nature of interactions between clinicians and NPIS in the future (4).

References

1. The National Poisons Information Service <<https://www.npis.org>> accessed 13th April 2023
4. Thomas EO, Manara A, Dineen RA, et al. The use of cerebral computed tomographic angiography as an ancillary investigation to support a clinical diagnosis of death using neurological criteria: a consensus guideline. *Anaesthesia* 2023. Epub 29 January. <https://doi.org/10.1111/anae.15950>.
3. Moyns E et al. 'The role of the UK National Poisons Information Service (NPIS) in the diagnosis of death in poisoned and non-poisoned patients' (2018): *Clinical Toxicology*, 75, p. 485. <<https://doi.org/10.1080/15563650.2018.1457818>>
2. Academy of Medical Royal Colleges. A Code of Practice for the Diagnosis and Confirmation of Death. Academy of Medical Royal Colleges. 2008. <www.aomrc.org.uk/reports-guidance/ukdec-reports-and-guidance/code-practice-diagnosis-confirmation-death> accessed 16th April 2023.

Topic: Poisoning/Toxicology/Pharmacology

000448

Physiological effects of awake prone position in moderate-to-severe acute hypoxemic respiratory failure

T. Rosà¹, D. L. Grieco¹, L. Delle Cese¹, L. S. Menga¹, T. Michi¹, G. Lombardi¹, M. Cesarano¹, V. Giammatteo¹, G. Bello¹, S. Carelli¹, S. L. Cutuli¹, C. Sandroni¹, G. De Pascale¹, A. Pesenti², S. Maggiore³, M. Antonelli¹
¹Scienze dell'emergenza, anesthesiologiche e della rianimazione, Fondazione Policlinico Universitario A. Gemelli, Roma, Italy; ²Department of Pathophysiology and Transplantation, University of Milan, Milano, Italy; ³Anesthesiology, D'Annunzio University of Chieti–Pescara, Chieti, Italy

Correspondence: T. Rosà

Intensive Care Medicine Experimental 2023, **11(Suppl 1)**:000448

Introduction: Awake prone position has been proposed for nonintubated patients with acute hypoxemic respiratory failure to improve oxygenation [1–4]. Although two studies showed that awake prone positioning in patients with hypoxemia due to COVID-19 reduces intubation rate and possibly mortality [5, 6], other data did not confirm these findings, highlighting possible risks related to intubation delays due to only transient oxygenation improvements [7].

Objectives: Few studies address the physiological effects of prone position in spontaneously breathing humans with acute hypoxemic respiratory failure receiving high-flow nasal oxygen (HFNO).

Methods: Fifteen patients with moderate-to-severe hypoxemia (PaO₂/FiO₂ < 200 mmHg) received HFNO for 1 h in supine position and 2 h in

prone position, followed by a final 1-h supine phase. For each study phase the following parameters were measured: arterial blood gases; inspiratory effort (ΔPES), transpulmonary driving pressure (ΔPL), respiratory rate and esophageal pressure simplified pressure–time product per minute (sPTPES) by esophageal manometry; tidal volume (VT), end-expiratory lung impedance (EELI), lung compliance, dynamic strain (VT/EELI), airway resistance, expiratory time constant and pendelluft extent through electrical impedance tomography.

Results: Results concerning comparisons between supine, prone and supine after proning are displayed in Figure 1, 2 and 3. Compared to supine position, prone position improved PaO₂/FiO₂ (median [interquartile range] 104 mmHg [76–129] vs. 74 [69–93], p < 0.001), reduced respiratory rate (24 breaths/min [22–26] vs. 27 [26–30], p = 0.05) and increased ΔPES (12 cmH₂O [11–13] vs. 9 [8–12], p = 0.04) with similar sPTPES and ΔPL. Airway resistance and expiratory time constant were higher in prone vs. supine position (9 cmH₂O*sec*arbitrary units-3 [4–11] vs. 6 [4–9], p = 0.05; 0.53 s [0.32–61] vs. 0.40 [0.37–0.44], p = 0.05). Prone position increased EELI (3887 arbitrary units [3414–8547] vs. 1456 [959–2420], p = 0.002) without affecting VT and lung compliance: this yielded lower dynamic strain (0.21 [0.16–0.24] vs. 0.38 [0.30–0.49], p = 0.004). Pendelluft was not different between study phases.

Conclusions: Prone position improves oxygenation, increases EELI and does not affect VT, ΔPL, lung compliance and pendelluft extent: this yields reduced dynamic strain. Prone position reduces respiratory rate but increases ΔPES because of higher airway resistance with prolonged expiratory time.

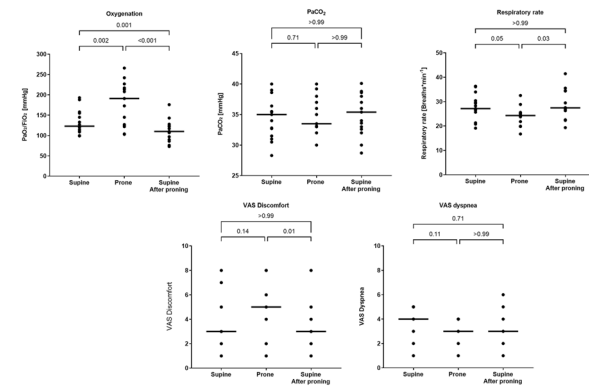

Figure 1 (abstract 000448) Individual patient values and medians of PaO₂/FiO₂, PaCO₂, respiratory rate, and VAS-measured patient dyspnea and discomfort during the three phases of the study

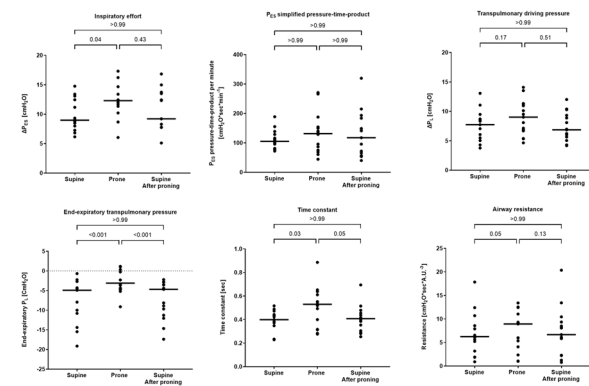

Figure 2 (abstract 000448) Individual patient values and medians of esophageal pressure inspiratory swings (ΔPES), simplified pressure-time product of the esophageal pressure per minute (PTPES), quasi-static transpulmonary pressure (ΔPL), end-expiratory transpulmonary

pressure, time constant and airway resistance during the three phases of the study

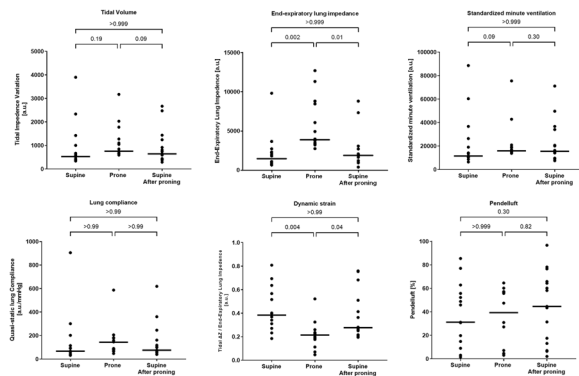

Figure 3 (abstract 000448) Individual patient values and medians of Tidal Impedance Variation, End-Expiratory Lung Impedance (EELI), standardized minute ventilation, lung compliance, dynamic strain and Pendelluft extent during the three phases of the study

References

1. This study was supported by a grant by ESICM (2017 Draeger award) and by departmental sources.
2. Elharrar X, Trigui Y, Dols A-M, et al. (2020) Use of Prone Positioning in Nonintubated Patients With COVID-19 and Hypoxemic Acute Respiratory Failure. *JAMA* 323:2336–2338. <https://doi.org/10.1001/jama.2020.8255>
3. Menga LS, Berardi C, Ruggiero E, et al. (2022) Noninvasive respiratory support for acute respiratory failure due to COVID-19. *Curr Opin Crit Care* 28:25–50. <https://doi.org/10.1097/MCC.0000000000000902>
4. Scaravilli V, Grasselli G, Castagna L, et al. (2015) Prone positioning improves oxygenation in spontaneously breathing nonintubated patients with hypoxemic acute respiratory failure: A retrospective study. *J Crit Care* 30:1390–1394. <https://doi.org/10.1016/j.jcrc.2015.07.008>
5. Perez-Nieto OR, Escarraman-Martinez D, Guerrero-Gutierrez MA, et al. (2022) Awake prone positioning and oxygen therapy in patients with COVID-19: The APRONOX study. *European Respiratory Journal* 59: <https://doi.org/10.1183/13993003.00265-2021>
6. Ehrmann S, Li J, Ibarra-Estrada M, et al. (2021) Awake prone positioning for COVID-19 acute hypoxaemic respiratory failure: a randomised, controlled, multinational, open-label meta-trial. *Lancet Respir Med* 9:1387–1395. [https://doi.org/10.1016/S2213-2600\(21\)00356-8](https://doi.org/10.1016/S2213-2600(21)00356-8)
7. Alhazzani W, Parhar KKS, Weatherald J, et al. (2022) Effect of Awake Prone Positioning on Endotracheal Intubation in Patients With COVID-19 and Acute Respiratory Failure: A Randomized Clinical Trial. *JAMA* 327:2104–2113. <https://doi.org/10.1001/jama.2022.7993>
8. Coppo A, Bellani G, Winterton D, et al. (2020) Feasibility and physiological effects of prone positioning in non-intubated patients with acute respiratory failure due to COVID-19 (PRON-COVID): a prospective cohort study. *Lancet Respir Med* 8:765–774. [https://doi.org/10.1016/S2213-2600\(20\)30268-X](https://doi.org/10.1016/S2213-2600(20)30268-X)
9. Lehingue S, Allardet-Servent J, Ferdani A, et al. (2022) Physiologic Effects of the Awake Prone Position Combined With High-Flow Nasal Oxygen on Gas Exchange and Work of Breathing in Patients With Severe COVID-19 Pneumonia: A Randomized Crossover Trial. *Crit Care Explor* 4:e0805. <https://doi.org/10.1097/CCE.0000000000000805>
10. Chiumello D, Chiodaroli E, Coppola S, et al. (2021) Awake prone position reduces work of breathing in patients with COVID 19 ARDS supported by CPAP. *Ann Intensive Care*. <https://doi.org/10.1186/s13613-021-00967-6>
11. Cammarota G, Rossi E, Vitali L, et al. (2021) Effect of awake prone position on diaphragmatic thickening fraction in patients assisted by noninvasive ventilation for hypoxemic acute respiratory failure related to novel coronavirus disease. *Crit Care* 25:1–10. <https://doi.org/10.1186/s13054-021-03735-x>

Topic: Acute respiratory failure and mechanical ventilation

000449

Clinical-epidemiological characteristics and risk factors for mortality in critically ill COVID-19 patients in Spain. A nationwide study based on National Hospital Discharge Records Database

A. Corbato Garcia¹, C. Risco Risco², L. E. Benitez Garzon¹, L. Pérez Bastida¹, M. Alvarez Torres¹, S. Barakat Fernández¹, M. Ortega Sáez¹, F. J. Manuel Merino¹, A. González Salamanca¹, A. Alvarez Ruiz¹, E. Domínguez Pardo³, E. Lopez Ramos⁴, D. Andaluz Ojeda¹

¹Intensive Care, General Hospital Río Carrión, Palencia, Spain; ²Internal Medicine, HM Sanchinarro University Hospital, Madrid, Spain; ³Intensive care, HM Sanchinarro University Hospital, Madrid, Spain; ⁴Medicina intensiva, Hospital Universitario Príncipe de Asturias, Meco, Spain

Correspondence: A. Corbato Garcia

Intensive Care Medicine Experimental 2023, **11(Suppl 1)**:000449

Introduction: COVID-19 emerged in 2020 as a novel disease associated with a high morbidity and mortality generating an overload in most ICUs around the world. It is necessary to analyze clinical and epidemiological characteristics of these patients to define risk factors and their outcome. We analyzed epidemiological and clinical features of all critically ill COVID-19 patients hospitalized in Spain along the first three pandemic waves, as well as risk factors predictors of hospital mortality.

Methods: Analysis of the National Hospital Discharge Records Database (NHDRD) of patients hospitalized with diagnosis of COVID-19 who required ICU admission. Demographic and clinical features and their relationship with clinical outcomes were analyzed. We performed a descriptive and a multivariate analysis to identify those risk factors related with fatal evolution in this population. Statistical package STATA v16.1 was employed.

Results: 22,957 critically ill patients were registered. ICU mortality was 31%, 62% of these patients were over 60 years old (mortality rate 41%). The main comorbidities were hypertension (45%, 38% mortality rate), dyslipidemia (31%, 34% mortality rate), DM (24%, 37% mortality rate) and obesity (19%, 28% mortality rate). Charlson Comorbidity Index ≥ 2 showed a mortality rate of 48%. Mechanical ventilation (MV) was required in 59% and SDRA were present in 28% with 39 and 40% of mortality respectively. Sepsis was presented in 14% (mortality rate 63%) and AKI was present in 25% (mortality rate 56%). Multivariate analysis identify age as independent risk factor for mortality along with comorbidities related to endothelial dysfunction and immunosuppression such as obesity, diabetes, artery disease, HIV, cancer, hematological malignance. Finally multivariate analysis identified presence of sepsis, AKI or need of MV were two independent risk factor associated with mortality. Combination of these last variables predicted mortality with an AUROC >0.90.

Conclusions: Mortality rate in critically ill COVID-19 Spanish patients in 2020 was very high. Age, states of immunosuppression and cardiovascular risk factors were the main risk factors associated with mortality. The need for MV and the presence of sepsis or AKI were independently conditions associated with a fatal prognosis.

Table 1 (abstract 000449) Risk factors associated with mortality in critically ill COVID-19 patients

	HR	IC 95%	P
AGE	1,57	1,53-1,62	0,000
OBESITY	1,18	1,10-1,27	0,000
HIV	2,22	1,36-3,64	0,001
DM	1,28	1,12-1,47	0,000
PERIPHERAL ARTERY DISEASE	1,23	1,09-1,40	0,001
SOLID CANCER	1,32	1,11-1,57	0,002
HEMATOLOGICAL MALIGNANCIES	1,34	1,14-1,59	0,001
METASTATIC CANCER	1,39	1,05-1,84	0,022
CEREBROVASCULAR DISEASE	1,51	1,30-1,76	0,000
ACIDOSIS	1,56	1,45-1,69	0,000
AKI	1,66	1,56-1,76	0,000
LIVER DISEASE	1,10	1,02-1,20	0,019
SEPSIS	1,43	1,34-1,53	0,000
MECHANICAL VENTILATION	1,65	1,54-1,76	0,000

Topic: Infections and prevention

000450

Lung ultrasonography can predict responsiveness to prone positioning in COVID19 ARDSS. Patsilina¹, E. Bourgani¹, C. Merkouri¹, M. Poulou¹, E. Dikoudi¹, V. Karaouli¹, M. Karagianni¹, A. Aiginitou¹, E. Kourtelesi¹, M. Daganou¹, A. Flevari¹¹New ICU Department, Sotiria Thoracic Diseases Hospital, Athens, Greece**Correspondence:** A. Flevari*Intensive Care Medicine Experimental* 2023, **11(Suppl 1)**:000450

Introduction: Prone positioning is a well validated therapeutic strategy in the treatment of Acute Respiratory Distress Syndrome (ARDS) in adults. Its application leads to improvement in PaO₂/FiO₂ (P/F) ratio and mortality reduction. Moreover, lung ultrasonography (LU) in critically ill patients is a useful point-of-care imaging method for the assessment of various thoracic pathologies.

Objectives: To examine if LU is able to predict prone positioning responsiveness in COVID19-associated ARDS (C-ARDS).

Methods: This prospective study was conducted in a 13-bed capacity ICU. Age, sex, Body Mass Index (BMI), disease severity scores APACHE II and SOFA were recorded on admission day. Alterations in FiO₂, Driving Pressure (DP), static Compliance (Cst) and Lung Ultrasound Score (LUS) between supine and prone positions were recorded at bedside. The effectiveness of the strategy was also recorded. Kolmogorov-Smirnov test checked normality. Paired two-sample t-test examined equality of the means. Multiple linear regression tested for differences in the means between categorical and continuous variables.

Results: Fifteen (15) intubated patients (8 male) with P/F ratio < 150 were included. Mean Age was 62.18 (± 16.68) years, mean BMI was 30.82 (± 5.93), mean APACHEII score was 15.64 (± 7.24) and mean SOFA was 6.09 (± 2.77). Table 1 states that there was significant improvement of all parameters examined in prone position compared to supine. We investigated whether all 4 variables stated in Table 1 could predict success of proning. The model explained 62% of variance and was a significant predictor of proning success [F(4,10) = 4.06, p = 0.033]. Among variables, only ΔLUS could effectively predict proning success (B = -0.07, p = 0.027), while others could not (ΔFiO₂ p = 0.43, Δcst p = 0.02, ΔDP p = 0.54).

Table1 (abstract 000450) Paired sample T-test results between supine and prone position

	T (14)	p-value
ΔFiO ₂	6.97	0.000
ΔCst	-4.06	0.001
ΔDP	2.86	0.013
ΔLUS	3.40	0.004

Conclusions: Bedside LUS, a point-of-care imaging tool, seems to have predictive value in the success of proning in patients with ARDS.

References

1. Guerin C, et al. Prone Positioning in Severe Acute Respiratory Distress Syndrome. *New Engl J Med.* 2013;368(23):2159–68. 2. Haddam M, et al. Lung ultrasonography for assessment of oxygenation response to prone position ventilation in ARDS. *Intensive Care Med.* 2016;42(10):1546–56. 3. Heldeweg MLA et al. Lung ultrasound to predict gas-exchange response

to prone positioning in COVID-19 patients: A prospective study in pilot and confirmation cohorts *J Crit Care* 2023; 73:154173

Topic: Acute respiratory failure and mechanical ventilation

000451

Tracheostomy in mechanically ventilated patient with ARDS by SARS CoV2: outcomes in reference center in Mexico CityM. Vidals-Sánchez¹, J. C. Gasca-Aldama¹, N. V. Alva-Arroyo², L. Mayo-Hernandez¹, M. A. Amezcua-Gutiérrez¹, J. Garduño-López¹, M. Mendoza-Martinez¹, F. Ordoñez-Hernandez¹¹Intensive Care Unit, Hospital Juárez de México, Ciudad de México, Mexico; ²Intensive Care Unit, Hospital Angeles Mocol, Ciudad de México, Mexico**Correspondence:** M. Vidals-Sánchez*Intensive Care Medicine Experimental* 2023, **11(Suppl 1)**:000451

Introduction: Percutaneous tracheostomy is one of the most frequently performed techniques in the intensive care unit (ICU), with great relevance during the SARS CoV2 pandemic. The most common indication remains the need for prolonged ventilation.

Objectives: To determine mortality in patients undergoing percutaneous tracheostomy vs. patients undergoing the Weaning protocol.

Methods: Non-randomized, descriptive clinical trial, 179 patients divided into 2 groups: tracheostomy group and non-tracheostomy group. The sample size was calculated with the formula for the estimation of two means, power of 80%, an error of 0.05, with a CI 95%. Variables with statistical significance were subjected to Cox correlation, ending with a Kaplan Meier curve or graph, calculating the Long Rank. Assigning a value of p < 0.05 as statistically significant. SPSS v25 was used for data analysis.

Results: Lower mortality, statistically significant, in patients with tracheostomy with the following risk factors: body mass index (BMI) and days of stay in the ICU. In a timely manner, patients with a higher BMI had a 60% higher risk of dying than non-obese patients. A total of 179 patients were analyzed, since there was no randomization due to bias in favor of the maneuver, n = 80 remained in the tracheostomy group, vs. n = 99 non-tracheostomy group. When comparing the relationship of both groups, the variables with statistical significance stood out: 1) days of Hospitalization 95% CI 16–31 p = 0.034, 2) days of stay in the ICU 95% CI 3.7–12.7 p = 0.027 and 3) days mechanical ventilation 95% CI 3.1–5.8 p = 0.003.

Conclusions: According to this study, there was lower mortality in the intervention group compared to the non-tracheostomy group (Figure 1). The risk factors associated with mortality are: BMI, ICU stay-reaching a median survival of 23 days-, the median survival for mechanical ventilation was 22 days (Table 1). However, other factors that could influence patient mortality regardless of the intervention would also have to be recognized.

Table 1 (abstract 000451) Cox proportional hazards or Cox regression

	B	HR	95% CI	p value
BMI > I	1.85	6.36	0.994–40.7	0.021*
ICU length of stay	1.94	7.01	1.07–45.6	0.002*
Mechanical ventilation duration (days)	1.77	2.93	0.141–3.80	0.001*
Hospital length of stay	1.38	3.22	0.412–9.71	0.028*

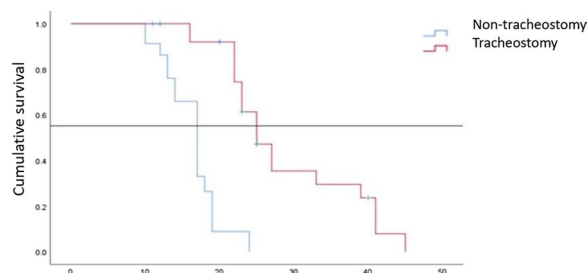

Figure 1 (abstract 000451) Survival comparison of the tracheostomy group versus non tracheostomy. Long Rank 0.001 Kaplan-Meier

References

- 5) Susarla, S. M., Peacock, Z. S., & Alam, H. B. (2012). Percutaneous dilatational tracheostomy: review of technique and evidence for its use. *Journal of Oral and Maxillofacial Surgery: Official Journal of the American Association of Oral and Maxillofacial Surgeons*, 70(1), 74–82. <https://doi.org/10.1016/j.joms.2011.04.002>
- 2) Rashid, A. O., & Islam, S. (2017). Percutaneous tracheostomy: a comprehensive review. *Journal of Thoracic Disease*, 9(Suppl 10), S1128–S1138. <https://doi.org/10.21037/jtd.2017.09.33>
- 1) Trouillet, J. L., Collange, O., Belafia, (2018). Tracheotomy in the intensive care unit: guidelines from a French expert panel. *Annals of Intensive Care*, 8(1). <https://doi.org/10.1186/s13613-018-0381-y>
- 4) Añón, J. M., Araujo, J. B., Escuela, M. P., & González-Higueras, E. (2014). Percutaneous tracheostomy in the ventilated patient. *Medicina Intensiva (English Edition)*, 38(3), 181–193. <https://doi.org/10.1016/j.medine.2012.11.005>
- 3) Sanabria, A. (2014). Which percutaneous tracheostomy method is better? A systematic review. *Respiratory Care*, 59(11), 1660–1670. <https://doi.org/10.4187/respcare.03050>

Topic: Acute respiratory failure and mechanical ventilation

000452

ECMO mobile teams in Madrid (SPAIN). Single center three year experience

S. Alcántara Carmona¹, M. Pérez Redondo¹, N. Martínez Sanz¹, H. Villanueva Fernández¹, A. Ortega López¹, P. Matía Almudévar¹, R. Fernández Rivas¹, S. Tejado Bravo¹, J. López Pérez¹, D. Ballesteros Ortega¹
¹Intensive Care, Hospital Puerta de Hierro-Majadahonda, Majadahonda, Spain

Correspondence: S. Alcántara Carmona
Intensive Care Medicine Experimental 2023, **11(Suppl 1)**:000452

Introduction: In November 2020, the Community of Madrid decided to implement a system of VV ECMO mobile teams (two hospitals on a one week-on, one week-off roster) so ECMO technology could reach all of its citizens.

Objectives: The objective of this study is to describe the population and the results of one of this mobile teams.

Methods: Retrospective study (Nov-2020 to April-2023). We recorded all patients referred to our VV ECMO mobile team and transferred to our center. We analyzed: number of referrals and transfers; age, gender, respiratory failure etiology, VV ECMO use, ICU length of stay (ICU-LOS) and mortality of all the transferred cases. Results are shown as mean \pm SD or median (IQR) for quantitative variables and as absolute value (%) for qualitative variables.

Results: In the 30-month period studied a total of 96 patients were referred to our VV ECMO mobile team. Forty-nine of them fulfilled relocation criteria and were transferred from 19 different hospitals (public and private centers). In 30 cases, the VV ECMO team was mobilized and ECMO cannulation was performed at the referring center. The other 19 were transferred without ECMO and 10 of them were finally cannulated upon arrival to our center. There were no complications during transfer. In the same time frame, our ICU admitted 12 local cases of VV ECMO, so the ECMO mobile program accounted for 77% (40) of all the ECMO cases of our department for that period of time.

Mean age of the transferred patients was 48 ± 12 years and 29 (59.2%) were males. Regarding respiratory failure etiology there were 48 (98%) cases of ARDS (40 secondary to SARS-CoV-2, one Influenza A, three cases each of community acquired and ventilator associated pneumoniae and one ARDS of unknown origin in a hematological patient) and one case (2%) of status asthmaticus. Median ECMO run was 14 (11–22) days.

Median ICU-LOS of the transferred patients was 27.5 (15.5–35) days. Overall mortality was 24.5% (12) with a VV ECMO group mortality of 30% (12). There were no casualties amongst the patients that were transferred that didn't require VV ECMO support.

Conclusions: ECMO mobile teams are a reality in the Community of Madrid. ECMO retrievals are our main source of ECMO patients nowadays which stresses the importance of referral centers. ECMO mobile teams bring equipoise across our population with good clinical results.

Topic: Acute respiratory failure and mechanical ventilation

000453

Volatile sedation in veno-venous ECMO patients. Impact on mechanical ventilation, ECMO parameters and sedation practices

S. Alcántara Carmona¹, N. Martínez Sanz¹, M. Pérez Redondo¹, B. Balandín Moreno¹, M. Valdivia De La Fuente¹, P. Matía Almudévar²
¹Intensive Care, Hospital Puerta de Hierro-Majadahonda, Majadahonda, Spain; ²Intensive care, Hospital Puerta de Hierro-Majadahonda, Majadahonda, Spain

Correspondence: S. Alcántara Carmona
Intensive Care Medicine Experimental 2023, **11(Suppl 1)**:000453.

Introduction: Volatile sedation (VS) might be an acceptable practice for patients on veno-venous ECMO (VV ECMO).

Objectives: To describe VS use in a small cohort of VV ECMO patients together with changes in mechanical ventilation (MV), sedation and neuromuscular blockade (NMB) practices before and after 24 h of VS.

Methods: Retrospective single-center study (Jan-2021/March-2023). We included all patients on VV ECMO with concomitant VS. Demographics; MV and ECMO parameters, vasoactive drug usage and sedation and NMB practices before and 24 h into VS; VS characteristics and ECMO run duration together with hospital length of stay and survival were recorded.

Results: Six patients were included. Mean age 34.3 ± 12.3 years. Four (66.6%) males. One patient was immunocompromised, and one suffered from COPD. There were no other comorbidities. Median BMI: $28.5 (26–39)$ kg/m². SOFA score 6.5 (3.75–7). All patients were admitted to ICU due to respiratory failure and global respiratory failure (5 patients) was the main indication for VV ECMO. In three patients VS was started at the same time as VV ECMO and in the other three cases VS started a median of 6.3 ± 3.5 h after VV ECMO commencement. Four patients received VS for difficult sedation and two for bronchospasm. Sevoflurane was the only agent used.

Before VS, MV parameters were: 235 (215–240) ml of tidal volume and 13 (10.5–14) bpm. Mean ECMO flow was 3.5 ± 0.23 lpm with a sweep gas flow of 5.4 ± 2.7 lpm. Three patients were receiving

norepinephrine. Regarding IV sedatives propofol was used in all patients, four received also ketamine, three midazolam and three clonidine. Four patients (66.6%) were treated with three sedatives at the same time and two were receiving two before VS was initiated. All patients were under continuous NMB. Mean BIS values were 50 ± 12.2 . Twenty-four hours after VS, tidal volume decreased to 195 (152.5–245) ml and respiratory frequency increased to 18 (14.5–21.5) bpm. ECMO flow was kept steady at 3.5 ± 0.53 lpm and sweep gas flow decreased to 4.1 ± 1.9 lpm. Two patients were receiving norepinephrine. Propofol, clonidine and midazolam were used in four patients each while three patients were treated also with ketamine. Half of the cohort was receiving three sedatives and two the other half. Four patients were still under continuous NMB. Mean BIS values were 40.2 ± 9.8 . Total dose of sevoflurane for the first 24h was 137.5 (133.5–228.5) ml with a mean exhaled concentration of $0.59 \pm 0.29\%$. Median duration of VS: 228.5 (77.2–335.5) h. No complications associated with this therapy were reported.

ECMO run duration was 13.5 (9.5–16.7) days. Median hospital length of stay was 73 (43.7–98.5) days. Five patients survived (83.7%).

Conclusions: VS in this small cohort of patients did not prompt major changes in MV or ECMO parameters and was not associated with hemodynamic instability. VS led to lower BIS values and decreased NMB needs but did not spare the use of IV sedatives. Long-term sedation with sevoflurane seems to be safe.

Topic: Sedation, analgesia and delirium

000454

Risk factors for enteral feeding intolerance in SARS-Cov2 severe ARDS patients

E. Gerovasileiou¹, L. Giannakou¹, S. Giannopoulos¹, V. Tsolaki¹, K. Deskata¹, M. E. Papadonta¹, D. Makris¹

¹Intensive care unit, University Hospital of Larissa, Larissa, Greece

Correspondence: E. Gerovasileiou

Intensive Care Medicine Experimental 2023, **11(Suppl 1)**:000454

Introduction: Feed intolerance in critically ill patients may be associated with adverse outcomes. Yet, risk factors associated with enteral feeding intolerance are poorly described especially in SARS-Cov2 ARDS patients.

Objectives: To identify risk factors associated with enteral feeding intolerance in SARS-Cov2 severe ARDS patients.

Methods: We prospectively included SARS-Cov2 ARDS patients hospitalized due to severe ARDS in the ICU of a tertiary hospital during the pandemic period (2020–2021).

Enteral feeding intolerance (EFI) was defined as events that included at least one the following: episode of high gastric residual volume (which was set based on previous studies, > 500 ml), recorded in patients' ICU chart and/or emesis.

Results: A total of 75 patients with severe SARS-Cov2 ARDS, median (IQR) PaO₂/FIO₂ was 211.8 (201.5; 231.2), median APACHE II score of 17.31 (15.9; 18.7) and median SOFA score of 8.32 (7.7; 8.9) were included. Fifty six of them (74.67%) died within 28 days. Median length of ICU stay was 14.79 (12.61; 16.96). EFI was documented at least once during hospitalization in 50 patients. Patients with EFI had more days in control modes of mechanical ventilation, received higher dose of propofol, midazolam (mg/kg/h) and of corticosteroids (mcg of hydrocortisone equivalent/kg/day) during their hospitalization compared to patients without EFI: (13.6, 11.7; 15.5 vs 7.5, 5.2; 9.8, $p < 0.0001$), (0.09, 0.07; 0.11 vs 0.05, 0.03; 0.06, $p = 0.0009$), (0.18, 0.14; 0.22 and 0.07, 0.05; 0.09, $p < 0.0001$) and (1.5, 1.2; 1.8 and 1.3, 0; 2.7 respectively, $p = 0.001$). Midazolam was independently associated with EFI ($p = 0.01$).

Conclusions: Sedative medication and more specifically the excessive use of midazolam may be a risk factor of increased EFI in SARS-Cov2 ARDS.

References

1. none
2. 1. Montejo JC, Miñambres E, Bordejé L, Mesejo A, Acosta J, Heras A, et al. Gastric residual volume during enteral nutrition in ICU patients: the REGANE study. *Intensive Care Med.* 2010 Aug;36(8):1386–93.

Topic: Metabolism, endocrinology, liver failure and nutrition

000455

Controlled donation after the determination of circulatory death with normothermic regional perfusion in a third level hospital: a six year review

M. Pérez Calle¹, A. M. Bellon Ramos², J. A. Galiano Gordillo³, A. Amaro Harpigny³, M. Carretero Rodrigo³, E. Bueso-Inchausti García⁴, S. Alcántara Carmona⁵, M. Pérez Redondo⁶

¹Intensive Care Medicine, Puerta de Hierro, Madrid, Spain; ²Unidad de Cuidados Intensivos, Puerta de Hierro Majadahonda University Hospital, Majadahonda, Spain; ³Intensive Care Unit, Puerta de Hierro Majadahonda University Hospital, Majadahonda, Spain; ⁴Critical Care, Puerta de Hierro, Madrid, Spain; ⁵Intensive Care, Puerta de Hierro Majadahonda University Hospital, Majadahonda, Spain; ⁶Intensive Care, Hospital Puerta de Hierro-Majadahonda, Majadahonda, Spain

Correspondence: M. Pérez Calle

Intensive Care Medicine Experimental 2023, **11(Suppl 1)**:000455

Introduction: Controlled donation after the determination of circulatory death (cDCD) has established itself as a fundamental source of organs in the last decade in Spain. The objective of this study is to review the cDCD donors and the validity of the organs retrieved under normothermic regional perfusion (NRP) of a third level hospital with a NRP-cDCD program.

Methods: Retrospective observational study (2017–2022) including all NRP-cDCD donors. Data were obtained from the e-medical records and the paper files of the NRP-cDCD process. General demographic and descriptive variables were collected as well as those associated with the NRP-cDCD technique. Functional warm ischemia time (f-WIT) was defined as the time from systolic arterial pressure < 60 mmHg to the onset of NRP. Organ success rate was defined as number of organs retrieved/total of organs evaluated in the cDCD–NRP $\times 100$. Quantitative variables are expressed as mean \pm SD for normal distribution, and median (IQR 25–75) for non-normal. Qualitative variables are expressed as % (absolute value).

Results: Twenty-nine NRP-cDCD were performed in the period studied. Mean age of the donors was 58 ± 13 years. Males accounted for 52% ($n = 15$) of the sample. Twenty-five (86%) donors were local while four (14%) were transferred from other centres for the sole purpose of donation under NRP. The reasons for hospital admission were: recovered cardiorespiratory arrest (55%; $n = 16$), stroke (28%; $n = 8$), severe brain injury (10%; $n = 3$) and respiratory failure (7%; $n = 2$). Mean ICU stay was 11 ± 6 days.

All cannulations were pre-mortem. The median f-WIT was 14 (9–18) minutes. Seventy-one organs were retrieved; 16 livers (55% success rate), 39 kidneys (63% success rate), 14 lungs (24% success rate) and two hearts (3.4% success rate).

NRP-cDCD accounted for 25.3% of the total of organs transplanted in our centre during the study period. According to organ NRP-cDCD provided: 27.6% of livers, 28.9% of kidneys, 18.9% of lungs and 14.3% of hearts of the total pull.

Conclusions: NRP-cDCD has contributed to an increase in the total number of donors, and is responsible for one out of every four donations performed in our centre. Organs obtained through PAN-DAC show acceptable success rates that are comparable to those described in other series.

Topic: Brain death, organ donation and transplantation

000456

Diagnostic accuracy of point-of-care ultrasound for shock: a systematic review and meta-analysis

T. Yoshida¹, T. Yoshida², H. Noma³, T. Nomura⁴, A. Suzuki⁵, T. Mihara²

¹Intensive Care Unit, Department of Emergency Medicine, Jikei University School of Medicine, Minato City, Japan; ²Department of Health Data Science, Graduate School of Data Science, Yokohama City University, Yokohama, Japan; ³Department of Data Science, The Institute of Statistical Mathematics, Tachikawa, Japan; ⁴Department of Perioperative Medical Support, Tokushukai Medical Corporation, Tokyo, Japan; ⁵Department of Anesthesiology and Critical Care Medicine, Jichi Medical University, Shimotsuke, Japan

Correspondence: T. Yoshida

Intensive Care Medicine Experimental 2023, **11(Suppl 1)**:000456

Introduction: Circulatory failure is classified into four types of shock (obstructive, cardiogenic, distributive, and hypovolemic) that must be distinguished as each requires a different treatment [1]. Point-of-care ultrasound (POCUS) is widely used in clinical practice for acute conditions [2, 3], and several diagnostic protocols using POCUS for shock have been developed [4–6].

Objectives: This study aimed to evaluate the diagnostic accuracy of POCUS in identifying the etiology of shock.

Methods: We conducted a systematic literature search of MEDLINE, Cochrane Central Register of Controlled Trials, Embase, Web of Science, Clinicaltrial.gov, European Union Clinical Trials Register, WHO International Clinical Trials Registry Platform, and University Hospital Medical Information Network Clinical Trials Registry (UMIN-CTR) until June 15, 2022. We followed the Preferred Reporting Items for Systematic Reviews and Meta-Analyses guidelines and assessed study quality using the Quality Assessment of Diagnostic Accuracy Studies 2 tool. Meta-analysis was conducted to pool the diagnostic accuracy of POCUS for each type of shock. The study protocol was prospectively registered in UMIN-CTR (UMIN 000048025).

Results: Of the 1553 studies identified, 36 studies were full-text reviewed, and 12 studies with 1132 patients were included in the meta-analysis. Pooled sensitivity and specificity were 0.82 [95% confidence interval (CI): 0.68–0.91] and 0.98 [95% CI: 0.92–0.99] for obstructive shock, 0.78 [95% CI: 0.56–0.91] and 0.96 [95% CI: 0.92–0.98] for cardiogenic shock, 0.90 [95% CI: 0.84–0.94] and 0.92 [95% CI: 0.88–0.95] for hypovolemic shock, and 0.79 [95% CI: 0.71–0.85] and 0.96 [95% CI: 0.91–0.98] for distributive shock, respectively. The area under the receiver operating characteristic curve for each type of shock was approximately 0.95. The positive likelihood ratios for each type of shock were all greater than 10, especially 40 [95% CI: 11–105] for obstructive shock. The negative likelihood ratio for each type of shock was approximately 0.2.

Conclusions: The identification of the etiology for each type of shock using POCUS was characterized by high sensitivity and positive likelihood ratios, especially for obstructive shock. These findings should be considered in future diagnostic protocols for shock using POCUS.

References

1. Vincent J-L, De Backer D. Circulatory shock. *N Engl J Med.* 2013;369(18):1726–34.
2. Diaz-Gómez JL, Mayo PH, Koenig SJ. Point-of-Care Ultrasonography. *N Engl J Med.* 2021;385(17):1593–602.
3. Vieillard-Baron A, Millington SJ, Sanfilippo F, Chew M, Diaz-Gomez J, McLean A, et al. A decade of progress in critical care echocardiography: a narrative review. *Intensive Care Med.* 2019;45(6):770–88.
4. Mayo PH, Beaulieu Y, Doelken P, Feller-Kopman D, Harrod C, Kaplan A, et al. American College of Chest Physicians/La Société de Réanimation de Langue Française statement on competence in critical care ultrasonography. *Chest.* 2009;135(4):1050–60.
5. Perera P, Mailhot T, Riley D, Mandavia D. The RUSH exam: Rapid Ultrasound in SHock in the evaluation of the critically ill. *Emerg Med Clin North Am.* 2010;28(1):29–56, vii.
6. Lichtenstein DA. BLUE-protocol and FALLS-protocol: two applications of lung ultrasound in the critically ill. *Chest.* 2015;147(6):1659–70.

7. Not applicable.

Topic: Cardiovascular issues in ICU

000458

Predicting risk of maternal critical care admission in Scotland

L. Cowan¹, I. Adamestam², J. Masterson¹, M. Beatty¹, L. Chislett³, P. Johnston⁴, J. Joss⁵, H. Lawrence⁶, K. Litchfield⁷, N. Plummer⁸, S. Rhode³, T. Walsh³, A. Wise¹, C. Weir², N. Lone³

¹Department of Anaesthesia, Critical Care, and Pain Medicine, Royal Infirmary of Edinburgh, University of Edinburgh, Edinburgh, United Kingdom; ²Edinburgh Clinical Trials Unit, Usher Institute, The University of Edinburgh, Edinburgh, United Kingdom; ³Usher Institute, The University of Edinburgh, Edinburgh, United Kingdom; ⁴Department of Anaesthesia, Critical Care, and Pain Medicine, Ninewells Hospital, Dundee, United Kingdom; ⁵Critical care unit, The University of Edinburgh, Edinburgh, United Kingdom; ⁶Patient representative, The University of Edinburgh, Edinburgh, United Kingdom; ⁷Department of Anaesthesia, Critical Care, and Pain Medicine, Glasgow Royal Infirmary, Glasgow, United Kingdom; ⁸Department of Critical Care, Nottingham University Hospitals, Nottingham, United Kingdom

Correspondence: L. Cowan

Intensive Care Medicine Experimental 2023, **11(Suppl 1)**:000458

Introduction: Maternal death in the UK is rare. Therefore, efforts to improve quality of care have focussed on reducing the risk of life-threatening perinatal illness [1]. Identifying women at highest risk of perinatal critical care admission may enable clinicians to risk stratify women antenatally so that enhanced care or elective admission to critical care may be considered in birthing plans.

Objectives: We aimed to develop a statistical model for the prediction of risk of perinatal critical care admission.

Methods: We studied 762,918 pregnancies between 2005 and 2018. Predictive models were constructed using multivariable logistic regression. The primary outcome was admission to critical care, i.e., an intensive care unit (ICU) or general high dependency unit (gHDU). Additional analyses were performed for: (a) admission to either ICU, gHDU or obstetric HDU in the subgroup these data were available, and (b) primary outcome occurring either on or after day of delivery to allow study of delivery-related factors. Predictors were selected following expert consultation and reviewing literature, resulting in 13 variables being included in the primary analysis: demographics, prior health status (e.g., comorbidities, smoking status), obstetric history (e.g., parity, previous C-section) and pregnancy factors (e.g., multiple gestation) A complete case analysis was done. K-fold cross validation was used to adjust for overfitting.

Results: Complete data were available for 578,310 pregnancies, of whom 2121 were admitted to critical care (0.37%). Model performance with respect to discrimination and calibration was fair (Figure 1; area under the ROC curve [AUC] = 0.65; Brier score = 0.0036). The negative predictive value (NPV) of the model was high across a range of predicted probability thresholds. A comparatively high cut-point of 2.8% or more for risk of critical care admission resulted in NPV of 99.6% and specificity 99.9% but positive predictive value (PPV) of just 3.95% and sensitivity of 0.896%.

Models produced from subgroup analyses also performed favourably. Complete data pertaining to delivery-related factors were available for 553,164 pregnancies, 1497 of which involved admission to critical care. A model containing an additional five variables relating to delivery achieved an AUC 0.77 and Brier score 0.0027. Among 68,553 for whom data on obstetric HDU admission were available, 1890 were admitted to either ICU, general HDU, or obstetric HDU. A model to predict risk of admission to critical care in this group achieved an AUC of 0.77 with Brier score of 0.026.

Conclusions: We have identified multiple independent risk factors for perinatal critical care admission. Our primary model has an acceptable discriminative ability, with an AUC of 0.65. While the NPV of the model is high, its low PPV indicates that implementation of the prediction model would be most useful as a “rule-out” test, to exclude women from pre-emptive consideration of critical care admission.

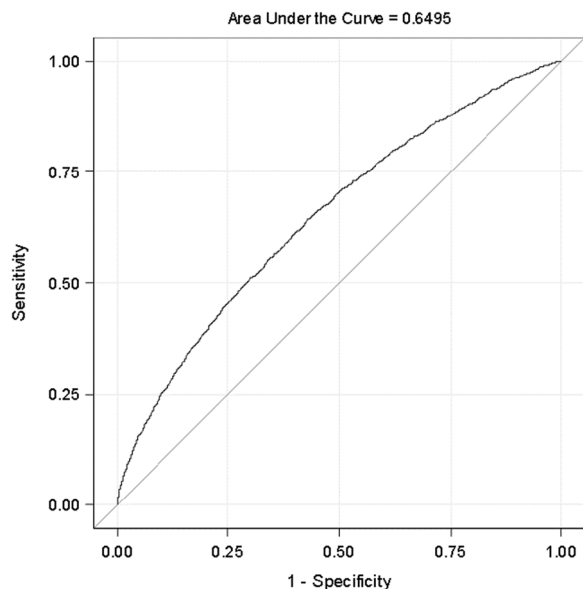

Figure 1 (abstract 000458) Receiving operating characteristic curve for model predicting risk of admission to critical care

References

1. We are grateful to Roz Pollock for deriving the cohort and linking the datasets. We are grateful to the late Prof. Denison who contributed to study design, analysis and securing funding. We thank the eDRIS Team (Public Health Scotland) for its involvement in obtaining approvals, provisioning and linking data and the use of the secure analytical platform within the National Safe Haven.
2. 1. Knight M, Acosta C, Brocklehurst P, et al. Beyond maternal death: improving the quality of maternal care through national studies of 'near-miss' maternal morbidity. Southampton (UK): NIHR Journals Library; June 2016.
3. Grant funding: Obstetric Anaesthetists' Association

Topic: Critical care organisation, quality management, information systems, outcomes

000460

Protocolized diagnostic algorithm to determine the etiology of out-of-hospital cardiac arrest

C. K. Wu¹, L. Chi-Hsien², M. S. Tsai², C. H. Huang²

¹Emergency Department, National Taiwan University Hospital, Taipei, France; ²Emergency Medicine, National Taiwan University Hospital, Taipei, Taiwan

Correspondence: C. H. Huang

Intensive Care Medicine Experimental 2023, **11(Suppl 1)**:000460

Introduction: The mortality rate for resuscitated patients after out-of-hospital cardiac arrest (OHCA) remains high, and prompt identification of the precipitating cause of OHCA is crucial for implementing cause-specific treatments and improving patient outcomes. We propose a protocolized diagnostic algorithm to quickly differentiate the exact etiology of OHCA.

Methods: We conducted a retrospective cohort study at a tertiary medical center between 2006 and 2020. We excluded pediatric cases, traumatic cases, cases with ROSC before hospital arrival, and cases without sustained ROSC (≥ 20 min). Emergency physicians reviewed medical records and followed the proposed diagnostic algorithm to determine a single most likely etiology of OHCA. The presumptive diagnoses during CPR and final diagnoses in post-ROSC period during hospitalization were listed and compared. The survival rate until

hospital discharge was compared among the determined causes of OHCA.

Results: We included 584 cases, with 46% presumed cardiac etiology, 35% non-cardiac etiology, and 19% undetermined etiology during CPR. After extensive workup during the post-ROSC period, final etiology was determined to be cardiac in 52%, non-cardiac in 42%, and unknown in 6% of cases. Compared to cardiac etiology, non-cardiac etiology was linked to younger age, lower rates of established survival predictors, and lower rates of all survival outcomes. Among non-cardiac etiology, respiratory causes accounted for 64% of cases, followed by infection (15%), neurology (9%), toxicology (4%), non-traumatic massive bleeding (3%), metabolic derangement (3%), and other (2%). Overall, 72.5% of initially undetermined cases had a final diagnosis deemed responsible for OHCA. Among these cases, 49% had cardiac causes and 51% had non-cardiac causes. Coronary angiogram and CT scan provided contributory causes of OHCA in 88% of initially undetermined cases. After exclusion of undetermined cases, only 29 cases (0.05%) received an incorrect presumptive diagnosis compared to the final diagnosis, and 70% of these cases required a CT scan to make the correct diagnosis responsible for OHCA.

Conclusions: Our protocolized diagnostic algorithm demonstrated high diagnostic rate and accuracy in determining the specific etiology of OHCA. Coronary angiogram and CT scan provided contributory causes of OHCA in most of the initially undetermined cases. Prospective studies are warranted to determine if protocolized OHCA diagnosis can lead to prompt cause-specific treatments following successful resuscitation and improve survival.

Topic: Cardiac arrest

000461

The effects of mitochondrial transplantation on sepsis is dependent on the origin cell of mitochondria isolation

K. Yun-Seok¹, A. R. L. Han², M. Lee³, J. P. Ye⁴, N. C. Tae⁵, K. Kyuseok³

¹Emergency Medicine, loupys@naver.com, Seongnam-si, Republic of Korea; ²Emergency Medicine, harlee91@naver.com, Seongnam-si, Republic of Korea; ³Emergency Medicine, Cha University, Pocheon-si, Republic of Korea; ⁴Emergency Medicine, Yejin6577@naver.com, Seongnam-si, Republic of Korea; ⁵Emergency Medicine, hendrix74@cha.ac.kr, Seongnam-si, Republic of Korea

Correspondence: K. Kyuseok

Intensive Care Medicine Experimental 2023, **11(Suppl 1)**:000461

Introduction: Previously, we have shown that the mitochondrial transplantation in sepsis model has immune modulation effects. The mitochondrial function could have different characteristics dependent on cell types.

Objectives: We investigated the effects of mitochondrial transplantation on sepsis model could be different depending on the cell type, from which mitochondria was isolated.

Methods: We isolated mitochondria from L6 muscle cells, clone 9 liver cells, and mesenchymal stem cells (MSC). We tested the effects of mitochondrial transplantation with in-vitro and in-vivo sepsis model. We used LPS stimulation of THP-1 cell as in-vitro model. First, we saw the mitochondrial function in mitochondrial transplantation. Second, we compared anti-inflammatory effects of mitochondrial transplantation. Third, we investigated the immune enhancing effects with endotoxin tolerance model. With in-vivo polymicrobial fecal slurry sepsis model, we investigated the survival and biochemical effects of each type of mitochondrial transplantation.

Results: In in-vitro LPS model, mitochondrial transplantation from all three cells improved mitochondrial function measured by oxygen consumption using XF analyzer. Of those 3 cell types, L6-mitochondrial transplantation enhanced mitochondrial function more significantly. Mitochondrial transplantation with each cell type reduced hyperinflammation in acute phase of in-vitro LPS model. It also enhanced immune function in late immune suppression phase, shown by endotoxin tolerance. These functions were not significantly different between 3 cell types-origin mitochondrial transplantation. However,

only L6-mitochondrial transplantation significantly improved survival than control in polymicrobial in-vivo sepsis model.

Conclusions: The effects of mitochondria transplantation on both in-vitro and in-vivo sepsis models were different from cell types of origin of mitochondria. L6-mitochondrial transplantation might be more beneficial in sepsis model.

Topic: Sepsis

000462

Left ventricular global longitudinal strain is independently associated with mortality in hyperdynamic patients with sepsis

Z. Jin¹, F. Guo¹

¹Jiangsu Provincial Key Laboratory of Critical Care Medicine, Department of Critical Care Medicine, Zhongda Hospital, School of Medicine, Southeast University, Nanjing, Jiangsu, China

Correspondence: Z. Jin

Intensive Care Medicine Experimental 2023, **11(Suppl 1)**:000462

Introduction: Sepsis-induced cardiomyopathy (SICM) is increasingly recognized as an important factor contributing to poor outcomes in septic patients, and it was confirmed in left ventricular diastolic dysfunction and right heart dysfunction [1–3]. However, the association between left ventricular systolic dysfunction (LVSD) and mortality of septic patients is to be determined.

Left ventricular ejection fraction (LVEF) is inconsistent with the mortality in septic patients [4, 5]. Some studies have reported that global longitudinal strain (GLS) was an independent risk factor for sepsis while other researchers have reached the opposite conclusion, which limited the potential application of GLS in septic patients [6, 7]. And this study aimed to assess the prognostic clinical value of GLS in septic patients.

Methods: We included patients who met the criteria for sepsis-3 from the Surviving Sepsis Campaign: International Guidelines for Management of Sepsis and Septic Shock 2016 were screened. And patients with history and/or potential cardiac dysfunction in this prospective study were excluded. All echocardiographies were performed within 24 h of enrollment according to the recommendations from the European Association of Cardiovascular Imaging and the American Society of Echocardiography. And speckle tracking echocardiography was analyzed offline. Full clinical data of patients were collected. According to modified Simpsons' rule, LVEF was measured with the biplane method. LVEF was defined as depressed (LVEF < 45% or requiring inotrope infusion), moderate (45–60%) and hyperdynamic (> 60%).

Results: We recruited 125 subjects in the final analysis. The age of all septic patients was 62.7 years old, and the 28-day and 90-day mortality were 24.8% (n = 31) and 31.2% (n = 39), respectively. The non-survivors with 28 days had higher Arterial blood lactates (3.1 pg/ml vs 2.1 mmol/L, $p < 0.05$), Troponin I (0.03 ng/ml vs 0.01 pg/ml, $p < 0.05$), NT-proBNP (2980 pg/ml vs 1590 pg/ml, $p < 0.05$) than survivors. Non-survivors had lower absolute GLS than that of survivor group (–17.2% vs –19.3%, $p = 0.045$), however, GLS was not an independent risk factor for mortality of sepsis after adjusting for clinical variables. And GLS has been demonstrated poor accuracy in predicting 28-day and 90-day outcomes of all septic patients with AUROC of 0.633 and 0.638, respectively. While GLS has good accuracy in predicting both 28-day and 90-day mortality in hyperdynamic patients (area under the receiver operating characteristic curve were 0.865 and 0.851, respectively). Cox regression analyses showed that less negative GLS was an independent predictor of mortality for septic patients with hyperdynamic LVEF.

Conclusions: GLS is an independent risk factor associated for mortality in patients with hyperdynamic left ventricular ejection. The clinical implications of this finding should be investigated in future larger studies.

References

1. National key research and development program (2022YFC2504505)
2. Vallabhajosyula S, Sakhuja A, Geske JB, Kumar M, Poterucha JT, Kashyap R, et al. Role of Admission Troponin-T and Serial Troponin-T Testing in

- Predicting Outcomes in Severe Sepsis and Septic Shock. *Journal of the American Heart Association*. 2017;6(9).
2. Lanspa MJ, Cirulis MM, Wiley BM, Olsen TD, Wilson EL, Beesley SJ, et al. Right Ventricular Dysfunction in Early Sepsis and Septic Shock. *Chest*. 2021;159(3):1055–63.
3. Sanfilippo F, Corredor C, Arcadipane A, Landesberg G, Vieillard-Baron A, Cecconi M, et al. Tissue Doppler assessment of diastolic function and relationship with mortality in critically ill septic patients: a systematic review and meta-analysis. *British journal of anaesthesia*. 2017;119(4):583–94.
4. Paonessa JR, Brennan T, Pimentel M, Steinhaus D, Feng M, Celi LA. Hyperdynamic left ventricular ejection fraction in the intensive care unit. *Critical care (London, England)*. 2015;19(1):288.
5. Chotalia M, Ali M, Hebballi R, Singh H, Parekh D, Bangash MN, et al. Hyperdynamic Left Ventricular Ejection Fraction in ICU Patients With Sepsis. *Critical care medicine*. 2022;50(5):770–9.
6. Chang WT, Lee WH, Lee WT, Chen PS, Su YR, Liu PY, et al. Left ventricular global longitudinal strain is independently associated with mortality in septic shock patients. *Intensive care medicine*. 2015;41(10):1791–9.
7. De Geer L, Engvall J, Oscarsson A. Strain echocardiography in septic shock—a comparison with systolic and diastolic function parameters, cardiac biomarkers and outcome. *Critical care (London, England)*. 2015;19(1):122.

Topic: Sepsis

000463

Impact of steroid therapy duration in COVID-19 patients: a multicenter, propensity score-matched study

S. Kim¹, J. Ryoo², S. C. Kim³, H. J. Cho³, J. Lee³

¹Division of Pulmonary, Allergy and Critical Care Medicine, Department of Internal Medicine, Yeouido St. Mary's Hospital, College of Medicine, The Catholic University of Korea, Seoul, Republic of Korea; ²Division of Pulmonary, Allergy and Critical Care Medicine, Department of Internal Medicine, Bucheon St. Mary's Hospital, College of Medicine, The Catholic University of Korea, Seoul, Republic of Korea; ³Division of Pulmonary, Allergy and Critical Care Medicine, Department of Internal Medicine, Seoul St. Mary's Hospital, College of Medicine, The Catholic University of Korea, Seoul, Republic of Korea

Correspondence: J. Lee

Intensive Care Medicine Experimental 2023, **11(Suppl 1)**:000463

Introduction: Systemic corticosteroids have been frequently used in COVID-19 pandemic. As there are many reports that demonstrated beneficial effects of corticosteroids on COVID-19, guidelines recommend the use of corticosteroids for COVID-19 patients requiring oxygen therapy (1, 2). However, optimal dose and duration of corticosteroids are not established. In a recent study (CIBERESUCICOID), long-term use (≥ 10 days) of corticosteroid was associated with lower risk of 90-day mortality (3).

Objectives: To compare the clinical outcomes according to duration of systemic corticosteroid treatment for hospitalized patients with COVID-19.

Methods: This multicenter, retrospective study was conducted between January 2020 and August 2021 at 22 Korean hospitals. COVID-19 patients aged ≥ 19 years who were treated with more than high-flow nasal cannula were included in this study. This study is supported by Grant No. (KATRD-S-2021-2) from the Korean Academy of Tuberculosis and Respiratory Diseases.

Among 1114 patients, 982 patients whose hospital length of stay (LOS) was longer than 10 days were included in the analysis. Patients were divided into two groups according to duration of corticosteroid treatment: long-term (> 10 days) and short-term (≤ 10 days). Propensity score matching (PSM) was performed using age, initial Sequential Organ Failure Assessment (SOFA) score, initial arterial partial pressure of oxygen (PaO₂) to fractional inspired oxygen (FiO₂) ratio, underlying diseases such as cardiovascular disease and hematologic disease, use of mechanical ventilation, and treatment with tocilizumab as confounding variables. Baseline characteristics and clinical outcomes were compared between the two groups of PSM cohort.

Results: Each group of PSM cohort consisted of 376 patients with no significant difference in demographic characteristics between the two groups (Table 1). Long-term group had longer time to negative conversion of COVID-19 polymerase chain reaction (PCR) test and longer hospital LOS. However, short-term group showed higher intensive care unit (ICU) mortality than long-term group (Table 2; 22.6% vs. 16.1%, $p=0.033$). In Kaplan–Meier curve, long-term group exhibited better survival probability than short-term group (Figure1; $p=0.0025$). Though short-term group was associated with shorter hospital LOS (Table 3A; $B \pm SE$, -5.194 ± 2.031 ; $p=0.011$), this group was associated with higher risk of in-hospital and ICU mortality (Table 3B; HR, 1.539; 95% CI, 0.123–0.739; $p=0.006$ and HR, 1.598; 95% CI, 0.129–0.808; $p=0.007$, respectively).

Conclusions: Short-term use of systemic corticosteroid for hospitalized patient with COVID-19 was associated with increased risk of in-hospital and ICU mortality.

Table 1 (abstract 000463) Baseline characteristics according to duration of steroid therapy

	Unmatched cohort			Propensity score-matched cohort		
	Long-term (n=605)	Short-term (n=377)	P-value	Long-term (n=376)	Short-term (n=376)	P-value
Age, median [Q1;Q3] - years	69.0 [59.0;77.0]	69.0 [61.0;78.0]	0.399	69.0 [59.0;78.0]	69.0 [60.5;78.0]	0.654
Sex, female, n (%)	242 (40.0)	145 (38.5)	0.650	158 (42.0)	145 (38.6)	0.372
BMI, median [Q1;Q3] - years	24.8 [22.2;27.2]	24.5 [22.3;26.9]	0.503	24.6 [22.2;27.2]	24.5 [22.3;27.0]	0.866
Comorbidities, n (%)						
HTN	325 (53.7)	209 (55.4)	0.646	197 (52.4)	209 (55.6)	0.421
DM	204 (33.7)	123 (32.6)	0.777	125 (33.2)	123 (32.7)	0.938
CVD	19 (3.1)	31 (8.2)	0.026	32 (8.5)	31 (8.2)	1.000
Chronic lung disease	47 (7.8)	32 (8.5)	0.778	30 (8.0)	32 (8.5)	0.895
Chronic neurologic disease	78 (12.9)	47 (12.5)	0.923	43 (11.4)	47 (12.5)	0.736
Chronic renal failure	49 (8.1)	25 (6.6)	0.470	27 (7.2)	25 (6.6)	0.886
Chronic liver disease	19 (3.1)	8 (2.1)	0.454	11 (2.9)	8 (2.1)	1.000
Hematologic disease	13 (2.1)	1 (0.3)	0.032	1 (0.3)	1 (0.3)	1.000
Solid tumor	45 (7.4)	24 (6.4)	0.609	27 (7.2)	24 (6.4)	0.772
Smoking history, n (%)						1.000
Never	409 (67.6)	260 (69.0)		260 (69.1)	260 (69.1)	
Ex- or current	196 (32.4)	117 (31.0)		116 (30.9)	116 (30.9)	
Initial vital signs, median [Q1;Q3]						
SBP - mmHg	132.0 [120.0;146.0]	131.0 [117.0;145.0]	0.112	132.0 [119.5;148.0]	131.0 [117.0;145.0]	0.134
DBP - mmHg	76.0 [67.0;85.0]	74.0 [66.0;84.0]	0.073	76.0 [67.0;85.5]	74.0 [66.0;84.0]	0.138
HR - beats per minute	77.0 [64.5;89.0]	77.0 [65.0;88.0]	0.606	76.0 [63.0;88.0]	77.0 [65.0;87.5]	0.527
RR - breaths per minute	22.0 [20.0;26.0]	22.0 [20.0;26.0]	0.316	22.0 [20.0;26.0]	22.0 [20.0;26.0]	0.563
BT - °C	36.8 [36.4;37.4]	36.8 [36.4;37.3]	0.979	36.8 [36.4;37.5]	36.8 [36.4;37.3]	0.821
GCS	15.0 [14.0;15.0]	15.0 [15.0;15.0]	0.036	15.0 [14.0;15.0]	15.0 [15.0;15.0]	0.191
Initial ABGA						
pH	7.4 [7.4;7.5]	7.4 [7.4;7.5]	0.770	7.4 [7.4;7.5]	7.4 [7.4;7.5]	0.508
PaCO ₂	33.6 [30.0;37.7]	33.3 [30.0;37.4]	0.795	33.6 [29.7;37.3]	33.3 [30.0;37.4]	0.862
PaO ₂	74.0 [62.0;91.0]	79.9 [65.0;101.8]	0.004	76.0 [64.0;97.3]	79.0 [65.0;101.8]	0.363
HCO ₃	22.7 [20.1;25.2]	22.9 [20.1;25.0]	0.987	22.8 [20.3;25.2]	22.9 [20.1;24.9]	0.944
P/F ratio	130.1 [90.9;192.4]	151.5 [100.4;219.0]	<0.001	159.2 [111.7;209.3]	163.9 [107.3;206.2]	0.929
Laboratory findings						
WBC	7.9 [5.6;11.9]	7.6 [5.4;11.4]	0.422	7.7 [5.5;11.6]	7.7 [5.3;11.4]	0.934
Hg	13.0 [11.8;14.2]	13.0 [11.8;14.2]	0.894	13.0 [11.8;14.1]	13.0 [11.8;14.2]	0.611
Platelet	190.0 [139.0;241.0]	188.0 [135.0;238.0]	0.616	191.0 [149.0;242.0]	188.0 [134.5;238.0]	0.274
BUN	19.0 [13.9;27.0]	18.0 [13.9;25.0]	0.292	18.2 [13.2;25.0]	18.0 [13.9;25.0]	0.771
Cr	0.8 [0.6;1.0]	0.8 [0.6;1.0]	0.355	0.8 [0.6;1.0]	0.8 [0.6;1.0]	0.048
Albumin	3.3 [2.9;3.6]	3.3 [3.0;3.6]	0.044	3.3 [3.0;3.6]	3.3 [3.0;3.6]	0.462
Bilirubin	0.5 [0.4;0.8]	0.6 [0.4;0.8]	0.329	0.5 [0.4;0.8]	0.6 [0.4;0.8]	0.068
AST	46.0 [33.0;68.0]	49.0 [34.0;69.0]	0.443	45.0 [32.5;68.5]	49.0 [34.0;68.5]	0.358
ALT	32.0 [21.0;52.0]	28.0 [21.0;46.0]	0.098	31.0 [20.0;53.5]	28.0 [21.0;46.0]	0.194
D-dimer	1.2 [0.6;4.3]	1.3 [0.5;7.0]	0.789	1.2 [0.6;7.4]	1.3 [0.5;7.0]	0.757
Ferritin	503.0 [0.0;1053.0]	121.0 [0.0;749.0]	<0.001	429.9 [0.0;920.5]	124.0 [0.0;752.7]	0.002
CRP	10.0 [4.0;19.1]	9.8 [5.4;16.8]	0.591	9.8 [4.0;19.7]	9.7 [5.4;16.6]	0.452
Procalcitonin	0.1 [0.0;0.5]	0.1 [0.0;0.5]	0.342	0.1 [0.0;0.3]	0.1 [0.0;0.5]	0.055
Initial SOFA score	4.0 [3.0;6.0]	3.0 [2.0;5.0]	0.012	3.0 [3.0;5.0]	3.0 [2.0;5.0]	0.950
Highest level of care			<0.001			0.894
HFN	215 (35.5)	191 (50.7)		193 (51.3)	191 (50.8)	
MV	310 (51.2)	143 (37.9)		145 (38.6)	143 (38.0)	
ECMO	80 (13.2)	43 (11.4)		38 (10.1)	42 (11.2)	
BSI	141 (24.2)	58 (16.1)	0.004	72 (19.7)	58 (16.2)	0.255
COVID-19 therapies						
Remdesivir	446 (73.7)	274 (72.7)	0.776	281 (74.7)	274 (72.9)	0.619
Tocilizumab	67 (11.1)	18 (4.8)	0.001	23 (6.1)	18 (4.8)	0.521

Table 2 (abstract 000463) Clinical outcomes according to duration of steroid therapy in propensity score-matched cohort

	Long-term (n=376)	Short-term (n=376)	P-value
Negative conversion, n (%)	171 (46.5)	172 (47.1)	0.970
Time to negative conversion, median [Q1;Q3] - days	25.0 [18.0;35.0]	20.0 [13.0;28.0]	<0.001
In-hospital mortality, n (%)	73 (19.4)	92 (24.5)	0.113
ICU mortality, n (%)	58 (16.1)	82 (22.6)	0.033
All-cause mortality, n (%)	97 (25.8)	103 (27.4)	0.680
Length of stay, median [Q1;Q3] - days	22.0 [16.0;36.0]	21.0 [14.0;31.0]	0.004
Length of ICU stay, median [Q1;Q3] - days	16.0 [9.0;26.0]	15.0 [10.0;25.0]	0.777

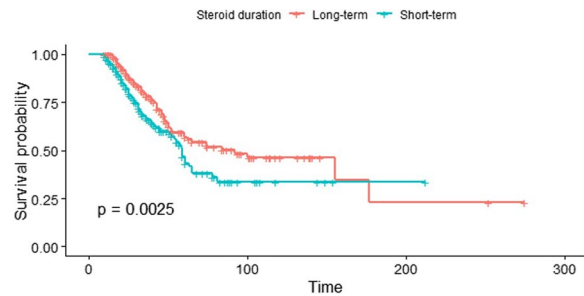

Figure 1 (abstract 000463) Kaplan–Meier curve according to duration of steroid therapy in propensity score-matched cohort

Table 3 (abstract 000463) Survival analysis according to duration of steroid therapy in propensity score-matched cohort

	A. Linear regression (univariable)		
	Long-term	Short-term $B \pm SE$	P-value
LOS	1 (ref)	-5.194 ± 2.031	0.011
ICU LOS	1 (ref)	-1.649 ± 1.412	0.243
	B. Cox proportional hazard ratio		
	Long-term	Short-term HR (95% CI)	P-value
In-hospital mortality	1 (ref)	1.539 (0.123-0.739)	0.006
ICU mortality	1 (ref)	1.598 (0.129-0.808)	0.007

References

3. Torres A, Motos A, Cilloniz C, Ceccato A, Fernandez-Barat L, Gabarrus A, et al. Major candidate variables to guide personalised treatment with steroids in critically ill patients with COVID-19: CIBERESUCICOVID study. Intensive Care Med. 2022;48(7):850–64.
2. Chalmers JD, Crichton ML, Goeminne PC, Cao B, Humbert M, Shteinberg M, et al. Management of hospitalised adults with coronavirus disease 2019 (COVID-19): a European Respiratory Society living guideline. Eur Respir J. 2021;57(4).
1. WHO Rapid Evidence Appraisal for COVID-19 Therapies (REACT) Working Group SJ, Murthy S et al. Association between administration of systemic corticosteroids and mortality among critically ill patients with COVID-19: a meta-analysis. JAMA. 2020;324(13):1330–41.
4. Authors are on behalf of Korean Intensive Care Study Group

Topic: Systemic diseases

000464

Safety and efficacy of using non-invasive ventilation of lungs for treatment of respiratory insufficiency outside the ICUA. Konkayev¹, A. Kadrainova¹, A. Yeltayeva¹, G. Abdirakhym¹, N. Zhanarystan¹¹Anesthesiology and Intensive Care Department, Astana Medical University, Astana, Kazakhstan**Correspondence:** A. Konkayev*Intensive Care Medicine Experimental* 2023, **11(Suppl 1)**:000464

Introduction: The progression of acute respiratory failure (ARF) in patients with lung pathology of various etiologies is a common reason for urgent transfer of patient to the intensive care unit. The use of non-invasive ventilation (NIV) in intensive care units significantly improves patient outcomes, prevents intubation and increases survival (1). Therefore, the expansion of indications for the use of NIV outside the ICU is gaining momentum. The widespread use of non-invasive positive pressure ventilation is observed not only in wards, but also in a number of countries, NIV is successfully used at home, for example, in the treatment of chronic obstructive pulmonary disease. There is a good evidence base for the use of NIV in COPD. (2, 3). NIV also showed better results treating ARF in immunocompromised patients. (4) However, there is also meta-analytic evidence of a beneficial effect in ARF regardless of etiology (5).

Objectives: Improving respiratory care outside the intensive care unit through the use of early non-invasive ventilation of lungs for treating mild to moderate respiratory failure.

Methods: Patients included in the study were randomized into 2 groups: early NIV and standard treatment. Patients in the early NIV group received non-invasive ventilation procedures. The standard treatment group received the usual best therapy. Daily monitoring of vital functions, arterial blood gas composition, other laboratory and instrumental research methods was carried out. In patients of both groups, the progression of ARF to a severe degree was monitored, sufficient for the transfer of ICU, 28-day survival, length of stay in the hospital, safety of NIV, and all respiratory complications during the hospitalization period.

Results: The study involved 24 participants. There were 16 patients in the NIV group and 8 patients in the control group. Progression of ARF and subsequent transfer to ICU—9 (56%) patients in the NIV group and 5 (62.5%) patients in the control group. The 28-day survival was in the early NIV group—12 (75%) patients, in the control group—8 patients (75%). The average length of stay in the hospital was 17.2 ± 10 days in the early NIV group and 11.8 ± 8 days in the control group. There were no respiratory complications associated with the use of NIV among patients who underwent non-invasive ventilation of the lungs.

Conclusions: Interim results of the study showed no NIV-related respiratory complications using NIV outside ICU. The efficacy of early NIV in respiratory failure requires further study.

References

5. Liu YJ, Zhao J, Tang H. Non-invasive ventilation in acute respiratory failure: a meta-analysis. *Clin Med (Lond)*. 2016 Dec;16(6):514–523. <https://doi.org/10.7861/clinmedicine.16-6-514>. PMID: 27927814; PMCID: PMC6297344.
1. Landoni G, Comis M, Conte M, Finco G, Mucchetti M, Paternoster G, Pisano A, Ruggeri L, Alvaro G, Angelone M, Bergonzi PC, Bocchino S, Borghi G, Bove T, Buscaglia G, Cabrini L, Callegher L, Caramelli F, Colombo S, Corno L, Del Sarto P, Feltracco P, Forti A, Ganzaroli M, Greco M, Guaracino F, Lembo R, Lobreglio R, Meroni R, Monaco F, Musu M, Pala G, Pasin L, Pieri M, Pisarra S, Ponticelli G, Roasio A, Santini F, Silvetti S, Székely A, Zambon M, Zucchetti MC, Zangrillo A, Bellomo R. Mortality in Multicenter Critical Care Trials: An Analysis of Interventions With a Significant Effect. *Crit Care Med*. 2015 Aug;43(8):1559–68. <https://doi.org/10.1097/CCM.0000000000000974>. PMID: 25821918.
2. Macrea M, Oczkowski S, Rochweg B, Branson RD, Celli B, Coleman JM 3rd, Hess DR, Knight SL, Ohar JA, Orr JE, Piper AJ, Punjabi NM, Rahangdale S, Wijkstra PJ, Yim-Yeh S, Drummond MB, Owens RL. Long-Term

- Noninvasive Ventilation in Chronic Stable Hypercapnic Chronic Obstructive Pulmonary Disease. An Official American Thoracic Society Clinical Practice Guideline. *Am J Respir Crit Care Med*. 2020 Aug 15;202(4):e74–e87. <https://doi.org/10.1164/rccm.202006-2382ST>. PMID: 32795139; PMCID: PMC7427384.
3. Wilson ME, Dobler CC, Morrow AS, Beuschel B, Alsawas M, Benkhadra R, Seisa M, Mittal A, Sanchez M, Daraz L, Holets S, Murad MH, Wang Z. Association of Home Noninvasive Positive Pressure Ventilation With Clinical Outcomes in Chronic Obstructive Pulmonary Disease: A Systematic Review and Meta-analysis. *JAMA*. 2020 Feb 4;323(5):455–465. <https://doi.org/10.1001/jama.2019.22343>. PMID: 32016309; PMCID: PMC7042860.
 4. Wang T, Zhang L, Luo K, He J, Ma Y, Li Z, Zhao N, Xu Q, Li Y, Yu X. Noninvasive versus invasive mechanical ventilation for immunocompromised patients with acute respiratory failure: a systematic review and meta-analysis. *BMC Pulm Med*. 2016 Aug 27;16(1):129. <https://doi.org/10.1186/s12890-016-0289-y>. PMID: 27567894; PMCID: PMC5002326.

Topic: Acute respiratory failure and mechanical ventilation

000465

Comparison the performance of the Simplified Mortality Score for the Intensive Care Unit and Sepsis Severity Score for predicting 90-day mortality in sepsis patientsB. Khwannimit¹, N. Sathaporn², R. Jomsuriya³¹Prince of Songkla University, Hat Yai, Songkhla, Thailand, Department of Internal Medicine, Faculty of Medicine, Hat Yai, Thailand; ²Internal medicine, Prince of Songkla University, Hat Yai, Thailand; ³Internal Medicine, Prince of Songkla University, Tambon Kho Hong, Thailand**Correspondence:** B. Khwannimit*Intensive Care Medicine Experimental* 2023, **11(Suppl 1)**:000465

Introduction: The commonly use severity scores were developed to predict in-hospital mortality. Recently, the Simplified Mortality Score for the Intensive Care Unit (SMS-ICU) was devised as a new model for predicting 90-day mortality in critically ill patients. The aim of this study was to compare the performance of the SMS-ICU with the Sepsis Severity Score (SSS) and standard severity scores in predicting 90-day mortality in patients with sepsis.

Methods: A retrospective study was conducted in a medical ICU of a tertiary university teaching hospital in Thailand over a 4-year period. The primary outcome was all cause 90-day mortality, and the secondary outcome was in-hospital mortality.

Results: A total of 1161 sepsis patients were enrolled, 641 (55.2%) patients were classified to septic shock. The 90-day mortality and in-hospital mortality were 42.4% and 41.5%. Community-acquired infection was classified in 750 patients (64.6%). Hemocultures were positive for 318 patients (27.6%), and micro-organisms were isolated from 941 patients (81%). The most common source of infection was respiratory tract infection (58.6%). Most patients (89.2%) needed mechanical ventilator support. Our sepsis patients had the SMS-ICU score ranges from 3 to 35 and SSS ranges from 13 to 138. The 90-day mortality gradually increased correlate with increasing the range of each score. The SMS-ICU had moderate discrimination for predicting 90-day mortality with an AUC 0.71 (95% CI 0.680–0.740) in contrast, the SSS present a good discrimination with an AUC 0.876 (95% CI 0.856–0.896). The AUC of SSS was significantly higher than that of the SMS-ICU ($p < 0.001$). However, the APACHE IV score provided the highest AUC for predicting 90-day and in-hospital mortality followed by SAPS II, APACHE II, SSS and was lowest for SMS-ICU. The AUCs of 90-day and in-hospital mortality of SMS-ICU and SSS were significantly lower than that of other standard severity scores (Figure 1). The SMS-ICU underestimated predicting 90-day and in-hospital mortality with SMR 1.36 (95% CI 1.24–1.48) and 1.33 (95% CI 1.22–1.46). The SSS presented appropriate estimating 90-day and in-hospital mortality with SMR 1.01 (95% CI 0.93–1.11) and 0.99 (95% CI 0.91–1.09). Similar with other standard severity scores, both SMS-ICU and SSS provide poor calibration for predicting 90-day mortality (Figure 2) and in-hospital mortality. The SSS had better overall performance than the SMS-ICU (Brier score 0.169 vs. 0.222 for 90-day mortality and 0.168 vs. 0.224 for in-hospital mortality, respectively).

Conclusions: The SSS had better discrimination and overall performance than the SMS-ICU. However, both scores poorly calibrated. The SMS-ICU score needs to be modified or we need to make a new specific model to predict 90-day mortality in patients with sepsis.

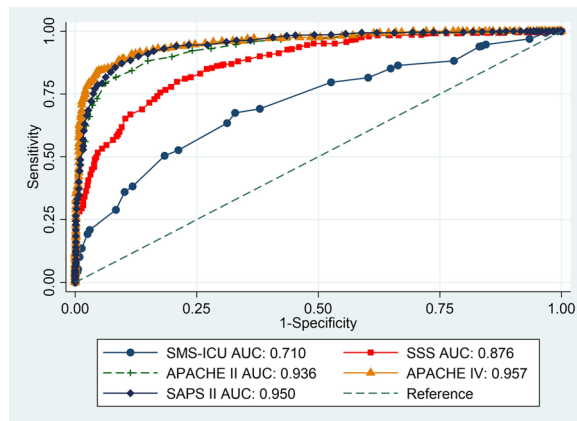

Figure 1 (abstract 000465) Comparison of ROC curves to predict 90-day mortality by SMS-ICU, SSS, APACHE II, IV and SAPS II

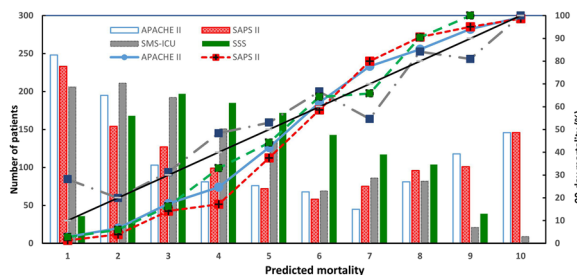

Figure 2 (abstract 000465) Calibration curves for SMS-ICU, SSS, APACHE II, IV and SAPS II

Topic: Critical care organisation, quality management, information systems, outcomes

000466

Effects of low positive end-expiratory pressure and pressure support on regional ventilation assessed by electrical impedance tomography during spontaneous breathing trials in specific patient populations. An interim report

M. Konaka¹, Y. Shimotani¹, T. Nakazawa¹, T. Santanda², M. Nabeshima¹, N. Yasuhiro²

¹Critical Care Medicine, Tokyo Bay Urayasu Ichikawa Medical Center, Urayasu, Japan; ²Emergency & Critical Care, Tokyo Bay Urayasu Ichikawa Medical Center, Urayasu, Japan

Correspondence: M. Konaka

Intensive Care Medicine Experimental 2023, **11(Suppl 1)**:000466

Introduction: Although positive end-expiratory pressure (PEEP) of 5 mmHg and/or pressure support (PS) of 5 mmHg have been frequently used as “minimal or no ventilator support” in daily practice, it is physiologically expected that even low PEEP and/or PS can be beneficial and possibly lead to overestimation of breathing abilities

in specific populations such as patients with chronic obstructive pulmonary disease (COPD), reduced left ventricular function and obesity. There are few studies investigating the effects of low PEEP and PS on regional ventilation using Electrical impedance tomography (EIT) during SBT in such populations.

Objectives: This study aimed to examine the effects of PEEP and PS of 5 cmH₂O on regional ventilation during SBT in various groups of patients.

Methods: Patients on mechanical ventilation who were planned to be extubated were included in this study and classified into 4 groups (group 1: COPD, group 2: reduced left ventricular function, group 3: obesity, group 4: others). Patients who belong to more than one group were excluded. A 30-min SBT was divided into three 10-min phases to assess changes in ventilation distribution on supine position. Phase 1 with a PEEP and PS of 5 mmH₂O; Phase 2 with a PEEP of 0 mmH₂O and PS of 5 mmH₂O; and Phase 3 with T-piece. Respiratory impedance changes in ventral and dorsal regions were recorded on EIT throughout the trials. All participants were extubated within 10 min after passing the SBT.

Results: So far, a total of 49 patients have been enrolled in this study. Statistical analyses have not been conducted yet with this sample size. Only patients in group 3 showed a tendency that the elimination of PEEP (shift from phase 1 to 2) reduces ventilation in ventral regions (median change in ΔZ : -3.5 AU). Patients in group 3 and 4 showed a tendency that the elimination of PEEP (shift from phase 1 to 2) reduces ventilation in dorsal regions (median change in ΔZ : -1.04 AU and -1.78 AU, respectively). All patients had the tendency that the elimination of PS (shift from phase 2 to 3) reduces ventilation in both ventral and dorsal regions.

Conclusions: This interim report indicates that even low PEEP and PS of 5 cmH₂O affect regional ventilation during SBT and may vary among specific patient populations.

Topic: Acute respiratory failure and mechanical ventilation

000467

Impaired microcirculation is associated with prolonged vasopressor and mechanical ventilation requirements after cardiac surgery

J. Greenwood¹, F. Talebi², D. Jang², A. Spelde³, T. Kilbaugh⁴, F. Shofer², J. G. Augoustides⁵, J. Bakker⁶, J. Brenner⁷, V. Muzykantor⁸, B. Abella⁹

¹Departments of Emergency Medicine, Anesthesiology & Critical Care, Perelman School of Medicine at the University of Pennsylvania, Philadelphia, United States of America; ²Department of Emergency Medicine, University of Pennsylvania, Philadelphia, United States of America; ³Department of Anesthesiology & Critical Care, Perelman School of Medicine at the University of Pennsylvania, Philadelphia, United States of America; ⁴Anesthesiology & Critical Care, Children's Hospital of Philadelphia, Philadelphia, United States of America; ⁵Anesthesiology & Critical Care, Perelman School of Medicine at the University of Pennsylvania, Philadelphia, United States of America; ⁶Department of intensive Care Adults, Erasmus University Medical Center, Rotterdam, Netherlands; ⁷Division of Pulmonary & Critical Care Medicine, Perelman School of Medicine at the University of Pennsylvania, Philadelphia, United States of America; ⁸Department of pharmacology, University of Pennsylvania, Philadelphia, United States of America; ⁹Department of Emergency Medicine, Perelman School of Medicine at the University of Pennsylvania, Philadelphia, United States of America

Correspondence: J. Greenwood

Intensive Care Medicine Experimental 2023, **11(Suppl 1)**:000467

Introduction: Cardiac surgery with cardiopulmonary bypass is associated with microcirculatory derangements that are often transient, but associated with significant patient morbidity and mortality in small observational studies [1, 2]. Current resuscitation markers used to

assess tissue perfusion include systemic hemodynamics, lactate, and blood gas derived biomarkers, but these measurements may not adequately reflect tissue perfusion after cardiac surgery. Inadequate postoperative resuscitation efforts may lead to prolonged impairments in tissue perfusion, leading to multiorgan injury and poor clinical outcomes [3, 4].

Objectives: To examine the relationship between microcirculatory blood flow, organ dysfunction, and traditional physiologic measures of tissue perfusion after surgery.

Methods: Consecutive adult patients undergoing elective cardiovascular surgery were consented and enrolled in the study. Preoperative sublingual microcirculation measurements were obtained, followed by repeated measurements immediately upon ICU admission, then 4- and 24-h later. Clinical data, hemodynamics, and blood samples were obtained at each time point. Microcirculation videos were analyzed manually using ESICM 2nd consensus recommendations [5]. Patients who were weaned from vasopressors and mechanical ventilation within 48-h of their index operation were used as controls. Prolonged postoperative organ dysfunction was defined as ≤ 28 vasopressor and ventilator free days (VVFDs) at postoperative day 30.

Results: A total of 142 subjects were enrolled in the study, 131 were included in the final analysis. Mean age was 66 ± 11 years, 68% were male, and EuroSCORE II was 2.81 ± 3.8 . A total of 36 subjects (27%) had ≤ 28 VVFDs at day 30. Compared to controls, patients with prolonged organ dysfunction had lower postoperative perfused vessel density (22.5 ± 4.7 vs. 20.4 ± 3.9 mm/mm²; $p < 0.05$; Figure 1), prolonged capillary refill time (4.5 ± 1.3 vs. 5.1 ± 1.3 s; $p < 0.05$), and lower central venous pressure (11 ± 4 vs. 9 ± 4 ; $p < 0.05$) on ICU admission. There was no difference in ICU admission cardiac index and mean arterial pressure between the two groups. Arterial lactate, mixed venous oxygen saturation, and venous-to-arterial PCO₂ difference were also similar at ICU admission. Baseline (23.8 ± 5.2 vs. 22.8 ± 4.9 ; $p = 0.32$), 4-h (22.6 ± 5.2 vs. 21.1 ± 3.9 ; $p = 0.16$), and 24-h (23.9 ± 4.3 vs. 22.3 ± 5.0 ; $p = 0.1$) PVD were similar between control and prolonged organ dysfunction groups (Figure 2).

Conclusions: After cardiac surgery, early microcirculatory blood flow abnormalities after cardiac surgery are associated with significant cardiovascular and pulmonary dysfunction. Microcirculatory perfusion could thus prove to be an early therapeutic target for resuscitation.

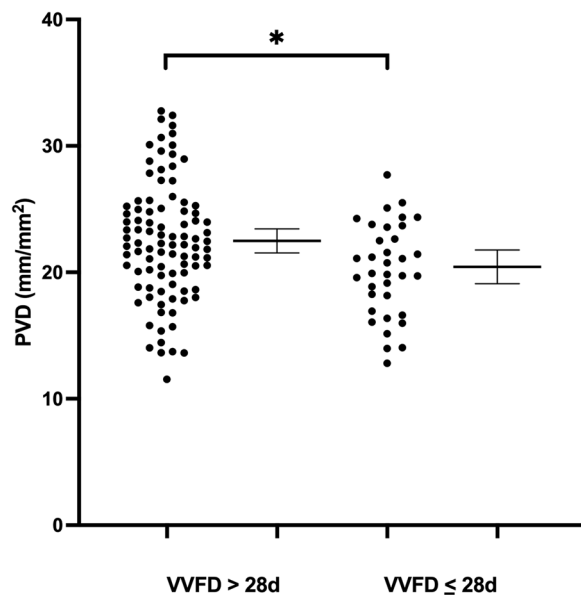

Figure 1 (abstract 000467) Perfused vessel density is lower in patients with prolonged vasoactive and mechanical ventilation requirements after cardiac surgery. Bars represent sample mean and 95% confidence interval

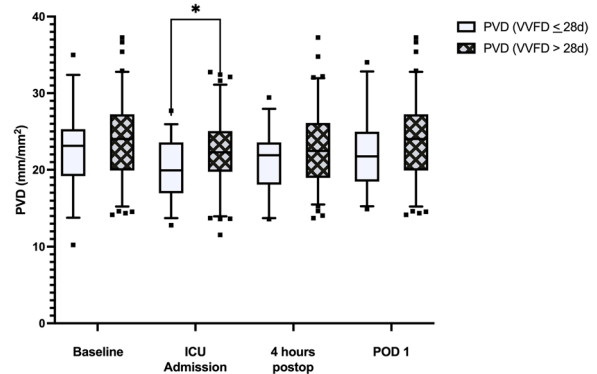

Figure 2 (abstract 000467) Changes in microcirculation perfused vessel density (PVD) over time. Patients with prolonged vasopressor and mechanical ventilation requirements had reduced microcirculatory flow on ICU admission, but similar values at baseline, 4-h after admission, and on postoperative day 1

References

- De Backer D, Dubois M-J, Schartz D, et al. (2009) Microcirculatory alterations in cardiac surgery: effects of cardiopulmonary bypass and anesthesia. *Ann Thorac Surg* 88:1396–1403. <https://doi.org/10.1016/j.athoracsur.2009.07.002>
- Schmittinger CA, Torgersen C, Luckner G, et al. (2012) Adverse cardiac events during catecholamine vasopressor therapy: a prospective observational study. *Intensive Care Med* 38:950–958. <https://doi.org/10.1007/s00134-012-2531-2>
- Suarez-Pierre A, Fraser CD, Zhou X, et al. (2019) Predictors of operative mortality among cardiac surgery patients with prolonged ventilation. *J Card Surg* 34:759–766. <https://doi.org/10.1111/jocs.14118>
- Ince C, Boerma EC, Cecconi M, et al. (2018) Second consensus on the assessment of sublingual microcirculation in critically ill patients: results from a task force of the European Society of Intensive Care Medicine. *Intensive Care Med* 44:281–299. <https://doi.org/10.1007/s00134-018-5070-7>
- Penn Abramson Critical Care & Resuscitation Research Fund
- National Center for Advancing Translational Sciences of the NIH KL2TR001879
- Greenwood JC, Jang DH, Hallisey SD, et al. (2021) Severe Impairment of Microcirculatory Perfused Vessel Density Is Associated With Postoperative Lactate and Acute Organ Injury After Cardiac Surgery. *Journal of Cardiothoracic and Vascular Anesthesia* 35:106–115. <https://doi.org/10.1053/j.jvca.2020.04.045>

Topic: Cardiovascular issues in ICU

000468

Prevalence of frailty and its effect on requirement of organ support and clinical outcomes in critically ill patients

N. Sahni¹, D. K. Singh², V. Saini¹, N. Yaddanapudi³

¹Anaesthesia and Intensive Care, Post Graduate Institute of Medical Education & Research, Chandigarh, Chandigarh, India; ²Anaesthesia & Intensive Care, Post Graduate Institute of Medical Education & Research, Chandigarh, Chandigarh, India; ³Anaesthesia and critical care, Post Graduate Institute of Medical Education & Research, Chandigarh, India

Correspondence: N. Sahni

Intensive Care Medicine Experimental 2023, **11(Suppl 1)**:000468

Introduction: Diagnosing frailty in ICU patients can help plan interventions to improve outcome.1

Objectives:

- To determine the prevalence of frailty in ICU patients based on Clinical Frailty Scale (CFS) within 24 h of admission.

2. To study effect of frailty on organ support requirement & clinical outcome.

Methods: After IEC approval & written informed consent, a prospective observational study was conducted in patients admitted to ICU from Feb2021 to Feb2022. Patients dying or getting discharged within 24 h and admitted for organ donation were excluded. The patients were categorized as Frail & Non-Frail, defining frailty as CFS ≥ 5, two weeks before index admission. The groups were compared for organ support requirement (vasoactive support, MV and RRT) & clinical outcomes (hospital & ICU LOS; hospital, ICU & 30-day mortality; HAI).

Results: The statistical analysis was done on Jamovi version 2.2.5. Out of 358 admissions to ICU, 317 were enrolled with 17 lost to follow up after ICU discharge.

Table 1 (abstract 000468) Demographic characteristics

Variable	All patients (n = 317)	Frail (n = 78)	Non-Frail (n = 239)	p-value
Age	41.6 ± 18.7	56.8 ± 17.3	36.7 ± 16.4	< 0.001
Gender				0.017
Male	154 (48.6)	47 (60.3)	107 (44.8)	
Female	163 (51.4)	31 (39.7)	132 (55.2)	
Level of education				0.091
Less than high school	183 (57.7)	43 (55.1)	140 (58.6)	
Undergraduate	111 (35.0)	25 (32.1)	86 (36.0)	
Postgraduate/doctorate	23 (7.3)	10 (12.8)	13 (5.4)	
Marital status				0.072
Single	63 (19.9)	10 (12.8)	53 (22.2)	
Married	254 (80.1)	68 (87.2)	186 (77.8)	
Family income	39.7 ± 54.1	62.5 ± 64.9	32.3 ± 47.9	< 0.001

The prevalence of frailty (CFS ≥ 5) was 24.6%. A significantly higher number of frail patients required vasoactive support. (Table 2)

Table 2 (abstract 000468) Organ support

Variable	Frail (n = 78)	Non-frail (n = 239)	Relative risk (95% CI)	p-value
MV	71 (91)	203 (84.9)	1.07 (0.98–1.62)	0.173
Vasoactive support	55 (70.5)	125 (52.5)	1.34 (1.11–1.61)	0.006
RRT	19 (24.4)	36 (15.1)	1.62 (0.98–2.62)	0.060

The median ICU LOS was 7 days [IQR, 3–7] in frail compared to 6 days [IQR, 3–10] in non-frail group. The median hospital LOS in frail patients was 18 days [IQR, 10–32] compared to 15 days [IQR, 8.25–26] in non-frail

ICU, hospital and 30-day mortality were significantly higher in frail patients (Table 3)

Table 3 (abstract 000468) ICU, hospital and 30-day mortality

Mortality	Frail	Non-frail	Relative risk (95% CI)	p-value
ICU	39/78 (50.0)	54/239 (22.6)	2.21 (1.60–3.06)	< 0.001
Hospital	41/76 (53.9)	60/224 (26.8)	2.01 (1.49–2.72)	< 0.001
30-day	46/76 (60.5)	68/224 (30.4)	1.99 (1.52–2.61)	< 0.01

Incidence of HAI in frail group was significantly higher (48.7%) as compared to non-frail group (20.9%) (p < 0.001).

Conclusions: The prevalence of frailty in ICU patients was 24.6% and a higher number of frail patients had requirement of vasopressor support, incidence of HAI and ICU, hospital and 30-day mortality.

References

1. Muscedere J, Waters B, Varambally A, et al. The impact of frailty on intensive care unit outcomes: a systematic review and meta-analysis. *Intensive Care Med* 2017;43:1105–22.
2. Darvall JN, Greentree K, Braat MS, Story DA, Lim WK. Contributors to frailty in critical illness: multi-dimensional analysis of the Clinical Frailty Scale. *J Crit Care* 2019; 52:19399.
3. None

Topic: Critical care organisation, quality management, information systems, outcomes

000473

The impact of BioFire FilmArray pneumonia panel results on mechanical-ventilated pneumonia patients

H. T. Chang¹, Z. H. Zhang¹, C. J. Lin²

¹Department of Critical Care Medicine, Far Eastern Memorial Hospital, New Taipei City, Taiwan; ²Department of Industrial Engineering and Management, Yuan Ze University, Taoyuan, Taiwan

Correspondence: H. T. Chang

Intensive Care Medicine Experimental 2023, **11(Suppl 1)**:000473

Introduction: The Biofire Filmarray Pneumonia Plus panel (FA-PP) has been proposed as a tool that can aid in the timely diagnosis and treatment of pneumonia but little evidence focus on its impact on mechanically-ventilated patients in real world. Also it is still unclear whether the use of FA-PP will improve the mortality rate of severe pneumonia patients in the intensive care unit. We evaluated the impact of FA-PP result on severe pneumonia patients who need mechanical ventilation in the intensive care unit.

Objectives: To evaluate the impact of Biofire Filmarray Pneumonia Plus panel (FA-PP) result on pneumonia patients who received mechanical ventilation in medical ICU.

Methods: This retrospective cohort study was conducted in medical ICU in northern Taiwan. From July 1, 2021 to Oct 31, 2022, all of the patients received mechanical ventilation in intensive care units were collected, while those who had clinical diagnosis of pneumonia and acute respiratory failure were enrolled. Demographic data, laboratory examinations, management records, timing of FA-PP and clinical outcomes were collected for analysis.

Results: During the study period, total 136 patients were enrolled for analysis. Among them, mean age was 66.87 (22–97) y/o, 95 patients (70%) were male, 58 patients (42.6%) had community-acquired pneumonia. Mean APACHE II score was 30.55 ± 8.47, and all of them received mechanical ventilation while enrollment. Fifty-two patients (38.2%) had discordant results between FA-PP and conventional sputum culture result, 28 patients (20.6%) received inappropriate antibiotics while FA-PP result available, and 33 patients (24.3%) escalated the antibiotics according to FA-PP result. 71 patients (52.2%) were nonsurvivors, they had higher APACHE II score (32.17 ± 8.572 vs. 28.78 ± 8.055, p = 0.019), had more malignant diagnosis (27 vs. 11, p = 0.007), and the interval between ICU admission and FA-PP implementation was longer (2.90 ± 6.27 vs. 0.97 ± 6.28, p = 0.016) as compared to survivors.

Conclusions: In the present study, in evaluation of impact of FA-PP on pneumonia patients with mechanical ventilation, late initiation of FA-PP after ICU admission is associated with mortality in addition to higher APACHE score and malignancy diagnoses. Application of FA-PP result may decreased inappropriate antibiotics and increased the opportunity of precise antibiotics to treat severe pneumonia patients who need mechanical ventilation.

References

1. FEMH-2023-C-022

Topic: Acute respiratory failure and mechanical ventilation

000474

Critically ill cirrhotic patients admitted to ICU. What is the benefit?

R. Yébenes¹, J. Vejo¹, A. Agrifoglio¹, J. Rábano¹, J. Soto¹, L. Cachafeiro¹, E. Graciani¹, B. Guzmán¹, M. Lavara¹

¹Intensive Care Unit, Hospital Universitario La Paz, Madrid, Spain, Spain

Correspondence: R. Yébenes

Intensive Care Medicine Experimental 2023, **11(Suppl 1)**:000474

Introduction: Cirrhotic patients requiring intensive care have higher morbidity and mortality compared to other critically ill patients. Their prognosis is influenced by both the severity of the underlying liver disease and the worsening of extrahepatic organ function. Since intensivists need objective prognostic measurements when making decisions, such as triage or treatment limitations, we conducted a retrospective study over a five-year period to reassess the prognosis of cirrhotic patients admitted to ICU.

Objectives: To evaluate the hospital mortality of cirrhotic patients admitted to our ICU as well as the development of organ failure during their admission.

Methods: All patients with clinical and/or histological diagnosis of liver cirrhosis admitted to ICU between January 2018 and December 2022 were retrospectively included. Liver transplantations were excluded and the following data were collected: demographic and epidemiological data, reason for admission to ICU, developed organ failure, need for organ support (Mechanical Ventilation MV, Continuous Renal Replacement Therapy CRRT and vasoactive drugs) and mortality in ICU.

Results: During the study period, 4790 patients were admitted to ICU. The mean APACHE II score was 17 points. Of these, 170 patients had liver cirrhosis diagnosis at admission, with mean APACHE II score of 19 points. The mean age was 51.5 ± 11 years and 70% were men. The mean length of stay for that subgroup was 7.5 days. Among the reasons for admission, 12% were related to complications directly associated with liver disease and 88% due to common causes of admission to ICU such as community and nosocomial sepsis, polytrauma, post-operative patients, neurocritically ill patients, exacerbation of COPD, intoxications, acute pulmonary edema or cardiac arrest. Cirrhotic patients, compared to the total number of patients admitted to ICU, required MV in 38% vs. 39%, CRRT in 18% vs. 10%, and shock needing vasoactive drugs in 75% vs. 40%. The mortality of cirrhotic patients was higher than expected for their APACHE II (40% vs. 17–27%) and, in relation to subgroups, mortality was 99% if CRRT was required, 83% for those requiring vasoactive drugs and 70% if they were on MV for more than 48 h.

Conclusions: The cirrhotic status of our patients resulted in a high mortality in ICU admission, higher than expected for their APACHE II, even if the reason for admission was for extrahepatic causes in 88% of them. The prognosis was poor if the patient developed organ failure on admission. Among the patients who survived their ICU stay, 48% died within a year. Therefore, after obtaining these data in our center and needing more studies about cirrhotic patients, we consider that the risk/benefit of ICU admission for patients with these characteristics should be individualized to make rational use of resources.

References

1. Choi C, Choi DH, Spears GM, Peeraphatdit TB, Serafim LP, Gajic O, Kamath PS, Shah VH, Gallo de Moraes A, Simonetto DA. Relationship Between Etiology of Cirrhosis and Survival Among Patients Hospitalized in Intensive Care Units. *Mayo Clin Proc.* 2022 Feb;97(2):274–284.
2. Lai CC, Tseng KL, Ho CH, Chiang SR, Chan KS, Chao CM, Hsing SC, Cheng KC, Chen CM. Outcome of liver cirrhosis patients requiring prolonged mechanical ventilation. *Sci Rep.* 2020 Mar 18;10(1):4980.
3. Paugam-Burtz C, Levesque E, Louvet A, Thabut D, Amathieu R, Bureau C, Camus C, Chanques G, Faure S, Ferrandière M, Francoz C, Galbois A, Gustot T, Ichai C, Ichai P, Jaber S, Lescot T, Moreau R, Roulet S, Saliba F,

- Thévenot T, Velly L, Weiss E. Management of liver failure in general intensive care unit. *Anaesth Crit Care Pain Med.* 2020 Feb;39(1):143–161.
4. Velarde-Ruiz Velasco JA, García-Jiménez ES, Aldana-Ledesma JM, Tapia-Calderón DK, Tornel-Avelar AI, Lazcano-Becerra M, Chávez-Ramírez RM, Cano-Contreras AD, Remes-Troche JM, Colunga-Lozano LE, Montañoloza A. Evaluation and management of emergencies in the patient with cirrhosis. *Rev Gastroenterol Mex (Engl Ed).* 2022 Apr-Jun;87(2):198–215.
5. Das V, Boelle PY, Galbois A, Guidet B, Maury E, Carbonell N, Moreau R, Offenstadt G. Cirrhotic patients in the medical intensive care unit: early prognosis and long-term survival. *Crit Care Med.* 2010 Nov;38(11):2108–16.
6. Gines P, Fernández J, Durans F, Saliba F. Management of critically-ill cirrhotic patients. *J Hepatol.* 2012;56 Suppl 1:S13-24.
7. To all our patients, their gratifying families and all the health team that work daily at the Intensive Care Unit in Hospital La Paz and made possible this study.

Topic: Metabolism, endocrinology, liver failure and nutrition

000475

Rapid temperature increases under isoflurane sedation

M. Graf¹, F. Albrecht¹, L. M. Müller-Wirtz², T. Volk¹, A. Meiser¹

¹Department of Anaesthesiology, Intensive Care and Pain Therapy, Saarland University Hospital, Homburg, Germany; ²Department of OUTCOMES RESEARCH, Anesthesiology Institute, Cleveland Clinic, Cleveland, United States of America

Correspondence: M. Graf

Intensive Care Medicine Experimental 2023, **11(Suppl 1)**:000475

Introduction: Intensive care patients often need sedation to better tolerate stressful life-sustaining measures (e.g. endotracheal intubation, mechanical ventilation). Impairment of thermoregulation by inhaled and intravenous anesthetics has been extensively studied and essentially all anesthetics blunt thermoregulatory responses [1]. Interestingly, isoflurane—unlike propofol—exhibits a non-linear dose-response, suggesting largely preserved thermoregulatory responses within low sedative doses [2, 3].

Objectives: We therefore hypothesized that an infection-associated increase in body temperature differs between isoflurane and propofol sedation.

Methods: According to STROBE guidelines, we performed a (retrospective) observational study over a period of one year. Patients needed to be ventilated for at least 96 h and received isoflurane or propofol for at least 48 h. Core temperatures were measured via urinary catheter temperature probes, collected digitally, and validated by an intensive care nurse. Prevalence of fever (≥ 38.5 °C) and temperature increases on fever days were assessed and adjusted for age, sex, body mass index, opioid intake, sedation day, SAPS II, and SOFA scores using logistic or linear generalized estimating equations regression.

Results: 97 patients were included; they received isoflurane ($n = 13$), propofol ($n = 21$), or both sedatives ($n = 63$). Across a total of 725 sedation days, patients were given isoflurane on 257 (35%) days and propofol on 468 (65%) days. Fever was twice as common in patients receiving isoflurane: 41/257 days (16%) vs. 41/468 days (9%); adjusted odds ratio [95% CI]: 2.4 [1.1, 5.1], $p = 0.021$.

Temperature increases on fever days were more rapid in patients receiving isoflurane, in whom both the fever threshold (≥ 38.5 °C) and peak temperatures were reached more quickly: average difference [95% CI]: -320 [$-454, -187$] min, $p < 0.001$; and -302 [$-465, 138$] min, $p < 0.001$ (Figure 1). Maximum increases observed within 1 or 2 h were significantly greater under isoflurane than propofol sedation, respectively: 0.13 [0.02, 0.23] °C/h, $p = 0.019$; and 0.17 [0.05, 0.29] °C/2 h, $p = 0.006$ (Figure 1). Baseline temperatures were slightly higher in isoflurane-sedated patients: 0.33 [0.07, 0.59] °C, $p = 0.012$; but peak temperatures were similar: 0.07 [$-0.09, 0.23$], $p = 0.407$. Procalcitonin and leucocyte count on fever days were indicative of infection and did not differ between the two groups. Symptoms of malignant hyperthermia (e.g., unexplained increases in end-tidal carbon dioxide, muscle rigidity, increased laboratory markers of muscle damage) did not occur.

Conclusions: Faster and steeper temperature rises were observed with isoflurane compared to propofol sedation, most probably due to better-preserved thermoregulatory responses with isoflurane sedation. The clinical significance of our findings remains to be determined.

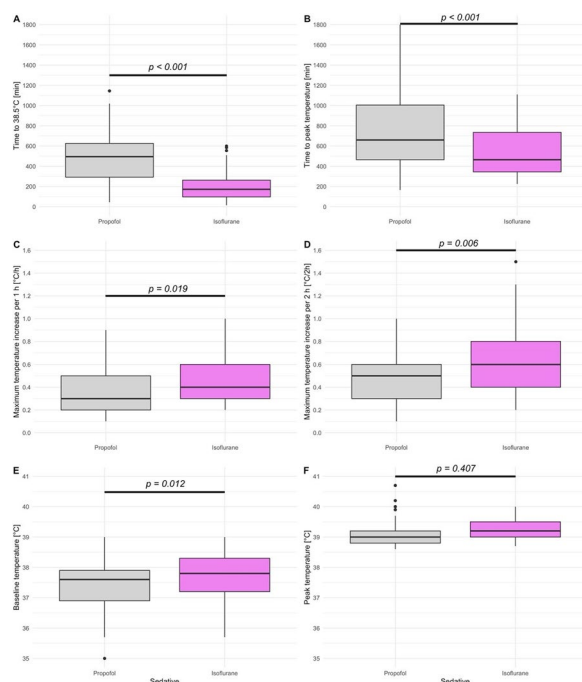

Figure 1 (abstract 000475) Body temperature increases—isoflurane versus propofol sedation

Differences in the characteristics of core temperature increases between patients receiving isoflurane (pink) or propofol (grey) were assessed by linear generalized estimating equations regression adjusted for age, sex, body mass index, opioid intake, sedation day, SAPSII, and SOFA scores. Boxplots show median, quartiles, 95-percentiles and outliers

References

- [1] Sessler DI (2008) Temperature monitoring and perioperative thermoregulation. *Anesthesiology* 109:318–38. <https://doi.org/10.1097/ALN.0b013e31817f6d76>
- [2] Matsukawa T, Kurz A, Sessler DI, et al. (1995) Propofol Linearly Reduces the Vasoconstriction and Shivering Thresholds. *Anesthesiology* 82:1169–1180. <https://doi.org/10.1097/00000542-199505000-00012>
- [3] Xiong J, Kurz A, Sessler DI, et al. (1996) Isoflurane Produces Marked and Nonlinear Decreases in the Vasoconstriction and Shivering Thresholds. *Anesthesiology* 85:240–245 <https://doi.org/10.1097/00000542-199608000-00003>.
- We acknowledge Ms. Gudrun Wagenpfeil for her statistical advice.

Topic: Sedation, analgesia and delirium

000476

An interactive, e-learning platform-based training to improve Intensive Care professionals' knowledge regarding central venous catheter-related infections

M. Foka¹, T. Kyprianou², N. Stylianides³, L. Paikousis⁴, G. Christodoulou⁵, L. Palazis⁶, M. Kyranou⁷, E. Papatthanassoglou⁸, E. Lambrinou⁹
¹Intensive Care Unit Nicosia General Hospital, Clinical Educator, Nicosia, Cyprus; ²St Georges' Univ. of London Medical programs at UNIC, Professor of Medicine, Nicosia, Cyprus; ³Leafnet, Dr. Eng. in Electrical & Computer Engineering eLearning Technical Editor, Nicosia, Cyprus; ⁴Improvast, Data scientist, Nicosia, Cyprus; ⁵Leafnet, eLearning Technical Editor,

Nicosia, Cyprus; ⁶Intensive Care Unit Nicosia General Hospital, ICU Director, Nicosia, Cyprus; ⁷Department of Nursing, Cyprus University of Technology, Assistant Professor, Nicosia, Cyprus; ⁸Faculty of Nursing, University of Alberta, Professor, Edmonton, Canada; ⁹Department of Nursing, Cyprus University of Technology, Professor, Limassol, Cyprus

Correspondence: M. FOKA

Intensive Care Medicine Experimental 2023, **11(Suppl 1)**:000476

Introduction: Central venous catheters (CVCs) are the lifelines of the critically ill, as they enable the co-administration of life-saving medications, fluids, blood products, and parenteral nutrition (Lee et al., 2018). At the same time, in situ CVCs are associated with a high risk of bloodstream infections that increase morbidity, mortality, and cost of care (Bearman et al., 2005; Allen et al., 2014; Ziegler et al., 2014). In 2011 (edited 2017), the Centers for Disease Control and Prevention (CDC) issued global recommendations on CVCs care and the prevention CVCs related infections (O'Grady et al., 2011). However, their implementation is hampered by gaps in ICU professionals' knowledge and training (Koutzavekiaris et al., 2011; Bianco et al., 2013; Dedunska and Dyk, 2015; Dyk et al., 2021). Several studies, recently reviewed by our team (Foka M et al., 2021) have shown that education and training programs can reduce the risk of CVCs-related infections, however, the ICU environment poses significant, escalating, time and physical presence-related educational constraints. e-Learning/distance learning in various formats has been extensively used in healthcare training (Vaona et al., 2018), however, effectiveness data, particularly in demanding environments like ICUs are scarce.

Objectives: This study aimed to assess the impact of an e-learning platform-based training program, on ICU professionals' knowledge regarding the prevention of CVC-related infections. The primary outcome was the improvement in participants' knowledge. Secondary outcomes included ICU professionals' satisfaction and the time they spend completing the interactive, distance learning education.

Methods: A prospective, quasi-experimental questionnaire-based study, to assess attitudes and theoretical knowledge of ICU nurses regarding the prevention of CVCs-related infections, before and after an e-Learning platform facilitated educational intervention. CRE-DEPTH guidelines were used for intervention development. The study was conducted in a twenty-three beds, multidisciplinary Intensive Care Unit/High Dependency Unit in a tertiary referral Hospital, and the participants were all nurses and intensivists working in both units during the study. An interactive, distance learning e-course was developed and delivered by TELEPROMETHEUS educational platform. To assess ICU professionals' attitudes and theoretical knowledge regarding the prevention of CVCs related infections, before and after education, a Greek version of the questionnaire originally developed by Labeau et al. (2008) and modified by Dedunska et al. (2015) was used. The questionnaire assesses health professionals' knowledge of evidence-based guidelines for preventing infections associated with central venous catheters. The questionnaire was translated into the Greek language (Brislin Richard, 1070), and the translation's semantic, idiomatic, experiential, and conceptual equivalence was checked by an expert committee. Furthermore, participants were asked about their view of the interactive, distance e-course and the time they spent completing the education, through a questionnaire specifically designed for this study. For checking the reliability of the questionnaire, a pilot study was conducted.

Results: Prior to the online, interactive, distance education, the mean total knowledge score was $\bar{x} = 4.8$ ($SD = 2.46$) while after the mean total knowledge score increased to $\bar{x} = 8.9$ ($SD = 2.38$) ($p < 0.001$). Physicians had a higher mean total knowledge score ($\bar{x} = 10.20$) than nurses ($\bar{x} = 8.75$) after the intervention. There was no correlation between years of experience in ICU with the level of knowledge ($r = 0.048$). The interactive, distance education was positively evaluated by the participants.

Conclusions: The current study demonstrated that nurses and physicians had a good level of knowledge regarding the CDC guidelines for preventing CVC-related infections before the education. It is very important though, that even starting from a higher level of pre-intervention knowledge, significant improvement can be observed using

an eLearning platform-based, unsupervised training program. Our results showed that in high-intensity work environments, such as ICUs, adopting innovative solutions seems today more necessary than ever.

References

1. Bianco, A. et al. (2013) 'The reduction of risk in central line-associated bloodstream infections: Knowledge, attitudes, and evidence-based practices in health care workers', *American Journal of Infection Control*, 41(2), pp. 107–112. <https://doi.org/10.1016/j.ajic.2012.02.038>.
2. Bearman, G. M. L. and Wenzel, R. P. (2005) 'Bacteremias: A leading cause of death', *Archives of Medical Research*, 36(6), pp. 646–659. <https://doi.org/10.1016/j.jarcmed.2005.02.005>.
3. Dedunska, K. and Dyk, D. (2015) 'Prevention of central venous catheter-associated bloodstream infections: A questionnaire evaluating the knowledge of the selected 11 evidence-based guidelines by Polish nurses', *American Journal of Infection Control*. Elsevier Inc, 43(12), pp. 1368–1371. <https://doi.org/10.1016/j.ajic.2015.07.022>.
4. Allen, G. B. et al. (2014) 'A multitiered strategy of simulation training, kit consolidation, and electronic documentation is associated with a reduction in central line-associated bloodstream infections', *American Journal of Infection Control*. Elsevier Inc, 42(6), pp. 643–648. <https://doi.org/10.1016/j.ajic.2014.02.014>.

Topic: Nursing care and physiotherapy

000477

Effects of fluid loading and extravascular lung water on the total fluid content measured by bioimpedance

D. Rosalba¹, R. M. Shi², C. Bruscaignin¹, C. Lai³, G. Fouqué⁴, J. Hagry¹, J. L. Teboul⁵, X. Monnet⁶

¹Médecine Intensive - réanimation, Bicetre Hospital, Le Kremlin-Bicêtre, France; ²Service de médecine Intensive - réanimation, Hôpital de Bicêtre, Université Paris-Sud, Le Kremlin-Bicêtre, France; ³Médecine Intensive réanimation, Bicetre Hospital AP-HP, Le Kremlin-Bicêtre, France; ⁴Intensive Care Medicine, Bicetre Hospital, Le Kremlin-Bicêtre, France; ⁵Réanimation médicale, CHU de Bicêtre, Le Kremlin Bicêtre, France; ⁶Médecine Intensive - réanimation, inserm umr s_999, FHU sepsis, groupe de recherche carmas, Bicetre Hospital AP-HP Université Paris-Saclay DMU CORREVE, Le Kremlin-Bicêtre, France

Correspondence: D. Rosalba

Intensive Care Medicine Experimental 2023, **11(Suppl 1)**:000477

Introduction: The Starling system (Baxter, Deerfield, IL, USA) is a non-invasive hemodynamic monitoring device that measures cardiac output through bioactance. Through bioimpedance, it also measures the mean transthoracic electric impedance (Z0), from which the thoracic fluid content (TFC) can be derived, which should reflect extravascular lung water, fluid in the large thoracic vessels and the cardiac cavities. We compared TFC to the extravascular lung water indexed for ideal body weight (EVLWI) and the global end-diastolic volume index for body surface (GEDVI) estimated by transpulmonary thermodilution (TPTD).

Methods: A group of patients with shock and another one with acute respiratory distress syndrome (ARDS) were included. All the patients were equipped with calibrated TPTD device (PiCCO₂, Getinge, Sweden) and the Starling system. Variables measured by TPTD and by the Starling system were collected at the same time before and after volume expansion (500 mL saline) for shock patients, and once a day during the course of the disease for ARDS patients.

Results: In the 42 patients receiving a fluid bolus, TPTD-derived cardiac output increased by 0.44 [−0.16–1.06] (22.5%) L/min/m² and bioactance-derived cardiac output by 0.22 [−0.72–1.16] (11.8%) L/min/m². GEDVI increased by 43.8 [−11.9–99.5] (7.6%) ml/m² and TFC by 2.4 [−0.3–5.1] (3%). EWLVI decreased by 0.02 [−1.83–1.79] (0.25%) ml/kg. There was no correlation between the fluid-induced changes in GEDVI or in EWLVI on the one side and in TFC on the other (p=0.95 and p=0.58).

In the 23 patients with ARDS, 124 measurements were performed. Between two successive measurements, EVLWI changed by −0.1 (6.3%) ml/kg and the TFC by −0.4 (4.6%). There was no correlation between the changes in EVLWI and in TFC between successive time-points (p=0.42).

Considering all measurement together (n=166), there was no correlation between the absolute values of GEDVI and TFC (p=0.16), EVLWI and TFC (p=0.06) and the sum of GEDVI and EVLWI on the one side and TFC on the other (p=0.19). Still considering all measurements, there was no correlation between the bias between the sum of GEDVI and EVLWI vs. TFC on the one side and the bias between TPTD- and bioactance-derived cardiac output on the other (p=0.29).

Conclusions: In patients with shock or ARDS, there is no significant relationship between TFC measured by bioimpedance and GEDVI or EVLWI measured by TPTD, neither in absolute values, nor in relative changes.

Topic: Cardiovascular issues in ICU

000478

Epidemiological features of age factor in critical illness and effects on survival

I. Erus¹, E. Aygün¹, E. Senturk², Z. Cukurova³, S. Asar³, K. E. Tulubas³, E. Canan⁴, N. Cakar¹

¹Anesthesiology and Intensive Care Unit, Koç University Hospital, Istanbul, Turkey; ²Anesthesiology and Reanimation, Koc University, Istanbul, Turkey; ³Anesthesiology and Reanimation, Sadi Konuk Research Hospital, Istanbul, Turkey; ⁴Metavision, Qlinicu, Istanbul, Turkey

Correspondence: E. Senturk

Intensive Care Medicine Experimental 2023, **11(Suppl 1)**:000478

Introduction: The rise in the elderly patient population increases the frequency and percentage of intensive care unit (ICU) admissions.

The World Health Organization (WHO classification) set a chronological limit of 65 years of age human lifespan in 2007. While the age range of 66–79 is expressed as middle age, the age range between 80 and 100 expressed as old.

Before the WHO classification (BWHO), aging classes were 65–74 years as young old age, 75–84 years as advanced old age, 85 years and over as very advanced old age.

Objectives: Our aim is to retrospectively scan the hospitalization rates and characteristics of these age groups and to investigate the differences between the groups in terms of survival.

Methods: Patients who were hospitalized for longer than 48 h at Vehbi Koç Foundation in the American Hospital and Bakırköy Sadi Konuk Training and Research Hospital between 2005 and 2019, whose ethics committee approval was obtained, were retrospectively screened from electronic recording systems (ERS, Metavision). Demographic characteristics of the patients, age, place of admission to the ICU (emergency unit, service, external center, nursing home, etc.), ICU length of stay (LOS), admission APACHE II and SOFA scores, and survival were examined. The differences between the age groups were analyzed by the Kruskal Wallis and Mann Whitney-U test, which were statistically analyzed on SPSS. The difference between their mortality was examined by X-Square test. Analysis was performed according to four different age groups of BWHO.

Results: Data of 4754 patients were analyzed retrospectively and demographic data according to both classifications are shown in Table 1. Mortality, ICU LOS, mechanical ventilation duration are also given. Being over 65 years of age significantly increases mortality compared to being under 65 years old. However, when the groups over 65 years of age are examined, being older than 65 does not increase mortality significantly.

Conclusions: Our results suggest that in patients over 65 the age increase is not the major determinant of mortality. As pointed with the saying "In the end it's not the years in your life that count; it is life in your years."

Table 1 (abstract 000478) Age and mortality

	Age: 18-65	Age: 65-74	Age: 75-84	Age>85	P values
APACHE II Median(min/max)	17(2/44) ^a	20(2/45) ^a	22(6/46) ^a	23(6/51) ^a	<0,0001
SOFA Median(min/max)	5(1/23) ^a	6(1/20) ^a	7(1/21) ^a	6(1/21) ^a	<0,0001
ICU length of stay/day Median(min/max)	6,3(2/247) ^a	5,5(2/164) ^a	6,1(2/110) ^a	5,8(2/91) ^a	0,014
Mechanical ventilation time/h Median(min/max)	87(1/4290) ^a	78(1/2504) ^a	80(1/2477) ^a	70(1/1139) ^a	0,037
Numbers of patient	2296	1021	900	537	4754
Mortality %	28 ^a	32,6 ^b	36,3 ^b	34,3 ^b	0,0001

References

- Katarzyna Kotfis a, Xavier Wittebole b, Ulrich Jaschinski c, Jordi Solé-Violán d, Rahul Kashyap e, Marc Leone f, Rahul Nanchal g, Luis E. Fontes h, Yasser Sakr i, Jean-Louis Vincent j,*, on behalf of the ICON Investigators 1. A worldwide perspective of sepsis epidemiology and survival according to age: Observational data from the ICON audit. *Journal of Critical Care* 51 (2019) 122–132
- none

Topic: Critical care organisation, quality management, information systems, outcomes

000479

Collaborative governance to advance the Dutch ICU Data Warehouse, a full-admission and multicenter electronic health records database for critically ill patients

M. Otten¹, A. Jagesar¹, T. A. Dam¹, L. A. Biesheuvel¹, D. M. Ouweneel¹, G. Klop², L. Derks², L. Fleuren³, R. H. Driessen¹, P. J. Thorax¹, A. Girbes¹, J. Rubrech⁴, D. A. Dongelmans⁵, B. C. Van Bussel⁶, M. E. Hoogendoorn⁷, M. Van Mol³, E. C. Boersma⁸, P. Elbers¹, ICU Data⁹

¹Intensive Care Adults, Amsterdam UMC, locatie VUmc, Amsterdam, Netherlands; ²ICUdata, Pacmed, Amsterdam, Netherlands; ³Intensive Care, Erasmus MC, Rotterdam, Netherlands; ⁴ICUdata, Zorgverbeteraars, Roden, Netherlands; ⁵Intensive Care, Amsterdam UMC, locatie AMC, Amsterdam, Netherlands; ⁶Intensive Care, Maastricht UMC, Maastricht, Netherlands; ⁷Hospital, Saxenburgh Medisch Centrum, Hardenberg, Netherlands; ⁸Intensive Care, Medical Center Leeuwarden, Leeuwarden, Netherlands; ⁹On behalf of the ICUdata Foundation, representing all participating ICUs, Netherlands, Netherlands

Correspondence: M. Otten

Intensive Care Medicine Experimental 2023, **11(Suppl 1)**:000479

Introduction: Intensive care (ICU) professionals from the Netherlands have initiated a widespread collaboration to collect all relevant routinely stored electronic health record data (EHR) related to ICU patients from participating hospitals to support the ongoing development of the application of data science and artificial intelligence for diagnosis, prognosis and decision support in intensive care medicine. Training models to perform these tasks benefits from large datasets to learn from naturally occurring practice variation, to avoid overfitting and to improve generalizability. Therefore, our aim is to combine all routinely stored data into the Dutch ICU Data Warehouse, with a strong focus on durability and scalability, to facilitate data driven research to ultimately benefit treatment and care of future critically ill patients.

Methods: For governance, the ICUdata foundation was established, which includes a general board, a participants' council, an advisory board, a scientific board, a technical committee and a privacy committee. The general board comprises representatives from the participating hospitals, the Dutch Society for Intensive Care and its research committee, the ICU patient and family federation, the ICU nursing federation, and the Dutch National Intensive Care Evaluation registry. With the support from united Dutch health insurers (ZN) the ICUdata foundation contracts a technical company, Pacmed, and medical PhD students from the Center for Critical Care Computational Intelligence at Amsterdam UMC to execute this project (Figure 1). To participate, hospitals sign a Joint Data Registry Agreement to comply with all relevant legislation, including the General Data Protection Regulation. All routinely collected data from ICU patients, except images and notes, are queried from three dominant EHRs in the Netherlands: HIX, EPIC and MetaVision. This initial query retrieves all retrospective data available, with planned addition of all new data on regular basis. This data is pseudonymized, encrypted and securely transferred to a protected cloud environment. There, the data is mapped from hospital variables to standardised concepts using machine learning software for suggestions, transformed to standardized concepts, and saved to the Observational Medical Outcomes Partnership (OMOP) common data model. All participating hospitals are granted access to the ICU data warehouse for research projects approved by the scientific board. The database cannot be used for commercial purposes (Figure 2). Initial example projects include prediction of safe extubation and prediction of mortality.

Results: In 2022, the ICUdata foundation was established, and contracting documents were signed with the technical company and PhD students. Nine hospitals, comprising five academic hospitals and four large non-academic hospitals, have signed the Joint Data Registry Agreement. Eleven more hospitals have expressed interest in joining. Three hospitals have already queried the data from their EHRs. The cloud environment has been designed, and first data transfers are underway. The mapping of this data and transfers of data from other hospitals will take place in subsequent months.

Conclusions: Based on collaborative governance between intensive care professionals as well as hospitals and their intensive care departments, the Dutch ICU Data Warehouse is a project that brings together large volumes of pseudonymised highly granular data on ICU patients in a data warehouse for research purposes. Governance, legal and technical aspects of the project have been finalized and data collection has commenced.

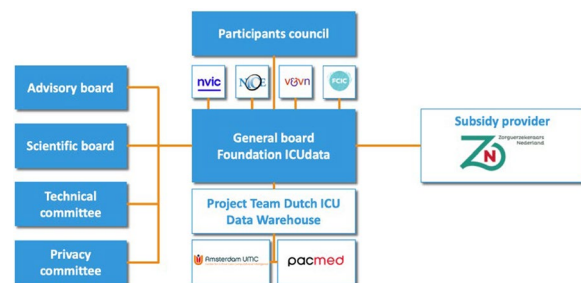

Figure 1 (abstract 000479) Organisational structure of foundation ICUdata. NVIC, Nederlandse Vereniging voor Intensive Care; NICE, Stichting Nationale Intensive Care Evaluatie; V&VN, Beroepsvereniging Verpleegkundigen & Verzorgenden Nederland; FCIC, Stichting Family and patient Centered Intensive Care

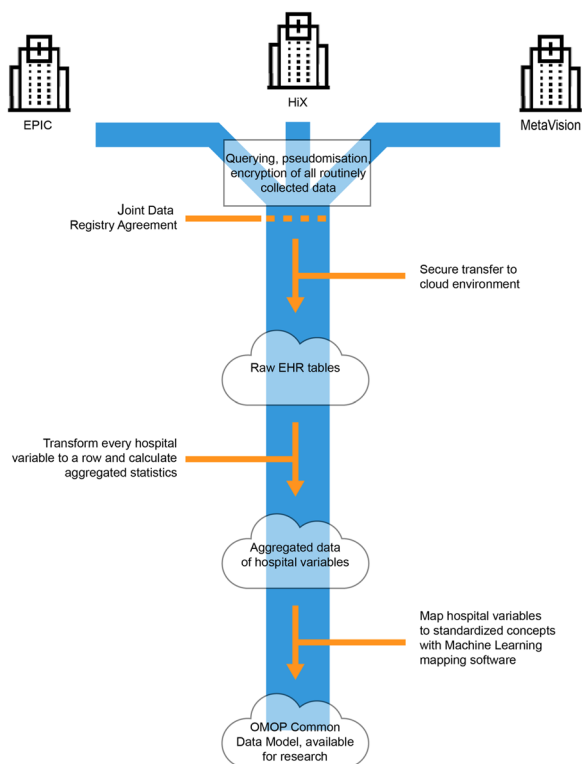

Figure 2 (abstract 000479) Work flow. EHR, electronic health record; OMOP, Observational Medical Outcomes Partnership

Topic: Data Science

000483

Clinical impact of the BioFire® Blood Culture Identification 2 (BCID2) panel in critically ill patients with bloodstream infection: a multicenter observational study in the United Arab Emirates

A. Senok¹, L. Al-Dabal², M. Alfaresi³, M. Habous⁴, H. Celiloglu⁵, S. Bashiri², N. Almaazmi², H. Ahmed², A. Mohammed⁶, O. Bahaaldin⁴, M. Elimam⁴, I. Rizvi⁵, V. Olowoyeye¹, M. Powell⁷, B. Salama⁸

¹College of Medicine, Mohammed Bin Rashid University of Medicine and Health Sciences, Dubai, United Arab Emirates; ²Infectious Diseases Unit, Rashid Hospital, Dubai, United Arab Emirates; ³Pathology and Laboratory Medicine, Zayed Military Hospital, Abu Dhabi, United Arab Emirates; ⁴Microbiology & Infection Control Unit, Pathology Department, Rashid Hospital, Dubai, United Arab Emirates; ⁵Microbiology Department, Mediclinic City Hospital, Dubai, United Arab Emirates; ⁶Intensive Care Unit, Sheikh Khalifa General Hospital, Umm Al Quwain, United Arab Emirates; ⁷Data Science, bioMérieux Inc., Salt Lake City, United States of America; ⁸Medical Affairs, bioMérieux, Dubai, United Arab Emirates

Correspondence: A. Senok

Intensive Care Medicine Experimental 2023, **11(Suppl 1)**:000483

Introduction: Rapid molecular tests such as the BioFire® Blood Culture Identification 2 (BCID2) panel allow the simultaneous identification of a broad range of pathogens and resistance genes from positive blood cultures. Rapid identification of causative pathogens and resistance determinants supports the timely administration of targeted antimicrobial therapy and may improve clinical outcome in critically ill patients. In the United Arab Emirates (UAE) bloodstream infections (BSI) remain a challenge and the clinical impact of BCID2 has yet to be evaluated.

Objectives: This observational study aimed at evaluating the clinical impact of the BCID2 panel on the time to result informing targeted antimicrobial therapy, in adult patients admitted with a BSI in the intensive care unit (ICU) of three UAE hospitals.

Methods: Time to result informing targeted antimicrobial therapy was compared in patients recruited prospectively for a period of 6 months upon implementation of the BCID2 panel (performed in addition to conventional microbiological methods; thereafter referred to as "BCID2" patients) vs. retrospective data from patients evaluated using conventional methods only, during a 6-month period preceding the implementation of BCID2 (thereafter referred to as "pre-BCID2" patients). Clinical outcomes were also compared between pre-BCID2 and BCID2 study groups.

Results: Time to pathogen identification result was analysed in 99 pre-BCID2 and 86 BCID2 patients. The median time to result informing optimal therapy was 92 and 28 h in pre-BCID2 and BCID2 patients, respectively ($p < 0.0001$). After accounting for center-to-center variability, the time to results gained in BCID2 vs. pre-BCID2 patients was 73 h (95% CI: 59.8–88.6 h; $p < 0.0001$). At least one pathogen was detected in 99% BCID2 vs. 88% pre-BCID2 patients ($p = 0.003$). Two pathogens were detected in 15% BCID2 vs. 4% pre-BCID2 patients ($p = 0.011$). Antimicrobial resistance phenotypes were identified in 12% detected pathogens pre-BCID2, while resistance genes were identified by the BCID2 panel in 30% identified pathogens. Among BCID2 patients, 76% identified pathogens were concordant between the BCID2 panel and conventional cultures, and only three patients showed truly discordant pathogen identification. The 30-day mortality was statistically lower in BCID2 vs. pre-BCID2 patients (17% vs. 32%, respectively; $p = 0.019$). The duration of empirical antibiotics usage and the rate of antibiotics de-escalation were comparable in both groups.

Conclusions: The implementation of the BCID2 panel was associated with a shorter time to test result informing optimal targeted antibiotic treatment and with a reduced 30-day mortality among ICU patients with BSI in our UAE hospital setting. The use of the BCID2 panel has therefore the potential to improve clinical outcome in ICU patients with BSI.

References

1. This study was supported by bioMérieux (Marcy l'Etoile, France)

Topic: Sepsis

000484

Effects of therapeutic hypothermia on brain functions in a refractory cardiac arrest model using extracorporeal cardiopulmonary resuscitation

A. Moreau¹, F. Su², F. Manicone², B. Garcia², F. Annoni¹, F. S. Taccone¹

¹Department of Intensive Care, Erasme hospital, Brussels, Belgium;

²Experimental Laboratory of Intensive Care, Université Libre de Bruxelles, Brussels, Belgium

Correspondence: A. Moreau

Intensive Care Medicine Experimental 2023, **11(Suppl 1)**:000484

Introduction: Cardiac arrest (CA) is a major cause of mortality and neurologic disability (1, 2). Extracorporeal cardiopulmonary resuscitation (ECPR) may be used in refractory CA in order to potentially reduce hypoxic ischemic brain injuries (3). Currently, targeted temperature management (TTM) with a target below 37.7 °C is recommended in patients who remain unconscious after CA (4). However, lower target temperatures might be needed during ECPR (5).

Objectives: To evaluate the effects of hypothermia on brain perfusion in an experimental model of ECPR.

Methods: Pigs were submitted to 5 min of untreated ventricular fibrillation (No flow) followed by 25 min of conventional CPR (Low flow). Thirty minutes after CA induction, V-A ECMO support was started and defibrillations were delivered until return of spontaneous circulation (ROSC). Pigs were then randomly assigned to receive either hypothermia (HT, body temperature of 33–34 °C) or controlled normothermia (NT, body temperature of 37–38 °C). A continuous infusion of norepinephrine was started to maintain mean arterial pressure

(MAP) between 65 and 70 mmHg. Respiratory rate and sweep gas flow were adjusted to maintain partial pressure of carbon dioxide (PaCO₂) between 35 and 45 mmHg. Brain oxygen pressure (PbtO₂), intracranial pressure (ICP), cerebral temperature (CT) and brain cortical activity were recorded during the whole experiment. Blood samples, allowing measurements of neuron-specific enolase (NSE), neurofilament (NfL), glial fibrillary acidic protein (GFAP), aspartate aminotransferase (AST), alanine aminotransferase (ALT), Troponin I (TnI) and creatine-phosphokinase (CPK), were collected at several endpoints. Twelve hours after ROSC, the animals were killed by an intracardiac potassium injection. Brain tissues were harvested immediately and stored for histological and molecular analysis.

Results: Twelve pigs were enrolled in this study (6 in each group). The baseline characteristics (Table 1) were comparable between the 2 groups. ROSC was obtained in every pig included in this protocol. With the exception of one pig who died from refractory distributive shock in the HT group, all the pigs achieved the end of the experiment. The mean time (mean ± SD) to reach targeted body temperature was 1.5 (1.2) hours in HT group and 2.1 (0.7) hours in NT group; PaCO₂ and MAP levels were similar between the 2 groups all along the protocol. In the 2 groups, PbtO₂ levels progressively decreased and ICP levels increased throughout the experiment. However, no difference was observed between the 2 groups, whether for PbtO₂ (p=0.8) or ICP levels (p=0.8) (Figures 1, 2). The levels of AST, ALT, TnI and CPK were similar in both groups. Biomarkers measurements, EEG interpretation and histological analysis are still in progress.

Table 1 (abstract 000484) Baseline characteristics

	Normothermia group	Hypothermia group	P value
Number of pigs (n)	6	6	-
Body weight (kg)	53.5 ± 3.4	51.3 ± 3.8	0.32
Body temperature (°C)	36.5 ± 0.8	35.7 ± 0.7	0.11
Cardiac output (L/min)	6.5 ± 0.9	6.3 ± 0.7	0.63
Mean arterial pressure (mmHg)	73 ± 4	70 ± 9	0.48
Blood lactate (mmol/L)	1.2 ± 0.2	1.3 ± 0.4	0.62
Blood glucose (mg/dL)	98 ± 28	124 ± 27	0.12
Cerebral temperature (°C)	36.8 ± 0.5	35.9 ± 0.9	0.06
PbtO ₂ (mmHg)	51.3 ± 12.1	46.1 ± 11.3	0.46
ICP (mmHg)	8.7 ± 3.7	9.6 ± 3.1	0.67

Conclusions: In this study, HT was not associated with significant improvement in brain hemodynamics when compared to NT. Further analyses are still in progress to confirm our preliminary results.

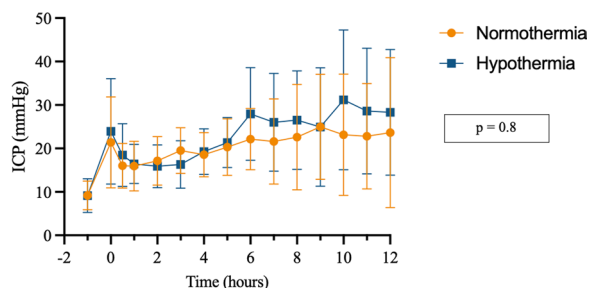

Figure 2 (abstract 000484) Evolution of ICP levels in hypothermia and normothermia groups throughout the experiment

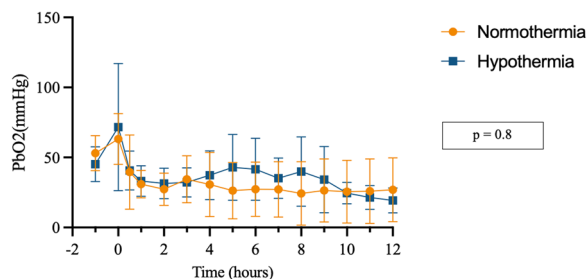

Figure 1 (abstract 000484) Evolution of PbtO₂ levels in hypothermia and normothermia groups throughout the experiment

References

1. Gräsner, J.-T. et al. EuReCa ONE-27 Nations, ONE Europe, ONE Registry A prospective one month analysis of out-of-hospital cardiac arrest outcomes in 27 countries in Europe. Resuscitation 105, 188–195 (2016).
2. Sandroni, C., Nolan, J., Cavallaro, F. & Antonelli, M. In-hospital cardiac arrest: incidence, prognosis and possible measures to improve survival. Intensive Care Med 33, 237–245 (2007).
3. Belohlavek, J. et al. Effect of Intra-arrest Transport, Extracorporeal Cardiopulmonary Resuscitation, and Immediate Invasive Assessment and Treatment on Functional Neurologic Outcome in Refractory Out-of-Hospital Cardiac Arrest: A Randomized Clinical Trial. Jama 327, 737–747 (2022).
4. Sandroni, C. et al. ERC-ESICM guidelines on temperature control after cardiac arrest in adults. Intensive Care Med 48, 261–269 (2022).
5. Moreau, A. et al. The use of induced hypothermia in extracorporeal membrane oxygenation: A narrative review. Resusc Plus 13, 100360 (2023).
6. AM and FST were supported by the Fonds Erasme pour la Recherche Médicale.

Topic: Cardiac arrest

000485

Health related quality of life assessed with RAND-36 after surviving intensive care for COVID-19: a prospective multicenter cohort study

P. Halvorsen¹, M. Hultström¹, J. Hästbacka², I. M. Larsson¹, R. Eklund³, F. K. Arnberg³, R. Frithiof¹, E. Wallin¹, L. Orwelius⁴, M. Lipcsey¹

¹Anesthesiology and Intensive Care Medicine, Department of Surgical Sciences, Uppsala University, Uppsala, Sweden; ²Intensive Care Units, Department of Anaesthesiology, Intensive Care and Pain Medicine, University of Helsinki and Helsinki University Hospital, Helsinki, Finland; ³Department of Medical Sciences, National Centre for Disaster Psychiatry, Uppsala University, Uppsala, Sweden; ⁴Departments of Intensive Care, Biomedical and Clinical Sciences, Linköping University, Linköping, Sweden

Correspondence: P. Halvorsen

Intensive Care Medicine Experimental 2023, 11(Suppl 1):000485

Introduction: In those surviving severe corona virus disease 2019 (COVID-19) mental and physical recovery has been reported to occur at varying degree and following different trajectories. Incomplete recovery may have considerable impact on daily activities and health-related quality of life (HRQoL). HRQoL can be measured with the RAND-36 questionnaire, a multidimensional instrument that assesses health in physical and mental aspects in eight dimensions.

Objectives: To investigate HRQoL among intensive care patients treated for COVID-19 at three Nordic university hospitals.

Methods: A prospective cohort study at three Nordic hospitals. HRQoL was measured using RAND-36 at 3–9 months after discharge from intensive care unit (ICU). Also, one site performed a second follow-up after 12 months from discharge. The RAND-36 questionnaire was either sent to the participants in advance and collected at the follow

up visit, administered there or by mail. Demographic and clinical data were registered.

Results: We screened 542 patients for participation and included 252. Median age was 61 (52–69) years, hypertension was the most common comorbidity seen in 132 (52%), and 121 (48%) patients were mechanically ventilated for a median of 8 (Q14–Q314) days. In RAND-36, physical functioning, physical role, general health ($p < 0.001$ for all) and social functioning ($p < 0.05$) were below the lower limit of the 95% CI in a Swedish reference cohort (Ohlsson-Nevo et al., 2021), while bodily pain, role functioning and mental health were not. In a time to event analysis assessing predictors of reaching above the lower limit of the 95% CI of the Swedish reference cohort, (Figure 1) female sex was associated with decreased chance of reaching normal HRQoL in the bodily pain dimension; increasing BMI in the physical functioning dimension; hypertension in the physical functioning, bodily pain, vitality and social role functioning dimensions; diabetes mellitus in the vitality dimension; pulmonary illness in the physical functioning and physical role functioning dimensions; and psychiatric diagnosis in the social role functioning dimension. Mechanical ventilation during ICU stay was associated with decreased chance of reaching normal HRQoL in the physical functioning and bodily pain dimensions.

Conclusions: In a cohort of patients treated in the ICU with COVID-19, HRQoL was decreased three to nine months after ICU discharge compared to the general population. Female gender and comorbidities were associated with slower rate recovery.

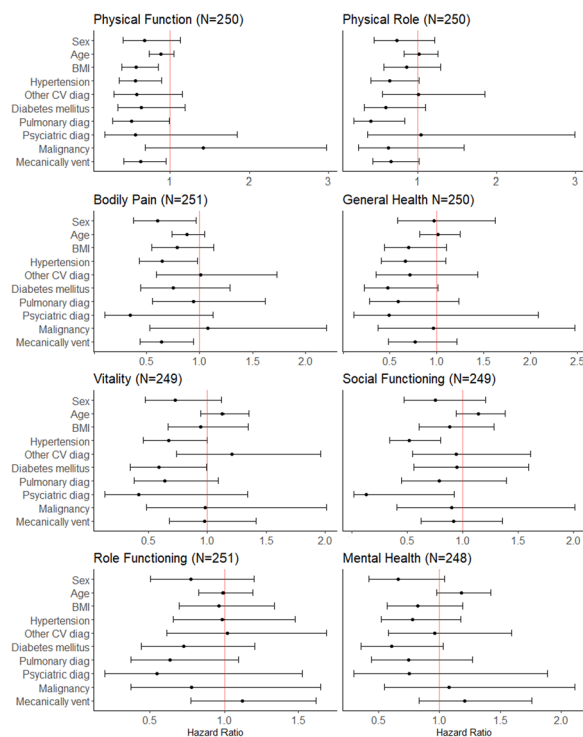

Figure 1 (abstract 000485) Hazard ratio over our RAND-36 data, based on our complete cohort. Lower values indicate slower recovery

References

1. Swedish Society of Medicine (M.H.:SLS-938101)
2. The Swedish Research Council (R.F.: 2014-02569, 2014-07606)
3. The Swedish Heart–Lung Foundation (M.H.: 20210089, 20190639, 20190637),
4. Nordforsk and government funding for university level research (TYH2021310).
5. SciLifeLab/Knut and Alice Wallenberg national COVID-19 research program (M.H.: KAW 2020.0182, KAW 2020.0241)
6. The Swedish Kidney Foundation (R.F.: F2020-0054)

Topic: Acute respiratory failure and mechanical ventilation

000487

The usefulness of VSI (Visensia® Safety Index) and other Early Warning Scores for detecting patients requiring Rapid Response Systems at an academic tertiary center

R. Tanii¹, K. Hayashi², T. Naito³, T. Yoshida³, S. Fujitani³

¹Emergency and Critical Care Medicine, St. Marianna University School of Medicine, Yokohama City Seibu Hospital, Yokohama, Japan; ²Data Science, Kyoto Women's University, Kyoto, Japan; ³Emergency and Critical Care Medicine, St. Marianna University School of Medicine, Kawasaki, Japan

Correspondence: R. Tanii

Intensive Care Medicine Experimental 2023, 11(Suppl 1):000487

Introduction: Rapid Response Systems (RRS) is a global standard for reducing in-hospital cardiac arrest (1). Various Early Warning Scores (EWS) have been implemented to identify deteriorating patients. Since incomplete vital signs lead to misclassification, EWS calculated with fewer parameters may be useful. Visensia® Safety Index (VSI) is an AI-based aggregated score calculated by fewer, at least three of five vital parameters.

Objectives: To compare the sensitivities toward RRS activation and the performance of adverse event detection of VSI and other EWSs.

Methods: A retrospective observational study at a single academic center in Japan was conducted. Patients activated RRS were collected from January 2019 to December 2022. Five different EWS: National EWS (NEWS)(2), VSI, Modified EWS (MEWS) (3), and Marianna-MEWS (MMEWS), were compared. These EWSs were calculated using vital data recorded when RRS activated. Positive thresholds were NEWS ≥ 7 , VSI ≥ 3.0 , MEWS ≥ 5 , and MMEWS ≥ 7 . First, we performed multiple comparisons based on McNemar's test to compare the sensitivities. Second, the accuracy of each score for detecting adverse events, defined as ICU transfer and one-month death after care unit transfer, was evaluated using AUCs of the receiver operating characteristic (ROC) curve. P-values < 0.05 were considered statistically significant, and all analyses were performed using R (version 4.1.1).

Results: During the study period, 666 patients were eligible. Among them, 234 patients had complete vital signs of seven parameters. Of the 234 cases, 131 were male (56%), and the median age was 72.5 (IQR 61.0–80.0). ICU transfer and one-month mortality rates were 30.8% and 24%. The sensitivity of each EWS was 0.66 for NEWS, 0.63 for VSI, 0.53 for MEWS, and 0.45 for MMEWS. Sensitivities between NEWS and VSI were not significantly different ($p = 0.41$); however, all others were significantly lower (Table). When we added the factor of consciousness level to VSI, the sensitivity increased to 0.79. On the other hand, if VSI was calculated with four parameters, except blood pressure (BP), respiratory rate (RR), or heart rate (HR), sensitivities dropped significantly. Regarding adverse event detection, AUC for one-month death after care unit transfer was 0.64 for NEWS, 0.61 for VSI ($p = 0.51$). The AUC for ICU transfer was 0.68 [95% CI, 0.61–0.75] for NEWS, 0.62 [0.54–0.69] for VSI ($p = 0.07$), and there were no statistical differences.

Table (abstract 000487) Sensitivities of RRS activation among different EWSs (n = 234)

EWS and alert criteria	Sensitivity	p-value
NEWS	7/20 0.66	ref
VSI	3.0/5.0 0.63	0.41 ref
MEWS	5/14 0.53	<0.001
MMEWS	7/15 0.45	<0.001
VSI + consciousness VPU	3.0/5.0 0.79	<0.001 <0.001
VSI (exc BP)	3.0/5.0 0.41	<0.001
VSI (exc HR)	" 0.59	0.02
VSI (exc RR)	" 0.53	<0.001

EWS and alert criteria	Sensitivity	p-value
VSI (exc SpO ₂)	"	0.61
VSI (exc Temp)	"	0.60

Note: Criteria are described as "alert threshold/total score"

ref: reference, exc: except

Conclusions: There were no significant differences in NEWS and VSI for sensitivities in detecting patients requiring RRS and for detecting adverse events. Our findings suggest that VSI might be useful for detecting patient deterioration with fewer parameters.

References

1. Subbe CP, Kruger M, Rutherford P, Gemmel L. Validation of a modified Early Warning Score in medical admissions. *QJM*. 2001 Oct;94(10):521–6. <https://doi.org/10.1093/qjmed/94.10.521>. PMID: 11588210.
2. Smith GB, Prytherch DR, Meredith P, Schmidt PE, Featherstone PI. The ability of the National Early Warning Score (NEWS) to discriminate patients at risk of early cardiac arrest, unanticipated intensive care unit admission, and death. *Resuscitation* 2013;84(4):465–70. <https://doi.org/10.1016/j.resuscitation.2012.12.016>.
3. Maharaj R, Raffaele I, Wendon J. Rapid response systems: a systematic review and meta-analysis. *Crit Care* 2015;19(1):254. <https://doi.org/10.1186/s13054-015-0973-y>.
4. Not Applicable

Topic: Cardiac arrest

000488

Comparison of gastric or post-pyloric blinded insertion of feeding tubes on target calories and enteral tolerance

V. Demirdogen¹, E. Aygün², E. Senturk², N. Cakar¹

¹Anesthesiology and Reanimation, American Hospital, İstanbul, Turkey;

²Anesthesiology and reanimation, Koc University, İstanbul, Turkey

Correspondence: E. Senturk

Intensive Care Medicine Experimental 2023, **11(Suppl 1)**:000488

Introduction: In critically ill patients post-pyloric (duodenal or jejunal) nutrition may have beneficial effects. However this was not proven.

Objectives: Our aim is to evaluate the anatomical placement (gastric or post pyloric) of feeding tubes inserted by blind method and to compare their time to reach the target calories.

Methods: All adult patients in between 2010 and 2021 were screened, the patients in which blind insertion of feeding tube (polyurethane, radiopaque, 14F, Bexen Medical, Hernani, Spain) was done were analyzed retrospectively in the general ICU of the American Hospital. For at least 5 days including 1st, 3rd, 5th days of feeding tube placement, chest X-rays were evaluated for anatomical location. (Figure A Post-pyloric tube, Figure B Gastric placement of feeding tube). If the patient's feeding tube is in the post-pyloric area in three chest X-rays these were accepted as post pyloric group (PG), the remaining are defined as gastric group (GG).

Enteral nutrition was started at a dose of 20 ml/h infusion, and if the amount of gastric residue (GRV) measured every 7 h is < 250 ml, infusion rate was increased 20 ml every 7 h. If GRV was > 250 ml, the infusion was interrupted for 2 h and then continued at half rate. In the presence of vomiting and/or abdominal distention, the infusion was also interrupted. The time to reach at least 75% of total daily calories (calculated by Harris Benedict and Schofield divided by two) of the patients were evaluated. The number of patients reaching target calories in 72 h were also recorded. The patients' gender, comorbidities (diabetes, neurological disease), medications (inotropic and/or sedative, prokinetic drugs usage), APACHE-II values were analyzed.

Results: 301 patients were retrospectively analyzed, 68% (206) were in PG and 32% (95) were in GG. In both groups there was no statistically significant difference between gender, diabetes, and neurological disease, use of sedative and inotropic agents. The mean time to reach the target calorie was 64 h in the PG, and 88 h in the GG ($p < 0.001$). The number of patients reaching target calories in 72 h or earlier in PG was

171 (83%), and it was 37 (39%) in GG. The rate of patients who developed enteral intolerance in the PG was 12 (6%), it was 22 (23%) in the GG ($p < 0.001$).

Conclusions: It was determined 68% of the blindly placed enteral feeding tubes were post-pyloric. PG has better feeding tolerance and reach targeted calories earlier. During insertion of feeding tubes this data has to be considered.

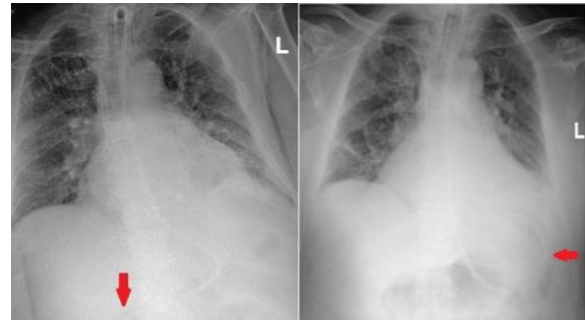

Enteral tube placement by bedside chest x-ray postpyloric and gastric tube.

References

1. None

Topic: Metabolism, endocrinology, liver failure and nutrition

000492

Protecting mucosal immunity against SARS-CoV-2 variant of concern

J. Liang¹, S. Mubareka², A. Slutsky³, H. Zhang¹

¹Anesthesiology and Pain Medicine, Critical Care Medicine, St. Michael's Hospital, University of Toronto, Toronto, Canada; ²Microbiology and Infectious Diseases, University of Toronto, Toronto, Canada; ³Critical Care Medicine, St. Michael's Hospital, University of Toronto, Toronto, Canada

Correspondence: H. Zhang

Intensive Care Medicine Experimental 2023, **11(Suppl 1)**:000492

Introduction: The SARS-CoV-2 Omicron variant differs from the parental virus and other variants of concern in two significant ways: (1) it exhibits robust binding to the angiotensin-converting enzyme 2 (ACE2) receptor, while also being highly adept at evading the immune system; and (2) it relies more on the endocytic pathway for cell entry, resulting in a significant loss of endogenous mucosal ACE2, reducing lung protection, and increasing infectivity. The Omicron variant is more likely to cause upper airway infections and less likely to affect the lung distal tissue. Individuals with weakened immune systems or underlying health conditions are at high risk. Consequently, the urgent need to explore effective prophylactic and therapeutic interventions to boost mucosal immunity against Omicron in the upper airways has become apparent.

Objectives: The study aims to identify potential prophylactic and therapeutic strategies to protect mucosal immunity against breakthrough infections.

Methods: Based on the viral structure and its interactions with host cells, we are testing several potential strategies against SARS-CoV-2 infection and its variants of concern in human lung organoids and humanized mice. These strategies include, but are not limited to, using decoy viral particles, decoy host receptors and blocking host receptor complexes, to prevent VOCs from escaping with mutative spike proteins.

Results: We observed significant preservation of mucosal ACE2, decreased viral loads, lower clinical manifestation scores, and lung injury scores using recombinant human ACE2 in humanized mice

infected with SARS-CoV-2. We also demonstrated the potential prophylactic role of recombinant ACE2 and SARS-CoV-2 virus-like particles as decoys, attenuating the number of viral gene copies and cytopathic effects in human lung organoids infected with Delta and Omicron (BA.2) variants.

Conclusions: The use of decoy host receptors and viral particles has shown promising results in preserving mucosal host immunity, and this study highlights their potential for the development of effective prophylactic and treatment capabilities against breakthrough SARS-CoV-2 infections.

References

1. This work was supported by the Canadian Institutes of Health Research (OV3-170344, SBC-171482 and VS1-175560).

Topic: Translational Medicine

000493

A novel method to reduce aerosol generation during non-invasive ventilation

Y. Angel¹, I. Moshkovitz¹, D. Stavi¹, N. Adi¹, A. Gal Oz¹

¹Division of Anaesthesia, Pain Management and Critical Care, Tel Aviv Sourasky Medical Center - Ichilov, Tel Aviv-Yafo, Israel

Correspondence: Y. Angel

Intensive Care Medicine Experimental 2023, **11(Suppl 1)**:000493

Introduction: Non-invasive ventilation (NIV) is a fundamental tool in the care of critically ill patients suffering from respiratory failure and specifically in those with respiratory infections. NIV is commonly considered an “aerosol generating procedure” [1]: Environmental spread of exhaled air and/or respiratory droplets during NIV may spread contagious pathogens such as SARS-CoV-2 and infect nearby patients as well as healthcare personnel. Consequently, many societies and institutions now require staff caring for patients receiving NIV to use respiratory precautions [2]. There is a need for methods to reduce the risk of environmental contamination during NIV.

Methods: This is a single-center, prospective, open-label study evaluating the Lumena NIV mask (Inspir Labs, Kfar Saba, Israel), a novel mask composed of a standard nose-mouth interface surrounded by a second layer of interface, with the space between two negatively pressurized to minimize environment air leak (Figure 1). This study takes place in the Intensive Care, Cardiology, and Internal Medicine wards at the Tel Aviv Sourasky Medical Center. Patients requiring NIV who met inclusion criteria, did not meet any exclusion criteria, and provided written informed consent were enrolled. Patients underwent three 30-min NIV sessions during a 24-h period: with a standard NIV mask and with the study mask with and without negative pressure applied. Following an inhalation of 5 ml 0.9% NaCl, the concentration in the air of particles 0.3, 0.5, 1 and 2.5 microns (a range consistent with airborne transmission [3]) was measured 1 m from the patient’s head using a particle measuring device (PCE Instruments PCE-PCO 01). Patients’ vital signs, clinical status, and arterial or venous blood gas analysis were monitored as safety outcomes.

Results: The first 12 enrolled patients who completed the study are included in this interim analysis (median age 72 years; 9 [75%] male). A significant reduction in the concentration of particles 0.3, 0.5 and 1.0 micron was observed with the use of the study mask with negative pressure applied compared to the conventional (control) mask (One-sided t-test $P < 0.001$, $P = 0.006$, $P = 0.045$, respectfully), with the greatest reduction observed for 0.3 and 0.5 micron particles (Figure 2). No significant differences were observed in heart rate, respiratory rate, blood pressure, O_2 saturation, arterial O_2 , CO_2 , Lactate or pH between the three groups.

Conclusions: In this interim analysis of a single-center, open-label study, a reduction in the number of particles 0.3, 0.5 and 1.0 micron was observed with the application of negative pressure to the novel Lumena mask, compared to the use of a conventional NIV mask.

Further studies are needed to validate these results and evaluate the effect of using the Lumena mask on cross contamination rates.

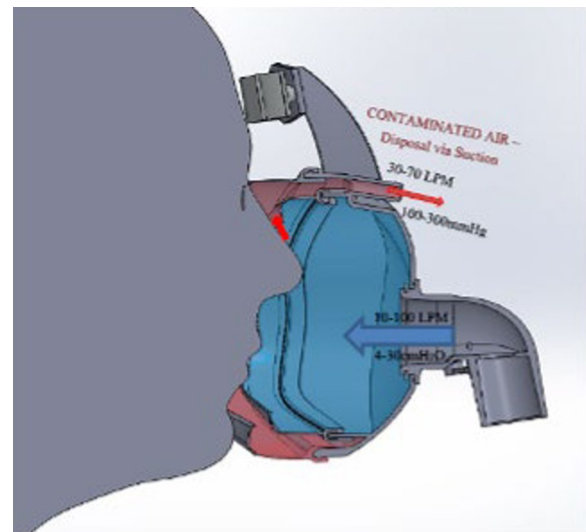

Figure 1 (abstract 000493) Illustration of the study mask. Positive-pressure ventilation is delivered through the conventional nose-mouth interface, while negative pressure is applied to the surrounding space, preventing dispersion of exhaled air to the surroundings

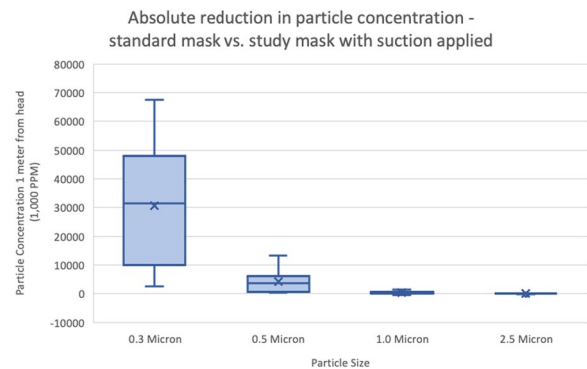

Figure 2 (abstract 000493) Boxplot comparison of the absolute reduction in particle concentration between standard mask and the study mask with suction applied. Boxes represent interquartile range, internal line represents median. Y axis is displayed in 1000 PPM

References

1. (3) Galton J, Tovey E, McLaws ML, Rawlinson WD. The role of particle size in aerosolised pathogen transmission: a review. *J Infect.* 2011 Jan;62(1):1–13. <https://doi.org/10.1016/j.jinf.2010.11.010>. Epub 2010 Nov 19. PMID: 21094184; PMCID: PMC7112663.
2. (2) British Thoracic Society. Guidance for inpatient infection control management of patients receiving Acute NonInvasive Ventilation and Long-Term Ventilation during and beyond COVID-19, October 2020. <https://www.brit-thoracic.org.uk/document-library/quality-improvement/covid-19/guidance-for-inpatient-infection-control-management-receiving-acute-niv-and-ltb/>.
3. (1) Chui J, Hui D S, Chan M T. How should aerosol generating procedures be defined? *BMJ* 2022; 378:e065903 <https://doi.org/10.1136/bmj-2021-065903>.

Topic: Acute respiratory failure and mechanical ventilation

000500

APACHE II and SAPS II scoring: outcomes in Intensive Care Unit Covid19 patients

D. Faria Lopes¹, T. Oliveira¹, R. A. Neto¹, N. Catorze¹

¹Medicine Intensive Service, District Hospital of Abrantes, Abrantes, Portugal

Correspondence: D. Faria Lopes

Intensive Care Medicine Experimental 2023, **11(Suppl 1)**:000500

Introduction: In the Intensive Care Units (ICU), it is important to know the magnitude of a patient's illness and forecast disease prognosis. Different severity scores are being used to assess outcomes in ICU, but variable data have been reported so far regarding their performance. Are the standard scores such as Acute Physiology and Chronic Health Evaluation II (APACHE II) and the Simplified Acute Physiology Score II (SAPS II) accurate for predicting outcomes in COVID 19 patients?

Objectives: The main purpose of our work was to compare the performance of APACHE II and SAPS II regarding the outcomes of ICU COVID 19 patients, namely mortality and invasive mechanical ventilation (IMV) need.

Methods: We performed a prospective study with confirmed COVID 19 patients admitted to the ICU, from March 2020 to March 2021. APACHE II and SAPS II were performed in the first day. Age, gender, IMV need and total days intubated, cardiovascular risk factors and length of stay in ICU were recorded. Two groups were made: survived and nonsurvived patients, that were compared by chi-square test for categorical variables and independent sample t-test for continuous variables. ROC analysis was used to compare scores' accuracy.

Results: We enrolled 158 patients. In the survived group there were 105 patients (66,46%), 70 men (66,67%), mean age of 61,23 ± 14,56 years. In the nonsurvived group there were 53 patients (33,54%), 36 men (67,92%), mean age of 70,43 ± 9,86 years. Regarding mortality, APACHE II demonstrated a sensitivity of 73,6% and a specificity of 68,6% with an Area Under the Curve (AUC) of 72,3%. SAPS II showed a sensitivity of 66% and a specificity of 62,9% with an AUC of 68,9%. Regarding prediction of the requirement of mechanical ventilation, APACHE II showed a sensitivity of 58,0% and a specificity of 56,9% and SAPS II showed a sensitivity of 62% and a specificity of 53,4%. There was a positive correlation between APACHE II and the total number of days on IMV ($r=0,0198$) and between APACHE II and the length of stay in ICU ($r=0,0239$), although not statistically significant ($p=0,845$ and $p=0,766$, respectively). Similar results were seen in SAPS II ($r=0,044$, $p=0,663$ and $r=0,0476$, $p=0,553$, respectively). Older age and diabetes were associated with high mortality ($p=0,00003$ and $p=0,03699$ respectively). Obesity, hypertension and dyslipidemia were not associated with increased mortality ($p=0,37973$ $p=0,10278$ and $p=0,92796$, respectively).

Conclusions: APACHE II and SAPS II are overall comparable and useful scores to predict outcomes in ICU patients. Both scores predicted mortality with similar sensitivity and specificity in COVID 19 patients, with APACHE II showing slightly more sensitivity than SAPS II. SAPS II showed more sensitivity regarding IMV need. Higher values of APACHE II and SAPS II scores are associated with higher mortality rates. There was a positive weak correlation between APACHE II and SAPS II scores and days on IMV and length of stay in ICU. Older age and diabetes are risk factors for mortality.

References

- Jeong S. Scoring systems for the patients of intensive care unit. *Acute Crit Care*. 2018;33(2):102–104.
- Mehrzad B, Seyed Sajjad E, Nasrollah M, et al. Use of the APACHE II score for the assessment of outcome and mortality prediction in an Iranian Medical–Surgical Intensive Care Unit. *Arch Anesth Crit Care* 2018;4:521–526.

Topic: Critical care organisation, quality management, information systems, outcomes

000501

Duration of PCR positivity in COVID-19 ICU patients

M. Masikou¹, C. C. Theocharidou², F. Ampatzidou³, E. Gavriilidou¹, A.

Otatzioglou¹, D. Palitzika⁴, A. Louka⁵, D. Kommatas¹, S. Tsaousidou¹

¹3rd ICU, General Hospital of Thessaloniki "George Papanikolaou",

Thessaloniki, Greece; ²3rd ICU, G. Papanikolaou Hospital, Thessaloniki,

Greece; ³3rd ICU, G. Papanikolaou Hospital, Thessaloniki, Greece; ⁴Director

of Nursing, General Hospital of Thessaloniki "George Papanikolaou",

Thessaloniki, Greece; ⁵Matron of Critical Care, General Hospital

of Thessaloniki "George Papanikolaou", Thessaloniki, Greece

Correspondence: M. Masikou

Intensive Care Medicine Experimental 2023, **11(Suppl 1)**:000501

Introduction: Viral replication and the majority of immune responses triggered by sars-cov-2 are believed to contribute to the clinical outcome of COVID-19, as recent studies show, however, it remains unclear whether there is a correlation between viral load and antibody production and clinical outcomes.

Objectives: The objective of this study was to determine the characteristics of critically ill, COVID-19 positive patients, with a prolonged PCR positivity and to investigate any association of this prolongation with mortality in a critical care setting.

Methods: Within the past year, from January 2022 to January 2023, 220 patients were admitted to the 3rd ICU of 'G. Papanikolaou' General Hospital. All COVID-19 patients who tested negative during their hospitalization participated in this study. The rest of them were either discharged to other departments or died with a positive PCR. Demographic characteristics, days of positivity (PD), Tocilizumab intake and mortality were also recorded.

Results: We studied a total of 83 patients, 25 of which were women (30.1%), with a mean age of 66.04 ± 13.1 years. A statistically significant moderate negative correlation was observed between age and positivity—Spearman's correlation was -0.563 with confidence interval (-0.691 , -0.39). Significance was found at $p < 0.0001$. No statistically significant difference was observed between the 2 sexes. For women PCR positivity days (PPD) were 18.9 ± 9.36 and for men 20.9 ± 9.9 respectively, with $p=0.46$. Tocilizumab was prescribed and administered to 14 (15.7%) patients and featured a mean PCR positivity duration of 15.4 ± 9.9 days, compared to those who did not receive it, who were PCR positive for 21.2 ± 9.5 days, with a statistical significance of $p=0.017$. Patient mortality under this study was estimated at 50.5%. Those who died had a mean PD of 20.9 ± 10.4 compared to those who lived who had a PD of 19.8 ± 9 with $p=0.6$.

Conclusions: Duration of PCR positivity days in COVID-19, critically ill patients was statistically significantly related to age and previous Tocilizumab intake, while no correlation was observed with ICU mortality.

References

- Howard-Jones, A. R., Maddocks, S., Basile, K., Dwyer, D. E., Branley, J., & Kok, J. (2021). Prolonged PCR positivity in elderly patients infected with SARS-CoV-2. *Pathology*, 53(7), 914–916. <https://doi.org/10.1016/j.pathol.2021.08.004>
- Eser, F., Kayaaslan, B., Güner, R., Hasanoğlu, I., Kaya Kalem, A., Aypak, A., & Akinci, E. (2021). The Effect of prolonged PCR Positivity on patient Outcomes and Determination of Isolation period in COVID-19 patients. *International journal of clinical practice*, 75(5), e14025. <https://doi.org/10.1111/ijcp.14025>

Topic: Nursing care and physiotherapy

000503

IgE class anti-ACTH antibodies in critically ill patients with COVID-19: are they related to complications and outcomes?C. Díaz-Rodríguez¹, D. Pérez-Torres¹, I. Canas¹, P. A. Merino-García¹, C. Colmenero-Calleja¹, G. J. Posadas-Pita¹, T. G. Ticona-Espinoza¹, C. Cuenca-Rubio¹, P. M. Enríquez-Giraudó¹, A. Armentia-Medina²¹Intensive Care Department, Hospital Universitario Río Hortega, Valladolid, Spain; ²Allergy Department, Hospital Universitario Río Hortega, Valladolid, Spain**Correspondence:** C. Díaz-Rodríguez*Intensive Care Medicine Experimental* 2023, **11(Suppl 1)**:000503

Introduction: Coronavirus disease 2019 (COVID-19) has resulted in a high mortality rate by evading the host's immune system through mechanisms that are not yet fully understood (1). Adrenal insufficiency may play an important role in this phenomenon and several potential mechanisms have been proposed. One of these is based on the fact that the SARS-CoV-2 amino acid sequence is highly close to human adrenocorticotropic hormone (ACTH) (1, 2). As a result, the hormone could also be neutralized by antibodies that target identical epitopes on the virus, preventing it from producing cortisol and resulting in a relative adrenal insufficiency. However, the information available on the presence of anti-ACTH antibodies and cortisol levels in COVID-19 patients is scarce (3).

Objectives: To investigate the prevalence of anti-ACTH antibodies in COVID-19 patients and their association with outcomes, complications, and endocrine alterations.

Methods: We conducted a prospective, observational, single-centre study in the intensive care unit (ICU) of a university hospital in Spain. Inclusion criteria: polymerase chain reaction (PCR)-confirmed infection by SARS-CoV-2 with COVID-19 symptoms, time from diagnosis to ICU admission < 14 days and mechanical ventilation (MV) > 48 h. Exclusion criteria: SARS-CoV-2 infection without COVID-19, use of MV for reasons other than COVID-19, or denial to participate in the study. Inclusion period: 01/11/21 to 28/02/22. We measured Ig-E class anti-ACTH antibodies on ICU day 10, by using ImmunoCAP[®] technology. We measured adrenocorticotropic hormone (ACTH) and cortisol levels on ICU days 5, 15 and 25. Patients were followed up until 90 days or hospital discharge (whichever occurred first). Results are expressed as median (interquartile range) or frequency (%). Chi-square, Student's T, and Mann-Whitney U tests were applied as appropriate.

Results: During the enrolment period, we identified 52 patients with a positive SARS-CoV-2 PCR, 35 of whom met inclusion criteria. Clinical characteristics of the patients included: 77% men, aged 60 ± 9 years-old, APACHE-II 13 (11–18). All the patients received MV, with a duration of 23 (12–41) days. Veno-venous extracorporeal membrane oxygenation (V-V ECMO) was required in 28.5% of the patients, with a duration of 19 (12–46) days. The observed 90-day mortality was 17%. We identified anti-ACTH antibodies in 46% of the patients.

Comparison between patients with vs. without anti-ACTH antibodies: age 61 ± 9 vs. 59 ± 9 years old, $p = 0.62$; male sex 75 vs. 79%, $p = 0.78$; APACHE-II 14 (12–20) vs. 13 (11–17) points, $p = 0.44$; length of MV 23 (13–58) vs. 24 (12–30) days, $p = 0.61$; length of ECMO 36 (12–53) vs. 12 (12–25) days, $p = 0.39$; 90-day mortality 19% vs. 16%, $p = 0.81$.

Association between anti-ACTH antibodies and complications (odds ratio, 95% confidence interval, p): colonization with multidrug-resistant bacteria 2.8 (0.6–14.7), $p = 0.15$; ventilator-associated pneumonia 1.37 (0.3–6.4), $p = 0.64$; bacteraemia 2.7 (0.5–15.4), $p = 0.17$; delirium 0.35 (0.1–1.7), $p = 0.13$; ICU-acquired weakness 0.9 (0.2–4.1), $p = 0.87$; thrombotic events 1.3 (0.3–6.6), $p = 0.71$; ischemic events 2.6 (0.2–159.9), $p = 0.45$; pulmonary fibrosis 2.8 (0.3–35.1), $p = 0.26$.

Hormone levels in patients with vs. without anti-ACTH antibodies on ICU days 5, 15 and 25. ACTH (pg/mL): 2 (0–7.2) vs. 2 (0–8.5), $p = 1$; 6.3 (2–9.4) vs. 15.3 (5.6–29.5), $p = 0.10$; 7.1 (2–11.7) vs. 9.1 (2–16.2), $p = 0.65$. Cortisol (µg/dL): 2.2 (1.6–7.6) vs. 2.4 (1.5–5), $p = 0.76$; 5.3 (2.1–13.5) vs. 8.4 (3.7–15.7), $p = 0.37$; 2.4 (1.5–5.4) vs. 2.7 (2.1–4.8), $p = 0.69$.

Conclusions: We found a high prevalence of anti-ACTH antibodies in patients with COVID-19. However, their role is yet to be determined. We could not find an association between the presence of these antibodies and the clinical outcomes, the incidence of complications, or the hormones from the pituitary-adrenal axis.

References

1. Pal R. COVID-19, hypothalamo-pituitary-adrenal axis and clinical implications. *Endocrine*. 2020;68(2):251–252. <https://doi.org/10.1007/s12020-020-02325-1>
2. Leow MK, Kwek DS, Ng AW, Ong KC, Kaw GJ, Lee LS. Hypocortisolism in survivors of severe acute respiratory syndrome (SARS). *Clin Endocrinol (Oxf)*. 2005;63(2):197–202. <https://doi.org/10.1111/j.1365-2265.2005.02325.x>
3. Pérez-Torres D, Díaz-Rodríguez C, Armentia-Medina A. Anti-ACTH antibodies in critically ill Covid-19 patients: A potential immune evasion mechanism of SARS-CoV-2. *Med Intensiva (Engl Ed)*. 2022;46(8):472–474. <https://doi.org/10.1016/j.medine.2021.09.001>

Topic: Infections and prevention

000504

The value of next-generation sequencing in diagnosis and therapy of critically ill patients with suspected bloodstream infections: a retrospective cohort studyR. Overbeek¹, C. Leitl¹, S. E. Stoll¹, W. Wetsch¹, T. Kammerer¹, A. Mathes¹, B. W. Böttiger¹, H. Seifert², F. Dusse¹¹Department of Anesthesiology and Intensive Care Medicine, Faculty of Medicine, University Hospital of Cologne, University of Cologne, Cologne, Germany; ²Institute for Medical Microbiology, Immunology and Hygiene, Faculty of Medicine, University Hospital Cologne, University of Cologne, Cologne, Germany**Correspondence:** R. Overbeek*Intensive Care Medicine Experimental* 2023, **11(Suppl 1)**:000504

Introduction: Bloodstream infection (BSI), a frequent cause of severe sepsis, is a life-threatening complication in critically ill patients and associated with a high mortality rate. Prompt pathogen identification is the crucial factor in the diagnosis and treatment of patients with suspected BSI in intensive care medicine. It allows for targeted antimicrobial therapy, thus improving patients' outcome, as emphasized in the surviving sepsis campaign. Currently, blood culture (BC) is still the gold standard method for diagnosis of BSI, despite of its low sensitivity, long culture time and high risk of contamination. Next-Generation-Sequencing (NGS) is a promising alternative which could potentially enhance patient outcomes and lower healthcare expenses by offering faster and more precise infection diagnosis and guiding appropriate treatment decisions [1–2]. NGS is based on the unbiased sequence analyses of circulating cell-free deoxyribonucleic acid (cfDNA) from plasma [3]. As cfDNA can originate from bacterial, fungal, parasitic and viral microorganisms, it allows NGS to detect multiple pathogens in a single sample which could be particularly beneficial in patients with suspected polymicrobial infections or unclear focus.

Objectives: This study aimed to evaluate the potential diagnostic benefit of additional NGS using the DISQVER[®] pathogen test for patients with suspected BSI in the Intensive Care setting and its impact on antimicrobial therapy.

Methods: In this retrospective single-centre study, adult patients admitted on intensive care unit (ICU) with suspected BSI were analysed with BCs and NGS simultaneously. Microbiological results of pathogen diagnostics of both tests were compared with clinical data of infection. The analysed timeframe included a maximum of five days before and after initiation of the first NGS diagnostic. Focus of the analysis was on relevant changes of antimicrobial therapy and infectious source control procedures in response to BC and NGS results within seven days after first initiation of NGS. A panel of at least two intensivists examined all medical files to assess the relevance of NGS and BC results. Data were analysed using the Chi-Square and Fisher's exact test and the independent student t-test. This study was approved by the Ethical Committee of University Hospital Cologne, Germany.

Results: 30 patients with parallel NGS and BC samplings were assessed. NGS had a positivity rate of 60% (18/30) and detected 35 relevant pathogens (bacteria: 22, viruses: 12, fungi: 1). In contrast, BC had a positivity rate of 23% (7/30) and detected nine relevant pathogens (bacteria: 7 fungi: 2). There were no significant differences between NGS positive and negative patients concerning demographical data, comorbidities, in hospital mortality and laboratory findings on sample

day. NGS led to initiation of antibiotic therapy in three cases and further diagnostics (real-time PCR) in two cases. Current empiric antibiotic treatment was confirmed by NGS results in seven cases (Fig. 1). In contrast, in 10 cases NGS diagnostics revealed negative results which were in concordance with clinical data. In two cases NGS failed to detect possible relevant pathogens.

Conclusions: Due to its higher sensitivity in detecting relevant pathogens in patients with suspected BSI, NGS may lead to a higher rate of targeted antibiotic treatment. Moreover, NGS may guide further virological diagnostics and consequently antiviral therapy. Vice versa, in our study NGS had a high negative predictive value which could be beneficial in avoiding overtreatment. Larger randomized multicentre studies are required to validate these findings.

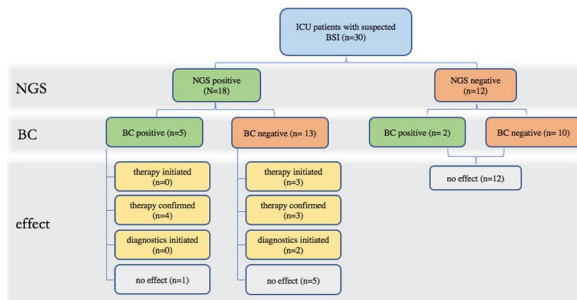

Figure 1 (abstract 000504) Flow-chart: effect of additional NGS considering BC results

References

- 3) Grumaz S, Stevens P, Grumaz C, Decker SO, Weigand MA, Hofer S, et al. Next-generation sequencing diagnostics of bacteremia in septic patients. *Genome Medicine*.2016;8(1):73.
- 2) Long Y, Zhang Y, Gong Y, Sun R, Su L, Lin X, et al. Diagnosis of Sepsis with Cell-free DNA by Next-Generation Sequencing Technology in ICU Patients. *Archives of medical research*.2016;47(5):365–71
- 1) Cao XG, Zhou SS, Wang CY, Jin K, Meng HD. The diagnostic value of next-generation sequencing technology in sepsis. *Frontiers in cellular and infection microbiology*.2022;12:899508

Topic: Sepsis

000509

Effect of different noninvasive respiratory support methods on gas exchange parameters in the postoperative cardiac surgery patients

D. Fomina¹, A. Eremenko¹, R. Komnov¹, L. Sorokina¹, A. Urbanov¹
¹Cardiac Intensive Care Unit, Petrovsky National Research Center of Surgery, Moscow, Russia

Correspondence: D. Fomina

Intensive Care Medicine Experimental 2023, **11(Suppl 1)**:000509

Introduction: Methods of noninvasive respiratory support are used to improve gas exchange, reduce the work of respiration and straightening of the collapsed alveoli due to formation of hypoventilation and microatelectasis. The most commonly used methods: non-invasive mask positive pressure ventilation (NIMPPV), high-flow nasal oxygen therapy (HFNO) and non-invasive positive pressure ventilation with helmet (NIHPPV).

Objectives: Comparison of the effectiveness of respiratory support methods depending on their effect on gas exchange in patients with moderate respiratory failure in the early period after cardiac surgery.

Methods: In randomized prospective study (ClinicalTrials.gov—NCT 04787666) 42 cardiac surgery patients with 200 < P/F < 300 were divided into 3 groups depending on the methods of respiratory support used (NIMPPV; HFNO and NIPPV). The main point of the study was to assess the dynamics of the gas exchange before, during and after their application. To carry out ventilation with a helmet, a higher level of pressure support than in mask ventilation was required due to the presence of an additional ventilated space inside it.

Results: All three methods demonstrated statistically significant improvement in gas exchange (SpO₂, PaO₂, HbO₂, Qsp/Qt), which persisted after the end of their application (Table 1). In this pilot study we did not receive significant differences between the methods investigated on their effect on blood gases and SpO₂.

Table 1 (abstract 000509) Dynamics of blood gases and SpO₂ during noninvasive respiratory support

Parameters	NIMPPV	p1-p2 p2-p3 p1-p3	HFNO	p1-p2 p2-p3 p1-p3	NIHPPV	p1-p2 p2-p3 p1-p3
SpO ₂ , %	87 ± 3	<0,001	90 [87; 98]	<0,001	89 ± 2	<0,001
1. Before	97 ± 2	<0,001	97 [93; 98]	<0,001	98 ± 2	<0,001
2. During	92 ± 3	<0,001	92 ± 3	0,02	94 ± 3	<0,001
3. After						
paO ₂ , mmHg	57 [50; 60]	<0,001	57 [60; 62]	<0,001	56 ± 10	<0,001
1. Before	107 ± 22	<0,001	85 ± 20	<0,001	100 ± 26	<0,001
2. During	62 ± 7	<0,001	60 ± 9	0,04	63 [59; 77]	0,01
3. After						
HbO ₂ , %						
1. Before	88,1 ± 3,8	<0,001	88,58 ± 3,36	<0,001	89,27 ± 3,1	<0,001
2. During	96,4 [94; 97,3]	<0,001	95,72 ± 0,92	<0,001	96,68 ± 1,02	<0,001
3. After	90,4 ± 3,6	0,02	90,53 ± 3,36	0,02	91,98 ± 3,17	0,04
Qsp/Qt (est), %						
1. Before	29,28 ± 7,93	<0,001	28,6 [7,9; 35,5]	<0,001	23,63 ± 7,46	0,03
2. During	17,9 [7,9; 20]	0,37	19,8 ± 6,1	0,87	15,76 ± 5,54	0,87
3. After	18,49 ± 10,86	<0,001	20,7 ± 7,83	0,03	16,46 ± 8,52	0,01

No significant changes in PaCO₂ was observed. NIHPPV significantly reduces the number of patients with P/F less than 300 in comparative with other group. In the course of this study, no data were revealed on changes in PaCO₂. A decrease in the proportion of patients with P/F < 300 after a single session in the NIMVL group by 2 times, in the HFNO group—by 1.6 times, in the NIVLH group—by 3.5 times

Conclusions: Noninvasive respiratory support significantly improves oxygenating lung function in the early postoperative period of cardiac surgery patients. NIHPPV and NIMPPV are more effective compared to HFNO. In case of helmet interface, a higher level of support was required and the most significant clinical effect was achieved.

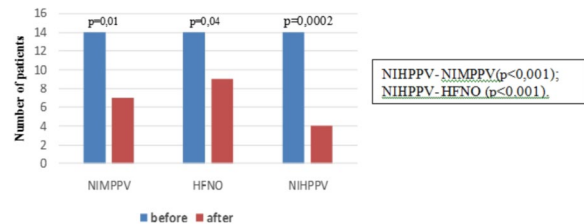

Note: p—statistical significance between periods of respiratory support inside each group. In the frame—statistically difference between effects of the helmet ventilation and mask and high flow support.

Topic: Acute respiratory failure and mechanical ventilation

000510

RNA binding protein DDX21 controls the sorting of microRNAs into exosomes through binding to specific motif in ARDS inflammatory response

H. Li¹, W. Huang², L. Liu³

¹Department of Critical Care Medicine, Zhongda Hospital, School of Medicine, Southeast University, Nanjing, Jiangsu, China; ²Department of Critical Care Medicine, Zhongda Hospital, Nanjing, China; ³Department

of Critical Care Medicine, Zhongda Hospital, Southeast University, Nanjing, China

Correspondence: H. Li

Intensive Care Medicine Experimental 2023, **11(Suppl 1)**:000510

Introduction: Exosomes are found to play an essential role in cell-cell crosstalk. Recent studies indicated that exosomes released by lung epithelial cell can activate pro-inflammatory macrophages by carrying microRNAs, which plays an important immunomodulatory role in ARDS1. However, the mechanisms that control the specific loading of microRNAs into exosomes remain unknown. Here we aimed to identify special pattern of microRNAs sorting into exosomes derived from lung epithelial cell, and the key molecule which determines the secretion of microRNAs during ARDS.

Objectives: To investigate the mechanisms that control the specific loading of microRNAs into lung epithelial cell-derived exosomes which are responsible for triggering inflammation of ARDS.

Methods: Exosomes were isolated from cell culture supernatants of murine lung epithelial (MLE-12) cells treated or untreated with LPS and intratracheally injected in C57BL/6 mice. RAW264.7 and alveolar macrophages MH-S were stimulated with LPS-treated exosomes (LPS-Exos). The microRNA sequencing for LPS-Exos and Ctrl-Exos were used to discover functional microRNAs and specific motif. We used biotinylated microRNA probe combining mass spectrometry to seek the key molecules that mediate the sorting of microRNAs into epithelial cell-derived exosomes. Western blotting and immunohistochemistry analysis were used to detect the expression of DDX21. Lentiviral infection was conducted to silence or overexpress DDX21 in epithelial cell line. Site-directed mutagenesis of the identified sequence was performed to exam the effect of the specific motif.

Results: LPS-Exos enhanced lung injury and polarization of M1 pro-inflammatory phenotype of macrophages (Fig. 1). Microarray analysis showed that the upregulated microRNAs were associated with pro-inflammatory factors and contained a "GGCGGGG" motif in LPS-Exos (Fig. 2a and b). Further detection the level of miRNAs containing the specific motif through RT-qPCR confirmed the microarray results (Fig. 2c). DDX21 could bind microRNAs containing specific motif (Fig. 3b). After silencing or overexpressing DDX21 by lentiviral infection (Fig. 3d), significant changes were observed in microRNA containing the specific motif in exosomes, such as microRNA-4332-3P, as well as IL-6 and TNF- α of macrophages treated with exosomes (Fig. 3e). DDX21 was increased in exosomes in bronchoalveolar lavage of ARDS patients (Fig. 3c), and in the lung tissues of mice intratracheal injected with LPS-Exo (Fig. 3a), as well as in LPS treated lung epithelial cells and LPS-Exos (Fig. 3c).

Conclusions: This study for the first time found that the microRNAs that promote ARDS inflammation contain specific motif. DDX21 could bind and sort series of pro-inflammatory microRNAs containing specific motif into lung epithelial cell-derived exosomes.

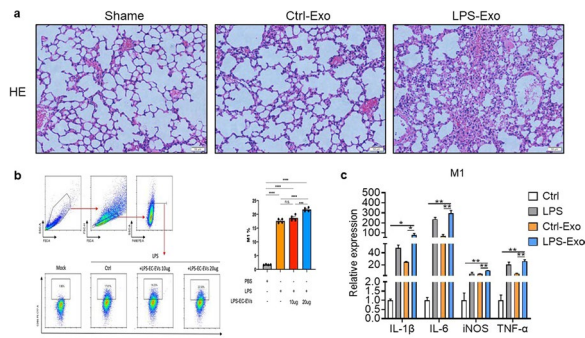

Figure 1 (abstract 000510) LPS-Exos enhanced lung injury and polarization of M1 pro-inflammatory phenotype of macrophages in mice. **a** Lung histology was assessed by H&E staining to determine acute lung injury (n=3). **b** M1 polarization of macrophages was determined by flow cytometry and RT-qPCR analysis. **P*-value < 0.05; ***P*-value < 0.01

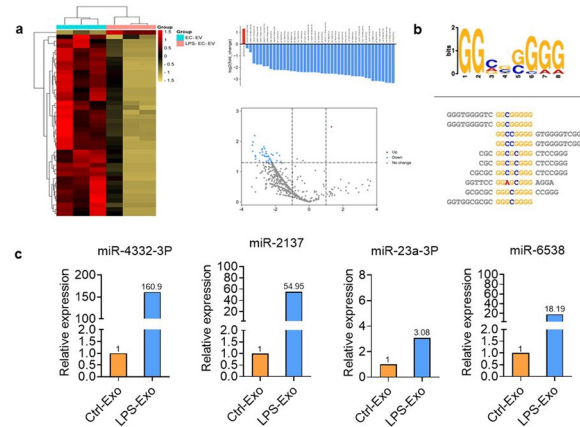

Figure 2 (abstract 000510) The pro-inflammatory microRNAs were increased and contained motif that control their sorting into exosomes derived from lung epithelial cells. **a** Microarray analysis of exosomal miRNAs from lung epithelial cell in resting and LPS activated conditions. **b** Specific motif in upregulated and pro-inflammatory related microRNAs. **c** qPCR analysis of microRNAs containing "GGCGGGG" motif in exosomes from control cells (Ctrl-Exo) or LPS treated cells (LPS-Exo)

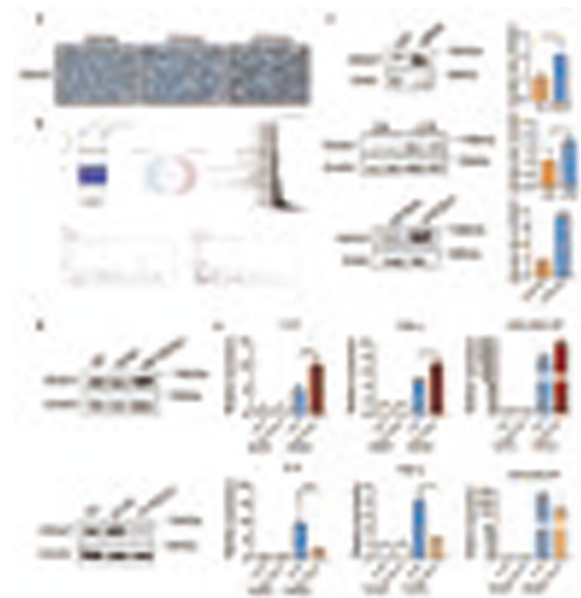

Figure 3 (abstract 000510) DDX21 controlled the loading of microRNAs into exosomes through binding series microRNAs containing specific motif. **a** Immunohistochemistry analysis of DDX21 in lung tissues from mice intratracheal injection of saline, Ctrl-Exo or LPS-Exo. **b** Mass spectrometry analysis results of RNA binding protein for biotinylated microRNA probe. **c** Western blot analysis of DDX21 in exosomes from bronchoalveolar lavage of ARDS patients, lung epithelial cells and derived exosomes. **d** Western blot verification of DDX21 level in control cells and cells silenced or overexpressed with lentiviral against DDX21. **e** qPCR analysis of IL-6, TNF- α and miR-4332-3P in exosomes from control cells and cells silenced or overexpressed against DDX21. **P*-value < 0.05; ***P*-value < 0.01

References

1. Hu Q, Lyon CJ, Fletcher JK, et al. Extracellular vesicle activities regulating macrophage- and tissue-mediated injury and repair responses. *Acta Pharm Sin B* 11, 1493–1512 (2021).
2. This work was supported by National Natural Science Foundation of China [Grant number 82270083].

Topic: Acute respiratory failure and mechanical ventilation

000512

Carboxyhemoglobin predicts oxygenator performance and imminent oxygenator exchange in extracorporeal membrane oxygenation

R. Erlebach¹, A. Buhlmann¹, R. Andermatt¹, B. Seeliger², K. Stahl³, C. Bode⁴, P. D. Wendel Garcia¹, S. David¹

¹Institute of Intensive Care Medicine, University Hospital Zurich, Zurich, Switzerland; ²Department of Respiratory Medicine, Hannover Medical School, Hannover, Germany; ³Department of Gastroenterology, Hepatology and Endocrinology, Hannover Medical School, Hannover, Germany; ⁴Department of Anaesthesiology and Intensive Care Medicine, University Hospital Bonn, Bonn, Germany

Correspondence: R. Erlebach

Intensive Care Medicine Experimental 2023, **11(Suppl 1)**:000512

Introduction: Hemolysis during extracorporeal membrane oxygenation (ECMO) is a common complication often caused by increasing resistance to flow due to progressive thrombosis and excessive mechanical stress, especially high negative pressures (1). Carbon monoxide—formed through degradation of heme by heme-oxygenase—binds with high affinity to hemoglobin (2) producing Carboxyhemoglobin (COHb). High COHb levels caused by excessive hemolysis and reduced elimination due to impaired gas exchange through the oxygenator might therefore be a novel point-of-care marker of oxygenator dysfunction.

Objectives: The aim of this study was to evaluate COHb, sampled from a conventional arterial blood gas analysis, as a marker of oxygenator dysfunction and its predictive value for oxygenator exchange in patients on ECMO.

Methods: Retrospective single-center analysis of all patients requiring ECMO support having experienced at least one oxygenator exchange between 2018 and 2021 at our Institute of Intensive Care Medicine. Multivariable, generalized mixed-effects models and time-varying proportional hazards models, adjusting for a set of predefined, causally identified confounders of hemolysis and ECMO circuit lifespan, were employed.

Results: In total 484 ECMO patients were screened of whom 89 required one or more oxygenator exchanges and were included into the final cohort. Of these 33 (37%) patients received ECMO in v-v configuration and 56 (63%) in v-a configuration. Cumulatively, 116 oxygenator exchanges were detected over 1833 patient days, including 20,000 COHb measurements. COHb was independently associated with oxygenator performance assessed by means of the partial pressure of oxygen in a post-oxygenator blood gas analysis sampled after the performance of an oxygen challenge (log Effect Size -7.0 [95% CI -11.5 to -2.5], $p=0.032$). Similarly, increasing COHb levels were independent predictors of an oxygenator exchange in the ensuing 6 h (log Odds Ratio 0.78 [95% CI 0.18 to 1.38], $p=0.0111$) and rising levels were independently associated with an absolute increase in the hazard of oxygenator exchange (Hazard Ratio 1.55 [95% CI 1.11 to 2.17], $p=0.0102$).

Conclusions: COHb is independently associated with reduced oxygenator performance and predicted imminent oxygenator exchange in a retrospective fashion. Its universal bedside availability, rapid turnover, and association with oxygenator performance makes COHb an interesting candidate for routine monitoring of ECMO patients.

References

- 1) Dufour N, Radjou A, Thuong M. Hemolysis and Plasma Free Hemoglobin During Extracorporeal Membrane Oxygenation Support:

From Clinical Implications to Laboratory Details. *ASAIO Journal*. 2020 Mar;66(3):239–46.

- 2) Ryter SW, Otterbein LE, Morse D, Choi AMK. Heme oxygenase/carbon monoxide signaling pathways: regulation and functional significance. *Mol Cell Biochem*. 2002;234–235(1–2):249–63.

Topic: Acute respiratory failure and mechanical ventilation

000513

Outcomes and predictors of hospital death among patients attended by rapid response team admitted to the intensive care/stepdown unit

V. Barbosa Galindo¹, T. Dias Midega¹, G. Martins De Souza¹, F. Hohmann¹, M. Assis¹, A. Pardini¹, M. Jaures¹, R. Cordioli¹, T. Domingos Corrêa¹

¹Department of Critical Care Medicine, Albert Einstein Israelite Hospital, São Paulo, Brazil

Correspondence: V. Barbosa Galindo

Intensive Care Medicine Experimental 2023, **11(Suppl 1)**:000513

Introduction: It has been demonstrated that the implementation of an intensivist-led rapid response team (RRT) is associated with better clinical outcomes (1). Nevertheless, predictors of mortality among patients admitted to the intensive care unit (ICU) or to the stepdown unit (SDU) after a RRT activation are not fully understood.

Objectives: To describe clinical characteristics, resources, main outcomes, and to address predictors of hospital mortality among patients admitted to the ICU/SDU after RRT activation.

Methods: Retrospective, single center, cohort study, conducted in a medical-surgical ICU/SDU located in a private quaternary care hospital. Adult patients admitted to the ICU or SDU from 2012 to 2020 were compared according to hospital mortality. Multivariate logistic regression analysis was performed to identify the predictors of hospital mortality.

Results: Among the 3841 patients included in this analysis [3165 (82.4%) survivors and 676 (17.6%) non-survivors], 1972 (51.3%) were admitted to the ICU and 1869 (48.7%) were admitted to the SDU. Compared to survivors, non-survivors were older [76 (64–87) yrs. vs. 67 (50–81) yrs; $p < 0.001$], had higher SAPS III score [64 (56–72) vs. 49 (40–57); $p < 0.001$] and longer hospital stay before unit admission [8 (3–19) days vs. 2 (1–7) days; $p < 0.001$]. Non-survivors used more non-invasive ventilation (42.2% vs. 20.9%; $p < 0.001$), mechanical ventilation (36.7% vs. 9.3%; $p < 0.001$), vasopressors (39.2% vs. 12.3%; $p < 0.001$), renal replacement therapy (15.5% vs. 4.3%; $p < 0.001$), and blood transfusion (34.9% vs. 14.0%; $p < 0.001$). Results of the multivariate analysis are shown in Table 1.

Table 1 (abstract 000513) Multivariate logistic regression analysis addressing risk factors for hospital mortality in patients admitted to the ICU or to SDU after rapid response team activation

Predictors	OR (CI 95%)	p-value
SAPS III score		
≤ 42	1.00 (Reference)	
43–50	1.81 (1.07–3.07)	0.027
51–59	3.00 (1.83–4.92)	< 0.001
≥ 60	6.15 (3.75–10.08)	< 0.001
Charlson Comorbidity Index		
0	1.00 (Reference)	
1–2	2.05 (1.41–3.00)	< 0.001
3–4	2.02 (1.35–3.03)	< 0.001
≥ 5	4.51 (2.98–6.83)	< 0.001
LOS before unit admission (days)		
≤ 1	1.00 (Reference)	
2–3	1.26 (0.90–1.78)	0.181

Predictors	OR (CI 95%)	p-value
4–8	2.14 (1.57–2.91)	<0.001
≥ 9	2.49 (1.88–3.29)	<0.001
Immunosuppression	1.54 (1.22–1.95)	<0.001
SpO ₂ < 92% criteria for RRT activation	1.51 (1.18–1.93)	<0.001
Night shift	1.35 (1.11–1.66)	0.003
Support during ICU stay		
High-flow nasal canula	2.28 (1.18–4.37)	0.014
Non-invasive ventilation	1.49 (1.20–1.86)	<0.001
Mechanical ventilation	2.56 (1.97–3.40)	<0.001
Vasopressors	1.68 (1.30–2.17)	<0.001
Blood transfusion	1.56 (1.23–1.97)	<0.001

OR: odds ratio; 95% CI: 95% confidence interval; SAPS 3: Simplified Acute Physiology Score 3; LOS: Length of stay; SpO₂: Peripheral oxygen saturation

Conclusions: Multiple factors may affect clinical outcomes among patients admitted to the ICU/SDU after RRT activation. Therefore, efforts should be made to boost RRT effectiveness to improve quality of care and patient safety.

References

- None.
1. Jung B, Daurat A, De Jong A, Chanques G, Mahul M, Monnin M, et al. Rapid response team and hospital mortality in hospitalized patients. *Intensive Care Medicine*. 2016;42(4):494–504.

Topic: Critical care organisation, quality management, information systems, outcomes

000519

Diastolic Shock Index—a useful trigger to early vasopressor initiation in septic shock

A. Alexandre¹, J. Colaço¹, P. Povoá²

¹Intensive Care Medicine Department, Hospital da Luz Lisboa, Lisboa, Portugal; ²Intensive Care Unit 4, Intensive Care Medicine Department, São Francisco Xavier Hospital, CHLO, Lisbon, Portugal

Correspondence: A. Alexandre

Intensive Care Medicine Experimental 2023, **11(Suppl 1)**:000519

Introduction: In septic shock, hypotension/hypoperfusion may arise from multiple causes: vasodilation, absolute and relative hypovolemia, septic myocardial dysfunction, and microcirculatory dysfunction [1]. The severity of peripheral vasodilation is of particular interest because it impacts the need and timing of vasopressors introduction during treatment. Recently, Ospina-Tascón et al. [2] proposed the use of a new marker of vasodilation severity—the Diastolic Shock Index (DSI). The DSI is the ratio between heart rate (HR) and diastolic arterial pressure (DAP) and is suggested to represent the impact of DAP (mainly determined by vascular tone) on vasodilation, while reflecting the severity of circulatory dysfunction by accounting for HR. They postulated that higher DSI values were associated with higher mortality and that its identification during initial assessment could signal patients prone to benefit from early vasopressors initiation through shock resuscitation. A previous work from our group confirmed the prognostic value of DSI in septic shock patients (median DSI = 2.3 in non-survivors) [3].

Objectives: To test the impact on hospital mortality of using DSI as a trigger to early vasopressor initiation in septic shock patients.

Methods: We designed a target trial using the Medical Information Mart for Intensive Care IV (MIMIC IV) v0.4 database [4, 5]. Adult patients (≥ 18 years-old) with septic shock (according to the SEPSIS-3 definition [6]) at intensive care unit (ICU) admission were selected. DSI was calculated as HR/DAP obtained upon initiation of fluid resuscitation. Patients with DSI ≥ 2.3 (indicating a worse prognosis) were included for analysis and assigned to early (≤ 1 h after first fluid bolus) or late (> 1 h) vasopressor initiation groups. Propensity score matching

(corrected variables: age, sex, lactate, SOFA and SAPS II scores) was used to evaluate the impact of early vs. late vasopressor initiation on hospital mortality in this septic shock population with high DSI.

Results: We studied 165 patients admitted for septic shock with DSI ≥ 2.3. Fifty-one percent were males, median age was 66 years (Interquartile Range [IQR]: 54–78) and the hospital mortality during the studied admission was 69%. At the first 24 h of ICU stay, the mean SAPS-II score was 56 ± 17 and the median SOFA score was 8 (IQR: 5–11). The mean DSI at enrolment was 2.6 (IQR: 2.4–2.9). After propensity score matching, early vasopressor group was associated with lower hospital mortality (odds ratio [OR] 0.85; 95% confidence interval [95% CI]: 0.77–0.95; *p* = 0.004).

Conclusions: Our findings reinforce the utility of DSI, not only as mortality predictor, but also as a trigger to early vasopressor initiation in septic shock patients. Its potential benefit on hospital mortality by highlighting vasopressor therapy urgency merits further research.

References

1. Vincent JL, De Backer D. Circulatory shock. *N Engl J Med*. 2013;369(18):1726–34.
2. Ospina-Tascón, G.A., Teboul, J.L., Hernandez, G. et al. Diastolic shock index and clinical outcomes in patients with septic shock. *Ann. Intensive Care* 10, 41 (2020).
3. ESICM LIVES 2021: Part 2. *Intensive Care Med* 2021 91 [Internet] 2021 [cited 2023 Apr 9];9(1):1–260.
4. Johnson A, Bulgarelli L, Pollard T, Horng S, Celi L A, Mark R. MIMIC-IV (version 0.4). *PhysioNet*. 2020. Available from: <https://doi.org/10.13026/a3wn-hq05>.
5. Goldberger A, Amaral L, Glass L, Hausdorff J, Ivanov PC, Mark R, Mietus JE, Moody GB, Peng CK, Stanley HE. *PhysioBank, PhysioToolkit, and PhysioNet: Components of a new research resource for complex physiologic signals*. *Circulation* [Online]. 101 (23), pp. e215–e220.
6. Singer M, Deutschman CS, Seymour CW, et al. The Third International Consensus Definitions for Sepsis and Septic Shock (Sepsis-3). *JAMA*. 2016;315(8):801–810. <https://doi.org/10.1001/jama.2016.0287>
7. None

Topic: Sepsis

000520

Blood stream infections in COVID-19 critically ill patients: a focus on Enterococcus and Candida species

C. C. Theocharidou¹, M. Endiaroglou¹, A. Dimaki¹, I. Gourlomat¹, Z. Kokkoni¹, A. Lionta¹, G. Zaptsi¹, F. Ampatzidou¹

¹3rd ICU, General Hospital of Thessaloniki “George Papanikolaou”, Thessaloniki, Greece

Correspondence: C. C. Theocharidou

Intensive Care Medicine Experimental 2023, **11(Suppl 1)**:000520

Introduction: A higher incidence of blood stream infections (BSIs) has been reported among COVID-19 critically ill patients. Two frequently documented pathogens that often cause prolonged ICU stay or even death in these patients are Enterococcus and Candida.

Objectives: We aimed to compare characteristics of patients with candidemia and enterococcal BSI to those of patients who were not affected.

Methods: We included patients admitted to the ICU department from April 2021 to April 2023. Including patients with positive blood cultures (Enterococcus or Candida species), we extracted the following data: sex, age, APACHE score, ICU stay duration, outcome (death or ICU discharge), blood culture results, and vaccination status. We used SPSS Statistics for the analysis. Statistical significance was set at *p* = 0.05.

Results: We included 308 patients (mean age = 66.94 years, SD = 13.34) out of whom 201 (65%) were male and 177 were not vaccinated (57%). Thirty-three patients (11%) developed candidemia and 64 patients (21%) developed enterococcal BSI. In 13 patients both BSIs were reported, in different timepoints. In 7 of them, candidemia occurred prior to enterococcal BSI. For all patients, the mean ICU stay was 13.62 days (SD = 17.96), and mean APACHE score was 20.89 (SD = 9.68). Both BSIs were associated with longer ICU stay (Table 1).

Patients afflicted with candidemia during their stay presented an increased likelihood of developing enterococcal BSI (OR=2.73, Confidence Interval—CI: 1.27, 5.84, $p=0.008$). Neither BSI increased the likelihood of death ($p=0.18$ for Candida and $p=0.14$ for Enterococcus). *Enterococcus faecium* bacteremia increased the likelihood of death significantly (OR=2.71, CI: 1.25, 5.89, $p=0.01$). Unvaccinated patients showed an increased likelihood of developing enterococcal BSI (OR=1.83, CI: 1.02, 3.26, $p=0.04$).

Table 1 (abstract 000520) Age, ICU stay and APACHE score for different groups of COVID-19 patients (*is for parametrical data)

	Patients with candidemia (N=33)				Patients without candidemia (N=275)				p		
	Median	IQR	Mean	SD	Median	IQR	Mean	SD			
Age (years)	67	59	73	65.82*	11.03	69	59	77	67.08	13.61	0.35
ICU stay (days)	17	9	35	28.48	32.91	8	2	16	11.77	14.14	<0.001
APACHE score	22	17.5	28	22.45*	8.07	20	13	27.5	20.55	9.99	0.22
	Patients with enterococcal BSI (N=64)				Patients without enterococcal BSI (N=244)				p		
	Median	IQR	Mean	SD	Median	IQR	Mean	SD			
Age (years)	69	62	77	66.76*	13.57	68	59	77	67.61	12.54	0.79
ICU stay (days)	20	12	37	28.94	28.12	7	2	13	9.42	10.69	<0.001
APACHE score	21	16.3	25	20.56*	6.54	20	13	28	20.97	10.33	0.78
	Patients who died in the ICU (N=148)				Patients discharged from the ICU (N=160)				p		
	Median	IQR	Mean	SD	Median	IQR	Mean	SD			
Age (years)	71	62	77	68.89*	11.31	66.5	56.5	77	65.01*	14.87	0.02
ICU stay (days)	9	5	20	14.11	15.76	7	2	16	13.15	19.92	0.02
APACHE score	24.5	20	32	25.71	8.47	15	10	21	16.12	8.38	<0.001

Conclusions: Candidemia and enterococcal BSI both prolong ICU stay but do not increase the likelihood of death in the ICU for COVID-19 patients. Candidemia COVID-19 patients developed enterococcal BSI more often than COVID-19 patients without candidemia.

References

- Kokkoris S, Papachatzakis I, Gavriellou E, Ntaidou T, Ischaki E, Malachias S, Vrettou C, Nichlos C, Kanavou A, Zervakis D, Perivolioti E, Ranellou K, Argyropoulou A, Zakyntinos S, Kotanidou A, Routsis C. ICU-acquired bloodstream infections in critically ill patients with COVID-19. *J Hosp Infect.* 2021 Jan;107:95–97. <https://doi.org/10.1016/j.jhin.2020.11.009>. Epub 2020 Nov 18
- Machado M, Estévez A, Sánchez-Carrillo C, Guinea J, Escríbano P, Alonso R, Valerio M, Padilla B, Bouza E, Muñoz P. Incidence of Candidemia Is Higher in COVID-19 versus Non-COVID-19 Patients, but Not Driven by Intrahospital Transmission. *J Fungi (Basel).* 2022 Mar 16;8(3):305. <https://doi.org/10.3390/jof8030305>
- Bonazzetti C, Morena V, Giacomelli A, Oreni L, Casalini G, Galimberti LR, Bolis M, Rimoldi M, Ballone E, Colombo R, Ridolfo AL, Antinori S. Unexpectedly High Frequency of Enterococcal Bloodstream Infections in Coronavirus Disease 2019 Patients Admitted to an Italian ICU: An Observational Study. *Crit Care Med.* 2021 Jan 1;49(1):e31–e40. <https://doi.org/10.1097/CCM.0000000000004748>

Topic: Infections and prevention

000521

Increased gamma power bilaterally in the medium prefrontal cortex, insula, angular gyrus and posterior cingulate cortex with diaphragm neurostimulation in ARDS patients

T. Bassi¹, E. Rohrs², M. Parfait³, J. Mayaux³, D. Maxens³, S. Reynolds², T. Similowski³, A. Demoule³, M. Dres³

¹Research, Lungpacer Medical Inc., Vancouver, Canada; ²Critical Care, Advancing Innovation in Medicine Institute, New Westminster, Canada;

³Neurophysiologie respiratoire expérimentale et clinique, Sorbonne Université, Paris, France

Correspondence: T. Bassi

Intensive Care Medicine Experimental 2023, **11(Suppl 1)**:000521

Introduction: Cognitive and consciousness impairments have been associated with reduced electroencephalographic gamma power spectrum density (PSD) [1, 2]. Deep sedation associated with invasive mechanical ventilation (MV) has been associated with cognitive impairment and delirium in ICU survivors [3, 4].

Objectives: This study investigated whether diaphragm neurostimulation in synchrony with MV would result in changes in gamma PSD in critically ill patients receiving MV.

Methods: Five deeply sedated ICU patients undergoing MV for moderate ARDS were included in this study. A central-line catheter embedded with electrodes was inserted via the left subclavian vein to stimulate the phrenic nerves bilaterally, in synchrony with MV. The study protocol was comprised of two hours with no diaphragm neurostimulation (unpaced sessions), and two hours with diaphragm neurostimulation during inspiration on every breath (paced sessions). All ventilator settings and administered medications remained unchanged during the study. A 32-channel electroencephalogram was used to collect brainwave activity during the study. Data from the frontal, temporal and parietal lobes, only, were collected. Four occipital channels were not used. PSD for the gamma frequency band was calculated as mV2/Hz. Wilcoxon paired test was used for linear analysis between the sessions. Data are reported as median (interquartile range). P-values < 0.05 were considered statistically significant.

Results: A significantly greater gamma PSD was observed bilaterally in the medium prefrontal cortex, insula, posterior cingulate gyrus, and angular gyrus during paced sessions compared to unpaced sessions (eight out of 28 channels). Average gamma PSD during the paced and unpaced sessions were, respectively: medial prefrontal cortex (left) 0.10 mV2/Hz (0.04–0.70) vs. 0.03 mV2/Hz (0.00–0.06), $p=0.0312$; medial prefrontal cortex (right) 0.10 mV2/Hz (0.05–0.70) vs. 0.02 mV2/Hz (0.01–0.05), $p=0.0312$; posterior cingulate cortex 0.07 mV2/Hz (0.01–0.74) vs. 0.02 mV2/Hz (0.00–0.04), $p=0.0312$; insula (left) 0.20 mV2/Hz (0.10–0.75) vs. 0.03 mV2/Hz (0.00–0.05), $p=0.0312$; insula (right) 0.11 mV2/Hz (0.05–0.78) vs. 0.04 mV2/Hz (0.00–0.06), $p=0.0312$; angular gyrus (left) 0.07 mV2/Hz (0.01–0.21) vs. 0.02 mV2/Hz (0.00–0.03), $p=0.0312$; and angular gyrus (right) 0.07 mV2/Hz (0.01–0.70) vs. 0.03 mV2/Hz (0.00–0.03), $p=0.0312$ (see Figure). No statistical difference in gamma PSD was observed between sessions, in the remaining 20 channels.

Conclusions: Diaphragm neurostimulation was associated with a greater gamma PSD bilaterally in the medial prefrontal cortex, the insula and the angular gyrus, and the posterior cingulate gyrus. The clinical effects of these changes warrant further studies.

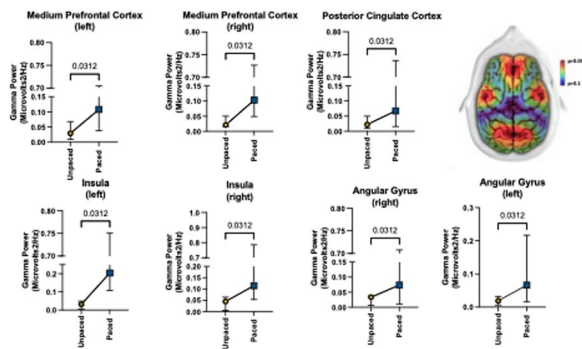

References

- Engel AK, Fries P, Singer W. DYNAMIC PREDICTIONS: OSCILLATIONS AND SYNCHRONY IN TOP-DOWN PROCESSING.; 2001. www.nature.com/revIEWS/neuro
- Salimi M, Javadi AH, Nazari M, et al. Nasal Air Puff Promotes Default Mode Network Activity in Mechanically Ventilated Comatose Patients: A Noninvasive Brain Stimulation Approach. *Neuromodulation*. 2022;25(8):1351–1363. <https://doi.org/10.1016/j.neurom.2021.11.003>
- Fleischmann R, Traenkner S, Kraft A, Schmidt S, Schreiber SJ, Brandt SA. Delirium is associated with frequency band specific dysconnectivity in intrinsic connectivity networks: Preliminary evidence from a large retrospective pilot case–control study. *Pilot Feasibility Stud*. 2019;5(1). <https://doi.org/10.1186/s40814-018-0388-z>
- Hesse S, Kreuzer M, Hight D, et al. Association of electroencephalogram trajectories during emergence from anaesthesia with delirium in the postanaesthesia care unit: an early sign of postoperative complications. *Br J Anaesth*. 2019;122(5):622–634. <https://doi.org/10.1016/j.bja.2018.09.016>
- Lungpacer Medical Inc.

Topic: Acute respiratory failure and mechanical ventilation

000523

The accuracy of dynamic parameters for prediction of fluid responsiveness in elderly patients with septic shock

S. Paphawin¹, Y. Sutherasan², P. Theerawit³, D. Junhasavasdikul⁴

¹Department of Internal Medicine, Faculty of Medicine Ramathibodi Hospital, Mahidol University, Bangkok, Thailand; ²Division of Pulmonary and Pulmonary Critical Care Medicine, Department of Internal Medicine, Mahidol University Faculty of Medicine Ramathibodi Hospital, Bangkok, Thailand; ³Division of Critical Care Medicine, Department of Internal Medicine, Faculty of Medicine Ramathibodi Hospital, Mahidol University, Bangkok, Thailand; ⁴Division of Pulmonary and Pulmonary Critical Care Medicine, Department of Internal Medicine, Faculty of Medicine Ramathibodi Hospital, Mahidol University, Bangkok, Thailand

Correspondence: Y. Sutherasan

Intensive Care Medicine Experimental 2023, **11(Suppl 1)**:000523

Introduction: Dynamic indicators derived from arterial pressure waveforms, such as stroke volume variation (SVV) and pulse pressure variation (PPV), have been used to assess fluid responsiveness (FR) in mechanically ventilated patients with septic shock. Aging is associated with an increase in the stiffness of the large arteries, resulting in the reduction of arterial compliance, which may increase pulse pressure and amplitude. Still, the stroke volume variation (SVV) does not change. Loss of arterial elasticity in elderly patients might affect PPV and SVV accuracy and its threshold value to predict FR. Several studies reported dynamic arterial elastance (Eadyn; PPV/SVV), which has been

proposed to assess functional arterial load. Eadyn can predict arterial pressure response [mean arterial pressure (MAP) responder] after a fluid challenge in the fluid responder patient. The predictive accuracy of PPV, SVV, and Eadyn has never been evaluated in elderly patients with septic shock.

Objectives: To assess the ability of the SVV and PPV to predict FR in mechanically ventilated elderly patients with septic shock. The secondary outcome was to test the ability of the Eadyn to predict an increase in MAP following volume expansion in preload-responsive elderly patients.

Methods: A prospective observational study was conducted on elderly patients with septic shock at Ramathibodi Hospital. We enrolled mechanically ventilated patients with ages > 65 years diagnosed with septic shock. The patients with limitations of PPV and SVV interpretation were excluded. SVV, PPV, Eadyn, and other hemodynamic data were recorded before and after the FR test. Positive FR is defined as cardiac output (CO) increase of 10% or more, assessed using the Vigileo™ or EV1000 after a passive leg raise test (PLR), mini-fluid challenge test, or fluid challenge. In patients with positive FR, SVV, PPV, Eadyn, and other hemodynamics were recorded before and after the fluid bolus. MAP responsiveness was described as a raised MAP of at least 10% after fluid loading.

Results: Of 104 elderly patients, 46 (44.2%) were classified as positive fluid responsiveness (defined by a CO increase of 10% or more after PLR, mini-fluid challenge test, or fluid challenge). The mean age was 78 ± 7 years. PPV and SVV were significantly higher in patients with positive FR than those without FR (22.07 ± 11.02 vs. 9.34 ± 7.39 ; $P < 0.001$ and 20 ± 11 vs. 9 ± 6 ; $P < 0.001$, respectively). The area under the PPV and SVV ROC curves was 0.875 (95% CI 0.802–0.947) and 0.841 (95% CI 0.757–0.925), respectively (Fig 1). The optimal threshold values for discrimination between FR and non-FR were 13.5% for PPV (sensitivity 81.8%, specificity 87.0%) and 11.5% for SVV (sensitivity 81.8%, specificity 87.0%). Among 46 patients who were positive for FR, 28 patients were MAP responders. Baseline Eadyn was higher in the MAP-responder group than in the MAP non-responder group (1.40 ± 0.57 vs. 0.98 ± 0.93 $P = 0.013$). The area under the Eadyn ROC curve was 0.844 (95% CI 0.704–0.894). The threshold value of Eadyn to predicting MAP-responder was 1.00 (sensitivity 85.7% and specificity 75%).

Conclusions: Despite the increased arterial stiffness in the elderly, PPV and SVV can predict fluid responsiveness in elderly patients with septic shock who underwent mechanical ventilation. Eadyn can predict MAP responsiveness in elderly patients.

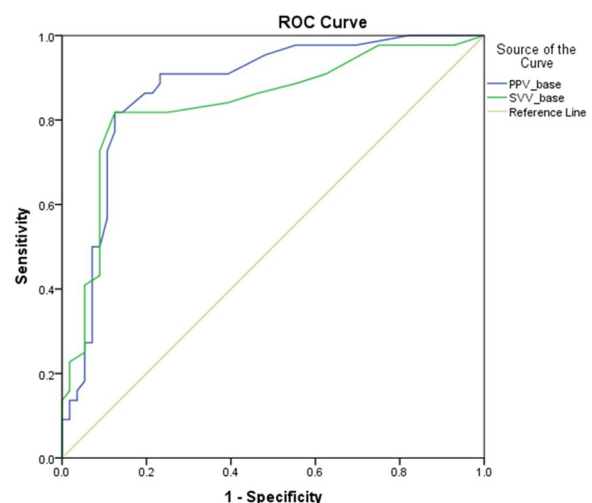

Figure 1 (abstract 000523) Prediction of fluid responsiveness by ROC curves of PPV and SVV in elderly

References

- García MI, Romero MG, Cano AG, Aya HD, Rhodes A, Grounds RM, et al. Dynamic arterial elastance as a predictor of arterial pressure response to fluid administration: a validation study. *Crit Care*. 2014;18(6):626.
- Steppan J, Barodka V, Berkowitz DE, Nyhan D. Vascular stiffness and increased pulse pressure in the aging cardiovascular system. *Cardiol Res Pract*. 2011;2011:263585

Topic: Sepsis

000524

Longitudinal trajectories of interleukin-6 predict ICU-admission and deleterious outcomes in patients with respiratory symptoms

M. M. Müller¹, M. Urner¹, A. T. Sage², E. Balzani¹, T. Kain¹, E. Fan¹, S. Husain³, S. Keshavjee⁴, L. Del Sorbo¹

¹Interdepartmental Division of Critical Care Medicine, University of Toronto, Toronto, Canada; ²Toronto Lung Transplant Program, Ajmera Transplant Center, University Health Network, Toronto, Canada; ³Department of Transplant Infectious Diseases, Multi-Organ Transplant Program, University Health Network, Toronto, Canada; ⁴Toronto Lung Transplant Program, Ajmera Transplant Center; Division of Thoracic Surgery, University Health Network, University of Toronto, Toronto, Canada

Correspondence: M. M. Müller

Intensive Care Medicine Experimental 2023, 11(Suppl 1):000524

Introduction: Respiratory tract infections (RTIs) represent a frequent cause for emergency department (ED) visits. The clinical trajectory of RTI can range from rapid recovery to severe respiratory and multi-organ impairment requiring ICU admission. Timely risk stratification is a critical component for the identification of patients at high risk for further deterioration requiring ICU care, since delayed ICU admission has been associated with worse outcomes.

Objectives: From 2020 to 2021, we conducted a biomarker study on patients presenting to the ED with respiratory symptoms. The present analysis aims to investigate the impact of deferred ICU admission on clinical outcomes and explore the potential utility of longitudinal Interleukin-6 (IL-6) measurements for early identification of patients requiring ICU care.

Methods: Patients presenting with symptoms of respiratory illness to the ED of the University Health Network (Toronto, CA) were enrolled. Individuals requiring inpatient management were categorized into three groups based on their ICU admission status: direct ICU admission from the ED, secondary transfer to the ICU after admission to the ward or discharge at home, and no ICU admission. The primary outcome was mortality at 28 days. As prognostic marker for ICU requirement, plasma IL-6 levels were measured on day 1, 2, 3, 5, and 7 after enrollment by immunoassay. In addition to descriptive statistics, we compared the discriminative ability of IL-6 for the prediction of ICU admission using ROC-curves.

Results: Of the 310 patients enrolled in the study, 168 required inpatient management, with 17 admitted to the ICU (11 directly and 6 secondary). Median age was 61 years; 12% had a community-acquired pneumonia, and 10% manifested signs of COVID-19 pneumonia, with no significant inter-group differences.

Patients with secondary ICU admission showed a higher mortality rate compared to directly admitted patients (4/6 vs. 1/11, $p=0.03$, Figure 1A). Plasma IL-6 levels at enrollment could discriminate for the risk of mechanical ventilation ($p<0.01$) and mortality ($p<0.05$) but failed to stratify for the overall requirement of ICU admission ($p=0.52$). Distinct longitudinal trajectories of plasma IL-6 levels were found for each of the 3 admission groups (Figure 1B). Higher IL-6 concentrations at day 1, 2, 3 and 7 were measured among patients with secondary admission compared to individuals not requiring ICU ($p<0.05$). In patients not immediately admitted to ICU, IL-6 measurements at day 2 showed a higher discriminative ability for the prediction of secondary ICU admission (AUC 0.92; cut-off value 209.3 pg/ml, Sen 1, Spe 0.92) compared to day 1 (AUC 0.73; cut-off value 22.9 pg/ml, Sen 1, Spe 0.47).

Conclusions: These findings demonstrate an association of deferred ICU admission with poor outcomes in patients with respiratory symptoms. Sequential measurements of IL-6 might be useful for stratification and early identification of patients at risk of further deterioration requiring transfer to an ICU facility.

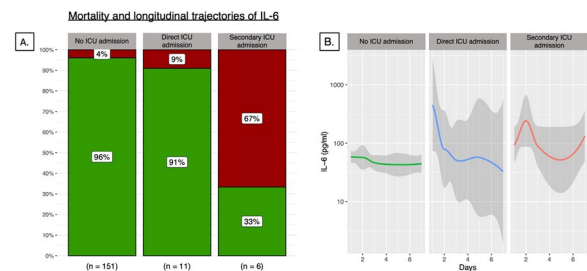

Figure 1 (abstract 000524) **A** Percentage of survivors (green) and non-survivors (red) at 28 days. Patients with secondary transfer to ICU had a higher 28-day mortality compared to directly admitted patients ($p=0.03$). **B** Longitudinal trajectories of plasma IL-6 levels in patients who were not admitted to ICU (green line), directly admitted to ICU (blue line), and those who were secondary transferred to ICU after admission to the ward or discharge at home (orange line)

Topic: Acute respiratory failure and mechanical ventilation

000525

Change of pulse pressure variation during reverse tidal volume challenge predicts fluid responsiveness in high risk surgical patients

S. Tetcharoenpanit¹, S. Morakul¹, W. Mongkolpun¹Anesthesiology, Ramathibodi Hospital, Mahidol University, Bangkok, Thailand

Correspondence: W. Mongkolpun

Intensive Care Medicine Experimental 2023, 11(Suppl 1):000525

Introduction: Volume expansion (VE) is applied during the perioperative period to restore blood pressure. However, excessive fluid balance is related to worse outcomes. A prediction of fluid responsiveness (FR) should therefore be performed before starting VE in order to optimize the fluid balance. A change in pulse pressure variation (PPV) during the recruitment maneuver (RM) is commonly used on surgical patients during the perioperative period, but the hemodynamic status might be deteriorated during RM.

Objectives: We aimed to evaluate whether a change of PPV from a transient reduction of tidal volume [reverse tidal volume challenge (rTVC)] can predict FR.

Methods: Patients who were scheduled for elective high risk abdominal surgery under general anesthesia using mechanical ventilation with an arterial catheter were included. After the induction of anesthesia, the tidal volume (VT) was set to 8 ml/kg for 5 min, and then rTVC was performed by decreasing VT from 8 to 6 ml/kg for 1 min. Hemodynamic variables, PPV were obtained before and immediately after rTVC was conducted. VE (250 ml, normal saline) was infused for 10 min. CI was measured by pulse contour analysis (HemoSphere[®], Edwards). A positive FR (+veFR) was defined by the function of $CI \geq 10\%$. Changes to PPV during rTVC (ΔPPV) were calculated as absolute values. Receiver operating characteristic curves were constructed and reported as areas under the curve (AUC) to predict +veFR.

Results: Fifty measurements were performed on 29 patients. Of these, 17 of the 50 assessments (34%) were +veFR. The mean age was 60 ± 12 years old, while 17/29 patients (58.6%) underwent liver surgery and 15/29 (51.7%) were ASA III. There were no differences in procedures or baseline hemodynamic variables, except PPV, between patients with +veFR and those with negative FR (-veFR) (Table 1). Only PPV decreased during rTVC in patients with +veFR (Table 2) and ΔPPV was greater in patients with +veFR than in the group (4 ± 2 vs 2 ± 1 ,

$p < 0.05$, respectively). Δ PPV (AUC 0.84 [0.73–0.95]) and baseline PPV (AUC 0.82 [0.71–0.93]) had the highest AUC for predicting +veFR with cut off values of ≥ 3.5 (sensitivity (Sn) 59%, specificity (Sp) 91%) and ≥ 12 (Sn 82%, Sp73%), respectively (Figure 1).

Table 1 (abstract 000525) Baseline hemodynamic variables between patients with +veFR and –veFR

Hemodynamic variables	+veFR (n = 17)	–veFR (n = 33)	p-value
Pulse pressure variation (%)	15 ± 4	9 ± 5	<0.01
Stroke volume variation (%)	14 ± 3	10 ± 4	<0.01
Pleth variability index (%)	16 ± 4	10 ± 5	<0.01
Stroke volume (mL)	70 ± 12	83 ± 26	0.1
Cardiac index (L/min/m ²)	3.0 ± 0.7	3.3 ± 1.1	0.2
Mean arterial pressure (mmHg)	76 ± 15	76 ± 11	0.9
Heart rate (bpm)	73 ± 15	67 ± 16	0.2

Table 2 (abstract 000525) Hemodynamic changes after reverse tidal volume challenge in +veFR and –veFR (* $p < 0.05$ Before vs After rTVC)

Hemodynamic variables	Before rTVC (Vt 8 ml/kg)	After rTVC (Vt 6 ml/kg)
Pulse pressure variation (%)		
+veFR	15 ± 4	10 ± 4*
–veFR	9 ± 5	7 ± 2
Mean arterial pressure (mmHg)		
+veFR	75 ± 15	76 ± 11
–veFR	76 ± 10	76 ± 10

Conclusions: Δ PPV during rTVC and baseline PPV can predict FR in high-risk surgical patients during perioperative period.

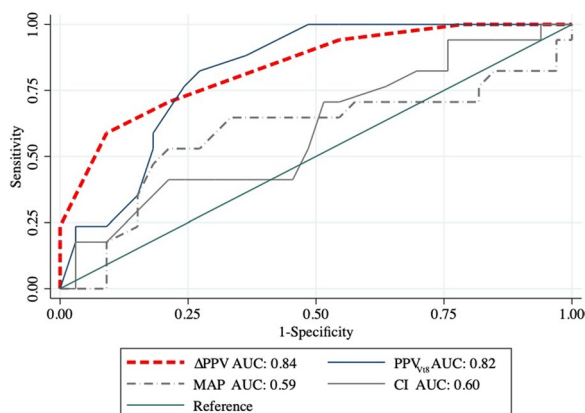

Figure 1 (abstract 000525) Baseline variables? PPV to predict FR +ve

References

1. No Grant

Topic: Perioperative care

000529

Frailty and outcomes among older critically ill patients with acute respiratory distress syndrome

S. Meng¹, Z. Jin¹, L. Wang¹, F. Guo¹

¹Jiangsu Provincial Key Laboratory of Critical Care Medicine, Department of Critical Care Medicine, Zhongda Hospital, School of Medicine, Southeast University, Nanjing, Jiangsu, China

Correspondence: S. S. Meng

Intensive Care Medicine Experimental 2023, 11(Suppl 1):000529

Introduction: Acute respiratory distress syndrome (ARDS) is a common disease in intensive care unit. Frailty, as a new prognostic indicator to describe the pre-hospital status, has received more and more attention in older patients with critically illness. However, it has not been elucidated whether or not frailty is associated with outcome of older patients with ARDS.

Methods: This was a retrospective cohort study conducted in the intensive care unit of a tertiary hospital. Aged 65 or older critically ill patients with ARDS were included and we accessed the clinical frailty scale (CFS) score before admission of these patients retrospectively. CFS score ≥ 5 was considered frailty. The outcome of this study was 28-day mortality.

Results: A total of 281 patients were included in the final analysis and 59.8% (168) of them were frail according to CFS (≥ 5). Frail patients had higher risk of 28-day mortality compared to those not frail (Hazard Ratio [HR] 2.94, 95% Confidence Interval [CI] 1.53–5.66, $p = 0.001$). 28.1% (n = 79) of all patients died within 28 days and the incidence of frailty was higher in death group than that of survivor group (82.0% vs 53.6%, $p = 0.000$). In multivariable cox regression, frailty was an independent risk factor for 28-day mortality in older patients with ARDS (HR 2.1422, 95% CI 1.247–3.676), $P = 0.006$.

Conclusions: In older patients with ARDS, the presence of frailty increased hazard ratio of 28-day mortality. The findings of this study implicated the importance of risk stratification of older patients with ARDS by clinical frailty before critical illness.

References

1. National Natural Science Foundation of China (82102300); Jiangsu Natural Science Foundation (BK20200367); China Postdoctoral Science Foundation (2022M710685).

Topic: Acute respiratory failure and mechanical ventilation

000532

Development of a predictive model for the occurrence of pressure ulcers of patients in intensive care units using AI

T. H. Kim¹, M. Kim², D. Kim², J. W. Heo³, D. Moon⁴, Y. Heo⁴, H. S. Choi⁵, S. S. Han³

¹University-Industry Cooperation Foundation, Kangwon National University, Chuncheon-si, Republic of Korea; ²Department of Research & Development, ZIOVISION Co., Ltd., Chuncheon-si, Republic of Korea; ³School of Medicine, Kangwon National University, Chuncheon-si, Republic of Korea; ⁴Pulmonology, Kangwon National University Hospital, Chuncheon-si, Republic of Korea; ⁵Department of Computer Science and Engineering, Seoul National University of Science and Technology, Seoul, Republic of Korea

Correspondence: T. H. Kim

Intensive Care Medicine Experimental 2023, 11(Suppl 1):000532

Introduction: The severe pressure ulcers (PUs) can worsen the patient's condition or require surgical treatment, which can increase the patient's medical expenses and increase the workload of medical staff in the intensive care unit (ICU) [1, 2].

Objectives: There are various evaluation tools for PU grade such as Braden score, Norton scale and Waterlow scale [3, 4]. These are widely used as important tools for assessing PU grade, but they have the disadvantage of being subjective and some factors are difficult to

understand [5]. Therefore, we developed an artificial intelligence (AI) model that can monitor the patient's condition in real-time to predict the occurrence of PUs and inform the medical staff.

Methods: In this study, patients with recoded for PUs occurrence in the nursing recodes and granted for PU grade were extracted from MIMIC-IV data [6]. Patients who had already occurred PUs before admission to the ICU were excluded from this study. Furthermore, we used almost variables that were used in previous studies related to pressure ulcers, as shown in Figure 1. We developed various machine learning (ML) models and deep learning (DL) models using multivariate time series data to develop predictive models, but we found that the performance of the model is degraded for missing values in the data. To overcome this problem, the multivariate time-series in real-data has missing values, and various models have been developed to solve this problem, including the GRU-D model. However, the GRU-D model also cannot handle such missing last observation value. So we developed the GRU-D++ model based on the GRU-D model to overcome this problem.

Results: As shown in Table 1, the logistic regression model and GRU-D++ model showed high performance among ML models and DL models. In the case of GRU-D++ model, AUROC was 0.941 at the PU occurrence time, and the AUROC was 0.910 at the 48 h before the occurrence of PU.

Table 1 (abstract 000532) Performance comparison of various AI models

	tzb*0 h		tzb12 h		tzb24 h		tzb48 h	
	AUROC	AUPRC	AUROC	AUPRC	AUROC	AUPRC	AUROC	AUPRC
Logistic regression	0.815	0.415	0.812	0.420	0.809	0.424	0.804	0.435
Decision tree	0.572	0.138	0.576	0.147	0.573	0.151	0.57	0.163
Random forest	0.821	0.393	0.818	0.400	0.814	0.404	0.808	0.413
XGBoost	0.813	0.382	0.809	0.390	0.804	0.392	0.799	0.406
RNN	0.867	0.496	0.856	0.478	0.860	0.505	0.853	0.516
GRU	0.913	0.619	0.905	0.612	0.899	0.616	0.878	0.593
LSTM	0.910	0.589	0.902	0.595	0.895	0.583	0.876	0.577
GRU-D	0.938	0.694	0.933	0.688	0.926	0.677	0.906	0.654
GRU-D++	0.941	0.694	0.936	0.687	0.930	0.683	0.910	0.659

tzb*: time-zero base

Conclusions: The AI-based PU prediction model developed in this study can be utilized to monitor the patient's condition in real-time and provide the medical staff with estimated timing of occurrence. Through this model, we can predict PU status in advance to improve patient's conditions and alleviate the workload of the medical staff in the ICU.

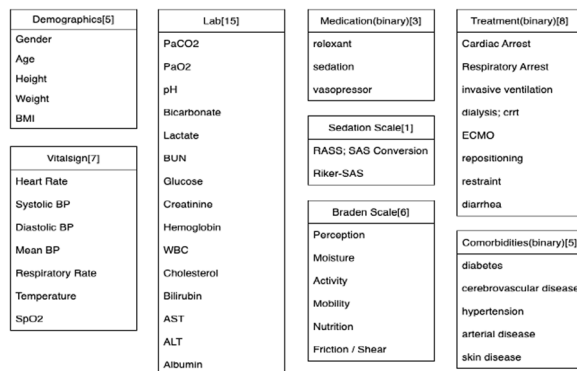

Figure 1 (abstract 000532) The variables for develop a pressure ulcer occurrence predict model

References

- [1] Kim, E., Ham, S., Jung, B.K., Park, J.-W., Kim, J., Lee, J.H. "Effect of baicalin on wound healing in a mouse model of pressure ulcers." *International Journal of Molecular Sciences* 24(1), 329 (2023)
- [2] Park, S.-H., Lee, Y.-S., Kwon, Y.-M. "Predictive validity of pressure ulcer risk assessment tools for elder: a meta-analysis." *Western Journal of Nursing Research* 38(4), 459–483 (2016)
- [3] Bergstrom, Nancy. "The Braden Scale for predicting pressure sore risk." *Nurs. res.* 36(4), 205–210 (1987)
- [4] Norton, D. "Calculating the risk. Reflections on the Norton Scale." *Advances in Skin & Wound Care*, 2(3), 24–31 (1989)
- [5] Papanikolaou, P., Lyne, P., Anthony, D. "Risk assessment scales for pressure ulcers: a methodological review." *International journal of nursing studies* 44(2), 285–296 (2007)
- [6] Johnson, Alistair, Bulgarelli, Lucas, Pollard, Tom, Horng, Steven, Celi, Leo Anthony, and Roger Mark. "MIMIC-IV" (version 2.2). *PhysioNet* (2023). <https://doi.org/10.13026/6mm1-ek67>
- This study was supported by the National Research Foundation of Korea Grant and the Korea Health Technology R&D Project through the Korea Health Industry Development Institute (KHIDI), funded by Korean Government (HI21C1074)

Topic: Data Science

000536

Clinical characteristics of acute ischemic stroke patients: a report from the acute stroke database

J. H. Lee¹, W. J. Kim², J. H. Park³, S. H. Hwang⁴

¹Neurology, NHIS Ilsan Hospital, Goyang-si, Republic of Korea; ²Neurology, Gangnam Severance Hospital, Seoul, Republic of Korea; ³Neurology, Inje University Sanggye Paik Hospital, Seoul, Republic of Korea; ⁴Neurology, Hallym University Kangnam Sacred Heart Hospital, Seoul, Republic of Korea

Correspondence: J. H. Lee

Intensive Care Medicine Experimental 2023, **11(Suppl 1)**:000536

Introduction: The aim of this study was to establish clinical characteristics of patients after acute ischemic stroke (AIS).

Objectives: Our acute ischemic stroke database consist of cause, subtype, treatment, etc. We investigate clinical characteristics of these patients.

Methods: In total, 972 consecutive patients with AIS were included from 2017 to 2022. We analyzed database after acute ischemic stroke from the database and medical records including neurosonology lab.

Results: Among the risk factors, hypertension was observed in 684 patients (70.4%), diabetes mellitus in 326 patients (33.5%), hyperlipidemia in 284 patients (29.2%), previous stroke history in 170 patients (17.5%), coronary heart disease in 72 patients (7.4%), atrial fibrillation in 169 patients (17.4%) and a history of smoking in 378 patients (38.9%). Regarding the types of stroke, ischemic stroke was observed in 886 patients (91.1%), AIS with hemorrhagic transformation was seen in 18 patients (1.9%) and transient ischemic attack in 68 patients (7.0%). By TOAST classification with neurosonology lab., large artery atherosclerosis was observed in 339 patients (34.9%), small vessel occlusion in 235 patients (24.2%), cardioembolism in 181 patients (18.6%), other determined causes in 25 patients (2.6%) and undetermined causes in 192 patients (19.7%). Mildly severe strokes were observed in 694 patients (71.4%), moderately severe strokes, in 174 patients (17.9%), and severe strokes in 104 patients (10.7%). Recanalization treatment was performed in 135 patients (13.9%), IV thrombolysis in 67.5%, endovascular treatment in 16%, and combined IV thrombolysis and endovascular treatment in 16.5%.

Conclusions: Our findings suggest that stroke mechanisms were similar to those reported by previous studies; however, the mechanism of large artery atherosclerosis seems more prevalent than in other studies. Only 13.9% patients underwent recanalization treatment, so a better system for treating patients with acute stroke seems necessary.

Topic: Neurointensive care

000538

Clinical outcomes and predictors of long-term survival of patients with home mechanical ventilation after critical illnessS. J. Kwon¹, M. Lee¹, D. Kang¹, I. B. Jeong¹, J. W. Son¹¹Respiratory and Critical Care Medicine, Konyang University Hospital, Daejeon, Republic of Korea**Correspondence:** S. J. Kwon*Intensive Care Medicine Experimental 2023, 11(Suppl 1):000538*

Introduction: Due to the improvement of intensive care unit (ICU) care, the number of patients with difficulty to wean and requiring home mechanical ventilation (HMV) after critical illness is increasing in Korea, but the predictors of patients requiring palliative care due to the high risk of death and clinical manifestations are not well known.

Objectives: The clinical characteristics and the predictors of the long-term survival of patients requiring HMV were analyzed.

Methods: From January 1, 2017 to September 31, 2022, a retrospective analysis was performed on patients who were admitted to the ICU and who were difficult to wean and consecutively applied HMV after tracheostomy in Konyang university hospital, Daejeon, Korea. At least 6 months after application of HMV were followed up, and predictors of 90-day survivors were analyzed by comparing clinical characteristics, laboratory findings, and HMV application status.

Results: During the study period, 89 of 95 HMV patients were analyzed, and 31 patients (34.8%) survived to 90 days and 22 patients (24.7%) survived to 180 days. 90-day survivors had low Charlson comorbidity index ($p=0.024$), ICU admission due to respiratory and cardiovascular cause and sepsis ($p=0.032$), low CRP level on HMV ($p=0.001$) comparing 90-day non-survivors (Tables 1, 2). There were no significant differences between the two groups in APACHE II score, body mass index, vasopressor use, pro-BNP level at ICU admission, serum albumin, creatinine, hemoglobin, lymphopenia, cause and tidal volume/predicted body weight of kg and mode of HMV on applying HMV (Tables 1, 2). In univariate analysis, 90-day survival was associated with young age, low Charlson comorbidity index, respiratory and cardiovascular cause and sepsis at ICU admission, and low CRP level on HMV, and in multivariate analysis, it was associated with low CRP level (Table 3).

Conclusions: In conclusions, 34.8% of patients survived more than 90 days and was associated with young age, low Charlson comorbidity index, respiratory and cardiovascular cause and sepsis at ICU admission, and low CRP level on HMV.

Table 1 (abstract 000538) Baseline characteristics of patient using HMV* at ICU admission

Baseline characteristics	Total (n=89)	90 days survivor (n=31)	90 days Non-survivor(n=58)	P-value
Sex, male (%)	48 (53.9)	14 (45.2)	34 (59.3)	0.225
Age (years)	68.7 ± 16.3	65.0 ± 14.2	70.6 ± 17.1	0.122
Charlson comorbidity index	8.92 ± 2.23	8.19 ± 2.30	4.91 ± 2.11	0.024
APACHE II score at ICU admission	19.9 ± 6.6	19.9 ± 7.8	20.5 ± 5.9	0.296
BMI (kg/m ²)	21.62 ± 3.99	22.19 ± 3.61	21.32 ± 4.18	0.327
Cause of ICU admission				0.032*
Respiratory, no. (%)	28 (31.5)	14 (45.2)	14 (24.1)	
Cardiovascular, no. (%)	3 (3.4)	1 (3.2)	2 (3.4)	
Sepsis, no. (%)	7 (7.9)	3 (9.7)	4 (6.9)	
Neurologic, no. (%)	27 (30.3)	7 (22.6)	20 (34.5)	
Others, no. (%)	24 (27.0)	6 (19.4)	18 (31.0)	
Cause of mechanical ventilation				0.09†
Acute respiratory failure, no. (%)	37 (41.6)	17 (54.8)	20 (34.5)	
Shock, n (%)	1 (1.1)	0 (0.0)	1 (1.7)	
Cardiac arrest, no. (%)	25 (28.1)	7 (22.6)	18 (31.0)	
Neuromuscular disease, no. (%)	26 (29.2)	7 (22.6)	19 (32.8)	
Vasopressors use at ICU admission, no. (%)	42 (47.2)	16 (51.6)	26 (44.8)	0.541
Pro-BNP (pg/mL) at ICU admission median (IQR)	918.9 (194.1-4018.0)	653.3(158.3-3952.0)	1748.5(200.3-4553.5)	0.535

* mean ±SD, median (IQR); HMV: home mechanical ventilation; ICU: in intensive care unit
† respiratory and cardiovascular cause, sepsis versus neurologic disease, other cause
‡ acute respiratory failure and shock versus cardiac arrest and neuromuscular disease

Topic: Acute respiratory failure and mechanical ventilation

000539

Association of systemic causes of secondary brain injury with outcome of critically ill patients with sepsis-associated encephalopathy—an analysis of the OUTCOME-REA databaseM. Thy¹, R. Sonnevill¹, S. Ruckly², B. Mourvillier³, C. Schwebel⁴, Y. Cohen⁵, M. Garrouste-Orgeas⁶, S. Siami⁷, C. Bruel⁸, J. Reignier⁹, E. Azoulay¹⁰, L.Argaud¹¹, D. Goldgran-Toledano¹², V. Laurent¹³, C. Dupuis¹⁴, J. Poujade¹, L. Bouadma¹⁵, E. de Montmolin¹⁶, J. F. Timsit¹⁶, The Outcomerea Network¹⁷

¹Medical and Infectious Diseases ICU - Hospital Bichat - Université Paris Cité, Assistance Publique – Hôpitaux de Paris, Paris, France; ²Umr 1137, INSERM, Paris, France; ³Médecine intensive et réanimation polyvalente, CHU Reims - Champagne Clinic, Reims, France; ⁴Médecine intensive réanimation, C.H.U de Grenoble, La Tronche, France; ⁵Respiratory Department, normadie univ, Avicenne Hospital (AP-HP), Bobigny, France; ⁶Service de médecine intensive et de réanimation, Hôpital Franco-Britannique – Fondation Cognacq-Jay, Levallois-Perret, France; ⁷Réanimation, Hospital Center Sud Essonne-, Étampes, France; ⁸Medical and Surgical Intensive Care Unit, Hospital Paris Saint-Joseph, Paris, France; ⁹Médecine Intensive réanimation, Nantes University Hospital Hotel-Dieu, Nantes, France; ¹⁰Réanimation médicale, Hôpital Saint-Louis, Paris, France; ¹¹Service de médecine intensive-réanimation, Hôpital Édouard Herriot, Lyon, France; ¹²Médecine Intensive et réanimation, Intercommunal Hospital Group Le Raincy Montfermeil, Montfermeil, France; ¹³Réanimation, C.H. de Versailles, Le Chesnay, France; ¹⁴Médecine Intensive - réanimation, CHU Gabriel-Montpied, Clermont-Ferrand, France; ¹⁵Paris, Medical and Infectious Intensive Care Unit, Bichat-Claude Bernard Hospital, Paris, France; ¹⁶Intensive Care Medicine Department, Assistance Hopitaux Publique de Paris, Paris, France; ¹⁷Intensive Care Medicine Department, Assistance Publique Hopitaux De Paris, Paris, France

Correspondence: M. Thy*Intensive Care Medicine Experimental 2023, 11(Suppl 1):000539*

Introduction: Sepsis-associated encephalopathy (SAE), which is independently associated with increased mortality, may be worsened by systemic causes of secondary brain injury (SSBI), that are frequently observed in ICU patients.

Objectives: We aimed to investigate the association between the presence of at least one SSBI within the first 48 h of intensive care unit (ICU) admission with outcomes of SAE patients.

Methods: We performed a retrospective analysis using data from the French OUTCOMEREA multicenter prospective database. We included consecutive patients without primary brain injury with SAE [defined by a score on the Glasgow coma scale ≤ 13 and severe sepsis or septic shock (SEPSIS 2.0 definition) criteria] requiring invasive mechanical ventilation at ICU admission. For each patient, we analyzed SSBI events (abnormal glycemia (<3 mmol/L or ≥ 11 mmol/L), hypotension (DBP ≤ 50 mmHg), temperature abnormalities (<36 °C or ≥ 38.3 °C), anemia (hematocrit $<21\%$), dysnatremia (<135 mmol/L or ≥ 145 mmol/L), oxygenation abnormalities, dyscapnia (<35 mmHg or ≥ 45 mmHg) present within the first 48 h of ICU admission and the impact of their control at day-3 on day-28 mortality and neurological recovery.

Results: Of the 4799 septic patients, 995 patients with SAE were included. Compared to decedents at day-28, alive patients had significantly less SSBI within the first 48 h of ICU admission, including less hypoglycemia (<3 mmol/L), less hypotension (DAP <50 mmHg), less hypothermia (<36 °C) and anemia (hematocrit $<21\%$) within the first 48 h of ICU admission. After adjusting for diagnostic, comorbidities and SOFA score, the control of the following SSBI at day-3 was significantly associated with lower day-28 mortality for blood pressure (diastolic pressure >50 mmHg: aHR = 1.77 [1.34–2.34], oxygenation (PaO₂ between 60 and 200 mmHg: aHR = 1.78 [1.2–2.63], $p=0.02$), glycemia (glycemia between 3 and 11 mmol/L: aHR = 1.41 [1.1–1.8], $p=0.01$), temperature (36 °C–38.3 °C: aHR = 1.46 [1.12–1.91], $p=0.007$). Control of the SSBI at day-3 was significantly associated with a better day-28 neurological recovery.

Conclusions: The control of several SSBI (particularly oxygenation, arterial pressure, glycemia, temperature) within the 3 first days of ICU admission is associated with lower mortality and better neurological recovery in SAE patients.

Table (abstract 000539) Multivariate analyzes of the controle of SSBI at day-3 on mortality and neurological recovery at day-28

Variable	Outcomes					
	Day-28 Mortality			Day-28 Neurological Recovery		
SSBI at D3	aHR	[95% CI]	p	aOR	[95% CI]	p
Blood pressure (DBP>50mmHg)			<.001			<.001
Normal within the 48 first hours	1			1		
Controlled at Day-3	0.76	[0.55-1.04]		1.56	[1.08-2.25]	
Not controlled at Day-3	1.77	[1.34-2.34]		0.62	[0.43-0.89]	
Oxygenation (60<N<200mmHg)			0.02			0.04
Normal within the 48 first hours	1			1		
Controlled at Day-3	1.03	[0.82-1.29]		1.23	[0.92-1.65]	
Not controlled at Day-3	1.78	[1.2-2.63]		0.51	[0.25-1.01]	
Temperature (36°C<N<38.3°C)			0.007			0.01
Normal within the 48 first hours	1			1		
Controlled at Day-3	1.11	[0.84-1.47]		0.95	[0.68-1.33]	
Not controlled at Day-3	1.46	[1.12-1.91]		0.64	[0.45-0.9]	
Glycemia (3<N<11mmol/L)			0.01			0.05
Normal within the 48 first hours	1			1		
Controlled at Day-3	1.03	[0.73-1.23]		1.01	[0.72-1.4]	
Not controlled at Day-3	1.41	[1.1-1.8]		0.64	[0.44-0.92]	
Anemia (Hematocrit<21%)			0.16			0.18
Not present within the 48 first hours	1			1		
Not present at Day-3	1.27	[0.97-1.66]		0.76	[0.51-1.14]	
Present at Day-3	1.24	[0.79-1.96]		0.35	[0.15-0.77]	
Natremia (135<N<145mmol/L)			0.66			0.97
Normal within the 48 first hours	1			1		
Controlled at Day-3	0.99	[0.78-1.46]		0.98	[0.72-1.33]	
Not controlled at Day-3	1.11	[0.86-1.41]		1.02	[0.74-1.42]	
Capnia (35<N<45mmHg)			0.36			0.55
Normal within the 48 first hours	1			1		
Controlled at Day-3	0.82	[0.63-1.08]		1.22	[0.85-1.77]	
Not controlled at Day-3	0.88	[0.69-1.12]		1.09	[0.78-1.52]	

SSBI: Systemic causes of secondary brain injury, aHR: adjusted hazard ratio

Each line represents a separate adjusted analysis, evaluating the association of different SSBI with outcomes (Day-28 mortality, Day-28 Neurological recovery)

The outcomes at Day-3 concerned the patients with an initial anormal SSBI within the first 48h of ICU admission

*aHRs are calculated with univariate Cox models censored at Day-28 after adjustment to the SOFA score without neurological component at ICU admission, the type of admission (medical versus other) and the existence of hepatic comorbidities

*aORs are calculated with logistic regression model after adjustment to the SOFA score without neurological component at ICU admission, the type of admission (medical versus other) and the existence of hepatic comorbidities. Day-28 Neurological Recovery defined as Glasgow score (GCS) > 13 at Day-28

If the patient was discharged survivors before Day-28, the value of the GCS on the day of discharge is used

If patient died on Day-28, non-recovery of the GCS on Day-28 is considered

Topic: Sepsis

000540

Acute ischemic stroke in the patients with inflammatory arthritis

J. H. Lee¹, W. J. Kim², J. H. Park³, S. H. Hwang⁴

¹Neurology, NHIS Ilsan Hospital, Goyang-si, Republic of Korea; ²Neurology, Gangnam Severance Hospital, Seoul, Republic of Korea; ³Neurology, Inje University Sanggye Paik Hospital, Seoul, Republic of Korea; ⁴Neurology, Hallym University Kangnam Sacred Heart Hospital, Seoul, Republic of Korea

Correspondence: J. H. Lee

Intensive Care Medicine Experimental 2023, **11(Suppl 1)**:000540

Introduction: Inflammation is an important mechanism of stroke. Inflammatory cells and cytokines largely contribute the pathophysiology of inflammatory arthritis.

Objectives: We evaluated the risk of stroke and compared the medical expenses between the patients of inflammatory arthritis and matched population, using data from National Health Insurance Service.

Methods: We defined the patients of ankylosing spondylitis, seropositive rheumatoid arthritis, and psoriatic arthritis and enteropathic spondyloarthropathy, using the combination of main diagnosis and V code of rare incurable diseases. Control group was defined by 1:5 propensity

matching in each disease. Newly developed stroke was defined as the patients with the main diagnosis of (I60–I64) and (1) brain imaging, or (2) prescription of stroke medication or related intervention.

Results: Seropositive rheumatoid arthritis was associated with more frequent stroke occurrence in the population of patient and control group of seropositive rheumatoid arthritis (Hazard ratio 1.11, 95% CI 1.02–1.20, p value = 0.012). Medical expenses in outpatient clinic, which is not related to stroke, was larger in all inflammatory arthritis with stroke. In-patient medical expenses related to stroke in seropositive rheumatoid arthritis patients, was larger than the control group, though statistically insignificant.

Conclusions: Seropositive rheumatoid arthritis was a predictor of the more frequent stroke occurrence. To decrease the comorbid stroke and following burden of social cost, the careful concern is needed for the early diagnosis and active management of inflammatory arthritis, especially seropositive rheumatoid arthritis. The underlying correlation between the inflammatory arthritis and the stroke needs further studies.

Topic: Neurointensive care

000541

The relationship between recruitment to inflation ratio assessed by single-breath technique and electrical impedance tomography in moderate to severe non-covid ARDS

K. Gulapa¹, Y. Sutherasan¹, P. Theerawit²

¹Department of Medicine, Division of Pulmonary Medicine and Pulmonary Critical Care Medicine, Faculty of Medicine Ramathibodi Hospital, Mahidol University, Bangkok, Thailand; ²Department of Medicine, Division of Critical Care Medicine, Faculty of Medicine Ramathibodi Hospital, Mahidol University, Bangkok, Thailand

Correspondence: K. Gulapa

Intensive Care Medicine Experimental 2023, **11(Suppl 1)**:000541

Introduction: Recently, the recruitment-to-inflation ratio (R/I ratio) from the single-breath (R/ISB) technique has been proposed for identifying lung recruitability in ARDS. This technique is modified from the end-expiratory lung volume (EELV) measurement principle of different positive end-expiratory pressure levels. Also, electrical impedance tomography (EIT) can estimate the delta EELV, providing the potential role of EIT in measuring the R/I ratio. However, a study comparing those techniques has not been conducted.

Objectives: We aimed to analyze the relationship between the R/ISB from exhaled tidal volume measurement and the R/I ratio from EIT-derived (R/IEIT) parameters. In addition, we analyzed the predictive performance of the R/I ratio regarding lung recruitability by the EIT technique.

Methods: The single-center prospective physiological study was conducted on moderate to severe ARDS. The R/ISB was initially performed. Simultaneously, the EIT data were recorded and followed by the recruitment maneuver (RM). Then, variables used to analyze the relationship were recruited volume (Vrec) by single-breath technique and EIT as well as R/I ratio by both methods. Regarding lung recruitability by EIT, we analyzed the average percentage change of gas distribution of dependent regions of interest (ROI) 3 and 4 during RM (difference of end of RM and before RM). We use the median value of the average percentage change in the ROI 3 and 4 for discriminating potential recruiters and non-recruiters.

Results: Twenty-one patients were enrolled. Eight patients (38%) were severe ARDS. The Vrec by EIT strongly correlated to the Vrec by single-breath technique ($R=0.680$, $P=0.001$). Similarly, a strong correlation was found between the R/ISB and the R/IEIT ($R=0.653$, $P=0.001$). Nevertheless, the Bland–Altman plot between Vrec by both techniques showed a mean difference of -46.09 ml (with 1.96 SD of -249.07 ml to 156.89 ml). The percentage of EIT-tidal impedance change at the dependent area during RM did not correlate with both

the R/ISB ($R=0.080$, $P=0.732$) and the R/IEIT ($R=0.191$, $P=0.407$). The median value in the average percentage change in the ROI 3 and 4 was 11.5% which was determined as the threshold value for discriminating potential recruiters and non-recruiters.

The area under the ROC curve was analyzed to determine the predictive performance of the R/I ratio from both methods. The R/IEIT showed the AUC of ROC of 0.818 ($P=0.014$), while the R/ISB showed 0.545 ($P=0.725$). The threshold value of R/IEIT to discriminate potential recruitability was 0.89, providing sensitivity and specificity of 81.8% and 90%, respectively.

Conclusions: The R/IEIT was strongly correlated with the R/ISB. The R/IEIT showed better predictive performance regarding lung recruitability than R/ISB.

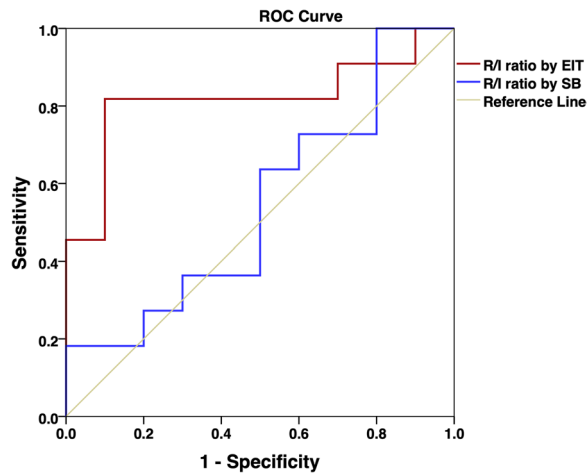

The ROC analysis of the R/I ratio by EIT and the R/I ratio by single-breath method to predict lung recruitability.

References

- Chen L, Del Sorbo L, Grieco DL, Junhasavasdikul D, Rittayamai N, Soliman I, et al. Potential for Lung Recruitment Estimated by the Recruitment-to-Inflation Ratio in Acute Respiratory Distress Syndrome. A Clinical Trial. *Am J Respir Crit Care Med* 2020;201:178-87.

Topic: Acute respiratory failure and mechanical ventilation

000542

Pro-apoptotic Bax/Bak, Smac and caspases interactions with the anti-apoptotic survivin and X-linked Inhibitor of Apoptosis Protein (XIAP) in sepsis

M. Miliaraki¹, P. Briassoulis², A. Polonifi³, K. Bastaki⁴, M. Mantzourani³, S. Ili¹, G. Briassoulis⁵

¹Pediatric Intensive Care Unit, Medical School, University of Crete, Goufira, Greece; ²Anesthesiology Department, National and Kapodistrian University of Athens, Athens, Greece; ³First Department of Internal Medicine, Laiko Hospital, National and Kapodistrian University of Athens, Athens, Greece; ⁴Pediatric Intensive Care Unit, University Hospital, Medical School, University of Crete, Heraklion, Greece; ⁵School of Medicine, University of Crete, Heraklion, Greece

Correspondence: M. Miliaraki

Intensive Care Medicine Experimental 2023, **11(Suppl 1)**:000542

Introduction: Apoptosis has recently been identified as an important mechanism of septic cell death. Efficient apoptosis requires the upregulation of key pro-apoptotic regulators, such as initiator or executioner caspases, Bax/Bak protein, and Smac (second mitochondria-derived

activator of caspases). The pro-apoptotic regulators lead to outer membrane permeabilization and inhibit the antiapoptotic action of the survivin protein and the X-linked inhibitor of apoptosis protein (XIAP) on executioner caspases (1). The apoptotic and antiapoptotic interactions seem to orchestrate the septic processes and their fragile balance defines cell survival.

Objectives: The purpose of the study is to evaluate whether the induction of certain apoptotic (executioner caspase-3, initiator of the extrinsic pathway caspase-8, or of the intrinsic pathway caspase-9, Bax/Bak, and Smac) or antiapoptotic proteins (survivin, XIAP) might be related to mortality in sepsis.

Methods: The study sample of this prospective single-center study consists of adult and pediatric ICU patients with sepsis (S), compared to non-infectious inflammation (I) and healthy controls (H). Consecutive serum samples were collected on the 1st day of ICU admission. The expression of serum apoptotic and antiapoptotic biomolecules was determined through enzyme-linked immunosorbent assay (ELISA).

Results: Out of 82 patients enrolled in the study, 26 were adults (9 S, 9 I, and 8 H) and 56 children (31 S, 18 I, and 7 H). Caspase-8 was correlated with Bax/Bak ($r_s=0.257$, $p=0.03$), while XIAP was positively correlated with Smac ($r_s=0.463$, $p=0.001$) and ne caspase-9 ($r_s=-0.525$, $p=0.021$). In adult sepsis, caspase-3 ($p=0.005$) and survivin ($p<0.001$) were increased and Bax/Bak decreased ($p=0.02$) compared to controls; caspase-9 was increased in pediatric sepsis ($p=0.017$). Among septic non-survivors, increasing trends were demonstrated for caspases 9 and 3, Smac, XIAP, and survivin and decreasing for caspase-8 and Bax/Bak (adults only, $p<0.001$). In all ICU groups (S and I), Smac and XIAP were induced and Bax/Bak repressed among non-survivors, compared to survivors (Fig. 1).

Conclusions: Our results show that the orchestration of certain apoptotic and anti-apoptotic mediators might be linked to sepsis and to unfavorable outcome in ICU.

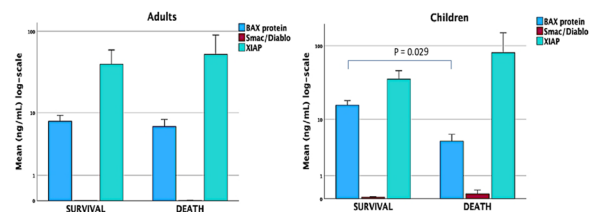

Figure 1 (abstract 000542) Increasing trends for Smac/Diablo and XIAP and decreasing for Bax/Bak serum levels among non-survivors in adult and paediatric ICU patients

References

- Anne Hamacher-Brady and Nathan Ryan Brady. Bax/Bak-dependent, Drp1-independent Targeting of X-linked Inhibitor of Apoptosis Protein (XIAP) into Inner Mitochondrial Compartments Counteracts Smac/DIABLO-dependent Effector Caspase Activation. *J Biol Chem*. 2015 Sep 4; 290(36): 22005–22018.

Topic: Sepsis

000545

The role of lung injury in brain tissue oxygenation after subarachnoid hemorrhage

L. Putnina¹, V. Rass², A. Lindner², M. Kofler¹, P. Kindl², A. J. Schiefecker², B. Pfausler², R. Beer², R. Helbok³

¹The Department of Anaesthesiology and Critical Care Medicine, Medical University of Innsbruck, Innsbruck, Austria; ²Department of Neurology, Medical University of Innsbruck, Innsbruck, Austria; ³Department of Neurology, Kepler University Hospital, Campus Neuromed, Linz, Austria

Correspondence: L. Putnina

Intensive Care Medicine Experimental 2023, **11(Suppl 1)**:000545

Introduction: Mechanical ventilation (MV) is commonly needed in poor-grade subarachnoid hemorrhage (SAH) patients. Especially these patients commonly suffer from a lung injury, which may affect oxygen delivery to the brain.

Objectives: In this study, we aimed to investigate the association between lung injury and brain tissue hypoxia after SAH.

Methods: In this observational study, 72 consecutive SAH patients on MV with brain tissue oxygen tension (PbtO₂) monitoring (Fig 1) admitted between 2011 and 2021 to the Neurocritical Care Unit (NICU) at Innsbruck Medical University Hospital were included. Various determinants as PbtO₂, cerebral perfusion pressure (CPP), PaO₂, pCO₂, and FiO₂ were collected whenever available. Lung injury was defined based on the degree of hypoxemia using Horowitz Index (PaO₂/FiO₂ Ratio, mmHg): mild (>200–300 mmHg), moderate (>100–200 mmHg), and severe (≤100 mmHg) [1]. Generalized estimating equations were used to analyze the longitudinal data.

Results: Patients had a median Glasgow Coma Scale of 3 [IQR 3–9] and were 59 years old [IQR 47–67]. A total of 6966 data points were analyzed. The median PaO₂ was within the normal range 94 mmHg [IQR 84–104] and normocapnia was observed with a median pCO₂ of 40 mmHg [IQR 37–43]. The median Horowitz index during the hospital course was 231 mmHg [IQR 183–293] and brain tissue oxygen tension (PbtO₂) was 27 mmHg [IQR 20–33]. Mild lung injury was observed in 43.9%, moderate in 32.3%, and severe in 0.9% of measurements. The decrease in Horowitz index was observed between 3 and 10 days after bleeding, with the lowest HI 214 mmHg [IQR 88–588] on day 7 (Fig 2). There was no independent association between PaO₂/FiO₂ ratio and PbtO₂ (p=0.074). Determinants for improved PbtO₂ were pO₂, pCO₂, inspired FiO₂, and cerebral perfusion pressure even adjusting for confounding factors of age and the Hunt & Hess scale.

Conclusions: Lung injury is common in patients with subarachnoid hemorrhage. Our results confirm the hypothesis that employing ventilator strategies and optimizing cerebral perfusion pressure is needed to prevent cerebral hypoxia independent of the degree of lung injury.

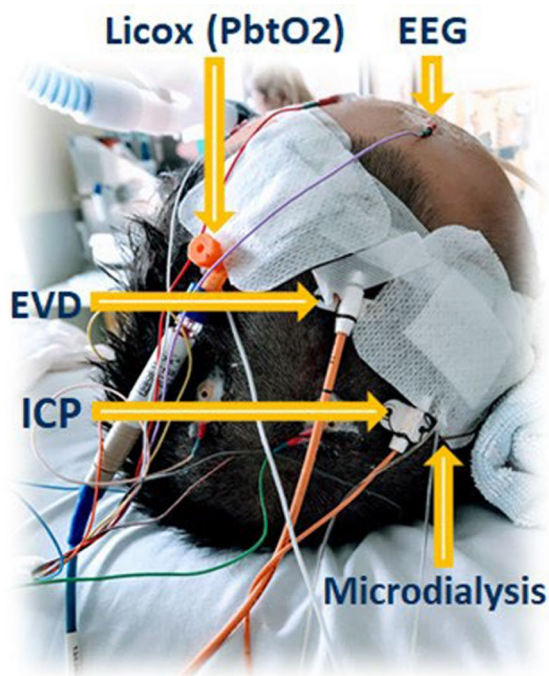

Figure 1 (abstract 000545) Multimodal neuromonitoring in subarachnoid hemorrhage patient

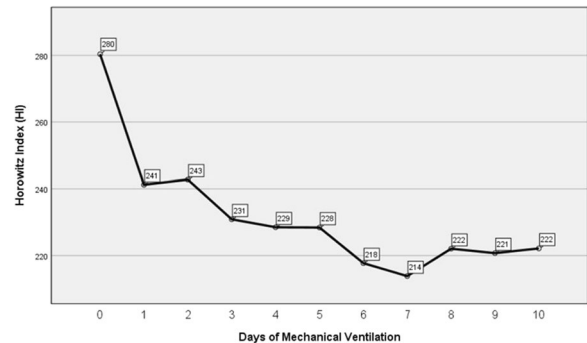

Figure 2 (abstract 000545) Lung function (median PaO₂/FiO₂ ratio, mmHg) in subarachnoid hemorrhage patients during hospitalization

References

- ARDS Definition Task Force; Ranieri VM, Rubenfeld GD, Thompson BT, Ferguson ND, Caldwell E, Fan E, Camporota L, Slutsky AS. Acute respiratory distress syndrome: the Berlin Definition. JAMA. 2012 Jun 20;307(23):2526-33. <https://doi.org/10.1001/jama.2012.5669>. PMID: 22797452.

Topic: Neurointensive care

000550

Effects of hypercapnia on alveolar epithelial cells and macrophages infected with pneumonia-causing bacteria

E. Campaña-Duel¹, L. Morales-Quinteros², A. Ceccato³, A. Areny-Balagueró⁴, P. Conde⁵, L. Blanch⁶, L. Fernandez-Barat⁷, A. Artigas⁸, M. Camprubi⁴

¹Respiratory Pathophysiology, Institut d'Investigació i Innovació Parc Taulí (I3PT), Sabadell, Spain; ²Intensive Care, Hospital Universitari Sagrat Cor - Grup Quirónsalut, Barcelona, Spain; ³Institut d'investigació i innovació parc taulí (i3pt)/ciberes, Universitat Autònoma de Barcelona, Cerdanyola del Vallès, Spain; ⁴Institut d'investigació i innovació parc taulí (i3pt), Universitat Autònoma de Barcelona, Cerdanyola del Vallès, Spain; ⁵Fundació clínic, Institut d'Investigacions Biomèdiques August Pi i Sunyer (IDIBAPS), Barcelona, Spain; ⁶Institut d'investigació i innovació parc taulí i3pt, Parc Taulí Hospital Universitari, Sabadell, Spain; ⁷Pneumology, Hospital Clínic de Barcelona, Barcelona, Spain; ⁸Department of Intensive Care Medicine, Corporación Sanitaria Universitaria Parc Taulí, Barcelona, Spain

Correspondence: E. Campaña-Duel

Intensive Care Medicine Experimental 2023, 11(Suppl 1):000550

Introduction: *Streptococcus pneumoniae* (SPNE) and *Pseudomonas aeruginosa* (PA) are frequent causes of pneumonia. Patients with advanced lung disease commonly develop hypercapnia.

Objectives: This project aims to evaluate the bacterial survival and biological response of the co-culture of alveolar epithelial cells (HPAEpiC) and macrophages as a result of infection with different types of bacteria (PA and SPNE) under different CO₂ concentrations.

Methods: Co-cultures of HPAEpiC cells and THP-1 cells differentiated to macrophages were separately infected with PA or SPNE for 1 h at 37 °C under normocapnic (5% CO₂) or hypercapnic (15% CO₂) conditions. Extracellular and intracellular bacterial survival was then assessed after infection.

24 h after infection, at 5% or 15% CO₂, intracellular and extracellular proteins were analyzed by ELISA for inflammatory mediators (IL-1β, IL-8, CCL-2). Cell binding ZO-1 protein was measured 1 and 24 h after infection. Apoptosis was also assessed by cytometry and TUNEL assay.

Results: Infection with PA or SPNE in a culture of HPAEpiC and THP-1 cells under hypercapnia increases inflammation and decreases phagocyte chemotaxis (Figure 1A, B). Hypercapnia would potentiate ZO-1

production in the co-culture after infection but not 24 h later, showing SPNE infection the poorest regeneration levels (Figure 1C). In addition, PA-infected THP-1 cells show decreased apoptosis under hypercapnia compared to normocapnia conditions (Figure D, E).

The inflammatory response against PA eliminates most of the extracellular bacterial load, but hypercapnia allows PA to multiply intracellularly (Figure 1F, H). On the other hand, cell cultures achieve to eliminate 50–60% of the initial SPN inoculum, which could establish intracellular niches under 5% and 15% CO₂ (Figure 1G, I).

Conclusions: The hypercapnic condition on bacterial-infection response could play a detrimental role in PA and SPNE infection.

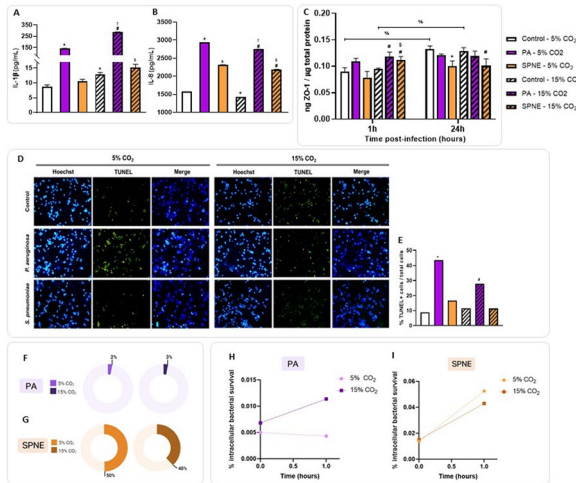

Figure 1 (abstract 000550) Biological response of HPAEpiC and THP-1 cells after infection at 5% and 15% of CO₂. (A, B) Protein concentration in cell culture supernatant of proinflammatory IL-1β (A) and chemoattractant IL-8 (B) mediators 24 hours post-infection with PA or SPNE of the HPAEpiC and THP-1 cells co-culture under 5% or 15% of CO₂. (C) ZO-1 protein concentration in total intracellular protein 1 and 24 hours post-infection with PA or SPNE of the HPAEpiC and THP-1 cells co-culture under 5% or 15% of CO₂. (D, E) Apoptosis was assessed in THP-1 cell cultures infected with PA or SPNE 24 hours post-infection. Analysis was done through fluorescence microscopy, TUNEL* cells were then quantified among total cells. (F, G) Extracellular bacterial survival of PA and SPNE immediately at the end of infection compared to the initial inoculum administered. (H, I) Intracellular bacterial survival of PA and SPNE in HPAEpiC and THP-1 cell co-culture immediately at the end of infection and 1 hour after compared to the initial inoculum administered. n = 4 in bacterial survival assays, n = 9–12 in protein analysis and n = 2 in TUNEL assay. Data represented as mean ± SEM. *p ≤ 0.05 vs control—5% CO₂. #p ≤ 0.05 vs control—15% CO₂. †p ≤ 0.05 vs PA—5% CO₂. ‡p ≤ 0.05 vs SPNE—5% CO₂. %p ≤ 0.05 vs same experimental group at 1 h. PA: *P. aeruginosa*. SPNE: *S. pneumoniae*. ZO-1: zonula occludens

References

- Institut d'Investigació i Innovació Parc Taulí (I3PT)
- Sociedad Española de Neumología y Cirugía Torácica (SEPAR)
- Burkhard Lachmann Research Award. ESICM
- Torres, A., Cilloniz, C., Niederman, M. S., Menéndez, R., Chalmers, J. D., Wunderink, R. G., & van der Poll, T. (2021). Pneumonia. *Nature Reviews. Disease Primers*, 7(1), 25. <https://doi.org/10.1038/s41572-021-00259-0>
- Morales-Quinteros, L., Camprubi-Rimblas, M., Bringué, J., Bos, L. D., Schultz, M. J., & Artigas, A. (2019). The role of hypercapnia in acute respiratory failure. *Intensive Care Medicine Experimental*, 7(Suppl 1), 39. <https://doi.org/10.1186/s40635-019-0239-0>

Topic: Infections and prevention

000551

SEA-MAKE score a predictor for mortality in patients admitted in Intensive Care Unit

N. Cango¹, G. Castañeda¹, C. Alvarez¹, A. Blanco¹, P. García Olivares¹, J. Cedeño Mora¹

¹Intensive Care Unit, H.G.U Gregorio Marañón, Madrid, Spain

Correspondence: N. Cango

Intensive Care Medicine Experimental 2023, **11(Suppl 1)**:000551

Introduction: Critical patients have high global morbidity and mortality rates. Some studies have used SEA-MAKE score to predict major adverse kidney events, but there is few data about its validity as a predictor for mortality in ICU patients. This score can be used at point of care and may be a good predictive marker for mortality in critically ill patients.

Objectives: Main purpose of this study was to identify if SEA-MAKE score is a good predictor for mortality in patients admitted in intensive care unit (ICU).

Methods: This is a single-center, retrospective, observational study, that was conducted in ICU patients admitted at Gregorio Marañón hospital, between February–March 2023. Exclusion criteria were chronic kidney disease (CKD) and age < 18 years. SEA-MAKE score was calculated at admission in ICU, wich included following parameters: Glasgow coma scale (3 points), tachypnea (1 point), vasopressor use (1 point), invasive mechanical ventilation (IMV) (2 points), oliguria defined as output urinary < 0,5 ml/kg/h (2 points), serum creatinine rising > 3 times (5 points), Blood urea nitrogen (BUN) > 40 mg/dl (3 points), hematocrit < 30% (2 points) and trombocytopenia < 150 10E3/μL (1 point).

Additionally, the following data was collected: age, reason for admission, Charlson index, need for IMV, vasopressor requirements and outcome. Severity of illness at admission was established by Acute Physiology and Chronic Health disease Classification System II (APACHE II) score and Sepsis related Organ Failure Assessment (SOFA). Categorical data was presented as percentages. Continuous data was expressed as mean and standard deviation (SD), or median with interquartile range (IQR) for continuous variables. Capacity of SEA-MAKE score to predict ICU mortality was established using the area under the receiver operating characteristic curve (AUROC). Estimation of calibration was established through Hosmer–Lemeshow goodness of fit test. To evaluate extent to which SEA-MAKE score was valid for prediction ICU mortality, sensitivity (S), specificity (E), overall validity of prediction, positive and negative predictive values (PPV, NPV) were determined.

Results: Seventy patients were included. Mean age was 58 ± 17 years and 50% were male. Most common reason for admission was sepsis (37.1%). Median Charlson index 1 (IQR 0–2). 42.9% patients required IMV, with a median 4 days (IQR 1–7), and 55.7% patients needed vasopressors. Median SEA MAKE 3 (IQR 1–6). Mean admission severity score by APACHE II 14 ± 7 and SOFA 5 ± 4. Median ICU stay was 5 days (IQR 3–9) and 8.7% mortality.

In univariate analysis we found that SEA-MAKE score determined at ICU admission was significantly higher in no survivors (10 ± 6) than in survivors patients (4 ± 3) (p < 0.01).

According AUROC curves, SEA-MAKE score had an adequate capacity for discriminating (AUC 0.83, 95% CI: 0.65–1) and a good calibration ability (Chi-squared test 5.5 p = 0.590) to predict mortality in ICU patients. A cut-off of 5 was the best value for predicting mortality: sensitivity 83% and specificity 76%, with positive predictive value (PPV) 25% and negative predictive value (NPV) 98%. (Figure 1).

Conclusions: In our experience SEA-MAKE score applied at admission in ICU patients, may be a good predictor for mortality.

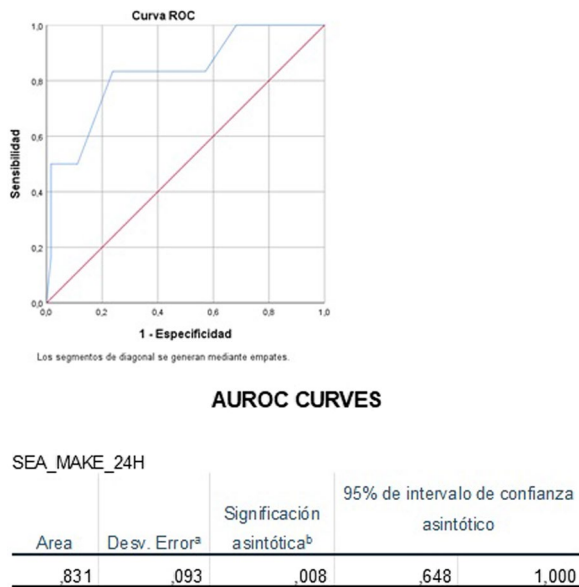

Figure 1 (abstract 000551) SEA-MAKE score a predictor for mortality

Topic: Critical care organisation, quality management, information systems, outcomes

000552

Renal Resistive Index as an independent prognostic factor for acute renal injury in critically ill patients

C. Alvarez¹, N. Cango¹, G. Castañeda¹, A. Blanco¹, P. García Olivares¹, J. Cedeño Mora¹

¹Intensive Care Unit, H.G.U Gregorio Marañón, Madrid, Spain

Correspondence: N. Cango

Intensive Care Medicine Experimental 2023, 11(Suppl 1):000552

Introduction: Acute kidney injury (AKI) is a common complication in the Intensive Care Unit (ICU). According to studies, AKI affects 30–60% of critically ill patients. Renal Resistive Index (RRI) has shown promise in early detection of AKI in ICU patients.

Objectives: The aim of this study was to identify if RRI, measured within 24 h from admission, is a independent prognostic factor for AKI in critically ill patients.

Methods: This is an observational, prospective study performed in ICU patients admitted at Gregorio Marañón Hospital (Madrid, Spain), between February–March 2023. Exclusion criteria were chronic kidney disease (CKD), age < 18 years and bad echographic window. RRI was obtained within 24 h of admission in ICU, this was measured by one of four operators who had at least one year’s clinical experience in RRI method. Both kidneys were examined, measurements were made at two sites on each kidney in an interlobular or arcuate artery. From the pole RRI values, a mean RRI was computed.

The following data was collected for each patient at the time of RRI measurement and after 72h of admission: age, reason for admission, cardiovascular risk factors, need for invasive mechanical ventilation (IMV), vasopressor requirements, use of nephrotoxic drugs. Severity of illness was graded by means of APACHE II score. Urea, creatinine and BUN values, also glomerular filtration rate was calculated using EPI-CKD equation. For AKI diagnosis and classification, we used KDIGO criteria.

Descriptive statistics were expressed as mean ± SD, or median with interquartile range for continuous variables and percentages for categorical data. In univariate analysis, RRI means were compared by

Student T test. Association between IRR and AKI was estimated by multiple logistic regression analysis, adjusted by confusional factors.

Results: seventy patients were included. Mean age was 58 ± 17 years and 50% were male. 44.3% had arterial hypertension and 25.7% mellitus diabetes. Mean admission severity score APACHE II 14 ± 7 points. 42.9% patients required IMV and 55.7% vasopressors. 41.4% patients were diagnosed AKI within 24 h ICU stay. After 72 h of admission 27.1% had AKI: 47.3% KDIGO-1, 5.2% KDIGO-2, 47.3% KDIGO-3 and 10% required continuous renal replacement therapy (CRRT).

In univariate analysis we found that RRI values measured within 24h of admission were significantly lower in patients without AKI (0,69 ± 0,06) than in those with AKI (0,78 ± 0,07) (p < 0.01). There was no difference in RRI between patients classified as KDIGO 1 (0,76 ± 0,06) (p = 0.28) compared to KDIGO 2, but RRI was higher in those with KDIGO 3 (0,82 ± 0,08) (p < 0.01) and patients with CRRT (p < 0.01). We confirmed that RRI values were associated with a significant increased risk of AKI: OR 7.7; 95% CI 2.5–23.9.

In Multivariable logistic regression analysis, which included main risk factors that could influence to development for AKI at ICU admission: age, arterial hypertension, Mellitus diabetes, APACHE II, IMV, vasopressors and nephrotoxic drugs, RRI was independently associated with AKI: OR 1.2; 95% IC 1.1–1.4. (Table 1).

Conclusions: In our experience RRI measured within 24 h of admission was an independent prognostic factor for AKI in critically ill patients.

Table 1 (abstract 000552) RRI as independent prognostic factor for AKI

RRI as Independent prognostic factor for AKI

VARIABLES	OR	95% C.I.	
Age	1,017	,952	1,086
Hypertension arterial	,261	,042	1,618
Mellitus diabetes	2,426	,314	18,713
APACHE II	1,109	,935	1,316
IMV(1)	,478	,060	3,808
Vasopressors	,394	,041	3,782
Nephrotoxic drugs	6,040	,990	36,857
Sepsis reason for admission	1,918	,273	13,469
IRR x 100	1,234	1,067	1,427

1. Invasive Mechanical Ventilation

Topic: Acute Kidney Injury and haemofiltration

000553

Best setting of temperature for starting HFNC treatment: a pragmatic randomized controlled trial

A. Galazzi¹, F. Binda², S. Gambazza², A. Cislaghi³, C. Dossena², I. Adamini³, G. Grasselli⁴, D. Laquintana⁵

¹Department of Healthcare Professions, Fondazione IRCCS Ca’Granda Ospedale Maggiore Policlinico, Milano, Italy; ²Department of Healthcare Professions, Fondazione IRCCS Ca’Granda Ospedale Maggiore Policlinico, Milano, Italy; ³Intensive Care Unit, Fondazione IRCCS Ca’Granda Ospedale Maggiore Policlinico, Milano, Italy; ⁴Department of Pathophysiology And Transplantation, University of Milan, Milano, Italy; ⁵Department of Healthcare Professions, Fondazione IRCCS Ca’Granda Ospedale Maggiore Policlinico, Milano, Italy

Correspondence: A. Galazzi

Intensive Care Medicine Experimental 2023, 11(Suppl 1):000553

Introduction: Oxygen therapy with high-flow nasal cannulas (HFNC) is an increasingly used treatment (1). An important aspect of HFNC is the patient's comfort, which mostly depends on the set temperature and flow (2, 3), however the optimum initial humidification temperature setting has not been defined yet.

Objectives: To understand whether there is a difference in comfort among three approaches to target humidification temperature of 37 °C with HFNC in patients hospitalized in intensive care unit (ICU). The secondary aim is to assess the patient's dryness and perceived humidity of the nose.

Methods: This is a single-center pragmatic randomized trial (ClinicalTrials.gov Identifier: NCT05688189). Adult patients who need HFNC and able to express consent to study procedures were enrolled and randomly assigned to one of the following approaches: the 37 °C arm (A), in which patients started HFNC immediately at 37 °C; the 34–37 °C arm (B) with a starting temperature at 34 °C raised after 15 min at 37 °C; and the 31–34–37 °C arm (C) with temperature initially set at 31 °C, and then raised to 34 °C and 37 °C every 15 min. The HFNC treatment was delivered by AIRVO TM 2 (Fisher & Paykel Healthcare). After 30 min at 37 °C, patients were asked to indicate their comfort, dryness and humidity level, using a 1 to 5 visual numerical scale. Data are presented as median (I–III quartile).

Results: We enrolled 21 patients (15 males, 71.4%), aged 62.1 (53.4–76.5) years old; BMI was 25.7 (22.2–30.7); 19 (90.5%) presented with extra pulmonary respiratory failure after surgery, SOFA score was 2 (2–3). The FiO₂ varied from 30 to 65% and the flow from 35 to 60 l/min. The level of comfort was 3 (2–5), 4 (2–4) and 2 (1–5) in arms A, B and C, respectively (P=0.6925). Nasal dryness (P=0.0587) and humidity (P=0.5878) did not show evidence of statistical difference among arms either.

Conclusions: After 30 min of HFNC therapy at target temperature of 37 °C, overall comfort was alike among study arms, regardless of the initial temperature setting.

References

1. none
2. Ischaki E, Pantazopoulos I, Zakyntinos S. Nasal high flow therapy: a novel treatment rather than a more expensive oxygen device. *Eur Respir Rev.* 2017 Aug 9;26(145):170028. <https://doi.org/10.1183/16000617.0028-2017>.
3. Mauri T, Galazzi A, Binda F, Masciopinto L, Corcione N, Carlesso E, Lazzeri M, Spinelli E, Tubiolo D, Volta CA, Adamini I, Pesenti A, Grasselli G. Impact of flow and temperature on patient comfort during respiratory support by high-flow nasal cannula. *Crit Care.* 2018 May 9;22(1):120. <https://doi.org/10.1186/s13054-018-2039-4>.
4. Rittayamai N, Grieco DL, Brochard L. Noninvasive respiratory support in intensive care medicine. *Intensive Care Med.* 2022 Sep;48(9):1211–1214. <https://doi.org/10.1007/s00134-022-06762-6>. Erratum in: *Intensive Care Med.* 2022 Aug 2.

Topic: Nursing care and physiotherapy

000554

Presepsin, procalcitonin and interleukin-6 trend in a population of severely infected critically ill patients

A. Corona¹, T. Foletti², A. Stara¹, S. Simoncini¹, I. Gatti¹, M. Zangrandi³, C. Santorsola³, G. Bonetti⁴, G. Tomasini¹, G. Richini³, M. Pasqua³, M. Biasini³

¹Accident & Emergency and ICU, ASST Vallecasonica, Esine, Italy; ²Accident & Emergency and ICU, ASST Vallecasonica, Via Alessandro Manzoni, Esine, Province of Brescia, Italy, Esine, Italy; ³Department of Emergency and Casualty and ICU, ASST Vallecasonica, Esine, Province

of Brescia, Italy, Esine, Italy; ⁴Department of Clinical Services, ASST Vallecasonica, Esine, Italy

Correspondence: A. Corona

Intensive Care Medicine Experimental 2023, **11(Suppl 1)**:000554

Introduction: Sepsis is a condition characterized by high morbidity and mortality which is commonly encountered in an emergency and critical care setting. Despite a substantial body of research, the ideal biomarker for the diagnosis and prognostic stratification of septic patients remains unknown.

Objectives: To assess the trend of sepsis biomarkers (CRP, PCT, Interleukin-6, Presepsin).

Methods: Since August 2022 up to March 2023 we collected in patients developing severe infection (i) comorbidities, SAPS II and SOFA at the admission (ii) mechanical ventilation (MV) and vasoactive drugs duration, ICU and hospital outcome; (iii) type of infection, antibiotic therapy; (iv) daily CRP, PCT, IL-6 and Presepsin trend. Differences for both quantitative and categorical variables assessed respectively by ANOVA test and X2 tests. Linear Regression (LR) and Bland Altman (BAP) plots were used for comparison among biomarkers. A p<0.05 was considered for statistical significance.

Results: 50 patients (65% males) for 1150 biomarker determinations, were recruited with a median (IQR) (i) age 73 (64–82), 1st 24 h SAPS II of 55 (35–62) and SOFA score 8 (6–10), ICU LOS 7 (6–15), MV duration 6 (5–8) days. Recorded ICU mortality was 21.6%; 1150 biomarker values on onset sepsis day were for survived patients: CRP 142 (101–334) mg/ml, PCT 3.5 (2.5–8.1) (p=n.s.); IL-6 185 (100–470) (p=n.s.); Presepsin 2100 (950–3500) (p=n.s.), whereas in dead ones CRP 139 (101–334) mg/ml (p=n.s.), PCT 1.5 (1–4.1) ng/ml (p=n.s.); IL-6 115 (99–270) (p=n.s.) ng/ml; Presepsin 2800 (1250–5400) ng/ml (p=n.s.). On antibiotic stopping day biomarkers values were significantly decreased in survivors: CRP 42 (15–105) mg/ml (p=0.03), PCT 0.2 (0.1–0.7) ng/ml (p=0.025); IL-6 32 (16–78) ng/ml (p=0.012); Presepsin 485 (250–740) ng/ml (p=0.014); whereas in dead ones remained higher CRP 126 (111–364) mg/ml (p=n.s.), PCT 1.4 (1.2–4.1) ng/ml (p=n.s.); IL-6 105 (68–170) (p=n.s.) ng/ml; Presepsin 1830 (999–5485) ng/ml (p=n.s.). LR showed a proportional trend but with a low value of association: Presepsin/PCT (R²=0.55), Presepsin/IL-6 (R²=0.61). BAP showed the highest agreement between Presepsin and IL-6, but not between PCT/Presepsin both in survived and dead patients.

Conclusions: PCT, IL-6, and Presepsin showed a dichotomous trend in relation with patient outcome; we documented (i) by LR a low correlation among tested biomarkers (ii) the highest agreement between Presepsin/IL-6 by BAP in terms of sepsis measurement.

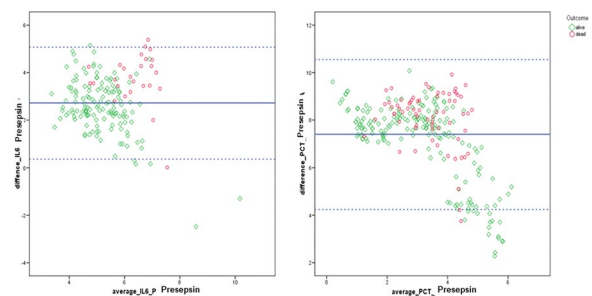

Figure (abstract 000554) Bland Altman plots: PCT/presepsin & IL-6/presepsin

Topic: Sepsis

000555

Renal Resistive Index as early predictor for acute renal injury in critically ill patientsN. Cango¹, A. Blanco¹, G. Castañeda¹, C. Alvarez¹, P. García Olivares¹, J. Cedeño Mora¹¹Intensive Care Unit, H.G.U Gregorio Marañón, Madrid, Spain**Correspondence:** N. Cango*Intensive Care Medicine Experimental* 2023, **11(Suppl 1)**:000555

Introduction: Acute kidney injury (AKI) is a common condition in patients admitted in Intensive care unit (ICU), it has great importance due to significant morbidity and mortality. Early diagnosis and adequate intervention could improve survival in these patients. Renal Resistive index (RRI) could be an especially helpful tool for early detection of AKI.

Objectives: The aim of this study was to identify if RRI measured within 24 h from admission in ICU, is an early predictor for AKI.

Methods: This is an observational, prospective study in ICU patients admitted at Gregorio Marañón Hospital (Madrid, Spain), between February–March 2023. Exclusion criteria were chronic kidney disease (CKD), age < 18 years and bad echographic window. RRI was obtained within 24 h of admission in ICU and was measured by one of four operators who had at least one year's clinical experience in RRI method. Both kidneys were examined, measurements were made at two sites on each kidney in an interlobular or arcuate artery. From the pole RRI values, a mean RRI was computed.

The following data was collected for each patient at time of RRI measurement and after 72 h of admission: age, reason for admission, cardiovascular risk factors, need for invasive mechanical ventilation (IMV), vasopressor requirements, use of nephrotoxic drugs, urea, creatinine and BUN values, also glomerular filtration rate was calculated using EPI-CKD equation. Severity of illness was graded using the Acute Physiology and Chronic Health disease Classification System II (APACHE II) score. For AKI diagnosis and classification, we used KDIGO criteria.

Descriptive statistics were expressed as mean \pm SD, or median with interquartile range (IQR) for continuous variables and percentages for categorical data. The ability of RRI to discriminate AKI was assessed using area under the receiver operating characteristic curve (AUROC). Estimation of their calibration was established through the Hosmer–Lemeshow goodness of fit test. To evaluate the extent to which the RRI was valid for prediction AKI, sensitivity (S), specificity (E), overall validity of prediction, positive and negative predictive values (PPV, NPV) were determined.

Results: Seventy patients were included. Mean age was 58 ± 17 years and 50% were male. 44.3% had arterial hypertension and 25.7% mellitus diabetes. Mean admission severity score APACHE II 14 ± 7 . 42.9% patients required IMV and 55.7% vasopressors. 41.4% patients were diagnosed AKI within 24 h ICU stay while 27.1% after 72 h of admission. 10% required continuous renal replacement therapy (CRRT).

In univariate analysis we found that RRI values measured within 24h of admission were significantly lower in patients without AKI ($0,69 \pm 0,06$) than in those with AKI ($0,78 \pm 0,07$) ($p < 0.01$).

In AU-ROC curves analysis, RRI had a good capacity for discriminating (AUC 0.85, 95% CI: 0.74–0.95) and a good calibration ability (Chi-squared test 8.03 $p = 0.43$) to predict AKI after 72 h of ICU admission. Best RRI value was 0.73 to diagnostic accuracy in predicting AKI: sensitivity 74%, specificity 80%, positive predictive value (PPV) 64% and negative predictive value (NPV) 87%. (Figure 1).

Conclusions: In our experience RRI measured within 24 h of admission in ICU, could be an early predictor for AKI in critically ill patients.

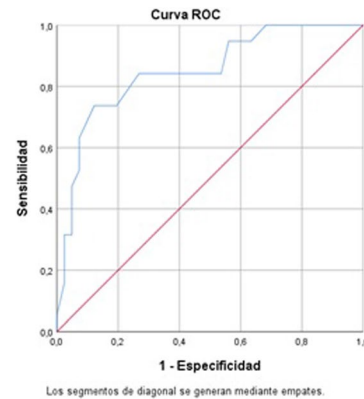
**AUROC CURVE**

RRI 24H: EARLY PREDICTOR AKI

Area	Desv. Error ^a	Significación asintótica ^b	95% de intervalo de confianza asintótico
.849	.055	.000	.742 .957

Figure 1 (abstract 000555) RRI an early predictor of AKI**Topic:** Acute Kidney Injury and haemofiltration

000556

A 29-mRNA host response test predicts mortality in Intensive Care Unit patients with COVID-19: a prospective observational cohort studyK. Daenen¹, K. Tong-Minh², O. Liesenfeld³, V. Dalm⁴, J. Huijben¹, D. Gommers¹, E. Van Gorp², H. E. Endeman¹¹Intensive Care, Erasmus University Medical Center, Rotterdam, Netherlands;²Viroscience, Erasmus University Medical Center, Rotterdam, Netherlands;³Inflammatix Inc., Inflammatix Inc., Redwood City, United States of America;⁴Immunology, Erasmus University Medical Center, Rotterdam, Netherlands**Correspondence:** K. Daenen*Intensive Care Medicine Experimental* 2023, **11(Suppl 1)**:000556

Introduction: Identification of illness severity in COVID-19 patients in the intensive care unit (ICU) is of critical importance. Analysis of host gene expression is a promising tool to prognosticate outcomes in these patients. The 29 host mRNA Inflammatix Severity-3b (IMX-SEV-3b) classifier has been reported to predict disease severity in emergency department and surgical ICU patients. The accuracy of IMX-SEV-3b to predict illness severity in COVID-19 patients admitted to the ICU is unknown.

Objectives: The goal of this study was to investigate the accuracy of IMX-SEV-3b to predict ICU-mortality compared to routinely measured biomarkers and APACHE-IV score.

Methods: A prospective observational cohort study enrolled COVID-19 patients admitted to the ICU of a tertiary hospital in Rotterdam, Netherlands. IMX-SEV-3b scores were generated by amplifying 29 host response genes from blood collected in PAXgene[®] Blood RNA tubes. A severity score was provided ranging from 0 to 1 and fall into one of five interpretation bands (very low, low, moderate, high and very high). The primary outcome was the accuracy of prediction of

ICU-mortality using IMX-SEV-3b. Results were compared to the predictive value of C-reactive protein (CRP), lactate dehydrogenase (LDH), and the APACHE-IV score.

Results: A total of 53 patients were included between March 1, 2020 and April 30, 2020, of which 18 (34%) died during ICU stay. Age, sex and BMI did not differ significantly between survivors and non-survivors. The performance of IMX-SEV-3b is shown in Table 1. IMX-SEV-3b scores were significantly associated with mortality with an unadjusted odds ratio of 204.63 (1.85–44,630.68); mean IMX-SEV-3b score was 0.57 in survivors versus 0.65 in non-survivors ($p=0.05$, univariate regression analysis). The AUC of IMX-SEV-3b for prediction of ICU mortality was 0.65 (95% CI: 0.48–0.82) compared to an AUC of 0.86 (95% CI: 0.74–0.98) for APACHE-IV. The biomarkers CRP and LDH were not significantly associated with mortality (Table 2). In multivariate regression analysis, IMX-SEV-3b remained a predictor of mortality when adjusting for age, sex and BMI, whereas CRP and LDH did not.

Table 1 (abstract 000556) Performance of IMX-SEV-3b on ICU mortality

IMX-SEV-3b severity score		Survival status		IMX-SEV-3b performance per band			
		Survivor	Non-survivor	% Patients in band	Sensitivity	Specificity	Likelihood ratio
IMX-SEV-3b category	Very High Bacterial	0	4	8%	22%	100%	Inf
	High Bacterial	2	0	4%	0%	94%	0.00
	Moderate Bacterial	9	6	28%	33%	74%	1.30
	Low Bacterial	23	8	58%	56%	66%	0.68
	Very Low Bacterial	1	0	2%	100%	3%	0.00

Table 2 (abstract 000556) Univariate analysis of IMX-SEV-3b, CRP, LDH and Apache-IV

Test/biomarker/clinical score	Odds ratio (95% CI)	AUC (95% CI)
CRP	1.0 (0.99–1.0)	0.52 (0.34–0.70)
LDH	1.0 (1.0–1.01)	0.56 (0.37–0.74)
IMX-SEV-3b	204.63 (1.85–44,630.68)	0.65 (0.48–0.82)
APACHE-IV	130.77 (3.93–13,126.55)	0.86 (0.74–0.98)

Conclusions: IMX-SEV-3b was significantly associated with mortality in COVID-19 patients in the ICU. Further prospective studies are required to determine the accuracy of IMX-SEV-3b for prediction of mortality and its value for patient management.

Table 1 (abstract 000556) Performance of IMX-SEV-3b on ICU mortality

IMX-SEV-3b Severity Score		Survival status		IMX-SEV-3b performance Per Band			
		Survivor	Non-survivor	% Patients in Band	Sensitivity	Specificity	Likelihood Ratio
IMX-SEV-3b category	Very High Bacterial	0	4	8%	22%	100%	Inf.
	High Bacterial	2	0	4%	0%	94%	0.00
	Moderate Bacterial	9	6	28%	33%	74%	1.30
	Low Bacterial	23	8	58%	56%	66%	0.68
	Very Low Bacterial	1	0	2%	100%	3%	0.00

References

1. Brakenridge SC, Starostik P, Ghita G, Midic U, Darden D, Fenner B, et al. A Transcriptomic Severity Metric That Predicts Clinical Outcomes in Critically Ill Surgical Sepsis Patients. *Crit Care Explor.* 2021;3(10):e0554
2. Galtung N, Diehl-Wiesenecker E, Lehmann D, Markmann N, Bergstrom WH, Wacker J, et al. Prospective validation of a transcriptomic severity classifier among patients with suspected acute infection and sepsis in the emergency department. *Eur J Emerg Med.* 2022;29(5):357–65

Topic: Critical care organisation, quality management, information systems, outcomes

000557

Renal Resistive Index as an independent prognostic factor for mortality in critically ill patients

G. Castañeda¹, N. Cango¹, C. Alvarez¹, A. Blanco¹, P. García Olivares¹, J. Cedeño Mora¹, J. C. Barrios¹

¹Intensive Care Unit, H.G.U Gregorio Marañón, Madrid, Spain

Correspondence: N. Cango

Intensive Care Medicine Experimental 2023, **11(Suppl 1)**:000557

Introduction: There are many scoring systems to predict the likelihood of hospital mortality for patients admitted to intensive care unit (ICU). Over the last few years, the use of ultrasonography has become widely extended in ICU clinical practice, so it would be useful to know an echographic tool to predict mortality that can be used at the patient’s bedside. Renal Resistive Index (RRI) could be used to predict mortality.

Objectives: The aim of this study was to identify if RRI, measured within 24 h from admission, is an independent prognostic factor for mortality in critically ill patients.

Methods: This is an observational, prospective study performed in ICU patients admitted at Gregorio Marañón Hospital (Madrid, Spain), between February–March 2023. Exclusion criteria were chronic kidney disease (CKD), age < 18 years and bad echographic window. RRI was obtained within 24 h of admission in ICU, this was measured by one of four operators who had at least one year’s clinical experience with the RRI method. Both kidneys were examined, measurements were made at two sites on each kidney in an interlobular or arcuate artery. From the pole RRI values, a mean RRI was computed.

The following data was collected for each patient: age, Charlson index, reason for admission, need for invasive mechanical ventilation (IMV), vasopressor requirements, development of acute kidney injury and outcome. Severity of illness was graded by APACHE II and SOFA scores. Descriptive statistics were expressed as mean ± SD, or median with interquartile range for continuous variables and percentages for categorical data. In univariate analysis mean IRR was compared using Student T test. Association between IRR and mortality was estimated by multiple logistic regression analysis, adjusted by confusional factors.

Results: Seventy patients were included. Mean age was 58 ± 17 years and 50% were male. Most common reason for admission was sepsis (37.1%). Median Charlson index 1 (IQR 0–2). Mean admission severity

score by APACHE II 14 ± 7 points and mean SOFA within 24 h 5 ± 4 points. 42.9% patients required IMV, median 4 days (IQR 1–7), and 55.7% needed vasopressors. Median ICU stay was 5 days (IQR 3–9) and 8.7% mortality.

In univariate analysis we found that RRI values were significantly higher in nonsurvivors (0.82 ± 0.07) than in survivors patients (0.70 ± 0.07) ($p < 0.01$). We confirmed that RRI measured in first 24h of ICU admission was a prognostic factor for ICU mortality (OR 1.21; 95% CI 1.07–1.37).

Multivariable logistic regression analysis included age, reason for admission, Charlson index, APACHE II, use IMV, vasopressors requirement and need for continuous renal replacement therapy, RRI was independently associated with mortality in critically ill patients: OR 1.69; 95% IC 1.04–2.74. (Table 1).

Conclusions: In our experience RRI measured within 24 h of admission in ICU, was an independent prognostic factor of death in critically ill patients.

Table 1 (abstract 000557) RRI an independent prognostic factor for mortality

RRI AN INDEPENDENT PROGNOSTIC FACTOR FOR MORTALITY

VARIABLE	OR	95% C.I.	
RRI x 100	1,686	1,036	2,742
Age	,978	,844	1,132
Charlson Index	,467	,130	1,679
Sepsis reason for admission	1,568	,013	189,200
APACHE II	1,083	,746	1,574
SOFA_24H	1,091	,595	2,002
IMV (1)	14,807	,068	3210,637
Vasopressors	,530	,001	513,508
CRRT (2)	,790	,003	243,807

1. Invasive Mechanical ventilation

2. Continuous Renal Replacement Therapy

Topic: Acute Kidney Injury and haemofiltration

000564

Association between coagulation markers and acute kidney injury following cardiopulmonary bypass in younger children

S. Minami¹, T. Abe¹, H. Nagafuchi², I. Takeuchi¹

¹Emergency and Critical Care Medicine, Yokohama City University Medical Center, Yokohama, Japan; ²Critical Care Medicine, Kanagawa Children's Medical Center, Yokohama, Japan

Correspondence: S. Minami

Intensive Care Medicine Experimental 2023, **11(Suppl 1)**:000564

Introduction: Acute kidney injury (AKI) following cardiopulmonary bypass (CPB) is a common complication in both adults and children. Reportedly, endothelial damage of renal capillaries is involved in the development of AKI (1). Vascular endothelial damage activates the coagulation cascade (2), but no previous studies have examined the association between coagulopathy after CPB and the onset of AKI, especially among younger children.

Objectives: To investigate whether early postoperative coagulation-fibrinolysis markers are risk factors for the onset of AKI after surgeries using CPB in younger children.

Methods: This single-center retrospective cohort study included infants and toddlers who underwent cardiovascular surgery with CPB and were admitted to the pediatric intensive care unit (PICU) between August 1, 2020, and December 31, 2021. The outcome of the study was to assess the presence or absence of AKI onset. We collected data on coagulation-fibrinolysis markers, age in months, sex, weight, and AKI risk factors (single ventricular disease, pulmonary hypertension, risk adjustment in congenital heart surgery system (RACHS) -1 score ≥ 3 , use of vasopressin, and cardiopulmonary bypass time) and compared those variables based on the AKI status. Subsequently, we performed multiple logistic regression analysis to evaluate coagulation-fibrinolysis markers as a factor controlling other variables.

Results: We enrolled 154 participants, of whom 55 (35%) developed AKI. Univariate analysis showed significant differences for thrombin-antithrombin complex (TAT) level ($p = 0.046$), fibrinogen level ($p = 0.007$), platelet level ($p = 0.008$), Plasminogen Activator Inhibitor-1 (PAI-1) level ($p = 0.023$), vasopressin use ($p = 0.006$), and CPB time ($p = 0.004$). However, in the multivariable analysis, only CPB time was significant. Although coagulation markers were significantly elevated in the AKI group, fibrinolytic markers were only mildly elevated in both the AKI and non-AKI groups, with no statistical significance.

Conclusions: The increase in coagulation markers in the early post-operative period following CPB was associated with the onset of AKI. Coagulation markers were elevated but fibrinolytic markers were not, suggesting that activation of the coagulation cascade due to vascular endothelial damage may be involved in the development of AKI. However, because this study was conducted at a single center with a limited number of patients, a further multicenter prospective study is needed to validate these findings.

References

1. Not applicable.
1. Kim M, Allen B, Korhonen EA, Nitschké M, et al. Opposing actions of angiotensin-2 on Tie2 signaling and FOXO1 activation. *J Clin Invest.* 2016;126:3511–25.
2. Higgins SJ, Ceunynck DK, Kellum JA, et al. Tie2 protects the vasculature against thrombus formation in systemic inflammation. *J Clin Invest.* 2018;128(4):1471–84.

Topic: Acute Kidney Injury and haemofiltration

000567

Postoperative prolonged mechanical ventilation and long term clinical outcome in lung transplantation

S. H. Youn¹, A. L. Woo¹

¹Division of Pulmonary and Critical Care Medicine, Department of Internal Medicine, Severance Hospital, Yonsei University College of Medicine, Seoul, Republic of Korea

Correspondence: A. L. Woo

Intensive Care Medicine Experimental 2023, **11(Suppl 1)**:000567

Introduction: Lung transplantation is a definitive treatment for end-stage lung disease, and the number of patients on the waitlist is increasing each year. Unfortunately, survival rates for lung transplantation are often lower than those for other solid organ transplants, with a 5-year survival rate of less than 60%. This is due to various recipient characteristics, such as age, frailty at the time of transplantation, and organ-specific complications. Prolonged postoperative mechanical ventilation (MV) leads to a longer stay in the intensive care unit (ICU) and ICU-acquired weakness. In this study, we assess the risk factors for prolonged MV in lung transplantation patients.

Methods: We collected electronic medical records of lung transplantation patients in Severance Hospital, a tertiary hospital in South Korea, from January 2016 to December 2020. We collected clinical information about pre- and post-lung transplantation. Prolonged mechanical ventilation was defined as the ventilator day over 7 days. We analyzed the risk factors for prolonged mechanical ventilation (MV) and intensive care unit (ICU) stay using logistic regression.

Results: A total of 224 cases of lung transplantation was conducted during the study period. After excluding re-transplantation ($n=5$) and immediate postoperative death ($n=43$), we analyzed 176 cases of lung transplantation. Patients with prolonged MV were younger, less male-dominant, and showed a higher ratio of connective tissue disease-associated interstitial lung disease. Preoperative mechanical ventilation (adjusted OR=2.72, 95% CI [1.21–6.13]) and postoperative primary graft dysfunction within 72 h (adjusted OR=14.6, 95% CI [4.00–53.57]) were associated with prolonged MV. Only waiting time was associated with 2-year mortality (adjusted OR=1.002, 95% CI [1.00–1.004]).

Conclusions: In this study, preoperative mechanical ventilation was identified as important risk factors for prolonged postoperative mechanical ventilation. Additionally, postoperative primary graft dysfunction was also associated with prolonged postoperative mechanical ventilation. Prolonged waiting time was associated long term survival, but prolonged mechanical ventilation was not.

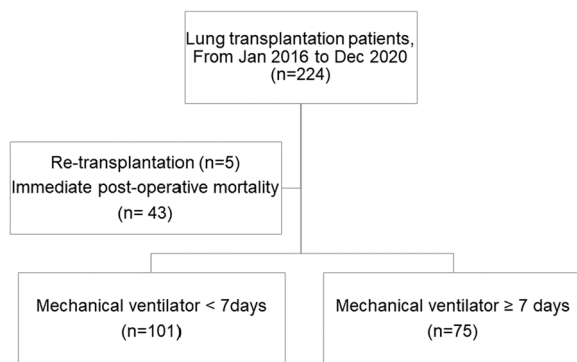

Figure 1 (abstract 000567) Study flow

References

- Yang, Tao et al. "Risk factors for intensive care unit-acquired weakness: A systematic review and meta-analysis." *Acta neurologica Scandinavica* vol. 138,2 (2018): 104–114. <https://doi.org/10.1111/ane.12964>
- Chambers, Daniel C et al. "The International Thoracic Organ Transplant Registry of the International Society for Heart and Lung Transplantation: Thirty-eighth adult lung transplantation report—2021; Focus on recipient characteristics." *The Journal of heart and lung transplantation: the official publication of the International Society for Heart Transplantation* vol. 40,10 (2021): 1060–1072. <https://doi.org/10.1016/j.healun.2021.07.021>
- Lee, K H et al. "Predicting ICU length of stay following single lung transplantation." *Chest* vol. 110,4 (1996): 1014–7. <https://doi.org/10.1378/chest.110.4.1014>

Topic: Acute respiratory failure and mechanical ventilation

000568

Role of hemolysis on pulmonary artery capacitance and right ventricular systolic function after cardiopulmonary bypass: results from a prospective cohort study

S. Redaelli¹, E. Rezoagli¹, R. Fumagalli¹, L. Berra²

¹School of Medicine and Surgery, University of Milano-Bicocca, Monza, Italy; ²Department of Anesthesia, Critical Care and Pain Medicine, Massachusetts General Hospital, Boston, United States of America

Correspondence: S. Redaelli

Intensive Care Medicine Experimental 2023, 11(Suppl 1):000568

Introduction: Cardiopulmonary bypass (CPB) during cardiac surgery has been associated with hemolysis that results in increased plasma hemoglobin and consequent nitric oxide depletion [1]. This may translate into worsened pulmonary hemodynamics after CPB. We hypothesized that CPB-related hemolysis is associated with lower pulmonary artery capacitance and worse right ventricular systolic function.

Methods: Patients undergoing cardiac surgery with CPB at Massachusetts General Hospital, Boston, USA, between June 2014 and March 2015 were prospectively included. Plasma nitric oxide consumption was assessed after CPB, at 15 min, 4 and 12 h. Pulmonary artery capacitance (stroke volume-to-pulmonary artery pulse pressure ratio), and right ventricular function index (right ventricular end systolic pressure-to-cardiac output ratio)—a surrogate of right ventricular systolic function [2]—were measured at 15 min, 4 and 12 h after CPB by a pulmonary artery catheter. Mixed-effects models for repeated measures and post-hoc multiple comparisons with Dunnett's correction were applied. We also evaluated the correlation among changes in nitric oxide consumption and hemodynamic parameters between 15 min and 4 h after CPB by the Pearson correlation coefficient.

Results: Forty patients (26% female, median [IQR] age 66 [57 to 75] years, median [IQR] body mass index 29.1 [26.6 to 33.0] kg/m²) were included in this preliminary subanalysis. Pulmonary artery capacitance was the lowest immediately after the end of CPB and gradually increased over time (Fig 1A). Similarly, the right ventricular function index was the highest 15 min after the end of CPB (i.e., worst right ventricular systolic function) and decreased at the subsequent time points (Fig. 1B). The improvement of these hemodynamic parameters paralleled the decrease in nitric oxide consumption over the same time points (Fig. 1C). The nitric oxide consumption reduction between 15 min and 4 h after CPB significantly correlated with the improvement in pulmonary artery capacitance ($r=0.46$, $p=0.002$) and right ventricular function index ($r=-0.79$, $p<0.001$).

Conclusions: In this study, patients undergoing CPB showed a gradual increase of pulmonary artery capacitance and a gradual decrease of right ventricular function index since 15 min until 12 h follow-up. The change in nitric oxide consumption—a robust biomarker of intravascular hemolysis—was significantly correlated with the change in pulmonary artery capacitance and right ventricular function index between 15 min and 4 h after CPB.

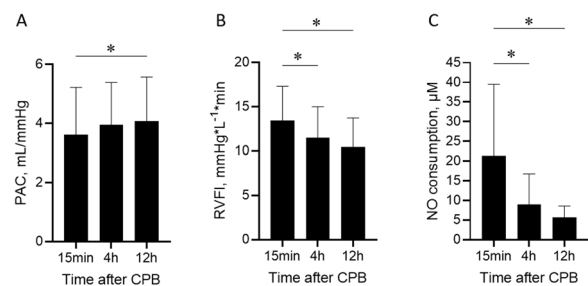

Figure 1 (abstract 000568) Hemodynamics and hemolysis parameters at 15 min, 4 h, and 12 h after cardiopulmonary bypass (CPB). A) Pulmonary artery capacitance (PAC) over time. B) Right ventricular function index (RVFI) over time. The higher the RVFI, the worse the right ventricular systolic function. C) Concentrations of plasma NO consumption over time. * $p<0.05$. Data are presented as mean \pm SD

References

- Couture EJ, Moses K, Monge García MI, Potes C, Haddad F, Grønlykke L, García F, Paster E, Pibarot P, Denault AY. Longitudinal Validation of Right Ventricular Pressure Monitoring for the Assessment of Right Ventricular Systolic Dysfunction in a Large Animal Ischemic Model. *Crit Care Explor*. 2023 Jan 18;5(1):e0847. <https://doi.org/10.1097/CCE.0000000000000847>. PMID: 36699251; PMCID: PMC9851694.

2. 1. Rezoagli E, Ichinose F, Strelow S, Roy N, Shelton K, Matsumine R, Chen L, Bittner EA, Bloch DB, Zapol WM, Berra L. Pulmonary and Systemic Vascular Resistances After Cardiopulmonary Bypass: Role of Hemolysis. *J Cardiothorac Vasc Anesth*. 2017 Apr;31(2):505–515. <https://doi.org/10.1053/j.jvca.2016.06.009>. Epub 2016 Jun 8. PMID: 27590461.

Topic: Cardiovascular issues in ICU

000569

The immune-mediated ferroptosis in acute lung injury/acute respiratory distress syndrome

A. Ma¹, L. Yang¹, W. Qin¹, Y. Jing¹, K. Yan¹

¹Department of Critical Care Medicine, West China Hospital of Sichuan University, Chengdu, Sichuan Province, China, Chengdu, China

Correspondence: A. Ma

Intensive Care Medicine Experimental 2023, **11(Suppl 1)**:000569

Introduction: Acute lung injury/acute respiratory distress syndrome (ALI/ARDS) is one of the most life-threatening diseases in the intensive care unit, with high mortality and morbidity [1–3]. Ferroptosis is a newly discovered immune-related cell death that is associated with various lung diseases [4–6]. However, the role of immune-mediated ferroptosis in ALI/ARDS has not been elucidated.

Objectives: To investigate the interactions between lung immune cell infiltration and ferroptosis and to explore the underlying mechanisms by which characteristic ferroptosis-related genes are regulated by immune cells in ALI/ARDS.

Methods: We analyzed two Gene Expression Omnibus (GEO) datasets (GSE2411 and GSE109913) and extracted characteristic ferroptosis-related genes (FRGs) between the control and ALI groups through bioinformatic analysis. We prospectively collected BALF from patients with ARDS and verified the expression of characteristic FRGs. We constructed the ALI/ARDS model induced by LPS and isolated the primary neutrophils of mice. Erastin, an inducer of ferroptosis, was used at the cellular level to verify the effect of neutrophils on ferroptosis in lung epithelium cells. We used electron microscopy to observe mitochondrial ultrastructural changes associated with ferroptosis, the JC-1 assay to observe changes in mitochondrial membrane potential, quantitative real-time PCR, Elisa, immunofluorescence (IF), and western blot (WB) to detect gene and protein changes in tissues and cells.

Results: We identified three characteristic FRGs, Cp, Slc39a14 and Slc7a11, by analyzing two gene expression profiling datasets. Immune infiltration analysis showed that the three characteristic genes were significantly positively correlated with the infiltration levels of neutrophils. We collected BALF from 59 ARDS patients to verify the expression of Cp, Slc7a11 and Slc39a14 in humans (Figure 1). The results showed that Cp was elevated in patients with severe ARDS, Slc7a11 was significantly elevated in patients with moderate ARDS ($p=0.0205$) relative to patients with mild ARDS. The levels of neutrophils in the peripheral blood of ARDS patients were positively correlated with the expression levels of Slc7a11 (Pearson's $R^2=0.086$, $p=0.033$). Three characteristic FRGs were significantly activated after the onset of ferroptosis (6 h) early in LPS induced ALI model, and that ferroptosis was alleviated after the organism compensated within 12 to 48 h (Figure 2). The immunofluorescence staining suggested that the

recruitment of activated neutrophils from the periphery to the lung after injury appears to be associated with an upregulation of Slc7a11. We extracted primary activated neutrophils from mice and co-cultured them with MLE-12 in transwell, Slc7a11, Cp and Slc39a14 in MLE-12 cells were significantly upregulated as the number of neutrophils increased (Figure 3). The results showed that neutrophil infiltration alleviated erastin-induced MDA accumulation, GSH depletion, and divalent iron accumulation, accompanied by upregulation of Slc7a11 and Gpx4, implying the existence of a compensatory effect of lipid oxidation in neutrophils after acute lung injury in the organism.

Conclusions: We identified three immune-mediated ferroptosis genes, namely, Cp, Slc7a11 and Slc39a14, which possibly regulated by neutrophils during the development of ALI, and their pathways may be involved in anti-oxidative stress and anti-lipid metabolism. Thus, the present study contributes to the understanding of ALI/ARDS and provide novel targets for future immunotherapeutic.

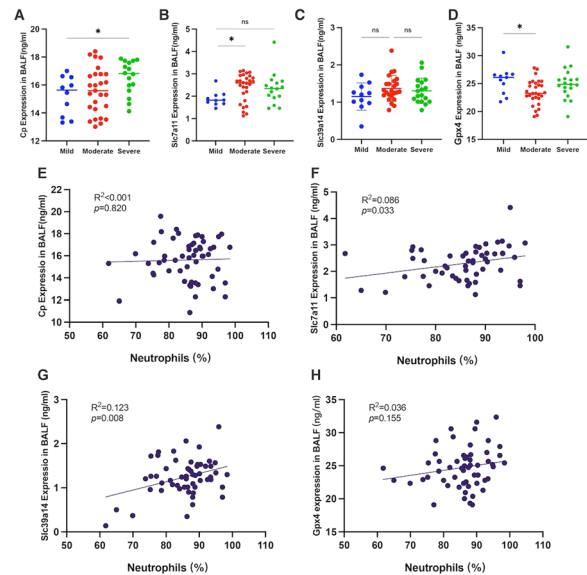

Figure 1 (abstract 000569) Concentrations of characteristic FRGs in BALF from patients with acute respiratory distress syndrome (Mild ARDS, $n=11$; Moderate ARDS, $n=29$; Severe ARDS, $n=19$). (A) Cp expression in BALF; (B) Slc7a11 expression in BALF; (C) Slc39a14 expression in BALF; (D) Gpx4 expression in BALF; (E) Correlation analysis between the expression of Cp in BALF and the percentage of peripheral blood neutrophils; (F) Correlation analysis between the expression of Slc7a11 in BALF and the percentage of peripheral blood neutrophils; (G) Correlation analysis between the expression of Slc39a14 in BALF and the percentage of peripheral blood neutrophils; (H) Correlation analysis between the expression of Gpx4 in BALF and the percentage of peripheral blood neutrophils; Pearson R^2 and p values were computed as indicated on each graph

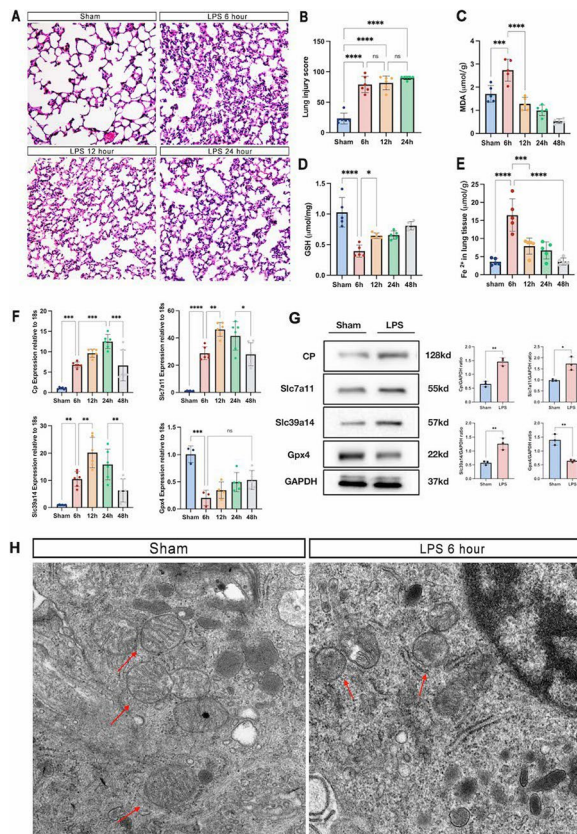

Figure 2 (abstract 000569) LPS administration induces lung injury and ferroptosis. (A) The representative H&E staining of lung tissue sections, magnification 400x; (B) The lung injury score analysis; The level of ferroptosis markers (C) MDA, (D)GSH, (E) Fe²⁺ in lung tissue; (F) The mRNA levels of Cp, Slc7a11, Slc39a14 and Gpx4 in lung tissue were detected by real-time qPCR. (G) The Cp, Slc7a11, Slc39a14 and Gpx4 protein levels in lung tissue were detected by western blotting at 6 h; (H) Ultrastructural changes of mitochondria in lung tissue by transmission electron microscopy, magnification 100,000x. Data presented as mean ± standard deviation with **p* < 0.05, ***p* < 0.01, ****p* < 0.001, *****p* < 0.0001 for all statistics

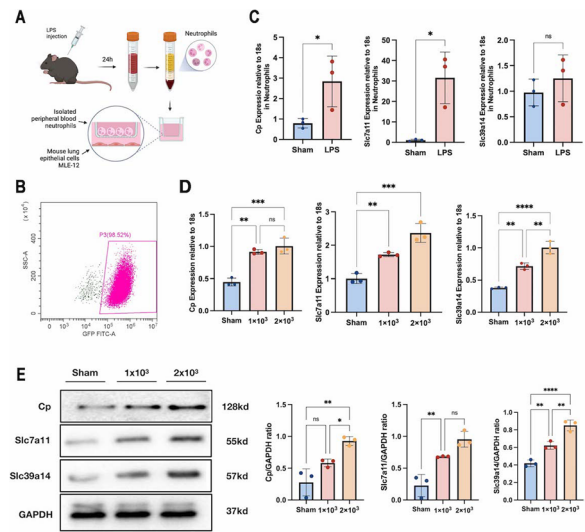

Figure 3 (abstract 000569) (A) Illustration of isolation of peripheral blood neutrophils and co-culture; (B) Verification of the purity of isolated neutrophils by flow cytometry; (C) mRNA expression of Cp, Slc7a11 and Slc39a14 in isolated neutrophils; (D) mRNA expression of Cp, Slc7a11 and Slc39a14 in MLE-12 co-cultured with different numbers of neutrophils; (E) Protein levels of Cp, Slc7a11 and Slc39a14 in MLE-12 co-cultured with different numbers of neutrophils; Data presented as mean ± standard deviation with **p* < 0.05, ***p* < 0.01, ****p* < 0.001, *****p* < 0.0001 for all statistics

References

6. Proneth B, Conrad M: Ferroptosis and necroinflammation, a yet poorly explored link. *Cell Death Differ* 2019, 26:14–24.
- The studies involving human participants were reviewed and approved by Biomedical Research Ethics Committee, West China Hospital, Sichuan University (2019-337). The patients/participants provided their written informed consent to participate in this study. The animal experiment was approved by the Ethics Committee of West China Hospital of Sichuan University (20220609006). The human or animal subjects related in this abstract complies with the guiding principles for experimental procedures, as set forth in the Declaration of Helsinki and related publications.
1. Meyer NJ, Gattinoni L, Calfee CS: Acute respiratory distress syndrome. *Lancet* 2021, 398:622–637.
2. Yadav H, Thompson BT, Gajic O: Fifty Years of Research in ARDS. Is Acute Respiratory Distress Syndrome a Preventable Disease? *Am J Respir Crit Care Med* 2017, 195:725–736.

3. Dres M, Austin PC, Pham T, Aegerter P, Guidet B, Demoule A, Veillard-Baron A, Brochard L, Geri G: Acute Respiratory Distress Syndrome Cases Volume and ICU Mortality in Medical Patients. *Crit Care Med* 2018, 46:e33–e40.
4. Sun Y, Chen P, Zhai B, Zhang M, Xiang Y, Fang J, Xu S, Gao Y, Chen X, Sui X, Li G: The emerging role of ferroptosis in inflammation. *Biomed Pharmacother* 2020, 127:110108.
5. Chen X, Kang R, Kroemer G, Tang D: Ferroptosis in infection, inflammation, and immunity. *J Exp Med* 2021, 218.

Topic: Acute respiratory failure and mechanical ventilation

000570

Sedentary behaviour and physical inactivity in individuals following critical illness: a prospective observational study

S. M. Parry¹, S. Abo¹, L. Denehy¹, A. Da Silva², P. Morris³, C. Granger¹

¹Physiotherapy, The University of Melbourne, Carlton, Australia;

²Physiotherapy, The Royal Melbourne Hospital, Parkville, Australia; ³Critical Care, University of Alabama at Birmingham, Birmingham, United States of America

Correspondence: S. M. Parry

Intensive Care Medicine Experimental 2023, **11(Suppl 1)**:000570

Introduction: Impairments in physical functioning and muscle strength are well recognised sequelae of critical illness. No studies have examined sedentary behaviour post discharge with limited evaluation of physical activity levels (largely < 3 months with small sample sizes).

Objectives: (1) Describe the physical activity and sedentary behaviour patterns over the first 12 months after hospital discharge in a cohort of ICU survivors; and (2) determine the relationship between physical activity and sedentary behaviour with a range of functional and patient report outcomes at 3 months.

Methods: Design/setting: Nested prospective observational study with serial data collection at hospital discharge, 3-, 6-, and 12-months post hospital discharge.

Participants: ICU survivors ventilated more than 48 h and in ICU at least four days and completed physical activity evaluation across at least two follow-up timepoints.

Outcome measures: Physical activity was assessed both objectively using Garmin VivoFit 2 device (triaxial accelerometer—steps per day over seven days) and subjectively using self-report questionnaire (International Physical Activity Questionnaire short form). Participants' levels of PA were compared with the recommended WHO Physical Activity Guidelines. Sedentary behaviour was assessed using the Sedentary Behaviour questionnaire from which average sedentary time (hours/day) was determined. Other measures included: quadriceps strength, physical function (Short Physical Performance Battery—SPPB), balance (Mini-BESTest), Clinical Frailty Scale, health related quality of life (EQ-5D-5L), fear of falls (measured by Falls Efficacy Scale International) and risk of falls (measured by Falls Risk for older people in the Community Screening Tool).

Results: 87 participants were included. 69% were male with mean age of 59.4 ± 16.1 years, mean APACHE II score of 21.2 ± 7.5, and ICU LOS of 8 days [5.0–15.0]. Physical activity levels were low across the 12 month follow up period with median daily steps per day of 4405 [2279–7036] at 3 months; 4316 [2777–7505] at 6 months and 5372 [3277–7447] at 12 months. Participants spent little to no time completing moderate to vigorous physical activity across the 12 month period (3 months: 0 [0–20]; 6 months: 0 [0–60] mins; and 12 months: 0 [0–60]). Participants had persistent high self-reported sedentary time across the 12 months (3 months: 7.5 ± 3.0 h/day; 6 months: 7.9 ± 3.3; 12 months: 8.2 ± 4.1) with increasing rates of sedentary behavior by 12 months (3 months: 48% classified as sedentary vs 12 months: 65%). The majority of participants (84–87% across the 12 months) did not meet the international PA guidelines of at least 150 min of moderate to vigorous activity per week. There was a fair correlation between higher steps per day at 3 months as measured by Garmin VivoFit2 with higher fatigue levels ($r = 0.493$, $p < 0.001$), quadriceps muscle strength ($r = 0.440$, $p < 0.001$) and quality of life ($r = 0.455$, $p < 0.001$). A moderate correlation existed between higher steps per day at 3 months with better physical functioning ($r = 0.598$, $p < 0.001$), and balance ($r = 0.562$, $p < 0.0001$). Higher

steps per day at 3 months was associated with lower levels of depression ($r = -0.509$, $p < 0.001$) and lower concern for falls ($r = -0.509$, $p < 0.001$), lower falls risk ($r = -0.516$, $p < 0.001$) and lower frailty score at 3 months ($r = -0.587$, $p = 0.001$). Participants with higher PA levels at 3 months had lower severity of illness, lower ICU-acquired weakness incidence and less comorbidities ($p < 0.05$).

Conclusions: Survivors of critical illness demonstrate persistent low levels of activity and high sedentary behaviour 12 months after hospital discharge and the majority do not meet international recommendations regarding physical activity. Modifiable factors exist which need to be targeted in post hospital discharge rehabilitation trials.

References

1. Grant: Al and Val Rosenstraus Fellowship

Topic: Nursing care and physiotherapy

000571

Determinants of extracorporeal carbon dioxide removal rate in extracorporeal CO₂ removal integrated within a continuous renal replacement circuit

Z. Qian¹, S. Liu¹, L. Liu¹

¹Department of Critical Care Medicine, Zhongda Hospital Southeast University, Nanjing, China

Correspondence: Z. Qian

Intensive Care Medicine Experimental 2023, **11(Suppl 1)**:000571

Introduction: Extracorporeal carbon dioxide removal (ECCO2R) can be integrated into standard continuous renal replacement therapy (CRRT) circuits (ECCO2R-CRRT), providing both CO₂ removal and hemofiltration/dialysis when there is concomitant acute kidney injury [1]. High CO₂ removal rate is critical for clinical practice. In the SUPERNOVA trial, compared with lower one, higher CO₂ extraction device are most likely to benefit from lung-protection of ECCO2R [2]. In a recent study, the CO₂ removal rate of the ECCO2R combined continuous veno-venous hemofiltration (CVVH) was about 5% lower than the elimination rate of the membrane lung alone [3]. However, the influence of CRRT to the CO₂ removal rate of entire extracorporeal circuits (VCO2EC) is unclear.

Objectives: For a higher CO₂ removal rate, how to choose the CRRT mode and substitution fluid in ECCO2R combined CRRT remain unanswered. In this large animal experiment, we plan to investigate the effect of different bicarbonate hemofiltration or dialysate on the CO₂ removal of entire extracorporeal circuit during CVVH and continuous veno-venous dialysate (CVVHD).

Methods: The study was approved by the Animal ethical Committee of Southeast University in China (ethical approval number: 20210901045). The experiments were performed in 12 domestic pigs (50–60 kg). The animals were generally anesthetized and connected to ECCO2R-CRRT devices, which was the combination of ECCO2R (OMNI-set[®], surface area 1.81 m², polymethylpentene membrane, filling volume 187 mL; BBraun, Germany), and the additional blood purification device, a hemoperfusion filter (OMNIFilter[®], surface area 1.6 m², polymethylpentene membrane, filling volume 94 mL; BBraun, Germany), and its circuit. The membrane lung was inserted serially in the extracorporeal circuit upstream to the hemofilter [4]. VCO2EC was measured under different combinations of ECCO2R alone, ECCO2R + CVVH, and ECCO2R + CVVHD. Each setting was conducted at different combinations of PaCO₂ (50–69, and 70–89 mmHg), extracorporeal blood flow (200, and 350 mL/min), and bicarbonate substitution fluid and dialysate (25, and 16 mmol/L) with the same rate of 30 mL kg⁻¹ h⁻¹ and zero net fluid loss. (Fig 1). The sweep gas flow was constantly set to 10 L/min with a fraction of delivered oxygen at 1.0. VCO2EC was calculated as the difference of total CO₂ content before membrane lung and after hemofilter, and normalized to an inlet PCO₂ of 45 mmHg [5, 6].

Results: Baseline characteristics of the studied animals were comparable within each mild or severe hypercapnia. At extracorporeal blood flow of 200 mL/min and bicarbonate substitution fluid and dialysate of 25 mmol/L, VCO2EC was reduced in ECCO2R + CVVH (49.5 ± 7.1 vs 54.3 ± 7.5 mL/min, $p < 0.05$), and ECCO2R + CVVHD (50.9 ± 6.7 vs 54.3 ± 7.5 mL/min, $p < 0.05$) compared with ECCO2R alone. But with

bicarbonate substitution fluid and dialysate of 16 mmol/L, no significant effect on VCO₂EC of CVVH and CVVHD was found (54.5 ± 7.1 vs 56.2 ± 9.7 vs 54.4 ± 8.4 mL/min; $p=0.3$) (Fig 2). At extracorporeal blood flow of 350 mL/min and bicarbonate hemofiltration and dialysate fluid of 25 and 16 mmol/L, VCO₂EC were unchanged in ECCO2R+CVVH and ECCO2R+CVVHD compared with ECCO2R alone (100.9 ± 24.0 vs 102.5 ± 27.9 vs 101.9 ± 22.9 mL/min; $p=0.8$ and 98.1 ± 14.7 vs 96.2 ± 15.5 vs 96.6 ± 12.7 mL/min; $p=0.7$) (Fig 3).

Conclusions: For ECCO2R-CRRT, low extracorporeal blood flow with conventional Bicarbonate hemofiltration and dialysis results in reduced VCO₂EC. Lower Bicarbonate hemofiltration and Dialysate is an optional solution to diminish this effect when extracorporeal blood flow cannot be elevated.

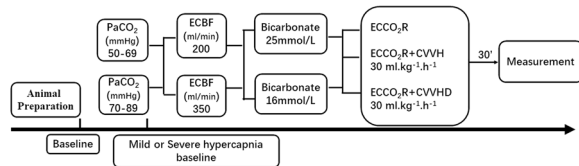
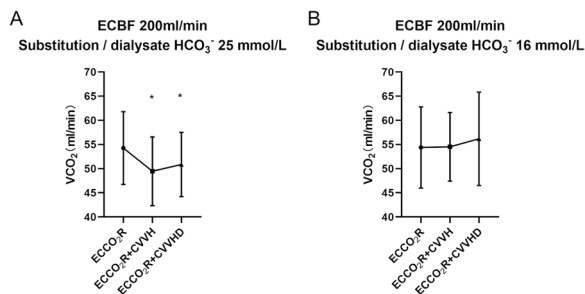

Figure 1 (abstract 000571) Experiment flowchart. Each value of before membrane lung, after hemofilter and arterial blood gas analysis was tested in all the possible combinations of PaCO₂, ECBF and Bicarbonate. PaCO₂, arterial pressure of carbon dioxide; ECBF, extracorporeal blood flow; ECCO2R, extracorporeal carbon dioxide removal; CVVH, continuous veno-venous hemofiltration; CVVHD, continuous veno-venous dialysate



***Figure 2 (abstract 000571)** The graph displays the VCO₂EC in ECCO2R, ECCO2R+CVVH and ECCO2R+CVVHD with a ECBF of 200 ml/min. Substitution or dialysate fluid bicarbonate concentration of 25 mmol/L (A) and 16 mmol/L (B). Each data point represents the mean and standard deviation of 12 pigs. * $p < 0.05$ compared with ECCO2R alone in A. No significant effect on VCO₂EC of CVVH and CVVHD was found in B ($p=0.3$). VCO₂EC, CO₂ removal of entire extracorporeal circuits; ECCO2R, extracorporeal carbon dioxide removal; CVVH, continuous veno-venous hemofiltration; CVVHD, continuous veno-venous dialysate; ECBF, extracorporeal blood flow

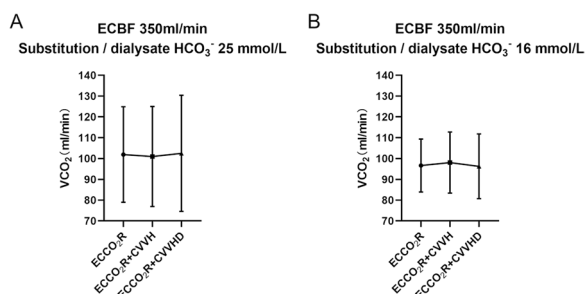

Figure 3 (abstract 000571) The graph displays the VCO₂EC in ECCO2R, ECCO2R+CVVH and ECCO2R+CVVHD with a ECBF of

350 ml/min. Substitution or dialysate fluid bicarbonate concentration of 25 mmol/L (A) and 16 mmol/L (B). Each data point represents the mean and standard deviation of 12 pigs. No significant effect on VCO₂EC of CVVH and CVVHD was found in A ($p=0.8$) and B ($p=0.7$). VCO₂EC, CO₂ removal of entire extracorporeal circuits; ECCO2R, extracorporeal carbon dioxide removal; CVVH, continuous veno-venous hemofiltration; CVVHD, continuous veno-venous dialysate; ECBF, extracorporeal blood flow

References

- Combes A, Brodie D, Aissaoui N, Bein T, Capellier G, Dalton HJ, et al. Extracorporeal carbon dioxide removal for acute respiratory failure: a review of potential indications, clinical practice and open research questions. *Intensive care medicine*. 2022;48(10):1308–1321.
- All authors agree to present the abstract in the session and at the time decided upon by the Congress Committee. All authors agree that ESICM will publish abstracts in the ICMx Journal and record the presentation for subsequent use, as it deems appropriate. All authors declare that the study was approved by the local animal investigation committee of Southeast University and animal handling was in accordance with the guide and use of laboratory animals. All authors declare that the scientific material found within the abstract has not been presented at any other meeting and will not be published in any form other than abstract form prior to the ESICM Annual Congress.
- Wearden PD, Federspiel WJ, Morley SW, Rosenberg M, Bieniek PD, Lund LW, et al. Respiratory dialysis with an active-mixing extracorporeal carbon dioxide removal system in a chronic sheep study. *Intensive care medicine*. 2012;38(10):1705–1711.
- Chittamma A, Vanavanan S. Comparative study of calculated and measured total carbon dioxide. *Clinical chemistry and laboratory medicine*. 2008;46(1):15–17.
- Allardet-Servent J, Castanier M, Signouret T, Soundarvelou R, Lepidi A, Seghboyen JM. Safety and Efficacy of Combined Extracorporeal CO₂ Removal and Renal Replacement Therapy in Patients With Acute Respiratory Distress Syndrome and Acute Kidney Injury: The Pulmonary and Renal Support in Acute Respiratory Distress Syndrome Study. *Critical care medicine*. 2015;43(12):2570–2581.
- Nentwich J, Wichmann D, Kluge S, Lindau S, Mutlak H, John S. Low-flow CO₂ removal in combination with renal replacement therapy effectively reduces ventilation requirements in hypercapnic patients: a pilot study. *Annals of intensive care*. 2019;9(1):3.
- Goligher EC, Combes A, Brodie D, Ferguson ND, Pesenti AM, Ranieri VM, et al. Determinants of the effect of extracorporeal carbon dioxide removal in the SUPERNOVA trial: implications for trial design. *Intensive care medicine*. 2019;45(9):1219–1230.

Topic: Acute respiratory failure and mechanical ventilation

000572

Management of delirium in the intensive care unit

G. Bhardwaj¹, A. Hagana², S. Sivanesan¹, P. Duggleby², T. Ali²
¹Anaesthetics and Critical Care, University of Buckingham, Eaglestone, United Kingdom; ²Anaesthetics and Critical Care, Stoke Mandeville Hospital, Aylesbury, United Kingdom

Correspondence: A. Hagana

Intensive Care Medicine Experimental 2023, **11(Suppl 1)**:000572

Introduction: Delirium is a common clinical phenomenon seen in critically ill patients and associated with significant adverse outcomes including increased morbidity, mortality, length of hospital stay and long-term cognitive impairment [1]. Although prevention and early recognition of delirium is the primary objective, the management approach has a significant effect on outcomes [1, 2]. This primarily involves identification and correction of the underlying source of delirium through a thorough clinical assessment, alongside non-pharmacological interventions including cognitive stimulation, reorientation, environment optimisation and family involvement [2]. Cautious pharmacological interventions may be utilised if required [2].

Methods: An audit was performed at Buckinghamshire Healthcare NHS Trust on patients admitted to the ICU between 22/09/22 and

5/10/22. 11 out of 38 patients were identified to have delirium during their admission. The management of delirium was investigated, focusing on the clinical assessment to identify the source, as well as non-pharmacological and pharmacological interventions based on NICE CKS guidelines [3].

Results: The results for this audit are summarised below.

Table 1 (abstract 000572) Summary of results

Clinical assessment	Factor reviewed (%)
Infection	Lines reviewed/VIP 54.5% Blood/urine/ sputum culture 18.2%
Metabolic disturbance	Glucose 45.5% Electrolytes 72.7%
Cardiovascular	ECG 27.3% Troponin 18.2% Echo 45.5%
Respiratory	O ₂ saturation 100% ABG 27.3% CXR 18.2%
Neurological	Imaging 27.3%
Gastrointestinal	Hydration 90.9% Constipation 72.7% Nutrition 100%
Pain	100%
Sleep	27.3%
Sensory impairment	27.3%
Mobility	45.5%
Non-pharmacological management	–
Re-orientation	36.3%
Family involvement	18.2%
Environment optimisation	18.2%
Cognitive stimulation	9.1%
Pharmacological management	–
Medication review	45.5%
Medication prescribed	72.7%

Conclusions: The results indicate that delirium management can be improved through a more thorough investigation of the underlying source of delirium. It shows particularly low non-pharmacological management, and a high reliance on pharmacological intervention, with 72.7% of delirious patients receiving haloperidol. We propose the introduction of a delirium management bundle, ensuring a comprehensive clinical review is performed and simple implementations made to every patient identified to be delirious. The ABCDEF bundle (Assess, prevent and manage pain; Both spontaneous awakening/spontaneous breathing trials; Choice of sedation and analgesia; Delirium: assess, prevent, manage; Early mobility and exercise; Family engagement and empowerment) has been shown to significantly improve outcomes in critical illness [2, 4].

References

1. Reznik ME, Slooter AJC. Delirium Management in the ICU. Current Treatment Options in Neurology. 2019;21(11):59.
2. Mart MF, Williams Roberson S, Salas B, Pandharipande PP, Ely EW. Prevention and Management of Delirium in the Intensive Care Unit. Seminars in Respiratory and Critical Care Medicine. 2021;42(1):112–26.
3. NICE. Delirium: Prevention, diagnosis and management in hospital and long-term care: Guidance. 2010. Available from: <https://www.nice.org.uk/guidance/cg103/chapter/Recommendations#preventing-delirium>
4. Sosnowski K, Lin F, Chaboyer W, Ransie K, Heffernan A, Mitchell M. The effect of the ABCDE/ABCDEF bundle on delirium, functional outcomes,

- and quality of life in critically ill patients: A systematic review and meta-analysis. International Journal of Nursing Studies. 2023;138:104410
5. No grants were received

Topic: Sedation, analgesia and delirium

000573

Effects of PEEP variation on mechanical power in healthy patients during general anesthesia

I. Fratti¹, T. Pozzi¹, M. Corrente¹, G. Galetta¹, P. Lopez¹, S. Grieco¹, C. Papini¹, N. Marin¹, S. Coppola², D. Chiumello²

¹Department of Health Sciences, University of Milan, University of Milan, Milano, Italy; ²Anesthesia and intensive Care, San Paolo, Milano, Italy

Correspondence: I. Fratti

Intensive Care Medicine Experimental 2023, 11(Suppl 1):000573

Introduction: Mechanical power (MP) reflects the energy delivered from the ventilator to the respiratory system (1, 2). Several studies have investigated the association between mechanical power and mortality in ARDS patients; however only few studies have focused on the variations of mechanical power on healthy patients during general anesthesia (3). Aim of this study was to evaluate the effect of two different positive end-expiratory pressure (PEEP) levels on MP in healthy mechanically ventilated patients of different ages.

Methods: 172 healthy (ASA classes 1–2 with no history of respiratory disease) patients undergoing elective surgery were prospectively enrolled. After induction, patients were ventilated in volume-controlled mode: tidal volume 8 mL/kg of predicted body weight (PBW), respiratory rate to obtain an end-tidal CO₂ of 35–40 mmHg, I:E 1:2, PEEP 5 cmH₂O and FiO₂ 0.40. Inhalational anesthesia was maintained by sevoflurane or desflurane. Before the start of the surgery, PEEP was set to 0 cmH₂O and, after 10 min, respiratory mechanics was measured and mechanical power was calculated. Consequently, the same was performed after setting and maintaining PEEP at 7 cmH₂O. Thus, the PEEP level was set according to the attending physician and the surgeon was allowed to operate. We performed a linear regression between age and the variation of mechanical power, driving pressure and peak pressure between the two PEEP levels (0 and 7 cmH₂O of PEEP). We divided patients into 5 equal quintiles according to their age; to assess the differences in terms of variation of MP (D0-7MP) among age-related quintiles a Kruskal–Wallis test with *post-hoc* comparisons was used.

Results: The median age was 60 [44–70] years old. Linear regression showed a negative association between MP variation from 7 and 0 cmH₂O of PEEP (...MP 0–7) and age, with elderly patients exhibiting a lower MP increase ($p < 0.001$, Figure 1). The variation in driving pressure significantly increased in older patients, while the variation in peak pressure was similar within different ages. When comparing age-related quintiles, the first and the last quintiles exhibited the highest and the lowest MP variation ($p < 0.05$, Figure 2).

Conclusions: In healthy subjects, age plays a significant role in response to PEEP adjustment in terms of MP mainly due to DP (elastic component) without an increase in peak pressure (resistive component).

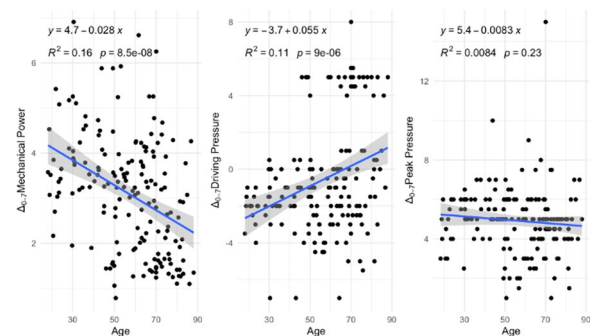

Figure 1 (abstract 000573) Linear regression that investigate the relation between age and (a) Variation in terms of mechanical power,

(B) Variation in terms of Driving pressure (dynamic component of the mechanical power) and (C) Variation in terms of Peak Pressure (resistive component of the mechanical power)

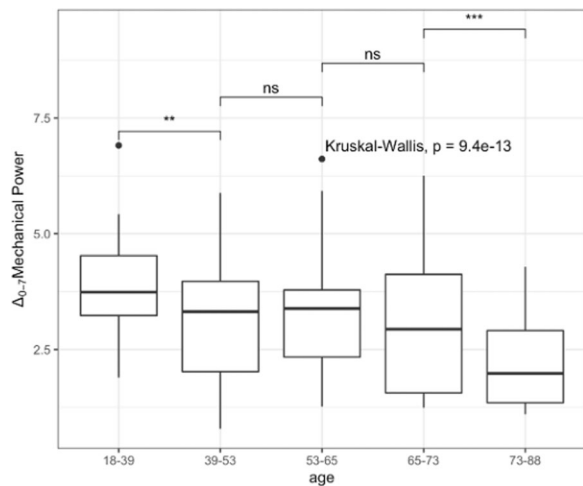

Figure 2 (abstract 000573) Analyses of the mechanical power variation between the two timepoints (ZEEP-PEEP7) with age quintiles

References

- (1) Gattinoni L, Tonetti T, Cressoni M, Cadringher P, Herrmann P, Moerer O, Protti A, Gotti M, Chiuazzi C, Carlesso E, et al. Ventilator-related causes of lung injury: the mechanical power. *Intensive Care Med.* 2016;42(10):1567–75
- (3) Santer P, Wachtendorf LJ, Suleiman A, Houle TT, Fassbender P, Costa EL, Talmor D, Eikermann M, Baedorf-Kassis E, Schaefer MS. Mechanical Power during General Anesthesia and Postoperative Respiratory Failure: A Multicenter Retrospective Cohort Study. *Anesthesiology.* 2022 Jul 1;137(1):41–54.
- (2) Collino F, Rapetti F, Vasques F, Maiolo G, Tonetti T, Romitti F, Niewenhuis J, Behnemann T, Camporota L, Hahn G, Reupke V, Holke K, Herrmann P, Duscio E, Cipulli F, Moerer O, Marini JJ, Quintel M, Gattinoni L. Positive End-expiratory Pressure and Mechanical Power. *Anesthesiology.* 2019 Jan;130(1):119–130.

Topic: Perioperative care

000574

Tracheostomy weaning and functional outcomes in adult ICU stroke patients: clinical observation from a large London Teaching Hospital

B. H. Azhar¹, R. Davies²

¹Physiotherapy, Kings College Hospital, London, United Kingdom;

²Therapies, King's College Hospital NHS Foundation Trust, London, United Kingdom

Correspondence: B. H. Azhar

Intensive Care Medicine Experimental 2023, **11(Suppl 1)**:000574

Introduction: Use of a tracheostomy is common practice in intensive care units (ICU) to facilitate weaning from mechanical ventilation. Neurological deficits associated with ischaemic and haemorrhagic strokes often require prolonged mechanical ventilation and subsequent tracheostomy insertion [1, 2]. However, the evidence within the literature on functional and weaning outcomes of this cohort of patients is sparse.

Objectives: To determine the functional and weaning outcomes in stroke patients who received a tracheostomy in a large South London teaching hospital.

Methods: A retrospective observational cohort study was conducted of adult ICU patients admitted with a primary diagnosis of a stroke requiring a tracheostomy. Data collected included: type and location of stroke; the number of days from intubation to tracheostomy insertion; number of days from tracheostomy insertion to ventilator liberation and decannulation; number of extubation trials prior to tracheostomy insertion; hospital length of stay (LoS); Glasgow Coma Scale (GCS) at tracheostomy insertion and hospital discharge; Rehab Complexity Scale (RCS) on ICU/hospital discharge; method of transfer from bed to chair at ICU/hospital discharge and discharge destination. Data was collected from the IntelliSpace Critical Care and Anaesthesia information system (Philips healthcare, Murraysville, USA) between 1 November 2021 and 31 November 2022.

Results: Data was collected from 13 patients. Of these, 10 (77%) experienced an ischaemic stroke and 3 (23%) haemorrhagic. Right sided MCA territory strokes were most common (n=5; 38%). 4 (31%) died in hospital.

Median time from intubation to tracheostomy insertion was 13 days (range 7–35). Median time from tracheostomy insertion to ventilator liberation was 25 days (range 8–110). 2 (16%) were decannulated prior to discharge from our hospital. The mean hospital LoS was 74 days (range 15–162). 11 (84%) were tracheotomised without an extubation trial; 2 (16%) failed extubation more than once. Median GCS prior to tracheostomy insertion was 6 (range 3–11), and 10 (range 9–14) on hospital discharge. Median RCS on ICU discharge was 15 (range 13–18), and 14 (range 12–17) on hospital discharge. All patients were dependent on hoist transfers on hospital discharge. 4 patients (31%) were discharged straight to a rehabilitation unit from our hospital. 5 (38%) were repatriated to their local hospital. None were discharged directly home.

Conclusions: Our observed population experienced limited functional improvements and a low occurrence of in hospital tracheostomy decannulation. Due to the repatriation of patients from our hospital, data collection on discharge was limited. Further data collection is required to understand longer term weaning trajectory and functional outcomes of this patient group. Further exploration of the impact of time to tracheostomy formation, stroke severity/location and longer term quality of life could also be of benefit.

References

1. Bösel, J., Niesen, W., Salih, F., Morris, N., Ragland, J., Gough, B., Schneider, H., Neumann, J., Hwang, D., Kantamneni, P. and James, M. (2022) 'Effect of early vs standard approach to tracheostomy on functional outcome at 6 months among patients with severe stroke receiving mechanical ventilation: the SETPOINT2 randomized clinical trial', *JAMA*, 327(19), pp.1899–1909.
2. Robba, C., Bonatti, G., Battaglini, D., Rocco, P. and Pelosi, P. (2019) 'Mechanical ventilation in patients with acute ischaemic stroke: from pathophysiology to clinical practice', *Critical Care*, 23, pp.1–14.
2. n/a

Topic: Neurointensive care

000575

Improving social history taking and frailty assessments for ICU admissions

A. Hagana¹, S. De Soysa¹, A. Nadeem¹, K. Panikkar¹, T. Ali¹

¹Anaesthetics and Critical Care, Stoke Mandeville Hospital, Aylesbury, United Kingdom

Correspondence: A. Hagana

Intensive Care Medicine Experimental 2023, **11(Suppl 1)**:000575

Introduction: Obtaining a thorough social history and frailty assessment is a crucial component of a patient's admission to the intensive care unit (ICU), with frailty associated with prolonged ICU admission, adverse outcomes post-admission as well as poor quality of life on discharge [1–4]. A quality improvement project on improving social

history taking and frailty assessments was undertaken in 2020 for ICU admissions at Buckinghamshire Healthcare NHS Trust, which led to the introduction of a social history proforma that was implemented into the clerking pack. As a result, significant improvements in documentation for social history and frailty assessments were observed. The trust has since transitioned to an online system for documenting medical records and notes within the ICU. This was re-audited to assess whether set standards were being maintained and translated to the online system.

Objectives: To improve the quality of social history and frailty assessment through re-audit and review.

Methods: Data was collected retrospectively on social history and frailty documentation for ICU admissions in September 2022. Forty-one admissions were identified, and their clerking subsequently analysed to assess adherence to the use of the proforma. This was compared to the results of the previous audit cycle to review whether improvement was still observed.

Results: The results prior to proforma introduction and cycle one and two are summarised below:

Table 1 (abstract 000575) Summary of results

	Pre-audit (% documented)	Audit cycle 1 (% documented)	Audit cycle 2 (% documented)
Smoking	15	100	27
Alcohol	10	88	15
Illicit drugs	5	94	10
Occupation	20	100	29
Accommodation	5	94	39
Living alone	80	100	71
Care packages	15	100	44
DNA CPR	20	94	83
Walking ability	55	100	44
Walking aids	47	100	41
Walking distance	11	100	12
Exercise tolerance limitations	0	56	15
Stairs ability	15	100	12
Stair aids	0	71	12
Number of stairs managed	6	78	5
Exercise frequency	5	65	10
Activities of daily living	25	94	34
Clinical Frailty Score	5	94	22

Conclusions: Analysis of the results found that the quality of documentation reduced between cycle one and cycle two across all domains. However, when compared to pre-audit data, documentation improved in 72% of the areas assessed. This suggests that whilst the proforma remains a valuable tool in the documentation of social history and frailty assessments, adherence has declined. This may be due to challenges completing it initially whilst the patient is being admitted, with relevant information not being readily available from the patient themselves or there being no previous documentation. By encouraging doctors to gain a full social history from either the patient or next of kin early in the admission, as well as encouraging other

healthcare professionals such as nurses, physiotherapists and occupational therapists to contribute to completing the proforma, this will allow for a more comprehensive social history and frailty assessment.

References

1. Flaatten H, Guidet B, Andersen FH, Artigas A, Cecconi M, Boumendil A, et al. Reliability of the Clinical Frailty Scale in very elderly ICU patients: a prospective European study. *Annals of Intensive Care*. 2021;11(1):22.
2. Muscedere J, Waters B, Varambally A, Bagshaw SM, Boyd JG, Maslove D, et al. The impact of frailty on intensive care unit outcomes: a systematic review and meta-analysis. *Intensive Care Medicine*. 2017;43(8):1105–22.
3. Jung C, Guidet B, Flaatten H, Fjølner J, Bruno RR, Kelm M, et al. Frailty in intensive care medicine must be measured, interpreted and taken into account! *Intensive Care Medicine*. 2023;49(1):87–90.
4. Bagshaw SM, Stelfox HT, McDermid RC, Rolfson DB, Tsuyuki RT, Baig N, et al. Association between frailty and short- and long-term outcomes among critically ill patients: a multicentre prospective cohort study. *Canadian Medical Association Journal*. 2014;186(2):E95–102.
5. We received no grants for this project.

Topic: Critical care organisation, quality management, information systems, outcomes

000578

Inflammasome caspase-1 signaling drives lung fibrosis in COVID-19 ARDS

P. Konrad¹, C. Feuerborn¹, S. Susanne¹, F. Mario¹, A. Sauer¹, C. Putensen¹, M. Coburn¹, C. Wilhelm², C. Bode¹

¹Department of Anesthesiology and Intensive Care Medicine, University Hospital Bonn, Bonn, Germany; ²Institute of Clinical Chemistry and Clinical Pharmacology, University of Bonn, Bonn, Germany

Correspondence: P. Konrad

Intensive Care Medicine Experimental 2023, **11(Suppl 1)**:000578

Introduction: Pulmonary fibrosis can be a complication of COVID-19 ARDS leading to severely diminished quality and expectancy of life. However, the mechanisms of fibrosis development in COVID-19 ARDS remain unclear. SARS-CoV-2 infections can cause pulmonary inflammation and damage inducing ARDS. This significantly involves inflammasome caspase-1 signaling with interleukin (IL)-1 β and IL-18 production. Inflammasome-caspase-1 activation can promote lung fibrosis in various inflammatory conditions. Thus, we hypothesized that inflammasome-caspase-1 signaling contributes to the fibrotic response in COVID-19 ARDS.

Methods: Bronchoalveolar lavage fluid (BALF) was obtained from non-pulmonary (n = 11) and COVID-19 ARDS (n = 39) patients. BALF cells were incubated ex vivo with the caspase-1 inhibitors tetracycline or VX-765 and examined after 16 h. K18-hACE2 mice were intratracheally infected with SARS-CoV-2. Lungs and BALF were analyzed after 8d. Lung damage, fibrosis-associated mediators, inflammatory cytokines, and caspase-1 were analyzed in human and murine BALF and cell culture supernatants by multiplex immunoassay, ELISA, qRT-PCR and immunoblotting. Lung damage and fibrosis in murine samples were analyzed histologically.

Results: In contrast to non-pulmonary ARDS patients, COVID-19 patients showed significantly increased levels of profibrotic matrix metalloproteinases (MMP) -1, -2, and -7 ($p \leq 0.01$) in the BALF. In addition, fibrosis-associated mediators CC-chemokine ligand-18 ($p < 0.0074$) and plasminogen activator inhibitor type 1 ($p < 0.0189$) as well as N-terminal procollagen I ($p < 0.0001$) concentrations were increased in the lungs of COVID-19 patients. In terms of caspase-1 orchestrated inflammation, we detected higher IL-1 β and IL-18 ($p < 0.0008$; $p < 0.0045$) concentrations in COVID-19 compared to non-pulmonary ARDS patients. Consistent with that, caspase-1 activation was increased ($p < 0.0019$). The correlation between IL-18 and both MMP-2 ($r = 0.8074$; $p < 0.0001$) and SOFA score ($r = 0.6497$; $p < 0.0001$)

suggests a strong association between caspase-1 mediated inflammation, fibrotic response and organ failure in COVID-19.

BALF cells from COVID-19 patients continued producing IL-1 β and IL-18 ex vivo. Tetracycline and VX-765 inhibited IL-1 β and IL-18 production as well as caspase-1 activation ($p \leq 0.0256$). Furthermore, tetracycline limited caspase-1 activation and subsequent IL-1 β and IL-18 production, thereby reducing lung injury ($p < 0.0161$) in SARS-CoV-2 infected mice. Of note, tetracycline reduced collagen I and III mRNA-levels ($p < 0.0296$), the production of profibrotic MMP-9 ($p < 0.0061$) and S100A8/9 proteins ($p \leq 0.0039$). Consistent with these findings, tetracycline treated mice showed reduced pulmonary fibrosis.

Conclusions: Our study demonstrates the close link between caspase-1 activation, disease severity and pulmonary fibrotic response in COVID-19 ARDS patients. In SARS-CoV-2 infected mice, both lung injury and pulmonary fibrotic response were reduced by caspase-1 inhibition. Caspase-1 inhibition should therefore be evaluated as a therapeutic option of COVID-19 ARDS and associated lung fibrosis.

Topic: Acute respiratory failure and mechanical ventilation

000579

Conservative fluid management does not reduce biomarkers of vascular injury in critically ill patients: data from the RADAR-2 randomised control trial

C. McGrath¹, R. McMullan², N. Cody², S. Scannell², J. Conlon³, C. O'kane⁴, D. McAuley⁵, J. A. Silversides⁶

¹Critical Care, Royal Victoria Hospital, Belfast, United Kingdom; ²Critical Care, Wellcome-Wolfson Institute for Experimental Medicine at Queen's University, Belfast, United Kingdom; ³Centre for Experimental Medicine, Queen's University Belfast, Belfast, United Kingdom; ⁴Centre for Infection and, Queen's University Belfast, Belfast, United Kingdom; ⁵University, Queen's University Belfast, Belfast, United Kingdom; ⁶Wellcome Wolfson Institute for Experimental Medicine, Queen's University Belfast, Belfast, United Kingdom

Correspondence: C. McGrath

Intensive Care Medicine Experimental 2023, **11(Suppl 1)**:000579

Introduction: Sepsis is associated with high morbidity and mortality. Administration of intravenous (IV) fluids is advocated by the Surviving Sepsis guidelines [1]. However, IV fluids can induce or exacerbate vascular injury [2, 3], and both greater volumes of administered IV fluid and accumulation of a positive fluid balance are associated with higher mortality in sepsis and other critical illness states [4]. In the Role of Active Deresuscitation After Resuscitation-2 (RADAR-2) trial, 180 critically ill patients were randomised to conservative fluid therapy and deresuscitation or to usual care [5]. This was an exploratory analysis of the RADAR trial.

Objectives: To test the hypothesis that a strategy comprising conservative fluid administration and deresuscitation would lead to a reduction in biomarkers of vascular injury compared to usual care.

Methods: Participants in the RADAR-2 trial were randomised to either a fluid strategy comprising conservative fluid administration and, if fluid overload was present, active deresuscitation; or to usual care. Blood samples were taken at baseline, day 3 and day 5. Plasma levels of angiotensin-2 (usual care—84 patients; intervention 81 patients), hyaluronan (usual care—82 patients; intervention 82 patients) and syndecan-1 (usual care—82 patients; intervention 82 patients) were measured in duplicate using a sandwich enzyme-linked immunosorbent assay (DuoSet, R&D systems). GraphPad Prism version 9.5.1 was used for statistical analysis.

Results: Samples were available for 165 patients, 67 of whom had sepsis. No significant differences were detected between intervention and usual care groups at any of the time points for any biomarker, either in the overall cohort or in the sepsis subgroup (Figure 1).

Conclusions: There was no evidence that a conservative fluid strategy improves vascular injury. Five days of conservative fluid management may be insufficient to mitigate early vascular injury associated with IV fluid administration.

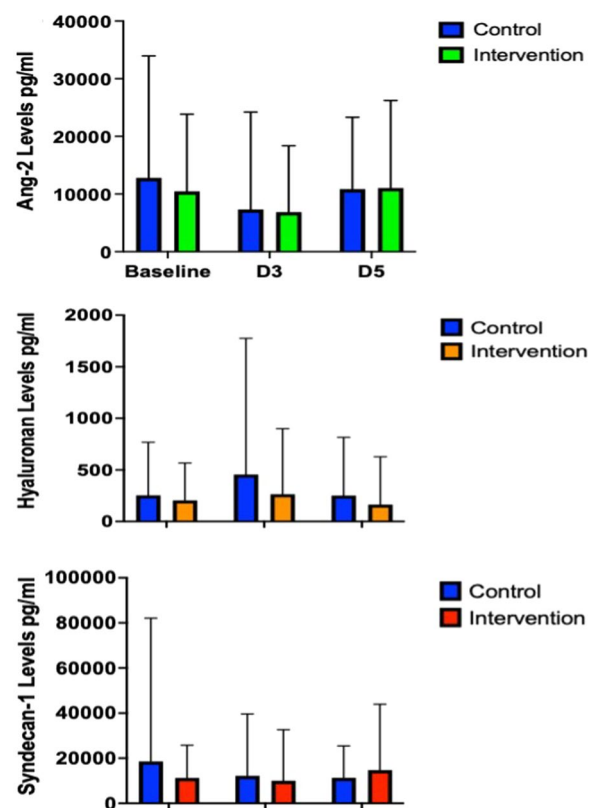

Figure 1 (abstract 000579) Levels of Ang-2, Hyaluronan and Syndecan-1 by group allocation

References

- [5] Silversides, J. A., et al. (2022). "Feasibility of conservative fluid administration and deresuscitation compared with usual care in critical illness: the Role of Active Deresuscitation After Resuscitation-2 (RADAR-2) randomised clinical trial." *Intensive care medicine* 48(2): 190–200.
- [4] Tigabu, B. M., et al. (2018). "Fluid volume, fluid balance and patient outcome in severe sepsis and septic shock: a systematic review." *Journal of critical care* 48: 153–159.
- [3] Hippensteel, J. A., et al. (2019). "Intravenous fluid resuscitation is associated with septic endothelial glycocalyx degradation." *Critical care* 23(1): 1–10.
- [2] Zeng, Y. and J. M. Tarbell (2014). "The adaptive remodeling of endothelial glycocalyx in response to fluid shear stress." *PloS one* 9(1): e86249.
- [1] Evans, L., et al. (2021). "Surviving sepsis campaign: international guidelines for management of sepsis and septic shock 2021." *Intensive care medicine* 47(11): 1181–1247.

Topic: Sepsis

000580

Relationship between SOFA scores and alarm metrics in intensive care units: implications for alarm fatigue

A. Chaoui¹, A. R. Flint¹, K. Rubarth¹, F. Balzer¹, A. S. Poncette¹

¹Institute of Medical Informatics, Charité – Universitätsmedizin Berlin, Berlin, Germany

Correspondence: A. Chaoui

Intensive Care Medicine Experimental 2023, **11(Suppl 1)**:000580

Introduction: Alarm fatigue is a growing concern in intensive care units (ICUs): high number of alarms generated by monitoring systems [1, 2] can lead to desensitization, missed alarms, and delayed responses, compromising patient safety [3, 4]. However, the relationship between clinical conditions and alarms is not yet fully understood. Previous studies linked worse patient conditions to higher alarm loads [5, 6], but they did not use large quantities of alarms for analysis in their study, nor put the number of alarms in relation to the patient's monitoring time. This study aims to provide an extensive evaluation—based on millions of alarms—of the relationship between SOFA scores as a proxy for clinical condition and alarm metrics in ICU patients.

Objectives: Primary objective: assess whether patients with higher SOFA scores generate more alarms than patients with lower scores. Secondary objective: determine if there is a relationship between SOFA scores and alarm response metrics, including the time taken to address an alarm and the frequency of interventions following an alarm.

Methods: After IRB approval (Ethics vote no. EA1/127/18), we extracted alarm metrics, such as number of alarms and alarm duration, from ICU bedside monitoring devices; SOFA scores recorded by clinical staff; and interventions after an alarm based on a set of annotation guidelines [7] for each patient in 15 ICUs in a tertiary care center over a 23-month period. We performed a retrospective analysis and included all SOFA score measurements with at least 1000 vital sign alarms of each type (heart rate (HR), blood pressure (BP), and peripheral oxygen saturation (SpO₂)) for the analysis. We used point plots to visualize the relationships between SOFA scores and mean alarm metrics and calculated Spearman's rank correlation coefficient and tested its statistical significance with a two-tailed test.

Results: We collected 6,143,128 vital sign alarms from 9969 ICU admissions and 77,414 SOFA score entries. We observed a positive relationship between SOFA score and HR alarm rate ($\text{corr} = 0.856$, $p < 0.001$), but no statistically significant relationship to SpO₂ alarm rate ($\text{corr} = -0.385$, $p = 0.115$) and a negative relationship to BP alarm rate ($\text{corr} = -0.542$, $p = 0.020$) (Fig. 1a). For the rate of actionable alarms, we observed a positive relationship to the SOFA score for all 3 alarm types: HR ($\text{corr} = 0.897$, $p < 0.001$); BP ($\text{corr} = 0.996$, $p < 0.001$) and SpO₂ ($\text{corr} = 0.839$, $p = 0.000$). The rate of interventions increased by almost threefold for BP and SpO₂ alarms, while only increasing by less than twofold for HR alarms (Fig. 1b). For alarm duration, we observed a negative relation to the SOFA score with: HR ($\text{corr} = -0.942$, $p < 0.001$); BP ($\text{corr} = -0.942$, $p < 0.001$) and SpO₂ ($\text{corr} = -0.944$, $p < 0.001$). For all three alarm types, the mean alarm duration reached almost half the time for patients with high SOFA scores in comparison to patients with lower SOFA scores (Fig. 1c).

Conclusions: Our study highlights the limited research on the relationship between patient characteristics and alarms in the ICU. We show that there is a complex relationship between the SOFA score and alarm metrics in the ICU. Contrary to our hypothesis, our results suggest that there is no clear increase in the number of alarms with a more severe SOFA score. While we observed a strong positive relationship for HR alarms, there was no statistically significant positive relationship for SpO₂ alarms and, surprisingly, a negative relationship for BP alarms. However, we observed a reduction in alarm response time and an increase in the rate of interventions following alarms, suggesting that healthcare providers become more responsive to alarms from patients with worse clinical conditions, possibly because of the greater risk of clinical deterioration. The almost constant rate of alarms produced across the whole range of SOFA scores may be caused by alarm settings and thresholds being adjusted more adequately for these patients, resulting in fewer alarms being generated. The observed increase in heart rate alarm rates, possibly representing worse alarm management, could also be the reason why the rate of interventions doesn't increase as much in comparison to the other investigated alarm types. These findings have implications for optimizing alarm systems in the ICU, as they suggest that a more nuanced approach is needed to ensure that alarms are effective in identifying life-threatening situations while minimizing alarm fatigue.

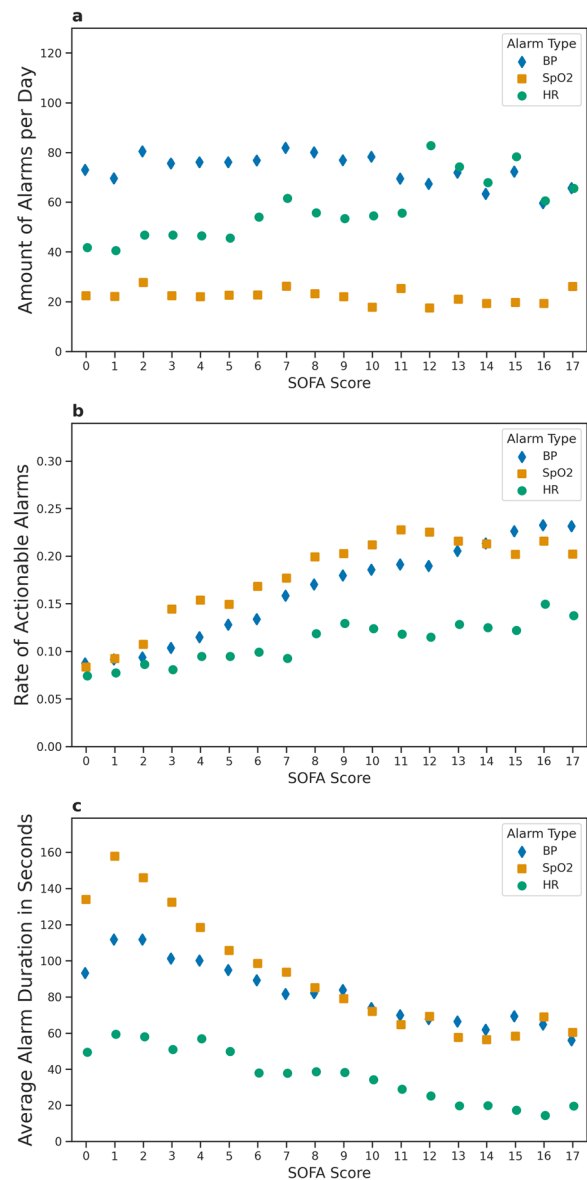

Figure 1 (abstract 000580) Point plot showing the relationship between the SOFA score and multiple alarm metrics presented for blood pressure (BP), heart rate (HR), and peripheral oxygen saturation (SpO₂) alarms: a) Amount of alarms produced per day; b) Rate of clinical interventions after an alarm; c) Average alarm duration

References

1. INALO project (grant 16SV8559, German Federal Ministry of Education and Research)
2. [1] Hravnak M, Pellathy T, Chen L, et al. A call to alarms: Current state and future directions in the battle against alarm fatigue. *J Electrocardiol.* 2018;51(6S):S44-S48. <https://doi.org/10.1016/j.jelectrocard.2018.07.024>
3. [2] Schmid F, Goepfert MS, Reuter DA. Patient monitoring alarms in the ICU and in the operating room. *Crit Care.* 2013;17(2):216. Published 2013 Mar 19. <https://doi.org/10.1186/cc12525>
4. [3] Sendelbach S, Funk M. Alarm fatigue: a patient safety concern. *AACN Adv Crit Care.* 2013;24(4):378-388. <https://doi.org/10.1097/NCI.0b013e3182a903f9>

5. [4] Johnson KR, Hagadorn JI, Sink DW. Alarm Safety and Alarm Fatigue. *Clin Perinatol.* 2017;44(3):713–728. <https://doi.org/10.1016/j.clp.2017.05.005>
6. [5] Sinno ZC, Shay D, Kruppa J, et al. The influence of patient characteristics on the alarm rate in intensive care units: a retrospective cohort study. *Sci Rep.* 2022;12(1):21801. Published 2022 Dec 16. <https://doi.org/10.1038/s41598-022-26261-4>
7. [6] Inokuchi R, Sato H, Nanjo Y, et al. The proportion of clinically relevant alarms decreases as patient clinical severity decreases in intensive care units: a pilot study. *BMJ Open.* 2013;3(9):e003354. Published 2013 Sep 10. <https://doi.org/10.1136/bmjopen-2013-003354>
8. [7] Klopfenstein SAI, Flint AR, Heeren P et al. How to Annotate Patient Monitoring Alarms in Intensive Care Medicine for Machine Learning, 14 February 2023, PREPRINT (Version 1) available at Research Square [<https://doi.org/10.21203/rs.3.rs-2514969/v1>]. Accessed 13/04/2023

Topic: Critical care organisation, quality management, information systems, outcomes

000581

Octane in exhaled breath to diagnose acute respiratory distress syndrome in invasively ventilated intensive care unit patients

L. Hagens¹, N. Heijnen², M. Smit¹, A. Verschueren³, T. Nijsen³, I. Geven³, C. Presurá³, R. Rietman³, D. Fenn⁴, P. Brinkman⁴, M. Schultz¹, D. Bergmans², R. Schnabel², L. Bos¹

¹Department of Intensive Care, Amsterdam UMC, locatie AMC, Amsterdam, Netherlands; ²Department of Intensive Care, Maastricht UMC+, Maastricht, Netherlands; ³Research, Philips Research, Global Headquarters, Eindhoven, Netherlands; ⁴Department of Respiratory Medicine, Amsterdam UMC, locatie AMC, Amsterdam, Netherlands

Correspondence: L. Hagens

Intensive Care Medicine Experimental 2023, **11(Suppl 1)**:000581

Introduction: The concentration of exhaled octane has been postulated as a reliable biomarker of acute respiratory distress syndrome (ARDS) using metabolomics analysis with gas chromatography mass spectrometry (GC–MS) [Bos, ERJ 2014]. A point-of-care (POC) breath test was developed in recent years to accurately measure octane at the bedside [Hagens, Analyst 2021].

Objectives: To validate the diagnostic accuracy of exhaled octane for ARDS using a POC test in invasively ventilated intensive care unit (ICU) patients.

Methods: This was an observational cohort study of consecutive patients receiving invasive ventilation for at least 24 h, recruited in two university ICUs. GC–MS and POC tests were used to quantify the exhaled octane concentration. ARDS was assessed by three experts following the Berlin definition and used as reference standard. The area under the receiver operating characteristics curve (AUROCC) was used to assess diagnostic accuracy. As a secondary endpoint the added value of the breath test on top of the Lung Injury Prediction Score (LIPS) was assessed.

Results: 519 patients were included and 190 (37%) fulfilled the criteria for ARDS. The concentration of octane using the POC breath test was not significantly different between patients with ARDS (0.14 ppb; IQR: 0.05–0.37) and without ARDS (0.11 ppb; IQR: 0.06–0.26; $P=0.64$). The AUROCC for ARDS based on the octane concentration in exhaled breath using the POC breath test was 0.52 (95% confidence interval (CI): 0.46–0.57, Figure 1 panel A). Analysis of exhaled octane with GC–MS showed similar results, (AUROCC 0.53; CI: 0.48–0.59; Figure 1, panel B). Combining LIPS with the octane concentration increased the AUROCC to 0.66 (CI: 0.62–0.71) and 0.67 (CI: 0.62–0.72) for the POC test and GC–MS respectively.

Conclusions: Octane in exhaled breath has insufficient diagnostic accuracy for ARDS. This disqualifies the use of octane as a biomarker in the diagnosis of ARDS and challenges most of the research performed up to now in the field of exhaled breath metabolomics.

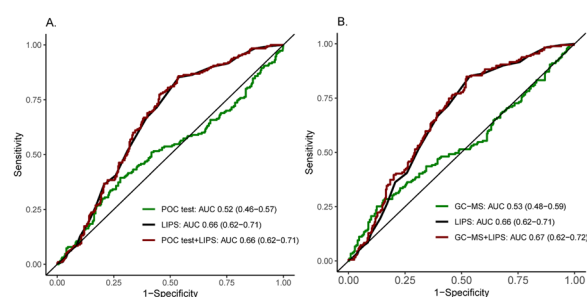

Figure 1 (abstract 000581) Panel A, AUROCC curves describing the diagnostic accuracy for the octane concentration measured with the POC breath test and LIPS for ARDS. Panel B, AUROCC curves describing the diagnostic accuracy for the octane concentration measured with the GC–MS and LIPS for ARDS

References

1. L. D. J. Bos et al., “Exhaled breath metabolomics as a noninvasive diagnostic tool for acute respiratory distress syndrome,” *Eur. Respir. J.*, vol. 44, no. 1, pp. 188–197, 2014.
2. Summary conflict of interest statements: LDJB reports grants from: Dutch lung foundation (Young investigator grant), Dutch lung foundation and Health Holland (Public–Private Partnership grant), Dutch lung foundation (Dirkje Postma Award), IMI COVID19 initiative, grants from Amsterdam UMC fellowship, ZonMW COVID-19 Urgency grant, ERS Gold Metal for ARDS. LDJB reports participating in an advisory board for Sobi, Exvastat, Santhera, Pfizer and Astra Zeneca, all paid to institution. LDJB reports consultancy for Scailyte, Santhera and Janssen en Janssen, all paid to institution, outside the submitted work. ARMV, TMEN, IG, CNP and RR are employees at Philips Research. LAH, NFLH, MRS, DWF, PB, MJS, DCJJB, and RMS have no conflict of interest regarding this manuscript. Funding information: This study was funded by Health Holland and the Dutch Lung Fund.
3. L. A. Hagens et al., “Development and validation of a point-of-care breath test for octane detection,” *Analyst*, vol. 146, no. 14, pp. 4605–4614, 2021.

Topic: Acute respiratory failure and mechanical ventilation

000583

Comparative effectiveness of dexamethasone, methylprednisolone, and prednisolone in hospitalized patients with COVID-19

T. Gondo¹, I. Osawa¹, Y. Miyamoto², K. Okamoto³, M. Hayakawa⁴, T. Tagami⁵, K. Doi¹

¹Emergency and Critical Care Medicine, The University of Tokyo Hospital, Tokyo, Japan; ²Nephrology, The University of Tokyo, Tokyo, Japan;

³Infectious Disease, The University of Tokyo Hospital, Tokyo, Japan;

⁴Department of Emergency Medicine, Hokkaido University Hospital, Hokkaido, Japan;

⁵Critical Care Medicine and Emergency Medicine, Nippon Medical School Musashi Kosugi Hospital, Kanagawa, Japan

Correspondence: T. Gondo

Intensive Care Medicine Experimental 2023, **11(Suppl 1)**:000583

Introduction: International guidelines recommend the use of dexamethasone for patients with severe or critical COVID-19 [1, 2]. If dexamethasone is not available, other corticosteroids at doses equivalent to 6 mg dexamethasone daily may be helpful [1, 2]. A recent study suggested that dexamethasone, rather than methylprednisolone, is beneficial in acute respiratory distress syndrome (ARDS) due to its potent anti-inflammatory and weak mineralocorticoid effects [3, 4]. However, little is known about the efficacy of other corticosteroids compared with 6 mg dexamethasone in COVID-19 [5, 6].

Objectives: To compare the efficacy of dexamethasone, methylprednisolone, and prednisolone in patients with severe COVID-19.

Methods: This retrospective cohort study used a nationwide registry of hospitalized patients with COVID-19 from 66 hospitals in Japan

from January 2020 to September 2020 [7]. We identified patients with severe COVID-19 (defined as $SpO_2 \leq 94\%$ on ambient air and imaging findings of pneumonia) who were treated with one of the following corticosteroids: dexamethasone, methylprednisolone, and prednisolone. Corticosteroid treatments equivalent to pulsed corticosteroid therapy were excluded. The primary and secondary outcomes were all-cause in-hospital mortality and the composite of mechanical ventilation use and in-hospital mortality, respectively. We evaluated the associations between the use of each corticosteroid and each outcome using inverse probability-weighted (IPW) analyses based on multiple propensity scores to adjust for potential confounders (e.g., age, sex, Charlson Comorbidity Index [CCI] score, sequential organ failure assessment [SOFA] score, and PaO_2/FiO_2 ratio [PFR]) at admission [8–10].

Results: Of 347 patients eligible for analysis, 258 (74.3%) were male and the median age was 65. 259 (74.6%), 27 (7.8%), and 61 (17.6%) patients were treated with dexamethasone, methylprednisolone, and prednisolone, respectively. Adjusted for multiple propensity scores, there were no significant differences in in-hospital mortality among the three groups (e.g., risk difference of methylprednisolone vs. dexamethasone: +3.7%; 95% confidence interval [CI] –9.2 to +16.7%) (Figure A). However, the risk of the composite outcome of mechanical ventilation use and in-hospital mortality was significantly higher in the prednisolone group (risk difference of prednisolone vs. dexamethasone: +16.4%; 95% CI +1.3 to +31.6%) than in the dexamethasone group (Figure B). We observed higher risk of the composite outcome in the methylprednisolone group (risk difference of methylprednisolone vs. dexamethasone: +11.6%; 95% CI –9.9 to +33.1%) than in the dexamethasone group, although the effect estimate was statistically imprecise with a wide CI.

Conclusions: In patients with severe COVID-19, methylprednisolone and prednisolone could serve as alternative agents to dexamethasone. However, prednisolone was associated with increased use of mechanical ventilator, possibly attributable to its mineralocorticoid effect.

Figure A In-hospital mortality

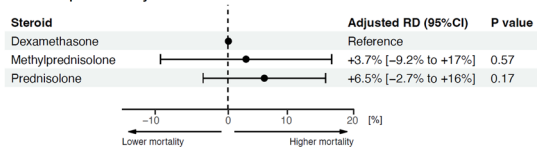
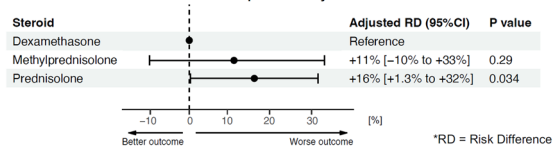

Figure B Mechanical ventilator use and in-hospital mortality



Risk difference in A. All-cause in-hospital mortality B. the composite of Mechanical ventilator use and in-hospital mortality. Adjusted risk differences in outcomes were estimated using inverse probability-weighted (IPW) analysis based on multiple propensity scores. (Dexamethasone as a reference). Abbreviations: RD, risk difference; CI, confidence interval.

References

2. World Health Organization. Corticosteroids for COVID-19: Living guidance. (2020) <https://www.who.int/publications/item/WHO-2019-nCoV-Corticosteroids-2020.1> (Accessed April 5, 2023).
1. Alhazzani W, Evans L, Alshamsi F, et al. Surviving Sepsis Campaign Guidelines on the Management of Adults With Coronavirus Disease 2019 (COVID-19) in the ICU: First Update. *Crit Care Med.* 2021;49(3):e219–e234.
- All authors have no conflicts of interest to declare.
9. Chen SW, Chan YH, Lin CP, et al. Association of Long-term Use of Antihypertensive Medications With Late Outcomes Among Patients With Aortic Dissection. *JAMA Netw Open.* 2021;4(3):e210469.

8. George MD, Baker JF, Winthrop K, et al. Risk for Serious Infection With Low-Dose Glucocorticoids in Patients With Rheumatoid Arthritis: A Cohort Study. *Ann Intern Med.* 2020;173(11):870–878.
7. Tagami T, Yamakawa K, Endo A, Hayakawa M, Ogura T, Hirayama A, et al. Japanese multicenter research of COVID-19 by assembling real-world data: a study protocol. *Ann Clin Epidemiol.* 2022; 4(3): 92–100.
6. Taher A, Lashkari M, Keramat F, et al. Comparison of the efficacy of equivalent doses of dexamethasone, methylprednisolone, and hydrocortisone for treatment of COVID-19-related acute respiratory distress syndrome: a prospective three-arm randomized clinical trial. *Wien Med Wochenschr.* 2023;173(5–6):140–151.
4. Lemieux SM. Standardising corticosteroid use in acute respiratory distress syndrome. *Lancet Respir Med.* 2022;10(12):e109.
10. Burgette L, Griffin BA, and McCaffrey D. Propensity scores for multiple treatments: A tutorial for the mnps function in the twang package. (2021) Available online: <https://cran.r-project.org/web/packages/twang/vignettes/mnps.pdf> (Accessed April 5, 2023).
3. Villar J, Ferrando C, Martínez D, et al. Dexamethasone treatment for the acute respiratory distress syndrome: a multicentre, randomised controlled trial. *Lancet Respir Med.* 2020;8(3):267–276.
5. Du Plessis EM, Lalla U, Allwood BW, et al. Corticosteroids in critical COVID-19: Are all corticosteroids equal? *S Afr Med J.* 2021;111(6):550–553.

Topic: Acute respiratory failure and mechanical ventilation

000584

Evaluation of antibiotics consumption and ICU stay in our Intensive Care Unit over the years

V. Losada Martínez¹, N. Cruza Leganés¹, F. Arbol Linde¹, D. Fuentes Scott¹, B. García Esteban², M. A. Taberna Izquierdo¹

¹Intensive Care Unit, University General Hospital Nuestra Señora del Prado, Talavera de la Reina, Spain; ²Hospital Pharmacy, University General Hospital Nuestra Señora del Prado, Talavera de la Reina, Spain

Correspondence: V. Losada Martínez

Intensive Care Medicine Experimental 2023, **11(Suppl 1)**:000584

Introduction: Monitoring the consumption of antibiotics is necessary in services with a high demand, such as the Intensive Care Unit (ICU). The use of these antibiotics has changed over the years, being the global pandemic by COVID 19 one of the events that has a greater influence on the increase of patients in our ICUs, as well as the widespread use of empirical antibiotic therapy in COVID patients. Other epidemics and the change in antibiotic resistance also influence this change.

Objectives: To evaluate the consumption of antibiotics between 2018 and 2022 in a multipurpose ICU, differentiating 3 periods: pre-pandemic, pandemic and post-pandemic. It's also analyzed the stay in the ICU, the variation that they have suffered over the years and the consumption with stays.

Methods: Retrospective descriptive observational study of the consumption of antibiotics in a 12-bed ICU, expanded to 24 beds with the pandemic, during the years 2018 to 2022. The consumption of antibiotics and stays in the ICU Service are collected. The following are analyzed: the defined daily dose (DDD: consumption (gr) × 100/DDD–WHO × stays) per stay (S) in the ICU) of the most used antibiotics, stays in the ICU per year, the DDD/100S in ICU by family of antibiotics and by most used antibiotics.

Results: The stay in our ICU was: 2018: 1818, 2019: 1915, 2020: 3801, 2021: 4173, 2022: 2638, which represents a variation in stays compared to the previous year of: 2019: 5.34%; 2020: 98.49%; 2021: 9.79%; 2022: –36.78% respectively.

In terms of the antibiotics with the highest consumption per year (DDD): 2018: Levofloxacin (LVF), Meropenem (MPN) and Linezolid (LZD); 2019: MPN, LVF and LZD; 2020: MPN, Ceftriaxone (CFX) (COVID 19 treatment) and LZD; 2021: MPN, LZD, Tigecycline (TGC) (*Acinetobacter baumannii* outbreak); 2022: MPN, LZD and LVF.

Regarding to antibiotic consumption (by groups) and ICU stay (Table 1):

AB 2018	DDD/100S 2018	AB 2019	DDD/100S 2019	AB 2020	DDD/100S 2020	AB 2021	DDD/100S 2021	AB 2022	DDD/100S 2022
Global consumption	188,88	Global consumption	212,21	Global consumption	237,24	Global consumption	199,13	Global consumption	192,49
Quinolones	47,58	Carbapenems	44,89	Carbapenems	45,96	Carbapenems	41,76	Other (linezolid)	41,38
Penicillins	40,14	Quinolones	41,06	Macrolides	45,00	Cephalosporins	33,82	Carbapenems	40,60
Carbapenems	40,11	Penicillins	34,99	Cephalosporins	39,52	Other (linezolid)	30,81	Cephalosporins	27,22

with a variation in such consumption compared to the previous year (DDD/100S total): 2019: 12.35%; 2020: 11.79%; 2021: – 16.06% and 2022: – 3.33%.

Conclusions: The COVID 19 pandemic increased the stay in the ICU by 98.49% in 2020, decreasing 36,78% in 2022. During those two years (pandemic), the most used antibiotics in our ICU changed. By connecting antibiotic consumption to hospital stay, the greatest increase occurs in 2020 where macrolides and cephalosporins appear among the most frequent antibiotics. In 2022 it decreases to similar values to pre-pandemic.

Topic: Infections and prevention

000586

Association between COVID-19 vaccination and mortality of COVID-19 pneumonia hospitalized in Intensive Care Unit during the COVID-19 pandemic

S. Ruangchan¹, S. Krudphu¹, P. Saengsanga², N. Kiamkan¹
¹Internal Medicine, Songkhla Hospital, Songkhla Province, Thailand;
²Critical Care Unit, Songkhla Hospital, Songkhla Province, Thailand

Correspondence: S. Ruangchan
 Intensive Care Medicine Experimental 2023, 11(Suppl 1):000586

Introduction: COVID-19 is a very high-transmission disease with a variable prognosis in the general population. Higher risks of severe disease were found in older individuals and with underlying health conditions (1). COVID-19 vaccination has substantially altered the course of the pandemic and its severity, lower mortality in critically ill COVID-19 pneumonia (2, 3).

Objectives: To evaluate the association between COVID-19 vaccination and mortality among COVID-19 pneumonia who were admitted to Intensive Care Unit (ICU) and needed mechanical ventilator support.

Methods: A retrospective, cross-sectional study was conducted in Songkhla Provincial Hospital, a 508-bed hospital, in Southern Thailand. All patients (≥ 15 years old) with a presumptive or confirmed diagnosis of COVID-19 pneumonia (4) who were admitted to the ICU and needed invasive or non-invasive mechanical ventilators from January 2021 to December 2022 were enrolled. Baseline patients' characteristics, COVID-19 Vaccine status, clinical manifestations, treatment, and outcome were collected from the medical records.

Results: A total of 224 patients were included in the study. Mean age, 65.95 ± 16.57 years, 124 (55.4%) were men, 158 (70.5%) were older than 60 years old, 209 (93.3%) has at least one co-morbid medical conditions including diabetes 37.9%, heart disease 23.7%, chronic kidney disease 20.1%, history of cerebrovascular disease 13.4%, chronic lung disease 12.1%, obesity (BMI ≥ 30) 10.3% and immunocompromised patient 9.3%. Only 54 (24.1%) completed 2 doses of the primary COVID-19 vaccination series more than 14 days before admission. The overall hospital mortality was 131 (58.5%), factors influencing mortality were older age (61.57 ± 18.16 years in the survival group

VS 69.06 ± 14.62 years in the non-survival group; *p-value* < 0.001), at least one medical condition 87.1% in survival group VS 97.7% in the non-survival group; *p-value* < 0.027 and initial palliative care condition in survival group 1.1% VS 19.1% in non-survival group *p-value* < 0.001. Multivariate analysis showed at least 2 doses of the COVID-19 vaccine were significantly associated with lower mortality compared with controls (110 of 170 patients [64.7%] died in the control group VS 21 of 54 [38.9%] in the full vaccination group; adjusted OR, 0.26 [95% CI, 0.11–0.6]; *p-value* = 0.002) and decrease day of non-invasive ventilator support 3 (3, 5) in control group VS 2 (2, 3) in full vaccination group *p-value* = 0.03, but not decrease in length of hospital stay and day of invasive ventilator support. Patients with ≥ 3 risk factors were significantly increasing mortality, adjusted OR 7.36 [95% CI, 1.28–42.28]; *p-value* = 0.025.

Conclusions: At least 2 doses of COVID-19 vaccination is a significant protective factor in preventing deaths due to COVID-19 pneumonia hospitalized in an Intensive care Unit.

Univariate and Multivariate logistic regression analysis Factor Influence mortality in COVID-19 pneumonia among ICU hospitalization during covid pandemic

variable	Univariate		Multivariate	
	OR (95%CI)	p-value	Adjusted OR (95%CI)	p-value
Age				
<40	Reference	1	Reference	1
40-49	6.4 (1.57, 26.03)	0.01*	5.95 (1.24, 28.58)	0.026*
50-59	3.45 (0.98, 12.1)	0.054	3.32 (0.8, 13.82)	0.099
60-69	4.22 (1.34, 13.28)	0.014*	3.3 (0.82, 13.19)	0.092
70-79	5.89 (1.87, 18.6)	0.002*	5.77 (1.45, 22.99)	0.013*
≥/80	6.78 (2.13, 21.57)	0.001*	5.56 (1.37, 22.59)	0.016*
Refer in from community hospital	0.59 (0.35, 1.01)	0.055	0.57 (0.3, 1.09)	0.087
Number of co-morbidities				
0	Reference	1	Reference	1
1	6.17 (1.57, 24.16)	0.009*	5.45 (1.19, 25.07)	0.029*
2	5.62 (1.48, 21.33)	0.011*	3.37 (0.69, 16.44)	0.133
3	10.8 (2.51, 46.43)	0.001*	7.36 (1.28, 42.28)	0.025*
4	5 (1.04, 24.03)	0.045*	2.7 (0.39, 18.68)	0.313
5	4 (0.39, 41.23)	0.244	6.88 (0.46, 102.29)	0.161
Initial palliative cases	21.7 (2.88, 163.27)	0.003*	25.3 (2.72, 235.33)	0.005*
Number of COVID-19 Vaccination				
No	Reference	1	Reference	1
1 dose of vaccine	1.88 (0.71, 5)	0.206	2.11 (0.67, 6.66)	0.201
2 doses of the primary series	0.31 (0.15, 0.62)	0.001*	0.26 (0.11, 0.6)	0.002*
3 doses of covid vaccine	0.89 (0.24, 3.3)	0.862	0.87 (0.2, 3.79)	0.853

References

1. I would like to thank the Intensive Care Unit team, who give the best care to all patients
2. Watson OJ, Barnsley G, Toor J, Hogan AB, Winskill P, Ghani AC. Global impact of the first year of COVID-19 vaccination: a mathematical modeling study. The Lancet Infectious diseases. 2022;22(9):1293–302.

3. 1. Clark A, Jit M, Warren-Gash C, Guthrie B, Wang HHX, Mercer SW, et al. Global, regional, and national estimates of the population at increased risk of severe COVID-19 due to underlying health conditions in 2020: a modeling study. *The Lancet Global health*. 2020;8(8):e1003-e17
4. 4. Coronavirus Disease 2019 (COVID-19) 2021 Case Definition: Division of Health Informatics and Surveillance, Centers for Disease Control and Prevention; 2021 [Available from: <https://ndc.services.cdc.gov/case-definitions/coronavirus-disease-2019-2021>].
5. 3. Grapsa E, Adamos G, Andrianopoulos I, Tsolaki V, Giannakoulis VG, Karavidas N, et al. Association Between Vaccination Status and Mortality Among Intubated Patients With COVID-19-Related Acute Respiratory Distress Syndrome. *JAMA network open*. 2022;5(10):e2235219.

Topic: Infections and prevention

000587

Infective endocarditis at ICU admission

J. M. Bonell-Goytisolo¹, C. March Cladera¹, T. J. Leal Rullan¹, O. Bonnin Gubianes², M. Picornell Noguera¹, N. Suárez Rovira¹
¹ICU, Hospital Quirónsalud Palmaplanas, Palma, Spain; ²Cardiac Surgery, Hospital Quirónsalud Palmaplanas, Palma, Spain

Correspondence: J. M. Bonell-Goytisolo

Intensive Care Medicine Experimental 2023, **11(Suppl 1)**:000587

Introduction: Infective endocarditis (IE) remains a very serious clinical identity in intensive care unit (ICU) although its frequency is lower than other acute infections. Complications of IE are often severe and can put the patient in a critical situation which requires ICU assistance.

Objectives: To analyze all cases with IE whose complications were the main reason for ICU admission.

Methods: Retrospective study of 20 patients recorded between 2011 and 2021, in all them IE was the main reason for admission in ICU and its diagnosis was established during their ICU stay following basically modified Duke criteria. Transesophageal echocardiography, as well as transthoracic, was routinely performed. Our ICU has 16 boxes and treat patients with many different pathologies, including cardiac surgery.

Results: Mean age was 60 years, IE diagnosis was established at day 4 of average after admission. Nine patients came from the emergency, 8 from hospital ward, 2 from other hospitals and 1 from surgery area. Heart failure (55%) was the most common admission reason, followed by ischemic stroke (20%), septic shock (15%), spondylitis and embolic myocardial infarction. Sixty percent of patients had fever on the first 48 h hours, and during their evolution 65% suffered from heart failure and 60% from shock. Eight patients (40%) had embolic events (cerebral, coronary, spinal, splenic). In 6 cases origin was nosocomial or related to health system (patients with previous sepsis, renal insufficiency, cancer). Most common microbial etiology were grampositive (65%, specially *Staphylococcus aureus*), in 30% cultures were negative. No multiresistant microorganisms were isolated. Aortic valve was the single affected in 45%, mitral in 40% and both in 15%. No cases of right endocarditis, pacemaker or valvular prosthesis infections were recorded. Surgery was performed in 55%, 6 days of average after diagnosis. Hospital mortality was 40% (8 cases), in almost all (7) surgery could not be made. 6 months later after diagnosis, among 12 patients who survived 5 were asymptomatic, 4 with minor neurological deficits in recovery process and in 3 cases no information was registered (foreign tourists repatriated to their home land).

Conclusions: Possibility of IE should always be suspected in the presence of some clinical situations as heart failure or acute ischemic stroke in order to begin proper therapy as soon as possible. Mortality is high and complications are frequent.

References

1. Leroy, O., Georges, H., Devos, P. et al. Infective endocarditis requiring ICU admission: epidemiology and prognosis. *Ann. Intensive Care* 5, 45 (2015). <https://doi.org/10.1186/s13613-015-0091-7>
2. Wang, A., Gaca, JG., Chu, VH. Management considerations in Infective Endocarditis: A Review. *JAMA* 2018; 320:72.

Topic: Infections and prevention

000588

Determinants of vascular leakage after cardiac arrest

E. Guérin¹, A. Rutault², I. Marangon², C. Desnos², P. L. Tharoux³, A. Combes⁴, S. Germain², N. Brechot¹

¹Medical ICU, European Hospital Georges Pompidou, Paris, France;

²INSERM U1050, Collège de France, Paris, France; ³INSERM U970, Paris

Research Center Cardiovascular - Inserm University Paris City, Paris, France;

⁴Service de médecine intensive-réanimation, ican, institut de cardiologie, University Hospitals Pitié Salpêtrière - Charles Foix, Paris, France

Correspondence: N. Brechot

Intensive Care Medicine Experimental 2023, **11(Suppl 1)**:000588

Introduction: Although vascular leakage is a major feature of systemic inflammatory response syndrome associated with shocks, its molecular mechanisms remain poorly characterized in humans. RNAseq analysis of circulating monocytes, performed in 11 patients after resuscitated cardiac arrest, revealed 860 genes that were differentially expressed between patients with and without massive vascular leakage. Ingenuity® pathway analysis identified clusters of genes related to (i) inflammation, (ii) Hypoxia-Inducible Factor-induced angiogenesis, and (iii) cell cycle regulation. Thirty-eight genes were retained after correction for false discovery rate. Among them, a gene coding for a protein P (protein with an ongoing patent protection), ligand of a receptor involved in vascular biology, had a 56 times higher expression in patients with massive leakage. In accordance, plasma levels of P-PROTEIN were found strongly associated with the level of vascular leak in an independent validation cohort of 52 post-cardiac arrest patients. The objective of the study was to test the hypothesis that P-PROTEIN may play a role during cardiac arrest induced vascular leakage.

Methods: We first set up a model of resuscitated cardiac arrest in mice, with a no-flow and a low-flow time of 8 min each. Survival and vascular leakage were then compared after cardiac arrest between *P-protein* knock-out (KO), wild-type (WT) mice, and WT mice injected with recombinant mouse P-PROTEIN (rmP-PROTEIN) at the time of resuscitation (after the no-flow). Vascular leakage was compared between conditions using i.v. injected fluorescent dextrans.

Results: We confirmed an important vascular leak in all organs after the return of spontaneous circulation (ROSC) in WT mice, and an induction of circulating P-PROTEIN levels at one-hour post-ROSC. Intra-venous injection of rmP-PROTEIN significantly reduced the vascular leakage quantified by extravasation of fluorescent dextrans. Survival was also significantly affected by modulating P-PROTEIN activity. We demonstrated a beneficial effect of rmP-PROTEIN injection, with 88% of ROSC in WT mice injected with rmP-PROTEIN vs. 67% in controls and an improved survival in rmP-PROTEIN injected mice vs controls (Figure 1). The proportion of mice achieving a ROSC was on the contrary strongly reduced in *P-protein* KO mice compared to their WT littermates (10%, $p < 0.0001$ vs. WT).

Conclusions: These results demonstrate that the P-PROTEIN, isolated from observations in human, is a key regulator of post-cardiac arrest vascular leakage, with beneficial effects on vascular leakage and survival of P-PROTEIN gain of function in mice. Further experiments are ongoing to characterize its mechanisms on vascular leakage, as well as its optimal dosing regimen in a pre-clinical setting.

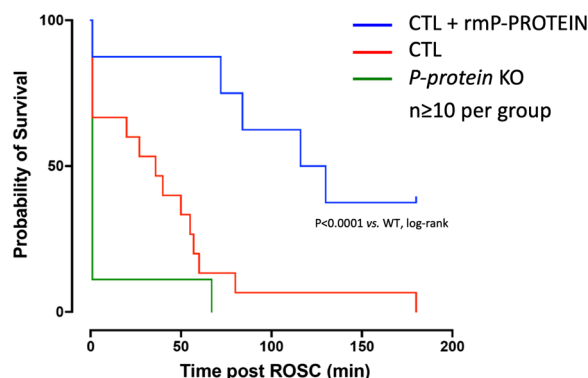

Figure 1 (abstract 000588) Survival after cardiac arrest of wild-type mice, *p-protein* KO mice, and wild type mice injected with recombinant mouse P-PROTEIN at the time of resuscitation

Topic: Cardiac arrest

000589

Predictors of circuit coagulation in continuous blood purification therapy for septic AKI

M. Akatsuka¹, H. Tatsumi¹, Y. Nakamura², S. Chihara³, Y. Masuda¹
¹Department of Intensive Care Medicine, Sapporo Medical University School of Medicine, Sapporo, Japan; ²Division of Clinical Engineering, Sapporo Medical University Hospital, Sapporo, Japan; ³Department of Clinical Engineering, Japan Health Care University Faculty of Health Sciences, Sapporo, Japan

Correspondence: M. Akatsuka

Intensive Care Medicine Experimental 2023, **11(Suppl 1)**:000589

Introduction: Continuous blood purification (CBP) is an essential therapeutic modality in an intensive care setting that is used to remove accumulated fluid and waste products in patients with acute kidney injury (AKI) and to remove chemical mediators in sepsis. However, it is often necessary to change the CBP circuit in a short time. Circuit coagulation in CBP reduces the filtration function of the hemofilter, and frequent coagulation necessitates circuit replacement, resulting in problems such as downtime and insufficient blood purification volume due to the interruption of CBP. Although there have been several reports on predictors of CBP lifetime, these have not yet been clarified.

Objectives: The aim of this study was to clarify variables as predictors of circuit coagulation in CBP for septic AKI patients.

Methods: We carried out a retrospective observational study. The study subjects were patients with septic AKI who were admitted to the ICU and received renal replacement therapy during the period from January 2012 to December 2020. The definition of sepsis was according to Sepsis-31) and AKI was defined by the KDIGO guidelines2). We obtained information on the characteristics of patients including age and sex, SOFA score, APACHE II score, focus of infection, length of ICU stay, shock, number of ventilation days, circuit coagulation, KDIGO classification, and disseminated intravascular coagulopathy (DIC) as well as laboratory data. We performed multivariate logistic regression analyses to clarify the predictive factors for circuit coagulation and calculated the cut-off value from the ROC curve.

Results: A total of 126 patients were included and 64 patients were excluded due to the exclusion criteria. Sixty-two patients were eligible for the study. Circuit coagulation occurred in 41.9% of the patients. Platelet count was significantly lower in the circuit coagulation group than in the non-coagulation group ($p = 0.002$). The circuit coagulation group also had a higher incidence of DIC than that in the

non-coagulation group ($p = 0.013$). Platelet count was found to be a predictive factor for circuit coagulation by multivariate logistic regression analysis ($p = 0.011$). The cut-off value of platelet count was determined from the ROC curve to be 52,500/ μ L.

Conclusions: Platelet count might be associated with circuit coagulation during CBP in sepsis patients with AKI. Circuit coagulation might be more likely to occur in patients with platelet counts below 52,500/ μ L. On the other hand, this study did not show whether other coagulation/fibrinolysis markers were associated with circuit coagulation. Further study is needed to extend our study on circuit coagulation during CPB for sepsis patients with AKI.

References

- 1) Singer M, Deutschman CS, Seymour CW, et al. The Third International Consensus Definitions for Sepsis and Septic Shock (Sepsis-3). *JAMA* 2016; 315: 801–810.
- 2) Kidney Disease: Improving Global Outcomes (KDIGO) Practice Guideline for Acute Kidney Injury. *Kidney Int Suppl* 2:1–138, 2012.

Topic: Acute Kidney Injury and haemofiltration

000592

Low global ejection fraction (GEF) in patients with impaired global indexed end-diastolic volume (GEDVI)

C. González¹, A. Traverso¹, A. Giordana¹, E. Papini¹, J. Rodriguez Louzan¹, D. Latasa¹, C. Lovesio¹

¹Intensive Care, Sanatorio Parque, Rosario, Argentina

Correspondence: C. González

Intensive Care Medicine Experimental 2023, **11(Suppl 1)**:000592

Introduction: Transpulmonary thermodilution is a technique that has gained great interest in recent years. Global ejection fraction (GEF) is one of the parameters that it provides. It reflects cardiac pump function. The calculation of the GEF is done using the formula (SV/ GEDV) *4. This algorithm depends on SV and GEDVI, so in hypovolemic patients with decreased preload, GEDVI could be decreased and leads to altered GEF values. In the same way, low stroke volume (SV) could generate low GEF by mathematical coupling without a disorder in cardiac contractility.

Objectives: To evaluate whether impairment in GEDVI and SV may constitute a limitation for the interpretation of GEF and to describe characteristics of patients with impaired GEF. Secondly, to determine factors independently associated with the development of impaired GEF.

Methods: A retrospective study was conducted in a 24-bed medical-surgical intensive care unit in Argentina. Baseline characteristics and hemodynamic variables of the opening measurement were recorded. Patients were classified according to GEF, GEDVI, and VS values.

Statistical analysis was performed by means of the Mann Whitney test for continuous variables and for categorical variables, Pearson's Chi2 test was used. To determine factors independently associated with the presence of impaired GEF, binary logistic regression was performed.

Results: We included 95 patients in shock. 48 were female. Median age were 62 [49–72] years. Apache II and SOFA score were 23 [17–27] and 8 [6–10] respectively. Etiology of shock were septic in 61%, hypovolemia 14%, cardiogenic 6% and perioperative 9.5%. (Table 1).

The haemodynamic characteristics of the opening measurement with transpulmonary thermodilution are shown in Table 2. Overall mortality was 49%. 47 (49%) patients had low GEDVI 534 \pm 82 ml/m², 26 (27%) patients had high GEDVI 901 \pm 73 ml/m² and 22 patients had normal GEDVI (23%). Of the 47 patients with low GEDVI, low GEDVI in 27 (57%) low GEF coexisted. Of all patients with decreased GEF, 36 (65%) had low SV. On the other hand, 47 patients presented low SV, in 37 of them (79%) the GEDVI was low.

Factors independently associated with impairment in GEF were decreased GEDVI, SV and cardiac output (Table 3).

Conclusions: In a high percentage of patients with altered GEF, low SV or GEDVI coexisted. The presence of low GEDVI and cardiac output was independently associated with altered GEF. Due to the formula by which GEF is calculated, there could be mathematical coupling between both parameters, so in hypovolemic patients with deterioration in the GEDVI, the GEF could also be altered without this implying disorders in pump function.

Table 1 (abstract 000592) Baseline characteristics

	All(n=95)	Survivors(n=47)	Non-Survivors(n=48)	p
Age (years)	62[49-72]	60 [45-73]	63[15-72]	0.77
Female(n%)	48 (50)	18 (19)	30(31)	0.12
Apache II	23[17-27]	21[16-25]	25[20-29]	0.03
SOFA	8[6-10]	8[5-10]	8[6-11]	0.12
Comorbidities				
Hypertension (n%)	39 (41)	19 (20)	20 (22)	0.77
Diabetes (n%)	19 (20)	10 (10)	9 (9)	0.94
COPD (n%)	23 (24)	4 (4)	5 (5)	0.83
Coronary disease (n%)	8 (8.5)	3 (3)	5 (5)	0.63
Cronic heart failure (n%)	9 (9.5)	6 (6)	3 (3)	0.62
Cronic kidney failure (n%)	4 (4.2)	2 (2)	2 (2)	0.94
Immunosuppression (n%)	29 (30)	19 (20)	10 (10)	0.20
Chronic corticosteroid use (n%)	13 (14)	9 (9)	4 (4)	0.39
Shock Etiology				
Sepsis	58 (61%)	30	28	0.35
Hypovolemia	14 (14%)	7	7	0.25
Cardiogenic	6 (6%)	4	2	0.83
Perioperative	9 (9.5%)	3	6	0.06
Other	8 (8.5%)	3	4	0.81
ICU Length of stay(n%)	11[6-17]	12[7-18]	10[5-16]	0.42
MV Days (n%)	7[3-13]	6[3-12]	8[3-16]	0.30

Table 2 (abstract 000592) Hemodynamic variables in the opening of transpulmonary thermodilution

	All (n=95)	Survivors (n=47)	Non survivors (n=48)	P
GEDVI(mL/m ²)	627[538-773]	605[515-784]	679[560-771]	0.11
SV (mL/lat)	55[36-72]	63[37-72]	51[36-72]	0.38
ELWI (mL/m ²)	10[8-15]	10[7.8-15]	10[8-15]	0.66
IPVP	2.2[1.6-3.1]	2.2[1.7-3.2]	1.6[1.7-3.2]	0.62
CI (L/min/m ²)	3.1[2.3-3.8]	3.3[2.3-4.1]	2.8[2-3.6]	0.21
GEF (%)	19[14-27]	21[16-28]	18[11-25]	0.01
IRVS(dmas-s-m ² /cm ²)	1697[1303-2312]	1610[1073-2312]	1826[1473-2544]	0.12
MAP (mmHg)	75[62-85]	77[67-98]	73[59-80]	0.01
HR (bpm)	103[82-119]	91[78-120]	105[82-116]	0.64

Table 3 (abstract 000592) Binary logistic regression with LOW GEF as outcome variable

	HR	IC	P
GEDIV	84	77- 92	0.00
SV (mL/lat)	1.11	1.05-1.18	0.00
IC (Lt/min/m2)	2	0.87- 4.9	0.09

Topic: Cardiovascular issues in ICU

000593

In vitro validation of intra-abdominal pressure measurement with the Accuryn system

M. Smit¹, M. W. Nijsten¹

¹Department of Critical Care, University Medical Center Groningen, Groningen, Netherlands

Correspondence: M. Smit

Intensive Care Medicine Experimental 2023, **11(Suppl 1)**:000593

Introduction: Intra-abdominal pressure (IAP) measurement is an important tool in critical care medicine as it helps in diagnosing intra-abdominal hypertension and abdominal compartment syndrome.

New technology has become available to automatically perform frequent IAP measurements. IAP and diuresis are measured using a SmartFoley® bladder catheter that is connected with the Accuryn® monitoring system (both from Potrero Medical, Hayward, CA, USA). Active drain line clearance of the catheter prevents urinary backflow and enables continuous urine output measurement. At the tip of the urinary catheter, a semi-flaccid balloon connected to a pressure sensor measures IAP.

Objectives: In the current study we examined the accuracy of the Accuryn system in measuring IAP under in vitro conditions.

Methods: In an experimental set-up using a water reservoir with levels of water varying between 0 and 52.5 cm, IAP in millimeters of mercury (mmHg) was measured using the Accuryn system. The tip of the Accuryn catheter was placed on the bottom of the reservoir for each measurement. The water level was measured in cm of water (cmH₂O) using a regular measuring tape and then converted to mmHg (1 cmH₂O=0.7356 mmHg).

Results: The water pressure was varied from 0 to 52.5 cm (0 to 38.6 mmHg). IAP was measured by the Accuryn Monitoring System for a total of 15 times with increasing water levels (see graph).

At the various water pressures, the reported IAP differed less than 1 mmHg from the applied pressure. This may be due to small inaccuracies in measuring the water level and in placement of the tip of the catheter on the bottom of the reservoir.

Conclusions: In this in vitro experiment, IAP values reported by the IAP-monitoring system Accuryn system were sufficiently accurate for values between 0 and 40 mmHg.

Water pressure and reported IAP

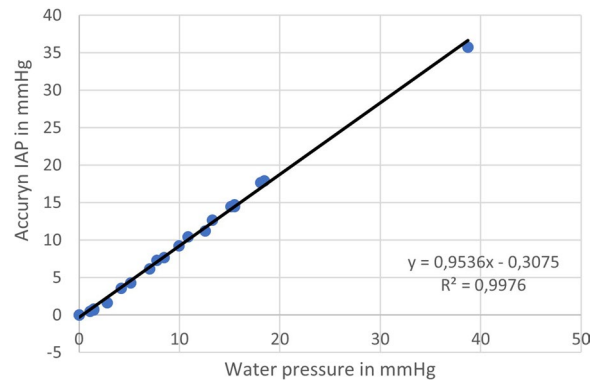

Figure 1 (abstract 000593)

References

- Materials for this study were provided by Potrero Medical (Hayward, CA, USA).

Topic: Acute respiratory failure and mechanical ventilation

000594

Change in our clinical practice in the nutrition of critical patients by the use of indirect calorimetry

M. Prieto Mora¹, L. Garcia Ezpeleta¹, B. Ongil García¹, M. Vazquez Hernandez¹, M. V. Perez Sanchez¹, M. A. Hurtado¹

¹Department of intensive care, Hospital Universitario Virgen de Valme, Seville, Spain

Correspondence: M. Prieto Mora

Intensive Care Medicine Experimental 2023, **11(Suppl 1)**:000594

Introduction: Indirect calorimetry (IC) is a tool that helps the clinician to create a more personalized nutritional therapy, which is very important in the management of critical patients.

Objectives: - Assess the modification or maintenance of the diet based on the results of IC.

- Compare the calories calculated by IC and by the Harris-Benedict equation (HBE).

Methods: Retrospective descriptive and analytical observational study of patients admitted to a 23-bed polyvalent ICU who underwent IC (Cosmed Q-NRG calorimeter) from December 2020 to November 2022. We collected clinical variables (comorbidities, SOFA, phase of the critical illness), epidemiological and nutritional variables (calories calculated by IC and HBE, laboratory parameters, type of nutritional therapy, modification of nutritional therapy). The qualitative variables are expressed as percentages, and the quantitative ones as mean and standard deviation (SD). The comparative analysis of quantitative variables was done with the Student's t test, and in the case of qualitative variables we used the Chi-square test. Sample size calculation: 23 IC performances to find a difference of 5 kcal/Kg (alpha 5%, power 80%, expected loss 5%). Data analysis was run in SPSS v28.0.

Results: We included 35 IC test, performed on 31 patients.

Qualitative variables		Number of patients	%
Sex	Male	20	57,1
	Female	15	42,9
Cardiovascular risk factors	Yes	23	65,7
Surgical patients		27	77,1
Medical patients		8	22,9
Critical illness phase	Acute	4	11,4
	Chronic	31	88,6
Nutritional therapy modification	No	7	20
	Yes	28	80
Type of nutritional therapy	EN	28	80
	TPN	2	5,7
	EN + SPN	4	11,4
	oral + EN or SPN	1	2,9

EN: enteral nutrition. TPN: total parenteral nutrition. SPN: supplemental parenteral nutrition

Variable	Statistics	t (CI 95%)	p
Age (years) (mean ± SD)	62,54 ± 10,5		
Previous kcal/kg administration	17,77 ± 8,15		
BMI (median, minimum, maximum)	28,4 (18,2–57,1)		
SOFA at admission	4 (2–16)		
SOFA at IC performance	7 (2–14)		
Kcal/kg calculation (mean ± SD):		3,35	0,002
IC	21,96 ± 5,71		
HBE	19,22 ± 2,1		

Conclusions: - The performance of IC is useful to guide the nutritional therapy of critically ill patients.

- After comparing the calorie requirement calculated by HBE and by IC, an statistically difference was revealed, being higher the result obtained by IC.

- Most of the patients who underwent IC were in the chronic stage of their critical illness.

Topic: Metabolism, endocrinology, liver failure and nutrition

000596

Study of prescribing patterns and effectiveness of ceftolozane/tazobactam real-world analysis (SPECTRA): results on critical care patients from a multi-national, multicenter, observational analysis

A. Soriano¹, D. Paterson², F. Thalhammer³, S. Kluge⁴, P. Viale⁵, B. Akrich⁶, M. Allen⁷, S. Wirbel⁸, E. Obi⁹, S. Kaul¹⁰

¹Department of Infectious Diseases, Hospital Clinic, Barcelona, Spain; ²Centre for Clinical Research, The University of Queensland, Queensland, Australia; ³Department of Urology, Medical University of Vienna, Wien, Austria; ⁴Department of Intensive Care Medicine, University Medical Center Hamburg-Eppendorf, Hamburg, Germany; ⁵Department of Medical and Surgical Sciences, University of Bologna, Bologna, Italy; ⁶Medical Affairs, MSD, Puteaux, France; ⁷Medical Affairs, MSD, London, United Kingdom; ⁸Biostatistics & Medical Writing, ICON Commercialization & Outcomes, ICON Plc, Lyon, France; ⁹Center for Observational and Real-world Evidence, Merck & Co., Inc., Rahway NJ, United States of America; ¹⁰Dept of Respiratory Medicine and Intensive Care, Harefield Hospital, London, United Kingdom

Correspondence: E. Obi

Intensive Care Medicine Experimental 2023, 11(Suppl 1):000596

Introduction: Ceftolozane/tazobactam (C/T) is indicated for the treatment of complicated intra-abdominal infections (cIAI) [1], complicated urinary tract infections (cUTI), including pyelonephritis [2], and hospital acquired bacterial and ventilator-associated bacterial pneumonia [3]. Information on real-world use and outcomes of patients treated with C/T in critical care settings is important to help inform disease management and clinical practice.

Objectives: This study presents findings on patient/treatment characteristics and outcomes associated with C/T use in patients managed in the critical care setting.

Methods: Data were collected from the SPECTRA study, a multi-national, multicenter, retrospective, inpatient, observational study of patients treated with C/T across hospitals in 7 countries (Spain, The United Kingdom, Germany, Italy, Austria, Australia, and Mexico) from 2016 to 2020. All adult patients admitted to the intensive care unit during the index hospitalization and treated with C/T for ≥ 48 h were included. Demographics, clinical characteristics, treatment management patterns, and outcomes were assessed.

Results: The study sample included 298 critical care patients receiving C/T (mean age 57.0 years; 68.8% male), 41.9% of which had an infection-related ICU admission. Sites of infection were respiratory (50.0%), skin/wound/tissue (21.1%), blood (13.7%), urine (10.3%), pleural fluid/cerebrospinal fluid/other fluid (9.3%), line/device (2.9%), abdominal (1.0%), bone/joint (0.5%), and stool (0.5%). The most common pathogens were *Pseudomonas aeruginosa* (89.7%) and *E. coli* (6.4%). Most patients (81.5%) had at least one comorbidity, with the most common being immunocompromised state (44.6%), sepsis (41.6%), heart disease (29.2%), and chronic pulmonary disease (27.2%). Renal replacement therapy was initiated in 21.5% of patients during index hospitalization, with 14.4% on continuous renal replacement therapy. The most common C/T regimen was 1.5 g every 8 h (36.9% of patients). About 51.6% of patients received C/T as third line or salvage (24.8% and 23.5% received C/T as 1st or 2nd line, respectively). Median C/T treatment duration was 11.0 days (Q1, Q3: 7.0, 16.5 days). Clinical success was 53.4%. All-cause in-hospital mortality was 35.6% overall, and 13.8% infection related. 30-day all-cause readmission was 3.4% overall, and 1.7% infection related.

Conclusions: This multinational real-world study included a high number of critical care patients and reported outcomes associated with C/T use. In this very high-risk cohort presenting with severe gram-negative infections, most C/T patients had beneficial outcomes despite their clinical complexity and late intervention with C/T.

References

1. Solomkin J, Hershberger E, Miller B, et al. Ceftolozane/Tazobactam Plus Metronidazole for Complicated Intra-abdominal Infections in an Era of

Multidrug Resistance: Results From a Randomized, Double-Blind, Phase 3 Trial (ASPECT-clAI). *Clin Infect Dis*. 2015;60(10):1462–1471.

2. Wagenlehner FM, Umeh O, Steenberg J, Yuan G, Darouiche RO. Ceftolozane-tazobactam compared with levofloxacin in the treatment of complicated urinary-tract infections, including pyelonephritis: a randomised, double-blind, phase 3 trial (ASPECT-cUTI). *Lancet*. 2015;385(9981):1949–1956.
3. Kollef MH, Nováček M, Kivistik Ü, et al. Ceftolozane-tazobactam versus meropenem for treatment of nosocomial pneumonia (ASPECT-NP): a randomised, controlled, double-blind, phase 3, non-inferiority trial. *Lancet Infect Dis*. 2019;19(12):1299–1311. [https://doi.org/10.1016/S1473-3099\(19\)30403-7](https://doi.org/10.1016/S1473-3099(19)30403-7)
4. This study was sponsored by Merck Sharp & Dohme LLC, a subsidiary of Merck & Co., Inc., Rahway, NJ, USA

Topic: Infections and prevention

000597

Factors correlated with outcome in ARDS COVID-19 patients on extracorporeal membrane oxygenation (ECMO): a Greek center experience

A. Kyriakoudi¹, G. Gavriilidis¹, K. Pontikis¹, M. Kyriakopoulou¹, V. Tsagkari¹, N. Kakaras¹, A. Koutsoukou¹

¹Intensive Care Unit, 1st Department of Respiratory Medicine, National & Kapodistrian University, Sotiria Hospital for Chest Diseases, Athens, Greece

Correspondence: A. Kyriakoudi

Intensive Care Medicine Experimental 2023, **11(Suppl 1)**:000597

Introduction: The severe acute respiratory distress syndrome (ARDS), refractory to usual supportive care, due to COVID-19, expanded the use of extracorporeal support therapies worldwide (1). Under the surge of the pandemic, ECMO therapy was urgently organized and implemented according to Extracorporeal Life Support Organization (ELSO) recommendations (2) in our academic 17-beds ICU. As long-term survival benefit of receiving ECMO in COVID-19 remains uncertain (3), any additional data from patients connected on ECMO will be useful to determinate factors which can affect outcome.

Objectives: The 6-month outcome and factors correlated with survival of patients connected on ECMO during COVID-19 pandemic in Greece.

Methods: All patients treated with ECMO, in our department, during Covid-19 period were followed for six months after hospital discharge. Data are presented as median (IQR) and were analyzed with non-parametric Mann–Whitney U test and Spearman rank correlation.

Results: From February 2021 until June 2022, 20 patients (3 women and 17 men), median age 44.7(IQR 35.5–54.0) years old, have been supported with ECMO due to life threatening acute respiratory failure due to COVID-19. Prior to ECMO initiation, all patients had received protective ventilation with recruitment maneuvers, prone positioning sessions and neuromuscular blockade. P/F ratio was 64 (IQR 51.3–73.5) for more than 6 h, pCO₂ 59 (IQR 55.3–72.0) mmHg, PH 7.32 (IQR 7.28–7.37) and respiratory system compliance was 24 (IQR 16–34.5) ml/cmH₂O. Median ECMO duration was 26 (IQR 15–63) days. Eleven patients (55%) were weaned from ECMO and 9 of them (45%) were discharged from the hospital (5 of them needed rehabilitation center). Six months later, all 9 were alive at home in a good health without requirement of oxygen therapy (5 of them returned to work).

The most frequent complication related to intervention was major bleeding, that appeared to 50%. Major causes of death were sepsis and multiorgan failure. Non-survivors as compared to survivors had longer duration of mechanical ventilation before ECMO initiation (11 vs 6 days, p=0.036), longer ECMO running time (63 vs 16 days, p=0.04), were more frequently complicated with acute renal failure (72.7% vs 11.1%, p=0.07) and multi-organ failure (81.8% vs 11.1%, p=0.02). The age was not correlated with outcome.

Conclusions: Under urgent circumstances ECMO implementation was feasible and obtained reasonable chances of six-month survival. In our cohort, factors found to be associated with in-hospital mortality were prolonged time from intubation to ECMO initiation, longer ECMO running time and acute renal failure. We didn't find any correlation

between age and outcome as we only provided ECMO support in younger than 65 years old patients, in accordance with ELSO guidelines (2). Our results are consistent with data of Euro ECMO-Covid survey (4) and could add in the estimation of long-term outcome of COVID-19 patients connected on ECMO.

References

1. (1) Lorusso R, Combes A, Coco V Lo, De Piero ME, Belohlavek J. ECMO for COVID-19 patients in Europe and Israel. *Intensive Care Med*. 2021;47(3):344–348. <https://doi.org/10.1007/s00134-020-06272-3>
2. not applicable
3. (2) Shekar K, Badulak J, Peek G, et al. Extracorporeal Life Support Organization Coronavirus Disease 2019 Interim Guidelines: A Consensus Document from an International Group of Interdisciplinary Extracorporeal Membrane Oxygenation Providers. *ASAIO Journal*. 2020;66(7):707–721. <https://doi.org/10.1097/MAT.0000000000001193>
4. (3) Whebell S, Zhang J, Lewis R, et al. Survival benefit of extracorporeal membrane oxygenation in severe COVID-19: a multi-centre-matched cohort study. *Intensive Care Med*. Published online March 3, 2022. <https://doi.org/10.1007/s00134-022-06645-w>
5. (4) Lorusso R, De Piero ME, Mariani S, et al. In-hospital and 6-month outcomes in patients with COVID-19 supported with extracorporeal membrane oxygenation (EuroECMO-COVID): a multicentre, prospective observational study. *Lancet Respir Med*. 2023;11(2):151–162. [https://doi.org/10.1016/S2213-2600\(22\)00403-9](https://doi.org/10.1016/S2213-2600(22)00403-9)

Topic: Acute respiratory failure and mechanical ventilation

000599

Endotracheal intubation of children and infants before transfer to paediatric intensive care—are we choosing the correct size tube?

D. Anderson¹, A. Hargedon-Lowe¹

¹Paediatric Intensive Care, Southampton General Hospital, Southampton, United Kingdom

Correspondence: D. Anderson

Intensive Care Medicine Experimental 2023, **11(Suppl 1)**:000599

Introduction: The use of cuffed endotracheal tubes (ETTs) is routine in infants and children requiring admission to a paediatric intensive care unit (PICU). Commonly, paediatric patients are intubated by non-paediatric anaesthetists or intensivists, before being transferred to a hospital with a PICU. Non-paediatric practitioners may be less familiar with optimal ETT selection in children, and traditional formulae can result in overestimation of ETT size—an issue discussed in European Resuscitation Council guidelines. Incorrectly sized ETTs can lead to complications including airway injury and extubation difficulties. The incidence of incorrect ETT size selection in the paediatric population has not been described previously.

Objectives: To describe the incidence of incorrectly sized ETTs used in patients aged 0–5 years admitted to a PICU from district general hospitals.

Methods: Data were collected from all intubated patients up to 5 years old who were transferred to our tertiary PICU over a 6-month period. Sizes of ETTs were compared to manufacturers guidance and to the traditional calculation used to decide ETT diameter. Further data were collected including how often incorrectly sized ETTs were changed in the first 24 h of PICU stay.

Results: 123 intubated patients were transferred to the PICU over the 6-month period. Of these, 117 had adequate clinical records for inclusion. The majority of intubated patients (97%) had cuffed ETTs inserted. Of patients with cuffed ETTs, 42% were incorrectly sized as per manufacturer's guidance. Of the patients with an incorrectly sized ETT, the majority (94%) had a larger size than recommended. The traditional formula adapted from calculating uncuffed ETTs was applied to the results, showing that 27% of ETTs incorrect as per manufacturer's advice were correct as per the calculation, 13% were incorrect by both the calculation and manufacturer's guidance, and 60% of cases were under 1 year of age and therefore too young to apply the formula. 24 h into PICU admission 56% of incorrectly sized ETTs were

left unchanged, 31% changed to the correct size, and 13% changed to another incorrect size.

Conclusions: Many patients intubated prior to PICU admission had an ETT size different to manufacturers guidance for age. In the majority of cases a larger than recommended tube was inserted. 24 h into their PICU stay, many patients either had the same incorrect ETT in situ or had their ETT changed to another incorrect size. These data raise concerns regarding risk of complications relating to oversized ETT placement in PICU patients, including subglottic or tracheal stenosis and failed extubation. Traditional calculations used to determine ETT diameter can overestimate the optimal size of ETT, however this only potentially explained incorrect tube size in 27% of our cases. Risks of complications may be reduced by promoting awareness amongst intubators regarding optimal ETT sizes, alongside greater vigilance of admission ETT size within PICU itself.

References

- John C. Wain. 'Postintubation Tracheal Stenosis'. *Seminars in Thoracic and Cardiovascular Surgery*, 21:3 (2009) 284–289
- Patrick Van de Voorde et al. 'European Resuscitation Council Guidelines 2021: Paediatric Life Support'. *Resuscitation*: 161 (2021) 327–287

Topic: Acute respiratory failure and mechanical ventilation

000600

The contribution of the combination of transthoracic and transcranial ultrasonography to the titration of positive end-expiratory pressure in patients with acute respiratory distress syndrome and acute brain injury

T. Schizodimos¹, P. Ioannidis¹, G. Pitsiou², C. Iasonidou¹, E. Kerezidou¹, N. Kapravelos¹

¹B ICU, General Hospital "G. Papanikolaou", Thessaloniki, Greece;

²Respiratory Failure Clinic, General Hospital "G. Papanikolaou", Thessaloniki, Greece

Correspondence: T. Schizodimos

Intensive Care Medicine Experimental 2023, **11(Suppl 1)**:000600

Introduction: Up to 30% of neurocritical care patients with acute brain injury (ABI) develop acute respiratory distress syndrome (ARDS), a complication that has been associated with poor outcome. The need to apply positive end-expiratory pressure (PEEP) in these patients can lead to an increase in intracranial pressure (ICP) measured invasively via intracranial probes. Non-invasive methods, such as lung (LUS) and brain (BUS) ultrasound, could help guide the appropriate mechanical ventilation (MV) strategy to improve lung function while protecting the brain from secondary injury.

Objectives: To investigate the alteration in the optimal PEEP level according to the use of LUS and BUS in mechanically ventilated patients with ARDS and ABI.

Methods: A preliminary, interventional, prospective clinical study was performed in a Greek ICU from June 2021 to March 2023, including 9 patients with ABI (3 TBI, 1 SAH, 5 ICH) and ARDS. GCS on admission, APACHE II and LISS score were recorded. The intervention included a gradual increase in PEEP level from 5 to 8, 12 and 16 cmH₂O. Simultaneously, LUS and BUS were performed after each PEEP level change, ICP and brain tissue pO₂ (PbtO₂) values and MV parameters were recorded, and arterial blood gas samples were obtained after 20 min. We performed LUS in 6 regions in each lung and calculated the LUS score. We also performed BUS and recorded the pulsatility index (PI) and diastolic flow velocity (FVd) values. During these maneuvers we ensured normal ICP (<22 mmHg) and adequate cerebral perfusion pressure in all patients.

Results: Included 9 patients had a mean age of 55.1 (SD ± 20.1) years, mean ICU admission GCS 6.4 (SD ± 1.66), mean APACHE II score 19.3 (SD ± 3.08) and mean LISS score 2.1 (SD ± 0.48). There was a marginally significant difference in LUS score regarding the PEEP 8–PEEP 16 pair (p = 0.05) (Table 1).

Table 1 (abstract 000600) LUS score comparison between PEEP levels

PEEP (cmH ₂ O) level pairs	p value
PEEP 5/PEEP 8	0.121
PEEP 8/PEEP 12	0.062
PEEP 12/PEEP 16	0.076
PEEP 5/PEEP 12	0.052
PEEP 5/PEEP 16	0.051
PEEP 8/PEEP 16	0.05

A non-significant trend towards a progressive decrease in LUS score as PEEP level increased was also observed (Figure 1). We were not able to detect a uniform pattern of reduction or rise in PI value as PEEP level was increased (Figure 2). Alterations in PI value was also not significant between different pairs of PEEP levels. A gradual rise in ICP was observed as PEEP level was increased but this was not statistically significant (Figure 3). All ICP comparisons between different PEEP levels were not significant. The lowest PEEP level with the greatest LUS score was compared with the maximum PEEP level that was safe according to BUS. There was no significant difference in PEEP according to LUS, BUS or ICP, although the BUS or ICP selected PEEP was lower than PEEP selected with LUS (Tables 2, 3).

Table 2 (abstract 000600) Comparison of selected PEEP according to LUS and BUS

Variable	PEEP (cmH ₂ O) (LUS)	PEEP (cmH ₂ O) (BUS)	p value
Median (IQR)	16 (0)	16 (0)	0.586
Mean (SD)	15.56 (SD 1.33)	14.67 (SD 2.83)	0.447

Table 3 (abstract 000600) Comparison of selected PEEP according to LUS and ICP

Variable	PEEP (cmH ₂ O) (LUS)	PEEP (cmH ₂ O) (ICP)	p value
Median (IQR)	16 (0)	16 (0)	0.773
Mean (SD)	15.56 (SD 1.33)	15.11 (SD 1.67)	0.447

Conclusions: LUS could contribute to the titration of PEEP in patients with ABI and ARDS. In contrast, BUS adjunct to invasive ICP monitoring did not appear to be helpful in our small sample. Since our study is ongoing, we expect a larger sample size to provide more accurate and reliable results in patients with ABI and ARDS.

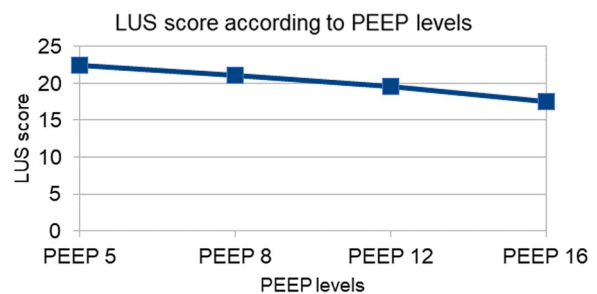

Figure 1 (abstract 000600) LUS score according to PEEP levels

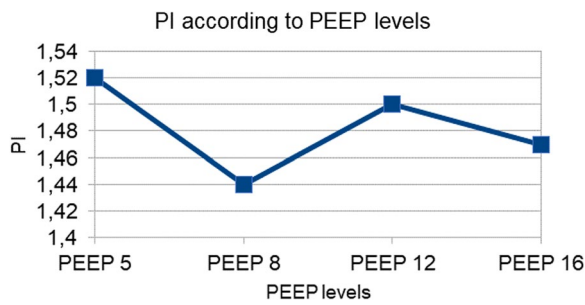

Figure 2 (abstract 000600) PI according to PEEP levels

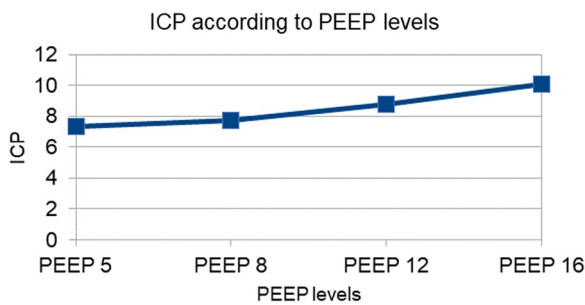

Figure 3 (abstract 000600) ICP according to PEEP levels

References

1. Corradi F, Robba C, Tavazzi G, et al. Combined lung and brain ultrasonography for an individualized “brain-protective ventilation strategy” in neurocritical care patients with challenging ventilation needs. Crit Ultrasound J. 2018;10(1):24.
2. Stefanidis K, Dimopoulos S, Tripodaki ES, et al. Lung sonography and recruitment in patients with early acute respiratory distress syndrome: a pilot study. Crit Care. 2011;15(4):R185.
3. None

Topic: Neurointensive care

000601

Factors associated with delayed intubation in trauma patients with rib fractures

J. Catlin¹, S. Marks², A. Cano³, M. Aboutanos¹
¹Surgery, Virginia Commonwealth University, Richmond, United States of America; ²Medical Scientist Training Program, VCU School of Medicine, Richmond, United States of America; ³Computer Science, Virginia Commonwealth University, Richmond, United States of America

Correspondence: S. Marks

Intensive Care Medicine Experimental 2023, 11(Suppl 1):000601

Introduction: Blunt thoracic trauma is common and contributes significantly to trauma admissions. Even among patients with rib fractures who initially appear stable, many are at risk of developing respiratory failure. Targeted management of the higher risk subset of patients may prevent decompensation requiring intubation. And allow for the proactive identification of patients who will require intubation, enabling planned intubation before decompensation. We sought to identify risk factors for delayed intubation (intubation more than one hour after arrival) that would be identifiable on admission to facilitate more aggressive management and triage for patients at the highest risk of developing clinically significant respiratory failure.

Objectives: To identify factors associated with delayed intubation in patients with rib fractures.

Methods: This an analysis of data from the American College of Surgeons’ Trauma Quality Improvement Project from 2020 to 21. We included patients 15 years or older with multiple rib fractures or flail chest and an AIS chest score of ≥ 2 or greater. We excluded patients going to the operating room from the emergency department (ED) or who had advanced directives limiting care. Descriptive statistics were used to compare characteristics of patients with delayed intubations to those patients not progressing to require intubation; multivariate logistic regression was used to identify factors associated with delayed intubation. Variables examined include patient demographics, injury type and severity, pre-existing conditions and initial vital signs upon arrival in the ED.

Results: A total of 146,908 patients were included in the analysis data set; 4.9% had a delayed intubation (median of 30 h (IQR: 6–74)). Characteristics of patients are described in Table 1. Partial multivariate model results are shown in Figures 1 and 2.

Table 1 (abstract 000601) Characteristics of patients by timing of intubation

	Delayed intubation	No intubation	Difference (95% CI)
Age (mean (SD))	59.0 (17.1)	57.8 (18.2)	1.2 (0.8–1.6)*
Male (%)	74.1	67.2	6.9 (5.8–7.9)*
ISS (mean (SD))	21.6 (10.1)	13.6 (6.5)	8.0 (7.2–8.2)*
Flail chest (%)	14.4	4.6	9.7 (8.9–10.5)*
Pulse (mean (SD))	95.3 (21.8)	86.7 (17.8)	8.6 (8.2–9.2)*
SBP (mean (SD))	130.8 (29.1)	139.8 (25.4)	8.8 (8.3–9.7)*
GCS (mean (SD))	14.2 (1.9)	14.8 (0.6)	–0.60 (0.56–0.65)*
Supplemental O ₂ in the ED (%)	38.9	16.7	22.2 (21.1–23.4)*

*p < 0.001.

Conclusions: Patients who progressed to requiring intubation were more likely to have flail chest injuries (vs only multiple rib fractures) and have pre-existing medical conditions. Need for supplemental oxygen upon arrival, higher ISS and other physiological parameters in the ED were also associated with delayed intubation. These results may aid in the development of prediction tools to identify patients who would benefit from more aggressive management within the first hour of presentation and guide patient triage to the appropriate level of care.

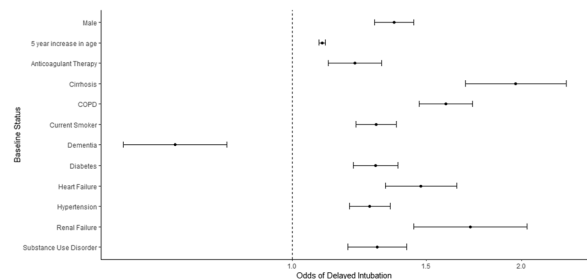

Figure 1 (abstract 000601) Select baseline patient characteristics associated with delayed intubation

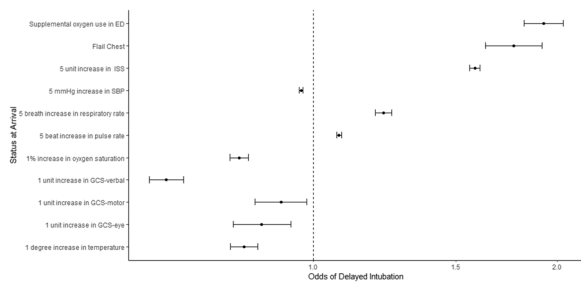

Figure 2 (abstract 000601) Select injury characteristics and vital signs associated with delayed intubation

References

5. Trupka A, Waydhas C, Nast-Kolb D, Schweiberer L. Early intubation in severely injured patients. *European journal of emergency medicine.* 1994;1(1):1–8. <https://doi.org/10.1097/00063110-199403000-00002>
- Naar L, El Hechi MW, van Erp IA, et al. Isolated rib cage fractures in the elderly: Do all patients belong to the intensive care unit? A retrospective nationwide analysis. *The journal of trauma and acute care surgery.* 2020;89(6):1039–1045. <https://doi.org/10.1097/TA.0000000000002891>
- Mirafior E, Chuang K, Miranda MA, et al. Timing is Everything: Delayed Intubation is Associated with Increased Mortality in Initially Stable Trauma Patients. *The Journal of surgical research.* 2011;170(2):286–290. <https://doi.org/10.1016/j.jss.2011.03.044>
- Martin CS, Lu N, Inouye DS, et al. Delayed Respiratory Failure After Blunt Chest Trauma. *The American surgeon.* 2021;87(9):1468–1473. <https://doi.org/10.1177/0003134820966278>
- Huf R, Kraft S, Schildberg FW. Der Einfluss des Intubationszeitpunktes auf den klinischen Verlauf polytraumatisierter Patienten mit Lungenkontusion [Effect of intubation timing on the clinical course of polytrauma patients with lung contusions]. *Zentralbl Chir.* 1996;121(1):21–23.

Topic: Trauma

000602

The metric of rapid response systems: can you measure the quality of your rapid response system?

R. K. So¹, E. Edwards², F. Haegdorens³, C. Subbe⁴
¹Intensive Care Unit Adults, Albert Schweitzer Hospital, Dordrecht, Netherlands; ²Betsi Cadwaladr University Health Board, Tremadog, United Kingdom; ³Department of Nursing and Midwifery Sciences, University of Antwerp, Antwerpen, Belgium; ⁴Bangor University, Bangor, United Kingdom

Correspondence: R. K. So
Intensive Care Medicine Experimental 2023, **11(Suppl 1)**:000602

Introduction: In 2018 the international society for Rapid Response Systems (iSRRS) convened a consensus conference to agree on ten metrics for quality improvement¹ related to structure, process and outcome of rapid response system (RRS) with outcomes following the domains of the quadruple aim.

It is not known whether hospitals are currently collecting data on these indicators or are capable to collect these data. This is an essential piece of information needed to initiate regional collaboratives that strive to improve the quality and safety of patients at risk of catastrophic deterioration in hospital.

Objectives: This study set out.

- To assess readiness of international hospitals to implement recommended quality metrics for RRS
- To evaluate feasibility of improvement collaboratives based on currently collected data categories

Methods: The study is a prospective international digital survey. The survey captures the current standard of data collection against the recommended metrics of the iSRRS and a small number of contextual items.

Inclusion criteria: hospitals who have a Rapid Response System (RRS) or are in the process of setting up a RRS and caring for acutely unwell patients. **Exclusion criteria:** hospitals caring only for palliative patients or specialising in post-acute care were excluded.

Recruitment

Participating units were recruited through national societies of critical care or Critical Care Outreach, national or international conferences and through social media postings by the iSRRS.

Data were collected, from July 1st to November 30th 2022, through an online survey.

https://www.surveymonkey.com.uk/r/iSRRS_METHOD3_Survey_2022.

Data collection

The survey collected data on the size of the hospital (approximate bed number), location of the hospital (region), nature of the current RRS, and details on the ability to collect data for each of the 10 recommended quality metrics¹. Response to each of the metrics contained categorical responses: recording already, could record, can't record, haven't got that service, not sure.

Statistics and analysis

Statistical analysis was limited to a descriptive evaluation collating capability of participating units. The predefined analysis plan included reporting of results by country and by size of hospital.

Results: In total 109 hospitals participated in the survey, of which 92 hospitals located in 11 countries could provide full data: UK (n=45), Australia & New Zealand (n=25), USA & Canada (n=13), Europe (n=8), Singapore (n=1). Half of all hospitals (54%) can be considered as large centers (i.e. > 500 beds). Percentages of hospitals indicating the application of the ten core metrics on the assessment of Rapid Response Systems (n = 109) are presented in the figure.

Conclusions: What we have found: most of the metrics are feasible for organizations to measure and track, but metrics 6–8 are culturally linked and require more effort.

Clinical implications: Breakthrough collaboratives could help clinicians to share data and learning for improvement based on the wide availability of the metrics.

Research implications: Context is needed for the non-measurables to understand barriers and enablers for wider spread of high quality care.



Percentages of hospitals indicating the application of the ten core metrics on the assessment of Rapid Response Systems

References

- Subbe CP, Bannard-Smith J, Bunch J, Champunot R, DeVita MA, Durham L, Edelson DP, Gonzalez I, Hancock C, Haniffa R, Hartin J, Haskell H, Hogan H, Jones DA, Kalkman CJ, Lighthall GK, Malycha J, Ni MZ, Phillips AV, Rubulotta F, So RK, Welch J; International Society for Rapid Response Systems. Quality metrics for the evaluation of Rapid Response Systems: Proceedings from the third international consensus conference on Rapid Response Systems. *Resuscitation.* 2019 Aug;141:1–12. PMID: 31129229.

Topic: Cardiac arrest

000603

Prevalence of spinal injury in trauma patients with hemodynamic or neurological instability: 3-year analysis of data from Lombardia (Italy) trauma registry (LTR)

V. Punzi¹, M. Leone², R. Giudici³, M. Brioni², G. Bassi³, C. Martinet², B. Franchi⁴, E. Chironi⁴, F. Marrazzo³, S. Peron⁵, F. Villa⁶, V. Terzi³, E. Borotto⁴
¹Anestesia e rianimazione, Università degli studi di Milano, Milano, Italy; ²Intensive Care unit, Foundation IRCCS Ca' Granda Ospedale Maggiore Policlinico, Milano, Italy; ³Department of Emergency medicine, ASST Great Metropolitan Niguarda, Milano, Italy; ⁴Anestesia e Rianimazione Neurochirurgica e Generale, the District Hospital - Entrance via Lazio, Varese, Italy; ⁵Neurosurgery, ASST Ovest Milanese - Ospedale di Legnano, Legnano, Italy; ⁶Anestesia e rianimazione, Università degli studi di Milano Bicocca, Monza, Italy

Correspondence: V. Punzi

Intensive Care Medicine Experimental 2023, **11(Suppl 1)**:000603

Introduction: The shared prehospital management of critically injured trauma patients assumes the presence of spinal injury until proven otherwise (1). However, there is growing evidence documenting harm and a delayed time to intervention associated with the use of rigid collar and spinal stabilization (2, 7), especially in trauma victims with hemodynamic or neurological instability (3, 4). In these patients, any prehospital procedure (spinal immobilization included) should never preclude or delay lifesaving interventions as it is proved that longer on-scene time is associated with increased mortality (5). Besides, there is no randomized trial showing superiority of usual spinal immobilization (cervical collars, long boards) over manual in line stabilization and recent literature is even highlighting several complications related to their use (increased intracranial pressure, reduced functional residual capacity, delay in airway management, pressure lesions) (6–8).

Objectives: To evaluate the prevalence of spinal injury in trauma patients with hemodynamic or neurological instability and to describe their median on-scene time and total prehospital time.

Methods: Inclusion criteria were trauma patients admitted to the trauma centers of Lombardia, who underwent a total body CT scan and whose data were reported in Lombardia Trauma Registry (LTR). In this LTR registry-based retrospective cohort study, demographic data, level of prehospital care (advanced life support—ALS, basic life support—BLS), prehospital time, abbreviated injury score (AIS, 2015 version), injury severity score (ISS) of all trauma patients were retrospectively reviewed. Moreover, the prevalence of spinal injuries (AIS ≥ 3), their localization (cervical or thoracic) and the severity of spinal lesions (spinal cord injuries or unstable vertebral fractures or ligamentous injuries) were recorded. Conventionally, an ISS ≥ 16 was defined as major trauma (2).

Prehospital hemodynamic and/or neurological instability was also detected. Hemodynamic instability (Hem-I) was defined as prehospital shock index (SI) > 1 or cardiac arrest, while neurological instability (Neu-I) was defined as Glasgow Coma Scale (GCS) < 9 and pupilar signs of intracranial hypertension. Moreover, prehospital time (PHT), defined as time elapsed between BLS or ALS arrival on scene and the arrival at the hospital, and on-scene time (OST) was recorded. Data are presented as median and interquartile range (IQR).

Results: The cohort is based on 7334 patients, victims of major trauma, from January 2020 to December 2022 and included in LTR. Among the 361 patients (77.8% male, 53 ± 15 years old, overall mortality 1.4%) that suffered from post-traumatic spinal injury (SPI), 72 (19.9%) reported spinal cord injury (SCI) and 299 (82.8%) vertebral unstable injuries (VUI). Details of these lesions according to their location (cervical or thoracic), their prevalence in hemodynamic or neurological unstable patients, the median OST in each group, and the severity of trauma (defined by ISS) are summarized in Table 1. Median PHT for Hem-I and Neu-I patients was respectively 54 (42–70) and 54 (42–68) minutes while PHT in stable patients was 49 (38–68).

Conclusions: The prevalence of SPI in Hem-I and Neu-I patients was respectively 12.1% and 8.3%; in these patients the median OST and total PHT was longer than recommended, especially in Neu-I patients with cervical injury (major head trauma). This result suggests that the goal of optimizing prehospital time in case of instability, especially in patients with early signs of intracranial hypertension, for most patients may be reached also by customizing immobilization protocols without an increased risk of spine lesion.

	Total		Hem-I		Neu-I		ISS
	N° (n)	N° (%)	OST (min)(IQR)	N° (%)	OST (min)(IQR)	Median (IQR)	
	7334 (100)	909 (12.4)	40 (29-54)	1019 (13.9)	39 (29-52)	9 (4-17)	
SPI (n°patients)	361 (4.9)		110 (12.1)*		85 (8.3)*		17 (12-29)
c-SCI (n°lesions)		41	12 (29.3)	43.5 (33.8-61.5)	10 (24.4)	60 (48.8-67.5)	29 (24.5-35.5)
t-SCI (n°lesions)	72 (19.9)	33	13 (39.4)	45 (38-52)	4 (12.1)	42 (37.5-46.5)	
c-VUI (n°lesions)		59	20 (33.9)	45.5 (32-55.5)	14 (23.7)	52 (43.2-55.5)	
t-VUI (n°lesions)	299 (82.8)	251	65 (25.9)	41 (34-54.2)	57 (22.7)	42 (31.2-50.8)	17 (10-26)

References

1. 7 "The Norwegian guidelines for the prehospital management of adult trauma patients with potential spinal injury" – Kornhall et al. – Scandinavian Journal of Trauma, Resuscitation and Emergency Medicine (2017) 25:2. <https://doi.org/10.1186/s13049-016-0345-x>.
2. 8 "Value of rigid collar in addition to head blocks: a proof of principle study" – Holla M – Emerg Med J 2012;29:104–7.
3. 1 "Emergency Neurological Life Support: Traumatic Spine Injury" – Stein DM, Knight W—Neurocritical care 27 (2017). DOI 10.1007/s12028-017-0462-z.
4. 2 "New clinical guidelines on the spinal stabilization of adult trauma patients – consensus and evidence based" – Maschmann C et al. Scandinavian Journal of Trauma, Resuscitation and Emergency Medicine 27 (1 2019). DOI 10-1186/s13049-019-0655-x.
5. 3 Impact of cervical collars on intracranial pressure values in Traumatic Brain Injury: A systematic review and meta analysis of prospective studies" – Nunez Patino RA, Rubiano AM, Godoy DA– Neurocritical care 32 (2 2020) DOI: 10-1007/s12028-019-00760-1.
6. 4 "Out of hospital spinal immobilization: its effect on neurologic injury" – M. Haitswald et al. – Academic Emergency Medicine 5 (3 1998) <https://doi.org/10.1111/j.1553-2712.1998.tb02615.x>.
7. 5 "Faster on scene times associated with decreased mortality in HEMS transported trauma patients 2017 – Pham H, Puckett Y, Dissanaik S – Trauma Surg Acute Care Open 2017;2:1–5.
8. 6 "Motion generated in the unstable cervical spine during the application and removal of cervical immobilization collars" – Prasarn ML, Conrad B, Del Rossi G, Horodyski M, Rehtine GR – J Trauma Acute Care Surg. 2012;72:1609–13.

Topic: Trauma

000604

Impact of an early and comprehensive communication strategy on the long-term prevention of depressive symptoms in patients with severe Covid-19

L. Alegria¹, P. Repetto², V. Rojas³, M. Ortiz⁴, M. P. Celis⁵, F. Paredes⁶, E. Tobar Almonacid⁷

¹Departamento de medicina intensiva, Pontificia Universidad Católica de Chile, Santiago, Chile; ²Escuela de psicología, Pontificia Universidad Católica de Chile, Santiago, Chile; ³Medicina intensiva, Universidad de Chile, Santiago, Chile; ⁴Escuela de psicología, Universidad de la Frontera, Temuco, Chile; ⁵Unidad de cuidados intensivos, COMPLEJO ASISTENCIAL DR SOTERO DEL RIO, Puente Alto, Chile; ⁶Escuela de Matemática, Pontificia Universidad Católica de Chile, Macul, Chile; ⁷Facultad de medicina, Universidad de Chile, Santiago, Chile

Correspondence: L. Alegria

Intensive Care Medicine Experimental 2023, **11(Suppl 1)**:000604

Introduction: A important number of patients hospitalized in Chile with COVID-19 have required Intensive Care Unit (ICU) (1). The isolation measures implemented in the ICU to reduce the spread of infection (social distancing, suspension of visits, etc.), and the increase in the number of severe patients, make it difficult to maintain fluid and constant communication between patients, family members and health care team (2). Under these conditions, communication has been a permanent challenge that has not been easy to address. The usual strategies for communication have been proved ineffective and difficult to implement given the increasing demand for care to which these teams are subjected. We know from recent reports about the negative impact not being able to maintain communication has on the mental health of patients, family members and health teams (3–5) and it is urgent to develop and implement simple and effective strategies that facilitate such communication, and that in turn does not become an additional workload for health teams.

Objectives: To determine the effect of an early and comprehensive communication strategy (ECCS) versus standard care on the rate of depressive symptoms at 3 and 6 months post ICU discharge in patients with severe Covid-19.

Methods: A longitudinal, quasi-experimental before-after, multicenter study was conducted in patients hospitalized in the ICU for severe COVID-19 (NCT05035563). The intervention consisted of a comprehensive and intensive strategy to facilitate communication between family, patients and healthcare team through written material, via web (tablet and webmaster) and telephone. Participants were evaluated 3 times: at ICU discharge and at 3 and 6 months post ICU discharge. Subjects completed a survey screening for anxiety and depression symptoms (Hospital Anxiety and Depression Scale—HADS), and post-traumatic stress disorder (Event Impact Scale-Revised—EIS-R). In addition, sociodemographic and clinical variables in addition to clinical outcomes of interest were collected. The results are reported using mean \pm standard deviation (SD) and percentages and compared using chi-square or t-test as deemed appropriate. The associations between risk factors and outcomes were presented as odds ratios (ORs) and 95% CIs, after adjustment for selected potential confounders. The study was approved by the ethics committee.

Results: A total of 444 patients were recruited between March 2021 and February 2022, of whom 351 patients corresponded to the control group or usual communication strategy and 93 patients to the intervention group or early and comprehensive communication strategy. Seventy-nine percent of the participants survived and only 2 patients died after hospital discharge. Follow-up was completed at 3 months post ICU discharge for 117 participants and at 6 months post ICU discharge for 65 patients. The demographic and clinical characteristics of the cohort are shown in Table 1. Participants were 63% male, the main comorbidities were obesity (56%), hypertension (30%) and diabetes II (21%). Participants had prolonged ICU and hospital stay, 65% of the cohort presented delirium in ICU and 29% (n = 119) required tracheostomy. 260 participants were in prone position during their ICU stay, with an average of 6.5 days in prone position, while 83% (n = 338) of the cohort required neuromuscular blockade in their treatment. Only 6% (n = 25) were readmitted to the ICU. In relation to psychological symptoms post ICU discharge, of the total subjects evaluated at 3 months post ICU discharge (n = 114), 21% presented anxiety, 20% depression and 36% PTSD; while at 6 months post ICU discharge follow-up (n = 65), 31% presented anxiety, 17% depression and 25% PTSD. Mixed-effects logistic regression analysis showed that the intervention under study decreased depressive symptoms (OR, 0.54; CI 0.25–1.15) and anxiety (OR, 0.83; CI 0.43–1.58), in the long term, but these results did not present statistical significance.

Conclusions: In this study concerning the effects of an early and comprehensive communication strategy on long-term psychological symptoms in patients hospitalized in ICU for severe COVID-19 in Chile, participants reported high rates of depression, anxiety, and long-term post-traumatic stress, however, there was no significant decrease in the interventional group.

Table 1 (abstract 000604) Patients demographics and clinical characteristics

Variable	Total n = 444	Usual communication strategy n = 351	ECCS n = 93	p-value
Age, media (SD)	53 (\pm 14)	52 (\pm 14)	59	<0.001
Gender, female n (%)	166 (37)	132 (38)	33 (35)	0.693
Charlson comorbidity index, media (SD)	2.5 (\pm 1.6)	2.44 (\pm 1.6)	2.9 (\pm 1.4)	0.020
SOFA Score, media (SD)	7 (\pm 3)	6.9 (\pm 3)	8.3 (\pm 2.4)	<0.001
APACHE II, media (SD)	17 (\pm 7)	16.9 (\pm 8)	16.8 (\pm 6)	0.966
Mechanical ventilation-days, media (SD)	26 (\pm 24)	26 (\pm 25)	23.1 (\pm 22)	0.437
Prone positioning, n(%)	260(64)	224 (69)	36 (42.3)	<0.0001
ECMO, n(%)	21 (5)	15 (4.3)	6 (6.4)	0.387
ICU LOS, media (SD)	30 (\pm 26)	30 (\pm 28)	30 (25)	0.987
Hospital LOS, media (SD)	44 (\pm 35)	45 (34)	41 (36)	0.372
Hospital mortality, n (%)	83 (21)	56 (18)	27 (33)	0.003

Abbreviations: APACHE II: acute physiology and chronic health evaluation II; SOFA: Chronic Health Evaluation II and Sequential Organ Failure Assessment Score; ECMO: Extracorporeal membrane oxygenation; ICU: intensive care unit; LOS: length of stay

References

1. Ministerio de Salud de Chile. Libro COVID-19 en Chile. Pandemia 2020–2022. Disponible en: <https://www.minsal.cl/libro-covid-19-en-chile-pandemia-2020-2022/>
2. Ekberg S, Parry R, Land V, Ekberg K, Pino M, Antaki C. Communicating with patients and families about difficult matters: A rapid review in the context of the COVID-19 pandemic. medRxiv. 2020 Jan 1
3. Akgün KM, Shamas TL, Feder SL, Schulman-Green D. Communication strategies to mitigate fear and suffering among COVID-19 patients isolated in the ICU and their families. Heart & Lung: The Journal of Cardiopulmonary and Acute Care. 2020 May 3.
4. Curtis JR, White DB. Practical guidance for evidence-based ICU family conferences. Chest. 2008
5. Magnus VS, Turkington L. Communication interaction in ICU—patient and staff experiences and perceptions. Intensive and Critical Care Nursing. 2006 Jun 1;22(3):167–80.
6. Fondecyt 1201772
7. COVID0921

Topic: Critical care organisation, quality management, information systems, outcomes

000605

Implementation in clinical practice of real-time mortality predictive model

S. Manrique¹, M. Ruiz-Botella², J. Gómez³, A. Ruiz¹, F. Esteban⁴, A. Rodríguez⁵, M. Bodí⁵

¹MEDICINA INTENSIVA, Hospital Universitari de Tarragona Joan XXIII, Tarragona, Spain; ²URV, Universitat Rovira i Virgili, Tarragona, Spain; ³Intensive Care Unit, Associate Professor at URV, PhD, Tarragona, Spain; ⁴Intensive Care Unit, Hospital Universitari de Tarragona Joan XXIII, Tarragona, Spain; ⁵Uci, Hospital Universitari de Tarragona Joan XXIII, Tarragona, Spain

Correspondence: S. Manrique

Intensive Care Medicine Experimental 2023, **11(Suppl 1)**:000605

Introduction: In the last decade, artificial intelligence, large databases and neural network models have been used to develop various predictive models. Many of these models aim to predict the mortality of

patients in the ICU using different variables. Despite achieving adequate AUC-ROC, none of them have been implemented in daily clinical practice. **Objectives:** Validating a predictive model of ICU discharge mortality using data extracted automatically from the clinical information system (CIS).

Define the data infrastructure to allow predictive model to be automatically implemented during the patient care process.

Methods: Prospective study in a 30-bed polyvalent ICU (Tarragona, Spain). All patients admitted to the ICU since the implementation of de CIS (2018–2022) were included. Variables for creating the predictive model were selected according to professional criteria (gender, admission type, admission reason, admission source, APACHE, SOFA, SpO₂/FiO₂, pH, creatinine, lactate, weight, height and RASS). Demographic variables, severity scores, ventilation parameters and laboratory data from the first 24 h after ICU admission was collected through the extraction, transformation and loading (ETL) process. The data was extracted using SQL and processed using Python. Null values were replaced through imputation. The 80% of the data was used to train a neural network model (multilayer perceptron) and the remaining 20% was used to validate the results.

To implement the real-time neural network model, it was isolated and inserted in compressed format into a Django project that runs in a Docker container from a server. Then, using Django and Python, the ETL process was replicated to feed the neural network model with real-time data. Finally, the model performs a patient mortality prediction that is saved and displayed on an ICU web map using HTML and Javascript (Figure 1).

Results: 3979 patient stays were included. Mortality was 15%. The model showed an accuracy of 81% and an AUC ROC of 80%. The model was integrated into de UCI maps, which show the current status of patients in real-time (Figure 2). Every time the map is accessed, the entire data pipeline is executed to obtain a mortality prediction for each patient. Clinicians are able to view the mortality prediction as a probability of death between 0 and 1. The model is not applied in patients with less than 24 h in the ICU due to lack of data.

Conclusions: Implementing the mortality prediction value obtained through a neural network based on real-time data with a complementary information tool, visible and actionable by the clinician, is the only way to assess its real impact on clinical practice.

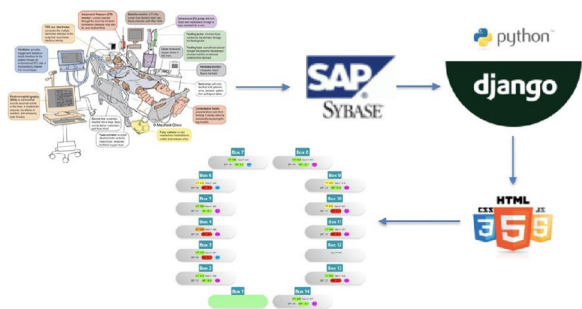

NOVA-BOX03



References

3. Li F, Xin H, Zhang J et al. Prediction model of in-hospital mortality in intensive care unit patients with heart failure: machine learning-based, retrospective analysis of the MIMIC-III database. *BMJ Open*. 2021 Jul 23;11(7):e044779.
4. Lu Z, Zhang J, Hong J, Wu J, Liu Y, Xiao W, Hua T, Yang M. Development of a Nomogram to Predict 28-Day Mortality of Patients With Sepsis-Induced Coagulopathy: An Analysis of the MIMIC-III Database. *Front Med (Lausanne)*. 2021 Apr 6;8:661710.
5. Mamandipoor B, Frutos-Vivar F, Peñuelas O et al. Machine learning predicts mortality based on analysis of ventilation parameters of critically ill patients: multi-centre validation. *BMC Med Inform Decis Mak*. 2021 May 7;21(1):152.
6. Wang H, Ou Y, Fan T, Zhao J, Kang M, Dong R, Qu Y. Development and Internal Validation of a Nomogram to Predict Mortality During the ICU Stay of Thoracic Fracture Patients Without Neurological Compromise: An Analysis of the MIMIC-III Clinical Database. *Front Public Health*. 2021 Dec 22;9:818439.
- Financiado por ISCIII beca FIS PI20/01674.
1. Sirgo G, Esteban F, Gómez J, Moreno G, Rodríguez A, Blanch L, et al. Validation of the ICUdMa tool for automatically extracting variables for a minimum dataset and quality indicators: The importance of data quality assessment. *Int J Med Inform*. 2018;112:166–72.
2. Hou N, Li M, He L et al. Predicting 30-days mortality for MIMIC-III patients with sepsis-3: a machine learning approach using XGboost. *J Transl Med*. 2020 Dec 7;18(1):462.

Topic: Critical care organisation, quality management, information systems, outcomes

000606

Health-related quality of life trajectories in critical illness: protocol for a Monte Carlo simulation study

B. S. Kaas-Hansen¹, M. Hylander Møller¹, M. B. N. Kjær¹, H. C. Thorsen-Meyer¹, M. E. Larsen¹, A. Perner¹, A. Granholm¹
¹Department of Intensive Care, Copenhagen University Hospital, Rigshospitalet, Copenhagen, Denmark

Correspondence: B. S. Kaas-Hansen
 Intensive Care Medicine Experimental 2023, 11(Suppl 1):000606

Introduction: Health-related quality of life (HRQoL) is a patient-important outcome enjoying increasing use in intensive care unit (ICU) trials [1]. Although it does capture salient aspects of clinical improvement in ICU patients that elude harder outcomes such as mortality, the most common approach of sampling HRQoL once after 6 or 12 months is suboptimal. Several aspects of HRQoL have recently been or are currently being reviewed [1–3], and an operationalisation is needed that both reconciles the seemingly paradoxical effect of interventions lowering mortality while hurting HRQoL [2] (caused by truncation due to death [4]) and is sensitive to early/accelerated improvement in patients who more quickly reach their eventual HRQoL level [5]. To this end, we propose the area under the HRQoL trajectory curve (AUTC) as a candidate solution.

Objectives: We will undertake an extensive Monte Carlo simulation study to gauge the performance of AUTC and compare it with that of the conventional single-sampling approach.

Methods: We will simulate 100,000 two-arm randomised clinical trials, as recommended by FDA when designing clinical trials [6], with equal fixed randomisation for each of 15,360 clinical scenarios. These scenarios arise by combining unique values of 7 simulation parameters such as sample size, 6-month mortality, proportion of mortality benefitters in the active arm and dampening effect of mortality on HRQoL at ICU discharge.

The clinical scenarios are based on published HRQoL values, and to the extent possible on EQ-5D, from real patients, to ensure the relevance of the results and insights for our population of interest: critically-ill patients potentially eligible for a randomised, embedded, multi-factorial, adaptive platform (REMAP) ICU trial [7] such as the Intensive Care Platform Trial (INCEPT, www.incept.dk).

We will simulate fortnightly HRQoL sampling to balance the desire for high temporal resolution with practical considerations. Intra-arm and intra-patient noise will be added; the former to reflect the spread of HRQoL within arms and the latter calibrated to yield an intra-class correlation of 0.80 (lower range of excellent agreement [8]). Finally, the resultant HRQoL levels will be connected with straight lines to yield one stepwise-linear HRQoL trajectory per fictive patient.

For each clinical scenario we will compute the following statistics:

1. HRQoL (mean, standard error, median, inter-quartile range) in survivors and all patients at end of follow-up; for the all-patient calculation, patients who die before end of follow-up will be assigned HRQoL=0
2. Absolute and relative cumulative attained HRQoL
3. Type-1 error rate and power for scenarios without and with effect in the active arm, respectively.

Results: We expect to have run all simulations by and present the results at LIVES 2023.

Conclusions: The results of this study will inform subsequent work on devising and testing a low-friction data-collection system to collate HRQoL trajectories from real ICU patients and quantify the effect sizes by way of Bayesian regression analyses, in future ICU trials and observational research.

References

1. 7. Angus DC, Alexander BM, Berry S, Buxton M, Lewis R, Paoloni M, et al. Adaptive platform trials: definition, design, conduct and reporting considerations. *Nature Reviews Drug Discovery*. 2019;18(10):797–807. <https://doi.org/10.1038/s41573-019-0034-3>
2. 6. U.S. Department of Health and Human Services. Adaptive Designs for Clinical Trials of Drugs and Biologics Guidance. U.S. Food and Drug Administration. 2019 November. Technical report.
3. 5. Hoffhuis J, Spronk P, van Stel H, Schrijvers G, Rommes J, Bakker J. The impact of critical illness on perceived health-related quality of life during ICU treatment, hospital stay, and after hospital discharge—A long-term follow-up study. *Chest*. 2008;133(2):377–385. <https://doi.org/10.1378/chest.07-1217>
4. 4. Colantuoni E, Scharfstein DO, Wang C, Hashem MD, Leroux A, Needham DM, et al. Statistical methods to compare functional outcomes in randomized controlled trials with high mortality. *BMJ*. 2018;360. <https://doi.org/10.1136/bmj.j5748>
5. 3. Kjær MN, Madsen MB, Møller MH, Egerod I, Perner A. Reporting and interpreting missing health-related quality of life data in intensive care trials: Protocol for a systematic review. *Acta anaesthesiologica Scandinavica*. 2019;63(6):796–801. <https://doi.org/10.1111/aas.13326>
6. 2. Pallanch O, Ortalda A, Pelosi P, Latronico N, Sartini C, Lombardi G, et al. Effects on health-related quality of life of interventions affecting survival in critically ill patients: a systematic review. *Crit Care*. 2022 May;26(1):126. <https://doi.org/10.1186/s13054-022-03993-3>
7. ** Granholm A, Anthon CT, Kjær MN, Maagaard M, Kaas-Hansen BS, Sivapalan P, et al. Patient-Important Outcomes Other Than Mortality in Contemporary ICU Trials: A Scoping Review. *Critical Care Medicine*. 2022. <https://doi.org/10.1097/CCM.0000000000005637>
8. 1. Feng Y, Kohlmann T, Janssen MF, Buchholz I. Psychometric properties of the EQ-5D-5L: a systematic review of the literature. *Quality of Life Research*. 2021;30(3):647–673. <https://doi.org/10.1007/s11136-020-02688-y>
9. This study is undertaken as part of the Intensive Care Platform Trial (INCEPT, www.incept.dk) programme, in turn funded by a grant from Sygeforsikringen “danmark” (2020–0320) with additional funding from Grosserer Jakob Ehrenreich og Hustru Grete Ehrenreichs Fond and Dagmar Marshalls Fond

Topic: Critical care organisation, quality management, information systems, outcomes

000607

Clonidine dose finding for sedation and delirium

E. Klaas¹, H. van den Oever², M. Arbouw³, M. Zeeman⁴, EVDH M⁵
¹Intensive Care, Deventer Hospital, Deventer, Netherlands; ²Intensive Care Unit, Deventer Hospital, Deventer, Netherlands; ³Department of Clinical Pharmacy, Deventer Hospital, Deventer, Netherlands; ⁴Department

of Clinical Geriatrics, Deventer Hospital, Deventer, Netherlands; ⁵Office of Science, Deventer Hospital, Deventer, Netherlands

Correspondence: E. Klaas

Intensive Care Medicine Experimental 2023, **11(Suppl 1)**:000607

Introduction: Clonidine is commonly used off-label in the intensive care (ICU) to manage sedation and agitation in critically ill patients. However, the optimal dose of clonidine as an add-on sedative in the ICU is unknown. The use of clonidine is associated with side effects such as hypotension and bradycardia. No formal dose-finding studies for clonidine as an add-on to standard sedation have been performed [1].

Objectives: The objective of the study was to provide a dosage recommendation for clonidine use in the ICU. Three aspects of clonidine were studied to determine the optimal dose within ventilated and sedated ICU patients: (1) hemodynamic adverse events (2) sedative effects and (3) *days alive without sedation and delirium*.

Methods: This was an exploratory study performed as a post-hoc analysis of a pharmacokinetic open-label study of clonidine in ventilated ICU patients [2]. The study included 24 mechanically ventilated and sedated adults admitted to a mixed medical and surgical ICU of the Deventer Hospital. Patients received clonidine after standard sedation with morphine, combined with midazolam or propofol. Patients received clonidine 600 (n=8), 1200 (n=8) or 1800 µg/day (n=8). Four patients in each group received a loading dose of 50% of the daily dose in 4 h. Richmond sedation scores, delirium scores, hemodynamic parameters and clonidine plasma levels were measured at several time points during follow up for a maximum of 9 days.

Results: No association was found between hemodynamic adverse events and clonidine dose (p=0.114). Patients who received a loading dose had a 1.7 fold higher incidence of hemodynamic adverse events (p=0.004). There was an association between the number of blood pressure events and the clonidine plasma concentration at each given time point (p=0.027). No association was found between the level of sedation and clonidine dose (β = -0.160, CI -0.338-0.017, p=0.077). The number of days alive without sedation and delirium was significantly higher in the 1800 µg/day group compared to the other two dose groups (p<0.001), Figure 1.

Conclusions: This pharmacodynamic study supports the use of clonidine at a fixed daily dose of 1800 µg/day as an add-on sedative and in the prevention of delirium in ventilated and sedated ICU patients. This recommended dosage should be used with caution and should be further investigated in a randomized clinical trial to confirm its safety and effectiveness in a larger patient population.

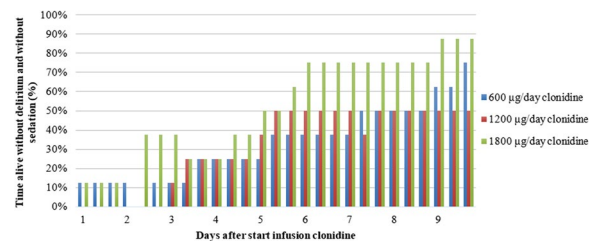

Figure 1 (abstract 000607) Patients alive without sedation and delirium comparing the clonidine dose groups. Data presented as the percentages of time patients were alive without sedation or delirium. Delirium and RASS scores were measured three times a day, every eight hours

References

1. 2. Cloesmeijer ME, van den Oever HLA, Mathot RAA, Zeeman M, Kruisdijk-Gerritsen A, Bles CMA, et al. Optimising the dose of clonidine to achieve sedation in intensive care unit patients with population pharmacokinetics. *Br J Clin Pharmacol*. 2020;86(8):1620–31.
2. 1. M. Zeeman, H.L.A. van den Oever, M. Arbouw, J. van der Valk, C. Kramers. Prolonged use of intravenous clonidine for sedation and analgesia in critically ill adult patients: systematic review. *Neth J Crit Care*. 2015;Volume 21, NO3.

3. Funded by Deventer Hospital Research Fund.

Topic: Sedation, analgesia and delirium

000609

Improvement of SSC guidelines compliance is associated with improvement of outcome of septic patients admitted to ICU: a quality improvement study

K. Belkhouja¹, A. Aljubairy¹, B. Aljedaani¹, W. Algarni¹, M. Jarad¹, M. Alshangeeti¹, H. Al-Sharif¹

¹Intensive Care Department, King Fahad Armed Forces Hospital, Jeddah, Saudi Arabia

Correspondence: K. Belkhouja

Intensive Care Medicine Experimental 2023, **11(Suppl 1)**:000609

Introduction: Sepsis and septic shock are major healthcare problems. The last Surviving Sepsis Campaign (SSC) guidelines were updated and published in 2021. The SSC guidelines compliance in our department is unknown and the impact on the outcome of the SSC guidelines compliance is not clear.

Objectives: To determine the rate of compliance with the SSC guidelines 2021 and the impact on the outcomes.

Methods: Retrospective and prospective, observational, quality improvement study of compliance to the SSC guidelines 2021, was conducted in King Fahad armed forces hospital, Kingdom of Saudi Arabia. The study had three periods (before and after study). The first period, Retrospective study (pre-intervention group) from November 1, 2021, to April 15, 2022, followed by an interventional period from April 15, 2022, to April 24, 2022. The third period is the prospective observational study (post-intervention group) from April 25, 2022, to March 25, 2023. All patients met the criteria for diagnoses of sepsis or septic shock and needs ICU admission were included. The exclusion criteria were patient who the decision of do not resuscitation (DNR) was activated within the first 3 days of ICU admission; pregnant patients; Drug overdose patient; Trauma or burn injury; Immunocompromised patients. During this period, we collect data using data collection sheet. The primary outcome was to evaluate the rate of compliance with SSC guidelines 2021 before and after intervention. The secondary outcomes were to assess the ICU morbidity and mortality before and after intervention. All statistical analysis was performed by using software Microsoft Excel and SPSS 20.0.

Results: A total of 161 patients with sepsis or septic shock were included, 77 patients in the pre-intervention group and 84 patients in the post-intervention group. The two groups were similar on term of baseline characteristics, and the severity of illness assessed by APACHE II score, SOFA score and requirement of organ support. In the pre-intervention group, the compliance to SSC guidelines was 35.1% (27 patients) versus 77.4% (65 patients) in the post-intervention group with $p < 0.001$. During ICU stay the complications was significantly higher in the pre-intervention group compared to post-intervention group (44.2% versus 23.8%; $p = 0.006$). The rate of ICU mortality during pre-intervention group was 28.6% (22 patients) versus 15.5% (13 patients) in the post-intervention group with $p = 0.044$ (OR, 0.45; 95% CI, 0.21–0.98). During ICU stay, the DNR decision was activated in 27 patients (35%) of the pre-intervention group versus 17 patients (20.2%) of the post-intervention group with $p = 0.035$.

Conclusions: Appropriate intervention induces significant improvement of compliance to SSC guidelines with significant reduction of ICU morbidity and mortality.

References

- Rhodes A, et al. The Surviving Sepsis Campaign bundles and outcome: results from the International Multicenter Prevalence Study on Sepsis (the IMPReSS study). *Intensive Care Med* 2015
- Evans L, et al. Surviving Sepsis Campaign: International Guidelines for Management of Sepsis and Septic Shock 2021. *Crit Care Med* 2021 (DOI: <https://doi.org/10.1097/CCM.00000000000005337>)
- We are indebted to the doctors and all staff with the Intensive Care Medicine Service who provide care for the patients included in the study.

Topic: Sepsis

000611

Prognosis survival score at admission for subarachnoid haemorrhage

L. Simón Miguel¹, B. Dopazo López¹, M. Mourelo Fariña¹, M. Sanchez De La Iglesia¹

¹Intensive Care Medicine, [CHUAC] University Hospital of A Coruña, A Coruña, Spain

Correspondence: L. Simón Miguel

Intensive Care Medicine Experimental 2023, **11(Suppl 1)**:000611

Introduction: Spontaneous subarachnoid haemorrhage is a rare cause of stroke, but it causes high mortality. Other studies describe a variable long term survival, using predicting models which doesn't count on physiological variables. The aim of this study is to develop a risk stratification survival score for HAS.

Methods: Retrospective study of 536 patients diagnosed with SAH admitted to the ICU of the University Hospital A Coruña 2003–2013.

Results: The middle age of the patients was 56.9 ± 14.1 years old. An aneurismatic lesion (A-SAH) was diagnosed in the 73.9% of the patients. The light disability of the patients after 6 months had middle values in the Glasgow Outcome Scale (GOS) and Rankin (mRS) around 4.3 ± 0.9 points and 1.5 ± 1.4 points respectively, and with a favorable recovery at 12 months GOS 4.6 ± 0.8 and mRS 1.0 ± 1.4 . A 16.3% of the patients discharged from the hospital passed away later. The survival score developed is composed by the variables independently associated with the survival: older age (HR = 1.02; $p = 0.001$), Fisher score (Fisher 3 HR = 1.82; $p = 0.033$) (Fisher 4 HR = 2.25; $p = 0.001$), APACHE II at 24 h (HR = 1.03; $p = 0.047$), and SOFA at day 0 (HR = 1.1, $p = 0.07$). For global survival after hospitalisation, based on the multivariate model, a nomogram was developed for predicting, in a patient admitted due to SAH, the estimated survival at 30 days, 6 months, 1 year, 5 years and 10 years after the episode.

The model showed an adequate discriminant capacity, with a C index of 0.797 and a corrected C index of 0.791. Likewise, it showed a good calibration at short-middle time but infraestimating the survival after 1 and 5 years.

Conclusions: One month after hospitalisation, two thirds of the patients were alive, and more than a half at 10 years. The main mortality cause during the first year was related with SAH, with a change from that moment to non related causes. The mortality was associated with older age, higher risk of complications in admission Fisher score, a higher severity for APACHE II in the first 24 h and SOFA at day 0, and the presence of rebleeding during ICU stay. The long term survival predictive model developed with the described variables has an adequate discrimination and calibration. That model doesn't require a previous etiological diagnosis and considers the initial organ dysfunction impact.

References

- Mourelo-Fariña M, Pérttega S, Galeiras R. A Model for Prediction of In-Hospital Mortality in Patients with Subarachnoid Hemorrhage. *Neurocrit Care*. 2021 Apr;34(2):508–518. <https://doi.org/10.1007/s12028-020-01041-y>. PMID: 32671649.

Topic: Neurointensive care

000613

Impact of diesel exhaust particles on the evolutive phenotype of acute respiratory distress syndrome

A. Gaudet¹, P. De Nadai², G. Piga¹

¹Intensive Care, CHU Lille - Center for Infection and Immunity of Lille, LILLE, France; ²U1019 Team 13, Pulmonary Immunity, University of Lille - Center for Infection and Immunity of Lille, Lille, France

Correspondence: A. Gaudet

Intensive Care Medicine Experimental 2023, **11(Suppl 1)**:000613

Introduction: The impact of diesel exhaust particles (DEP) on late-stage acute respiratory distress syndrome (ARDS) remains unknown. Published data suggest that prior exposure to DEP may increase the risk of progression to fibrosis in ARDS (1, 2).

Methods: After intranasal administration of DEP (10µg) at a rate of 3 times/week for 1 week, C57BL/6 male mice aged 6 to 8 weeks were exposed to LPS at a dose of 5 mg/kg (3) by intratracheal route. Three weeks after exposure to LPS, the alveolar inflammatory response was assessed by the count of immune cell populations in the bronchoalveolar lavage fluid (Figure 1). Mice exposed to PBS instead of DEP or LPS were used as controls.

Results: Macrophages represent most immune cells found in BAL for all mice. We find a higher value for BAL macrophages in mice exposed to DEP and LPS, compared than in mice exposed to DEP and PBS, or PBS and LPS (Figure 2).

Conclusions: Our preliminary results suggest a possible effect of pre-exposition to DEP on alveolar inflammation. We plan to conduct further explorations, including automated measurements of histological lung fibrosis (4) and evaluation of lung regional elasticity by atomic force microscopy (5), to complete these results.

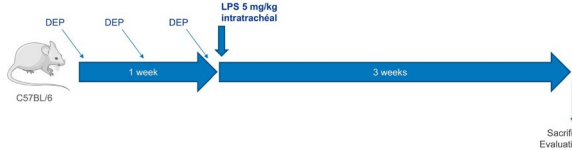

Figure 1 (abstract 000613) Experimental model

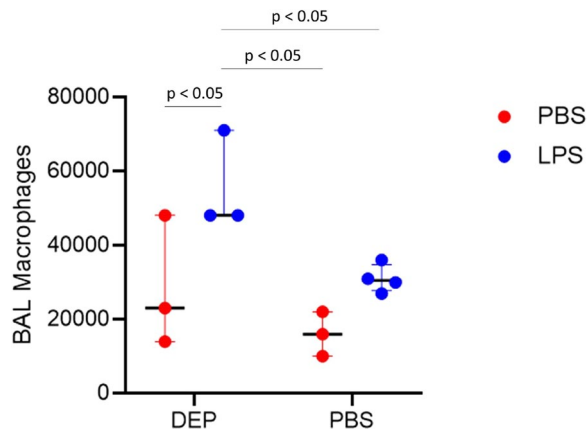

Figure 2 (abstract 000613) Counts of BAL macrophages

References

1. S. D. Sicard et al., "Aging and anatomical variations in lung tissue stiffness," *Am J Physiol Lung Cell Mol Physiol*, vol. 314, no. 6, pp. L946–L955, Jun. 2018
2. G. E. Courtoy et al., "Digital Image Analysis of Picrosirius Red Staining: A Robust Method for Multi-Organ Fibrosis Quantification and Characterization," *Biomolecules*, vol. 10, no. 11, p. 1585, Nov. 2020
3. Y. Li et al., "Pirfenidone ameliorates lipopolysaccharide-induced pulmonary inflammation and fibrosis by blocking NLRP3 inflammasome activation," *Mol Immunol*, vol. 99, pp. 134–144, Jul. 2018
4. N. de Souza Xavier Costa et al., "Air pollution impairs recovery and tissue remodeling in a murine model of acute lung injury," *Sci Rep*, vol. 10, no. 1, p. 15314, Sep. 2020
5. R. Yanagisawa et al., "Enhancement of acute lung injury related to bacterial endotoxin by components of diesel exhaust particles," *Thorax*, vol. 58, no. 7, pp. 605–612, Jul. 2003

Topic: Translational Medicine

000614

Monitoring of the respiratory drive during mechanical ventilation by the muscle pressure

G. Guidetti¹, J. Luna Castro¹, C. García Lozano¹, M. J. Delgado Amaya¹, A. M. Baena Angulo², J. M. Serrano Simón²

¹Intensive Care Unit, Hospital Regional Universitario de Málaga, Málaga, Spain; ²Intensive Care Unit, Hospital Regional Universitario Reina Sofía, Córdoba, Spain

Correspondence: J. M. Serrano Simón

Intensive Care Medicine Experimental 2023, **11(Suppl 1)**:000614

Introduction: Lung and diaphragmatic injury can be related to an excessive respiratory drive during mechanical ventilation (MV) (1). Usually, it is assessed by the airway occlusion pressure (Pocc) or by the esophageal pressure (2).

Objectives: To evaluate a new approach for monitoring the respiratory drive that utilizes the muscle pressure (Pmus) signal generated by equation motion (EM). This signal allows us to identify the real neural inspiratory time (3). For our purpose, we designate, T0: Tonset effort, T1: Tonset of inspiratory flow. We hypothesized, therefore that T0-T1 is indicative of isometric muscle (Figure 1); and it could be useful to measure D pressure at 100 ms (P100) continuously, without the inconveniences due to occlusions and esophageal catheter. Our goal was to compare the measurement of Pmus, at 100 ms with the data obtained from the Pocc.

Methods: We studied a group of mechanically ventilated patients during the weaning time, with different levels of support, instrumented with esophageal/gastric/tracheal, airway pressure (Paw) and flow. Pmus was calculated applying the equation of motion (EM) by means of respiratory mechanics, calculated using standard methods. 200 cycles was analysed. We chose the maximum sensitivity of the trigger allowed by the ventilator. After an occlusion manoeuvre was performed, Pocc 100 was measured in Paw signal between 0 and 300 ms (ms) after the occlusion, in which the regression of the Paw every 100 ms, obtain the highest slope and R2 > 0.95 (Figure 1). Ten consecutive regular cycles prior to occlusion were analyzed to measure the Pmus 100 between T0-T1, carry out by regressions every 50 ms, searching for the optimal slope with R2 > 0.95; and compared with the data obtained from an occlusion. Demographics data was recording. The results are expressed as mean ± SD, median (IRQ), or percentage. The comparisons by t-student. Bland–Altman and linear regression analyses were performed (Figure 2).

Results: Patients N 27. Age: 64.22 ± 8.10 years. Males 74.2%. PaO₂/FiO₂ 265.72 ± 121.47. Diagnosis: SARS-COV2 8. ARDS-pneumonia 4. Lung transplant 4. Cardiac Surgery 2. Abdominal sepsis 3. Trauma 4. Others 2. Days MV 6 (1.74–15). Inspiratory pressure 10.55 ± 5.22; PEEP 7.56 ± 1.95 cmH₂O. Elastance (Ers): 22.99 ± 6.45 cmH₂O/L; Total resistances (Rrs): 14.69 ± 4.45 cmH₂O/L/s.

Conclusions: The measurement of the respiratory drive by means of the Pmus signal is precise, and non-intrusive, and allows its continuous monitoring. This method can be incorporated into the ventilator monitoring.

Table (abstract 000614) Agreement of the measurements of P100 between the both methods: Pmus vs Pocc. Note no significant differences and high correlation between both methods

P100, cmH ₂ O	Mean (SD)	P	Means Difference (SD)	Limits agreement, CI 95%	R ²
All Data	Pmus	0.696	-0.14 (0.21)	-0.57 a 0.28	0.99
	Pocc				
High PSV	Pmus	0.761	-0.15 (0.22)	-0.58 a 0.28	0.98
	Pocc				
Middle PSV	Pmus	0.125	-0.17 (0.21)	-0.59 a 0.25	0.99
	Pocc				
Low PSV	Pmus	0.833	-0.11 (0.21)	-0.53 a 0.32	0.98
	Pocc				

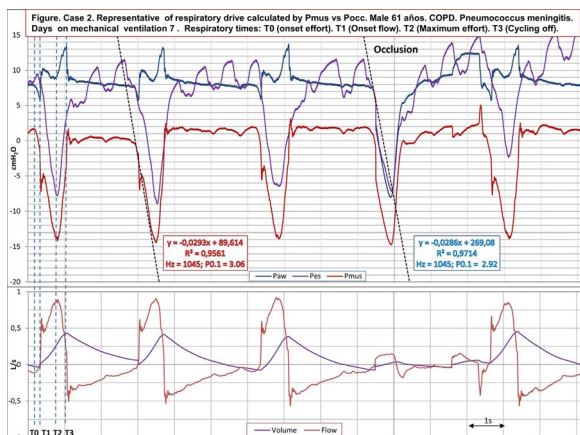

Figure of representative case. Shown the methods of measurement.

References

1. Mascheroni DE, Kolobow T, Fumagalli R, Moretti MP, Chen V, Buckhold D, Acute respiratory failure following pharmacologically induced hyperventilation an experimental animal study. *Intensive Care Med*. 1988;15(1):8–14.
2. Whitelaw W A, Derenne JP, Milic-Emili J. Occlusion pressure as a measure of respiratory center output in conscious man. *Respiratory Physiology* 1975; 23, 181–199.
3. Younes M, Brochard L, Grasso S, Kun J, Mancebo J, Ranieri M, Richard J-C, Younes H. A method for monitoring and improving patient: ventilator interaction. *Intensive Care Med* 2007 33:1337–1346.

Topic: Acute respiratory failure and mechanical ventilation

000615

Prognostic value of the percent change in NIHSS and glucose in acute ischemic stroke patients: a retrospective cohort study with survival analysis

O. L. Medina Espitia¹, J. O. Casallas-Barrera², C. Poveda-Henao², M. M. Zúñiga Castrillón², P. C. Flórez Navas³, B. I. Quiroga Corredor⁴, F. Cortes-Muñoz², J. Perea Ronco⁵, A. Fonnegra-Caballero⁷, J. F. Torres Zafra⁸

¹Internal Medicine and Endocrinology, Fundación Clínica Shaio, Bogotá, Colombia; ²Critical Care Medicine., Fundación Clínica Shaio, Bogotá, Colombia; ³Critical Care Resident, Universidad de La Sabana, Chía, Colombia; ⁴Research Department, Fundación Clínica Shaio, Bogotá, Colombia; ⁵Direction of Research, Fundación Clínica Shaio, Bogotá, Colombia; ⁶Pathology and Hemovigilance, Fundación Clínica Shaio, Bogotá, Colombia; ⁷Neurosurgery and Neurointerventional Surgery, Fundación Clínica Shaio, Bogotá, Colombia; ⁸Neurology, Fundación Clínica Shaio, Bogotá, Colombia

Correspondence: J. Casallas

Intensive Care Medicine Experimental 2023, 11(Suppl 1):000615

Introduction: Stroke is one of the leading causes of mortality and disability worldwide. Stroke severity measured by the baseline National Institutes of Health Stroke Scale (NIHSS) is a strong predictor of clinical outcomes in acute ischemic stroke (AIS). On the other hand, alterations in glucose (GLC) have been associated with stress and outcomes in AIS. In a Latin American population, we analyzed the percentage change in NIHSS (%ΔNIHSS) and glucose (%ΔGLC) at 24 h as a prognostic tool to predict hospital survival.

Objectives: This study describes the demographic characteristics, clinical outcomes and prognostic utility of %ΔNIHSS and %ΔGLC at 24 h in patients treated with intravenous thrombolysis within 4.5 h of AIS.

Methods: A retrospective cohort of patients admitted between 2007 and 2022 in Bogotá, Colombia, was studied. Subjects diagnosed with AIS and treated with intravenous alteplase who required Intensive Care Unit (ICU) were included and baseline characteristics, etiology, and in hospital

outcomes were measured. %ΔNIHSS was defined as $([admission\ NIHSS\ score - 24\ h\ NIHSS\ score] \times 100 / admission\ NIHSS\ score)$ and %ΔGLC as $([admission\ GLC - 24\ h\ GLC] \times 100 / admission\ GLC)$. Receiver operating characteristic curve (ROC) analysis was done in order to establish cut-points for %ΔNIHSS and %ΔGLC values. Descriptive and inferential statistics were performed as well as survival analysis techniques (Kaplan–Meier survival estimation and Cox-Proportional Hazard Model).

Results: We analyzed the outcome in 254 patients. The median age was 71 years, 128 (50.3%) were females. Significant demographic variables found were age, chronic kidney disease, heart failure, atrial fibrillation, carotid stenosis, and Charlson comorbidity index ($p < 0.005$). All patients were admitted to the ICU. The median duration of hospital stay in patients who survived was 8 days (interquartile range— IQR—6–14), in those who did not survive, it was 6 days (interquartile range— IQR—4–12). ROC curve comparison AUC 0.8776 showed that a %ΔNIHSS > 20 was a predictor for survival (HR: 0.109; 95% CI 0.03–0.33 $p < 0.001$) (Figure 1). In a multivariate model, the %ΔNIHSS > 20 continued to be an excellent predictor for survival (HR: 0.117; 95% CI 0.03–0.36 $p < 0.001$), compared to the %ΔGLC > 2 AUC 0.6113 (HR: 0.538; 95% CI 0.21–1.34 $p = 0.184$) (Figure 2). The Kaplan–Meier curve shows a statistically significant difference in survival probability between %ΔNIHSS ≥ 20 and %ΔNIHSS ≤ 20 (Figure 3).

Conclusions: This study demonstrates the prognostic value of the %ΔNIHSS > 20 for AIS. To our knowledge, this is the first description in the literature of the %ΔGLC as a potential prognostic value in AIS. Prospective and bigger studies are required to address the true added value of the %ΔGLC. %ΔNIHSS is a useful, feasible, and a universal prognostic tool for AIS.

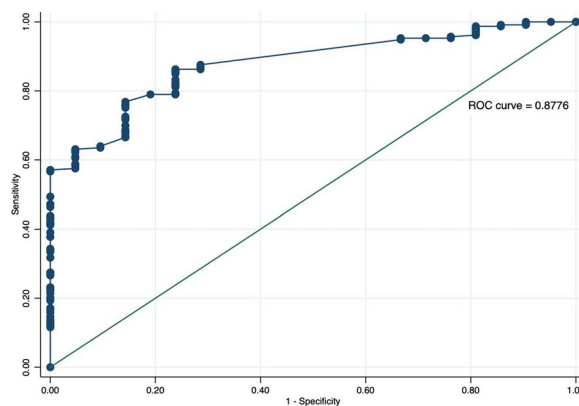

Figure 1 (abstract 000615) Receiver operating characteristics analyses for the prediction of hospital survival %ΔNIHSS > 20

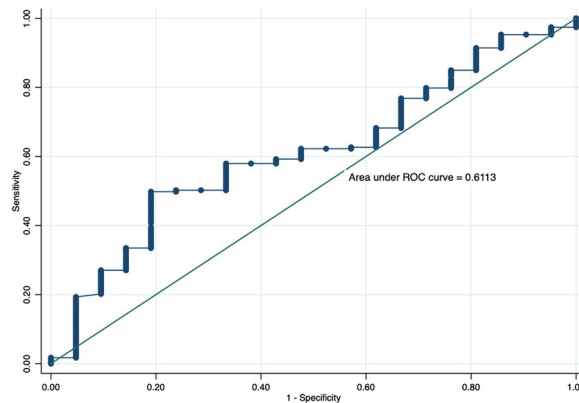

Figure 2 (abstract 000615)

Receiver operating characteristics analyses for the prediction of survival %ΔGLC > 2

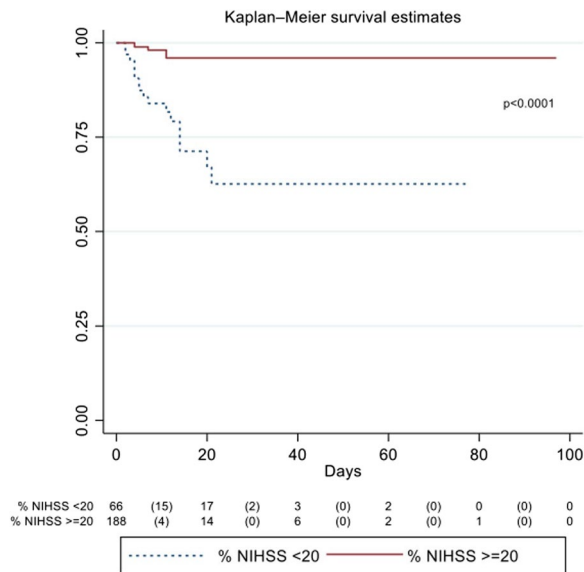

Figure 3 (abstract 000615) Kaplan–Meier curve for survival in AIS

References

1. Wouters A, Nysten C, Thijs V, Lemmens R. Prediction of Outcome in Patients With Acute Ischemic Stroke Based on Initial Severity and Improvement in the First 24 h. *Front Neurol*. 2018;9:308.
2. Hacke W, Kaste M, Bluhmki E, Brozman M, Davalos A, Guidetti D, et al. Thrombolysis with alteplase 3 to 4.5 h after acute ischemic stroke. *N Engl J Med*. 2008;359(13):1317–29.
3. Favate AS, Younger DS. Epidemiology of Ischemic Stroke. *Neurol Clin*. 2016;34(4):967–80.
4. Ribo M, Molina C, Montaner J, Rubiera M, Delgado-Mederos R, Arenillas JF, et al. Acute hyperglycemia state is associated with lower tPA-induced recanalization rates in stroke patients. *Stroke*. 2005;36(8):1705–9.
5. National Institute of Neurological Disorders and Stroke rt-PA Stroke Study Group. Tissue plasminogen activator for acute ischemic stroke. *N Engl J Med*. 1995;333(24):1581–1587.
6. This study belongs to The sTroke sHalo NetworK INvestiGators (THINK-ING) group.
7. The authors received no grant support for this study.

Topic: Neurointensive care

000619

Improving emergency airway planning on a district general hospital intensive care unit: results and barriers

J. Gibson¹, N. Botting²
¹Critical Care, East Surrey Hospital, Redhill, United Kingdom; ²Critical Care, Worthing Hospital, Worthing, United Kingdom

Correspondence: J. Gibson

Intensive Care Medicine Experimental 2023, 11(Suppl 1):000619

Introduction: The fourth National Audit Project of the Royal College of Anaesthetists and the Difficult Airway Society evidenced that approximately one-quarter of major airway complications occur outside of the theatre environment, in areas that include the intensive care unit [1]. When major airway events occurred, they commonly led to death or severe neurological disability. Recommendations were made that

included planning and documentation for ‘inadvertent tracheal tube or tracheostomy displacement or obstruction’ in critical care [1].

Objectives: We sought to establish whether the creation of a dedicated electronic form improves documentation of emergency airway management plans for patients with a tracheal tube or tracheostomy in the critical care environment. Barriers to completion were considered.

Methods: An initial audit of emergency airway plan documentation was performed for all patients with a tracheostomy admitted to the critical care unit of a district general hospital over a three-year period (February 2019–January 2022). Subsequently, an emergency airway management form was created (Figure 1) on the hospital critical care information system (IntelliSpace Critical Care and Anaesthesia, Philips). A re-audit was undertaken to establish completion rates of this emergency airway management document for all patients with a tracheal tube or tracheostomy.

Results: Pre-intervention, zero percent of patients (0 of 62) cared for with a tracheostomy over a three-year period had documented plans for emergency airway management. Following the creation of the dedicated electronic emergency airway management plan form, accompanied by education and inclusion of the form in the daily safety huddle, completion rates increased to 26.8% (36/134) for patients with tracheostomies or tracheal tubes.

Conclusions: Documentation of an emergency airway management plan remained low, despite education and the creation of a dedicated electronic form. This continues to expose patients to unnecessary risk in the event of a major airway complication occurring during their admission to this district general hospital critical care unit. Possible explanations are numerous, but locally may include the rotation of critical care trainees every few months, inadequate teaching intervals and the burden of electronic documentation. Suggested ways to improve completion rate include regular educational refresher sessions to critical care staff members, inclusion of the form during the induction of new critical care staff and making the electronic form compulsory at the time of critical care admission, given completion of forms is improved in other areas of healthcare when these are made compulsory [2, 3]. These simple interventions may greatly improve emergency airway planning and reduce the risk of preventable morbidity in the event of a major airway emergency.

Figure 1 (abstract 000619) Layout and content of the ‘Airway Management Plan’ form created on the critical care information system

References

2. Nelson E, Reynolds P. Inpatient Falls: Improving assessment, documentation, and management. *BMJ Qual Improv Rep.* 2015; 4(1):u208575. w3781. <https://doi.org/10.1136/bmjquality.u208575.w3781>.
3. Vukanic D, Kelly EG, Cleary SM. Does an Orthopedic Ward Round Pro Forma Improve Inpatient Documentation? *J Patient Saf.* 2021 17(8):553–556. <https://doi.org/10.1097/PTS.0000000000000678>.
- Nil to declare.
1. Cook TM, Woodall N, Harper J, Benger J, Fourth National Audit Project. Major complications of airway management in the UK: results of the Fourth National Audit Project of the Royal College of Anaesthetists and the Difficult Airway Society. Part 2: intensive care and emergency departments. *British Journal of Anaesthesia* 2011; 106: 632–42.

Topic: Trauma

000620

Diaphragm excursions as proxy for tidal volume during spontaneous breathing

T. Janssen¹, A. Jonkman¹, M. Wennen¹, E. J. Wils², H. E. Endeman¹, L. Heunks¹¹Intensive Care, Erasmus University Medical Center, Rotterdam, Netherlands; ²Intensive care, Franciscus Gasthuis, Rotterdam, Netherlands

Correspondence: T. Janssen

Intensive Care Medicine Experimental 2023, **11(Suppl 1)**:000620

Introduction: Respiratory rate is an important indicator of respiratory failure, however, upon increased respiratory loading, changes in tidal volume precede increases in respiratory rate (1). TV measurement in non-intubated critically ill patients is challenging given the need for accurate flow measurements. We hypothesized that measurement of diaphragm excursion (DE) could serve as surrogate for TV.

Objectives: The aim was to determine the relationship and correlations between changes in TV and DE within healthy volunteers and patients on invasive mechanical ventilation (IMV).

Methods: Patients with tracheostomy, BMI > 35 kg/m², exacerbation of obstructive lung disease, neuromuscular disease or diaphragm paralysis were excluded. This prospective study was executed in two hospitals in the Netherlands after ethical approval. TV-DE relationships were investigated using a linear mixed model with DE as fixed effect with a random intercept per participant. Simultaneous measurements of TV and DE were obtained in ≥ 3 breaths per participant. The right hemidiaphragm was visualized using subcostal ultrasound in M-mode. To determine TV, healthy volunteers were breathing through a mouthpiece with flow sensor connected to a signal acquisition system while wearing a nose clip. In patients on IMV measurements were performed during CPAP (5 cmH₂O).

Results: IMV patients (N = 21) and healthy volunteers (N = 20) yielded 471 analyzable breaths. The models indicated an excellent association within participants (R² = 0.96 in IMV patients, R² = 0.90 in healthy volunteers, Figure 1). The TV-DE ratio was 201 (161–240) mL/cm in IMV and 361 (294–428) mL/cm in healthy volunteers. However, the variability of the DE and TV relationship between participants was considerable. Estimation of absolute TV by DE using the models showed large differences between observed TV and TV predicted by the model, illustrated with Bland–Altman analysis in Figure 2.

Conclusions: The difference in TV-DE ratio between IMV patients and healthy volunteers may be explained by a smaller distribution of TV in IMV patients. Also, underlying Ventilator-induced Diaphragmatic Dysfunction (2) possibly decreased the TV-DE ratio in IMV patients compared to healthy volunteers.

Despite a strong relationship between changes in DE and TV within participants, the large variability in the data precludes a reliable estimation of TV from the absolute value of DE. Possibly, consecutive measurements of DE to monitor changes in DE within patients with respiratory failure may indicate clinical deterioration. Since diaphragm motion is multidimensional (3), the novel speckle tracking technique could enable better measurement of DE by quantifying diaphragm motion in multiple dimensions (4).

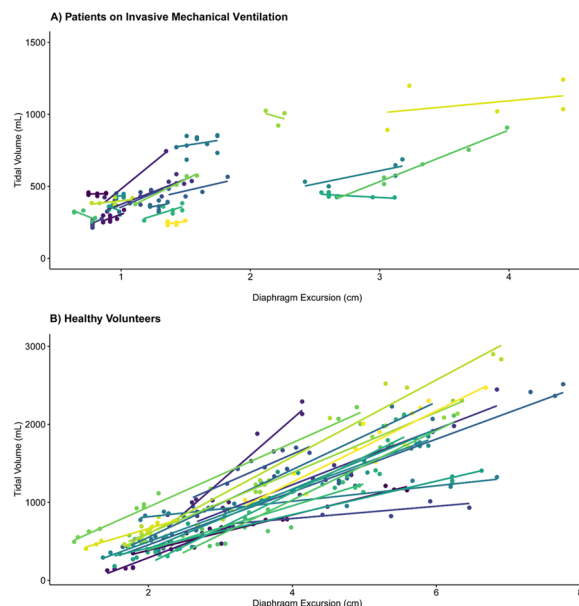

Figure 1 (abstract 000620) Correlation between Diaphragm Excursion and Tidal volume per participant, separated for patients on invasive mechanical ventilation and healthy volunteers. Both patients on invasive mechanical ventilation and healthy volunteers are included, every participant has a different color

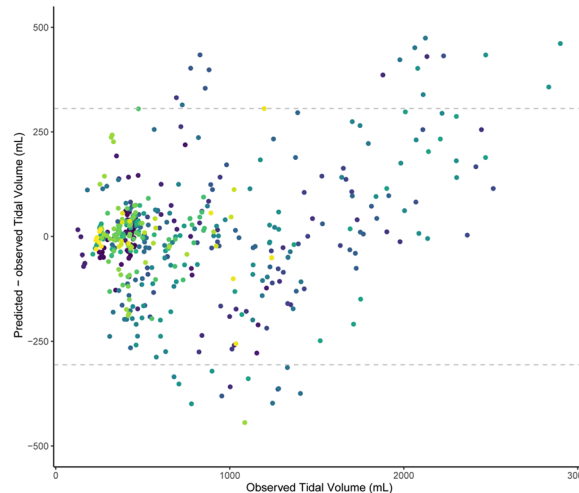

Figure 2 (abstract 000620) Bland–Altman plot showing the association between observed and predicted Tidal Volumes, based on the linear mixed model. Both patients on invasive mechanical ventilation and healthy volunteers are included, every participant has a different color

References

- This study was partly funded by an unrestricted grant by Fisher & Paykel Healthcare.
1. Vaporidi K, Akoumianaki E, Telias I, Goligher EC, Brochard L, Georgopoulos D. Respiratory Drive in Critically Ill Patients. Pathophysiology and Clinical Implications. *Am J Respir Crit Care Med.* 2020;201(1):20–32.
2. Vassilakopoulos T, Petrof BJ. Ventilator-induced diaphragmatic dysfunction. *Am J Respir Crit Care Med.* 2004;169(3):336–41.

4. 3. Oppersma E, Hatam N, Doorduyn J, van der Hoeven JG, Marx G, Goetzenich A, et al. Functional assessment of the diaphragm by speckle tracking ultrasound during inspiratory loading. *J Appl Physiol* (1985). 2017;123(5):1063–70.
5. 4. Huang D, Song F, Luo B, Wang S, Qin T, Lin Z, et al. Using automatic speckle tracking imaging to measure diaphragm excursion and predict the outcome of mechanical ventilation weaning. *Critical Care* (London, England). 2023;27(1):18.

Topic: Acute respiratory failure and mechanical ventilation

000621

An increase in microvascular reactivity from near-infrared spectroscopy (NIRS) is related to an increase in oxygen consumption after fluid challenge in patients with circulatory shock

K. Cheerasiri¹, S. Thertchanakun², S. Morakul², W. Mongkolpun³

¹Critical Care Medicine, Ramathibodi Hospital, Bangkok, Thailand; ²Anesthesiology, Faculty of Medicine Ramathibodi Hospital, Mahidol University, Bangkok, Thailand; ³Critical Care, Faculty of medicine Siriraj Piyamaharajkarun Hospital Mahidol University, Bangkok, Thailand

Correspondence: W. Mongkolpun

Intensive Care Medicine Experimental 2023, **11(Suppl 1)**:000621

Introduction: The ultimate goal of fluid challenge (FC) is to reduce tissue hypoxia which would be confirmed by an increase in oxygen consumption (VO₂) following oxygen delivery (DO₂) after FC. Microvascular reactivity was assessed non invasively by near-infrared spectroscopy (NIRS) with a vascular occlusion test (VOT) at bedside. We aimed to evaluate whether the change of microvascular reactivity was related to an increase in VO₂ after FC.

Methods: Circulatory shock patients with atrial catheterization (mean arterial pressure (MAP) < 65 mmHg or the need of a vasopressor to maintain MAP ≥ 65 mmHg with ≥ 1 sign of poor tissue perfusion (oliguria, alteration of consciousness, cold clammy skin, lactate levels ≥ 2 mmol/L) who required FC (250 ml of crystalloid for 10 min) within the first 24 h were included. A cardiac index (CI) rating was obtained by pulse contour analysis (Hemosphere®, Edwards). Hemodynamic variables, lactate levels, central venous oxygen saturation (ScvO₂), capillary refill time (CRT) (index finger, contra lateral site of NIRS), thenar muscle oxygen saturation (StO₂) (FORE-SIGHT Elite®, Edwards) and VOTs were obtained before and after FC. VOTs were performed by inflating an arm-cuff to a pressure of 40 mmHg above systolic blood pressure for 3 min. The descending (Desc) and ascending (Asc) StO₂ slopes were calculated. Patients were divided by the function of ΔCI and ΔVO₂ ≥ 15%.

Results: 28 shock patients were included. 26 of the 28 patients (93%) had septic shock and a SOFA score of 11 (9–14). 11 of the 28 patients (39%) were fluid responders. All patients received norepinephrine with a median dose of 0.2 (0.1–0.6) mcg/kg/min. The time of inclusion was 3 (3–7) hours and the amount of fluid resuscitation before inclusion was 3.4 (2.0–5.9) L.

Before FC, only CI was greater in the fluid responders (FRs) than in the non fluid responders (non-FRs) (Figure 1). There were no differences in baseline hemodynamic variables, DO₂, VO₂, CRT, ScvO₂, StO₂, Asc and Desc StO₂ slopes between the VO₂ responders and the VO₂ non responders (Figure 1).

Comparing the FRs and non-FRs after FC, CI, DO₂ and CRT increased only in the FRs (Figure 1). Among the FRs, only Asc slope increased in the VO₂ responders (Figures 1, 2). There was no correlation between baseline hemodynamic variables, ScvO₂, lactate, CRT, StO₂, Asc, Desc StO₂ slope and baseline VO₂.

Conclusions: In shock patients, microvascular reactivity increased after FC only in VO₂ responders.

	Fluid responders (n=11)						Fluid non responders (n=17)	
	Fluid responders (n=11)		VO2 responders (n=7)		VO2 non responders (n=4)		Before FC	After FC
	Before FC	After FC	Before FC	After FC	Before FC	After FC		
MAP (mmHg)	77 (61-81)	77 (67-94)	81 (62-89)	85 (71-102)	72 (59-81)	76 (70-81)	74 (72-88)	81 (70-86)
Heart rate (bpm)	122 (83-143)	116 (84-144)	102 (83-132)	102 (84-142)	133 (105-145)	128 (102-144)	102 (85-120)	100 (85-118)
Central venous pressure (mmHg)	11 (4-12)	11 (4-15)	12 (5-12)	12 (6-14)	11 (7-12)	11 (7-13)	12 (10-14)	13 (10-16)
CI (L/min/m ²)	2.8 (2.0-3.1)	3.3 (2.9-4.2) ^a	2.8 (2.2-2.8)	3.3 (2.4-3.5) ^a	3.3 (2.4-3.6)	4.3 (3.6-4.5)	2.4 (2.1-3.2)	2.5 (2.2-3.3)
Lactate levels (mmol/L)	2.3 (1.3-5.7)	2.6 (1.8-5.7)	3.1 (2.1-4.7)	3.4 (1.8-4.3)	3.9 (1.7-10.9)	3.8 (1.5-11.5)	3.5 (2.5-5.7)	3.7 (2.2-5.3)
Central venous oxygenation (%)	71 (68-79)	73 (67-77)	69 (68-71)	71 (67-74)	79 (77-85)	79 (78-79)	75 (68-85)	76 (72-83)
DO ₂ (ml/min/m ²)	363 (260-388)	435 (348-498) ^a	313 (260-374)	412 (348-469) ^a	413 (314-441)	478 (382-563)	321 (286-393)	327 (260-411)
VO ₂ (ml/min/m ²)	70 (51-98)	86 (67-123)	60 (51-85)	101 (68-123) ^a	98 (55-134)	76 (41-130)	87 (68-98)	79 (65-113)
CRT (seconds)	5.47 (3.35-7.04)	4.97 (3.12-5.68) ^a	5.42 (3.33-7.02)	4.56 (3.12-5.68)	6.29 (4.20-7.30)	5.34 (4.09-6.01)	4.92 (3.42-6.15)	4.92 (3.12-5.78)
StO ₂ (%)	63 (60-67)	62 (60-65)	62 (58-65)	61 (58-65)	67 (63-67)	65 (64-66)	62 (60-64)	61 (55-65)
Desc slope StO ₂ (%/min)	6.0 (3.6-11.0)	9.0 (4.0-9.6)	8.3 (3.6-11.0)	9.6 (5.3-12.3)	4.8 (3.6-8.8)	4.6 (3.5-7.3)	5.0 (3.7-6.6)	4.6 (4-7)
Asc slope StO ₂ (%/min)	41.2 (24-58.5)	55.5 (22.5-67.5)	41.2 (25.6-58.5)	55.5 (51-67.5) ^a	34.5 (21-54)	30.7 (13.9-82.5)	42.0 (19.5-57.0)	24.0 (14.0-66.0)

^ap<0.05- Before FC vs After FC in the same group, ^bp<0.05 Fluid responders vs Fluid non responders

Figure 1 (abstract 000621) Baseline hemodynamic variables, CRT, StO₂ including Asc, Desc slope in FRs vs non-FRs and VO₂ responders vs VO₂ non responders. ^ap<0.05 Before FC vs after FC in the same group, ^bp<0.05 Fluid responders vs Fluid non responders

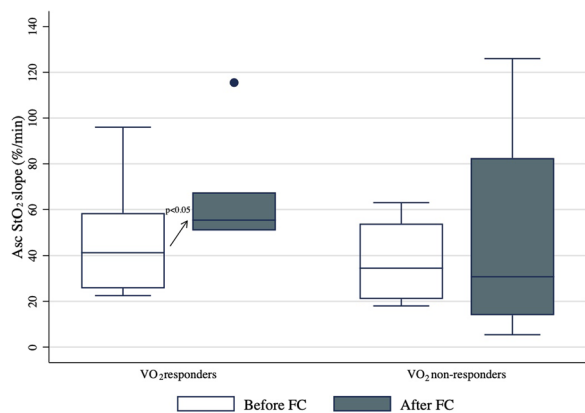

Figure 2 (abstract 000621) Asc StO₂ slope before and after FC in VO₂ responders and VO₂ non-responders

Topic: Cardiovascular issues in ICU

000622

Clinical performance of high-flow nasal cannula devices under different simulated environmentsR. Wen¹, X. Lixin², Z. Zhao³, X. Fei²

¹College of Pulmonary and Critical Care Medicine, Chinese PLA General Hospital, Beijing, China; ²College of Pulmonary and Critical Care Medicine, Chinese PLA General Hospital, Beijing, China; ³Institute of technical medicine, Furtwangen University, Villingen-Schwenningen, Germany

Correspondence: R. Wen*Intensive Care Medicine Experimental* 2023, **11(Suppl 1)**:000622

Introduction: The atmospheric pressure and air-oxygen percentage in highland regions vary with changes in altitude. Differences in environmental conditions may affect precision instruments within HFNC devices, which influences the temperature, humidity, flow rate, and oxygen concentration of the delivered gas. Therefore, it is important to determine whether HFNC devices are influenced by different ambient temperatures, ambient humidities, and altitude conditions, which could inform the selection of suitable devices based on environmental conditions.

Objectives: This study aimed to investigate the clinical performance of high-flow nasal cannula (HFNC) oxygen therapy devices in different simulated environments with various ambient temperatures, humidity levels, and altitudes.

Methods: Four representative regions were selected with various combinations of ambient temperatures, humidities, and altitudes. The temperature accuracy, flow rate accuracy, oxygen concentration accuracy, and humidification ability of four types of HFNC devices were tested in a multi-parameter environment simulation cabin. Then, an HFNC clinical evaluation scoring system was used to evaluate the clinical performance of the HFNC devices in different environments. Moreover, to measure the volume of accumulated condensate in the HFNC devices within different simulated environment. The HFNC devices were continuously operated for 6 h in three simulated environments with different altitudes but identical ambient temperature and humidity levels. Finally, the possibility to establish an environmental correction algorithm using test results was demonstrated.

Results: We found that the temperature accuracy, flow accuracy, oxygen concentration accuracy, and humidification ability of all HFNC devices were influenced by simulated high and extreme altitude environments, with differences in the clinical performance stabilities across the different types of HFNC devices. Additionally, all HFNC devices showed significant abnormal changes in the condensate volume in the simulated high and extreme altitude environments. The volume of accumulated condensate more than 100 ml at a simulated altitude of 3000 m and 4000 m in three HFNC devices. The test results were used to derive a temperature correction formula applicable to altitudes of up to 3000 m above sea level for correcting the actual temperatures of gas delivered by the HFNC devices.

Conclusions: Taken together, changes in the clinical performance of different HFNC devices showed complex differences according to the simulated environment. HFNC devices and their parameter settings should be selected based on the external environment and individual characteristics of each device.

The experimental process and test method.

References

1. Wen, R., et al., High-flow nasal cannula: Evaluation of the perceptions of various performance aspects among Chinese clinical staff and establishment of a multidimensional clinical evaluation system. *Front Med (Lausanne)*, 2022. 9: p. 900958
2. Burtcher, M., et al., Extreme Terrestrial Environments: Life in Thermal Stress and Hypoxia. A Narrative Review. *Front Physiol*, 2018. 9: p. 572
3. Yes

Topic: Acute respiratory failure and mechanical ventilation

000623

Impact of implementing multidisciplinary daily rounds in a Brazilian poorly resourced public ICU on clinical outcomes: a retrospective studyH. Sousa Bastos¹, G. A. Lisboa Oliveira¹, A. M. Clayton¹, M. N. Caroline¹, D. L. Oliveira Da Silva¹, V. Freire Pereira¹, V. Freitas Neto¹, P. De Carvalho Bacelar¹¹Intensive Care, Hospital Municipal Djalma Marques, São Luís, Brazil**Correspondence:** H. Sousa Bastos*Intensive Care Medicine Experimental* 2023, **11(Suppl 1)**:000623

Introduction: Intensive Care Units (ICUs) are critical areas of the hospital that require intensive and complex care. In low-resource hospitals, the quality of care in the ICU may be impaired due to a lack of resources and qualified personnel. In this context, the implementation of a multidisciplinary quality program can improve the quality of care in the ICU. The aim of this study is to evaluate the impact of implementing a multidisciplinary quality program in the ICU of a low-resource hospital.

Objectives: Evaluate the outcomes as risk-adjusted mortality rate and length of stay on care in the ICU one year before and after the implementation of the multidisciplinary quality program.

Methods: We conducted a population-based retrospective cohort study of medical patients admitted in our unit (N=652) from January 1, 2021, to December 31, 2022. We analyzed 12 months before and 12 months after the implementation of a multidisciplinary quality program in the ICU. Multivariate logistic regression was used to determine the independent relationship between daily multidisciplinary rounds on mortality and length of stay.

Results: A total of 652 non-COVID patients in a non-dedicated ICU were included in the final analysis, with a mean predominance of males (67% before and 70.9% after, $p=0.52$), maintaining a mean occupancy rate (96% before and 99.5% after, $p=0.29$) and mean age (45.9 before and 47.2 after, $p=0.25$) similar, but with greater mean severity (SAPS3) in the post-intervention group (40.2 before and 61.8 later, $p=0.001$). Despite the greater severity in the post-intervention group, the mean standardized mortality was significantly lower (3.7 before and 0.8 after, $p=0.001$ [95% CI, -4.3 to -1.6]), as well as in the mean time using mechanical ventilation (10 before and 7 after, $p=0.03$ [95% CI, -5.0 to -0.1]), but with an increase in the mean number of days using devices such as a bladder catheter (166 before and 210 after, $p=0.02$) and central line catheter (85 before and 161 after, $p=0.04$), with no impact in the regression on mean length of stay (11 before and 12.5 after, $p=0.77$).

Conclusions: The implementation of daily rounds by a multidisciplinary team seems to be associated with lower mortality among ICU patients, showing the potential benefit on survival and others clinical outcomes with simple actions like the daily presence of an intensivist physician staffing and a multidisciplinary team, even in a public intensive care unit with low resources.

References

1. Gunter EP, Viswanathan M, Stutzman SE, Olson DM, Aiyagari V. Development and Testing of an Electronic Multidisciplinary Rounding Tool. *AACN Adv Crit Care*. 2019;30(3):222–9. <https://doi.org/10.4037/aacnacc2019815> Sharma S, Hashmi MF, Friede R. Interprofessional Rounds in the ICU. In: StatPearls. Treasure Island (FL): StatPearls Publishing [Internet]. 2021[cited 10 Jun 2021]. Available from: <https://www.ncbi.nlm.nih.gov/books/NBK507776/>
2. Vukoja M, Dong Y, Adhikari NKJ, Schultz MJ, Arabi YM, Martin-Loeches I, et al. Checklist for early recognition and treatment of acute illness and injury: an exploratory multicenter international quality-improvement study in the ICUs with variable resources. *Crit Care Med*. 2021;49(6):e598–e612. <https://doi.org/10.1097/CCM.0000000000004937>
3. Writing Group for the CHECKLIST-ICU Investigators and the Brazilian Research in Intensive Care Network (BRICNet), Cavalcanti AB, Bozza FA,

Machado FR, Salluh JI, Campagnucci VP, et al. Effect of a quality improvement intervention with daily round checklists, goal setting, and clinician prompting on mortality of critically ill patients: a randomized clinical trial. *JAMA*. 2016;315(14):1480–90. <https://doi.org/10.1001/jama.2016.3463>

- Berg SM, Bittner EA. Disrupting deficiencies in data delivery and decision-making during daily ICU Rounds. *Crit Care Med*. 2019;47(3):478–9. <https://doi.org/10.1097/CCM.0000000000003605>

Topic: Critical care organisation, quality management, information systems, outcomes

000627

Association of the TAPSE/PASP index and mortality in patients admitted to intensive care unit with right ventricular dysfunction treated with levosimendan

P. Núñez González¹, C. J. Gaytán García¹, O. González Marcos², J. S. Aguirre-Sánchez³, B. Martínez⁴

¹Critical Medicine, ABC Observatory Medical Center, Ciudad de México, Mexico; ²Clinical Pharmacy, ABC Observatory Medical Center, Ciudad de México, Mexico; ³Critical care unit, ABC Medical Center, Ciudad de México, Mexico; ⁴Intensive care unit, ABC Medical Center, Ciudad de México, Mexico

Correspondence: P. Núñez González

Intensive Care Medicine Experimental 2023, **11(Suppl 1)**:000627

Introduction: Right heart failure is an entity that is rarely diagnosed in intensive care units in Mexico, reporting a prevalence of 14–18%; however, it is potentially lethal and is the cause and/or consequence of different common critical illnesses (ARDS, pulmonary embolism, acute myocardial infarction, and postoperative cardiac surgery). Right ventricular dysfunction is a common problem in critically ill patients and has been associated with increased mortality rates.

The gold standard for the assessment of right ventricular-pulmonary artery coupling requires invasive pressure–volume loop recordings to measure the end-systolic/arterial elastance ratio (Ees/Ea). Echocardiographic measurement of the relationship between TAPSE and PASP is a simple, non-invasive parameter that has shown good correlation with invasively estimated coupling (<0.31 mm/mmHg, sensitivity: 87.5%, specificity: 75.9%, for predicting mortality); however, its use is currently still controversial.

Objectives: To evaluate the association of the TAPSE/PASP index at a cut-off point of 0.31 mm/mmHg and mortality in patients admitted to the Critical Care Unit who received levosimendan.

Methods: A retrospective cohort was carried out, in which a total of 49 patients were included, older than 18 years and who used levosimendan; without considering any comorbidity (diabetes, kidney disease, cancer, etc.); excluding patients who had a life expectancy of less than 48 h, whose baseline characteristics were described, grouping them into two groups (TAPSE/PASP index greater or less than 0.31 mm/mmHg), to determine if there was a difference, X2 was applied, a simple logistic regression was subsequently performed to determine if other factors, such as age, sex, etc., had an impact on the outcome; to finally adjust for the variables with the greatest impact in a multiple logistic regression.

Results: Of the patients analyzed, 30 (61.2%) were men with a median age of 72 years (58.25, 78.5) and had a median TAPSE/PASP index of 0.34 mm/mmHg (0.30, 0.48). Preliminary results indicate that mortality in the studied population was 31.8% (14) for the group with the best prognosis according to the index under study; however, it is important to mention that it is still necessary to adjust the results for variables such as: the severity of the patients, comorbidities and time of evolution.

Conclusions: Preliminary results indicate that it will be possible to determine whether there is an association between the TAPSE/PASP index and mortality for critically ill patients receiving levosimendan.

References

- Qu et al. Effect of Levosimendan on Acute Decompensated Right Heart Failure in Patients With Connective Tissue Disease-Associated Pulmonary Arterial Hypertension. *Front Med* 2022;9: 778620.

- M Kanwar et al. Epidemiology and management of right ventricular-predominant heart failure and shock in the cardiac intensive care unit. *European Heart Journal: Acute Cardiovascular Care* (2022) 11: 584–594.
- Yan-Bo Wang et al. Effects of Levosimendan on Right Ventricular Function in Patients with Acute Decompensated Heart Failure. *Acta Cardiol Sin* 2019;35:585–591.
- King et al. Management of Right Heart Failure in the Critically Ill. *Crit Care Clin* 30 (2014) 475–498.
- Clifford R Greyson. Right Heart failure in the intensive care unit. *Curr Opin Crit Care* 2012, 18:424–431.
- Tello et al. Validation of the Tricuspid Annular Plane Systolic Excursion/ Systolic Pulmonary Artery Pressure Ratio for the Assessment of Right Ventricular-Arterial Coupling in Severe Pulmonary Hypertension. *Cir Cardiovasc Imaging* 2019;12: e009047.
- Naseem et al. Tricuspid annular plane systolic excursion/pulmonary arterial systolic pressure ratio as a predictor of in-hospital mortality for acute heart failure. *BMC Cardiovasc Disord* 2022;22(1):414.

Topic: Cardiovascular issues in ICU

000628

Machine learning models to predict intensive care unit transfer among patients admitted in the intermediate ward

P. Patanayindee¹, T. Petnak²

¹Critical Care Medicine, Faculty of Medicine Ramathibodi Hospital, Mahidol University, Nonthaburi, Thailand; ²Department of Internal Medicine, Division of Pulmonary and Pulmonary Critical Care Medicine, Faculty of Medicine Ramathibodi Hospital, Mahidol University, Bangkok, Thailand

Correspondence: P. Patanayindee

Intensive Care Medicine Experimental 2023, **11(Suppl 1)**:000628

Introduction: Intermediate ward has been established for less severe critical-ill patients to alleviate the burden on the intensive care unit (ICU). However, patients transferred to the ICU after intermediate ward admission demonstrate worse outcomes. This study was conducted aiming to develop a machine learning model to predict ICU transfer among patients admitted in the intermediated ward.

Objectives: Our study aimed to develop and validate prediction model using machine learning to predict ICU transfer among patients admitted to the intermediate ward.

Methods: We conducted a retrospective study to develop prediction models for ICU transfer using both statistical model of logistic regression and the machine learning approach, a random forest model. The models were trained and tested using several variables measured within 24 h before admission, including patient demographics, vital signs, laboratory tests. Performance of the models were evaluated using the area under the receiver-operating characteristic curve (AUROC), sensitivity, positive predictive value accuracy and F-score.

Results: Total 1973 patients were included in the study, 1286 for training dataset and 705 for testing dataset. Of these, 132 patients (6.7%) were transferred to the ICU. Random forest demonstrated the excellent performance to predict ICU transfer, with an AUROC of 0.997, positive predictive value (PPV) of 76.7%, sensitivity of 97.9%, accuracy of 97.9%, and an F1 score of 0.86 in testing dataset. The most contributed variables in the random forest model included blood pressure, heart rate, using of FiO₂>0.5, serum creatinine levels, respiratory rate, serum sodium levels, and body temperature. In contrast, the statistical logistic regression had an AUROC of 0.722, PPV of 10.3%, sensitivity of 78.7%, accuracy of 50.8%, and an F1 score of 0.18 in the testing dataset. For logistic regression model, age, underlying of cerebrovascular disease, admission from the general wards, diagnosis of pneumonia, body temperature, blood pressure, respiratory rate, Glasgow coma score, requiring mechanical ventilator, using of FiO₂<0.5, and serum bicarbonate levels were included in the final model.

Conclusions: The machine learning approach using random forest demonstrated a noteworthy performance to predict ICU transfer among patients admitted in the intermediate ward. The findings of our study demonstrated the potential of machine learning in the triage process, especially when physician decisions are controversial.

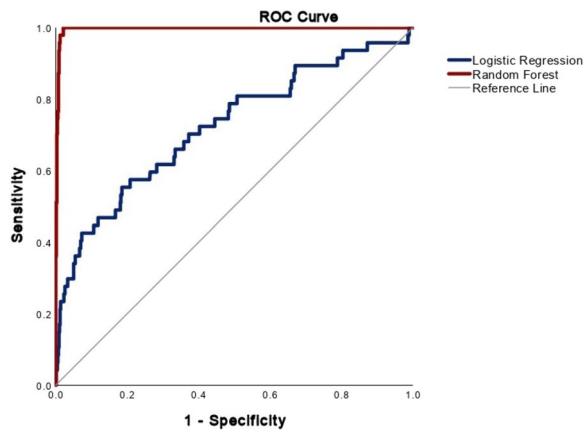

The Receiver-Operating Characteristic (ROC) curve of the test sets.

References

1. Liu Y, Gao J, Liu J, Walline JH, Liu X, Zhang T, et al. Development and validation of a practical machine-learning triage algorithm for the detection of patients in need of critical care in the emergency department. *J Scientific reports*. 2021
2. Miles J, Turner J, Jacques R, Williams J, Mason SJD, research p. Using machine-learning risk prediction models to triage the acuity of undifferentiated patients entering the emergency care system: a systematic review. 2020;4:1–12.
3. Johnson AE, Ghassemi MM, Nemati S, Niehaus KE, Clifton DA, Clifford GD. Machine learning and decision support in critical care. *Proc IEEE*. 2016;104(2):444–466.
4. The author would like to acknowledge Department of Medicine, Faculty of Medicine Ramathibodi Hospital, Mahidol University for having provide access to all database in this study.

Topic: Critical care organisation, quality management, information systems, outcomes

000629

Respiratory viral co-infections in patients with COVID-19

M. Sahu¹, V. R. Kola², H. Gonuguntla³, G. Yedlapati⁴, S. Y³, G. Mallu⁴, P. Nimmala⁵
¹Infectious Diseases, Yashoda Hospitals, Hyderabad, India; ²Critical Care, Yashoda Hospitals, Hyderabad, India; ³Interventional Pulmonology, Yashoda Hospitals, Hyderabad, India; ⁴Pulmonology, Yashoda Hospitals - Secunderabad, Hyderabad, India; ⁵Microbiology, Yashoda Hospitals - Secunderabad, Hyderabad, India

Correspondence: M. Sahu

Intensive Care Medicine Experimental 2023, **11(Suppl 1)**:000629

Introduction: Coronavirus Disease 2019 (COVID-19) has clinical similarity with other flu-like syndromes. Owing to the similarity of symptoms, there are chances of misdiagnosis of patients with other respiratory viruses as COVID-19 or chances of missing out upon viral co-infections in patients with COVID-19.

Objectives: Here we report etiologic pattern of respiratory tract infections, especially of the viral etiology, diagnosed at Yashoda Hospital, Hyderabad, a tertiary care hospital of Hyderabad, Southern India, during period of the pandemic.

Methods: The patients presenting with the respiratory symptoms were tested for presence of other respiratory tract pathogens. At admission, we sent samples, nasopharyngeal swab for COVID real-time reverse transcriptase PCR (RT-PCR) and nasopharyngeal swab or Bronchoalveolar lavage (BAL), depending on the clinical profile, for multiplex PCR BioFire FilmArray Pneumonia panel or Respiratory panel

(BioFire Diagnostics; bioMérieux, Marcy l'Étoile, France). These Biofire panels allow detection of 33 respiratory pathogens with a run time of 1 h.

We retrospectively reviewed clinical and microbiologic records generated via routine clinical practice (ethical approval not required) from 490 consecutive patients (336 males; median age, 53 years; range, 14–93 years), with respiratory symptoms who were screened with FilmArray and RT-PCR for COVID-19, over 28 months months, from 1st June 2020 to 30th September 2022.

Results: We included nasopharyngeal swabs (229/490, 46.9%), and BAL (261/490, 53.1%) samples. SARS-CoV-2 RNA was detected in 315 (64.8%) of 490 samples, while FilmArray showed presence of other viruses in 54/490 (10.9%). FilmArray results showed 27/54 samples (50%) had multiple viruses, and were as follows: Rhinoviruses/Enteroviruses (24/54, 44.4%), Influenza A virus, Coronaviruses and rhinovirus (each 9/54, 16.6%). One nasopharyngeal swab in a 61-year old COVID-19 patient showed presence of rhinovirus/enterovirus and Influenza A and was mildly symptomatic, but no secondary cases were found among her contacts. Our data are consistent with results from other studies on co-infection, showing low prevalence of other respiratory virus co-infection in SARS-CoV-2 patients, in range of 1.6–6.5%. Several phenomena like viral interference, common receptor usage, different inoculum size or simply resource competition might explain why dual or multiple concurrent viral respiratory infections are rare among COVID-19 patients.

Conclusions: A multiplex PCR system for rapid diagnosis of respiratory infections revealed that there is low prevalence of concomitant viral infection in patients positive for SARS-CoV-2. Moreover, with the spread of SARS-CoV-2, occurrence of other respiratory pathogens has undergone a sharp decline.

SAMPLES	Total number of samples	COVID-19 positive	COVID-19 Negative	
Bronchoalveolar lavage (BAL)	261	150	111	
		Viral co-infection present	6 (4%)	21 (19%)
		Viral co-infection absent	144	90
Nasopharyngeal swab	229	164	65	
		Viral co-infection present	12 (7.2%)	15 (22%)
		Viral co-infection absent	152	50

References

1. Lai CC, Wang CY, Hsueh PR. Co-infections among patients with COVID-19: The need for combination therapy with non-anti-SARS-CoV-2 agents?. *J Microbiol Immunol Infect*. 2020;53(4):505–512. <https://doi.org/10.1016/j.jmii.2020.05.013>
2. Singh V, Upadhyay P, Reddy J, Granger J. SARS-CoV-2 respiratory co-infections: Incidence of viral and bacterial co-pathogens. *Int J Infect Dis*. 2021;105:617–620. <https://doi.org/10.1016/j.ijid.2021.02.087>
3. Received no grants of any sort for the study

Topic: Infections and prevention

000633

Identification of subphenotypes in a Korean National Cohort of severely ill COVID-19 patientsK. H. Kim¹, J. Lee²

¹Division of Pulmonary, Allergy and Critical Care Medicine, Department of Internal Medicine, Incheon St. Mary's Hospital, The Catholic University of Korea, Seoul, Republic of Korea; ²Division of Pulmonary, Allergy and Critical Care Medicine, Department of Internal Medicine, Seoul St. Mary's Hospital, The Catholic University of Korea, Seoul, Republic of Korea

Correspondence: K. H. Kim*Intensive Care Medicine Experimental* 2023, **11(Suppl 1)**:000633

Introduction: Acute respiratory distress syndrome and sepsis are heterogeneous syndromes comprised of various diseases. The heterogeneity of these two syndromes signifies that our understanding remains incomplete despite numerous efforts and may explain why randomized controlled trials of numerous drugs and treatment methods have not achieved groundbreaking results in these syndromes. In the case of COVID-19 infection, it is a disease caused by a single virus, which is expected to exhibit relatively similar characteristics. However, it is also true that the disease progression varies among patients. Therefore, this study aims to elucidate the sub-phenotypes present in a cohort of severe COVID-19 patients, as observed in their clinical progression.

Methods: We conducted a retrospective multicenter cohort study of severe COVID-19 patients admitted to the intensive care units of 26 university hospitals in South Korea from January 2020 to August 2021. To identify sub-phenotype groups, we utilized latent class analysis modeling. We employed initial data variables following cohort enrollment as factors for sub-phenotype classification. Subsequently, we examined the differences between subgroups and clinical outcomes and analyzed the effects of each treatment.

Results: We analyzed a total of 1114 patients. The latent class analysis revealed that the two-class model best described the sub-phenotypes within the cohort. Of the 1114 patients, 823 belonged to the type 1 sub-phenotype, and 291 belonged to the type 2 sub-phenotype. The type 2 sub-phenotype was associated with higher mortality, higher usage of vasopressors, mechanical ventilation, continuous renal replacement therapy, extracorporeal membrane oxygenation, longer ICU length of stay, higher serum inflammatory markers (WBC, CRP), higher initial FiO₂, and lower PF ratio. No significant difference in steroid use was observed between the two groups.

Conclusions: We identified two sub-phenotypes in severe COVID-19 patients, which were associated with more severe hyperinflammation, shock, metabolic acidosis, and worse clinical outcomes. In this study, we were able to classify subgroups in severe COVID-19 patients, which could potentially aid in patient stratification and inform future treatment approaches.

Topic: Acute respiratory failure and mechanical ventilation

000634

Clinical significance of head CT scan in patients admitted to the Emergency Department for mild head injury: preliminary analysis from a prospective observational studyM. Baldrighi¹, D. Luzzi¹, A. Rubineti¹, D. Urzia¹, C. Cicerone¹, M. Alfano¹, S. Fidone¹, A. Friuli¹, E. Fabbro¹, F. Patti¹, L. Trovato¹, L. Molinari¹, M. Bellan², L. M. Castello², F. Patrucco², P. P. Sainaghi², G. C. Avanzi¹, F. Gavelli¹

¹Emergency Medicine Department, Università degli Studi del Piemonte Orientale, Novara, Italy; ²Dipartimento di medicina traslazionale, Università degli Studi del Piemonte Orientale 'Amedeo Avogadro', Novara, Italy

Correspondence: F. Gavelli*Intensive Care Medicine Experimental* 2023, **11(Suppl 1)**:000634

Introduction: Head trauma is the main cause of death and disability in people under 40 in industrialized countries (1).

It has been estimated that 70–90% of all head traumas evaluated in Emergency Departments (EDs) are mild (2). Mild Head Injury (MHI) is defined as any blunt trauma to the head presenting at the time of evaluation a Glasgow Coma Scale (GCS) score of 13 to 15 (3).

Early diagnosis of intracranial lesions through Computed Tomography (CT) scan is the aim of the emergency physician, but multiple studies have demonstrated that only a small percentage of such lesions requires surgery (1.5% in some cases) (4).

Objectives: The aim of this study is to evaluate the impact of head CT scans on the clinical management of patients suffering MHI.

Methods: Patients older than 18 admitted to the ED of the Novara University Hospital reporting a MHI and able to express an informed consent were consecutively enrolled in this prospective observational study. They were clinically evaluated at the time of admission and then 6, 24, 48 and 72 h later, as long as they were still in the ED. A telephone follow-up was performed at 90 days.

The primary composite endpoint was a change in patients' management decided by the emergency physician after finding a post-traumatic intracranial lesion on a CT scan. Component endpoints were admission to an ordinary ward (such as Neurosurgery), modifications in pharmacotherapy (reversal of anticoagulation, prolonged withdrawal of antithrombotic drugs, anti-edema treatments) or invasive treatments (invasive ventilation, surgery).

Results: This preliminary analysis includes 248 patients recruited between June 2021 and December 2022.

At least 1 CT scan was performed in 87.9% of cases, and the first CT scan revealed an intracranial lesion in 18.1% of them. At least another CT scan was repeated in the first 24 h in 70 patients; a delayed lesion was observed in 1 case only, but finding it had no clinical impact on the patient's management.

The cumulative number of CT scans performed throughout the study was 309, but only 20 of them (6.5%) had a clinical impact. In particular, 17 patients were hospitalized, and among them 1 patient also received reversal therapies for ongoing anticoagulation, 2 patients also received anti-edema treatments, and in 1 patient antithrombotic treatment was also withdrawn. In the remaining 3 out of 20 patients, the CT scan induced the physician to withdraw anticoagulation. None of the patients underwent neurosurgery. Two patients died, but only one because of an intracranial injury.

Out of the 53 patients reached so far at follow-up, only 4 reported a transient limitation in daily-life activities after the event, but they all got back to their pre-event condition within 90 days.

Conclusions: These preliminary data support the need to move the attention of the emergency physician from finding intracranial lesions as such, to finding clinically significant intracranial lesions, thus reducing the number of useless CT scans and improving both patients' and resources management.

References

- 1) 2019 surveillance of head injury: assessment and early management (NICE guideline CG176). 2019.
- 2) Cassidy JD, Carroll LJ, Peloso PM, et al. Incidence, risk factors and prevention of mild traumatic brain injury: results of the WHO Collaborating Centre Task Force on Mild Traumatic Brain Injury. *J Rehabil Med*. Feb 2004;(43 Suppl):28–60. <https://doi.org/10.1080/16501960410023732>
- 3) Culotta VP, Sementilli ME, Gerold K, Watts CC. Clinicopathological heterogeneity in the classification of mild head injury. *Neurosurgery*. Feb 1996;38(2):245–50. <https://doi.org/10.1097/00006123-199602000-00002>
- 4) Stiell IG, Clement CM, Rowe BH, et al. Comparison of the Canadian CT Head Rule and the New Orleans Criteria in patients with minor head injury. *JAMA*. Sep 2005;294(12):1511–8. <https://doi.org/10.1001/jama.294.12.1511>

Topic: Trauma

000635

Nutritional adequacy, muscle changes and functional impairment in children receiving extracorporeal membrane oxygenation

L. Yang¹, C. Ong², J. H. Lee³

¹Physiotherapy, KK Women's and Children's Hospital, Singapore, Singapore; ²Nutrition and Dietetics, KK Women's and Children's Hospital, Singapore, Singapore; ³Children's Intensive Care, Department of Paediatric Subspecialties, KK Women's and Children's Hospital, Singapore, Singapore

Correspondence: L. Yang

Intensive Care Medicine Experimental 2023, **11(Suppl 1)**:000635

Introduction: Children requiring extracorporeal membrane oxygenation (ECMO) experience malnutrition and significant functional impairment. Nutritional adequacy in relation to functional impairment in children receiving ECMO has not been reported.

Objectives: This pilot study aimed to describe the nutritional adequacy, muscle changes and functional outcomes in children requiring ECMO.

Methods: Children admitted to a tertiary mixed pediatric intensive care unit (PICU), requiring ECMO between January 2018 and December 2020 were included in this study. Energy and protein intake for the first 7 days of ECMO were collected. Energy and protein requirements were determined using the Schofield equation and 1.5 g/kg/day, respectively. Intake adequacy was determined as a percentage of requirements. Muscle changes were assessed using ultrasound of the rectus femoris cross sectional area (RFCSA) at ECMO initiation, ECMO decannulation, and PICU discharge. Function was assessed using the functional status scale (FSS) at baseline, PICU discharge and hospital discharge. Functional impairment was defined as an increase in FSS score by ≥ 3 from baseline. Presence of gross motor impairment at hospital discharge was assessed using the Test of Infant Motor Performance (TIMP) (0–4 months), Peabody Developmental Motor Scales-II (PDMS-2) (4 months–5 years) through gross motor quotient scores, or 6-min walk distance test (6MWT) (>5 years).

Results: Sixteen children [median age 1.31 years (Interquartile range (IQR) 0.03–3.52)] were included. All required venous-arterial ECMO. 11 (68.8%) patients survived to hospital discharge. Median energy and protein intakes were 31.4% (IQR 19.9–53.3) and 24.2% (IQR 6.0–37.9), respectively. Median RFCSA change was 7.69% (IQR –11.88–23.23) during ECMO, and –0.33% (IQR –15.42–8.48) from ECMO decannulation to PICU discharge. Functional impairment was present in 8 (50%) children.

Gross motor impairment was assessed in 10 patients (90.9%). 1 participant had a below average TIMP score, and 7 patients had very poor to below average [70 (IQR 55–83)] PDMS-2 scores. 6MWT distance of 2 patients >5 years of age were less than 3rd centiles of age-normative values for Asian children. 3 patients required long-term physiotherapy review more than 6 months.

Total energy [27.9% (IQR 27.8–51.5) vs. 35.5% (IQR 16.2–58.0), $p=0.921$] and protein adequacy [19.7% (IQR 19.0–44.4) vs. 17.1% (IQR 3.6–52.1), $p=0.630$] were similar between those with and without PICU functional impairment. There was no correlation between RFCSA change and energy [Pearson's $r=-0.027$, $p=0.938$] or protein adequacy [Pearson's $r=-0.06$, $p=0.858$] during ECMO.

Conclusions: Functional impairment and gross motor delay rates were high in children requiring ECMO. Nutritional adequacy was low. Energy and protein intakes were similar between children with and without functional impairment. Energy and protein adequacy were not correlated with RFCSA. Larger cohort studies are required to validate these findings.

References

- Li, A. M., Yin, J., Au, J. T., So, H. K., Tsang, T., Wong, E., Fok, T. F., & Ng, P. C. (2007). Standard reference for the six-minute-walk test in healthy children aged 7 to 16 years. *American journal of respiratory and critical care medicine*, 176(2), 174–180. <https://doi.org/10.1164/rccm.200607-883OC>

- This work was supported by the following grant: Duke/Duke-NUS/RECA(Pilot)/2017/0035 (PI: Dr. Jan Hau Lee)

Topic: Metabolism, endocrinology, liver failure and nutrition

000637

Co-designed peer support to improve critical care recovery: icuRESOLVE Pilot randomised controlled trial

K. Haines¹, E. Hibbert², N. Leggett³, Y. Ali Abdelhamid¹, S. Bates⁴, E. Bicknell², S. Booth⁵, J. Carmody⁶, A. Deane¹, K. Emery², K. Farley⁴, C. French⁴, C. Holdsworth², B. Macleod-Smith², M. Paykel², E. Skinner², T. J. Iwashyna⁷

¹Department of Critical Care, University of Melbourne, Parkville, Australia;

²Department of Physiotherapy, Western Health, St Albans, Australia;

³Department of Critical Care, University of Melbourne, Parkville, France;

⁴Intensive Care Department, Western Health, St Albans, Australia;

⁵Department of Social Work, Western Health, St Albans, Australia;

⁶Department of Psychology, Western Health, St Albans, Australia;

⁷Department of Critical Care, Johns Hopkins University, Baltimore, United States of America

Correspondence: N. Leggett

Intensive Care Medicine Experimental 2023, **11(Suppl 1)**:000637

Introduction: Peer support is a promising intervention to reduce psychological morbidity and improve social support and self-efficacy for ICU survivors and their caregivers. Our prior systematic review demonstrated there are few well-designed and rigorously reported trials. In one of the first international pilot randomised controlled trials, this study aimed to establish the feasibility of an in-person, co-designed, peer support model—in both the early and late post-hospital phases of recovery.

Methods: Prospective, randomised, single-centre pilot trial with blinded outcome assessment. Community-dwelling ICU survivors (and their nominated caregiver if designated), >18 years of age, able to speak and understand English and participate in phone surveys, were eligible.

Participants were randomised to attendance at the in-person peer support group (six sessions, fortnightly or usual care). Two models were piloted: 1. Early (baseline outcome measurement within 2 weeks post-hospital discharge; intervention commencing 2–3 weeks post-hospital discharge, follow-up at 15–17 weeks post-hospital discharge); 2. Late (baseline outcome measurement within 3–4 weeks post-hospital discharge, intervention commencing 4–6 weeks post-hospital discharge with follow-up 17–20 weeks post-hospital discharge). Outcomes included post-traumatic growth, resilience, social support, anxiety and depression, post-traumatic stress disorder, and quality of life. The primary outcome was feasibility of implementing the peer support model, as measured by participant recruitment, intervention attendance, and outcome measurement completion.

Results: Of 231 eligible patients, 80 participants were recruited. The early phase pilot recruited 38 participants, (28 patients, 10 carers; 18 singles, 10 dyads), with an average (SD) age of 59.8 (17.9) years, 55% female. Twenty-two (58%) were randomised to intervention. The primary outcome (Impact of Events Scale) was completed by 20 (53%) participants at baseline and 14 (37%) at follow-up. The early intervention group attended a median (IQR) of 0 (0 to 1) sessions (total 24 sessions).

The late phase pilot recruited 42 participants (32 patients, 10 carers; 22 singles, 10 dyads), with an average (SD) age of 60.4 (15.4) years, 50% female. Twenty-one (50%) were randomised to intervention. The primary outcome was completed by 41 (98%) participants at baseline, and 29 (69%) at follow-up. The late intervention group attended a median (IQR) of 1 (0 to 5) sessions (total 44 sessions).

Conclusions: In this proof of concept trial, an in-person peer support model delivered in the late post-hospital phase of recovery, appeared to be more feasible than an early model. Further research, should investigate alternative modes of intervention delivery to improve uptake and reduce barriers to attendance.

References

1. The Society of Critical Care Medicine—Thrive Grant to Accelerate Recovery

Topic: Critical care organisation, quality management, information systems, outcomes

000638

Preoperative malnutrition is risk factor for unplanned postoperative reintubation in patients who undergoing abdominal surgery

D. Choi¹, S. Lee¹, K. Park¹, K. Y. Lee¹, J. Y. Jang¹

¹General Surgery, National Health Insurance Service Ilsan Hospital, Goyang-si, Republic of Korea

Correspondence: K. Park

Intensive Care Medicine Experimental 2023, **11(Suppl 1)**:000638

Introduction: Postoperative reintubation in patients who extubated after surgery under general anesthesia is associated with poor prognosis, longer hospital stay and increase of medical expenditure. Accurate extubation timing is critical for patient safety and intensive care unit (ICU) resource management. Therefore, this study aimed to identify preoperative malnutrition is a risk factor for postoperative reintubation in patients undergoing abdominal surgery.

Objectives: To identify preoperative malnutrition is a independent risk factor for postoperative reintubation in patients undergoing abdominal surgery.

Methods: We retrospectively analyzed medical charts of patients who extubated after abdominal surgery under general anesthesia between January 2017 and June 2022 at the National Health Insurance Service Ilsan Hospital.

Results: Among 9917 patients, unplanned postoperative reintubations were occurred in 42 patients. There were significant difference in age, sex, operation time, amount of red blood cell transfusion, blood loss in operating room, operation time, underlying disease (hypertension, cardiac disease, Chronic obstructive pulmonary disease and cancer), ASA score, preoperative and postoperative sequential organ failure assessment (SOFA) scores, and preoperative malnutrition between reintubation group and non-reintubation group. Logistic regression analysis preoperative malnutrition (OR 3.578 95% CI 1.426–8.98) were independent risk factors for unplanned reintubation. The area under the ROC curve for this model was 0.9496.

Conclusions: Pre-operative malnutrition is a risk factor for unplanned postoperative reintubation in patients undergoing abdominal surgery.

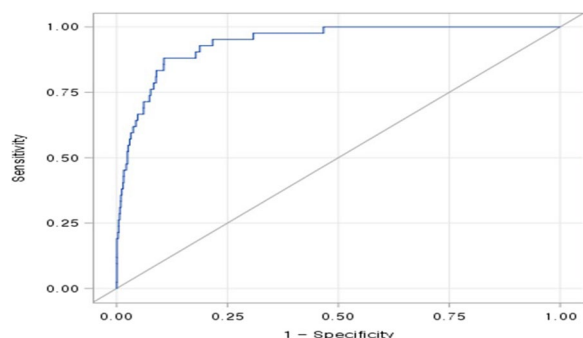

Figure 1 (abstract 000638) .

Topic: Perioperative care

000639

Open abdominal management (OAM) and intensive care improve prognosis in cases of lower colonic perforation with septic shock

Y. Minami¹, C. Watanabe², H. Masui¹

¹Department of surgery, Yokosuka Kyōsai Hospital, 横須賀市, Japan;

²Emergency and Critical Care, Yokosuka Kyōsai Hospital, 横須賀市, Japan

Correspondence: Y. Minami

Intensive Care Medicine Experimental 2023, **11(Suppl 1)**:000639

Introduction: OAM has long been selected as a damage control surgery for severely injured patients, but in recent years, it has also been applied to severe non-traumatic conditions (1). According to reports, OAM in severe non-trauma peritonitis patients is feasible and safe as surgical strategy management without increasing mortality, length hospital of stay, or complications (2).

Since 2019, our hospital has performed OAM for lower colonic perforation cases with septic shock. In the first surgery, only the cause of shock was removed, and intensive care was performed in the ICU with the abdomen open. After the general condition has improved, create an intestinal anastomosis or colostomy and close the abdomen.

Objectives: In this study, we investigated the treatment results of OAM for patients with colonic perforation with septic shock in our hospital.

Methods: 31 cases were underwent surgery from 2017 to October 2022. We examined perioperative factors between two groups, one that underwent OAM and received intensive care (OAM group) and one that underwent primary abdominal closure and received intensive care (PC group), and examined the short-term results after surgery.

Results: OAM was performed in 13 of 31 patients. There was no significant difference in patient background between the two groups. APACHE2 score and SOFA score did not show any significant difference between the two groups. The initial operation time in the OAM group was significantly shorter than that in the PC group (104 vs 208 min, $p=0.000$). In the OAM group, an average of 3 surgeries were performed until abdominal closure. There was no difference in postoperative complications between the two groups, but in the PC group, 4 died of multiple organ failure associated with infection and 1 died of respiratory failure associated with ARDS. There were no deaths in the OAM group, mortality was significantly lower in the OAM group ($p=0.050$). In cases excluding death cases, the number of days of ventilator management and ICU stay tended to be longer in the OAM group, but there was no significant difference. There was no significant difference in postoperative length of stay between the two groups (43.3 vs. 36.5 days, $p=0.531$).

Conclusions: In patients colonic perforation with septic shock, the prognosis could be improved by selecting OAM and improving the general condition first by intensive care.

References

1. (1) Y. Okishio et al. Is open abdominal management useful in nontrauma emergency surgery for older adults? A single-center retrospective study. *Surg Today*. 2021 Aug; 51(8):1285–1291
2. (2) Carlos A. Ordóñez et al. Damage Control Surgery may be a Safe Option for Severe Non-Trauma Peritonitis Management: Proposal of a New Decision-Making Algorithm. *World J Surg* (2021) 45:1043–1052
3. no acknowledgments

Topic: Sepsis

000640

Association of preoperative prognostic nutritional index and postoperative acute kidney injury in patients undergoing on pump coronary artery bypass grafting

D. Z. Alih¹

¹Critical Care Medicine Division, Philippine Heart Center, Quezon City, Philippines

Correspondence: D. Z. Alih

Intensive Care Medicine Experimental 2023, **11(Suppl 1)**:000640

Introduction: Acute kidney injury (AKI) is documented to occur at 12 to 48.5% after coronary artery bypass graft (CABG) surgery. Prognostic nutritional index (PNI) has been related to clinical outcomes in post-surgery patients and is documented as an independent predictor of AKI. In this study, we aimed to investigate the association of PNI with AKI after elective on-pump CABG operations.

Objectives: To determine the association of prognostic nutritional index with post-operative acute kidney within 48 h of surgery, in patients undergoing elective coronary artery bypass graft.

Methods: A total of 66 consecutive patients who underwent elective on-pump CABG were enrolled in this prospective study. Prognostic nutritional index was computed based on the laboratory tests taken during their admission prior to surgery. AKI was defined as occurrence of creatinine changes within the first 48 h after CABG surgery based on the Kidney Disease: Improving Global Outcomes (KDIGO) criteria. The patients were then grouped into an AKI (–) and an AKI (+) group.

Results: A total of 66 patients were included in the study with a mean age 58.04 ± 9.28 years predominantly male (80.3% men vs 19.7% female). Of the 66 patients, a total 5 patients (8%) developed AKI. PNI did not show association with the development of AKI after elective on-pump coronary artery bypass surgery.

Conclusions: In our study, PNI was not associated with the development of AKI after elective on-pump coronary artery bypass surgery.

References

1. This research was not funded nor the author received research grants from any company.
2. Onodera, T.; Goseki, N.; Kosaki, G. Prognostic nutritional index in gastrointestinal surgery of malnourished cancer patients. *Nihon Geka Gakkai Zasshi* 1984, 85, 1001–1005.
3. Majeed A, Moser K, Carroll K. Trends in the prevalence and management of atrial fibrillation in general practice in England and Wales, 1994–1998: analysis of data from the general practice research database. *Heart* 2001;86:284–288.
4. Perkovic V, Agarwal R, Fioretto P, et al. Management of patients with diabetes and CKD: conclusions from a “Kidney Disease: Improving Global Outcomes” (KDIGO) Controversies Conference. *Kidney Int* 2016;90:1175–1183.
5. Dolapoglu A, Avci E, Kiris T, Bugra O. The predictive value of the prognostic nutritional index for postoperative acute kidney injury in patients undergoing on-pump coronary bypass surgery. *J Cardiothorac Surg* 2019 Apr 11;14(1):74. <https://doi.org/10.1186/s13019-019-0898-7>. PMID: 30971264; PMCID: PMC6458745.
6. The European Society for Clinical Nutrition and Metabolism. *Basics in Clinical Nutrition*, 4th ed.; Publishing House Galen: Somerville, NJ, USA, 2011.

Topic: Acute Kidney Injury and haemofiltration

000641

Hs-troponin-T on day of extubation is associated with extubation failure

C. Groenland¹, A. Siemers¹, E. J. Wils², E. Dubois¹, L. Heunks¹, V. Baggen¹, H. E. Endeman¹

¹Intensive Care, Erasmus University Medical Center, Rotterdam, Netherlands; ²Intensive care, Franciscus Gasthuis, Rotterdam, Netherlands

Correspondence: C. Groenland

Intensive Care Medicine Experimental 2023, **11(Suppl 1)**:000641

Introduction: Accurate timing of readiness for extubation in patients with COVID-19 is challenging, since the extubation failure rate is reported to be up to 20% (1, 2). Extubation failure is associated with higher mortality, morbidity, ICU length of stay, and healthcare costs (3, 4). To date, clinical and respiratory variables are used to predict extubation failure. Data on the value of cardiac and inflammatory biomarkers in this setting is limited.

Objectives: The aim of this study is to investigate whether cardiac and selected inflammatory biomarkers (NT-proBNP, high sensitive troponin-T (hs-TnT), procalcitonin, and IL-6) on the day of extubation are associated with extubation failure in mechanically ventilated patients with COVID-19.

Methods: This was a single-center retrospective cohort study. From march 2020 until march 2022, 602 mechanically ventilated patients with COVID-19 were screened for eligibility. Patients were eligible for inclusion if they were extubated for the first time, according to a weaning protocol including a spontaneous breathing trial. The primary endpoint was extubation failure (i.e. reintubation or mortality within 7 days). Logistic regression was performed to investigate the relation between biomarkers on day of extubation and extubation failure. Biomarkers were log2 transformed and associations were adjusted for age and SOFA score on day of extubation.

Results: In total 298 patients met the inclusion criteria. Median age was 60 years [IQR, 51–67], and 70.1% was male. The primary endpoint occurred in 20.8% patients. Patients with extubation failure had a higher SOFA score on the day of extubation (5 [IQR, 3–7] versus 3 [IQR, 2–4], p < 0.001) and a longer duration of mechanical ventilation prior to extubation (11.5 days [IQR, 7.3–15] versus 8 days [IQR, 6–11.3], p < 0.001) (Table 1). Of the four evaluated biomarkers, log2 hs-TnT was independently associated with extubation failure (adjusted OR, 1.38 (95% CI, 1.03–1.88), but NT-proBNP, procalcitonin and IL-6 were not (Figure 1). The AUC of the ROC curve was 0.76 (95% CI, 0.63–0.90), with a sensitivity and specificity of 73 and 72%, respectively.

Table 1 (abstract 000641) Baseline characteristics

Characteristics	All patients N = 298	Patients without extubation failure N = 236	Patients with extubation failure N = 62	P-value
Age (years)*	60 [51–67]	59 [51–67]	64 [55–68]	0.051
Male, sex, N (%)	209 (70.1%)	164 (69.5%)	45 (72.6%)	0.751
BMI (kg/m ²)*	28.9 [25.9–32.9]	28.94 [26.3–33.1]	28.06 [24.5–30.9]	0.078
SOFA score on the day of extubation*	3 [2–5]	3 [2–4]	5 [3–7]	<0.001
Days of MV prior to extubation*	9 [6–13]	8 [6–11.3]	11.5 [7.3–15]	<0.001
Biomarkers levels on the day of extubation				
NT-pro-BNP (pmol/l)*	26.9 [12.4–62.2]	25.2 [12.1–58.7]	36.1 [15.2–77.1]	0.066
Hs-TnT (ng/L)*	13.9 [9.8–25.0]	12.9 [9.0–21.7]	19.2 [12.1–45.9]	<0.001
Procalcitonin (ng/mL)*	0.10 [0.06–0.20]	0.09 [0.06–0.19]	0.18 [0.10–0.34]	<0.001
IL-6 (pg/mL)*	73.5 [20.0–209.5]	76.0 [20.0–207.5]	67.5 [23.8–248.3]	0.860

*Values are presented as median, [Interquartile Range]

Conclusions: In mechanically ventilated patients with COVID-19, hs-TnT was independently associated with extubation failure. This association was not found for NT-proBNP, procalcitonin, and IL-6. Prospective cohort studies are needed to further investigate this association.

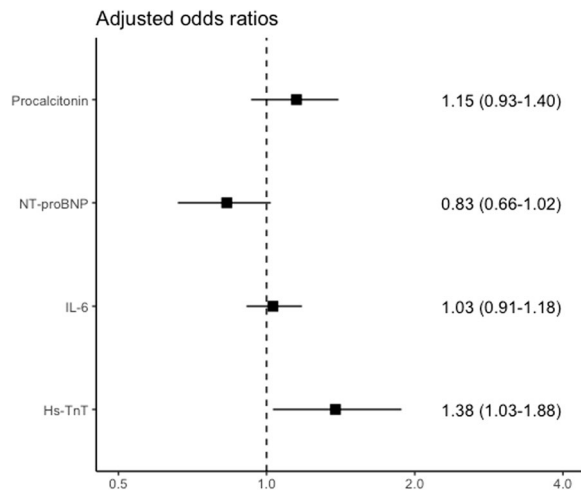

Figure 1 (abstract 000641) Adjusted odds ratios for extubation failure. Biomarkers were log₂ transformed

References

1. Thille AW, Richard J-CM, Brochard L. The decision to extubate in the intensive care unit. *Am J Respir Crit Care Med.* 2013;187:1294–302
2. Fleuren LM, Dam TA, Tonutti M. Predictors for extubation failure in COVID-19 patients using a machine learning approach. *Crit Care.* 2021 Dec 27;25(1):448
3. Rothaar RC, Epstein SK. Extubation failure: magnitude of the problem, impact on outcomes, and prevention. *Curr Opin Crit Care.* 2003 Feb;9(1):59–66
4. Seymour CW, Martinez A, Christie JD, Fuchs BD. The outcome of extubation failure in a community hospital intensive care unit: a cohort study. *Crit Care.* 2004 Oct;8(5):R322-7.

Topic: Acute respiratory failure and mechanical ventilation

000642

Benefits of “Analgesia Nociception Index” guided fentanyl administration in critically ill patient: a pilot study and randomized controlled trial

C. Plukmonton¹, P. Theerawit², Y. Sutherasan³, S. Morakul¹
¹Anesthesiology and Critical Care Medicine, Faculty of Medicine Ramathibodi Hospital, Mahidol University, Bangkok, Thailand; ²Critical Care Medicine, Faculty of Medicine Ramathibodi Hospital, Mahidol University, Bangkok, Thailand; ³Pulmonary and Pulmonary Critical Care Medicine, Faculty of Medicine Ramathibodi Hospital, Mahidol University, Bangkok, Thailand

Correspondence: C. Plukmonton
Intensive Care Medicine Experimental 2023, **11(Suppl 1)**:000642

Introduction: Mismanagement of analgesic and sedative drugs in mechanically ventilated and sedated ICU patients can lead to adverse outcomes. The use of the Analgesia Nociception Index (ANI) has been proposed as a reliable biomarker to monitor nociception in critically ill patients. We hypothesize that using ANI monitoring to guide fentanyl administration in mechanically ventilated and sedated ICU patients can reduce the total fentanyl doses administered at 48 h.

Objectives: To assess the benefit of analgesia nociception index to guide fentanyl administration in mechanically ventilated and moderate to deep sedated ICU patient.

Methods: We conduct a randomized controlled trial to compare the total fentanyl doses administered in patients who receive ANI-guided fentanyl administration to those who receive standard care. We monitored ANI and fentanyl doses every 4 h for 48 h to evaluate the effect on total fentanyl doses and patient outcomes.

Inclusion Criteria:

1. Age ≥ 18 years
2. Receiving mechanical ventilation through an endotracheal tube or tracheostomy
3. Admitted to the medical or surgical ICU
4. Indicate moderate to deep sedation with the analgesic drug for more than 48 h.

Exclusion criteria:

1. Patients with an unstable hemodynamic required a high dose of vasopressor or inotrope
2. Patients with a history of cardiac arrhythmia, on pacemaker, autonomic dysfunction, and chronic opioid use
3. Patients who have contraindications to study drug
4. Patients with a respiratory rate lower than ten breaths per minute
5. Patients who were expected to undergo sedation for less than 48 h after the start of the study.
6. Patients refused to participate in the research program or withdrew from the research.

Withdrawal Criteria

1. Patients desire to stop the study
2. Inability to participate until the end of the trial namely hemodynamic instability required a high dose of vasopressor during study and a new onset of cardiac arrhythmia.
3. Patients have adverse reactions to the study drug
4. Physician decision to stop sedation or study drug before 48 h

Results: 15 out of 39 patients were included in the study, and the mean dose of fentanyl administered was lower in the ANI-guided group compared to the control group (42.25 ± 12.21 vs 65.11 ± 33.15 , 95% confidence interval 0.349–0.686, $P=0.08$). ANI was associated with significantly lower fentanyl dose when using Linear mixed model estimated mean difference 0.52 mcg/kg/h ($P<0.001$, 95% CI 0.35 to 0.69). The mean ANI scores were higher in the ANI-guided group 71.71 ± 3.7 compared to 61.5 ± 4.62 (95% CI – 23.11 to 2.67, $P=0.11$). No significant differences were observed in the RASS score, BIS, and BPS score. There were no significant differences in the length of hospital and ICU stay, ventilator days, the occurrence of adverse events, and 28-day mortality between the two groups.

Conclusions: The dose of fentanyl administered over time was lower in the ANI-guided group compared to the control group in mechanically ventilated and sedated ICU patients. Our study suggests that the use of ANI may be a promising tool for guiding analgesia-based sedation in mechanically ventilated patients.

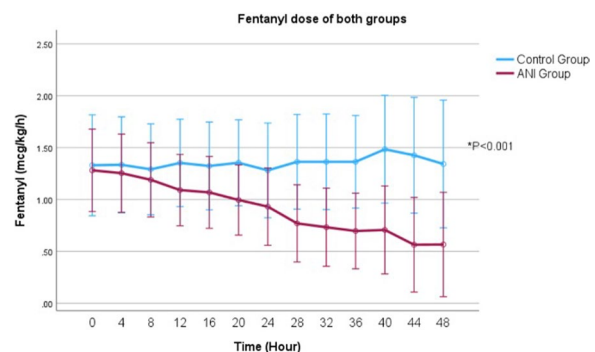

Figure 6 (abstract 000642) Fentanyl dose of both groups Mean fentanyl dose of both groups are significantly different with p value < 0.001 and 95% CI 0.35 to 0.67

References

1. Sirirat Tribuddharat TS. Comparative study of analgesia nociception index (ANI) vs. standard pharmacokinetic pattern for guiding intraoperative fentanyl administration among mastectomy patients. 2021;21:50.
2. R. Logier MJ. PhysioDoloris: a monitoring device for Analgesia/Nociception balance evaluation using Heart Rate Variability analysis. 2010;1194–7.
3. Laosuwan P. Analgesia Nociception Index: an Evidence-Base Review. 2019;164–70.
4. Ledowski T. Objective monitoring of nociception: a review of current commercial solution 2019;123(20).
5. The authors acknowledge and thank to my research advisor (Asst. Prof. 32 Yuda Sutheerasan) and my co-advisor whom counseled and advised guided me through the whole process of completing my project. And I would really like to show my thankfulness to every participant and their families for participating in my project comforted. Theatre staff and intensive care nurse team of intensive ward, Ramathibodi Hospital for their assistance in these trial.

Topic: Sedation, analgesia and delirium

000643

Which patient groups benefit from model-informed precision dosing of beta-lactam antibiotics and ciprofloxacin at the ICU?

T. Ewoldt¹, A. Abdulla¹, W. Rietdijk¹, N. Hunfeld², A. Muller³, H. E. Endeman⁴, B. Koch¹

¹Department of Hospital Pharmacy, Erasmus University Medical Center, Rotterdam, Netherlands; ²Intensive Care, Erasmus MC, Rotterdam, Netherlands; ³Department of Medical Microbiology and Infectious Diseases, Erasmus University Medical Center, Rotterdam, Netherlands; ⁴Intensive Care, Erasmus University Medical Center, Rotterdam, Netherlands

Correspondence: T. Ewoldt

Intensive Care Medicine Experimental 2023, **11(Suppl 1)**:000643

Introduction: Antibiotic dosing is not optimal in the ICU. Our recent trial investigated the effect of model-informed precision dosing (MIPD) of beta-lactam antibiotics and ciprofloxacin and showed no significant differences in clinical outcomes.

Objectives: This study aimed to identify subgroups of patients in which MIPD of these antibiotics could be beneficial for clinical outcomes.

Methods: We analyzed data from the DOLPHIN randomized controlled trial, which compared MIPD to standard dosing of beta-lactam antibiotics and ciprofloxacin in 388 ICU patients. We divided patients into subgroups based on baseline characteristics and assessed the effect of MIPD on 28-day mortality, 6-month mortality, delta-SOFA, and ICU length of stay (LOS).

The following subgroups were deemed to be of interest: obese patients (BMI ≥ 30 kg/m²), male patients, patients with high renal clearance, younger patients, the use of renal replacement therapy (RRT), low Sequential Organ Failure Assessment (SOFA) score, lack of positive microbiology, and patients with sepsis (defined using the Sepsis III criteria). Patients who received a dose recommendation within 24 h after initiation of the study antibiotic and those that received ceftriaxone were also analyzed as separate subgroups. Groups that were based on continuous variables were divided based on their median value.

For 28-day and 6-month mortality, a binary logistic regression was used, displaying the odds ratio (OR). For the change in SOFA score between day 0 and day 5, a linear regression was used and displayed as estimate. For ICU LOS the associations between MIPD versus standard dosing treatment using a negative Poisson regression was examined and reported as incidence risk ratio (IRR). All data is displayed with corresponding 95% confidence intervals (95% CI).

Results: In total, 450 patients were randomized in the DOLPHIN trial. Due to meeting exclusion criteria between randomization and the first study intervention, 62 patients were excluded from analyses. This leaves 388 patients in total, of which 189 patients are in the MIPD group, and 199 patients in the standard dosing group. The subgroups and their respective cohort sizes are shown in Figure 1.

Patients with a SOFA score below 8 at T0 had a decreased 28-day mortality when randomized to the MIPD group (11% MIPD vs 24% standard dosing; OR 0.40; 95% CI 0.17–0.88) (Figure 2). On the contrary, patients with a SOFA score above or equal to 8 show increased 28-day mortality (39% MIPD vs 25% standard dosing; OR 1.94; 95% CI 1.07–3.59) and 6-month mortality (52% MIPD vs 35% standard dosing; OR 2.04; 95% CI 1.16–3.62) when randomized to MIPD.

Applying MIPD only for ceftriaxone showed a decreased delta-SOFA score (–3 MIPD vs –3 standard dosing; estimate 1.85; 95% CI 0.02–3.67). However, dose recommendations within 24 h resulted in a trend towards increased delta-SOFA score for all antibiotics (–4 MIPD vs –2 standard dosing; estimate –1.19; 95% CI –2.98–0.60).

For both beta-lactams and ciprofloxacin, patients with a SOFA score below 8 at T0 had an increased ICU LOS when randomized to the MIPD group (12 MIPD vs 6 standard dosing; IRR 1.36; 95% CI 1.01–1.83). Early dose recommendations within 24 h showed a trend towards a decreased ICU LOS in MIPD (5 MIPD vs 8 standard dosing; IRR 0.77; 95% CI 0.52–1.16). Using MIPD for only ceftriaxone results in an increased ICU LOS (7 MIPD vs 4 standard dosing; IRR 1.76; 95% CI 1.24–2.51). All other subgroups showed no major differences.

Conclusions: ICU patients with a SOFA below 8 using MIPD had an increased ICU LOS as they had a decreased mortality. In addition, fast dose recommendations using MIPD of beta-lactam antibiotics and ciprofloxacin may be beneficial in ICU patients.

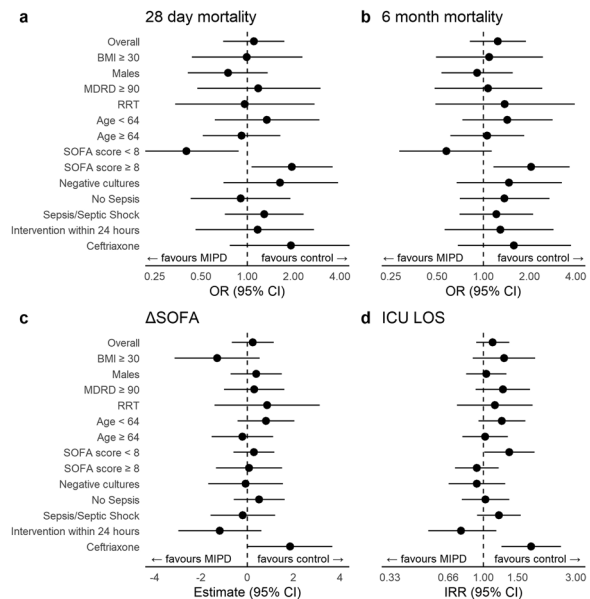

Figure 1 (abstract 000643) Effect sizes in subgroup analyses. Data represented as (a, b) odds ratio (OR), (c) estimate, or (d) incidence risk ratio (IRR) with 95%

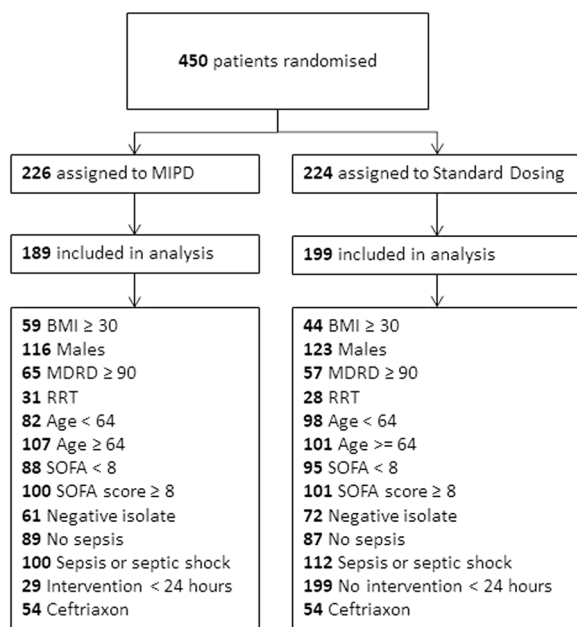

Figure 2 (abstract 000643) Patient flow and subgroup sizes

References

1. Ewoldt, T.M.J., Abdulla, A., Rietdijk, W.J.R. et al. Model-informed precision dosing of beta-lactam antibiotics and ciprofloxacin in critically ill patients: a multicentre randomised clinical trial. *Intensive Care Med* 48, 1760–1771 (2022). <https://doi.org/10.1007/s00134-022-06921-9>
2. This work was supported by the Dutch Organization for Health Research and Development ZonMw [Grant 848017008], Stichting de Merel and Erasmus MC MRace Grant. The funders of the study had no role in study design, data collection, data analysis, data interpretation, or writing of the report.

Topic: Infections and prevention

000644

'Experienced health among ICU survivors and their family members three months post-ICU: an interview study'

M. Onrust¹, I. Van Der Meulen², M. L. Luttkik³, W. Paans², P. Van Der Voort¹, F. Blokzijl¹

¹Critical Care, University Medical Center Groningen, Groningen, Netherlands; ²Research Group Nursing Diagnostics, Hanze University of Applied Sciences Groningen, Groningen, Netherlands; ³Professorship Family Nursing, School of Nursing, Hanze University of Applied Sciences Groningen, Groningen, Netherlands

Correspondence: M. Onrust

Intensive Care Medicine Experimental 2023, **11(Suppl 1)**:000644

Introduction: Admission to an Intensive Care Unit (ICU) can have major consequences on well-being and quality of life after discharge. ICU-survivors and family members can both develop persistent problems (1–3) which has consequences for their social functioning (4). The needs of survivors for care after ICU discharge are often significant (2), making it arduously for them to reassume their role within the family. Family members may experience the pressure of being an informal caregiver while at the same time feeling the need to return to their former lives. To what extent this affects the family relationships is largely unknown.

Objectives: To gain insight in the way ICU-survivors and their family members experience their health in the physical, emotional and social domain, three months after ICU discharge and to explore whether this affects family relationships.

Methods: A cross-sectional qualitative study with an exploratory design using semi-structured interviews was conducted at the ICU of the University Medical Center Groningen (UMCG) in the Netherlands.

All patients with unplanned admission to the ICU between November 2018 and September 2019, with a length of stay of 48 h or more, and their family members, were eligible to participate. Survivors were asked for their consent and for permission to approach family members by telephone. Participants of whom we expected communication problems and participants who did not live in the northern part of the country were excluded.

Participant demographics were retrieved from the Electronic Patient File and collected in the interviews. Interviews with ICU-survivors and family members were conducted at participants' homes three months after ICU admission by four experienced ICU nurses. An interview guide was used with seven open and impartially formulated questions, based on the Research And Development 36-item Health Survey (RAND-36). Furthermore, two quantitative questions on Quality of Life (QoL) were asked by using a 10-point Numeric Rating Scale (NRS). The audio-recorded interviews were transcribed verbatim and subsequently analysed using Atlas.Ti version 22, according to the steps of thematic analysis (5).

Results: A total of 138 patients were eligible for participation. Interviews were conducted until data saturation was reached, resulting in ten survivors and ten family members participating in the study. Mean age was 63 (Standard Deviation [SD] 10) and 64 (SD 6) respectively. Eight of the survivors were male and of the family members five were male. Seven dyads participated, who were interviewed separately from each other. The median ICU Length Of Stay (LOS) was 4.5 days (IQR: 3.2–6).

Five of the survivors evaluated their QoL three months post-ICU lower than before their ICU admission, whereas four of them genuinely rated their QoL higher, with a median of 7 (IQR: 6–7.7) on the NRS. Family members rated their QoL lower than before or equally (median: 8, IQR: 6–8).

The qualitative data of this study are now being analysed and the findings will be presented during the conference.

Conclusions: Five out of ten of the ICU-survivors rated their QoL three months post-ICU lower than before admission, however four out of ten evaluated their QoL higher. The family members rated their QoL lower or the same as before. The qualitative results may provide more insight into the origin of this findings, which may be of use to health-care professionals in improving ICU-aftercare.

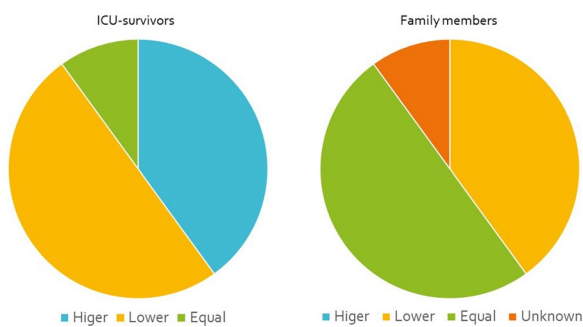

Figure 1 (abstract 000644) Experienced QoL of ICU survivors and family members, three months post-ICU compared to the experienced QoL pre-ICU

References

5. Braun V, Clarke V. Using thematic analysis in psychology. *Qual Res Psychol.* 2006;3(2):77–101.
4. van Beusekom I, Bakshi-Raiez F, de Keizer NF, Dongelmans DA, van der Schaaf M. Reported burden on informal caregivers of ICU survivors: A literature review. *Crit Care.* 2016;20(1).
3. Davidson JE, Jones C, Bienvu OJ. Family response to critical illness: Postintensive care syndrome-family. Vol. 40, *Critical Care Medicine.* 2012. p. 618–24.
2. Geense WW, Zegers M, Peters MAA, Ewalds E, Simons KS, Vermeulen H, et al. New Physical, Mental, and Cognitive Problems 1 Year after ICU Admission: A Prospective Multicenter Study. *Am J Respir Crit Care Med* [Internet]. 2021 Jun 15;203(12):1512–21.
1. Needham DM, Davidson J, Cohen H, Hopkins RO, Weinert C, Wunsch H, et al. Improving long-term outcomes after discharge from intensive care unit: Report from a stakeholders' conference. *Crit Care Med.* 2012;40(2):502–9.
- None to declare.

Topic: Critical care organisation, quality management, information systems, outcomes

000645

Population pharmacokinetics of dexamethasone in critically ill COVID-19 patients: does inflammation play a role?

L. Li¹, S. Sassen², N. Hunfeld³, T. Smeets⁴, T. Ewoldt³, S. Van Den Berg⁵, B. Koch², H. E. Endeman⁶

¹pharmacy, Erasmus University Medical Center, Rotterdam, Netherlands; ²Department of Hospital Pharmacy, Erasmus University Medical Center, Rotterdam, Netherlands; ³Intensive Care, Erasmus MC, Rotterdam, Netherlands; ⁴Hospital Pharmacy, Erasmus University Medical Center, Rotterdam, Netherlands; ⁵Clinical Chemistry, Erasmus MC, Rotterdam, Netherlands; ⁶Adult Intensive Care, Erasmus University Medical Center, Rotterdam, Netherlands

Correspondence: L. Li

Intensive Care Medicine Experimental 2023, **11(Suppl 1)**:000645

Introduction: One of the common causes of COVID-19 related death is acute respiratory distress syndrome (C-ARDS) [1, 2]. Dexamethasone is the cornerstone in the treatment of C-ARDS and reduces mortality probably by suppressing inflammatory levels in ICU patients [3]. Its anti-inflammatory effects may be concentration-dependent. However, no pharmacokinetic studies of dexamethasone have been conducted in ICU patients.

Objectives: The aim of this study is to design a population pharmacokinetic study to gain a deeper understanding of the pharmacokinetics of dexamethasone in critically ill COVID-19 patients in order to identify relevant covariates that can be used to personalize dosing regimens.

Methods: Blood samples from critically ill patients receiving fixed-dose intravenous dexamethasone (6 mg/day) for the treatment of

COVID-19 were sampled in a retrospective pilot study. The data were analyzed using Nonlinear Mixed Effects Modelling (NONMEM) software for population pharmacokinetic analysis and clinically relevant covariates were selected and evaluated.

Results: A total of 51 dexamethasone samples from 18 patients were analyzed and a two-compartment model fit the data best. The mean population estimates were 2.85 L/h (inter-individual-variability 62.9%) for clearance, 15.4 L for the central volume of distribution, 12.3 L for the peripheral volume of distribution and 2.1 L/h for the inter-compartmental distribution clearance. The covariate analysis showed a significant negative correlation between dexamethasone clearance and CRP.

Conclusions: Dexamethasone PK parameters in ICU COVID patients were substantially different from those from non-ICU non-COVID patients, and inflammation may play an important role in dexamethasone exposure. This finding suggests that fixed-dose dexamethasone over several days may not be appropriate for ICU COVID patients.

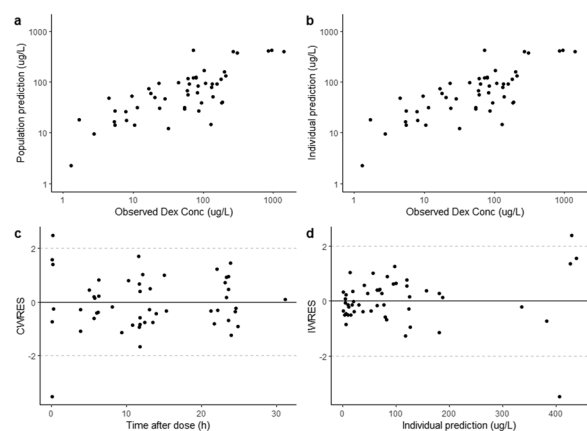

Figure 2 (abstract 000645) Basic goodness of fit plots for the final model: population predictive concentration versus observed concentration (DV) (upper left); individual predictive concentration versus observed concentration (DV) (upper right); time after dose versus individual weighted residuals (IWRES) (lower left); time after dose versus conditional weighted residuals (CWRES) (lower right). CWRES: conditional weighted residuals, DV: dependent variable, IWRES: individual weighted residuals

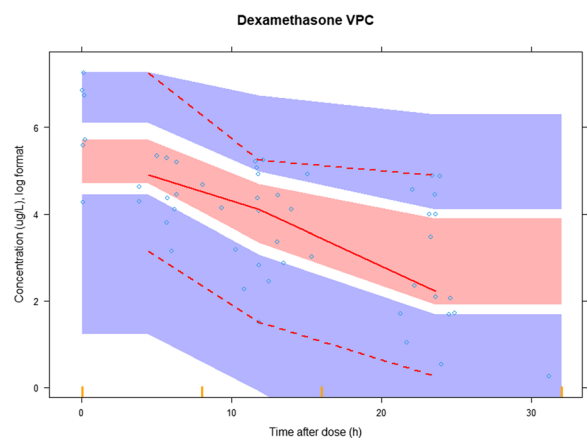

Figure 3 (abstract 000645) The visual predictive check (VPC) of dexamethasone in the final. The x-axis is time after dose (h) and y-axis is concentration of dexamethasone in log transformed format. VPC: visual predictive check

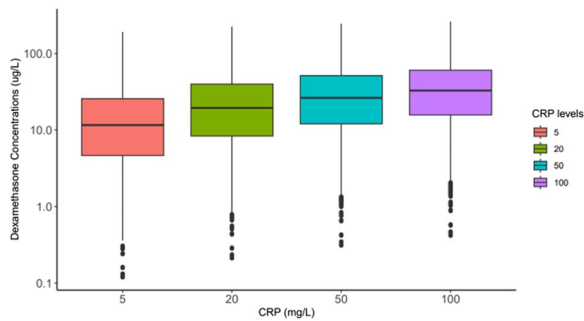

Figure 4 (abstract 000645) Simulation results of trough dexamethasone concentration under different CRP levels (5, 20, 50, 100 mg/L) in standard ICU patient

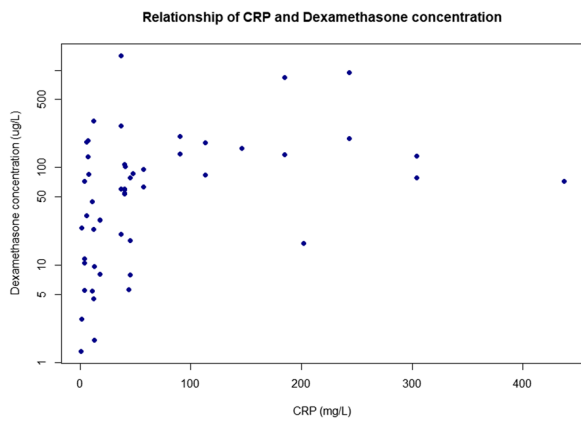

Figure 1 (abstract 000645) Relationship of CRP and dexamethasone concentration. y axis: Patient dexamethasone concentration (µg/L), x axis: CRP (mg/L). CRP: C-reactive protein

References

1. Kim, J.S., et al. Immunopathogenesis and treatment of cytokine storm in COVID-19. *Theranostics* 11, 316–329 (2021)
2. Meyer, N.J., Gattinoni, L. & Calfee, C.S. Acute respiratory distress syndrome. *Lancet* 398, 622–637 (2021)
3. Group, R.C., et al. Dexamethasone in Hospitalized Patients with Covid-19. *N Engl J Med* 384, 693–704 (2021)

Topic: Acute respiratory failure and mechanical ventilation

000646

Sensitivity of methods for confirming gastric tube position

F. Streibert¹, C. Bernhardt¹, P. Simon², H. Wrigge³
¹Dept. of Anaesthesiology, Intensive Care and Emergency Medicine, Pain Therapy, BG Klinikum Bergmannstrost Halle, Merseburger Straße, Halle (Saale), Germany, Halle (Saale), Germany; ²Dept. of Anaesthesiology and Intensive Care, University Hospital Augsburg, Augsburg, Germany; ³Department of Anesthesiology, Intensive Care and Emergency Medicine, Pain Therapy,

Berufsgenossenschaftliche Kliniken Bergmannstrost Halle, Halle (Saale), Germany

Correspondence: F. Streibert

Intensive Care Medicine Experimental 2023, **11(Suppl 1)**:000646

Introduction: Insertion of a gastric tube (GT) is a routine procedure in the intensive care unit (ICU). For immediate position control, the injection of air through the GT with simultaneous auscultation of the epigastrium is probably the most simple and common clinical method. Quality reviews show auscultation finding is misinterpreted by tracheal, bronchial, or pleural secretion, and mispositioning may remain undetected [1–3]. In the worst case, hyperosmolar tube feeding occurs via the misplaced tube into the lungs or pleural space causing subsequent severe pneumonia, pleuritis, and often fatal patients’ outcome (##). Recent data from NHS UK over a five-year period describe 95 unrecognized misplaced gastric tubes in 3 million with a mortality of 30% [4].

In contrast to similar procedures in the ICU, like installation of central venous catheters or endotracheal intubation, no uniform standards for forensic GT position verification exists.

Objectives: The work examines the sensitivity of (1) pH measurement of gastric tube aspirate, point of care ultrasound (POCUS) (2) without and (3) with parallel performed bubble test, as compared with chest X-ray (CXR) as gold standard for GT position control.

Methods: Following ethical approval, study registration (Deutsches Register für Klinische Studien, ID: 00029309), and consent by the patient or legal representative, 300 consecutive ICU patients older than 18 years with indication for GT insertion were included. GT was inserted according to the in-house standard and checked by means of auscultation and CXR. In addition, secretion was aspirated via GT and pH tested, if successful, and a POCUS including bubble test was carried out.

Results: A total of 303 patients with 321 ET placements were included (12 patients received multiple GTs). All patients received a routine CXR, in 239/321 (74.45%) cases exclusively to check GT position. Aspiration was successful in 277/321 (86.3%). Although all patients were treated with proton pump inhibitors for stress ulcer prophylaxis, 207/277 (74.7%) tests showed a pH-Value below the cut off value of 5.5. POCUS allowed a clear position check in a high number of cases (Table 1), and the additional bubble test was successful in all 39 patients, in whom no GT was identifiable in the POCUS alone.

Table 1 (abstract 000646)

Test performed	Success rate single test	Success rate combined test A	Success rate combined test B
pH-Test	321/321	74,7%	100%
POCUS		87,9%	100%
POCUS bubble test		88,5%	
Chest X-ray		100%	

Conclusions: Combination of pH-value measurement and POCUS with bubble test provide a highly sensitive position control of GT and can significantly reduce CXRs solely performed for GT position control. This single center study was not powered to test the specificity of the tests.



Figure 1 (abstract 000646) Abdominal sonography with transversal sound plane, clear sound cancellation by the gastric tube in the center [5]

References

- [5] Streibert F, Bernhardt C, Simon P, Hilbert-Carius P, Wrigge H. Safe position check of gastric tubes: an often underestimated topic to prevent possible severe complications Anaesthesiologie. 2023 Jan;72(1):57–62. German. <https://doi.org/10.1007/s00101-022-01218-4>
- [4] NHS England» Nasogastric tube misplacement: continuing risk of death and severe harm. <https://www.england.nhs.uk/2016/07/nasog-astic-tube-misplacement-continuing-risk-of-death-severe-harm/>. Accessed 15 Feb 2021
- [3] Tho PC, Mordiffi S, Ang E, Chen H (2011) Implementation of the evidence review on best practice for confirming the correct placement of nasogastric tube in patients in an acute care hospital. Int J Evid Based Healthc 9:51–60. <https://doi.org/10.1111/j.1744-1609.2010.00200.x>
- [2] de Aguiar-Nascimento JE, Kudsk KA (2007) Use of small-bore feeding tubes: successes and failures. Curr Opin Clin Nutr Metab Care 10:291–296. <https://doi.org/10.1097/MCO.0b013e3280d64a1d>
- [1] Metheny NA, Meert KL, Clouse RE (2007) Complications related to feeding tube placement. Curr Opin Gastroenterol 23:178–182. <https://doi.org/10.1097/MOG.0b013e3280287a0f>

Topic: Metabolism, endocrinology, liver failure and nutrition

000652

Increased hyaluronan synthesis by overexpression of HAS2 improves pulmonary microvascular endothelial barrier function in ARDS

X. Lu¹, A. Liu²

¹Department of Critical Care Medicine, Zhongda Hospital, School of Medicine, Southeast University, Nanjing, China; ²Department of Critical Care Medicine, Zhongda Hospital, School of Medicine, Southeast University, Nanjing, Jiangsu, China

Correspondence: X. Lu

Intensive Care Medicine Experimental 2023, **11(Suppl 1)**:000652

Introduction: Increased lung permeability due to impaired pulmonary microvascular barrier function is the main pathological change in ARDS. The glycocalyx plays an important role in maintaining the function of the pulmonary endothelial barrier. Since hyaluronic acid synthesized by HAS2 is an important component of the glycocalyx.

Altered HAS2 expression in pulmonary microvascular endothelial cells in ARDS may be important for endothelial barrier function disruption.

Objectives: This study wanted to explore the effect of hyaluronic acid synthesis by HAS2 in pulmonary microvascular endothelial cells on pulmonary microvascular barrier function in ARDS.

Methods: 1. From September 2009 to August 2022, 34 patients with ARDS and 15 patients with severe illness caused by non-infection were enrolled in the department of Intensive Care at Zhongda hospital affiliated to Southeast University, and 10 healthy adult volunteers were recruited. The peripheral blood of ARDS patients was collected on D1 and D3 after admission, and the peripheral blood of non-infection severe group and healthy group was collected on D1 after admission, to compare the correlation between HA content in peripheral blood and the severity and prognosis of ARDS patients, non-infection-induced severe patients and healthy adults.

2. ALI/ARDS Mouse model was established by cecal ligation and puncture (CLP). The expression of HAS2 in lung tissue and the content of HA in lung tissue and plasma were detected, and the relationship between the expression of HAS2 and inflammatory reaction, lung endothelial injury, lung permeability were observed.

3. The expression of HAS-2 and the content of HA in the supernatant of mouse pulmonary microvascular endothelial cells were observed before and after LPS stimulation. A stable transgenic strain of mouse lung microvascular endothelial cells with HAS2 gene overexpression/low expression was constructed, to observe the changes in permeability of endothelial cells with different HAS2 expression levels before and after LPS stimulation.

Results: 1. The content of HA in peripheral blood of Ards patients on D1 and D3 was significantly higher than that of non-infection severe patients and healthy adults ($p < 0.0001$). The content of HA in peripheral blood of ARDS patients was positively correlated with PEEP and SOFA score of invasive mechanical ventilation (Rho: 0.51, 0.61; $P = 0.0024$, < 0.001). The patients were divided into two groups according to the median value of HA content in peripheral blood of ARDS patients on D3 (134.4 ng/ml), the difference of survival analysis between the two groups was statistically significant ($p = 0.01$).

2. HA content in lung tissue of CLP mice was lower than that of Sham group ($P = 0.0038$). HA content in plasma of CLP mice was higher than that of Sham group ($P = 0.0233$). MPO level in lung tissue of CLP mice was higher than that of Sham group ($P = 0.0082$). The wet/dry ratio of lung tissue in CLP group was lower than that in Sham group ($P = 0.026$). The expression of HAS2 mRNA and protein in lung tissue of CLP mice were significantly lower than that of Sham group ($P = 0.021$, 0.0197). The fluorescence intensity of CD31/HAS2 co-localization in lung endothelial cells of CLP mice was lower than that of Sham group ($p < 0.05$).

3. After LPS stimulation for 24 h, the expression of HAS2 mRNA and protein in the lung Endothelium was down-regulated compared with the control group ($p = 0.0018$, 0.0014), and the content of HA in the supernatant of the lung Endothelium stimulated by LPS was increased compared with the control group ($p = 0.0117$). After overexpression low expression of HAS2 gene in mouse lung Endothelium, the control group was cultured in Trans-Well chamber and the lung Endothelium were treated with LPS for 24 h, the results showed that the permeability of the Endothelium with HAS2 overexpression was lower than that of the control group ($p = 0.0036$), and that of the Endothelium with HAS2 overexpression was higher than that of the control group ($p = 0.047$).

Conclusions: Down-regulation of HAS-2 expression in ARDS leads to a decrease in HA synthesis, which increases endothelial permeability. Overexpression of HAS2 can increase HA synthesis and improve pulmonary microvascular endothelial barrier function.

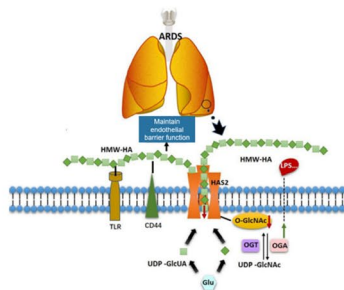
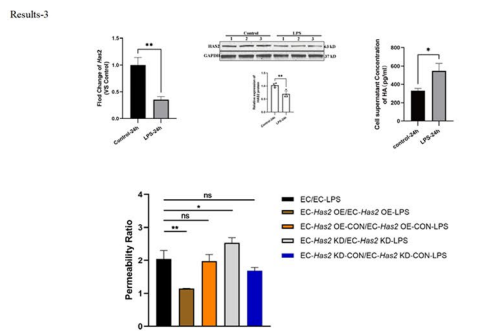
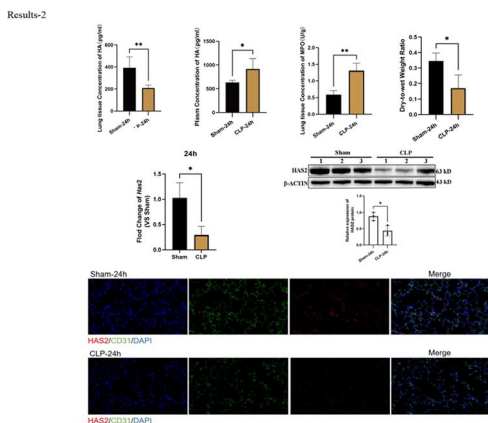
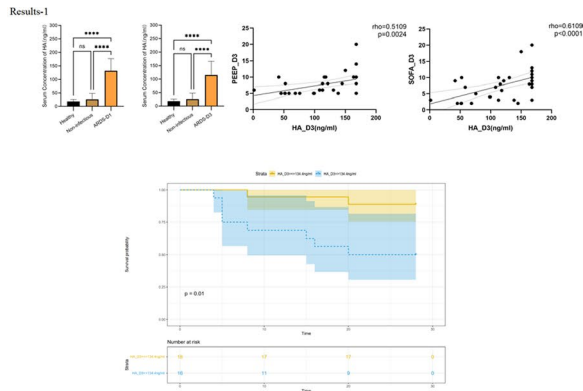

References

1. This work was supported by the General Program of National Natural Science Foundation of China (No. 82072154).

Topic: Acute respiratory failure and mechanical ventilation

000653

Immunological sub-phenotypes and response to Convalescent Plasma (CP) in COVID-19 induced ARDS (C-ARDS): a hierarchical cluster analysis

B. Misset¹, A. N. Diep², S. Robinet³, E. Hoste⁴, M. Piagnerelli⁵, A. Bertrand⁶, M. Moutschen⁷, E. Cavalier⁸, A. F. Donneau², P. F. Laterre⁹
¹Department of Intensive Care, CHU de Liège, Avenue de L'Hôpital, Liège, Belgium, Liège, Belgium; ²Biostatistic Unit, Public Health Department, University of Liège, Liège, Belgium; ³Department of Intensive Care, University Hospital Liege, Liège, Belgium; ⁴Icu, Ghent University Hospital, Gent, Belgium; ⁵Department of Intensive Care Medicine, Marie curie, Chaussée de Châtelet, Charleroi, Belgium, Charleroi, Belgium; ⁶Intensive Care, University Hospital Liege, Liège, Belgium; ⁷Department of Infectious Diseases, CHU de Liège, Avenue de L'Hôpital, Liège, Belgium, Liège, Belgium; ⁸Clinical Chemistry, University Hospital of Liège, Liège, Belgium; ⁹Intensive Care Unit, Cliniques Universitaires Saint-Luc, Brussels, Belgium

Correspondence: B. Misset

Intensive Care Medicine Experimental 2023, 11(Suppl 1):000653

Introduction: The Belgian multicentric CONFIDENT RCT has shown a reduced day-28 mortality in C-ARDS patients treated with CP. As COVID-19 patients are immunologically heterogeneous, we hypothesized that immunologically similar COVID-19 clusters may differ in their treatment responses to convalescent plasma.

Methods: We measured 20 cytokines, chemokines and cell adhesion markers using a multiplex Luminex technique in patients at the time of inclusion in the CONFIDENT trial. We performed descriptive statistics, hierarchical cluster analysis and search for association between the identified clusters and CP effect on day-28 mortality. Ethics Committee of the University Hospital of Liège CE 2020/239. Clinicaltrials.gov NCT04558476.

Results: 384 patients out of 475 included in CONFIDENT were sampled. Missing samples were completely at random because several centers did not sample for this sub-study.

Age 64 [56–72] years, BMI 30 [26–35] kg/m², delay from hospital admission 4.6 [2.7–7.4] days, SOFA 6 [4–8], PEEP 10 [10–12] cmH₂O, FiO₂ 65 [50–80]%, CRP 123 [66–192] mg/L, steroids 98%.

Median [IQR] levels of the biomarkers in pg/mL: MIP-1α=4.1 (2.3–10.3), IL-1β=1.6 (1.6–17.4), IL-4=18 (13–27), IP-10=127 (48–275), IL-6=16 (10–124), IL-8=13 (5–26), IL-10=3.4 (1.6–9.3), IL-12p70=14 (8–69), IL-13=3.4 (3.4–7.2), IL-17A=4.2 (2.9–12.7), IFNγ=10 (10–26), GM-CSF=12 (12–12), TNFα=16 (10–30), MIP-1β=76 (44–134), IFNα=0.8 (0.8–3.2), MCP-1=240 (103–3962), P-Selectin=192,818 (3781–356,545), IL-1α=2.3 (1.3–3.8), ICAM-1=199,975 (127,457–313,908), E-selectin=29,943 (18,869–43,647).

Unsupervised learning analyses identified 3 clusters of participants. The most contributing biomarkers to distinguish cluster 1 (n=181, 47.1%) from cluster 2 (n=99, 25.8%) are IL-1 β, IL-12p70, IL-6, IFN α, and IL-17A (CTLA-8) and cluster 3 (n=104, 27.1%) IL-6, MCP-1 (CCL2), IL-8 (CXCL8), IL-10, IP-10 (CXCL10), MIP-1 α (CCL3). The treatment effect of convalescent plasma was found in cluster 2 with those receiving the CP having a significant lower likelihood of mortality at D-28, OR=0.42 (95% CI: 0.19–0.95).

Conclusions: In a population of patients with COVID-19 induced ARDS during the first days of invasive mechanical ventilation, we identified 3 sub-phenotypes of immune profile with different response to convalescent plasma.

References

1. Misset B, BMC Pulm Med. 2020;20:317.
2. KCE 2020, 1-0-1 AXA 2021, Liège University 2021.

Topic: Sepsis

000654

Association between the body mass index and short- and long-term mortality in Korean septic patients: a retrospective cohort study

I. Park¹

¹Department of Anesthesiology and Pain Medicine, Seoul National University Bundang Hospital, Seongnam-si, Republic of Korea

Correspondence: I. Park

Intensive Care Medicine Experimental 2023, 11(Suppl 1):000654

Introduction: Sepsis is a major contributor of the intensive care unit (ICU) patient mortality in many countries, including Korea. The “obesity paradox” in critical illness has raised a great consideration in the scientific community, and a number of studies have also explored the association between obesity and mortality in patients with sepsis and septic shock using the body mass index (BMI) as a representation of the patient’s body fat. Obesity is reported to exhibit a protective effect on the survival of septic patients, but the results have been inconsistent.

Objectives: We investigated the association between obesity and 30-day and 1-year mortality in septic patients.

Methods: This retrospective study included patients with either sepsis or septic shock who were admitted to the ICU between November 2013 and May 2017. Based on the BMI, patients were categorized as underweight (<18.5 kg/m²), normal weight and overweight (18.5–25.0 kg/m²) and obese (≥ 25.0 kg/m²) in accordance to the Asia-Pacific World Health Organization guidelines. Primary endpoints were the 30-day and 1-year mortality from the date of ICU admission. Risk factors were analyzed via Cox proportional hazard regression analyses. The Kaplan–Meier survival curves were compared via a signed log rank test.

Results: Out of the total 834 patients, 207 (24.8%), 478 (57.3%), and 149 (17.9%) patients were underweight, normal weight and obese, respectively. Obesity was associated with lower 30-day (HR 0.61, 95% CI 0.41 to 0.89, P=0.012) and 1-year mortality (HR 0.75, 95% CI 0.57 to 0.98, P=0.037). Being underweight had no effect on the 30-day mortality (P=0.683) but was associated with higher 30-day mortality (HR 1.44, 95% CI 1.17 to 1.77, P=0.001). The 1-year survival was longest in obese patients followed by normal weight and underweight patients (Ps<0.032). The 30-day survival was not different among the three groups (Ps>0.05).

Conclusions: Obesity was associated with lower 30-day and 1-year mortality in septic patients. Being underweight showed no difference in 30-day mortality but higher 1-year mortality.

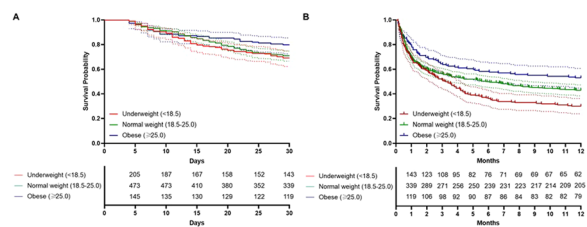
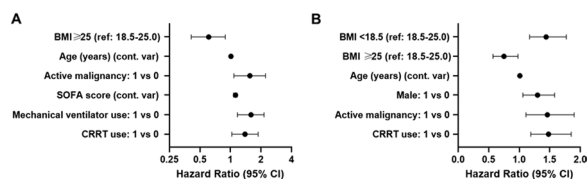

References

- Li S, Hu X, Xu J, Huang F, Guo Z, Tong L, et al. Increased body mass index linked to greater short- and long-term survival in sepsis patients: A retrospective analysis of a large clinical database. *Int J Infect Dis.* 2019;87:109–16.
- Zhang L, Fang L, Lihua H, Li C. Association between obesity and 1-year mortality in septic patients: a retrospective cohort study. *BMJ Open.* 2023;13(2):e066526.
- Zhou Q, Wang M, Li S, Zhang J, Ma Q, Ding Y, et al. Impact of body mass index on survival of medical patients with sepsis: a prospective cohort study in a university hospital in China. *BMJ open.* 2018;8(9):e021979.
- Wurzinger B, Dünser MW, Wohlmuth C, Deutinger MC, Ulmer H, Torgersen C, et al. The association between body-mass index and patient outcome in septic shock: a retrospective cohort study. *Wien Klin Wochenschr.* 2010;122(1–2):31–6.
- Sato T, Kudo D, Kushimoto S, Hasegawa M, Ito F, Yamanouchi S, et al. Associations between low body mass index and mortality in patients with sepsis: A retrospective analysis of a cohort study in Japan. *PLoS one.* 2021;16(6):e0252955.
- Oami T, Karasawa S, Shimada T, Nakada T-a, Abe T, Ogura H, et al. Association between low body mass index and increased 28-day mortality of severe sepsis in Japanese cohorts. *Scientific reports.* 2021;11(1):1–7.
- Weng L, Fan J, Yu C, Guo Y, Bian Z, Wei Y, et al. Body-mass index and long-term risk of sepsis-related mortality: a population-based cohort study of 0.5 million Chinese adults. *Critical Care.* 2020;24(1):1–9.
- Pepper DJ, Demirkale CY, Sun J, Rhee C, Fram D, Eichacker P, et al. Does obesity protect against death in sepsis? A retrospective cohort study of 55,038 adult patients. *Critical care medicine.* 2019;47(5):643.
- none
- Paulsen J, Askim Å, Mohus RM, Mehl A, Dewan A, Solligård E, et al. Associations of obesity and lifestyle with the risk and mortality of bloodstream infection in a general population: a 15-year follow-up of 64027 individuals in the HUNT Study. *Int J Epidemiol.* 2017;46(5):1573–81.
- Chae M-J, Choi D-J, Shin T-G, Jeon K-M, Suh G-Y, Sim M-S, et al. Body mass index and outcomes in patients with severe sepsis or septic shock. *Korean Journal of Critical Care Medicine.* 2013;28(4):266–71.

Topic: Metabolism, endocrinology, liver failure and nutrition

000656

Echocardiographic findings in mechanically ventilated Covid-19 ARDS patients

G. Zakyntinos¹, V. Tsolaki², N. Karavidas², V. Vazgiourakis², D. Makris³

¹3rd Cardiology Clinic, Sotiria Thoracic Diseases Hospital of Athens, Athina, Greece; ²Intensive Care Unit, Larissa General University Hospital, Larissa, Greece; ³Intensive Care Unit, Faculty of Medicine, University of Thessaly, Larissa, Greece

Correspondence: V. Tsolaki

Intensive Care Medicine Experimental 2023, 11(Suppl 1):000656

Introduction: Cardiac injury is frequently reported in Corona virus disease 2019 (Covid-19) patients. Yet, many reports rely on elevated cardiac biomarkers to diagnose the myocardial involvement and few have focused on detailed echocardiographic findings.

Objectives: We aimed to comprehensively describe the cardiac function in mechanically ventilated (MV) Covid-19 Acute Respiratory Distress Syndrome (ARDS) patients, using 2D/4D echocardiography.

Methods: We prospectively evaluated the cardiac function in consecutive MV Covid-19 ARDS patients (04/2020–09/2021, University Hospital of Larissa, Greece) during the first 48 h of ICU admission. Patients with 1. severe pre-existing cardiac/lung disease and 2. pulmonary embolism, were excluded. Increased pulmonary afterload was considered if patients presented: Pulmonary Artery Systolic Pressure (PASP) > 38 mmHg, Pulmonary Acceleration Time < 90 ms, a notch in the ascending part of the (velocity time integral in the right ventricular outflow tract)VTIRVOT envelope.

Results: One hundred and sixty one patients were assessed. The mean age was 65.57±0.92, (117 male, 72.7%), were intubated on the 10.8±0.4 day from Covid-19 symptom onset. Comorbidities included: arterial hypertension (117, 72.7%), diabetes mellitus (43, 26.7%), Coronary Artery Disease [without heart failure, (13, 8%)], mild

Chronic Obstructive Pulmonary Disease (16, 9.9%), smoking habitus (24, 14.9%). The RV was dilated [RV End-Diastolic Area/Left Ventricular End-Systolic Area (RVEDA/LVEDA): 0.91 ± 0.03]. RV systolic function was also impaired: Right Ventricular Longitudinal strain (RV-LS) was severely reduced [RV-LS = $-13.02 \pm 0.46\%$. RV-LS < 20% in was present in almost the whole cohort 146/155 (94.2%) patients measured], while RV-LS ≤ 17 (average value reported in severe Covid-19 patients) was present in 122/155 (78.7%). Tricuspid Annular Plane Systolic Excursion, (TAPSE) ≤ 16 mm was present in 49/177 (27.68%) and RV Fractional Area Change, RVFAC $\leq 35\%$ in 97/184 (52.72%), while RV ejection Fraction (RVEF) $\leq 44\%$ was present in 71/93 (76.34%) of patients. Increased Pulmonary Vascular Resistances (PVRs) were present in 120/143 (83.9%) and right ventriculoarterial coupling (VACR) was excessively decreased (0.57 ± 0.04 mm/mmHg). Although the mean Ejection Fraction (EF) was almost normal ($55.21 \pm 1.07\%$), LV-LS was severely decreased ($-13.15 \pm 0.46\%$). Troponin levels were increased in 51 patients (0.93 ± 0.15 ng/ml) and correlated to RV function and LVEF. Mild (<10 mm) pericardial infusion (in diastole) was present in 59/161 (36.64%) patients.

Conclusions: The myocardial function is affected in MV Covid-19 ARDS patients. Increased RV afterload was documented, while conventional echocardiography may fail to depict the effects on LV systolic function which were mainly unraveled with longitudinal strain imaging.

Topic: Cardiovascular issues in ICU

000657

Human umbilical cord mesenchymal stem cells-derived exosomes attenuate heat stroke-induced neuroinflammation by modulating microglia M1/M2 phenotypes

L. Wang¹, Z. Deng², Y. Li³, H. Kang⁴

¹Department of Critical Care Medicine, Chinese PLA General Hospital, Beijing, China; ²Graduate School, Chinese PLA General Hospital, Beijing, China; ³Department of Critical Care Medicine, Chinese PLA General Hospital, Beijing, China; ⁴Department of Critical Care Medicine, Chinese PLA General Hospital, Beijing, China

Correspondence: L. Wang

Intensive Care Medicine Experimental 2023, 11(Suppl 1):000657

Introduction: Heat stroke (HS) is a clinical syndrome characterized by the rapid rise of body core temperature (>40.5 °C) caused by exposure to high temperature environment. Central nervous damage inflammation plays an important role in the occurrence and development of heat stroke. The polarization state of microglia is closely related to the inflammation of the central nervous system. Previous studies have indicated that mesenchymal stem cells (MSCs) could protect against inflammation and brain injury in heat stroke. However, whether MSCs exosome activated microglia from M1 to M2 phenotypes under heat stress conditions is still unknown.

Objectives: In this study, we focused on microglial phenotypic modulation to investigate the mechanisms underlying the anti-inflammatory effects of MSCs exosome in vivo and in vitro.

Methods: Exosomes were extracted from human umbilical cord mesenchymal stem cells, and characterized by transmission electron microscopy, nanoparticle tracking analysis and western blotting. The expression of long non-coding RNAs in exosomes was detected by high-throughput sequencing and verified by qRT-PCR. In vitro and in vivo models of heat stroke were compared with whether LncRNA-VIM-AS1 was overexpressed or not treated with exosomes from human umbilical cord mesenchymal stem cells. The expression of M1/M2 microglia genes and proteins was detected by qRT-PCR and western blot. The proliferation rate of M1/M2 microglia was detected by flow cytometry. The concentration of pro-inflammatory and anti-inflammatory factors in the medium was detected by Elisa, and the interaction between lncRNAs, microRNAs and mRNA was detected by luciferase reporter assay.

Results: Exosomes from human umbilical cord mesenchymal stem cells promote functional behavioral recovery by transferring microglial polarization from M1 to M2 phenotype in vivo and in vitro. High-throughput sequencing results showed that LncRNA-VIM-AS1

was most enriched in human umbilical cord mesenchymal stem cell exosomes, and may be involved in human umbilical cord mesenchymal stem cell exosome-mediated microglial polarization. LncRNA-VIM-AS1 upregulation promotes microglial M1/M2 polarization by inhibiting miR-34a-5p and promoting Per2 expression, and was confirmed by a series of gain and loss-of-function experiments.

Conclusions: We demonstrate that lncRNA-VIM-AS1-enriched exosomes from human umbilical cord mesenchymal stem cells can inhibit microglial inflammation by down-regulating miR-34a-5p and promoting Per2 expression, which can shift microglial polarization from M1 to M2, providing neuroprotection and functional improvement after heat stroke.

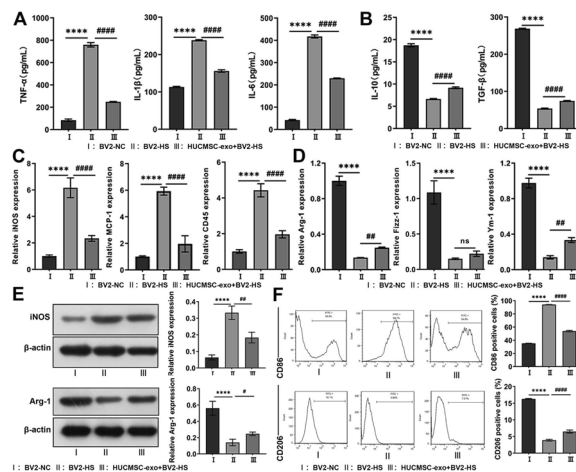

Figure 1 (abstract 000657) HUC-MSCs promote the polarization of heat shock model microglia from M1 to M2 phenotype. A, B) The concentration of pro-inflammatory and anti-inflammatory cytokines in different groups. C, D) qRT-PCR assay was conducted to detect the expression level of M1- and M2-related genes in BV2 cells. E) The protein levels of M1- and M2-related genes were detected by western blot analysis. F) Flow cytometry analysis of M1/M2 microglia. Data were expressed as mean \pm SD, *P < 0.05, **P < 0.01, ***P < 0.001, ****P < 0.0001

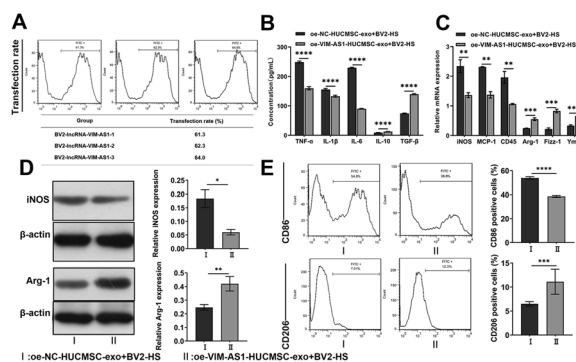

Figure 2 (abstract 000657) LncRNA-VIM-AS1 in HUCMSC?exo promote the polarization of heat shock model microglia from M1 to M2 phenotype. A) Flow cytometry assay of the transfection rate of VIM-AS1 from HUCMSC?exo to BV2 cell. B) The concentration of pro-inflammatory and anti-inflammatory cytokines in different groups by Elisa assay. C) qRT-PCR assay was conducted to detect the expression level of M1- and M2-related genes. D) The protein levels of M1- and M2-related genes were detected by western blot assay. E) Flow cytometry assay of M1/M2 microglia. Data were expressed as mean \pm SD, *P < 0.05, **P < 0.01, ***P < 0.001, ****P < 0.0001

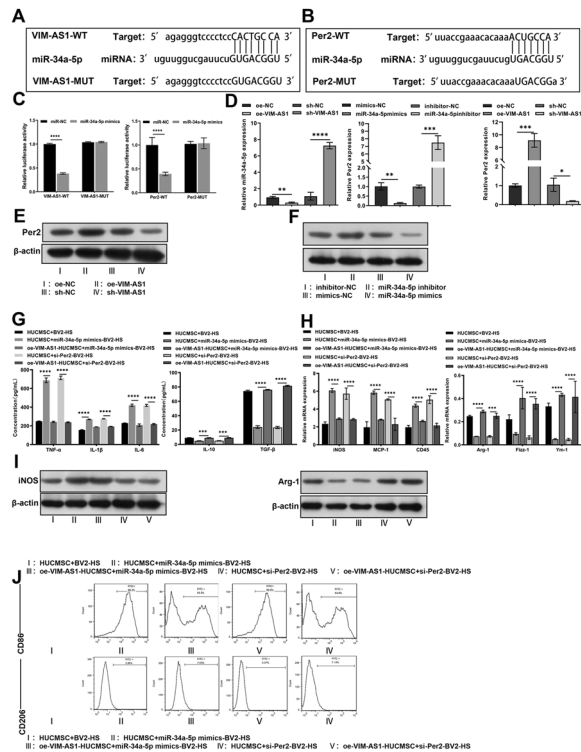

Figure 3 (abstract 000657) Exosomal LncRNA-VIM-AS1 regulates microglia M1/M2 polarization by targeting miR-34a-5p/ Per2 axis. A) The predicted binding region between VIM-AS1 and miR-34a-5p. B) The predicted binding region between Per2 and miR-34a-5p. C) Luciferase reporter assay. D) The expression level of miR-34a-5p and Per2 were detected by qRT-PCR assay. E–F) The protein levels of Per2 were detected by western blot assay. G) The concentration of pro-inflammatory and anti-inflammatory cytokines in different groups by Elisa assay. H) qRT-PCR assay was conducted to detect the expression level of M1- and M2-related genes. I) The protein levels of M1- and M2-related genes were detected by western blot analysis. J) Flow cytometry analysis of M1/M2 microglia. Data were expressed as mean \pm SD, * P < 0.05, ** P < 0.01, *** P < 0.001, **** P < 0.0001

References

- Chen J, Chen Y, Du X, Liu G, Fei X, Peng J R, Zhang X, Xiao F, Wang X, Yang X, Feng Z. Integrative Studies of Human Cord Blood Derived Mononuclear Cells and Umbilical Cord Derived Mesenchyme Stem Cells in Ameliorating Bronchopulmonary Dysplasia [J]. *Front Cell Dev Biol*, 2021, 9:679866.
- Hsuan Y C, Lin C H, Chang C P, Lin M T. Mesenchymal stem cell-based treatments for stroke, neural trauma, and heat stroke [J]. *Brain Behav*, 2016, 6(10): e00526.
- Phinney D G, Pittenger M F. Concise Review: MSC-Derived Exosomes for Cell-Free Therapy [J]. *Stem Cells*, 2017, 35(4): 851–8.
- Zhang Y, Deng Z, Li Y, Yuan R, Yang M, Zhao Y, Wang L, Zhou F, Kang H. Mesenchymal Stem Cells Provide Neuroprotection by Regulating Heat Stroke-Induced Brain Inflammation [J]. *Front Neurol*, 2020, 11:372.
- Wang L, Deng Z, Yuan R, Zhao Y, Yang M, Hu J, Zhang Y, Li Y, Zhou F, Kang H. Protective effect and mechanism of mesenchymal stem cells on heat stroke induced intestinal injury [J]. *Exp Ther Med*, 2020, 20(4): 3041–50.
- Chio C C, Lin M T, Chang C P. Microglial activation as a compelling target for treating acute traumatic brain injury [J]. *Curr Med Chem*, 2015, 22(6): 759–70.
- Loane D J, Kumar A. Microglia in the TBI brain: The good, the bad, and the dysregulated [J]. *Exp Neurol*, 2016, 275 Pt 3(0 3): 316–27.

- Du L, Zhang Y, Chen Y, Zhu J, Yang Y, Zhang H L. Role of Microglia in Neurological Disorders and Their Potentials as a Therapeutic Target [J]. *Mol Neurobiol*, 2017, 54(10): 7567–84.
- Liu R, Liao X Y, Pan M X, Tang J C, Chen S F, Zhang Y, Lu P X, Lu L J, Zou Y Y, Qin X P, Bu L H, Wan Q. Glycine Exhibits Neuroprotective Effects in Ischemic Stroke in Rats through the Inhibition of M1 Microglial Polarization via the NF- κ B p65/Hif-1 α Signaling Pathway [J]. *J Immunol*, 2019, 202(6): 1704–14.
- Li G, Guo Q, Liu Y, Li Y, Pan X. Projected Temperature-Related Years of Life Lost From Stroke Due To Global Warming in a Temperate Climate City, Asia: Disease Burden Caused by Future Climate Change [J]. *Stroke*, 2018, 49(4): 828–34.

Topic: Translational Medicine

000658

Regional citrate anticoagulation for continuous renal replacement therapy protocol in a peripheral Portuguese ICU—How are we doing?

M. Gordinho¹, L. Cunha¹, B. Banheiro¹, A. Baptista¹

¹Intensive Care Medicine Department, Serviço de Medicina Intensiva 2, Centro Hospitalar Universitário do Algarve – Unidade de Portimão, Portimão, Portugal

Correspondence: M. Gordinho

Intensive Care Medicine Experimental 2023, **11(Suppl 1)**:000658

Introduction: Acute kidney injury (AKI) is one of the most prevalent organ dysfunctions present in a critical patient. The management of patients with AKI is mainly supportive, with continuous renal replacement therapy (CRRT) used in patients with severe kidney injury or its complications. CRRT often requires effective anticoagulation of the extracorporeal circuit in order to prevent filter clotting, improve the efficacy of CRRT and prolong filter life. Despite being the suggested choice for anticoagulation by the KDIGO guidelines, regional citrate anticoagulation (RCA) is still not the most used worldwide compared to systemic anticoagulation with unfractionated heparin (SUH). This results from the perception that RCA is a complex technique, difficult to monitor and with a significant number of potential side effects. In order to avoid these misconceptions, our ICU developed an ubiquitous RCA for CRRT protocol, in partnership with intensivists and nephrologists, without any exclusion criteria. Both the medical and nursing staff were comprised of stable, well trained and meticulous teams, extremely attentive and experienced in extracorporeal techniques that replace kidney function.

Objectives: This study aims to do a retrospective evaluation of the quality and safety of the protocol instituted for CRRT in our peripheral Portuguese ICU between 2018 and 2022.

Methods: We performed a retrospective study on all the patients who underwent renal replacement therapy in our ICU between 1 January of 2018 and 31 December of 2022.

Results: Among the 101 patients enrolled, 65,4% were male, the mean age was 65,45 (\pm 12,35) years old, the mean weight was 75,8 kg and the mean BMI was 26,76. The baseline value of serum creatinine was 1,89 mg/dL, a previous history of chronic kidney disease was present in 26,73% of the patients and 9,90% were already under a dialysis program. The mean APACHE score was 29,09, the mean SAPSII was 58,81 and the mean maximum renal SOFA score was 3,61. The day before the start of CRRT the mean serum creatinine was 4,97 and the mean urine output was 0,415 mL/Kg/h. The most common indications to start CRRT were the patient's incapacity in managing volume, severe nitrogen retention and severe acidosis (or alkalosis). Of the patients enrolled, in 91,51% was used RCA, in 2,83% was used SUH and in 5,66% no regional or systemic anticoagulation was initiated. The mean dialysis dose was 1841,38 mL (approximately 23,68 mL/Kg), the mean pump velocity was 110,34 mL/min and the mean citrate concentration was 2,78 mmol/L. The CCRT was considered effective, as shown by the decrease of serum creatinine levels—a decrease of 54,89% after 48h of CRRT and of 61,89% after 72h. Also, in the patients who needed CRRT because of severe acidosis, we documented an increase of the mean pH—7,257 at the beginning of CRRT,

7,301 24h after the start, 7,331 48h after and 7,343 after 72h. To control de safety of the protocol, we used calcium compensation as an initial surrogate of citrate toxicity. After 24h of CRRT, 7.32% of patients had an increase in calcium compensation, number that rose to 7.81% and 8%, respectively at 48h and 72h. In those patients a total calcium to ionized calcium ratio was obtained, and only 2.17% of the patients showed toxic levels that forced citrate to be switch to other type of anticoagulation.

Conclusions: AKI is a frequent diagnosis in the ICU, despite only a small fraction develop the need to CRRT. In our retrospective evaluation, we found that the majority of our patients underwent RCA for CRRT and only a negligible percentage needed other types of anticoagulation. Our data shows that the protocol that we developed and instituted in our ICU was always adhered to, without frequent need to adjust our strategy. It also shows that RCA is safe regarding the extremely low percentage of patients that developed citrate toxicity and needed to switch to other means of anticoagulation. The results of our study also confirm the inexistence of absolute contraindications to RCA for CRRT—because RCA showed to be safe in the vast majority of patients, regardless of medical history and reason of admission at the ICU. This shows that under cautiously developed protocols, RCA is relatively easy to use, being safer, cheaper and with lesser associated complications compared to other means or the lack of anticoagulation.

Topic: Acute Kidney Injury and haemofiltration

000659

Incidence and outcomes of sepsis-associated encephalopathy: a nationwide prospective cohort study

Y. H. Ahn¹, J. Lee², D. K. Oh³, L. Su Yeon³, M. H. Park³, C. M. Lim³, S. M. Lee⁴, H. Y. Lee²

¹Department of Critical Care Medicine, Seoul National University Hospital, Seoul, Republic of Korea; ²Internal Medicine, Seoul National University Hospital, Seoul, Republic of Korea; ³Department of Pulmonary and Critical Care Medicine, Asan Medical Center, Seoul, Republic of Korea; ⁴Department of Pulmonary and Critical Care, Seoul National University Hospital and Seoul National University College of Medicine, Seoul, Republic of Korea

Correspondence: Y. H. Ahn

Intensive Care Medicine Experimental 2023, **11(Suppl 1)**:000659

Introduction: The inflammatory, metabolic, and hemodynamic disturbances observed in sepsis can lead to the development of sepsis-associated encephalopathy (SAE), a condition characterized by diffuse brain dysfunction that presents on a spectrum ranging from delirium to coma. As SAE is frequently observed in critically ill patients, understanding its impact on clinical outcomes is important.

Objectives: To explore the association between SAE and mortality in patients with sepsis.

Methods: This nationwide, prospective cohort study analyzed patients with sepsis admitted to 20 tertiary hospitals between September 2019 and December 2021. SAE was defined as a Glasgow coma score (GCS) < 15 in patients without neurologic infection; those with preexisting neurological disease (stroke, epilepsy, encephalitis), metabolic encephalopathy, and dementia were excluded. The primary outcome of in-hospital mortality was analyzed by logistic regression adjusted for key prognostic factors.

Results: Of the 5723 patients included in the study, 2634 (46%) developed SAE, and a total of 2657 (46.4%) were admitted to the intensive care unit (ICU). Significant differences in terms of comorbidities, sequential organ failure assessment scores, and laboratory values were observed between patients with SAE and those without. SAE was associated with both higher in-hospital mortality (adjusted odds ratio [aOR], 1.66; 95% confidence interval [CI], 1.46–1.9) and ICU mortality (aOR, 1.7; 95% CI, 1.39–2.09). In addition, patients with SAE who survived until discharge had a longer length of stay in the ICU (5 [3–10] vs 4 [2–7] days; $P < 0.001$) and were less likely to be discharged to home (1,043 [63.9] vs 1,940 [82]; $P < 0.001$). When stratified according to SAE severity, higher 28-day mortality was observed in patients with lower GCS scores ($P < 0.001$, log-rank test) (Figure 1).

Table 1 (abstract 000659) Clinical outcomes according to SAE status

Variables	Non-SAE (N = 3089)	SAE (N = 2634)	P-value	Adjusted OR (95% CI)*
In-hospital mortality	723/3089 (23.4)	1001/2634 (38)	0.05	1.66 (1.46–1.9)
ICU mortality	230/1231 (18.7)	443/1426 (31.1)	0.37	1.7 (1.39–2.09)
Hospital LOS, days				
Survivors	14 (8–26)	15 (9–26)	0.28	
Non-survivors	12 (4–28)	7 (2–19)	< 0.001	
ICU LOS, days				
Survivors	4 (2–7)	5 (3–10)	< 0.001	
Non-survivors	5 (2–12)	4 (1–11)	0.08	
Discharge location				
Home	1940 (82)	1043 (63.9)	< 0.001	
Other hospital	426 (18)	590 (36.1)		

Values reported as n (%) for categorical variables and median (IQR) for continuous variables

CI confidence interval, ICU intensive care unit, LOS length of stay, OR odds ratio, SAE sepsis-associated encephalopathy

*Adjusted for age, sex, BMI, diabetes mellitus, malignancy, Charlson Comorbidity Index, clinical frailty scale, non-neurologic Sequential Organ Failure Assessment score, septic shock, and lactate

Conclusions: SAE is a common complication of sepsis that is associated with adverse clinical outcomes.

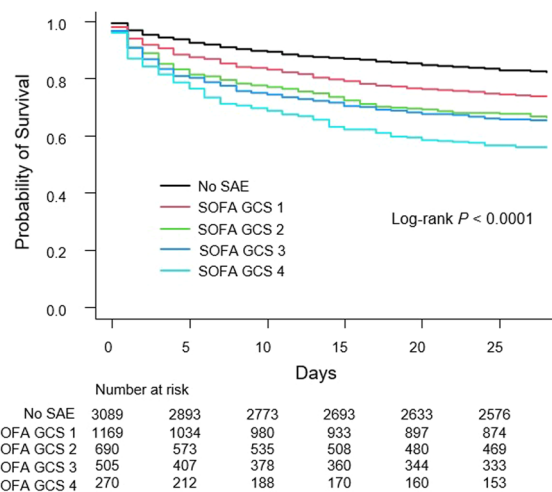

Figure 1 (abstract 000659) Kaplan–Meier estimates of 28-day mortality according to SAE severity. For each time interval, the survival probability was calculated as the number of patients who survived divided by the number of patients at risk

References

- Gofton TE, Young GB. Sepsis-associated encephalopathy. *Nat Rev Neurol*. 2012;8(10):557–66.
- This work was supported by the Research Program funded by the Korea Disease Control and Prevention Agency and supported by Korean Sepsis Alliance (KSA) affiliated with Korean Society of Critical Care Medicine (KSCCCM)

Topic: Sepsis

000660

Comparison of different dynamic tools in prediction of fluid responsiveness in shock

M. Khalil¹, G. Hamed¹, A. Abouelela², M. Fakher¹, Y. Nassar¹
¹Critical Care Medicine, Faculty of Medicine Kasr Al-Ainy, Cairo University, Cairo, Egypt; ²Critical Care Medicine, Alexandria Faculty of Medicine, Alexandria, Egypt

Correspondence: A. Abouelela
 Intensive Care Medicine Experimental 2023, 11(Suppl 1):000660

Introduction: Accurate choice of tools guiding fluid management of critically ill patients is crucial since excessive volume expansion and hyperhydration have been shown to increase morbidity and mortality.

Objectives: To compare the effectiveness and accuracy of different invasive and noninvasive dynamic tools in the prediction of fluid responsiveness, in relation to an actual volume challenge (500 ml) monitored by invasive Peripherally inserted continuous cardiac output (PICCO) as a gold standard in shocked mechanically ventilated adult patients.

Methods: 40 critically ill shocked adult patients, on controlled mechanical ventilation (MV) with Tidal volume 8 ml/kg, sinus rhythm. Exclusion criteria; arrhythmia, spontaneous breathing, and valvular heart disease. Noninvasively tools monitored by Doppler/Echo: Inferior vena cava distensibility index (IVC-DI), delta velocity time integral (Δ VTI) of the left ventricular outflow tract. Invasive tools monitored by PICCO: stroke volume variation (SVV), pulse pressure variation (PPV), end-expiratory occlusion (EEO) test, passive leg raising (PLR) test, and the actual volume bolus (500 ml) challenge. A truly positive or truly negative result of each tool was considered if it coincided with the result of the gold standard actual volume bolus. Sensitivity (Sens), Specificity (Sp), Accuracy (Acc.) were calculated. Area under the curve (AUC) was withdrawn from ROC curves, correlations[®] were determined.

Results: PLRT showed (r = 0.614, P 0.001, AUC 0.815, ACC. 75.0%, Sens. 85.0%, SP70.0%). SVV (r = 0.380, P 0.015, AUC 0.775, ACC 70.0%, Sens 79.0%, SP62.0%). PPV (r = 0.299, P 0.019, AUC 0.743, ACC 71.0%, Sens 77.0%, SP64.0%). IVC-DI (r = 0.405, P 0.009, AUC 0.693, ACC 54.0%, Sens 60.0%, SP50.0%). EEO (r = 0.170, P 0.09, AUC 0.61, ACC 52.0%, Sens 55.0%, SP50.0%). Δ VTI (r = 0.068, P 0.675, AUC 0.63, ACC 53.0%, Sens 58.0%, SP49.0%).

Conclusions: PICCO monitored PLR test is the most accurate and correlating tool for predicting fluid responsiveness in shocked mechanically ventilated patients, followed by SVV, PPV AND IVC-DI. On the other hand, EEO and Δ VTI were not significantly correlated.

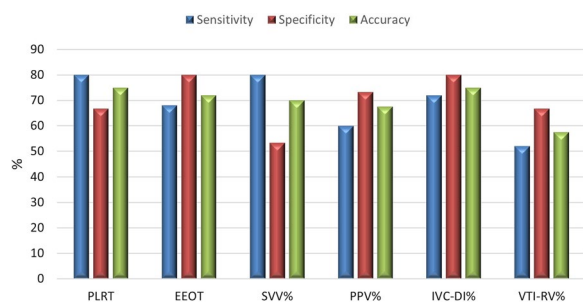

References

1. Monnet X, Teboul JL. Assessment of volume responsiveness during mechanical ventilation: recent advances. Crit Care. 2013;17:217-22. Seif D, Perera P, Mailhot T. Bedside ultrasound in resuscitation and therapid ultrasound in shock protocol. Crit Care Res Pract.2012;2012:503254. 3. Vincent JL, Rhodes A, Perel A, et al. Clinical review: Update on hemodynamic monitoring—a consensus of 16. Crit Care. 2011;15:229

Topic: Cardiovascular issues in ICU

000661

Impact of fever on the outcome of patients with acute brain injury: a systematic review and meta-analysis

M. Salvagno¹, T. Marta¹, M. Fiore¹, S. Fratio¹, F. Montanaro¹, C. Prezioso¹, F. S. Taccone¹, E. Bogossian¹
¹Soins intensifs, ULB Erasme, Anderlecht, Belgium

Correspondence: M. Salvagno
 Intensive Care Medicine Experimental 2023, 11(Suppl 1):000661

Introduction: Fever is a common condition in intensive care unit (ICU) patients, with an incidence between 30 and 50% in non-neurological ICU patients and up to 70–90% in neurological-ICU patients [1, 2]. It is known that fever has some potential protective functions [3]. Despite it, fever shows several detrimental effects, especially in patients with neurologic injuries, correlating with increased ICU mortality, longer ICU stay, and worse neurological outcomes [4–6].

Objectives: A systematic review and meta-analysis of current literature on the impact of fever on neurological outcomes and mortality of acute brain injury (ABI) patients (not including cardiac arrest patients).

Methods: We searched MEDLINE and SCOPUS following the recommendations of the Preferred Reporting Items for Systematic Reviews and Meta-Analyses (PRISMA) statement, and we included both retrospective and prospective observational studies, interventional studies, and randomized clinical trials that had data on body temperature during ICU admission and outcome (mortality, neurological outcome, stroke progression, neurological/radiological deterioration). There were no language restrictions. This study was registered in PROSPERO (CRD42020155903).

Results: 68 studies from 15.236 records identified after the initial search were included in the final analysis, for a total of 56.049 patients. The level of evidence in most studies was low to moderate. All studies had a low overall risk of bias. Fever/hyperthermia increased the chance of death (pooled OR 2.03 [95% CI 1.84–2.24], I2:93%), unfavorable neurological outcome (pooled OR 1.84 [95% CI 1.74–1.96], I2:86%), neurological deterioration (pooled OR 1.59 [95% CI 1.29–1.95], I2:78%) and risk of stroke progression/DCI (pooled OR 2.19 [95% CI 1.88–2.55], I2:57%).

Conclusions: Fever/Hyperthermia is associated with poor neurological outcomes and mortality in patients with acute brain injury. Normothermia should be targeted in the management of neuro critically ill patients.

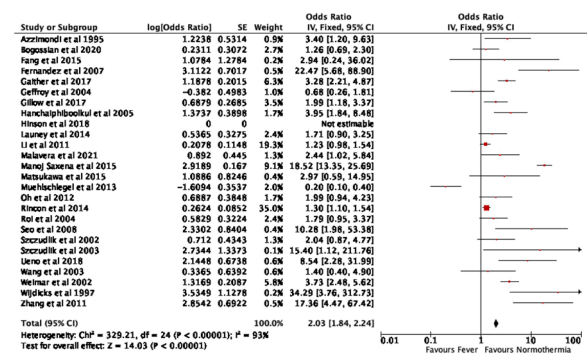

Fever and mortality
 Odds-ratio for fever or hyperthermia and mortality.

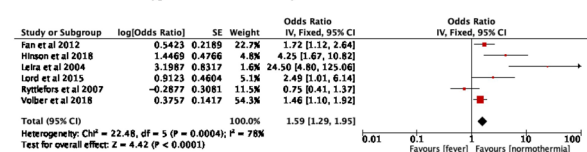

Neurological deterioration
 Odds-ratio for fever or hyperthermia and neurological deterioration.

Odds-ratio for fever or hyperthermia, and mortality or neurological deterioration.

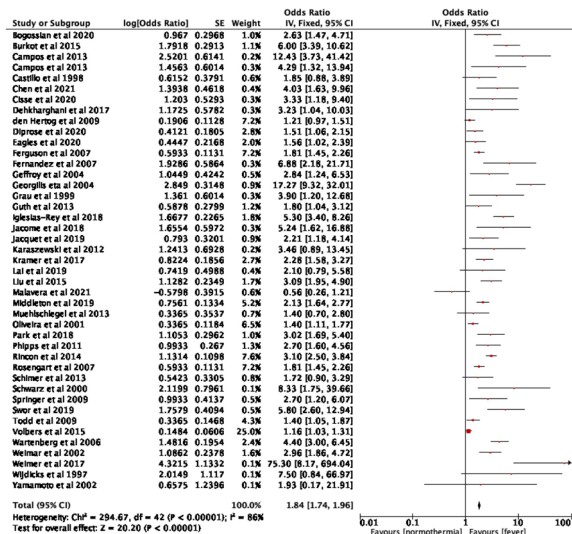

Fever and UO
Odds-ratio for fever or hyperthermia and unfavorable outcome.

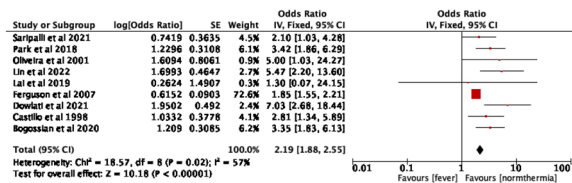

Stroke progression
Odds-ratio for fever or hyperthermia and stroke progression.

Odds-ratio for fever or hyperthermia, and unfavorable outcome or stroke progression.

References

- Stocchetti N, Rossi S, Zanier ER, Colombo A, Beretta L, Citerio G. Pyrexia in head-injured patients admitted to intensive care. *Intensive Care Med.* 2002;28(11):1555–1562. <https://doi.org/10.1007/s00134-002-1513-1>
- Diringier MN, Reaven NL, Funk SE, Uman GC. Elevated body temperature independently contributes to increased length of stay in neurologic intensive care unit patients. *Crit Care Med.* 2004;32(7):1489–1495. <https://doi.org/10.1097/01.CCM.0000129484.61912.84>
- Rossi S, Roncati Zanier E, Mauri I, Columbo A, Stocchetti N. Brain temperature, body core temperature, and intracranial pressure in acute cerebral damage. *J Neurol Neurosurg Psychiatry.* 2001;71(4):448–454. <https://doi.org/10.1136/JNPP.71.4.448>
- Oliveira-Filho J, Ezzeddine MA, Segal AZ, et al. Fever in subarachnoid hemorrhage: relationship to vasospasm and outcome. *Neurology.* 2001;56(10):1299–1304. <https://doi.org/10.1212/WNL.56.10.1299>
- Greer DM, Funk SE, Reaven NL, Ouzounelli M, Uman GC. Impact of Fever on Outcome in Patients With Stroke and Neurologic Injury A Comprehensive Meta-Analysis. Published online 2008. <https://doi.org/10.1161/STROKEAHA.108.521583>
- Su F, Nam DN, Wang Z, Cai Y, Rogiers P, Vincent JL. Fever control in septic shock: Beneficial or harmful? *Shock.* 2005;23(6):516–520. <https://doi.org/10.1097/01.SHK.0000161390.46688.DA>

Topic: Neurointensive care

000662

Changes in quality of life one year after intensive care; a multicenter prospective cohort study

L. Porter¹, K. Simons¹, S. Corsten², B. Westerhof³, T. Rettig⁴, E. Ewalds⁵, I. Janssen⁶, C. Jacobs⁷, S. Van Santen⁸, A. Slooter⁹, M. Van Der Woude¹⁰, J. G. Van Der Hoeven¹¹, M. Zegers¹¹, M. van den Boogaard¹¹

¹Intensive Care, Jeroen Bosch Hospital, s’Hertogenbosch, Netherlands; ²Intensive Care, Canisius Wilhelmina Hospital, Nijmegen, Netherlands; ³Intensive Care Medicine, Rijnstate Hospital, Arnhem, Netherlands; ⁴Department of Anesthesiology, Intensive Care and Pain Medicine, Amphia Hospital, Breda, Netherlands; ⁵Intensive Care, Bernhoven, Uden, Netherlands; ⁶Intensive Care Medicine, Maas Hospital Pantein, Boxmeer, Netherlands; ⁷Intensive Care, Elkerliek ziekenhuis, Helmond, Netherlands; ⁸Intensive Care, Munc+, Maastricht, Netherlands; ⁹Intensive Care, UMC Utrecht, Utrecht, Netherlands; ¹⁰Intensive Care, Zuyderland MC, Heerlen, Netherlands; ¹¹Intensive Care, Radboud University Medical Center, Nijmegen, Netherlands

Correspondence: L. Porter

Intensive Care Medicine Experimental 2023, 11(Suppl 1):000662

Introduction: ICU survivors’ quality of life (QoL) is generally lower than that of the general population. Additionally, with survival rates of critical illness increasing, patient reported outcomes, such as QoL, are becoming an important factor in decisions regarding ICU treatment. However, as most studies do not take pre-ICU QoL into account, it is unknown to what extent this reduced QoL is attributable to critical illness.

Objectives: To better understand the effects of critical illness on QoL, we explored QoL before and one year after ICU in different subgroups of ICU patients.

Methods: Data from an ongoing prospective multicenter cohort study, the MONITOR-IC, were used. Patients admitted to the ICU in one of the eleven participating hospitals between July 2016 and June 2021 were included. Patients completed questionnaires regarding their QoL before hospital admission and one year after ICU admission. Outcome was defined as change in QoL, measured using the EuroQol five-dimensional (EQ-5D-5L) questionnaire, and calculated by subtracting the EQ-5D-5L score at baseline from the EQ-5D-5L score one year after ICU. Based on the minimal clinically important difference, an improvement in QoL was defined as an increase in EQ-5D-5L score of ≥ 0.08 , a deterioration in QoL as a decrease of ≥ 0.08 , and an unchanged QoL as a delta EQ-5D-5L score < 0.08 . Patients were grouped by admission diagnosis, using the Acute Physiology and Chronic Health Evaluation (APACHE) IV diagnosis system, resulting in 6 main groups and 22 subgroups.

Results: 3913 (50.6%) of included patients completed both baseline and follow-up questionnaires. 25.2% (n = 989) of patients reported a deterioration in QoL one year after ICU admission, while 39.4% (n = 1540) reported an improvement, and 35.4% (n = 1384) returned to their pre-ICU QoL. After ICU admission due to trauma, 56.5% (n = 104) experienced a deterioration in QoL, while after cardiovascular surgery this was true for 19.7% (n = 289). The largest increase in QoL was seen in patients admitted due to respiratory disease (mean 0.17, SD 0.38), whereas the largest decrease in QoL was observed in trauma patients (mean -0.13, SD 0.28) (Table 1). The lowest QoL one year after ICU was observed in the group admitted due to obstructive pulmonary disease (EQ-5D-5L score 0.64, IQR 0.37–0.76). Notably, before hospital admission 92.3% (n = 36) of these patients experienced limitations in their daily activities. One year after ICU, this was true for 84.6% (n = 33) (Figure 1). In the total group, the most-affected dimension of the EQ-5D-5L was pain, with 61.3% (n = 2398) of patients reporting symptoms of pain before hospital admission, and 59.3% (n = 2320) one year after ICU admission.

Table 1 (abstract 000662) Changes in quality of life one year after ICU for 6 main groups of ICU patients, based on APACHE IV diagnosis

Admission diagnosis	EQ-5D-5L score before hospital admission Median (IQR)	EQ-5D-5L score 1 year after ICU admission Median (IQR)	P value*	Delta EQ-5D-5L score Mean (SD)
Cardio-vascular (n = 587)	0.82 (0.59–0.96)	0.82 (0.70–0.91)	< 0.01	0.07 (0.30)
Cardiovascular surgery (n = 1464)	0.83 (0.70–0.91)	0.86 (0.78–1.00)	< 0.001	0.07 (0.22)
Respiratory (n = 675)	0.68 (0.31–0.88)	0.81 (0.67–0.89)	< 0.001	0.17 (0.38)
Neurological (n = 186)	0.82 (0.55–0.91)	0.80 (0.62–0.89)	0.55	0.01 (0.36)
Trauma (n = 184)	1.00 (0.82–1.00)	0.82 (0.61–0.89)	< 0.001	-0.13 (0.28)
Other (n = 817)	0.81 (0.60–0.89)	0.82 (0.74–0.91)	< 0.001	0.08 (0.26)

*Comparison of EQ-5D-5L score before and 1 year after ICU, using wilcoxon signed rank test

Conclusions: One year after ICU, the majority of survivors returned to, or exceeded their pre-ICU QoL, while patients admitted after trauma experienced a significant decrease in QoL.

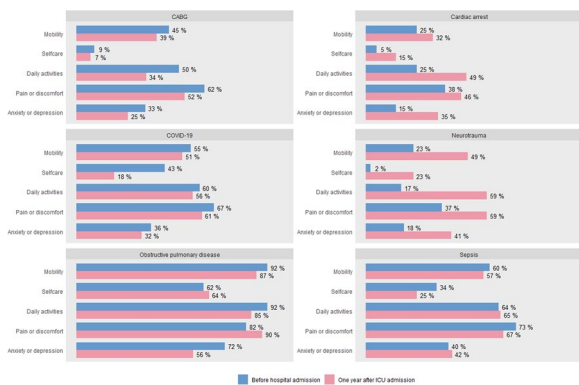

Figure 1 (abstract 000662) Percentage of patients reporting limitations in each dimension of the EQ-5D-5L, before hospital admission and one year after ICU admission for 6 subgroups of ICU patients

Topic: Critical care organisation, quality management, information systems, outcomes

000663

Survival of patients with sepsis secondary to soft tissue infection treated in an intensive care unit (ICU) of a regional hospital

L. Da Costa Llácer¹, L. M. Vasquez Candela², Z. Chova Sendra¹, J. L. Jiménez Ortiz¹, C. Pedrós Mas¹, E. Vendrell Torra¹, M. P. Garro¹, R. Iglesias Rodríguez¹

¹Intensive Care Medicine, Hospital General de Granollers, Granollers, Spain; ²General Surgery, Hospital General de Granollers, Granollers, Spain

Correspondence: L. Da Costa Llácer

Intensive Care Medicine Experimental 2023, 11(Suppl 1):000663

Introduction: Soft tissue infections result from microbial invasion of the skin and its supporting structures. Management depends on

severity of the infection and the patient’s comorbidities. Sepsis and multiple complications can be associated, requiring admission to ICU. Survival will depend on early identification and treatment, severity and response to treatment. Patients require empirical polymicrobial antibiotic coverage and surgical evaluation for possible debridement of the infection focus.

Objectives: To analyze the evolution and survival of patients with severe soft tissue infections that require admission to the ICU.

Methods: Retrospective observational study carried out in a regional hospital. Data have been obtained from the HGG ICU Admissions Database for 10 years period (2013–2022). All patients with severe soft tissue infection were included. Final cohort: 28 patients.

Results: The mean age was 66 years, 79% being male. Medium–high comorbidity (average Charlson of 3). Average GMA (adjusted morbidity group) of 3.7/5. High BMI was observed with mean of 28.8. Type of infection: 45% cellulitis, 24% fasciitis and 31% gangrene. 82% presented multi-organ dysfunction syndrome (MODS). In the fasciitis group 100% presented MODS, 89% in gangrene group and 63% in cellulitis group. Diagnosis and microorganism: blood cultures were performed in 100% of patients, these being negative in 71%. Cultures of the infectious focus were performed in 89.28% of the patients, 16% were negative. Among the positive cultures we found *E. coli* (28%), *S. aureus* (20%), *S. anginosus* (8%), *S. epidermidis* (8%). The patients took 3 days to consult since the start of symptoms. Diagnosis took an average of 15.7 h of delay since the emergency room visit. 64.28% of the patients required urgent surgery. Cellulitis group was the one with the least indication for surgery, indicated only in 18.2%, versus 87.5% and 100%, in the cases of fasciitis and gangrene. Once indicated, surgery took an average of 4:30 h to be performed. Mean hospital stay of 40 days (median 29.5 days). Mean ICU stay 14.75 days and post-ICU 24 days. Average Apache II on ICU admission: 16. Therapeutic measures used in ICU stay are shown in Table 2.

Table 2 (abstract 000663)

	VAS%	CRRT%	MV%	PRONE%	TRACHEO%
Cellulitis	90	45	55	0	27
Fasciitis	100	50	63	25	37
Gangrene	78	11	55	0	0
% Total	89	36	68	7	29

VAS: vasoactive support. CRRT: continuous renal replacement therapy. MV: mechanical ventilation. PRONE: prone position. TRACHEO: tracheostomy

32% of all patients died. Death rate in cellulitis group 45.5%, in fasciitis group 33% and finally 11% in gangrene group

Conclusions: Soft tissue infections can be life-threatening and remain a diagnostic and therapeutic challenge for clinicians. In many cases, they require multidisciplinary management involving intensive care providers, surgeons and infectious disease specialists. Early recognition is essential in order to start broad-spectrum empirical antibiotic treatment and perform debridement of the focus of infection as soon as possible.

Topic: Sepsis

000664

How to improve prediction models: boosting the accuracy of existing models by updating and extending

D. Meijs¹, L. Wynants², S. Van Kuijk³, C. Scheeren⁴, A. Hana⁵, J. Mehagnoul⁶, B. Stessel⁷, M. Vander Laenen⁸, E. G. M. Cox¹, J. W. Sels¹, L. Smits⁹, J. Bickenbach¹⁰, D. Mesotten¹¹, I. Van der Horst¹, G. Marx¹², B. C. Van Busse¹, C. Investigators¹

¹Intensive Care Medicine, UMC+, Maastricht, Netherlands; ²Epidemiology, Care and Public Health Research Institute, Maastricht, Netherlands;

³Clinical Epidemiology and Medical Technology Assessment, Maastricht University, Maastricht, Netherlands; ⁴Intensive Care Medicine, Zuyderland MC, Heerlen, Netherlands; ⁵Intensive Care Medicine, University Hospital of Zürich, Zürich, Switzerland; ⁶Intensive Care Medicine, VieCuri Medisch

Centrum, Venlo, Netherlands;⁷Anesthesiology and Intensive Care, Virga Jessa, Hasselt, Belgium; ⁸Department of Anesthesiology, Intensive Care Medicine, Emergency Medicine and Pain Medicine, Ziekenhuis Oost-Limburg, Genk, Belgium; ⁹Epidemiology, Care and Public Health Research Institute, Maastricht, Netherlands; ¹⁰Intensive Care Medicine, University Hospital RWTH Aachen, Aachen, Germany; ¹¹Department of Anesthesiology, Intensive Care and Pain Therapy, Ziekenhuis Oost-Limburg A. V., Genk, Belgium; ¹²Intensive Care, University Hospital RWTH Aachen, Aachen, Germany

Correspondence: D. Meijs

Intensive Care Medicine Experimental 2023, **11(Suppl 1)**:000664

Introduction: Most published prediction models for Coronavirus Disease 2019 (COVID-19) were poorly reported, at high risk of bias, and heterogeneous in model performance. Unreliable outcome predictions could cause more harm than support, discouraging the use of these models in clinical practice. We aimed to provide an approach how to tackle important methodological challenges faced in previous prediction studies, using the Intensive Care Unit (ICU) as a proxy, and to investigate whether this results in better mortality prediction.

Methods: The Euregio Intensive Care COVID cohort included COVID-19 patients admitted to seven ICUs in Belgium, Germany, and the Netherlands. The 4C Mortality and Spanish Society of Infectious Diseases and Clinical Microbiology (SEIMC) scores were selected as promising prognostic models from an external validation study. Five predictors could be estimated for updating and extending based on cohort size. We adhered to the transparent reporting of a multivariable prediction model for individual prognosis or diagnosis (TRIPOD) guideline. Logistic regression analyses with the linear predictor, Acute Physiology and Chronic Health Evaluation score, and country were performed with and without a restricted cubic spline (RCS) function. Bootstrapping with backward selection was applied to select variables for the final model, using a p-value of 0.1, and, together with multiple imputation in each bootstrap sample, to assess optimism. Model discrimination was displayed as optimism-corrected areas under the receiver operating characteristic curve and calibration by calibration slopes and plots. Shrinkage was performed using the optimism-corrected calibration slope.

Results: Between March 2 and August 12, 2020, 551 patients were included. The mortality rate was 36%. For the 4C Mortality score and the SEIMC score, discrimination after updating and extending increased from 0.70 to 0.74 and 0.70 to 0.73, respectively. Calibration plots improved compared to the original models.

Conclusions: Mortality prediction can be improved after updating and extending promising models. Instead of spending much time, effort, and money on developing new models, we show how to adapt available or future prediction models to a new target population and setting, resulting in more reliable and robust predictions for clinical decision-making.

References

- Riley RD, Ensor J, Snell KIE, Harrell FE Jr, Martin GP, Reitsma JB, et al. Calculating the sample size required for developing a clinical prediction model. *BMJ*. 2020;368:m441.
- Berenguer J, Borobia AM, Ryan P, Rodriguez-Bano J, Bellon JM, Jarrin I, et al. Development and validation of a prediction model for 30-day mortality in hospitalised patients with COVID-19: the COVID-19 SEIMC score. *Thorax*. 2021;76(9):920–929.
- Knight SR, Ho A, Pius R, Buchan I, Carson G, Drake TM, et al. Risk stratification of patients admitted to hospital with covid-19 using the ISARIC WHO Clinical Characterisation Protocol: development and validation of the 4C Mortality Score. *BMJ* 2020;370:m3339.
- Mesotten D, Meijs DAM, van Bussel BCT, Stessel B, Mehagnoul-Schipper J, Hana A, et al. Differences and Similarities Among COVID-19 Patients

Treated in Seven ICUs in Three Countries Within One Region: An Observational Cohort Study. *Crit Care Med*. 2022;50(4):595–606.

- Meijs DAM, van Kuijk SMJ, Wynants L, Stessel B, Mehagnoul-Schipper J, Hana A, et al. Predicting COVID-19 prognosis in the ICU remained challenging: external validation in a multinational regional cohort. *J Clin Epidemiol* 2022;152:257–68.
- Collins GS, Reitsma JB, Altman DG, Moons KG. Transparent Reporting of a multivariable prediction model for Individual Prognosis or Diagnosis (TRIPOD): the TRIPOD statement. *Ann Intern Med*. 2015;162(1):55–63.
- Moons KG, Kengne AP, Grobbee DE, Royston P, Vergouwe Y, Altman DG, et al. Risk prediction models: II. External validation, model updating, and impact assessment. *Heart*. 2012;98(9):691–8.
- De Jong VMT, Rousset RZ, Antonio-Villa NE, Buenen AG, Van Calster B, Bello-Chavolla OY et al. Clinical prediction models for mortality in patients with covid-19: external validation and individual participant data meta-analysis. *BMJ* 2022;378:e069881.
- Wynants L, Van Calster B, Collins GS, Riley RD, Heinze G, Schuit E, et al. Prediction models for diagnosis and prognosis of covid-19 infection: systematic review and critical appraisal. *BMJ*. 2020;369:m1328.
- Steyerberg EW. *Clinical prediction models: a practical approach to development, validation, and updating*. 2nd ed. Cham, Switzerland: Springer; 2019.
- This work was supported by the "Interreg Euregio Meuse-Rhine" [Covid Data Platform (CoDaP) grant: Interreg-EMR 187].

Topic: Critical care organisation, quality management, information systems, outcomes

000665

Equality of care—a review of patients with learning disabilities admitted to ICU

J. Donachie¹, E. Harlow¹, H. Butler¹, T. De Beer¹

¹Critical Care, Royal Cornwall Hospital, Truro, United Kingdom

Correspondence: J. Donachie

Intensive Care Medicine Experimental 2023, **11(Suppl 1)**:000665

Introduction: Learning disabilities (LD) affect 2.2% of adults in the UK (1). NICE defines an LD as “a significantly reduced ability to understand complex information (impaired intelligence); a reduced ability to cope independently (impaired social functioning); a condition which started before adulthood, and has a lasting effect” (2).

LDs are associated with poorer physical and mental health, and reduced life expectancy compared to those without (3, 4). Deaths from avoidable causes are more common in this group (49%) than in the general population (22%) (3). This can be propagated by impaired communication: 50–90% of LD patients have communication difficulties, resulting in ‘softer signs’ of acute illness and delayed recognition (5).

Patients with learning disabilities are at risk of delayed escalation to ICU, impairing their chance of survival and extending their length of stay. It is important to ensure LD patients are identified early and are adequately supported throughout their ICU admission.

Objectives: This project aims to audit current practices at a DGH ICU through review of quantitative data, and to develop a standard operating procedure to guide future practice and facilitate subsequent audit cycles. This study used NHS England’s LD improvement standards; LD guidance from The Royal College of Physicians; and GPICS standards of care to determine research parameters (5–7).

Methods: Patients with an LD admitted to ICU between April 2017–April 2022 were identified through central admissions software. A local ICU database provided quantitative data; these parameters were compared to the non-LD patients admitted to ICU over the same time period.

Results:

Table 1 (abstract 000665) Comparison of LD patients vs non-LD patients in ICU cohort

	LD n = 90	Non-LD n = 4384	Total n = 4474	Mann Whit- ney U
Time from hospital to ICU admission, days Median (IQR)	1 (0–2)	0 (0–1)	0 (0–1)	p 0.023
ICNARC score Median (IQR)	21 (14–27)	15 (10–22)	15 (10–23)	p < 0.001
LOS, days Median (IQR)	1.9 (0.7–4.7)	2 (1–4.3)	2 (1–4.3)	p 0.159
Unit mortality, n (%)	4 (4.4%)	529 (12.1%)	533 (11.9%)	
Time from ICU to hospital discharge, days Median (IQR)	4 (0–9)	4 (1–10)	4 (1–10)	p 0.437
Delay from request to discharge, minutes Median (IQR)	393 (199–657)	406 (175–668)	406 (175–667)	p 0.669

Conclusions: There was a statistically significant difference in the time from hospital to ICU admission and the median ICNARC score, though this did not translate into a significantly higher ICNARC predicted risk of death (p 0.368) nor longer length of stay. We plan to perform qualitative analysis of this dataset via manual review of electronic notes, focusing on whether LD was recognised by clinical teams and referred to the LD support team, and reasons for delayed admission to ICU. Involving the MDT and stakeholders, we will then develop a standard operating procedure to guide clinical management and facilitate reaudit in one year.

References

1. No grants were used or associated with this project.
2. 1. How Common Is Learning Disability In The UK? Mencap. Available from: <https://www.mencap.org.uk/learning-disability-explained/research-and-statistics/how-common-learning-disability>
3. 5. Acute care toolkit 16: Acute medical care for people with a learning disability | RCP London. Available from: <https://www.rcp.ac.uk/projects/outputs/acute-care-toolkit-16-acute-medical-care-people-learning-disability>
4. 6. NHS Improvement. The learning disability improvement standards for NHS trusts. 2018.
5. 7. Care Society, Faculty of Intensive Care Medicine. Guidelines for the provision of intensive care services, Version 2.1. 2022.
6. 2. The National Institute for Health and Care Excellence. NICE guideline 11. Challenging Behaviour and Learning Disabilities: Prevention and interventions for people with learning disabilities whose behaviour challenges. 2015. Available from: www.nice.org.uk/guidance/NG11
7. 3. Heslop P, Byrne V, Calkin R, Pollard J, Sullivan B, Daly P, et al. The Learning Disabilities Mortality Review (LeDeR) Programme, Annual Report 2020. Bristol; 2021.
8. 4. The National Institute for Health and Care Excellence. Mental health problems in people with learning disabilities: prevention, assessment and management. NICE guideline 54. NICE Guidelines. NICE; 2016.

Topic: Critical care organisation, quality management, information systems, outcomes

000666

Redefining SOFA categories to maximize predictive performance using Bayesian optimization—a pilot study

J. Helleberg¹, A. Sundelin², O. Rooyackers³, J. Mårtensson⁴

¹Perioperative Medicine and Intensive Care, Karolinska University Hospital, Stockholm, Sweden; ²Department of Physiology and Pharmacology, Section of Anesthesia and Intensive Care Medicine, Karolinska Institute, Stockholm, Sweden; ³Department of Clinical Science, Intervention and Technology, Karolinska Institute, Stockholm, Sweden; ⁴Department of Physiology and Pharmacology, Section of Anaesthesia and Intensive Care Medicine, Karolinska Institute, Stockholm, Sweden

Correspondence: A. Sundelin,

Intensive Care Medicine Experimental 2023, **11(Suppl 1)**:000666

Introduction: SOFA score has been in clinical use since the expert consensus 1996, but the standard of care in the ICU has improved significantly. Best practice of e.g., continuous renal replacement therapy and vasoactive support has changed. It is possible that the categories could be changed to better reflect the present. Such a revision could also be aimed to make SOFA score a better tool for measurement of illness severity. A data-driven approach based on large data sets could be of use in such work.

Objectives: To test whether Bayesian Optimization could be used to define cut-offs in the variables of the SOFA components that are both easy to remember, and maximize the ability of a modified SOFA score (mSOFA) to predict 30-day mortality.

Methods: An electronic algorithm was developed and validated to calculate SOFA score from variables extracted from a Patient Data Management System (PDMS). The algorithm aggregates values for GCS, Mean Arterial Pressure (MAP), PaO₂/FIO₂-index (PFI), Norepinephrine dose, Urine output, Creatinine, Bilirubin and Platelets according to the original SOFA score definition. Patients admitted to the ICU at the Karolinska University Hospital 2015–2018 were included in the study. The patients were split into a development cohort and a hold-out cohort. Bounds for cut-offs for each variable and category in a modified SOFA (mSOFA) were fed into a Bayesian optimization process which attempted to maximize the area under the ROC curve with maximum mSOFA score up to ICU day 7 as predictor and 30-day mortality as outcome. Five-fold cross-validation was used to define variable cutoffs. The process was halted when no improvement in ROC curve greater than 0.001 could be found. The predictive performance of the mSOFA score was compared to standard SOFA score in the holdout set, using Delong’s method for comparison of ROC curves.

Results: The Bayesian optimization procedure was terminated after 20 epochs due to lack of further improvement. In the holdout set, the AUC for standard SOFA score (highest during the first week) was 0.777 (95% CI: 0.7523–0.8032), the modified SOFA score had an AUC of 0.822 (95% CI: 0.7979–0.8462), p = 0.013 (Fig 1).

Table 1 (abstract 000666) Best performing scoring, mSOFA

Score	Central nervous system (GCS)	Coagulation (platelets 10 ⁹ /L)	Renal (creatinine μmole/L; urine output mL)	Hepatic (bilirubin μmole/L)	Circulation (MAP mmHg; norepinephrine μg/kg/min)	Respiratory (PFI kPa)
1	< 9	< 40	> 150 or < 2000	> 170	< 55 or > 0.23	< 60
2	< 8	< 30	> 300 or < 1500	> 340	< 50 or > 0.46	< 45

Score	Central nervous system (GCS)	Coagulation (platelets $10^9/L$)	Renal (creatinine $\mu\text{mole/L}$; urine output mL)	Hepatic (bilirubin $\mu\text{mole/L}$)	Circulation (MAP mmHg; norepinephrine $\mu\text{g/kg/min}$)	Respiratory (PFI kPa)
3	<7	<20	>450 or <1000	>510	<45 or >0.69	<30
4	<6	<10	>600 or <500	>680	<40 or >0.92	<1

Conclusions: This study shows that SOFA score could be redefined, using the same variables and number of categories, to retain its human interpretable quality and simple arithmetic, but with better correlation with higher score to mortality. Any such undertaking should involve both expert consensus and data-driven methods using large data sets to best capture the standard of care in the ICU in the 2020s.

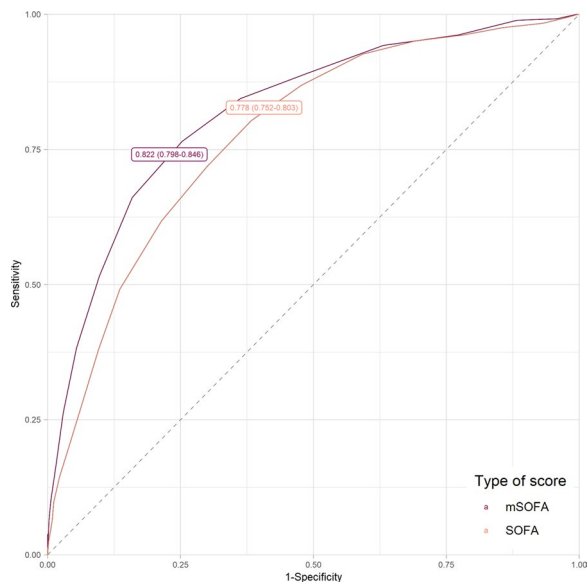

Figure 1 (abstract 000666) Mortality prediction, comparing SOFA and mSOFA AUC

References

- DeLong ER, DeLong DM, Clarke-Pearson DL. Comparing the areas under two or more correlated receiver operating characteristic curves: a non-parametric approach. *Biometrics*. 1988;837-845.
- Shahriari B, Swersky K, Wang Z, Adams RP, Freitas Nd. Taking the Human Out of the Loop: A Review of Bayesian Optimization. *Proceedings of the IEEE*. 2016;104(1):148-175. <https://doi.org/10.1109/JPROC.2015.2494218>
- Lambden S, Laterre PF, Levy MM, Francois B. The SOFA score-development, utility and challenges of accurate assessment in clinical trials. *Crit Care*. Nov 2019;23(1):374. <https://doi.org/10.1186/s13054-019-2663-7>
- Vincent JL, Moreno R, Takala J, et al. The SOFA (Sepsis-related Organ Failure Assessment) score to describe organ dysfunction/failure. On behalf of the Working Group on Sepsis-Related Problems of the European Society of Intensive Care Medicine. *Intensive Care Med*. Jul 1996;22(7):707-10. <https://doi.org/10.1007/BF01709751>

Topic: Data Science

000667

Plasma transfusion and procoagulant product administration in extracorporeal membrane oxygenation—a secondary analysis of an international observational study on current practices

M. van Haeren¹, J. Raasveld¹, D. Dos Reis Miranda², D. Dauwe³, F. Pappalardo⁴, W. M. van den Bergh⁵, A. Oude Lansink-Hartgring⁵, J. J. Maas⁶, P. Van De Berg⁷, D. W. Donker⁸, C. L. Meuwese², F. S. Taccone⁹, R. Lorusso¹⁰, E. Scholten¹¹, V. Ivancan¹², R. Bojčić¹², J. De Metz¹³, M. De Bakker¹⁴, B. Reddi¹⁴, G. Hermans¹⁵, L. M. Broman¹⁶, J. P. S. Henriques¹⁷, J. Schenk¹⁸, A. P. J. Vlaar¹, M. C. A. Müller¹

¹Department of Critical Care, Amsterdam UMC, locatie AMC, Amsterdam, Netherlands; ²Adult Intensive Care Unit, Erasmus University Medical Center, Rotterdam, Netherlands; ³Department of Intensive Care Medicine, Surgical Intensive Care Unit, UZ Leuven, Leuven, Belgium; ⁴Department of Cardiothoracic and Vascular Anesthesia and Intensive Care, Ospedale Civile Ss. Antonio e Biagio e Cesare Arrigo, Alessandria, Italy; ⁵Department of Critical Care, University Medical Center Groningen, Groningen, Netherlands; ⁶Adult Intensive Care Unit, Leiden University Medical Center (LUMC), Leiden, Netherlands; ⁷Adult Intensive Care Unit, Catharina Ziekenhuis, Eindhoven, Netherlands; ⁸Intensive Care Center, UMC Utrecht, Utrecht, Netherlands; ⁹Department of Intensive Care, Hospital Erasme, Bruxelles, Belgium; ¹⁰Department of Intensive Care, UMC+, Maastricht, Netherlands; ¹¹Department of Intensive Care, St. Antonius Hospital, Nieuwegein, Netherlands; ¹²Department of Anesthesia and Intensive Care, University Hospital Centre Zagreb, Zagreb, Croatia; ¹³Department of Intensive Care, OLVG, location East, Amsterdam, Netherlands; ¹⁴Department of Critical Care, Royal Adelaide Hospital, Adelaide, Australia; ¹⁵Department of General Internal Medicine, University Hospitals Leuven & Laboratory of Intensive C, Katholieke Universiteit Leuven, Leuven, Belgium; ¹⁶ECMO Centre Karolinska, Karolinska Institute, Stockholm, Sweden; ¹⁷Department of Cardiology, Amsterdam UMC, locatie AMC, Amsterdam, Netherlands; ¹⁸Department of Epidemiology and Data Science, Amsterdam UMC, locatie AMC, Amsterdam, Netherlands

Correspondence: M. van Haeren

Intensive Care Medicine Experimental 2023, **11(Suppl 1)**:000667

Introduction: To achieve optimal hemostatic balance in patients on extracorporeal membrane oxygenation (ECMO), a liberal transfusion practice is currently applied despite clear evidence.

Objectives: We aimed to give an overview of the current use of plasma, fibrinogen concentrate, tranexamic acid (TXA) and prothrombin complex concentrate (PCC) in patients on ECMO.

Methods: This was a prespecified subanalysis of an international, multicenter (16 intensive cares) retrospective study. Venovenous (VV) and venoarterial (VA) ECMO are analyzed as separate populations, comparing patients with and without bleeding and with and without thrombotic complications.

Results: Of 420 VA ECMO patients, 59% (n = 247) received plasma, 20% (n = 82) fibrinogen concentrate, 17% (n = 70) TXA and 7% (n = 28) PCC. Fifty percent (n = 208) suffered bleeding complications, 27% (n = 112) thrombotic complications. More patients with than without bleeding complications received plasma (77% vs. 41%, p < 0.001), fibrinogen concentrate (28% vs. 11%, p < 0.001) and TXA (23% vs. 10%, p < 0.001). More patients with than without thrombotic complications received TXA (24% vs. 14%, p = 0.02, OR 1.75) in VA ECMO, where no difference was seen in VV ECMO. Of 205 VV ECMO patients, 40% (n = 81) received plasma, 6% (n = 12) fibrinogen concentrate, 7% (n = 14) TXA and 5% (n = 10) PCC. Thirty-nine percent (n = 80) of VV ECMO patients suffered bleeding complications, 23% (n = 48) thrombotic complications. More patients with than without bleeding complications received plasma (58% vs 28%, p < 0.001), fibrinogen concentrate (13% vs 2%, p < 0.01) and TXA (11% vs 2%, p < 0.01). Of the plasma transfusions in ECMO patients without bleeding complications, 89% (VV ECMO) to 90% (VA ECMO) was transfused with an INR below 3.0.

Conclusions: The majority of patients on ECMO receive transfusions of plasma, procoagulant products or antifibrinolytics. In a significant part of the plasma transfused patients, this was in the absence of bleeding

or prolonged INR. This poses the question if these plasma transfusions were administered for another indication or could have been avoided.

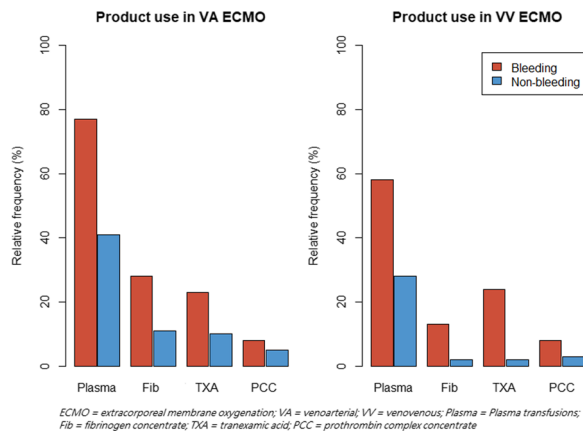

Plasma transfusion, fibrinogen concentrate, tranexamic acid and prothrombin complex use in extracorporeal membrane oxygenation (ECMO). ECMO = extracorporeal membrane oxygenation; VA = venoarterial; vv = venovenous; Plasma = Plasma transfusions; fib = fibrinogen concentrate; TXA = tranexamic acid; PCC = prothrombin complex concentrate

Topic: Transfusion and haemostasis disorders

000668

Pursuing the real midazolam clearance during continuous renal replacement therapy in ICU patients with COVID-19: are midazolam and metabolites dialyzable?

T. Smeets¹, H. de Geus², A. Valkenburg³, B. Koch¹, D. Gommers⁴, H. E. Endeman⁵, N. Hunfeld⁶

¹Hospital Pharmacy, Erasmus University Medical Center, Rotterdam, Netherlands; ²Intensive Care Adults, Erasmus University Medical Center, Rotterdam, Netherlands; ³Anesthesiology and Intensive Care, Isala Zwolle, Zwolle, Netherlands; ⁴Department of intensive care, Erasmus MC, Rotterdam, Netherlands; ⁵Intensive care, Erasmus University Medical Center, Rotterdam, Netherlands; ⁶Intensive care, Erasmus MC, Rotterdam, Netherlands

Correspondence: T. Smeets

Intensive Care Medicine Experimental 2023, **11(Suppl 1)**:000668.

Introduction: Midazolam based continuous intravenous (iv) sedation in patients admitted to the intensive care became prominent during the COVID-19 pandemic. However, benzodiazepine based sedation is associated with a high incidence of benzodiazepine-related delirium and an increased number of days spent in coma. Given the high midazolam dose requirements and the impaired renal clearance (CL) of the active (10% potency compared to midazolam) metabolite 1-OH-midazolam-glucuronide, ICU patients with COVID-19 and continuous renal replacement therapy (CRRT) may be at risk of prolonged sedation. Several factors like CRRT modality, downtime and filter patency may influence and determine the delivered clearance of midazolam and its metabolites.

Objectives: The aim of the case serie was to study CRRT related factors that could influence the CL of midazolam and metabolites in critically ill COVID-19 patients with CRRT.

Methods: Pre-filter blood samples and ultrafiltrate samples were collected simultaneously. Midazolam, 1-OH-midazolam and 1-OH-midazolam-glucuronide plasma samples were analyzed by means of a validated UPLC-MS/MS method. The prescribed renal dose was corrected for downtime therapy and filter integrity by means of a filter urea ratio. CL of midazolam and metabolites were calculated by the delivered renal dose and saturation (Sd) coefficient.

Results: We included 3 patients with CVVHD and 2 patients with CVVHDF (see Table1). The delivered renal dose ranged from 10.3 mL/kg/h to 33.3 mL/kg/h and the corrected delivered renal dose ranged from 8.8 mL/kg/h to 29.3 mL/kg/h. The urea ratios were in 4 patients >0.80 and in 1 patient <0.80. Midazolam, 1-OH-midazolam and 1-OH-midazolam-glucuronide concentrations ranged from below of quantification to 6070 µg/L, below of quantification to 295 µg/L and 1727 to 39,000 µg/L, respectively. Sd ranged from 0.02 to 0.03 for midazolam, 0.05–0.06 for 1-OH-midazolam and 0.23–0.43 for 1-OH-midazolam-glucuronide. The CL by the delivered renal dose was 0 mL/min to 1.7 mL/min for midazolam, 0 mL/min to 3.5 mL/min for 1-OH-midazolam and 4.0–27.7 mL/min for 1-OH-midazolam-glucuronide.

Conclusions: Midazolam and 1-OH-midazolam are not removed efficiently by CRRT and 1-OH-midazolam-glucuronide approximately up to 43%. Type of CRRT, filter integrity and downtime of CRRT affect the CL of midazolam and metabolites. Our results have implications for more personalized titration of midazolam in COVID-19 patients with CRRT, mainly to avoid oversedation.

Table 1 (abstract 000668) Patient characteristics and clinical data of midazolam and CRRT therapy

	Patient 1	Patient 2	Patient 3	Patient 4	Patient 5
Demographics					
Gender	M	M	M	F	M
Age (years)	34	72	64	62	75
Weight (kg)	121	85	150	80	89
SOFA Score from date sampling day midazolam	10	16	9	5	10
CRRT					
Type of CRRT	CVVHDF-CiCa	CVVHD-CiCa	CVVHDF-CiCa	CVVHD-CiCa	CVVHD-CiCa
Type of filter	Ultraflux AV1000s	Ultraflux AV1000s	Ultraflux AV1000s	Ultraflux AV1000s	Ultraflux AV1000s
Blood flow rate (mL/min)	140	130	160	110	130
Dialysate flow rate (mL/h)	2800	2600	3200	2200	2600
Substitution (mL/h)	1400	n.a.	1600	n.a.	n.a.
Prescribed renal dose (mL/kg/h)	34.7	30.6	32	27.5	29.2
Delivered renal dose (mL/kg/h)	33.3	29.3	30.7	10.3	29.2
Corrected delivered renal dose (mL/kg/h)	17.6	29.3	28.2	8.8	28.3
Urea ratio	0.53	1.0	0.92	0.85	0.97
Midazolam					
Infusion rate (mg/h)	20	10	25	0	30
Dose (mg/kg/h)	0.14	0.12	0.17	n.a.	0.34
Plasma concentration (µg/L)					
Midazolam	3650	1016	660	n.a.	6070
1-OH-midazolam	97	178	43	n.a.	295
1-OH-midazolam-glucuronide	39000	37490	21630	1727	36640
Total sum	7627	4907	2857	173	9970
Sd					
Midazolam	0.02	0.03	0.02	n.a.	0.03
1-OH-midazolam	0.05	0.06	n.a.	n.a.	0.05
1-OH-midazolam-glucuronide	0.23	0.43	0.36	0.29	0.32
Midazolam CL by (mL/min)					
Prescribed renal dose	1.7	1.3	1.7	n.a.	1.1
Delivered renal dose	1.7	1.2	1.6	n.a.	1.1
1-OH-Midazolam CL by (mL/min)					
Prescribed renal dose	3.6	2.4	n.a.	n.a.	2.2
Delivered renal dose	3.5	2.3	n.a.	n.a.	2.2
1-OH-Midazolam-glucuronide CL by (mL/min)					
Prescribed renal dose	15.8	18.5	28.9	10.7	14.1
Delivered renal dose	15.1	17.7	27.7	4.0	14.1

All renal doses and associated calculated clearance are over the last 24 h. CiCa, calcium citrate; CL, clearance; CRRT, continuous renal replacement therapy; CVVHD, continuous venovenous hemodialysis; CVVHDF, continuous venovenous hemodiafiltration; Sd, saturation coefficient; SOFA score, sequential organ failure assessment score

Topic: Acute Kidney Injury and haemofiltration

000669

Extubation failure and tracheostomy in critically ill patients with severe COVID-19 pneumonia

T. Schizodimos¹, G. Katsikaki¹, G. Gogos¹, E. Kerezidou¹, E. Brasinika¹, D. Ntontos¹, C. Iasonidou¹

¹B ICU, General Hospital "G. Papanikolaou", Thessaloniki, Greece

Correspondence: T. Schizodimos

Intensive Care Medicine Experimental 2023, **11(Suppl 1)**:000669

Introduction: Severe COVID-19 pneumonia is associated with significant morbidity and mortality and often requires intubation and invasive mechanical ventilation (MV). Weaning from MV is a difficult issue in this patient population, leading to extubation failure and/or tracheostomy. This contributes significantly to the prolonged ICU stay with its known negative effects.

Objectives: To investigate the incidence and consequences of successful and failed extubation and tracheostomy in ICU patients with COVID-19 pneumonia.

Methods: A retrospective observational study was performed in a Greek ICU from April 2021 to November 2021. We collected data from a total of 55 critically ill patients with severe laboratory-confirmed COVID-19 pneumonia. We excluded 19 patients who died without extubation attempt or direct tracheostomy. Demographic and baseline data, MV parameters and laboratory results, and sedation management data were collected at day 1, 3 and 7 after ICU admission. We also recorded all data from the day of extubation, re-intubation, or tracheostomy, general in-ICU events such as ventilator-associated pneumonia (VAP) and tracheobronchitis (VAT), and in-ICU, in-hospital, 28-day, 3-month, and 6-month mortality.

Results: Included 36 patients were males in 58.3%, had a mean age of 59.8 (SD ± 9.4) years, mean CCI 1.8 (SD ± 1.3) (arterial hypertension in 52.8%), mean APACHE II score 13.7 (SD ± 3.8) and mean LIS score 2.95 (SD ± 0.37). 17 (47.2%) patients underwent an extubation attempt on average day 10. Among them, 2 (11.8%) extubation failures were recorded with respiratory failure as the main cause. Patients with extubation failure displayed a longer length of ICU stay (39 vs 13 days), a longer MV duration (29 vs 10 days) and a higher in-ICU (50% vs 0%), in-hospital (50% vs 20%), 28-day (50% vs 13.3%), 3-month (50% vs 20%), and 6-month (50% vs 20%) mortality rate compared to patients with successful extubation (Figure 1). 19 (52.8%) patients underwent tracheostomy without extubation attempt on average day 14 with expected long duration of MV as the main cause. Patients with direct tracheostomy (mean APACHE II score 13.9 ± 3.8, LIS score > 2.5) displayed a longer length of ICU stay (31 vs 16 days), a longer MV duration (27 vs 12 days) and a higher in-ICU (47.4% vs 5.9%), in-hospital (47.4% vs 23.5%), 28-day (47.4% vs 17.6%), 3-month (52.6% vs 23.5%), and 6-month (52.6% vs 23.5%) mortality rate than patients with an extubation attempt (success and failure) (mean APACHE II score 13.5 ± 3.9, LIS score > 2.5). Patients with direct tracheostomy experienced more VAP (68.4% vs 23.5%) and VAT (10.5% vs 5.9%) events compared to patients with an extubation attempt (Figure 2).

Conclusions: In critically ill patients with severe COVID-19 pneumonia, extubation failure (11.8%) was found to be similar to the general ICU population (10.4%) according to current literature. Extubation failure and direct tracheostomy are associated with unfavorable outcomes.

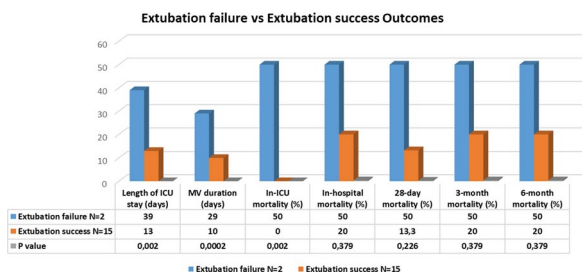

Figure 1 (abstract 000669) Extubation failure vs extubation success outcomes

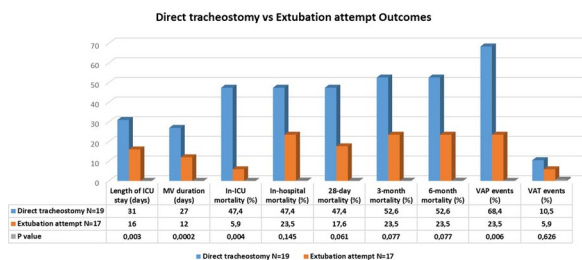

Figure 2 (abstract 000669) Direct tracheostomy vs extubation attempt outcomes

References

1. Jaber S, Quintard H, Cinotti R, et al. Risk factors and outcomes for airway failure versus non-airway failure in the intensive care unit: a multicenter observational study of 1514 extubation procedures. Crit Care. 2018;22(1):236.
2. Ionescu F, Zimmer MS, Petrescu I, et al. Extubation Failure in Critically Ill COVID-19 Patients: Risk Factors and Impact on In-Hospital Mortality. J Intensive Care Med. 2021;36(9):1018–1024.
3. None

Topic: Infections and prevention

000670

Resource consumption in a contemporary cohort of patients requiring ICU admission with documented SARS-CoV-2 infection

N. Guimarães¹, P. Silveira², J. M. Ribeiro³, P. Povoas⁴, F. Esteves⁵, D. Nuñez⁶, L. Bento⁷, J. A. Paiva⁸, I. Milet⁹, A. Fernandes¹⁰, M. Henriques¹¹, P. Martins¹², P. T. Freitas¹³, F. Froes¹⁴, J. Gonçalves-Pereira¹⁵, P. Mergulhão¹⁶, I. Eira¹⁷, R. Cardoso¹⁸, D. Bento¹⁹, R. N. Junior²⁰, J. Cepeda⁹, R. Gomes¹⁰, M. S. Santos²¹, R. Freitas²², J. Nogueira¹³

¹SCI-1, CHUdSA, Porto, Portugal; ²Medicina Intensiva, Braga Public Hospital, Braga, Portugal; ³Serviço de medicina intensiva, Centro Hospitalar Universitário Lisboa Norte, Lisbon, Portugal; ⁴Polyvalent Intensive Care Unit, São Francisco Xavier Hospital, CHLO, Lisbon, Portugal; ⁵Intensive Medicine, Centro Hospitalar De Trás-Os-Montes E Alto Douro, E.P.E., Vila Real, Portugal; ⁶Intensive care unit, Centro Hospitalar Universitário do Algarve - Faro, Faro, Portugal; ⁷Unidade de urgência medica (uum), Centro Hospitalar Universitário de Lisboa Central - Hospital de São José, Lisboa, Portugal; ⁸Intensive Care, São João University Hospital Center, Porto, Portugal; ⁹Medicina intensiva, Centro Hospitalar Vila Nova de Gaia/Espinho - Unit 1, Vila Nova de Gaia, Portugal; ¹⁰Serviço de medicina intensiva, Hospital Garcia de Orta, Almada, Portugal; ¹¹Intensive care, Hospital do Divino Espírito Santo, Ponta Delgada, Portugal; ¹²Intensive care medicine service, Hospitalar and University Center of Coimbra, Coimbra, Portugal; ¹³SMI, Hospital Fernando Fonseca, Amadora, Portugal; ¹⁴Intensive Care Unit, Hospital Pulido Valente, Centro Hospitalar Lisboa Norte, Lisboa, Portugal; ¹⁵Intensive Care Unit, Hospital de Vila Franca de Xira, Vila Franca de Xira, Portugal; ¹⁶Intensive Care Department, Hospital Lusíadas Porto, Porto, Portugal; ¹⁷SMI, Braga Public Hospital, Braga, Portugal; ¹⁸Ucic, Hospital de São Francisco Xavier, Lisboa, Portugal; ¹⁹Serviço de medicina intensiva, Centro Hospitalar de Trás-os-Montes e Alto Douro, Vila Real, Portugal; ²⁰Unidade de urgência medica (uum), Centro Hospitalar Universitário de Lisboa Central - Hospital de São José, Lisbon, Portugal; ²¹Critical Care, HDES, Ponta Delgada, Portugal; ²²Department of Intensive Care, Centro Hospitalar e Universitário de Coimbra, Coimbra, Portugal

Correspondence: N. Guimarães

Intensive Care Medicine Experimental 2023, 11(Suppl 1):000670

Introduction: COVID is likely to become endemic in several regions. Europe has vaccinated a large proportion of its citizens, and effective preventive and therapeutic interventions for earlier disease stages are becoming available (1–5) it is important to assess the resource consumption associated with COVID-19 infection, and factors that may influence it.

Objectives: To compare resources used to care for patients requiring ICU admission with SARS-CoV-2 infection and stratified by disease severity (ie: severe or critical COVID-19 vs nonsevere disease).

Methods: Retrospective chart review of all patients requiring ICU admission with with PCR-proven SARS-CoV-2 infection between February, 1 and April, 30, 2022 with follow-up until hospital discharge, in 11 Portuguese hospitals.

Results: 305 patients were recorded. 194 (63.6%) had severe or critical COVID-19 (S/C) and 111 had non-severe (NS) disease and were admitted due to other conditions. ICU LOS in S/C patients was more than double that of NS (13.7 vs 6.6 days); hospital LOS was also longer (27.8 vs 17.9 days). Data on ventilatory support is presented in Table 1.

Table 1 (abstract 000670) .

	HFNO use n (%)	Duration of HFNO—days (AVG; range)	NIV use n (%)	Duration of NIV—days (AVG; range)	IMV n (%)	IMV duration days (AVG; range)
Global (n = 278*) * Data missing in 27	118 (42.4)	4.84 [0–36]	108 (38.8)	4.93 [1–36]	114 (41.0)	15; [1–61]
Covid S/C (n = 194)	105 (54.1)	5.03 (n = 105) [0.5–36]	94 (48.6)	4.90 (n = 94) [1–36]	91 (46.9)	16.28 (n = 90) [1–61]
Covid NS (n = 84)	13 (15.5)	3.0 (n = 13) [1–10]	14 (16.7)	5.0 (n = 14) [1–27]	23 (27.4)	9.68 (n = 22) [1–35]

Of 83 S/C patients submitted to iMV, with known vaccination status, 26 (31,3%) were non-vaccinated (NV) and without prior SARS-CoV-2 infection. Duration of MV was similar in both groups: NV 17,88 days vs 16,77 days.

Prone positioning was used in 77 patients. Of these 75 were in the S/C group and 71% were vaccinated.

28/277 patients received renal replacement therapy. Of these 24 (20 previously vaccinated) were in the S/C group and duration of treatment was longer in this group (13,5 vs 6 days). Ten patients received VV-ECMO, 8 in the S/C group (6 unvaccinated), for an average of 23 days.

Tracheostomies were done in 21 patients of whom 17 were critical COVID-19 cases.

A first episode of ICU-acquired infection occurred in 98 patients, of which 84 (85.7%) were in the S/C group. The most frequent foci were respiratory (n = 67) and urinary (n = 17). 40 had positive blood cultures (34 in C/S group).

Overall hospital mortality was 28.5% (37.1 in S/C vs 17.9 in NS); survivors were discharged to home in 72% of cases (equal in SC and NS pts).

Conclusions: With ~90% of the Portuguese population vaccinated, roughly two thirds of patients admitted to intensive care with documented SARS-CoV-2 infection still had severe disease. Resource consumption is significant with S/C patients more frequently requiring respiratory support and prone positioning. Duration of invasive mechanical ventilation was markedly prolonged. Extracorporeal organ support also appeared to be used more often although the numbers are quite small.

The high resource consumption may be, in part, driven by a higher incidence of nosocomial infection.

References

1. This work was supported by an unrestricted grant by AstraZeneca

Topic: Infections and prevention

000672

Flow versus pressure-controlled ventilation (FCV vs PCV) in postoperative cardiothoracic surgery patients on the ICU; a physiological prospective pilot study

J. P. van Oosten¹, H. E. Endeman¹, D. Gommers¹, A. Jonkman¹

¹Department of Intensive Care, Erasmus University Medical Center, Rotterdam, Netherlands

Correspondence: J. P. van Oosten

Intensive Care Medicine Experimental 2023, **11(Suppl 1)**:000672

Introduction: The mechanical power (MP) unifies variables known to be related to the development of ventilator-induced lung injury (VILI) and is independently associated with ICU mortality [1]. Flow controlled ventilation (FCV) is a ventilation mode that uses a constant flow during both in- and expiration [2]. In a mathematical model the dissipated energy during FCV was lower compared to standard modes of controlled mechanical ventilation (CMV; being VCV and PCV) [3]. So far only Grassetto and colleagues compared the MP between CMV modes and FCV in ICU patients, however these results are hard to interpret since airway pressures were measured at different levels (the valve in CMV and

intratracheal in FCV) [4]. Therefore, we conducted a physiological pilot study comparing FCV and PCV in patients requiring CMV at the ICU, whereby all airway pressures and flows were measured intratracheally.

Objectives: To assess the difference in MP and dissipated energy between FCV and PCV.

Methods: Post-cardiothoracic surgery patients requiring CMV in the ICU were enrolled. Intratracheal pressure and flow were measured continuously using dedicated equipment (BIOPAC Systems, Inc.) and stored for offline analysis. Patients were ventilated on PCV (t=0) and then switched to FCV at the same PEEP and FiO₂ while Ppeak and flow of the FCV were optimized aiming for a stable tidal volume and ET/CO₂. After 30 min, FCV was further optimized in terms of driving pressure aiming for the highest dynamic compliance (not exceeding tidal volumes of 10 ml/kg IBW) and continued for 90 min. Arterial blood gases were collected at start and then every 30 min. The MP, comprised of the resistive and elastic dynamic work but not static elastic work (Fig 1), and the dissipated energy (area within P-V loop) were calculated breath-by-breath for an 8-min stable period at t=0 (PCV) and t=90 (optimized FCV). Average values were compared using the paired-samples t-test or the Wilcoxon matched-pair signed-rank test (for not normally distributed data).

Results: 10 patients were included (7 males; age 66y (IQR 63–68); BMI 30.5 kg/m² (IQR 27.5–34.8)). Figure 1 shows a representative P-V loop with corresponding calculations. FCV resulted in a lower MP and dissipated energy while the minute volume (MV) decreased but the PaCO₂ and P/F ratio remained stable (Table 1).

Table 1 (abstract 000672) .

Variables	PCV (t = 0m) Median (IQR)	FCV (t = 90m) Median (IQR)	P-value
MV (L/min)	8.0 (6.5–8.4)	4.8 (4.3–7.2)	0.005
PaCO ₂ (kPa)	5.4 (5.1–6.2)	5.3 (5.1–5.9)	0.264
P/F ratio	324 (240–365)	300 (273–369)	0.683
MP (J/min)	11.0 (8.4–12.8)	7.6 (5.7–11.4)	0.013
Dissipated energy (J/L)	0.34 (0.21–0.43)	0.20 (0.16–0.27)	0.003

Conclusions: FCV resulted in a significantly lower MP and dissipated energy compared to PCV with a lower MV but a stable gas exchange.

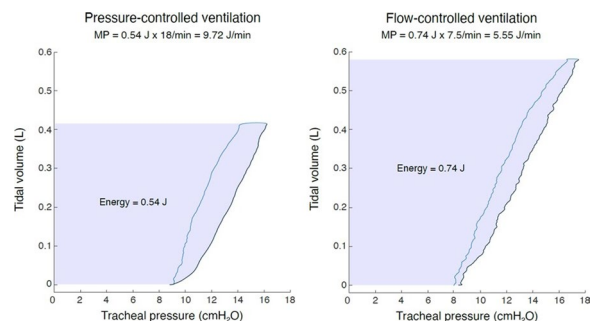

Figure 1 (abstract 000672) A representative P-V loop with corresponding MP calculations during PCV and FCV

References

1. 4. Grassetto A., Pettenuzzo T., Badii F., Carlon R., Sella N. and Navalesi P. Flow-controlled ventilation may reduce mechanical power and increase ventilatory efficiency in severe coronavirus disease-19 acute respiratory distress syndrome. *Pulmonology* 2023, **29(2)**: 154–156.
2. 3. Barnes TE, van Asseldonk D, and Enk D: Minimisation of dissipated energy in the airways during mechanical ventilation by using constant inspiratory and expiratory flows—Flow-controlled ventilation (FCV). *Med Hypotheses* 2018, **121**:167–176.

3. 2. Barnes TE, and Enk D.: Ventilation for low dissipated energy achieved using flow control during both inspiration and expiration. Trends in Anaesthesia and Critical Care 2018, 1(1): 1–8.
4. 1. Serpa Neto A., Deliberato RO., Johnson AEW., et al. Mechanical power of ventilation is associated with mortality in critically ill patients: an analysis of patients in two observational cohorts. Intensive Care Med 2018, 44: 1914–1922.
5. This work has been supported by Ventinova Medical B.V. and the European Union Horizon 2020 research and innovation program under grant agreement number 961787.

Topic: Acute respiratory failure and mechanical ventilation

000673

Impact of early rehabilitation of the functional quality of life of the critically ill SARS-CoV2 positive patients at one year—a propensity score study

A. A. Rodríguez¹, B. Lobo Valbuena¹, M. C. L.², A. A.², R. Molina, B. P.², J. J.², R. Castañeda Vozmediano³, F. Gordo Vidal¹

¹Intensive Care Unit, H. U del Henares, Madrid, Spain; ²Rehabilitation and Physiotherapy Unit, H. U del Henares, Madrid, Spain; ³Research Group on Critical Pathology, Faculty of Health Sciences, Universidad Francisco de Vitoria, Madrid, Spain

Correspondence: A. A. Rodríguez

Intensive Care Medicine Experimental 2023, **11(Suppl 1)**:000673

Introduction: ICU-acquired weakness (ICUAW) is a long-recognised phenomenon, featuring a prevalence of 25–80%. Early mobilisation is an accepted intervention that may attenuate ICUAW and improve outcomes [1–4].

Objectives: Analyse, through a prospective observational study in a polyvalent ICU, the effect of early rehabilitation (eRHB) on the functional quality of life of patients one year after discharge (D/C).

Methods: During the COVID-19 pandemic, an early mobilisation protocol was started, working with the rehabilitation and physiotherapy department. Following its implementation, we conducted a prospective observational study in a polyvalent ICU analysing the effect of early rehabilitation (eRHB) on the quality of life of critically ill SARS-CoV2 positive patients one year after discharge (D/C); between March 2020 and July 2022.

Our study cohort included patients who did not receive early RHB (NO-eRHB group; programme was not yet in place) and patients who did receive early RHB (YES-eRHB group). All patients had (a) SARS-CoV2 pneumonia and (b) required invasive mechanical ventilation > 24 h. Demographic and clinical data were collected, and a telephone survey was conducted one year after D/C. We assessed the quality of life measured by: CFS on ICU admission (T1), Barthel at ICU discharge (T2), Barthel at hospital discharge (T3), and CFS/Barthel/SF36 one year after hospital discharge (T5). Statistical analysis was performed between subgroups: Pearson’s Chi-square test or Mann–Whitney U test to find significant differences.

Results: We included 99 patients; 64.6% belonged to the YES-eRHB group (n = 64). In the raw data analysis (NO-eRHB group vs. YES-eRHB group), we observed statistically significant differences in SAPS III (59 vs. 53, p = 0.001) and SOFA on ICU admission (5 vs. 3; p < 0.001). Given the possibility that this statistically significant difference could impact the results obtained in the surveys, a propensity score (matching according to severity scales, age, and sex) was performed. Thus, we got 35 patients from the YES-eRHB group with demographic characteristics very similar to those from the NO-eRHB group. We observed only one death in the YES-eRHB group during the study period.

Demographic data and survey results are shown in Tables 1 and 2, respectively. Patients who belonged to the YES-eRHB showed a higher prevalence of respiratory comorbidities, required more often non-invasive mechanical ventilation after extubation, and showed longer hospital length-of stay. Regarding survey results, there were no statistically significant differences except for social functioning and self-reported health transition.

Conclusions: The assessment of interventions in critically ill patients is often complicated, given the close relationship between many factors,

some of which are uncontrollable. Despite not having found statistically significant differences in most of the items assessed, we should highlight that patients who received early rehabilitation reported a clear positive impact on their social life and on the self-reported health transition item (higher vitality recovery, better pain control, and physical functioning). These results encourage and push us to continue improving critical patient care from a multidisciplinary point of view. Our goal is to get our patients back on their feet and back to their baseline life (or at least to a state of health they are satisfied and happy with).

Table 1 (abstract 000673) Demographic data

		NO-RHB	YES-RHB	p
Comorbidities, n (%)	Cardiovascular	13 (37.1%)	19 (54.3%)	0.2
	Respiratory	3 (8.6%)	11 (31.4%)	0.034
	Renal	13 (37.1%)	19 (54.3%)	0.2
	Hepatic	2 (5.7%)	2 (5.7%)	>0.9
	Cancer disease	6 (17.1%)	6 (17.1%)	>0.9
	Endocrine	16 (45.7%)	13 (37.1%)	0.6
Organ-supportive treatments	Days on invasive MV, n (%)	11.0 [9.0-16.0]	15.0 [9.0-25.0]	0.2
	Non invasive MV, n (%)	6 (17.1%)	24 (68.6%)	<0.001
	Reintubation, n (%)	6 (17.1%)	2 (5.7%)	0.3
	Prone positioning, n (%)	17 (48.6%)	24 (68.6%)	0.14
	Neuromuscular blockade, n (%)	27 (77.1%)	19 (54.3%)	0.076
Organ failure, n (%)	Cardiovascular	31 (88.6%)	27 (77.1%)	0.3
	Renal	12 (34.3%)	9 (25.7%)	0.9
	Hepatic	2 (5.7%)	0 (0.0%)	0.5
	Hematologic	6 (17.1%)	4 (11.4%)	0.7
Number of organ failure/s, median (IQR)		3 (2-4)	0 (0-2)	<0.001
ICU length-of-stay, days, median (IQR)		14.0 [10.0-30.5]	22.5 [16.0-33.2]	0.051
Hospital length-of-stay, days, median (IQR)		15.0 [10.0-28.0]	22.5 [16.8-37.0]	0.036

*Age, sex, SAPSIII and SOFA are excluded from the table as we matched patients according to these variables

Table 2 (abstract 000673) Quality of life data. Different periods for each scale and different items within the SF-26 score

		NO-PHYS	YES-PHYS	p
Survey answered, n (%)		30 (85.7%)	25 (73.5%)	0.2
Survey recipient, n (%)	Patient	28 (93.3%)	19 (76.0%)	0.12
	Surrogate	2 (6.7%)	6 (24.0%)	
CFS, median (IQR)	At ICU admission	3.0 [2.0-3.0]	3.0 [3.0-3.0]	0.067
	1 yr after discharge	4.0 [3.0-4.0]	3.0 [3.0-4.0]	>0.9
Barthel, median, (IQR)	At ICU discharge	40.0 [25.0-70.0]	40.0 [25.0-60.0]	0.9
	At hospital discharge	75.0 [55.0-90.0]	60.0 [45.0-92.5]	0.3
	1 yr after discharge	90.0 [80.0-95.0]	100.0 [80.0-100.0]	0.4
SF36 1 yr after discharge, median (IQR)	Limitation of activities	55.0 [35.0-72.5]	75.0 [45.0-85.0]	0.3
	Physical health problems	37.5 [0.0-68.8]	75.0 [0.0-100.0]	0.1
	Emotional health problems	66.7 [33.3-100.0]	66.7 [33.3-100.0]	0.9
	Energy	55.0 [41.2-65.0]	70.0 [50.0-80.0]	0.12
	Mental health	64.0 [56.0-75.0]	72.0 [56.0-80.0]	0.5
	Social activities	56.2 [37.5-71.9]	75.0 [62.5-97.5]	0.004
	Pain	55.0 [45.0-77.5]	67.5 [55.0-77.5]	0.4
	General health	47.5 [31.2-55.0]	55.0 [45.0-70.0]	0.2
	One yr transition	50.0 [50.0-75.0]	75.0 [50.0-100.0]	0.031

References

- [1] Needham DM. JAMA 2008; 300:1685–1690.
- [4] Lang JK et al. Crit Care Med. 2020;48(11):e1121–e1128.
- [3] Miranda Rocha AR et al. Med Intensiva 2017;41(7):429–436.
- [2] Schweickert WD et al. Lancet 2009; 373:1874–1882.

Topic: Critical care organisation, quality management, information systems, outcomes

000674

Risk factors and colonization by multidrug-resistant bacteria in patients admitted to our ICU before and after the pandemic

N. Cruza Leganés¹, V. Losada Martínez¹, F. Arbol Linde¹, D. Fuentes Scott¹, M. A. Taberna Izquierdo¹

¹Intensive Care Unit, University General Hospital Nuestra Señora del Prado, Talavera de la Reina, Spain

Correspondence: N. Cruza Leganés

Intensive Care Medicine Experimental 2023, **11(Suppl 1)**:000674

Introduction: Facing the problem of multidrug-resistant bacteria (MDR-B) increasing, in our Intensive Care Unit (ICU) screening for MDR-B is carried out on admission from all patients with risk factors (RF) for them within the “Zero Resistance” project (1).

Objectives: To analyse patients admitted to our ICU who have RF for colonization by MDR-B, the RF rate, colonized patients and isolated MDR-B, assessing their evolution before and after COVID-19 pandemic.

Methods: A retrospective descriptive observational analysis of MDR-B RF and colonizations of patients admitted to our ICU in the pre-COVID (preC) and post-COVID (posC) period, from May 2018 to February 2020 and from November 2021 to March 2023. Screening for MDR-B is carried out by collection of oropharyngeal (OP) and rectal swabs on admission from all patients with risk factors (RF) for them within the “Zero Resistance” project (1). It is a multipurpose ICU with 12 beds, which increased to 24 beds during the pandemic.

Results: In the preC period, 912 patients were admitted to our ICU, of which 147 (16.12%) had RF for MDR-B; 77 (52.38%) had one RF and 57 (38.77%) 2 RF. The most frequent RF being previous admission (73.47%), followed by previous antibiotic treatment (61.9%). OP and rectal samples were collected from 114 patients (77.5%), of which 30 (26.32%) presented colonization by MDR-B, being rectal 25 (83.33%) and OP 8 (26.66%). The most frequent germs in rectal colonization (RC) were 12 (48%) extended spectrum betalactamase-producer *Gram-negative bacillus* (ESBL-GNB), followed by 5 (20%) *Acinetobacter baumannii* imipenem-resistant, 4 (16%) methicillin-resistant *Staphylococcus aureus* (MRSA), 4 (16%) vancomycin-resistant *Enterococcus* (VRE) and 4 (16%) other GNB (1 carbapenemase). Three patients (12%) were colonized by more than one MDR-B. The most frequent germ in OP colonization (OPC) was MRSA in 5 (78.5%).

In the posC period, 701 patients were admitted, of whom 146 had RF (20.83%); 94 (64.38%) 1 FR and 40 (27.4%) 2 RF. The most frequent RF was previous admission (76.02%), followed by previous antibiotic treatment (44.52%). OP and rectal samples were collected from 108 patients (73.97%), of which 32 (29.63%) presented colonization by MDR-B, 27 (84.37%) RC and 12 (37.5%) OPC. About de rectal samples the most frequent were 13 (48.15%) ESBL-GNB, 7 (25.92%) KPC producing GNB, 4 (14.81%) *Pseudomonas aeruginosa* (PA), 3 (11.1%) *Enterobacter* and 3 (11.1%) MRSA. Five patients (18.52%) had RC by more than one MDR-B. In OP, 4 (33.33%) PA, 4 (33.33%) GNB ESBL and 3 (25%) MRSA; 4 (33.33%) had more than one MDR-B.

Conclusions: There is an increase in the rate of patients presenting RF in the posC period (20.83%) beside preC (16.12%). In both, the most frequent RF was previous admission, followed by previous antibiotic

treatment. MDR-B colonization was 26.32% preC and 29.63% postC. The most frequent germs in RC were ESBL-GNB in both periods. In the posC appear KPC-GNB that were not detected the preC, with more patients colonized by more than one MDR-B. In OP, SAMR predominates in preC and GNB in posC.

References

1. Montero JG, Lerma FÁ, Gallego PR, Martínez MP, Rocha LÁ, Gaité FB, Rodríguez JÁ, González MC, Moreno IF, Baño JR, Campos J, Andrés JM, Varela YA, Gay CR, García MS; Scientific Expert Committee for Zero Resistance Project. Combatting resistance in intensive care: the multimodal approach of the Spanish ICU “Zero Resistance” program. Crit Care. 2015 Mar 16;19(1):114. <https://doi.org/10.1186/s13054-015-0800-5>. PMID: 25880421; PMCID: PMC4361202.

Topic: Infections and prevention

000675

Point of care application of T2 bacteria magnetic resonance assay in the intensive care unit

C. Vrettou¹, E. Douka¹, E. Perivolioti², A. G. Vassiliou¹, A. Sarri¹, V. Giannopoulou¹, K. Trigkidis¹, A. Kotanidou¹

¹First department of Critical Care, Evaggelismos General Hospital, Athens, Greece; ²Department of Clinical Microbiology, Evaggelismos General Hospital, Athens, Greece

Correspondence: C. Vrettou

Intensive Care Medicine Experimental 2023, **11(Suppl 1)**:000675

Introduction: ESKAPE pathogens are increasingly identified as causative microorganisms in hospital acquired infections. The T2MR platform can expedite the identification of such pathogens in whole blood specimens without the prior need of a positive blood culture.

Objectives: To evaluate the feasibility and diagnostic accuracy of the T2 bacteria assay as point of care test in the intensive care unit compared to blood cultures.

Methods: Prospective observational study of consecutive critically ill patients with suspected bacteremia. Data collected included microbiological and T2 bacteria assay reports. Diagnostic accuracy was evaluated considering the blood cultures as the gold standard.

Results: 208 patients were assessed for eligibility and included in the study. All patients had T2 bacteria and blood culture samples sent. The rate of reported blood culture contamination as well as the rate of invalid T2 bacteria reports was 6.73%. 181 patients had valid blood culture and T2 bacteria reports. The mean time from sampling to report availability was 4 days for the blood culture results, and 3 h and 40 min for the T2 bacteria assay. The positive % agreement was 90.5%, the negative % agreement was 62.6%, the positive predictive value was 42.2%, and the negative predictive value was 95.6%.

Conclusions: The T2 bacteria diagnostic assay has high negative predictive value for excluding bacteremia caused by ESKAPE pathogens in a fraction of time compared to blood cultures. The application of this method is feasible as point of care technique in the intensive care. The lower positive predictive value observed can be attributed to higher sensitivity of T2 bacteria compared to blood cultures.

References

1. Mcadam AJ (2017) Sensitivity and Specificity of Positive and Negative Percent Agreement? A Micro-Comic Strip. Journal of clinical microbiology 55(11), 3153–3154. <https://doi.org/10.1128/JCM.00977-17>
2. Nguyen MH, Clancy CJ, William Pasculle A, et al. (2019) Performance of the T2bacteria panel for diagnosing bloodstream infections. Ann Intern Med 170:845–852. <https://doi.org/10.7326/M18-2772>

3. Vincent JL, Sakr Y, Singer M, et al. (2020) Prevalence and Outcomes of Infection among Patients in Intensive Care Units in 2017. *JAMA* 323:1478–1487. <https://doi.org/10.1001/jama.2020.2717>

Topic: Infections and prevention

000676

Safety and effectiveness of intensive treatments administered outside the intensive care unit to hematological critically ill patients

B. Vergnano¹, D. Signori², A. Benini¹, S. Calcinati¹, F. Bettini¹, L. Verga³, L. M. Borin³, F. Cavalca², C. Gambacorti Passerini², G. Bellani⁴, G. Foti²

¹Anesthesia and Intensive Care Medicine, Ospedale San Gerardo, Monza, Italy; ²Department of Medicine and Surgery, University of Milano-Bicocca, Monza, Italy; ³Hematology, Ospedale San Gerardo, Monza, Italy;

⁴Anesthesia and Intensive Care, Centre for Medical Sciences - CISMed, University of Trento, Trento, Italy

Correspondence: D. Signori

Intensive Care Medicine Experimental 2023, **11(Suppl 1)**:000676

Introduction: Historically, admission of hematological patients in the ICU shortly after the start of a critical illness is associated with better survival rates [1–3]. However, prompt ICU admission cannot always be achieved. Intensive interventions administered by a pre-ICU system as (Medical Emergency Team) MET have an establish role in the management of critically ill patients [4–6]. However, the safety and effectiveness of intensive management of hematological patients in non-intensive wards is unclear [3].

Objectives: Our aim was to evaluate the safety and effectiveness of an intensive treatment trial in the medical ward provided by MET on hematological patients who develop a critical illness.

Methods: This is a monocentric retrospective study. The interventions provided by MET in the pre-ICU setting are mainly helmet CPAP and/or pharmacological cardiovascular support. We considered eligible for the study hematological adult patients (age ≥ 18 years) that were referred to MET for an acute clinical deterioration. We excluded patients who were not eligible to the ICU treatment due their clinical condition and poor prognosis defined by a multidisciplinary team composed of hematologists and intensivists. We also excluded those patients who immediately died after MET referral and for which the MET was alerted for the first time for a cardiac arrest.

Results: Between January 2015 and December 2019, our MET was called for advice for 169 hematological patients, 133 of which were considered eligible for data collection and analysis. Of these, 84 (63%) were admitted to ICU, while 49 (37%) were treated exclusively in the hematological ward (Figure 1).

Overall, in hospital mortality was 38%; mortality doesn't increase in patients not immediately transferred to the ICU (Figure 2). Moreover, 37% of patients overcame the critical episode in the hematological ward, thereby avoiding a relocation in a less isolated environment and lifting the pressure on ICU beds. 84 patients were admitted to the ICU, 53 of them (63%) immediately after the first MET referral. Only 3 patients died without a former admission in ICU; in these cases, mortality was not related to the acute illness, confirming the safety of this approach.

Apparently, mortality is not influenced by age, sex, comorbidity, prior performance status, neutropenia, pharmacological immunosuppression, PaO₂/FiO₂, and degree of cardiovascular failure. Contrarily, patients who died had generally more severe systemic disease at first MET evaluation (SOFA 8.0 vs. 5.9, $p < 0.001$; MEWS 4.9 vs 3.8, $p = 0.007$) than those who survived.

Conclusions: An intensive treatment trial in the medical ward provided with MET support on hematological patients who develop a critical illness may be effective in avoiding ICU admission and safe. SOFA and MEWS were effective tools for prognostication. A prospective and multicentric trial is necessary to confirm our results.

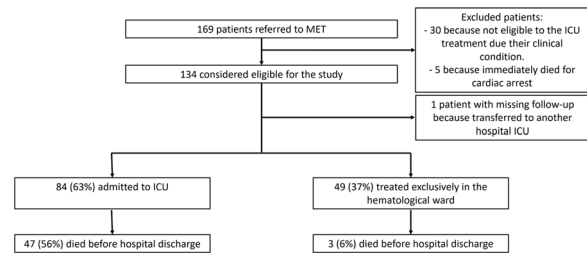

Figure 1 (abstract 000676) Enrollment, exclusion and patients' distribution in the primary analysis

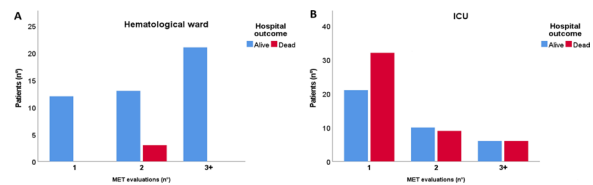

Figure 2 (abstract 000676) Mortality distribution between 1, 2, and 3 or more (3+) MET evaluations in patients treated exclusively in the hematological ward (panel A) and in those admitted in the ICU (panel B). MET: medical emergency team; ICU: intensive care unit

References

1. Azoulay E, Mokart D, Pène F, et al. Outcomes of critically ill patients with hematologic malignancies: prospective multicenter data from France and Belgium—a groupe de recherche respiratoire en réanimation onco-hématologique study. *J Clin Oncol*. 2013;31(22):2810–2818. <https://doi.org/10.1200/JCO.2012.47.2365>
2. Kiehl M, Beutel G, Böll B, et al. Consensus statement for cancer patients requiring intensive care support. *Annals of Hematology*. 2018;97. <https://doi.org/10.1007/s00277-018-3312-y>
3. Taheri L, Anandanadesan R, de Lavallade H, et al. The role of a critical care outreach service in the management of patients with haematological malignancy. *Journal of the Intensive Care Society*. 2019;20(4):327–334. <https://doi.org/10.1177/1751143719855201>
4. Austin CA, Hanzaker C, Stafford R, et al. Utilization of rapid response resources and outcomes in a comprehensive cancer center*. *Crit Care Med*. 2014;42(4):905–909. <https://doi.org/10.1097/CCM.0000000000000098>
5. Jung B, Daurat A, De Jong A, et al. Rapid response team and hospital mortality in hospitalized patients. *Intensive Care Med*. 2016;42(4):494–504. <https://doi.org/10.1007/s00134-016-4254-2>
6. De Jong A, Jung B, Daurat A, et al. Effect of rapid response systems on hospital mortality: a systematic review and meta-analysis. *Intensive Care Med*. 2016;42(4):615–617. <https://doi.org/10.1007/s00134-016-4263-1>
2. None

Topic: Haematologic-oncologic issues in the ICU

000677

Post-COVID anxiety, depression, and post-traumatic stress

M. Detoraki¹, S. Ili¹, E. Kondyli², N. Papanikolaou³, S. Koukias¹, E. Bachlitzanaki¹, G. Briassoulis¹

¹Postgraduate Program “Emergency and Intensive Care in Children, Adolescents, and Young Adults”, School of Medicine, University of Crete, Heraklion, Greece; ²ICU, University Hospital, School of Medicine, University of Crete, Heraklion, Greece; ³First Department of Internal Medicine, Venizeleio-Pananeio General Hospital, Heraklion, Greece

Correspondence: S. Ili

Intensive Care Medicine Experimental 2023, **11(Suppl 1)**:000677

Introduction: The long-standing effects of Covid-19 disease in physical and mental health are described by the term “post-Covid syndrome”. Anxiety, depression, and post-traumatic stress are the most frequent post-Covid psychiatric manifestations. It is crucial to identify the patients at risk for post-Covid mental health sequelae, so that further support is provided, and their quality of life is improved in the long term.

Objectives: We aim to identify risk factors associated with the post-Covid anxiety, depression, and post-traumatic stress; correlate post-Covid symptoms with demographic and clinical characteristics; compare the prevalence of psychiatric manifestations among patients differing in co-morbidity, vaccination status, and Covid-19 severity.

Methods: A prospective cohort study recruited patients at one-, three-, or six- month follow-up after SARS-CoV-2 infection. Their demographic information, medical history, and clinical records during (disease severity, need for hospitalization or oxygen therapy) and after infection (somatic and psychiatric symptoms) were investigated. Symptoms of anxiety and depression were measured by the Hospital Anxiety and Depression Scale (HADS) [1] and symptoms of post-traumatic stress were measured by the Post-traumatic Stress Disorder Checklist-Civilian (PCL-C) [2].

Results: Two hundred and fifty patients were enrolled in the study. Post Covid symptoms varied from 88.3% (3rd month) to 70.1% (6th month). Mild mental health symptoms were common (anxiety 29.4%, depression 24.3%, post-traumatic stress 32.3%). Female sex ($p < 0.01$) and comorbidities ($p < 0.001$) were the strongest predictors of these symptoms, whereas severe or critical Covid-19 disease ($p = 0.001$) and hospitalization ($p = 0.002$) were associated with the presence of post-Covid depressive symptoms. Absent (26.8%) or incomplete (16.4%) vaccination against SARS-CoV-2 virus was associated with severe or critical illness (55.3%, $p < 0.001$) and post-traumatic stress symptoms ($p = 0.05$). Age, body mass index, respiratory support, oxygen therapy, and length of stay were not found to significantly correlate with post-Covid mental health symptoms.

Conclusions: Mental health symptoms are common up to six months after Covid-19 infection, with women and patients with comorbidities being the most vulnerable. Taking into consideration the increasing number of patients with post-Covid syndrome, this study highlights the need for their multidisciplinary evaluation.

References

1. Zigmond AS, Snaith RP. The Hospital Anxiety and Depression Scale. *Acta Psychiatrica Scandinavica*. 1983;67(6):361–70.
2. Weathers F, Litz B, Herman D, Huska JA, Keane T. The PTSD Checklist (PCL): Reliability, validity, and diagnostic utility. Paper Presented at the Annual Convention of the International Society for Traumatic Stress Studies, 1993.

Topic: Sedation, analgesia and delirium

000678

Effects of NF- κ B inhibitor on sepsis depend on the severity and phase of the animal sepsis model

J. P. Ye¹, J. Bae², J. K. Yoo³, A. So-Hee⁴, Y. P. Seon⁵, K. Yun-Seok⁶, M. Lee⁷, N. C. Tae⁸, C. Chulhee⁹, K. Kyuseok⁷

¹Emergency Medicine, Yejin6577@naver.com, Seongnam-si, Republic of Korea; ²Emergency Medicine, galen97@cha.ac.kr, Seongnam-si, Republic of Korea; ³Department of Research, jyoo@iliasbio.com, Daejeon, Republic of Korea; ⁴Department of Research, shahn@iliasbio.com, Daejeon, Republic of Korea; ⁵Department of Research, jchoi@iliasbio.com, Daejeon, Republic of Korea; ⁶Emergency medicine, louyps@naver.com, Seongnam-si, Republic of Korea; ⁷Emergency Medicine, Cha University, Pocheon-si, Republic of Korea; ⁸Emergency Medicine, hendrix74@cha.ac.kr, Seongnam-si, Republic of Korea; ⁹Department of Research, cchoi@iliasbio.com, Daejeon, Republic of Korea

Correspondence: K. Kyuseok

Intensive Care Medicine Experimental 2023, **11(Suppl 1)**:000678

Introduction: Hyperinflammation occurs in sepsis, especially in early phase, and it could have both positive and negative effects on sepsis.

Previously, we showed that new concept of NF- κ B inhibitor, exosome-based super-repressor I κ B α (Exo-srI κ B) delivery, has beneficial effect on sepsis.

Objectives: To investigate the therapeutic effects of this Exo-srI κ B in different severity and phase of the sepsis using animal polymicrobial intra-abdominal infection model.

Methods: We used a rat model of fecal slurry polymicrobial sepsis. First, we determined the survival effects of Exo-srI κ B on sepsis according to the severity. We used two different severities of animal sepsis model. Severe model had mortality rate over 50%. Mild/moderate model had less than 30% mortality rate. Second, we administered the Exo-srI κ B at various time points (1 h, 6 h, and 24 h after fecal slurry administration) to determine the therapeutic effect of Exo-srI κ B at different phase of sepsis. Lastly, we determined the effects of the Exo-srI κ B on the arterial blood gas, electrolyte, and lactate.

Results: The survival gain was statistically significant in severe sepsis model when Exo-srI κ B was administered 6 h after sepsis. The laboratory data showed that lactate, glucose, and potassium levels were significantly lowered in NF- κ B inhibitor group.

Conclusions: Exo-srI κ B, exhibited beneficial therapeutic effect when administered 6 h post fecal slurry administration in severe sepsis model.

Topic: Sepsis

000679

Safety and performance of the NucleoCapture[®] Column for selective therapeutic removal of cfDNA/NETs in patients with sepsis (ClinicalTrials.gov Identifier: NCT04749238)

A. Aswani¹, S. Abramovsky², M. I. Afanasieva³, N. S. Pokrovsky³, A. A. Sokolov³, I. Adamova⁴, S. Avtushenko⁵, K. Surkov⁵, D. Genkin⁵

¹Dept of Intensive Care Medicine, Guy's and St Thomas' NHS Foundation Trust, London, United Kingdom; ²North Western Regional Scientific and Clinical Center, Named after N. N. L. G. Sokolova FMBA, Saint Petersburg, Russia; ³National Medical Research Center of Cardiology, Ministry of Health of Russia, Moscow, Russia; ⁴Therapeutic apheresis, Pocard Ltd, Moscow, Russia; ⁵Therapeutic Apheresis, Santerus AG, Zürich, Switzerland

Correspondence: A. Aswani

Intensive Care Medicine Experimental 2023, **11(Suppl 1)**:000679

Introduction: Cell-free DNA (cfDNA)/Neutrophil Extracellular Traps (NETs) are associated with sepsis. NucleoCapture[®] (Pocard) apheresis is based on recombinant histone H1.3 selective binding to cfDNA/NETs. We previously demonstrated that NucleoCapture[®] reduced organ dysfunction and improved survival in a porcine sepsis model. We therefore performed a first in human study of NucleoCapture[®] in ten patients with sepsis in the ICU.

Methods: We enrolled ten adult ICU patients diagnosed with sepsis according to the Sepsis-3 criteria. We aimed to apply NucleoCapture[®] treatment in conjunction with the Terumo Optia system once daily for 3–5 days depending on the physician's assessment, in addition to standard of care. Efficacy and safety parameters were measured. We used the NuQ H3.1 nucleosome assay (Volition) to measure cfDNA/NETs.

Results: Ten patients underwent a total of 32 treatments with NucleoCapture[®]. The majority underwent 3 sequential treatments on Days 1 to 3. Each treatment lasted 4.26 (± 0.8) hours and 3.7 (± 0.4) plasma volumes were processed, Mean (\pm SD). No saturation of the column was evident with near complete removal (85–100%) of cfDNA/NETs in the extracorporeal circuit at all time points. This resulted in a reduction in the circulating levels of cfDNA/NETs in patient blood from 861.45 (IQR 295.7–1201.4) ng/ml to 211.5 (102.8–275.6) ng/ml from Days 1–3 (Figure 1). There were statistically significant decreases in inflammatory markers (e.g., CRP), organ function biomarkers (e.g., NGAL, Figure 2) and SOFA score (from 5.4 (± 2.76) to 3.14 (± 2.34), $p = 0.05$) during treatments with NucleoCapture[®]. The 28-day mortality was 50%. Six patients experienced a total of 12 adverse events, three of which were determined to be serious adverse events (SAEs). The investigators considered the SAEs to be unrelated to treatment with the investigational device.

Conclusions: This first in human study of NucleoCapture® suggests that selective cfDNA/NETs apheresis in sepsis is feasible, safe and has the potential to improve the course and outcomes of the disease. We plan to test this in an upcoming larger pivotal multicentre randomised controlled trial (ClinicalTrials.gov Identifier: NCT05647096).

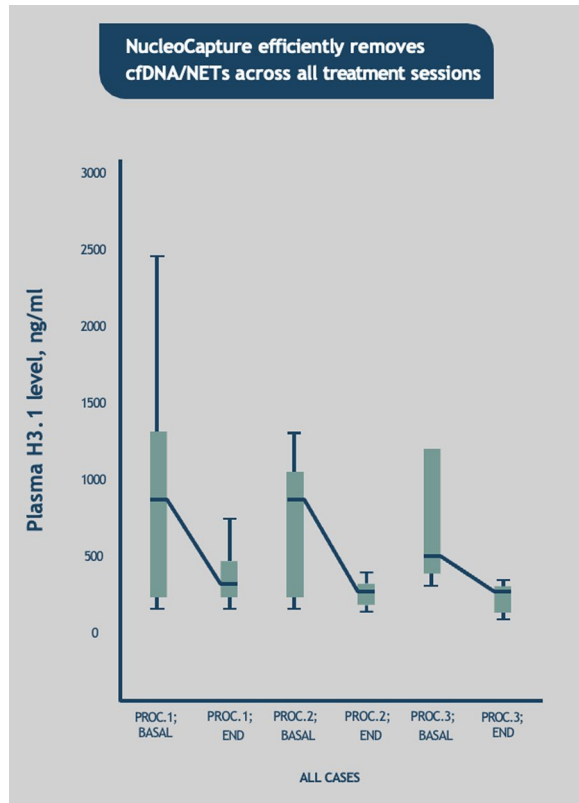

Figure 1 (abstract 000679) Change in plasma cfDNA/NETs over the course of 3 days of treatment with NucleoCapture®. cfDNA/NETs were measured using the NuQ H3.1 ELISA (Volition). Box plot with Min, Max, Median (IQR) values shown

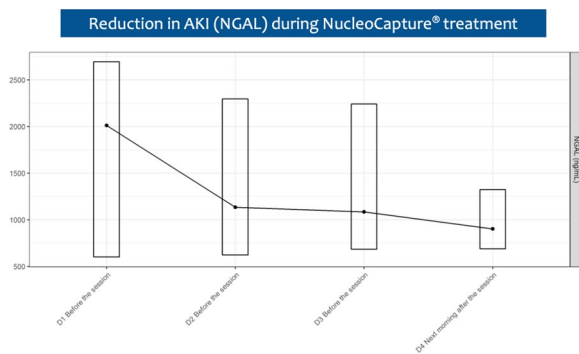

Figure 2 (abstract 000679) Early kidney injury biomarkers during NucleoCapture® treatment: Neutrophil gelatinase-associated lipocalin (NGAL). The plasma level of NGAL gradually decreased during the course of NucleoCapture® treatments, from a median of 1012 ng/

mL on day 1 before the 1st session to 902 ng/mL on day 4, the day after the 3rd session, i.e., by 55%. A statistically significant decrease ($p=0.020$) in the NGAL levels was observed between day 1 before start of the 1st session and day 2 before start of the 2nd session. Median (IQR) values shown

References

- Singh, J., Boettcher, M., Dölling, M., Heuer, A., Hohberger, B., Leppkes, M., Naschberger, E., Schapher, M., Schauer, C., Schoen, J., et al. (2023). Moonlighting chromatin: when DNA escapes nuclear control. *Cell Death Differ*, 1–15. <https://doi.org/10.1038/s41418-023-01124-1>
- Nofi, C.P., Wang, P., and Aziz, M. (2022). Chromatin-Associated Molecular Patterns (CAMPs) in sepsis. *Cell Death Dis* 13, 700. <https://doi.org/10.1038/s41419-022-05155-3>
- McDonald, B., Davis, R.P., Kim, S.-J., Tse, M., Esmon, C.T., Kolaczowska, E., and Jenne, C.N. (2017). Platelets and neutrophil extracellular traps collaborate to promote intravascular coagulation during sepsis in mice. *Blood* 129, 1357–1367. <https://doi.org/10.1182/blood-2016-09-741298>
- Clark, S.R., Ma, A.C., Tavener, S.A., McDonald, B., Goodarzi, Z., Kelly, M.M., Patel, K.D., Chakrabarti, S., McAvoy, E., Sinclair, G.D., et al. (2007). Platelet TLR4 activates neutrophil extracellular traps to ensnare bacteria in septic blood. *Nature medicine* 13, 463–469. <https://doi.org/10.1038/nm1565>
- Fuchs, T.A., Abed, U., Goosmann, C., Hurwitz, R., Schulze, I., Wahn, V., Weinrauch, Y., Brinkmann, V., and Zychlinsky, A. (2007). Novel cell death program leads to neutrophil extracellular traps. *J Cell Biology* 176, 231–241. <https://doi.org/10.1083/jcb.200606027>
- AA is Chief Medical Officer of Santerus AG

Topic: Sepsis

000681

Consensus-based indicators for evaluating and improving the quality of regional collaborative networks of Intensive Care Units: results of a nationwide Delphi study

G. Hesselink¹, R. R. Verhage¹, I. Van der Horst², J. G. Van Der Hoeven¹, M. Zegers¹

¹Intensive Care, Radboud University Medical Center, Nijmegen, Netherlands; ²Intensive Care, UMC+, Maastricht, Netherlands

Correspondence: G. Hesselink

Intensive Care Medicine Experimental 2023, **11(Suppl 1)**:000681

Introduction: Regional collaboration between Intensive Care Units (ICUs) is needed to cope with the increasing demand for ICU care and limited resources in terms of staff, beds and budget.

Objectives: Our aim was to select a consensus-based set of relevant and feasible indicators for monitoring and improving the quality of regional ICU network collaboratives.

Methods: Prior to the Delphi, 85 potentially relevant indicators were identified and listed through a systematic search of (grey) literature and by using the input of a core group of experts. A three-round RAND-modified Delphi study was subsequently conducted in the Netherlands between April and July 2022 (Figure 1). A multidisciplinary expert panel appraised and prioritized the potentially relevant indicators in two rounds of questionnaires with two consensus meetings between both rounds. The RAND/UCLA appropriateness method was used to categorize indicators and synthesize results. The relevance and feasibility of each indicator (in the first questionnaire generally assessed as the degree of appropriateness) were scored on a nine-point Likert scale. In the final questionnaire experts were additionally asked to prioritize the indicators by selecting the ‘top 5’ of most relevant and feasible indicators. Indicators with a group median ≥ 7 , a disagreement index < 1 (indicating agreement) and receiving more than five percent of the maximum possible ranking points were selected for the core set and finally tested in two ICU network collaboratives to assess their measurability.

Results: After three rounds, 24 indicators were deemed as relevant and feasible. Seven indicators (three structure, three process and one outcome) were selected for the core set measuring the standardized mortality rate in the region ($n=1$) and measuring the existence, content and/or follow-up of a formal plan describing network structures and policy agreements ($n=3$), a long-term network vision statement ($n=1$), and network meetings to reflect on and learn from ICU outcome data ($n=2$) (Table 1). The practice tests led to minor reformulations.

Table 1 (abstract 000681) List of core set indicators*

A regional ICU cooperation plan is integrated in the policy plan of each ICU in which the tasks, responsibilities and competencies of each hospital/ICU within the network are clearly described (yes/no)
ICU indicator data from NICE** is regionally discussed with a focus on learning and improving (yes/no)
The regional ICU cooperation plan is demonstrably annually evaluated and actualized within the network (yes/no)
Presence of an annual (quality) report of the ICU network describing the network governance structure, actions and outcomes (yes/no)
The number and a description of the nature/types of improvements implemented after regional quality discussion meetings
SMR within the ICU network, expressed as the ratio of the observed and predicted mortality
A long-term vision is formulated in which the role of each ICU within the network is clearly defined (yes/no)

ICU: Intensive Care Unit; SMR: Standardized Mortality Ratio; NICE: National Intensive Care Evaluation Registry

*Indicators selected for the core set (on the basis of: a median > 7 and DI score < 1 for both relevance and feasibility, and receiving $\geq 5\%$ of the maximum possible ranking points)

**This registry receives monthly batches of data from ICUs extracted from local electronic hospital registries on intensive care patients and their outcomes to monitor and improve the quality of care

Conclusions: This study generated a set of relevant and feasible indicators for monitoring and improving the quality of regional ICU collaborative networks based on the collective opinion of a multidisciplinary group of experts. The indicators can assist those responsible for the governance of regional ICU network collaboratives in the Netherlands and abroad.

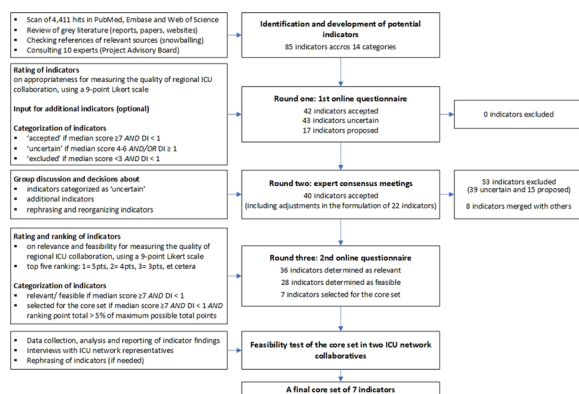

Figure 1 (abstract 000681) Flowchart of the study

Topic: Critical care organisation, quality management, information systems, outcomes

000682

Clinical evaluation of a new method to estimate transpulmonary pressure during assisted mechanical ventilation

M. Sánchez Galindo¹, J. A. Sanchez Giralte², M. A. Pérez Lucendo², I. Magaña Bru², I. Temprano García², C. Alvargonzález Riera², L. Rojo Montes², E. Rosas Carvajal², B. Abad Santamaría², J. Beck³, C. Sinderby³, F. Suarez Sipmann²
¹ITU, Hospital de La Princesa, Madrid, Spain; ²ICU, Hospital de La Princesa, Madrid, Spain; ³Keenan Research Centre for Biomedical Science, St. Michael's Hospital Li Ka Shing Knowledge Institute, Toronto, Canada

Correspondence: M. Sánchez Galindo

Intensive Care Medicine Experimental 2023, **11(Suppl 1)**:000682

Introduction: Excessive patient spontaneous breathing efforts can complicate the transition from controlled to assisted ventilation. During this complex phase the lung may be particularly vulnerable to the injurious effects of high regional transpulmonary pressures. These can result from an unfavorable combination of ventilator delivered pressures and patient's generated muscular pressure. Monitoring transpulmonary pressures, especially in the context of patient's high inspiratory efforts, is of great clinical relevance but it requires the use of esophageal manometry of complex handling and interpretation. **Objectives:** Clinical validation of a new method to estimate transpulmonary pressure (PL) in patients on assisted ventilation without the need of an esophageal balloon. The method is based on the combined recording of the diaphragmatic electrical activity (EAdi) and the estimation of the patient's effort contribution during an inspiratory low-assist maneuver (LAM).

Methods: Experimental, physiological, prospective, comparative study performed in patients on assisted ventilation with an adequate spontaneous respiratory drive. Patients were simultaneously monitored with esophageal manometry (Nutrivent®) and an EAdi catheter. After checking the correct positioning and signal of both catheters, three consecutive periods of 30 min using different inspiratory assist levels (clinician-adjusted, under-assist: 50% reduction and over-assist: 50% increase) were performed in a new ventilatory mode called neural-pressure support (n-PSV), a modified PSV mode in which the pneumatic signal is replaced by the EAdi signal for inspiratory trigger and expiratory cycling. A LAM (2 cmH₂O-assisted cycle) was programmed every 3 min. LAM derived PL (PLLAM) was estimated using a correction factor obtained from the ratio between the inspiratory volume during the LAM cycle and the volume of an assisted cycle ensuring that both resulted from breaths with a similar inspiratory drive by confirmed by their respective EAdi. PLLAM was compared with the reference measurement obtained from the esophageal pressure derived PL (PLpes). Correlation (Pearson) and accuracy, precision and percentage error were analyzed using the Bland-Altman test between the two methods.

Results: Preliminary analysis including the first 22 patients of an estimated sample size of 26. Clinician-adjusted PEEP and inspiratory support pressure were $7,2 \pm 1,5$ and $10,5 \pm 2,7$ cmH₂O respectively. PLLAM correlated well with PLpes ($R^2 = 0.79$) accuracy (Bias of -0.05 cmH₂O) and precision (95% limits of agreement of -3.7 to 3.6 cmH₂O) and a percentage error of 34% independent from the level of assistance.

Conclusions: The proposed method provides good estimates of PL with high accuracy and good precision compared to the reference method in the studied population. If confirmed, PLLAM could be an attractive clinical method to continuously monitor PL during assisted ventilation, without the need to measure esophageal pressure.

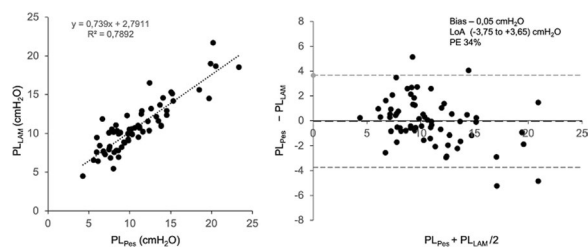

References

1. Yonis H. Patient-ventilator synchrony in Neurally Adjusted Ventilatory Assist (NAVA) and Pressure Support Ventilation (PSV): a prospective observational study. *BMC anesthesiology*. 2015;1–9.
2. Suarez-Sipmann F, SEMICYUC por el G de T de IRA de la. New modes of assisted mechanical ventilation. *Medicina intensiva/Sociedad Española de Medicina Intensiva y Unidades Coronarias*. 2014;38:249–60.
3. Piquilloid L, Vignaux L, Bialais E, Roeseler J, Sottiaux T, Laterre P-F, et al. Neurally adjusted ventilatory assist improves patient-ventilator interaction. *Intensive Care Medicine*. 2010;37:263–71.
4. Barwing J, Ambold M, Linden N, Quintel M, Moerer O. Evaluation of the catheter positioning for neurally adjusted ventilatory assist. *Intensive Care Medicine*. 2009;35:1809–14.
5. Milic-Emili J, Mead J, TURNER JM, GLAUSER EM. IMPROVED TECHNIQUE FOR ESTIMATING PLEURAL PRESSURE FROM ESOPHAGEAL BALLOONS. *Journal of Applied Physiology*. 1964;19:207–11.
6. Mauri T, Yoshida T, Bellani G, Goligher EC, Carreaux G, Rittayamai N, et al. Esophageal and transpulmonary pressure in the clinical setting: meaning, usefulness and perspectives. *Intensive Care Medicine*. 2016;1–14.
7. Yoshida T, Fujino Y, Amato MBP, Kavanagh BP. Fifty Years of Research in ARDS. Spontaneous Breathing during Mechanical Ventilation. Risks, Mechanisms, and Management. *American Journal of Respiratory and Critical Care Medicine*. 2017;195:985–92.
8. Brochard L, Slutsky A, Pesenti A. Mechanical Ventilation to Minimize Progression of Lung Injury in Acute Respiratory Failure. *Am J Resp Crit Care*. 2017;195:438–42.
9. Blanch L, Villagra A, Sales B, Montanya J, Lucangelo U, Luján M, et al. Asynchronies during mechanical ventilation are associated with mortality. *Intens Care Med*. 2015;41:633–41.
10. Tobin MJ, Laghi F, Jubran A. Ventilatory Failure, Ventilator Support, and Ventilator Weaning. *Comprehensive Physiology*. 2012

Topic: Acute respiratory failure and mechanical ventilation

000683

The haemodynamic effects of PEEP depend on alveolar recruitability in patients with acute respiratory distress syndrome

J. Hagry¹, S. Cappio Borlino¹, C. Lai¹, G. Fouqué¹, M. Fasan¹, E. Rocca¹, R. Shi², T. Pham¹, N. Angueli¹, J. L. Teboul¹, X. Monnet¹

¹AP-HP, Service de médecine intensive-réanimation, Hôpital de Bicêtre, Université Paris-Saclay, DMU CORREVE, Inserm UMR S_999, FHU SEPSIS, Groupe de Recherche Clinique CARMAS, Le Kremlin-Bicêtre, France;

²AP-HP, Service de médecine intensive-réanimation, Hôpital de Bicêtre, Université Paris-Saclay, Guangzhou, China

Correspondence: S. Cappio Borlino

Intensive Care Medicine Experimental 2023, **11(Suppl 1)**:000683

Introduction: During acute respiratory distress syndrome (ARDS), positive end-expiratory pressure (PEEP) might increase pulmonary vascular resistance (PVR). In theory, according to the U-shape of the relationship between PVR and lung volume, which nadir corresponds to the functional residual capacity, PEEP should increase PVR in case of alveolar overdistention and lower PVR if alveolar recruitment predominates. This has never been proven in patients with ARDS.

Objectives: We conducted a prospective observational study to evaluate PVR changes during PEEP modifications depending on the potential of lung recruitability, estimated through the recruitment-to-inflation (R/I) ratio.

Methods: In intubated ARDS patients, monitored by a pulmonary artery catheter, an oesophageal balloon and transthoracic echocardiography, PEEP was lowered by 10 cmH₂O from baseline. At the two levels of PEEP, hemodynamic, echocardiographic and respiratory variables were measured and preload dependence was evaluated through the passive leg-raising test. An R/I ≥ 0.5 defined high recruitment potential (HRP) and R/I < 0.5 defined low recruitment potential (LRP).

Results: Forty-five measurements were performed in 16 patients (2 [1; 3] measures per patient). Demographical and clinical characteristics are presented in Table 1.

Table 1 (abstract 000683) Demographical and clinical characteristics

Variables	Study population (n = 16)
Age, years	66 (11)
Male sex, n. (%)	12 (75)
BMI, kg/m ²	29 (6)
Extra-pulmonary ARDS aetiology, n. (%)	4 (25%)
SOFA score at admission	6 (3)
PaO ₂ /FIO ₂ at diagnosis, mmHg	108 (73–123)
Noradrenaline support at inclusion, n. (%)	16 (100)
Duration of invasive mechanical ventilation, days	8 (4–20)
ICU length of stay, days	11 (7–23)
ICU mortality, n. (%)	6 (38)

The R/I ratio was ≥ 0.5 (0.71 [0.60; 0.89]) in 25 (56%) measurements and there was no difference in the incidence of fluid-responsiveness between HRP and LRP groups (p=0.23). PEEP was lowered from 15 (12; 15) to 5 (2; 5) cmH₂O. By lowering PEEP, the PVR decreased in case of LRP (– 23 [– 29; – 14]%) while they remained unvaried in case of HRP (0 [– 10; 13]%, p<0.0001) (Figure 1). The gradient between mean pulmonary arterial pressure (MPAP) and pulmonary arterial occlusion pressure (PAOP) decreased in case of LRP (-7 [– 19; – 6]%) but increased in case of HRP (9 [0; 19]%, p<0.0001). A similar effect was observed for right to left ventricular end-diastolic area ratio (– 16 [– 25; – 9]%) vs. 3 [– 9; 17]%, respectively, p=0.0003). An R/I ≤ 0.44 could predict a decrease in the gradient between MPAP and PAOP with PEEP lowering with an area under the receiver operating characteristic curve of 0.83 (0.68–0.92) (p<0.0001 vs 0.5), a sensitivity of 80 (56–94)% and a specificity of 84 (64–96)% (Figure 2).

Conclusions: Effects of PEEP on PVR in mechanically ventilated patients with ARDS might depend on alveolar recruitment. A

significant risk of PVR increase exists when PEEP leads to pulmonary overdistention. This suggests that the potential of lung recruitment should be considered during PEEP titration, in order to better individualize respiratory support. The study is ongoing.

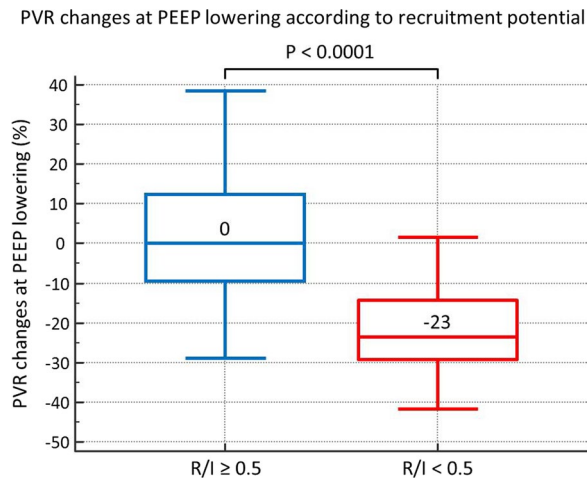

Figure 1 (abstract 000683) PVR changes at PEEP lowering according to recruitment potential

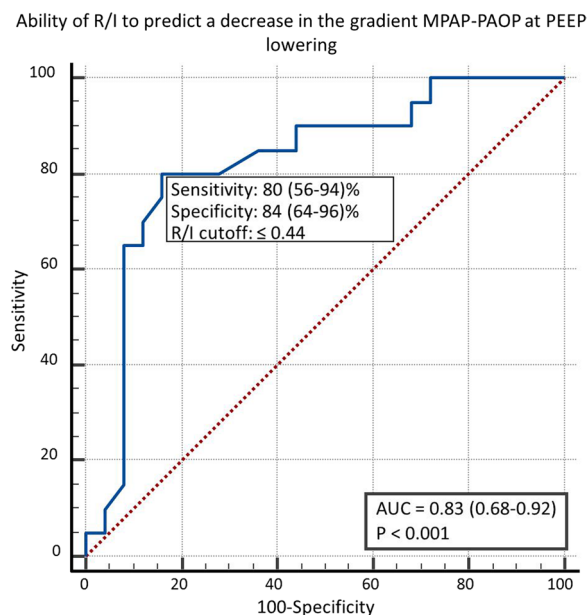

Figure 2 (abstract 000683) ROC curve for the ability to predict a decrease in the gradient MPAP-PAOP at PEEP lowering by R/I value

Topic: Cardiovascular issues in ICU

000684

Determinants of amino acid concentration in critically ill patients on CRRT

V. Vicka¹, T. Alcauskas², M. Kancyte², S. Miskinyte², I. Bartuseviciene², A. Vickiene³, D. Ringaitiene¹, M. Serpytis¹, I. Lisauskiene⁴, J. Sipylaite¹

¹Clinic of Anaesthesiology and Intensive Care, Institute of Clinical Medicine, Faculty of Medicine, Vilnius University, Vilnius, Lithuania;

²Faculty of medicine, Vilnius University, Vilnius, Lithuania; ³Clinic of Gastroenterology, Nephro-Urology and Surgery, Institute of Clinical

Medicine, Faculty of Medicine of Vilnius University, Vilnius, Lithuania;

⁴Clinic of Anaesthesiology and Intensive Care, Institute of Clinical Medicine, Faculty of Medicine of Vilnius University, Vilnius, Lithuania

Correspondence: V. Vicka

Intensive Care Medicine Experimental 2023, **11(Suppl 1)**:000684

Introduction: For patients undergoing continuous renal replacement therapy (CRRT) amino acid metabolism is dysregulated, favouring the decrease of amino acid concentration, and promoting negative nitrogen balance. This leads to protein wasting and worse clinical outcomes. For patients undergoing continuous renal replacement therapy (CRRT) amino acid metabolism is dysregulated, favouring the decrease of amino acid concentration, and promoting negative nitrogen balance. This leads to protein wasting and worse clinical outcomes.

Objectives: The aim of this study was to describe the determinants of amino acid concentrations during the 1st and the 3rd day of CRRT.

Methods: This was a prospective study of patients who were admitted to a tertiary referral university hospital ICU. Inclusion criteria were as follows: start of continuous renal replacement therapy (CRRT), mechanical ventilation and compatible with either SEPSIS-3 or SIRS criteria. The patients were evaluated on the 1st and the 3rd day of CRRT. Amino acid (AA) concentration was measured in the systemic circulation with calorimetric assay kit (mmol/l). Possible determinants of amino acid concentration were collected: fat free mass index (FFMI) as a marker of protein storage (kg/m²), AA loss during CRRT (g/day), SOFA score for disease severity and amount of prescribed daily protein (g/kg). (1) Univariate and multivariate regression analysis for the 1st and 3rd day was conducted.

Results: 60 high mortality risk patients (APACHE II of 22.98 ± 7.87, SOFA score of 12.25 ± 3.61) were included during the period of the study. The AA concentrations for the 1st day were 2.14 ± 1.01 (mmol/l), for the 3rd day were 3.14 ± 2.36 (mmol/l), with a significant increase toward the 3rd day (p = 0.011). In the univariate regression analysis of 1st day AA concentration determinants, the results were as follows: for FFMI (R = 0.313, Beta = 0.084, P = 0.02), for AA loss (R = 0.686, Beta = 0.087, P < 0.001), for SOFA (R = 0.315, Beta = -0.087, P = 0.016), for daily protein intake (n.s. p = 0.51); in the multivariate regression analysis only the amino acid loss during CRRT prevailed (R = 0.672, Beta = 0.068, P < 0.001). In the univariate regression analysis of 3rd day AA concentration determinants, the results were as follows: for FFMI (n.s. p = 0.468), for AA loss (R = 0.578, Beta = 0.075, P < 0.001), for SOFA (n.s. p = 0.329), for daily protein intake (R = 0.427, Beta = 2.098, P = 0.013); in the multivariate regression analysis both the amino acid loss during CRRT (R = 0.771, Beta = 0.071, P < 0.001) and daily protein intake (R = 0.771, Beta = 2.226, P < 0.08) prevailed.

Conclusions: Amino acid concentrations are low in ICU population on CRRT. The most important determinant of low amino acid concentration is loss through the haemofilter. During the 1st day of CRRT the reserves and the severity of the disease are also effectual, towards the 3rd day the protein load starts to be more impactful.

References

1. Comprehensive metabolic amino acid flux analysis in critically ill patients Deutz, Nicolaas E.P. et al. *Clinical Nutrition*, Volume 40, Issue 5, 2876 – 2897, 2021.
2. Research Council of Lithuania. Biosensor Platform for Fast, Cheap and Accurate Quantification of Amino Acids in Patients Undergoing Renal Replacement Therapy (DIALSENS) (No. 01.2.2-LMT-K-718-01-0019)

Topic: Metabolism, endocrinology, liver failure and nutrition

000685

Anti-inflammatory activities of the leukotriene modifiers montelukast and zileuton in acute pulmonary inflammation

A. Biedritzky¹, Y. Zhang¹, A. Fuhr¹, J. Gamper-Tsigaras¹, K. C. Ngamsri¹, F. Konrad¹

¹Klinik für Anästhesiologie und Intensivmedizin, Tübingen University Hospital, Tübingen, Germany

Correspondence: A. Biedritzky

Intensive Care Medicine Experimental 2023, **11(Suppl 1)**:000685

Introduction: The leukotriene receptor antagonist montelukast and the lipoxygenase inhibitor zileuton have been successfully used in the USA in patients with chronic pulmonary diseases, e.g. asthma. In addition, both agents have been associated with protective effects in other inflammatory conditions, such as inflammatory liver disease, arteriosclerosis and rheumatoid arthritis [1–3]. Since the pathophysiology of the Acute Respiratory Distress Syndrome (ARDS) is rather complex and still insufficiently understood, we tested the leukotriene modifiers montelukast and zileuton regarding potential anti-inflammatory effects in this setting. An uncontrolled infiltration of polymorphonuclear neutrophils (PMNs) into the lung is the main hallmark of ARDS. Thereby, the activation of platelets and the formation of platelet-neutrophil-conjugates (PNCs) play a crucial role in acute pulmonary inflammation. The enzyme lipoxygenase and the leukotriene receptor do have a distinct role in inflammation. However, the effects of leukotriene modifiers in acute pulmonary inflammation and the underlying mechanisms remain unclear.

Objectives: Our systematic investigations in acute pulmonary inflammation will provide new insights in the potential use of montelukast and zileuton for ARDS on intensive care units.

Methods: Acute pulmonary inflammation was induced by lipopolysaccharide (LPS)-inhalation in C57BL/6 mice. Montelukast and zileuton were injected intraperitoneally with a dose of 0.1 µg/µl at 1 µg/g body weight 1 h after LPS inhalation, highlighting the clinical impact of the presented study.

Results: Montelukast and zileuton decreased the LPS-induced PMN-infiltration into all different compartments of the lung (intravascular, interstitial and intra-alveolar) by reduced expression of the involved adhesion molecules and chemokines. Levels of TNF-α, IL6 and CXCL2/3 were diminished by both leukotriene modifiers. Supporting our statement, the corresponding transcription factors ERK1/2 and pCREB were also suppressed on PMNs, lung endothelium and epithelium. Caspase-1 protein expression was decreased in response to both drugs, influencing cleavage and therefore activation of proinflammatory interleukins. Furthermore, our data revealed that both agents inhibited the release of mature PMNs from the bone marrow into the blood, which is a critical step regarding the following PMN-infiltration into the lung. The formation of PNCs, which contributes to an increased neutrophil adhesion and transmigration, was blocked by montelukast and zileuton. Thereby, platelet activation was inhibited by the reduced expression of Txbas1 and P2Y12. To confirm the effects of both modifiers, we examined the expression of leukotriene pathway-related genes. Alox5, CysLTR1, CysLTR2, LTA4H, LTC4S and LTB4R1 were reduced in lung tissue by both modifiers.

Conclusions: Our study revealed formerly unknown anti-inflammatory effects of montelukast and zileuton in LPS-induced lung injury in mice, leading to promising clinical investigations.

References

- [3] Ee, M. T., Kantores, C., Ivanovska, J., Wong, M. J., Jain, A., and Jankov, R. P. (2016) Leukotriene B4 mediates macrophage influx and pulmonary hypertension in bleomycin-induced chronic neonatal lung injury. *Am J Physiol Lung Cell Mol Physiol* 311, L292-302
- [2] Martinez-Clemente, M., Ferre, N., Gonzalez-Periz, A., Lopez-Parra, M., Horrillo, R., Titos, E., Moran-Salvador, E., Miquel, R., Arroyo, V., Funk, C. D., and Claria, J. (2010) 5-lipoxygenase deficiency reduces hepatic inflammation and tumor necrosis factor alpha-induced hepatocyte damage in hyperlipidemia-prone ApoE-null mice. *Hepatology* 51, 817–827
- [1] Fredman, G., Hellmann, J., Proto, J. D., Kuriakose, G., Colas, R. A., Dorweiler, B., Connolly, E. S., Solomon, R., Jones, D. M., Heyer, E. J., Spite, M., and Tabas, I. (2016) An imbalance between specialized pro-resolving lipid mediators and pro-inflammatory leukotrienes promotes instability of atherosclerotic plaques. *Nat Commun* 7, 12859
- DFG KO 4280/4-1

Topic: Acute respiratory failure and mechanical ventilation

000687

Multidrug-resistant bacteria and antibiotic use in our Intensive Care Unit

D. Fuentes Scott¹, V. Losada Martínez¹, N. Cruza Leganés¹, F. Arbol Linde¹, B. Garcia Esteban², L. Diez Izquierdo³, A. M. Biurrún Larralde³, M. A. Taberna Izquierdo¹, E. Alvarez Fernandez¹

¹Intensive Care Unit, University General Hospital Nuestra Señora del Prado, Talavera de la Reina, Spain; ²Hospital Pharmacy, University General Hospital Nuestra Señora del Prado, Talavera de la Reina, Spain; ³Preventive Medicine, University General Hospital Nuestra Señora del Prado, Talavera de la Reina, Spain

Correspondence: D. Fuentes Scott

Intensive Care Medicine Experimental 2023, **11(Suppl 1)**:000687

Introduction: Presence of multidrug-resistant bacteria (MRD-B) gain importance in our Intensive Care Unit (ICU) and it's necessary to know which MRD-B are rising and monitoring the consumptions of antibiotics. Knowledge about our MRD-B also helps to decide the best initial empiric antibiotic therapy, as it's shown in antibiotic consumption.

Objectives: The main objective of our study is to analyze MRD-B isolations in patients admitted to our ICU (a polyvalent ICU with 12 beds, extended to 24 beds during COVID-19 pandemic period) and to observe which were the antibiotics we mostly used in a defined period of time. We considered MRD-B imipenem resistant *Acinetobacter baumannii* (IRAB), methicillin-resistant *Staphylococcus aureus* (MRSA), extended spectrum beta-lactamase-producing *Klebsiella pneumoniae* (ESBL-KP), multiresistant *Pseudomonas* (MR-P), vancomycin-resistant *Enterococcus* (VRE) and carbapenem-resistant *Enterobacteriaceae* (CRE).

Methods: Retrospective descriptive observational analysis of MRD-B isolation and the use of antimicrobials in patients admitted in our ICU from January 1st, 2021 to December 29th, 2022. Microbiological isolation obtained from oropharyngeal and rectal exudates and clinical samples. Antibiotic consumption is expressed in defined daily dose (DDD): consumption (gr) × 100/DDD-WHO × stays, related to 100 stays.

Results: During the study period we had a total of 928 patients admitted in our ICU (420 in 2021 and 508 in 2022). MRD-B isolations were 892, 648 in 2021 and 242 in 2022. Most frequent MRD-B in 2021 were IRAB 374 (41,92%) that was an outbreak without any isolation in 2022, MR-P 134 (20,67%), ESBL-KP 67 (10,33%), CRE 41 (6,32%), MRSA 31 (4,78%) and VRE 1 (0,15%). In 2022, MRSA 113 (46,31%), MR-P 57 (23,36%), ESBL-KP 49 (20,08%), CRE 25 (8,19%) and VRE 0. Total antibiotic consumption in this two years were similar between them, in 2021 antibiotic consumption was 199, 13 and in 2022 was 192,49. Both years the main antibiotic used was Meropenem, with 41, 69 DDD/100 stays in 2021 and 40,26 in 2022. In 2nd place, Linezolid with 27,57 DDD/100 stays in 2021 and 27,03 in 2022. In 2021, Tigecycline ranked 3rd according to the increase of IRAB outbreak (23,52). Same year, the 4th antibiotic was represented by Ceftriaxone (21,44), followed by Levofloxacin (19,53). In 2022, the 3rd mostly used antibiotic was Levofloxacin (20,39), followed by Daptomycin (14,26) and Amoxicillin-clavulanic acid (10,3).

Conclusions: In 2021, we had more MRD-B isolations than 2022, even with similar number of admissions and similar antibiotic consumption. In 2021, we had an increased presence of IRAB due to an outbreak and this made Tigecycline gain importance in this period. Excluding this special situation, most frequent MRD-B were MR-P, ESBL-KP and MRSA. The most used antibiotic were Meropenem in 1st place followed by Linezolid.

Topic: Infections and prevention

000690

Characteristics and outcomes of auto-intoxicated patients admitted to the ICU: a retrospective cohort study

F. Polfliet¹

¹Anaesthesiology, Jessa Ziekenhuis, campus Salvator, Hasselt, Belgium

Correspondence: F. Polfliet

Intensive Care Medicine Experimental 2023, **11(Suppl 1)**:000690

Introduction: Auto-intoxications are responsible for a large number of Intensive care unit (ICU) admissions (1). Literature focusing on characteristics and outcomes of ICU-admitted auto-intoxicated patients is limited.

Objectives: We aimed to describe the characteristics and outcomes of these patients and to calculate the percentage of ICU admissions attributable to auto-intoxications.

Methods: In this retrospective cohort study, all patients admitted to the ICU of JESSA hospital, Hasselt, Belgium with a diagnosis of auto-intoxication between January 1th 2017 and December 31th 2022, were included in the study. We collected data on patient characteristics, comorbidities, type of intoxication and outcomes including the length of ICU and hospital stay and mortality.

Results: In total, 374 patients were included in the dataset, covering 2.66% of all ICU admissions from 2017 to 2022. Baseline characteristics are presented in Table 1. Almost 25% of included patients had a history of previous suicide attempt and more than 40% of previous auto-intoxication. More than 70% of included patients tried to commit suicide versus almost 20% recreational abusers. Toxicological results revealed abuse of more than 1 substance in almost 55% of cases. Outcomes are presented in Table 2. ICU- and hospital mortality were 1.6% and 0.8% respectively. Total mortality at time of dataset closure was 7.2%.

Conclusions: The impact of auto-intoxication on ICU resource utilisation is quite high and the risk of recidivism is substantial. ICU- and in-hospital mortality after auto-intoxication is low but these patients have a substantial risk for death following hospital discharge.

Table 1

	Intoxicated patients ICU n=374
Age (years)	38.00 (26.00, 53.00)
Gender (male/female)	162 (43.3%) / 212 (56.7%)
BMI (kg/m ²)	24.22 (22.09, 26.36)
Comorbidities	
Chronic Liver Disease	31 (8.3%)
Chronic Kidney Disease	5 (1.3%)
Chronic Lung Disease	18 (4.8%)
Cardiovascular Disease	22 (5.9%)
CVA	8 (2.1%)
Dysrhythmia	5 (1.3%)
Gastrointestinal Disease	9 (2.4%)
Malignancies	16 (4.3%)
Chronic Pain	48 (12.8%)
Gastric bypass	23 (6.1%)
Diabetes	28 (7.5%)
Cognitive impairment	8 (2.1%)
Obesity	38 (10.2%)
Psychiatric disorder	
- Psychoses	12 (3.3%)
- Personality disorder	49 (13.4%)
- Depression	90 (24.7%)
- Combination	9 (2.4%)
- Unknown	8 (2.1%)
Previous suicide attempt (yes/unknown)	93 (24.9%) / 1 (0.3%)
Previous intoxication	153 (40.9%)
Smoking	57 (15.2%) / 7 (1.9%)
Alcoholism	77 (20.6%)
Prisoner	10 (2.7%)
Home medication (yes/unknown)	281 (75.1%) / 17 (4.5%)
Type of intoxication	
- Suicide attempt	265 (70.9%)
- Accidental	15 (4.0%)
- Iatrogenic	21 (5.6%)
- Recreational	73 (19.5%)

Topic: Poisoning/Toxicology/Pharmacology

000691

The impact of continuous quality improvement on sleep distortion in critical patients

P. T. Chu¹, L. Ya-Mei², C. Hsing-Chi², F. Shih-Fang², H. Sheng-Huei², H. Ming-Shiuan², C. Kang-Pan², H. Wei-Chun¹

¹Department of Critical Care Medicine, Kaohsiung Veterans General Hospital, Kaohsiung City, Taiwan; ²Department of Nursing, Kaohsiung Veterans General Hospital, Kaohsiung City, Taiwan

Correspondence: P. T. Chu

Intensive Care Medicine Experimental 2023, **11(Suppl 1)**:000691

Introduction: Intensive care unit patients were shown to have poor quality of sleep over the last three decades. However, to improve the sleep distortion in critical patients remains challenging.

Objectives: The aim of this study is to investigate the impact of continuous quality improvement on sleep distortion in critical patients.

Methods: All consecutive patients from 2019 to 2021 in adult ICU were enrolled. The key interventions include novel sacral suspended decompression recumbent care, simple air pressure turning device, remote warning care system and using big data to monitor critical care warning indicators. The patients were divided into three periods: pre-intervention period from Jan to Dec 2019, intervention period from Jan to Dec 2020, and post-intervention period from Jan to Dec 2021.

Results: The sleep assessment ratio improved from 49.0% in the pre-intervention period, to 67.5% in intervention period and to 95.1% in post-interventional period ($p < 0.0001$). The good quality sleep ratio improved from 70.4% in the pre-intervention period, to 74.2% in intervention period and to 87.8% in post-interventional period ($p < 0.0001$). Average ICU stay decreases from 7.9 days to 6.9 days after intervention ($p < 0.05$). The incidence of ventilator-associated pneumonia decreased from 0.7% to 0.4% ($p < 0.05$). The mortality decreased from 7.6% to 5.2% ($p < 0.05$).

Conclusions: The study showed that implementation of continuous quality improvement using novel critical care system could increase sleep assessment ratio and good quality sleep ratio, and reduce the average ICU stay. Furthermore, the incidence of ventilator-associated pneumonia and mortality also improved.

References

1. Bijwadia JS, Ejaz MS. Sleep and critical care. *Curr Opin Crit Care*. 2009 Feb;15(1):25-9. <https://doi.org/10.1097/MCC.0b013e3283220dc7>.

Topic: Acute respiratory failure and mechanical ventilation

000692

Improvements in functional outcome and health-related quality of life between 3 and 12 months in survivors of critical COVID-19

I. Didriksson¹, A. Frigyesi², M. Spångfors³, M. Leffler⁴, A. Lybeck⁵, M. Annborn⁶, A. Reepalu¹, A. Nilsson⁷, H. Friberg⁸, G. Lilja⁸

¹Department of Anesthesia and Intensive Care Medicine, Skånes universitetssjukhus Malmö, Malmö, Sweden; ²Department of Intensive and Perioperative Care, Skånes universitetssjukhus Lund, Lund, Sweden; ³Department of Anaesthesia and Intensive Care, Kristianstad Hospital, Kristianstad, Sweden; ⁴Department of Anesthesia and Intensive Care Medicine, Skånes universitetssjukhus Malmö, Lund, Sweden; ⁵Department of Clinical Sciences, Intensive and Perioperative Care, Lund University, Lund, Sweden; ⁶Department of Anaesthesia and Intensive Care, Helsingborgs hospital, Helsingborg, Sweden; ⁷Department of Infectious Diseases, Skånes universitetssjukhus Malmö, Malmö, Sweden; ⁸Department of Clinical Sciences Lund, Neurology, Lund University, Lund, Sweden

Correspondence: I. Didriksson

Intensive Care Medicine Experimental 2023, **11(Suppl 1)**:000692

Introduction: Long-term functional outcomes after critical COVID-19 are not sufficiently studied.

Objectives: The aim of this study was to describe functional outcome and health-related quality of life (HRQoL) at 3 and 12 months in a cohort of critically ill COVID-19 survivors and to investigate factors associated with good functional outcome and HRQoL at 12 months.

Methods: This prospective multicentre cohort study included critically ill COVID-19 patients admitted to six intensive care units in Sweden between May 2020 and May 2021. Surviving patients were invited to a follow-up at three and 12 months. A good functional outcome was defined as a Glasgow Outcome Scale Extended > 6. HRQoL was assessed by the Short Form-36 item Questionnaire Health Survey version 2® (SF-36v2®). Factors associated with good functional outcome and HRQoL at 12 months were explored by multivariable logistic regression.

Results: Good functional outcome was found in 93/264 (35%) survivors at 3 months and in 138/217 (64%) at 12 months (p<0.001). There was a significant improvement in the physical component summary of the SF-36.v2® between 3 and 12 months (mean 40.2 versus 43.8, p<0.001). The SF-36.v2® mental component summary was within the normal range at three months, with no significant difference at 12 months (mean 46.5 versus 48.4, p=0.051). Age ≤ 65, shorter time on mechanical ventilation and a higher level of education were associated with good functional outcome at 12 months. Low clinical frailty and shorter time on mechanical ventilation were associated with a better physical HRQoL.

Conclusions: A significant improvement in functional outcome and physical aspects of HRQoL was seen between 3 and 12 months, indicating continued recovery up to at least one year after critical COVID-19. Younger age, lower clinical frailty and shorter time on mechanical ventilation were associated with better long-term outcome.

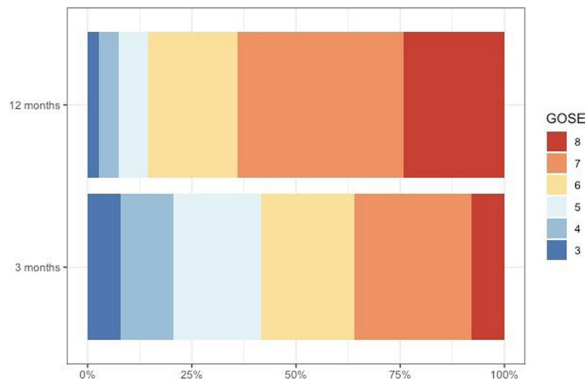

Figure 1 (abstract 000692) Functional outcome measured by Glasgow Outcome Scale-Extended in 217 survivors at 3 and 12 months post critical COVID-19

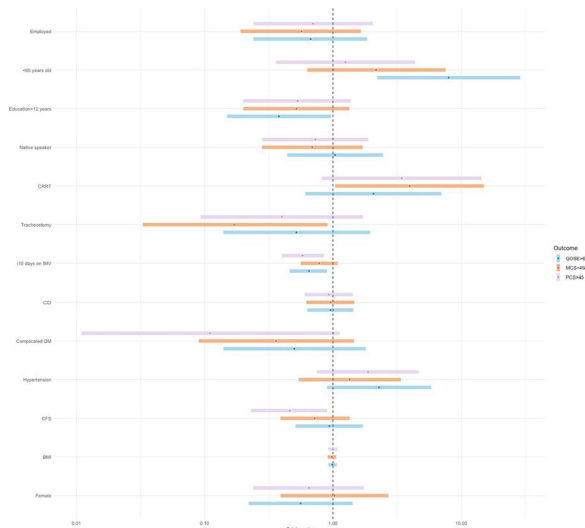

Figure 2 (abstract 000692) Forest plot of good functional outcome GOSE>6 at 12 months (light blue), good mental HRQoL (mental

component Summary>45 in SF36v2) at 12 months (orange), and good physical HRQoL (Physical component Summary>45 in SF36v2) (purple) at 12 months. Model based on information on admission and during intensive care stay, with a p-value < 0.1 in the univariate analysis. Demonstrating adjusted/multivariable odds ratio with a 95% CI (demographics, comorbidities, acute physiology, ICU treatments)

References

1. Pettrilli CM, Jones SA, Yang J, Rajagopalan H, O'Donnell L, Chernyak Y, et al. Factors associated with hospital admission and critical illness among 5279 people with coronavirus disease 2019 in New York City: prospective cohort study. *BMJ*. 2020;369:m1966.
2. Ferguson ND, Fan E, Camporota L, Antonelli M, Anzueto A, Beale R, et al. The Berlin definition of ARDS: an expanded rationale, justification, and supplementary material. *Intensive Care Med*. 2012;38(10):1573–82.
3. Cummings MJ, Baldwin MR, Abrams D, Jacobson SD, Meyer BJ, Balough EM, et al. Epidemiology, clinical course, and outcomes of critically ill adults with COVID-19 in New York City: a prospective cohort study. *Lancet*. 2020;395(10239):1763–70.
4. Desai SV, Law TJ, Needham DM. Long-term complications of critical care. *Crit Care Med*. 2011;39(2):371–9.
5. Yanagi N, Kamiya K, Hamazaki N, Matsuzawa R, Nozaki K, Ichikawa T, et al. Post-intensive care syndrome as a predictor of mortality in patients with critical illness: A cohort study. *PLoS One*. 2021;16(3):e0244564.
6. Michelen M, Manoharan L, Elkheir N, Cheng V, Dagens A, Hastie C, et al. Characterising long COVID: a living systematic review. *BMJ Glob Health*. 2021;6(9).
7. Hatakeyama J, Inoue S, Liu K, Yamakawa K, Nishida T, Ohshimo S, et al. Prevalence and Risk Factor Analysis of Post-Intensive Care Syndrome in Patients with COVID-19 Requiring Mechanical Ventilation: A Multicenter Prospective Observational Study. *J Clin Med*. 2022;11(19).
8. Armstrong RA, Kane AD, Kursumovic E, Oglesby FC, Cook TM. Mortality in patients admitted to intensive care with COVID-19: an updated systematic review and meta-analysis of observational studies. *Anaesthesia*. 2021;76(4):537–48.
9. Grasselli G, Greco M, Zanella A, Albano G, Antonelli M, Bellani G, et al. Risk Factors Associated With Mortality Among Patients With COVID-19 in Intensive Care Units in Lombardy, Italy. *JAMA Intern Med*. 2020;180(10):1345–55.
10. Evans RA, McAuley H, Harrison EM, Shikotra A, Singapuri A, Sereno M, et al. Physical, cognitive, and mental health impacts of COVID-19 after hospitalisation (PHOSP-COVID): a UK multicentre, prospective cohort study. *Lancet Respir Med*. 2021;9(11):1275–87.
11. Heesakkers H, van der Hoeven JG, Corsten S, Janssen I, Ewalds E, Simons KS, et al. Clinical Outcomes Among Patients With 1-Year Survival Following Intensive Care Unit Treatment for COVID-19. *Jama*. 2022;327(6):559–65.
12. Huang L, Yao Q, Gu X, Wang Q, Ren L, Wang Y, et al. 1-year outcomes in hospital survivors with COVID-19: a longitudinal cohort study. *Lancet*. 2021;398(10302):747–58.
13. Rosa RG, Cavalcanti AB, Azevedo LCP, Veiga VC, de Souza D, dos Santos RdRM, et al. Association between acute disease severity and one-year quality of life among post-hospitalisation COVID-19 patients: Coalition VII prospective cohort study. *Intensive Care Medicine*. 2023.
14. Didriksson I, Leffler M, Spångfors M, Lindberg S, Reepalu A, Nilsson A, et al. Intensive care unit burden is associated with increased mortality in critically ill COVID-19 patients. *Acta Anaesthesiol Scand*. 2022.
15. von Elm E, Altman DG, Egger M, Pocock SJ, Gøtzsche PC, Vandenbroucke JP. The Strengthening of Reporting of Observational Studies in Epidemiology (STROBE) statement: guidelines for reporting observational studies. *J Clin Epidemiol*. 2008;61(4):344–9.
16. McMillan T, Wilson L, Ponsford J, Levin H, Teasdale G, Bond M. The Glasgow Outcome Scale—40 years of application and refinement. *Nat Rev Neurol*. 2016;12(8):477–85.
17. Wilson JT, Pettigrew LE, Teasdale GM. Structured interviews for the Glasgow Outcome Scale and the extended Glasgow Outcome Scale: guidelines for their use. *J Neurotrauma*. 1998;15(8):573–85.
18. Lijja G, Nielsen N, Ullén S, Blennow Nordstrom E, Dankiewicz J, Friberg H, et al. Protocol for outcome reporting and follow-up in the Targeted Hypothermia versus Targeted Normothermia after Out-of-Hospital Cardiac Arrest trial (TTM2). *Resuscitation*. 2020;150:104–12.
19. Ware JE, Jr., Gandek B. Overview of the SF-36 Health Survey and the International Quality of Life Assessment (IQOLA) Project. *J Clin Epidemiol*. 1998;51(11):903–12.
20. Needham DM, Sepulveda KA, Dinglas VD, Chessare CM, Friedman LA, Bingham CO, 3rd, et al. Core Outcome Measures for Clinical Research in Acute Respiratory Failure Survivors. An International Modified Delphi Consensus Study. *Am*

J Respir Crit Care Med. 2017;196(9):1122–30. 21. Taft C, Karlsson J, Sullivan M. Performance of the Swedish SF-36 version 2.0. Qual Life Res. 2004;13(1):251–6. 22. Soto M, Failde I, Márquez S, Benítez E, Ramos I, Barba A, et al. Physical and mental component summaries score of the SF-36 in coronary patients. Qual Life Res. 2005;14(3):759–68. 23. Mark E, Maruish P. User's manual for the SF-36v2 Health survey Third edition. QualityMetric Incorporated 2011. 24. World values survey 2023 <https://www.oecdbetterlifeindex.org/countries/sweden/>. 25. Better life index: OECD; 2022 <https://www.oecdbetterlifeindex.org/countries/sweden/>. 26. Rockwood K, Song X, MacKnight C, Bergman H, Hogan DB, McDowell I, et al. A global clinical measure of fitness and frailty in elderly people. Cmaj. 2005;173(5):489–95. 27. Quan H, Li B, Couris CM, Fushimi K, Graham P, Hider P, et al. Updating and validating the Charlson comorbidity index and score for risk adjustment in hospital discharge abstracts using data from 6 countries. Am J Epidemiol. 2011;173(6):676–82. 28. Careno L, Protti A, Dalla Corte F, Aceto R, Iapichino G, Milani A, et al. Short-term health-related quality of life, physical function and psychological consequences of severe COVID-19. Ann Intensive Care. 2021;11(1):91. 29. Gamberini L, Mazzoli CA, Prediletto I, Sintonen H, Scaramuzza G, Allegri D, et al. Health-related quality of life profiles, trajectories, persistent symptoms and pulmonary function one year after ICU discharge in invasively ventilated COVID-19 patients, a prospective follow-up study. Respir Med. 2021;189:106665. 30. Hopkins RO, Weaver LK, Collingridge D, Parkinson RB, Chan KJ, Orme JF, Jr. Two-year cognitive, emotional, and quality-of-life outcomes in acute respiratory distress syndrome. Am J Respir Crit Care Med. 2005;171(4):340–7. 31. Herridge MS, Cheung AM, Tansey CM, Matte-Martyn A, Diaz-Granados N, Al-Saidi F, et al. One-year outcomes in survivors of the acute respiratory distress syndrome. N Engl J Med. 2003;348(8):683–93. 32. Dowdy DW, Eid MP, Dennison CR, Mendez-Tellez PA, Herridge MS, Guallar E, et al. Quality of life after acute respiratory distress syndrome: a meta-analysis. Intensive Care Med. 2006;32(8):1115–24. 33. Brown SM, Wilson E, Presson AP, Zhang C, Dinglas VD, Greene T, et al. Predictors of 6-month health utility outcomes in survivors of acute respiratory distress syndrome. Thorax. 2017;72(4):311–7. 34. Baldwin MR, Anesi GL. Post-Intensive Care Syndrome in COVID-19 versus Non-COVID-19 Critical Illness Survivors: More Similar than Not? Am J Respir Crit Care Med. 2022;205(10):1133–5. 35. Hodgson CL, Higgins AM, Bailey MJ, Mather AM, Beach L, Bellomo R, et al. Comparison of 6-Month Outcomes of Survivors of COVID-19 versus Non-COVID-19 Critical Illness. Am J Respir Crit Care Med. 2022;205(10):1159–68. 36. Weidman K, LaFond E, Hoffman KL, Goyal P, Parkhurst CN, Derry-Vick H, et al. Post-Intensive Care Unit Syndrome in a Cohort of COVID-19 Survivors in New York City. Ann Am Thorac Soc. 2022;19(7):1158–68. 37. Quan D, Luna Wong L, Shallal A, Madan R, Hamdan A, Ahdi H, et al. Impact of Race and Socioeconomic Status on Outcomes in Patients Hospitalized with COVID-19. J Gen Intern Med. 2021;36(5):1302–9. 38. Little C, Alsen M, Barlow J, Naymagon L, Tremblay D, Genden E, et al. The Impact of Socioeconomic Status on the Clinical Outcomes of COVID-19: a Retrospective Cohort Study. J Community Health. 2021;46(4):794–802. 39. SCB. utbildning-jobb-och-pengar/ utbildningsnivån i Sverige 2023 [Available from: <https://www.scb.se/hitta-statistik/sverige-i-siffror/utbildning-jobb-och-pengar/utbildning-snivan-i-sverige/>]. 40. Khanijahani A, Iezadi S, Gholipour K, Azami-Aghdasi S, Naghibi D. A systematic review of racial/ethnic and socioeconomic disparities in COVID-19. Int J Equity Health. 2021;20(1):248. 41. Careno L, Dalla Corte F, Haines RW, Palandri C, Milani A, Aghemo A, et al. Return to Work After Coronavirus Disease 2019 Acute Respiratory Distress Syndrome and Intensive Care Admission: Prospective, Case Series at 6 Months From Hospital Discharge. Crit Care Med. 2021;49(11):e1157–e62. 42. Dodoo-Schittko F, Brandstetter S, Blecha S, Thomann-Hackner K, Brandl M, Knüttel H, et al. Determinants of Quality of Life and Return to Work Following Acute Respiratory Distress Syndrome. Dtsch Arztebl Int. 2017;114(7):103–9. 43. SCB. More than 5 million gainfully employed people in 2019 2020 [Available from: <https://www.scb.se/en/finding-statistics/statistics-by-subject-area/labour-market/employment-and-working-hours/labour-statistics-based-on-administrative-sources/pong/statistical-news/labour-statistics-based-on-administrative-sources-rams-and-gross-pay-statistics-based-on-administrative-sources-lsum-2019/>]. 44. NICE. Rehabilitation after critical illness in adults 2009 [Available from: <https://www.nice.org.uk/guidance/cg83>]. 45. Herridge MS, Azoulay É. Outcomes after Critical Illness. N Engl J Med. 2023;388(10):913–24.

- AF was supported by governmental funding of clinical research within the Swedish national health service, 2019:YF0053. HF was supported by the Swedish national health service (ALF), Regional funding from Region Skåne, the Swedish Heart–lung foundation (grant nr 21004021 and 21023322).

Topic: Infections and prevention

000693

Mechanical ventilation affects reliability of pulmonary artery pressure waveform based methods to estimate right ventricle stroke volume

A. Santos¹, M. I. Monge García², J. B. Borges³, J. Retamal⁴, G. Tusman⁵, A. Larsson⁶, F. Suarez Sipmann⁷

¹Intensive Care Medicine Department, Hospital Universitario Fundación Jiménez Díaz, IIS-FJD, Madrid, Spain; ²University Hospital of Jerez, Intensive Care Unit, Jerez, Spain; ³Institute of Physiology, Charles University, 1st Medical Faculty, Prague, Czech Republic; ⁴Departamento de medicina intensiva, Pontificia Universidad Católica de Chile, Santiago, Chile; ⁵Anesthesiology, Community Private Hospital, Mar del Plata, Argentina; ⁶Surgical sciences department, Hedenstierna Laboratory, Uppsala University, Uppsala, Sweden; ⁷Icu, Hospital de La Princesa, Madrid, Spain

Correspondence: A. Santos

Intensive Care Medicine Experimental 2023, **11(Suppl 1)**:000693

Introduction: Analysis of the arterial pressure waveform allows to estimate left ventricle stroke volume (SV). This approach can also be applied for estimation of right ventricle SV (RV-SV) but is less extended in clinical settings. Intrathoracic pressure changes resulting from mechanical ventilation could affect pulmonary artery (PA) pressure waveform (PAPW) and, in consequence, decrease the reliability of its use to estimate RV-SV.

Objectives: To evaluate if correcting the effect of mechanical ventilation on PAPW increases correlation between parameters used to estimate SV and the measured RV-SV.

Methods: Continuous PA pressure and flow were measured simultaneously during two minutes in 5 pigs using a high fidelity microtip catheter and a transonic flow sensor placed at the PA trunk, before and after being subjected to an experimental ARDS model. Animals were ventilated in a volume controlled mode with a PEEP 8 cmH₂O, tidal volume 6 ml/kg, inspiratory/expiratory ratio 1:2, FIO₂ 1 and respiratory rate adjusted to keep an end-tidal CO₂ around 45 mmHg. Validated parameters to estimate SV such as pulse pressure (PP), systolic area (SA) and standard deviation (SD) were calculated beat by beat from the PAPW while actual RV-SV was obtained from the PA flow signal. The effect of mechanical ventilation was estimated by creating an artificial continuous signal based on the beat by beat diastolic PA pressure and the relative time position of cardiac beats in the respiratory cycle. This signal was subtracted from the PA pressure signal (Fig 1) and then, corrected PAPW parameters were calculated (cPP, cSA, cSD). Correlation between beat by beat PAPW parameters before and after correction and beat by beat measured RV-SV during the two minutes analysis time was calculated. Two-way ANOVA for repeated measurements was applied to assess whether corrected measurements have a different correlation than uncorrected measurements in the two evaluated conditions.

Results: Driving pressure increased after ARDS, 7 [5–8] cmH₂O vs 19 [19–22] cmH₂O, p=0.04. Before ARDS rho between measured RV-SV and uncorrected parameters was: 0.86±0.70 vs PP, –0.11±0.34 vs SD and 0.54±0.14 vs SA while for corrected parameters was: 0.88±0.09 vs cPP, 0.88±0.13 vs cSD and 0.92±0.05 vs cSA. After ARDS rho between measured RV-SV and uncorrected parameters was: 0.75±0.08 vs PP, –0.03±0.26 vs SD and 0.48±0.11 vs SA while for corrected parameters was: 0.85±0.05 vs cPP, 0.84±0.08 vs cSD and 0.93±0.03 vs cSA. A p<0.05 was found for the effect of correction in the correlation between measured RV-SV and standard deviation and between measure RV-SV and systolic area.

Conclusions: The effect of mechanical ventilation affected the correlation between RV-SV and the PAPW parameters used for its estimation. In our dataset, this was significant for the standard deviation and the systolic area. These results could be relevant for the bedside implementation of methods to estimate right ventricle SV from PA pressure.

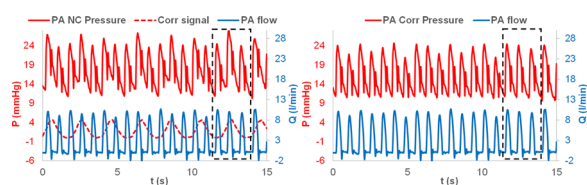

Figure 1 (abstract 000693) Example of the PA pressure before (PA NC Pressure, left) and after correction (PA Corr Pressure, right). A better coherence between pressure and flow amplitudes is seen after the correction (dashed rectangle). Corr signal (dashed red line, left) is the signal used to correct for the effect of mechanical ventilation and is in phase with the airway pressure

References

1. ESICM Professor Burkhard Lachmann Award for Experimental Research 2022. ESICM ECCRN Basic Sciences Award 2012

Topic: Cardiovascular issues in ICU

000694

Inhaled sedation in COVID-19 acute respiratory distress syndrome: an observational study with a propensity score matching model

I. Cappellini¹, L. Zamidei¹, B. Freschi¹, L. Campiglia¹, G. Consales¹
¹Emergency And Critical Care Medicine, Ospedale Santo Stefano, Prato, Italy

Correspondence: I. Cappellini

Intensive Care Medicine Experimental 2023, **11(Suppl 1)**:000694

Introduction: Patients affected by severe form of COVID-19 induced respiratory failure (C-ARDS) frequently need deep sedation in order to perform adequate ventilator support. Volatile Anesthetics (Vas) are an alternative to intravenous molecules, allowing to obtain the desired level of sedation.

Methods: This is a retrospective single-center nonprofit observational cohort study. We enrolled patients admitted for C-ARDS to the COVID Intensive Care Unit of Santo Stefano Hospital in Prato during the period March 2020-June 2021 who received to invasive mechanical ventilation. Participants were divided in two categories: those who received Sevoflurane and those sedated with intravenous drugs. A propensity score matching model (PSM) was applied to minimize the differences between the two groups. The Mann-Whitney/Wilcoxon test or *t* test was used to analyze continuous variables; for categorical variables, Fisher's exact test or chi-square test was used. Values with $p < 0,05$ were considered significant.

Results: A total of 112 patients were enrolled in the study. 56 patients who received inhaled sedation have been matched with 56 participants who received intravenous sedation by means of PSM. An adequate level of sedation was obtained in both groups. The application of the Wilcoxon test showed an improvement in P/F in the sevoflurane group compared to controls at T2 in respect to T1 (mean: T1 148.31 vs. 208.26 at T2), although this difference was not statistically significant ($p = 0,06$); on the seventh day of ventilation an improvement in the P/F ratio was observed (mean: T0 148.31 vs 182.33 in the sevoflurane group at T3 (p value = 0.10). Static compliance in the "Sevoflurane" population at three days was statistically significantly higher (mean of 42 compared to 39.95 cmH₂O/mL at T1 in the Sevoflurane group) than in the "non-Sevoflurane" population (p value = 0.02). At seven days after intubation, static compliance was improved in the "Sevoflurane" population compared to the "non-Sevoflurane" population, but the difference was not statistically significant (p value = 0.1).

Finally, a logistic regression model was applied to the paired sample, relating the *mortality* (dependent variable) to the treatment used (independent variable). The model showed estimate value of -0.9 with a p value = 0,02. The *odds ratio* is 0.40, which is a wide 95% confidence interval that does not include the value of 1 (0.18–0.87).

Conclusions: The use of sevoflurane for deep sedation of invasively ventilated CARDS patients is effective and feasible. Sevoflurane sedation induced a relevant amelioration of respiratory mechanics that may have a clinically relevant effect in C-ARDS patients.

References

1. Jabaudon M, Boucher P, Imhoff E, Chabanne R, Faure JS, Roszyk L, Thibault S, Blondonnet R, Clairefond G, Guérin R, Perbet S, Cayot S, Godet T, Pereira B, Sapin V, Bazin JE, Futier E, Constantin JM. Sevoflurane for Sedation in Acute Respiratory Distress Syndrome. A Randomized Controlled Pilot Study. *Am J Respir Crit Care Med.* 2017 Mar 15;195(6):792-800. <https://doi.org/10.1164/rccm.201604-0686OC>. PMID: 27611637.

Topic: Acute respiratory failure and mechanical ventilation

000695

Improving physical function of patients following Intensive Care Unit admission (EMPRESS): a randomised controlled feasibility trial

R. Cusack¹, I. Reading², L. Denehy³, H. Golding⁴, N. Hart⁵, A. Bates², M. Chorozioglou⁶, Z. van Willigen⁷, A. Dushianthan⁸, M. Grocott⁹

¹Critical Care, University Hospital of Southampton NHS FT, Southampton, United Kingdom; ²Facility of Medicine, University of Southampton, Southampton, United Kingdom; ³Physiotherapy, The University of Melbourne, Carlton, Australia; ⁴Critical Care Research, Southampton General Hospital, Southampton, United Kingdom; ⁵Lane Fox Unit, Guys & St Thomas Nhs Foundation Trust, London, United Kingdom; ⁶Faculty of Medicine, University of Southampton, Southampton, United Kingdom; ⁷Therapy Services, University Hospital of Southampton NHS FT, Southampton, United Kingdom; ⁸Critical Care, University Hospital Southampton NHS Foundation Trust, Southampton, United Kingdom

Correspondence: R. Cusack

Intensive Care Medicine Experimental 2023, **11(Suppl 1)**:000695

Introduction: Protocolised early rehabilitation of critically ill patients may improve long-term outcomes, however, protocolised interventions are poorly described and implementation challenging due to limited staff and resources. We conducted a feasibility study that aimed to deliver a protocolised early rehabilitation program including supine cycling, delivered by a therapy technician, compared with usual care. This study was to inform the protocol design for a future randomised control clinical trial (1).

Methods: Patients were enrolled from 3 UK mixed medical-surgical ICUs. Eligibility criteria were: unplanned medical admissions; intubated and ventilated < 72 h; expected to need continued invasive ventilation for a further 48 h, > 42 years old and functionally independent prior to ICU admission. Randomised participants (1:1) received usual care or usual care plus a protocolised early rehabilitation program consisting of 2 additional 30-min rehabilitation interventions including cycling. Feasibility outcomes included: (1) recruitment at sites; (2) protocol fidelity with > 75% of patients commencing interventions within 72 h of mechanical ventilation, with > 70% interventions delivered; (3) blinded outcome measures recorded at three time points in > 80% of patients.

Results: Recruitment took place between July 2019 and July 2022. Study delivery was impacted by COVID-19 with an interim suspension to recruitment, redeployment of research staff and hospital visiting restrictions. Of 46 patients enrolled, 20 (43%) were female, median age 60, 23 (50%) had pneumonia/COVID pneumonitis with an overall median APACHE II score of 19 (range 9–69). 20 participants received the protocolised rehabilitation. Total ICU mortality was 15/46 (33%) and 16/46 (35%) at hospital discharge and 3 months. Feasibility outcomes (1) Recruitment 0.9 patients/month/site (2) Protocol fidelity 93% patients commencing interventions within 72 h of mechanical ventilation, 70% of study interventions delivered (3) Outcome assessments were completed in 26/31 (84%), 22/26 (85%) and 16/25 (64%) of

patients at the 3 time points. Of these assessments, 12/26 (46%), 10/22 (45%), and 9/16 (56%) respectively were blinded. Interventions delivered were as per table.

	Usual care (N=22)	Usual care plus protocolise rehabilitation (N=22)		
		Usual Care therapy	Proto-colised therapy	Total therapy Intervention
Time from intubation to randomisation (hrs)	Median: 32 IQR: 18–52		Median: 23 IQR: 19–40	
Time from randomisation to first therapy intervention (hrs)	Median: 24 IQR: 16–104	Median: 23 IQR: 18–72	Median: 20 IQR: 2–24	
Total therapy intervention per day (minutes)	Median: 23 IQR: 17–35	Median: 20 IQR: 15–35	Median: 35 IQR: 20–60	Median: 48 IQR: 30–74
Total therapy intervention (minutes)	Median: 90 IQR: 70–255	Median: 105 IQR: 35–240	Median: 213 IQR: 88–313	Median: 278 IQR: 170–517

Conclusions: Although feasibility was confounded by COVID-19 restrictions our results suggest careful consideration of staffing resources, which outcome measures should be used, when these data are collected and by whom.

References

1. This work is supported by the National Institute for Health Research (NIHR) under its Research for Patient Benefit (RfPB) Programme. Grant Reference Number PB-PG-0317-20045.
2. Cusack R, Bates A, Mitchell K, et al. Improving physical function of patients following intensive care unit admission (EMPRESS): protocol of a randomised controlled feasibility trial. *BMJ Open* 2022;12:e055285. <https://doi.org/10.1136/bmjopen-2021-055285>

Topic: Nursing care and physiotherapy

000696

Early admission of oncohematologic patients to the Intensive Care Unit (ICU) improves their prognosis. Prospective observational study

I. Azkarate¹, J. Marin¹, M. Iriarte¹, I. Elosegui¹, I. Quevedo Marcos¹, B. Millan¹, M. Duran¹

¹Critical Care Unit, Donostia University Hospital, Donostia, Spain

Correspondence: J. Marin Cortajarena

Intensive Care Medicine Experimental 2023, **11(Suppl 1)**:000696

Introduction: Survival rates of oncohematologic patients have increased due to advances in diagnosis and treatment in this field. As a result, their admission to the ICU is more frequent due to disease- or management-related complications.

Objectives: To analyze whether the prognosis of oncohematologic patients improves with an earlier admission to the Intensive Care Unit (ICU).

Methods: Prospective observational study conducted over a consecutive 7-year period (1.1.2016 to 12.31.2022) in a 48-bed ICU in a tertiary level hospital, whose Hematology service is the reference for hematopoietic transplantation in the Basque Autonomous Community. Results from 2016, considered as a control year, were analyzed and a protocol for an earlier admission to the ICU was established in the following years.

Results: Over the 7-year period, a total of 197 patients were admitted to ICU (29 in 2016, 36, 19, 36, 18, 22 and 39 in successive years). Patients were predominantly male (69%, in 2016 and 62%, 58%, 53%, 53%, 72%, 77% subsequently), and there was no age difference between years (61, 63, 65, 59, 66, 63 and 60 years). A significant ($p=0.039$) decrease of SOFA at admission was observed over the years, being 11 in 2016, 8 from 2017 to 2020, and 7 in 2021 and 2022. Mean APACHE significantly ($p=0.024$) decreased from 2016 to 2022, being 25 in 2016, and decreasing to 24, 23, 24, 23, 22 and 21 in the successive years.

The underlying hematological diseases did not differ, with leukemia being the most frequently reported (36.4%, acute myeloblastic 35.2%), followed by lymphoma (34.9%, 86.7% was non-Hodgkin's lymphoma). Among a wide range of causes of ICU admission, the leading causes were sepsis, followed by respiratory failure, reported in 43% and 29% of patients, respectively. No significant differences were observed during the 7-year period.

An important amount of patients required vasopressors (72% in 2016, 64%, 68%, 47%, 91%, and 62% subsequently, $p=0.05$) and mechanical ventilation (62% in 2016, and 28%, 53%, 33%, 33%, 33%, 45% and 30% in successive years, $p=0.055$). A statistically significant difference ($p=0.035$) was observed in the percentage of patients in need of renal clearance techniques, being 31% in 2016, and decreasing in the following years (14%, 21%, 22%, 22%, 22%, 17%, 5% and 3%).

ICU mortality decreased significantly ($p=0.001$) being 59% in 2016, and 28%, 53%, 33%, 33%, 23% and 11% in subsequent years. Similarly, overall, in-hospital mortality decreased significantly ($p=0.007$), being 69% in 2016 and 33%, 58%, 44%, 39%, 32% and 24% in the following years.

Conclusions: Oncohematological patients account for a small percentage in ICU, but with high morbimortality and high resource utilization. Sepsis is the most frequent cause of admission. Earlier admission to our ICU, reflected by a significantly lower SOFA, did not lead to a considerable increase in the number of patients but did lead to a significant decrease in both intra-ICU and overall, in-hospital mortality.

References

1. Azoulay E, Mokart D, Pène F, Lambert J, Kouatchet A, Mayaux J, et al. Outcomes of critically ill patients with hematologic malignancies: Prospective multicenter data from France and Belgium—A groupe de recherche respiratoire en réanimation onco-hématologique study. *J Clin Oncol* [Internet]. 2013
2. Encina B, Lagunes L, Morales-Codina M. The immunocompromised oncohematological critically ill patient: considerations in severe infections. *Ann Transl Med* [Internet]. 2016

Topic: Haematologic-oncologic issues in the ICU

000697

Acute gastrointestinal injury and mortality in ICU patients with SARS-CoV-2 infection

C. Giannaki¹, C. Karachristos¹, I. Mouskeftara¹, M. Tzimou¹, B. Voutsas¹, E. Kaimakamis¹, A. Lavrentieva¹, M. Bitzani¹

¹A-ICU, General Hospital of Thessaloniki "George Papanikolaou", Thessaloniki, Greece

Correspondence: A. Lavrentieva

Intensive Care Medicine Experimental 2023, **11(Suppl 1)**:000697

Introduction: Recognizing the variables that independently predict death in COVID-19 is of great importance; there is little data regarding the impact of acute gastrointestinal injury (AGI) on outcome in COVID-19 patients.

Objectives: The aim of this study was to analyze the association of acute gastrointestinal injury and mortality in COVID-19 patients admitted to an 18-bed ICU.

Methods: The study was carried out prospectively in a single ICU in northern Greece. Data of all adult patients who were tested positive for SARS-CoV-2 between April 2020 and February 2022 were analyzed. All the patients were intubated due to acute respiratory insufficiency and received invasive mechanical ventilation. Patients' demographic characteristics and clinical data were recorded; development of acute gastrointestinal injury was recorded. AGI was categorized into four grades based on collected clinical and imaging data. Comparison between discrete variables were made using the χ^2 test, logistic regression analysis was performed to estimate the relationship between AGI and outcome.

Results: A total of 375 patients were admitted to the ICU during the investigation period. Of those, 239 (63.7%) were male. The patients had a mean age of 64.1 years and had severe ARDS upon admission to the ICU with an average APACHE II of 16.3 and an average length of stay in the unit of 18 days. Overall, the ICU survival was 49.6%, whereas the 28-day survival reached 46.9%. The overall incidence of AGI was 24% in survivors vs. 68.5% in non-survivors, $p=0.001$ (χ^2 test). Logistic regression analysis demonstrated that the presence of AGI grades III and IV was independently associated with higher 28-day and ICU mortality rates.

Conclusions: The development of high-grade acute gastrointestinal injury (AGI) during ICU stay may serve as a prognostic tool to predict outcome in critically ill patients with SARS-CoV-2 infection.

References

1. Drakos P, Volteas P, Cleri NA, Alkadea LN, Asencio AA, Oganov A, Pryor A, Talamini M, Rubano J, Bannazadeh M et al.: Acute Gastrointestinal Injury and Feeding Intolerance as Prognostic Factors in Critically Ill COVID-19 Patients. *J Gastrointest Surg* 2022, 26(1):181-190.

Topic: Metabolism, endocrinology, liver failure and nutrition

000698

Application of adsorptive hemofiltration filter in extracorporeal blood purification therapy of critical ill patients: a national survey in China

C. Chen¹, W. Minmin¹

¹Medical Affairs, Baxter Healthcare Trading (Shanghai) Co., Ltd., Shanghai, China

Correspondence: C. chen

Intensive Care Medicine Experimental 2023, **11(Suppl 1)**:000698

Introduction: With the additional ability to remove endotoxins and inflammatory factors, adsorptive hemofiltration filter (Oxiris) is a novel CRRT filter that has been available in China for five years. There is currently no consensus among experts or advice in the guidelines regarding whether patients will benefit more from oxiris, how to assess the treatment's effectiveness, or how to modify how frequently filters need to be replaced. In an effort to learn more about these issues, we created this survey for experienced oxiris users.

Objectives: Seeking the concepts and concerns of Critical Care physicians with experience with oxiris to help standardize the administration of oxiris.

Methods: Focus on the indication, patient selection, effectiveness assessment, and replacement frequency of oxiris using the QR code questionnaire survey. Target doctors are those who used more than 12 sets of oxiris in the previous year.

Results: 193 hospitals and a total of 493 critical care physicians participated in the survey. There were 8 questions in each survey, and the average response time was 162 s. Depending on the site of infection, 85% of doctors would decide to recommend oxiris for patients in abdominal infection with septic AKI, and then bloodstream infection (73.8%) and lung infection (63.9%).

Diseases with a high inflammatory response are ideal candidates for further investigation, such as acute pancreatitis. Doctors identified the benefits of the efficacy evaluation as a decrease in inflammatory response (97%), a decrease in the demand for vasoactive medications (79%), and an increase in microcirculation (69%). In one course of treatment, 39% of patients in China utilized 3 sets of oxiris, while 49% used 2 sets. A single set typically lasts for 24 h (41% of the time). It is well accepted that oxiris offer a window of opportunity for surgical or anti-infection intervention (93%).

Conclusions: The appropriate population and oxiris improvement metrics were verified through this survey. The majority of doctors will choose oxiris when treating patients with septic AKI, most frequently an intra-abdominal infection. Following use, the patient's inflammatory condition got better and the drugs that vasoactive drugs were downregulated. According to medical professionals, oxiris offers this opportunity for surgical or anti-infection intervention a therapeutic time window.

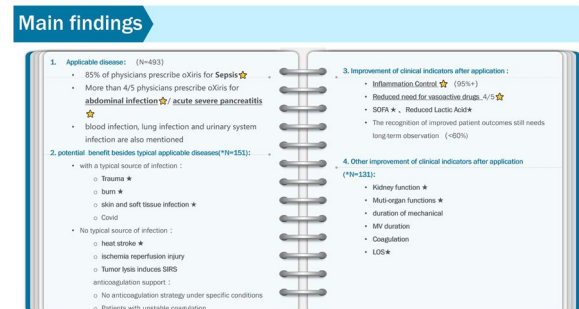

References

1. we gratitude Wu Yulin and Gao Qing jointly participated in the study design and survey process. Thanks all the physicians participating and sharing in the study

Topic: Acute Kidney Injury and haemofiltration

000701

Intensive care nurses' experiences in identifying and clarifying potential donors in non-donor hospitals in Norway

A. Haustreis¹, L. Sandnes², L. T. Gustad²

¹Helse Nord, Helgelandssykehuset Mo i Rana, Mo i Rana, Norway; ²Faculty of Nursing and Health Sciences, Nord University, Bodø, Norway

Correspondence: A. Haustreis

Intensive Care Medicine Experimental 2023, **11(Suppl 1)**:000701

Introduction: The need for transplants is increasing in Scandinavia, but the potential for deceased organ donation in Norway is not being fulfilled. Oslo University Hospital (OUS) has the national responsibility for transplantation in Norway and for the participation in Scandia transplant. However, OUS depends on the work carried out by the 28 donor hospitals and approximately 24 smaller hospitals in Norway (called non-donor hospitals), to find and preserve potential organ

donors to patients on the organ waiting list (1). In difference from a donor hospital, non-donor hospitals don't take a donor all the way to organ removal due to a lack of facilities, staff, training and usually, a lack of a dedicated organ donor team. However, also non-donor hospitals are obliged to start the donor process by identifying potential organ donors, clarifying consent from relatives, contacting the transplant coordinator at OUS and caring for the organ donor until transfer to a donor hospital is possible. Intensive care nurses (ICNs) play a crucial role in identifying potential organ donors and clarifying consent with the donor's family. However, there is a lack of research on ICNs' experiences with this process in non-donor hospitals.

Objectives: Gain insight and describe intensive care nurses' perceptions and experiences with identifying and clarifying potential organ donors in non-donor hospitals. New knowledge can help provide targeted efforts to increase the proportion of organ donation from deceased donors in non-donor hospitals.

Methods: The study has a qualitative, explorative design. Semi-structured interviews were conducted with six intensive care nurses in May 2022. The informants were three men and three women aged 33 to 56, recruited from three intensive care units at non-donor hospitals. All had experience with organ donation at non-donor hospitals. The analysis was conducted by using systematic text condensation (STC) (2).

Results: Two main themes were identified. The assessment of organ donation is non-systematic and dependent on the individual health-care worker on duty. The ICN experienced insecurity due to lack of training and practice of the procedures. Transferring the potential donor from non-donor hospitals is experienced as a barrier by ICNs'. The transfer of their deceased loved one may affect the relatives' consent negatively. To lay this extra burden on the relatives may also prevent ICN's from proposing organ donation.

Conclusions: The study shows that there is more potential for identifying organ donors in non-donor hospitals. Systematic team training to identify donors and approach relatives for consent would possibly increase donors from non-donor hospitals.

References

2. Malterud K. Systematic text condensation: A strategy for qualitative analysis. *Scandinavian Journal of Public Health*. 2012;40(8).
1. Scandiatransplant office. Annual report 2022. 2022.
- This study received a grant from Stiftelsen Organdonasjon (a funding organization for organ donation in Norway). The funders did not play any part in the planning or analyzing of this research.

Topic: Brain death, organ donation and transplantation

000702

Assessing nutritional targets and the factors that affect those in a tertiary intensive care unit without dietician input

M. Mariyam¹, N. Nikitas², M. El-Gazzar¹

¹Medical School, University of Plymouth, Plymouth, United Kingdom;

²Department of Intensive Care Medicine, Derriford Hospital, Plymouth, United Kingdom

Correspondence: M. El-Gazzar

Intensive Care Medicine Experimental 2023, **11(Suppl 1)**:000702

Introduction: Critically ill patients who do not achieve the recommended nutritional intake are at risk of adverse outcomes such as increased mortality, prolonged ventilation, and longer hospital-stay. Underfeeding and overfeeding compared to recommended targets, suboptimal daily protein intake and defining the optimal nutritional intake in patients with body mass index (BMI) over 30 are the main challenges ICU clinicians face. Evidence-based national and international recommendations exist to help with the management of these challenges (1, 2).

Objectives: This audit's objective was to test the compliance of the local nutritional practices to national and international guidelines (in the absence of national guidelines) and to identify factors that affect this practice in a tertiary intensive care unit without dietician input.

Methods: Single centre, retrospective audit collecting data on all adult medical and neuro-ICU patients who were intubated and enterally fed via nasogastric (NG) tube, over a 4-month period (Oct–Jan 2021). Data was collected from the electronic patient database. Patients' demographics, admission details, total/mean daily caloric intake, total/mean daily protein intake, interruptions in enteral nutrition, reasons for interruptions and total/mean daily propofol intake were collected. Descriptive statistics were used in the data analysis.

Results: Data from 67 ICU participants were collected and analysed. Among audit participants, 63% were male and 37% female, the median age was 58.

When propofol administration-related non-nutritional calories were not included in the analysis the recommended daily caloric intake was not achieved in all participants. When the propofol-related calories were included, 50% of participants with BMI < 30 and 32% of participants with BMI > 30 exceeded the recommended daily caloric intake. Recovery rate enteral nutrition was provided in 38% of participants. Of these, 69% were NG fed for longer than 20 days. In 97% of the participants including those with BMI > 30, the recommended daily protein intake target was not met. Length of stay (LOS) < 5 days led to a median duration of interruptions of 4 h (range: 0–15 h), LOS between 6 and 15 days led to a median duration of interruptions of 10 h (range: 0–54 h), LOS between 15 and 25 days led to a median duration of interruptions of 18 h (range: 0–99 h). The most common indications for interruptions were NG tube dislodgement, high aspirates, and transfers for imaging. In 79% of cases, the interruptions in enteral nutrition were not corrected.

Conclusions: Variable factors affect the achievement of nutritional targets in critically ill patients. These results highlight some of those factors and their effect on ICU nutrition targets. Considering national recommendations, interventions will address these factors and optimise nutritional intake for critically ill patients, being at the same time generally applicable.

References

- (1) Andrea Baldwin Network Director, Lancs & South Cumbria Adult Critical Care Operational Delivery Network Rosaleen Baruah Consultant in Intensive Care Medicine and Anaesthesia, NHS Lothian Christopher Bassford (2) Baldwin A, Baruah R, Bassford C, et al. Guidelines for the provision of intensive care services, version 2.1. London Fac Intensive Care Med. 2022.

Topic: Metabolism, endocrinology, liver failure and nutrition

000703

Early and dynamic alteration of 2B4 and CD28 on T lymphocytes predicts 30-day mortality of patients with sepsis: a prospective observational study

Q. Liu¹, Y. Yi²

¹Critical Care Medicine, Zhongda Hospital Affiliated to Southeast

University, Nanjing, China; ²Department of Critical Care Medicine, Zhongda Hospital, Southeast University, Nanjing, Dingjiaqiao 87, Nanjing, China

Correspondence: Q. Liu

Intensive Care Medicine Experimental 2023, **11(Suppl 1)**:000703

Introduction: 2B4 and CD28 are important immune checkpoints expressed on T lymphocytes, which are associated with T cell function in sepsis. We aimed to determine the early and dynamic alteration of 2B4 and CD28 expressed on T lymphocytes in patients with sepsis and their association with clinical outcome.

Methods: A prospective observational study included 152 patients with sepsis admitted to the ICU. 2B4 and CD28 expression on T cells were measured on day 1, 3 and 7 in patients with sepsis, and assessed for associations with 30-day mortality. Associations of kinetic changes of 2B4 and CD28 on T cells with clinical outcomes were investigated using time-varying cox proportional hazard regression model.

Results: This study demonstrated that non-survivors (n=39) had increased 2B4 on CD4+ T cells (p=0.019) and CD8+ T cells (p=0.001), and decreased CD28 on CD4+ T cells (p=0.031) compared to survivors (n=113). In the multivariate cox regression model, time-varying static %2B4 on CD4+ T cells (p<0.001) and time-varying static %CD28 on CD4+ T cells (p=0.012) were associated with 30-day mortality in patients with sepsis. According to the cut-off value of 2B4 and CD28 on CD4+ T cells in predicting 30 day-mortality of septic patients, patients could be split into four groups (2B4hiCD28lo, 2B4hiCD28hi, 2B4loCD28lo and 2B4loCD28hi), in the multivariate cox regression model, the 2B4hiCD28lo pattern was associated with 30-day mortality in patients with sepsis.

Conclusions: Flow cytometric assessment of dynamic alterations in 2B4 and CD28 expression on T cells identifies patients with poor outcomes during sepsis. A dominant 2B4hiCD28lo pattern on day 1 is associated with increased 30-day mortality in patients with sepsis.

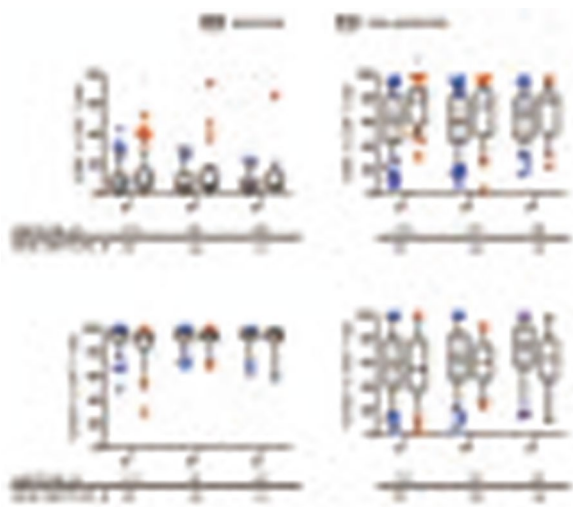

Figure 1 (abstract 000703) Percentage of 2B4 on CD4+ T cells, CD28 on CD4+ T cells, 2B4 on CD8+ T cells, CD28 on CD8+ T cells between non-survivors and survivors of sepsis patients. The percentage of 2B4 on CD4+ T cells, CD28 on CD4+ T cells, 2B4 on CD8+ T cells and CD28 on CD8+ T cells between survivors and non-survivors on day 1, day 3 and day 7 after the admission to the ICU for sepsis. Data are compared using the Mann–Whitney U tests; *p<0.05, **p<0.01, ***p<0.001

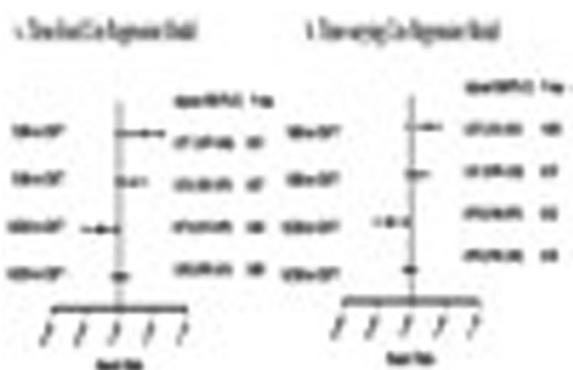

Figure 2 (abstract 000703) Association between 2B4 and CD28 expressed on T lymphocytes and 30-day mortality. (a) Association between 2B4 and CD28 expressed on T lymphocytes and 30-day mortality in time-fixed cox regression model. (b) Association between 2B4 and CD28 expressed on T lymphocytes and 30-day mortality in time-varying cox regression model. Data are expressed with multivariate cox regression

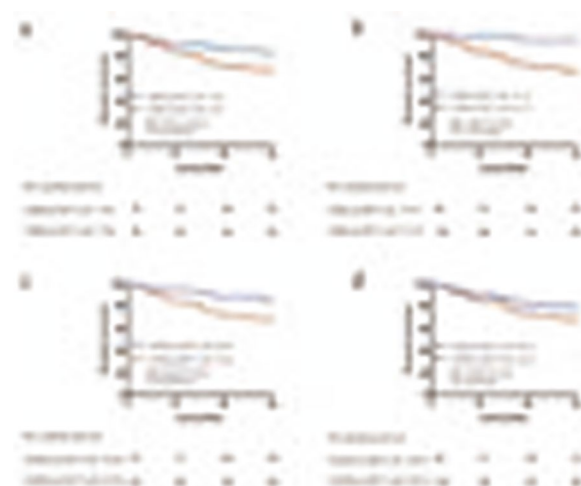

Figure 3 (abstract 000703) Survival analysis. (a–d) Groups are divided according to the cut-off value of 2B4 expression on CD4+ T lymphocytes, CD28 expression on CD4+ T lymphocytes, 2B4 expression on CD8+ T lymphocytes, and CD28 expression on CD8+ T lymphocytes for predicting 30-day mortality of septic patients. Data are compared using Log-rank test and expressed with Kaplan–Meier curves

References

1. Singer M, Deutschman CS, Seymour CW, et al. The Third International Consensus Definitions for Sepsis and Septic Shock (Sepsis-3). *JAMA* 2016;315(8):801–810.
 2. Rudd KE, Johnson SC, Agesa KM, et al. Global, regional, and national sepsis incidence and mortality, 1990–2017: analysis for the Global Burden of Disease Study. *The Lancet (British edition)* 2020;395(10219):200–211.
 3. Buchman TG, Simpson SQ, Sciarretta KL, et al. Sepsis Among Medicare Beneficiaries. *Crit Care Med* 2020;48(3):276–288.
 4. Xie J, Wang H, Kang Y, et al. The Epidemiology of Sepsis in Chinese ICUs: A National Cross-Sectional Survey. *Crit Care Med* 2020;48(3):e209–e218.
 5. Nedeva C, Menassa J, Puthalakath H. Sepsis: Inflammation Is a Necessary Evil. *Front Cell Dev Biol* 2019;7:108.
2. All authors reviewed and provided consent the publication.

Topic: Sepsis

000704

Formalising echocardiography in critical care—a survey on accreditation status and barriers towards widespread accreditation

H. van Huellen¹, C. Bernard¹, A. Myers¹, T. Samuels¹
¹Critical Care, East Surrey Hospital, Redhill, United Kingdom

Correspondence: H. van Huellen

Intensive Care Medicine Experimental 2023, **11(Suppl 1)**:000704

Introduction: Bedside echocardiography is now an established part of routine critical care. To ensure a consistent approach and reduce inter-operator variability, a variety of accreditation pathways exist. In the United Kingdom these are Focused Ultrasound in Intensive Care (FUSIC) run by the Intensive Care Society (ICS), as well as two levels of competency set out by the British Society of Echocardiography (BSE) (1). Data is lacking regarding which accreditations are favoured by UK intensivists and how many have achieved these.

Objectives: To establish the level of echo proficiency and accreditation status amongst intensivists in Kent, Surrey, and Sussex, as well as ascertaining the perceived barriers to achieving accreditation and how these could be overcome.

Methods: In Spring 2023, intensivists (consultants and trainees) working across the South-East of England were surveyed to find if they

were accredited or working towards accreditation in any of the following: Focused Ultrasound for Intensive Care—Heart (FUSIC Heart) or Haemodynamics (FUSIC HD) and BSE Level 1 or Level 2. They were also questioned regarding barriers to accreditation.

Results: 45 responses were analysed. The majority (36 or 80%) used echocardiography at least occasionally as part of their clinical practice and 17 (37.8%) used it regularly. Less than half (18 or 40%) were formally accredited, with FUSIC Heart accounting for the majority of those (13 or 28.9%). 11 (24.4%) respondents were currently working towards accreditation, with a further 13 (28.9%) planning on doing so in the future. Only 3 respondents (6.7%) were not interested in formal accreditation.

A lack of dedicated time alongside clinical duties was cited as the most common barrier to achieving accreditation (79.1%), followed by scarcity of local mentors (58.1%) or difficulty reviewing scans with them (53.5%). In contrast, unavailability of suitable ultrasound machines was only rarely (2.3%) a problem (Fig. 1).

Availability of echocardiography mentors (73.7%) as well as local echocardiography training (68.4%) were felt to be most beneficial in overcoming these barriers. There was also demand for formal teaching days and peer support groups (65.8% and 42.1% respectively).

Conclusions: This study reflects the increasing importance of critical care echocardiography in the UK, with most participants using it as part of their routine clinical practice. However, growing interest has not yet reliably translated into widespread training and accreditation. Several factors are implicated including a perceived lack of time to complete the accreditation process. These findings are in keeping with data from the Intensive Care Society, who quote that only 34% of those seeking accreditation finished the process in 2014 (2). ICU training and practice is likely to require dedicated echo training sessions or in-house fellowships as standard for intensivists to develop and maintain skills.

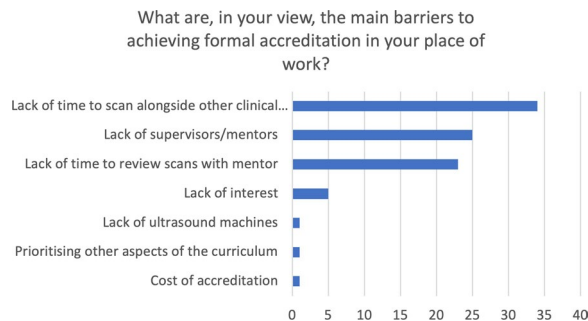

Figure 1 (abstract 000704) Perceived barriers to accreditation (number of responses)

References

2. Peck M, Breen A, Jones N, Orme R, Russell C. Focused intensive care echocardiography: 1000 participating, 300 accredited and counting. *Journal of the Intensive Care Society*. 2017;18(1):74–5.
1. Ritzmann S, Baker S, Peck M, Ingram TE, Allen J, Duffy L, et al. British Society of Echocardiography Departmental Accreditation Standards 2015 with input from the Intensive Care Society. *Echo research and practice*. 2020;7(1):G43–G9.

Topic: Cardiovascular issues in ICU

000705

Development of quick post-cardiac arrest neurological outcome Score (qCANS) for predicting neurological outcome at hospital discharge

E. J. Park¹, H. Lee¹, S. E. Lee¹, S. Kim¹, Y. J. Choi¹, M. Ahn²

¹Emergency Medicine, Ajou University, Suwon-si, Republic of Korea;

²Oncology, Ajou University, Suwon-si, Republic of Korea

Correspondence: E. J. Park

Intensive Care Medicine Experimental 2023, **11(Suppl 1)**:000705

Introduction: Predicting neurological outcome of post cardiac arrest patients is important but extremely difficult in quick decision. Prognostication was recommended to use multimodal methods. Several studies presented predicting score for return of spontaneous circulation (ROSC), survival admission and neurological outcome. Of those, scoring for predicting neurological outcome had simple variables though had complex calculation equation.

Objectives: The aim of this study is to develop a simple and broadly applicable score at admission to predict a poor neurological outcome at discharge in post cardiac arrest patients.

Methods: This was a retrospective study performed in a tertiary care hospital in South Korea from 2019 to 2021. Patients with admission for PCAC after ROSC were included. Poor neurological outcome was defined as a cerebral performance category of 3, 4, or 5.

Results: Total 259 patients were enrolled. Median age was 60.0 (IQR 25.00), male was 167 (67.5%). 214 (82.6%) was out of hospital cardiac arrest (OHCA). 177 (68.3%) was witnessed arrest. 61 (23.6%) showed first monitored shockable rhythm (Table 1). Targeted temperature management was performed for 253 (97.3%) patients, those target temperature was 33.0 °C (IQR 2.00). Median SOFA score was 10.0 (IQR 4.00). 46 (17.8%) was diagnosed with brain death. 135 (52.1%) were survived at discharge and good neurological state at was 48 (18.5%). Univariable analysis showed age, sex, cause of arrest, arrest duration, initial shockable rhythm and acute abnormal finding of brain CT at admission was correlated with poor neurological outcome at discharge. Binary logistic regression showed that age 65 or more, non-cardiac cause of arrest, arrest duration 20 min or more, initial nonshockable rhythm, acute abnormal lesion of brain CT were significant variables showing poor neurological outcome (adjusted R² 0.660). To build a simple scoring system, each variable was given 1 impact score except cardiac cause of arrest, which was given – 1 impact score. qCANS score can present – 1 to 4. Receiver operating characteristic (ROC) curve to predict performance showed area under curve (AUC) was 0.935 (95% CI 0.897–0.963) (Fig 1). The Hosmer–Lemeshow Goodness-of-Fit test statistic showed this model adequately fits the data (p = 0.116).

Table 1 (abstract 000705) Summary of variables of qCANS score according to neurological outcome at discharge

	Total (n = 259)	Good outcome (n = 104)	Poor outcome (n = 250)	P value
Age (years)	60 (25.00)	51 (22.00)	65 (24.00)	0.000
Initial shockable rhythm	61 (23.6)	38 (79.2)	23 (10.9)	0.000
CPR duration (min)	27.0 (25.00)	17.0 (13.00)	30.0 (27.00)	0.001
Presumed cardiac cause of arrest	164 (63.3)	8 (73.9)	156 (16.7)	0.000
Acute lesion of brain CT at admission	116 (46.8)	6 (14.3)	110 (53.4)	0.000

Data are presented as median (IQR) or n (%)

Conclusions: qCANS score is simple and easily applicable tool at admission to predict poor neurological outcome for post cardiac arrest patients.

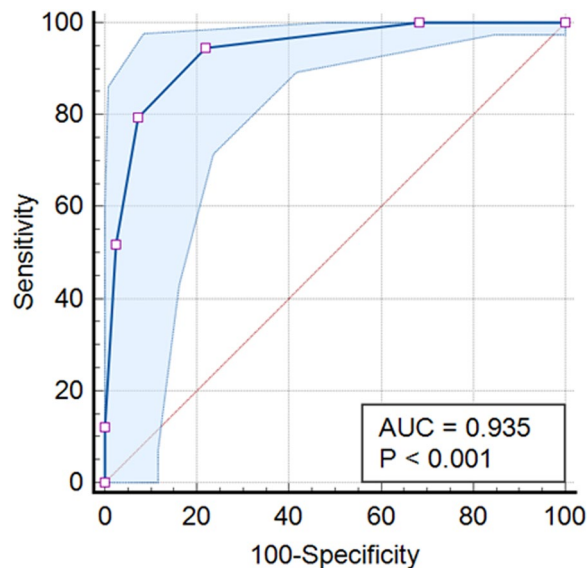

Figure 1 (abstract 000705) Receiver operating characteristic curves for quick post-Cardiac Arrest Neurological outcome Score

References

- Baldi E, Caputo ML, Savastano S, et al. An Utstein-based model score to predict survival to hospital admission: The UB-ROSC score. *Int J Cardiol.* Jun 1 2020;308:84–89.
- Panchal AR, Bartos JA, Cabanas JG, et al. Part 3: Adult Basic and Advanced Life Support: 2020 American Heart Association Guidelines for Cardiopulmonary Resuscitation and Emergency Cardiovascular Care. *Circulation.* Oct 20 2020;142(16_suppl_2):S366-S468.
- Nolan JP, Sandroni C, Bottiger BW, et al. European Resuscitation Council and European Society of Intensive Care Medicine Guidelines 2021: Post-resuscitation care. *Resuscitation.* Apr 2021;161:220–269.
- Seewald S, Whent J, Lefering R, et al. CaRdiac Arrest Survival Score (CRASS)—A tool to predict good neurological outcome after out-of-hospital cardiac arrest. *Resuscitation.* Jan 1 2020;146:66–73.
- Liu N, Whent J, Lee JW, et al. Validation of the CaRdiac Arrest Survival Score (CRASS) for predicting good neurological outcome after out-of-hospital cardiac arrest in an Asian emergency medical service system. *Resuscitation.* Jul 2022;176:42–50.
- Liu N, Liu M, Chen X, et al. Development and validation of an interpretable prehospital return of spontaneous circulation (P-ROSC) score for patients with out-of-hospital cardiac arrest using machine learning: A retrospective study. *EclinicalMedicine.* Jun 2022;48:101422.
- Grasner JT, Meybohm P, Lefering R, et al. ROSC after cardiac arrest—the RACA score to predict outcome after out-of-hospital cardiac arrest. *Eur Heart J.* Jul 2011;32(13):1649–56.

Topic: Cardiac arrest

000706

Early identification of Intensive Care unit-acquired pneumonia in severe COVID19 patients with daily monitoring of C-reactive protein and Calcitonin

J. P. Cidade¹, L. Coelho¹, V. Costa¹, R. Morais¹, L. Morais¹, P. Moniz¹, P. Fidalgo¹, A. Tralhão¹, D. Nora¹, B. Valerio¹, V. Mendes¹, C. Tapadinhas¹, P. Povoal¹

¹UCI-4, CHLO, Lisbon, Portugal

Correspondence: J. P. Cidade

Intensive Care Medicine Experimental 2023, **11(Suppl 1)**:000706

Introduction: The SARS-CoV-2 infection is a complex form of hypoxic acute respiratory failure, leading to frequent progression to acute respiratory distress syndrome, multiorgan failure, and intensive care unit (ICU) admission. Due to invasive organ support, significantly prolonged ICU stay, and specific immunosuppressive therapies, these patients are prone to nosocomial superinfections. Furthermore, the manifestations of sepsis are recognizably poorly specific. Therefore, using serum biomarkers kinetics in conjunction with clinical manifestations could be the key to early identification and prompt therapy.

Objectives: Our aim was to assess the value of daily measurements of C-reactive protein (CRP) and Procalcitonin (PCT) in the early identification of ICU-acquired infections in COVID-19 patients.

Methods: We undertook a prospective observational cohort study (12 months). All adult patients admitted for ≥ 72 h to ICU care with COVID-19 pneumonia were divided into an infected group (n=36) and a non-infected group (n=82). Infected patients had a documented ICU-acquired infection if they presented: new clinical signs of sepsis, positive cultures, and started a targeted antibiotic therapy. The non-infected group did not present clinical signs of sepsis and were not receiving antibiotics for at least 5 days before day 0. Day 0 was considered the day of the diagnosis of infection (infected group) and day 10 of the ICU stay (non-infected group) considering that the median day of infection in the infected group was at D10 of the ICU stay. The kinetics of CRP and procalcitonin daily values were registered from day -10 to day 10 of the ICU stay and evaluated using a general linear model, and univariate, repeated-measures analysis.

Results: 118 patients (mean age 63 years, 74% males) were eligible for the analysis. The groups did not differ in patients' age, gender, CRP, and PCT serum levels registered at ICU admission. However, the infected group encompassed patients with a higher severity score (SOFA score at ICU admission, $p=0.009$), and with higher ventilation ($p<0.001$), vasopressor ($p<0.001$), renal replacement therapy ($p=0.004$) requirements and 28-day mortality rate ($p<0.001$). The infected group also presented higher maximum CRP and PCT serum levels registered during ICU length of stay ($p<0.001$ in both analyses) and a significantly longer ICU length of stay (26 days (19; 37) vs non-infected group (11 days (10; 17), $p<0.001$). CRP showed a significant increase in infected patients, whereas in noninfected it remained almost unchanged ($P<0.001$), while PCT did not appear to retain diagnostic value to predict superinfection in COVID-19 patients ($p=0.593$) (Figure 1).

Conclusions: COVID-19 patients who develop nosocomial superinfections exhibited different anticipatory biomarker profiles before diagnosing those infections. Daily CRP monitoring and the recognition of the CRP pattern could be helpful in the prediction of ICU-acquired infections.

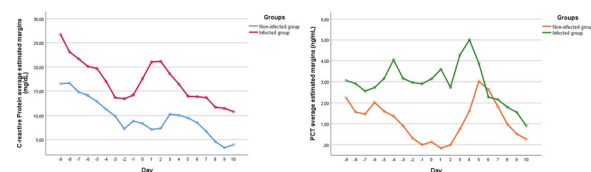

Figure 1 (abstract 000706) C-reactive protein and Procalcitonin progression ten days before and after infection diagnosis date (day 0)

Topic: Infections and prevention

000708

Milrinone in addition to standard therapy in aneurysmal subarachnoid haemorrhage confers favourable neurological outcome: a meta-analysis

C. Camarda¹, L. Premraj¹, B. Jack¹, L. Unnah¹, S. Adriano², S. M. Cho³, D. Battaglini²

¹School of Medicine, Griffith University, Brisbane, Australia; ²Anaesthesia and Intensive Care, IRCCS AOU San Martino, Genova, Italy; ³Neurocritical Care, Johns Hopkins University, Baltimore, United States of America

Correspondence: C. Camarda

Intensive Care Medicine Experimental 2023, **11(Suppl 1)**:000708

Introduction: Delayed cerebral ischemia (DCI) occurs in almost a third of patients with aneurysmal subarachnoid hemorrhage (aSAH) and is the leading cause of morbidity. Evidence for current DCI therapies is limited. A recent randomized controlled trial showed that milrinone, when used as an adjuvant, improved neurological outcome.

Objectives: We investigated the effect of milrinone as an adjuvant therapy on patients with aSAH. The primary aim was favourable neurological outcome (modified Rankin score = mRS \leq 2) and DCI resolution. Secondary aims included mortality, intensive care unit (ICU), and hospital length of stay (LOS).

Methods: PubMed, EMBASE, Scopus, Google Scholar, and Web of Science were searched. Articles with more than 15 aSAH patients who received milrinone as an adjuvant therapy were included. The overall effect size was determined by a general linear mixed model with random effects. Models were moderated for milrinone administration method (intravenous (IV), intraarterial (IA) or intrathecal (IT), combined (IV + IA)), haemorrhage location (Internal Carotid (ICA), Middle Cerebral (MCA), Posterior Cerebral (PCA)) and study year.

Results: 19 studies (1648 patients, mean age of 55 years) that used milrinone as an adjuvant therapy were included. Among those with recorded World Federation of Neurological Surgeons Score, 46.7% had a score $>$ 2. Overall, 67.9% (95% CI = 62.4–73.0, I² = 48.3%) had favourable neurological outcome (mRS \leq 2). DCI resolved in almost all patients (92.2%, 95% CI = 77.9–97.5, I² = 89.2%). Route of administration (IV, IA, IT, IV + IA), haemorrhage location (ICA, MCA, PCA), and study year did not significantly affect neurological outcome or DCI resolution rate. Overall mortality was 7.5% (95% CI = 5.3–10.6, I² = 51.3%), hospital LOS was 27.5 days (95% CI = 24.5–30.6, I² = 0.0%) and ICU LOS was 20.8 days (95% CI = 18.3–23.3, I² = 78.3%).

Conclusions: Our meta-analysis of over 1600 moderate to severe aSAH patients receiving milrinone as adjuvant therapy found a high prevalence of favourable neurological outcome with excellent inter-study agreement despite protocol variance. We also reported near-universal DCI resolution and $<$ 8% mortality. Given the reported limited efficacy of standard therapy, milrinone shows promise as an adjuvant. Studies are needed to determine the effect of the route of administration and artery of haemorrhage more precisely. Given the above, confirmatory randomized trials are warranted.

Topic: Neurointensive care

000711

Ischemic and hemorrhagic stroke in critically ill patients with COVID-19: disparities in low-middle- and high-income countries

L. Premraj¹, D. Battaglioli², K. Lan³, M. Griffiee⁴, J. Fanning⁵, G. Whitman⁶, B. Diego⁷, R. Arora⁸, W. Nicole⁹, S. Adriano¹⁰, G. Libassi¹¹, S. Jacky¹², J. Fraser¹³, P. Pelosi¹⁴, C. Robba¹⁵, S. M. Cho¹⁶

¹School of Medicine, Griffith University, Brisbane, Australia; ²Anesthesia and Intensive Care, San Martino Policlinico Hospital, IRCCS for Oncology and Neurosci, IRCCS AOU San Martino, Genova, Italy; ³School of Pharmacy and Medical Sciences, University of South Australia, City East Campus, Adelaide, Australia; ⁴Anesthesiology - Associate Professor (Clinical), University of Utah Hospital, Salt Lake City, United States of America; ⁵Faculty of Medicine, The University of Queensland, Saint Lucia, Australia; ⁶Cardiac surgery, Johns Hopkins University, Baltimore, United States of America; ⁷Intensive Care Medicine, São Camilo Hospital, Cura d'Arts Fortaleza, Brazil; ⁸Cardiac surgery, St. Boniface Hospital Research, Winnipeg, Canada; ⁹Australian Centre for Health Services Innovation (Aushsi) and Centre for Healthcare Transformati, QUT Gardens Point Campus, Brisbane City, Australia; ¹⁰Anaesthesia and Intensive Care, Ospedale Policlinico San Martino, Genoa, Italy; ¹¹Applied Research in Respiratory Diseases, Institut d'Investigacions Biomèdiques August Pi i Sunyer (IDIBAPS), Barcelona, Spain; ¹²Critical Care Research Group, The Prince Charles Hospital, Chermside, Australia; ¹³Ccrg, Clinical Sciences, The Prince Charles Hospital, Chermside, Australia; ¹⁴Departement of Anesthesia and Intensive Care, University of Genoa, Genova, Italy; ¹⁵Department of Anesthesia and Intensive Care, University of Genoa, Genova, United Kingdom; ¹⁶Neurocritical Care, Johns Hopkins University, Baltimore, United States of America

Correspondence: L. Premraj

Intensive Care Medicine Experimental 2023, **11(Suppl 1)**:000711

Introduction: Coronavirus disease 2019 (COVID-19) can cause multiorgan dysfunction and systemic complications including acute stroke. The pandemic exacerbated global income inequality and disparity of healthcare resources between low-middle income countries (LMIC) and high-income countries (HIC), thus impacting clinical outcomes, ability to collect data, and to join international collaborations.

Objectives: We sought to investigate the disparity of ischemic and hemorrhagic stroke between LMIC and HIC in critically ill patients with COVID-19 and their risk factors and outcomes.

Methods: This is a retrospective analysis of a multicenter prospective observational study of a well-curated international database, the COVID-19 Critical Care Consortium, of COVID-19 adults admitted to intensive care units in 32 countries. Our primary outcome is stroke incidence per admission and 1000 admitted days in LMIC vs. HIC. Secondary outcomes included in-hospital mortality. Incidence rates and rate ratios were estimated using Poisson models clustered by site. Mortality rate ratios were weighted by inverse probability weights.

Results: Overall, 20,312 COVID-19 patients (median age = 61 (51–70)) yrs, 68.4% were males) were included, with an incidence of stroke per admission of 3.0%. Incidences of hemorrhagic type was 0.5% (n = 98) [HIC 0.5% (n = 75) vs. LMIC 0.8% (n = 23)] and ischemic type was 0.5% (n = 88) [HIC 0.4% (n = 60) vs. LMIC 1.0% (n = 28). After imputation, the IRR per admitted days by income region (LMIC vs. HIC) was IRR = 1.96 (95% CI = 1.54–2.51) (p < 0.001), whereas per admission IRR = 1.26 (95% CI 0.99–1.61) (p = 0.059). At multivariable analysis, LMIC group, age, previous neurological condition, chronic cardiac disease, diabetes, platelet count, mechanical ventilation, ECMO support, and pandemic phase (Jan 2021–Dec 2022 vs. Jan–Jun 2020) were independent risk factors of all types of strokes.

Patients from LMIC were more likely to die than those from HIC [RR = 2.54, 95% CI 2.32–2.79 per admitted days, p < 0.001; RR = 1.71, 95% CI 1.62–1.79 per admission, p < 0.001]. Patients with stroke were more likely to die than those without stroke [RR = 1.40, 95% CI 1.15–1.69, p < 0.001 per admitted days; RR = 1.73, 95% CI 1.57–1.90, p < 0.001 per admission]. Patients from LMIC were more likely to have a shorter hospital length of stay than those from HIC. Male gender, obesity, previous neurological condition, stroke during admission, ECMO, mechanical ventilation, and pandemic phases (Jul–Dec 2020 vs. Jan 2021–Dec 2022) were independent risk factors for longer hospitalization.

Conclusions: The incidence of stroke per admitted days was higher for those in LMIC vs HIC, but not for stroke per admission, which multidisciplinary taskforce is allowing us to rapidly provide more interventions to iteratively meet our objective. The formation of the taskforce is allowing multiple other interventions to run in parallel to improve delirium prevention and management; this includes extending visitor hours, supporting family involvement, reorientation boards and promoting sleep hygiene.

References

- Chen, T-J. et al. Diagnostic accuracy of the CAM-ICU score and ICDSC in detecting intensive care unit delirium: A bivariate meta-analysis. *Int J Nurs Stud.* 2021; 113: 103782. <https://doi.org/10.1016/j.ijnurstu.2020.103782>
- Koftis K, Marra A, Ely EW. ICU delirium- a diagnostic and therapeutic challenge in the intensive care unit. *Anaesthesiol Intensive Ther.* 2018; 50(2): 160–167. <https://doi.org/10.5603/AIT.a2018.0011>
- Cavallazzi, R., Saad M., Marik PE. Delirium in the ICU—an overview. *Ann. Intensive Care.* 2012; 2 (49). <https://doi.org/10.1186/2110-5820-2-49>
- N/A

Topic: Sedation, analgesia and delirium

000715

Role of muscle ultrasound as a prognostic domain in critically ill frail patients

M. Kumar¹, V. Sundarsingh¹, N. Baliga¹, P. Rodrigues¹

¹Critical Care Medicine, Father Muller Medical College, Mangaluru, India

Correspondence: M. Kumar

Intensive Care Medicine Experimental 2023, **11(Suppl 1)**:000715

Introduction: Frailty and physical decline occur in the elderly as they age, increasing their risk of health issues and disability. Recent studies have stressed the importance of evaluating frailty among critically ill population (1, 2). The Clinical Frailty Scale (CFS) is one of many assessment tools that has been well validated in critically ill patients (3). Sarcopenia is a domain of frailty that can be objectively quantified by muscle thickness measurement using muscle ultrasonography (MUS) (4).

Objectives:

- To analyse the relationship between Muscle thicknesses (MT) of rectus femoris plus vastus intermedius and CFS-based frailty assessments in a cohort of critically ill hospitalised elderly patients (> 65 years).
- To analyse MT measurements & CFS and its correlation with length of ICU stay, length of hospital stay, mechanical ventilation free days, vasopressor free days, requirement of Renal Replacement Therapy, Ventilator Associated Pneumonia, Blood Stream Infection, re-admission.

Methods: This was a prospective single centre observational study conducted in a 20 bedded intensive care unit in southern part of India. All patients aged more than 65 years were scored for CFS for the evaluation of frailty. Patients were excluded if they had undergone amputation, had limb asymmetry due to a prior hemiplegic stroke that resulted in unilateral muscle wasting, had neuromuscular muscle-wasting disorder as a known pre-existing condition, or had skin abrasions or wounds in the areas chosen for ultrasound examination. Through MUS axial cross-section, the rectus femoris and vastus intermedius muscle thicknesses (MT) were measured. Based on the CFS patients were classified into four groups as no frailty (CFS < 5), mildly frail (CFS = 5), moderately frail (CFS = 6), severely frail (CFS = 7&8).

Results: The study population consisted of 60 elderly patients, 39 men (65%), with median age of 76 (72–84) years, CFS of 5 (4–7), and MT of rectus femoris plus vastus intermedius 20.32 (16.32–23.18) mm. On multivariable regression analysis, CFS was associated significantly and independently with age (p = 0.017) and MT of rectus femoris and vastus intermedius (p = 0.047). None of the secondary outcomes such as mechanical ventilator free days, vasopressor free days, need for RRT were significantly different between the four groups based on CFS. We also found a significant difference in the prevalence of severe frailty between individuals aged 80 years and older and those younger than 80 years (11 vs 5, p = 0.004).

Conclusions: In a cohort of hospitalised elderly critically ill patients, MT of the vastus intermedius and rectus femoris was found to be associated to CFS, independent of other factors taken into consideration. Additional research is required to confirm this association and assess the therapeutic relevance of these findings.

Table 1 (abstract 000715) Showing baseline characteristics of the study population

CHARACTERISTICS(n=60)	VALUES
MEDIAN AGE	76(72-84) YEARS
NO OF MALE	39(65%)
MEDIAN LOS (ICU)	4 days (3-7)
MEDIAN LOS (HOSPITAL)	9 days (6-12)
MORTALITY	16/60 (26.66%)
MEDIAN APACHE 2	16 (11-21)
MEDIAN SOFA	4 (2-5)
NO OF FRAIL	37/60 (61.66%)
MEDIAN CFS	5(4-7)
MEDIAN MT(RF+VI) mm	20.32(16.32-23.18)

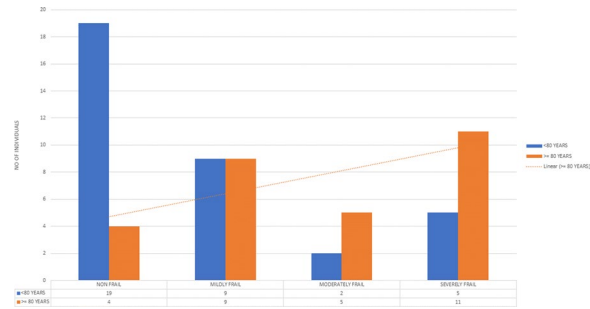

Figure 1 (abstract 000715) Distribution of frailty among our study population (P = 0.004)

References

1. Bencivenga L, Picaro F, Ferrante L, Komici K, Ruggiero F, Sepe I, et al. Muscle Ultrasound as Imaging Domain of Frailty. *Front Med* [Internet]. 2022 [cited 2023 Jan 24];9.
2. Flaatten H, Guidet B, Andersen FH, Artigas A, Cecconi M, Boumendil A, et al. Reliability of the Clinical Frailty Scale in very elderly ICU patients: a prospective European study. *Ann Intensive Care*. 2021 Feb 3;11(1):22.
3. Muscedere J, Waters B, Varambally A, Bagshaw SM, Boyd JG, Maslove D, et al. The impact of frailty on intensive care unit outcomes: a systematic review and meta-analysis. *Intensive Care Med*. 2017;43(8):1105–22.
4. Jung C, Guidet B, Flaatten H, VIP study group. Frailty in intensive care medicine must be measured, interpreted and taken into account! *Intensive Care Med*. 2023 Jan;49(1):87–90.

Topic: Imaging in intensive care

000717

Psychiatric, neurocognitive, and fatigue symptoms two years after COVID-19

H. Ollila¹, R. Pihlaja², M. Tiainen³, V. Salmela², L. Hokkanen², J. Hästbacka⁴
¹Perioperative and Intensive care, University of Helsinki and Helsinki University Hospital, Helsinki, Finland; ²Department of Psychology and Logopedics, University of Helsinki, Helsinki, Finland; ³Department of Neurology, University of Helsinki and Helsinki University Hospital, Helsinki, Finland; ⁴Department of Anaesthesia and Intensive Care, Tampere University Hospital and University of Tampere, Tampere, Finland

Correspondence: H. Ollila

Intensive Care Medicine Experimental 2023, **11(Suppl 1)**:00071

Introduction: COVID-19 survivors may present with psychiatric and neurocognitive symptoms long after the acute phase [1, 2].

Objectives: To determine subjective psychiatric, neurocognitive, and fatigue symptoms two years after COVID-19.

Methods: We assessed three COVID-19 patient groups of different acute disease severity (ICU-treated, ward-treated, home-isolated) and non-COVID controls concerning neurocognitive symptoms (ABNAS; AB Neuropsychological Assessment Schedule), anxiety (GAD7; Generalised Anxiety Disorder 7), depression (PHQ9; Patient Health Questionnaire 9), post-traumatic stress (IES-6; Impact of Event Scale 6), and fatigue (MFI; Multidimensional Fatigue Inventory) with a mailed questionnaire approximately two years after acute COVID-19. We compared the results with those obtained six months after the acute disease [3, 4].

Results: Altogether, 58 ICU-treated, 35 ward-treated, 27 home-isolated COVID-19 survivors and 34 non-COVID controls responded to the questionnaire (Table 1). Cognitive impairment was reported by 26.8% of ICU-treated, 34.4% of ward-treated, 26.9% of home-isolated patients, and 2.9% of non-COVID controls (p=0.011). COVID-19 patient groups had higher median scores in PHQ9, IES-6, and MFI compared to non-COVID controls (Table 1; no differences existed among the different COVID-19 severity groups. Self-reported anxiety

symptoms were rare, and no differences between groups existed (Table 1). The amount of neurocognitive, anxiety, and fatigue symptoms was similar to the six-month follow-up, but depressive and post-traumatic stress symptoms had decreased (Figure 1).

Table 1 (abstract 000717) Characteristics of study subjects in different groups, and outcomes of neurocognitive, depressive, anxiety, post-traumatic stress, and fatigue symptoms 24 months after acute COVID-19

	ICU, n = 58	WARD, n = 35	HOME, n = 27	CON- TROLS, n = 35	p
Participated in 24 month-follow-up (%)	71.6	62.5	54	64.8	NS
Age, years, median (IQR)	60 (50–67.5)	58 (51.5–62.5)	50 (42–58.5)	56 (48.5–62.5)	0.014
Sex, female, n (%)	23 (39.7)	25 (71.4)	19 (70.4)	17 (48.6)	0.006
ABNAS, median (IQR)	11 (5–19.3)	8 (1.8–25.3)	8.5 (0.5–15.5)	2 (0–5)	<0.001
ABNAS > 15, n (%)	15/56 (26.8)	11/32 (34.4)	7/26 (26.9)	1/35 (2.9)	0.011
PHQ9, median (IQR)	3 (1–6)	2.5 (0–7)	2 (0–5.5)	1 (0–1)	0.002
PHQ9 ≥ 10, n (%)	6/56 (10.7)	5/32 (15.6)	2/27 (7.4)	1/35 (2.9)	0.324
GAD7, median (IQR)	1 (0–5)	3 (0–5)	1.5 (0–3.5)	1 (0–2)	0.541
IES-6 mean, median (IQR)	0.5 (0.17–0.83)	0.5 (0–0.83)	0.17 (0–0.58)	0 (0–0)	<0.001
IES-6 mean > 1.75, n (%)	6/58 (10.3)	5/33 (15.2)	1/27 (3.7)	3/34 (8.8)	0.523
MFI, median (IQR)	48 (38–68)	48 (40–58)	53 (37.5–62)	36 (28–43)	0.001

IQR interquartile range; ABNAS AB Neuropsychological Assessment Schedule; PHQ9 Patient Health Questionnaire 9; GAD7 Generalised Anxiety Disorder 7; IES-6 Impact of Event Scale 6; MFI Multidimensional Fatigue Inventory.

Conclusions: Two years after COVID-19, particularly neurocognitive symptoms remained significant.

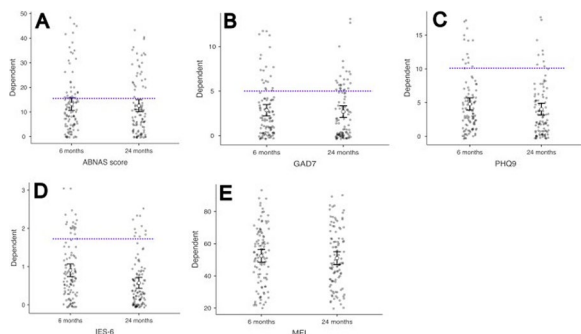

Figure 1 (abstract 000717) Scores of COVID-19 patients (all groups included) in different domains at six and 24 months post-COVID. Mean scores with 95% CI; dots represent observed scores. Dashed lines represent published cut-off values. A) ABNAS, n = 103 (cut-off value > 15) B) GAD7, n = 103 (cut-off value ≥ 5) C) PHQ9, n = 102, paired

samples t-test $p = 0.013$ for the difference between time points (cut-off value ≥ 10) D) IES-6, n = 106, paired samples t-test $p < 0.001$ for the difference between time points (cut-off value > 1.75) E) MFI, n = 106. CI confidence interval; ABNAS AB Neuropsychological Assessment Schedule; GAD7 Generalised Anxiety Disorder 7; PHQ9 Patient Health Questionnaire 9; IES-6 Impact of Event Scale 6; MFI Multidimensional Fatigue Inventory

References

6. Ollila H, Pihlaja R, Koskinen S, Tuulio-Henriksson A, Salmela V, Tiainen M, et al. Long-term cognitive functioning is impaired in ICU-treated COVID-19 patients: a comprehensive controlled neuropsychological study. *Crit Care*. 2022;26(1):223.
5. Pihlaja RE, Kauhanen LS, Ollila HS, Tuulio-Henriksson AS, Koskinen SK, Tiainen M, et al. Associations of subjective and objective cognitive functioning after COVID-19: A six-month follow-up of ICU, ward, and home-isolated patients. *Brain Behav Immun Health*. 2023;27:100587.
4. Huang L, Li X, Gu X, Zhang H, Ren L, Guo L, et al. Health outcomes in people 2 years after surviving hospitalisation with COVID-19: a longitudinal cohort study. *The Lancet Respiratory Medicine*. 2022;10(9):863–76.
3. Heesakkers H, van der Hoeven JG, van den Boogaard M, Zegers M. Two-year physical, mental and cognitive outcomes among intensive care unit survivors treated for COVID-19. *Intensive Care Med*. 2023; doi: <https://doi.org/10.1007/s00134-023-07038-3>.
2. Sun L, Shang Z, Wu L, Pan X, Sun L, Ouyang H, et al. One-quarter of COVID-19 patients developed PTSD symptoms: A one-year longitudinal study. *Psychiatry Res*. 2023;323:115161.
1. Heesakkers H, van der Hoeven JG, Corsten S, Janssen I, Ewalds E, Simons KS, et al. Clinical Outcomes Among Patients With 1-Year Survival Following Intensive Care Unit Treatment for COVID-19. *JAMA*. 2022;327(6):559–65.
- J.H. has received funding from Helsinki University Hospital Grant (TYH2021310) and NordForsk.

Topic: Critical care organisation, quality management, information systems, outcomes

000718

Left ventricular radial strain depicts and quantitatively assesses the severity of paradoxical septal motion in ventilated patients with the acute respiratory distress syndrome

B. Evrard¹, JB. Woillard², A. Legras³, M. Bouaoud³, M. Gourraud³, A. Humeau⁴, M. Goudein¹, P. Vignon¹

¹Réanimation Polyvalente et Inserm CIC 1435, CHU Dupuytren 1, Limoges, France; ²Pharmacologie, Toxicologie et Pharmacovigilance, CHU Dupuytren 1, Limoges, France; ³Médecine Intensive Réanimation, Chru Hôpitaux De Tours, Tours, France; ⁴Pharmacologie et Transplantation, INSERM U1248, Université de Limoges, Limoges, France

Correspondence: B. Evrard

Intensive Care Medicine Experimental 2023, **11(Suppl 1)**:000718

Introduction: Accurate diagnosis of acute cor pulmonale (ACP) is key since it is prognostic in patients ventilated for an acute respiratory distress syndrome (ARDS). ACP is characterized by a paradoxical septal motion (PSM) which identification using two-dimensional echocardiography is highly subjective. Left ventricular (LV) radial strain has not yet been used to help the identification and assess the severity of PSM. **Objectives:** We sought to describe LV radial strain changes related to PSM in patients at risk of sustaining ACP according to its severity.

Methods: This prospective bicentric study included patients ventilated for an ARDS related to COVID-19 who were assessed using transesophageal echocardiography between March 2020 and June 2021. Two-dimensional transgastric short-axis view at mid-papillary level was used to grade septal motion: normal (grade 0), transient end-systolic septal flattening (grade 1), prolonged end-systolic septal flattening or reversed septal curvature (grade 2). LV radial strain analysis was performed off-line on the same digital loops and six LV segments were distinguished: mid-infero-septal and mid antero-septal, their opposite segments (mid-infero-lateral and mid-antero-lateral, respectively), and the remaining two segments (mid-anterior

and mid-inferior). After having confirmed visually that LV radial strain curves were altered in certain segments when a PSM was present (Figure), we performed feature engineering. We calculated the “time-to-peak” defined as the time lag required to reach the maximal value of strain, which was normalized by the length of cardiac cycle and the “partial area under segmental strain curves” which was calculated as the area under each LV segmental strain curve between 33 and 66% of the cardiac cycle length (time period selected on graphical examination of the strain curves where most alterations of strain pattern occurred) to standardize the measurement.

Results: Overall, 318 echocardiography examinations performed in 184 patients were analyzed. Two-dimensional assessment identified a grade 1 and a grade 2 PSM at end-systole in 106 (33%) and 43 (14%) examinations, respectively. When compared with mid-anterior or mid-inferior segments, the time-to-peak of mid-septal and mid-lateral segments occurred significantly later in systole and this delay gradually increased with the grade of PSM (Figure). Similarly, the area under the strain curve of mid-septal and mid-lateral segments increased significantly with the grade of PSM, compared with mid-anterior or mid-inferior segments (Figure).

Conclusions: LV radial strain can objectively depict PSM and quantitatively assess its severity.

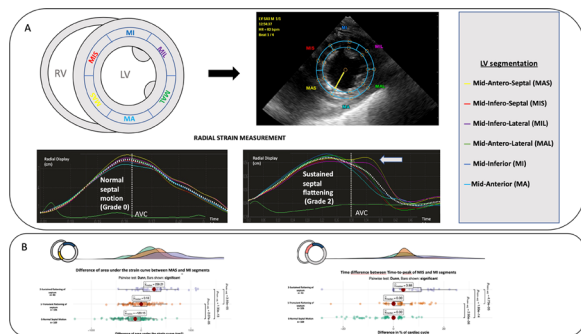

Figure (abstract 000718) A. Schematic representation of LV segmentation for strain analysis with illustrative examples of a normal septal pattern of contraction (grade 0) and of sustained septal flattening (grade 2). **B.** Boxplots with density plots of main result.

Topic: Cardiovascular issues in ICU

000719

Analysis of myeloid activation markers (nCD64 and mCD169) in critically ill patients with severe pneumonia due to SARS-CoV-2 or bacterial sepsis

L. Martín Sánchez¹, A. Ruiz-Sanmartín¹, L. Chiscano¹, C. Palmada¹, I. Bajaaná¹, I. Arrese², S. Salgado², J.C. Ruiz-Rodríguez¹, R. Ferrer Roca¹

¹Intensive Care Department, Hospital Vall d’Hebron, Barcelona, Spain;

²Immunology Department, Vall d’Hebron University Hospital, Barcelona, Spain

Correspondence: L. Martín Sánchez

Intensive Care Medicine Experimental 2023, **11(Suppl 1)**:000719

Introduction: Innate immune cells use a variety of pathogen-derived molecular pattern recognition receptors to survey their environment and activate myeloid cells as an early response to bacteria or viruses. Increased expression of CD64 on neutrophils has been associated with bacterial infections, while increased expression of CD169 on monocytes is associated with viral infections.

Objectives: To analyze the behavior of the nCD64 markers against bacteria, mCD169 against viruses, and HLA-DR in critically ill patients with COVID or bacterial sepsis.

Methods: Single-center prospective study conducted between December 2020 and May 2021. Adult patients admitted to the ICU due to severe pneumonia due to SARS-CoV-2 (COVID) or bacterial sepsis

were included. The diagnosis of sepsis was made following the Sepsis 3 criteria. The diagnosis of COVID was made by evidence of bilateral pulmonary infiltrates in the chest X-ray or in the CT and confirmation by nasopharyngeal PCR test. All patients underwent a study of myeloid activation markers (nCD64 and mCD169) in the first 48 h of admission to the ICU and 10 days later. The expression of mCD169, nCD64 and HLA-DR was determined by flow cytometry. The result is expressed as the mean fluorescent intensity (MFI). ROC curve was made to establish the cut-off point (PC) of values for nCD64, mCD169 and HLA-DR with 95% confidence intervals with the corresponding sensitivity (S) and specificity (E) values. Demographic, clinical and intra-ICU mortality variables were collected. Quantitative data are expressed as mean \pm standard deviation and qualitative data as percentage. Informed consent was requested from patients or relatives and the study was approved by the CEIC of our hospital (PR(AG)639/2020).

Results: Twenty nine patients were included in the study. The demographic and clinical characteristics of the patients are summarized in Table 1. The PCs were: for mCD169 0.97 (S 65% and E 88%), for nCD64 2.04 (S 88% and E 90%) and for HLA-DR 6.68 (S 66% and E 75%) (Fig. 1). On day 0, the expression of CD169 in patients with COVID was positive in 60% of the cases, decreasing in the study period, while only 17% of patients with sepsis were positive at baseline. CD64 expression was positive in 10% of COVID patients and 89% of sepsis patients, and became negative after 10 days. On day 0 the expression of HLA-DR in patients with COVID was 55% while at 10 days it increased to 90%. In patients with sepsis, the expression of HDL-DR at day 0 was 11% and at 10 days 77%. (Fig. 2).

Conclusions: The study of the expression of mCD169 and nCD64 in neutrophils is useful for evaluating the immune response of viral or bacterial origin.

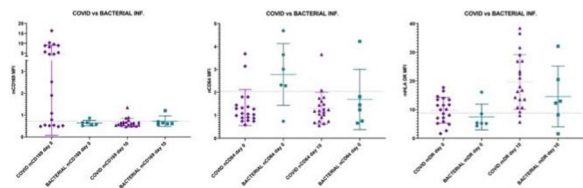

Topic: Sepsis

000720

Acute pancreatitis associated with accidental hypothermia: a multicentre prospective observational study

M. Takahashi¹, M. Hayakawa¹, K. Maekawa¹, T. Wada¹, K. Katayama¹; T. Yoshida¹, T. Saito¹, Y. Honma¹, M. Hayamizu¹, S. Takauji¹, T. Tsuchida¹, Y. TAKAHASHI¹; S. Fukui¹, J. Kato¹, M. Murashita¹

¹Department of Emergency Medicine, Hokkaido University Hospital, Sapporo, Japan

Correspondence: M. Takahashi

Intensive Care Medicine Experimental 2023, **11(Suppl 1)**:000720

Introduction: Although acute pancreatitis (AP) has been reported to occur in patients with accidental hypothermia (AH), the mechanism and risk factors remain unclear.

Objectives: We investigated the frequency and risk factors for the development of AP in patients with AH.

Methods: We conducted a multicentre prospective observational study in 36 tertiary emergency hospitals in Japan. Adult patients aged \geq 18 years with a body temperature of \leq 32 °C and admitted to emergency departments between December 2019 and March 2022 were included in this study. The patients were divided into two groups: those who developed AP within 1 week after admission (AP group) and those who did not (Control group). We explored risk factors for the development of AP by comparing the patients’ characteristics, vital signs, blood gas analysis, and laboratory data.

Results: Of 499 patients with AH, 71 with missing serum amylase levels at admission were excluded, and 428 were analysed in this study. A total of 196 (45.8%) had elevated serum amylase levels on admission, and 17 (4.0%) developed AP within 1 week of admission. A negative correlation was observed between serum amylase level on admission and body temperature (Spearman's rank correlation coefficient -0.100 , $p=0.046$). The AP group were younger than the Control group (AP: 69 years vs. Control: 82 years, $p=0.003$) and had a higher proportion of alcohol consumption before emergency medical service transport. Body temperature at admission was not significantly different between the two groups (AP: 27.8 °C vs. Control: 28.6 °C, $p=0.146$), and body temperature had no significant prognostic value for the development of AP (area under the receiver operating characteristic curve = 0.604, 95% confidence interval = 0.472–0.736). The 28-day mortality was higher in the AP group, but not statistically significant (AP: 35.3% vs. Control: 23.9%, $p=0.385$). The AP group had a higher SOFA score (AP: 9.5 vs. Control: 6.0, $p=0.042$), and by category, only the cardiovascular category showed a significant difference (AP: 4.0 vs. Control: 1.0, $p=0.004$). The AP group showed lower base excess (AP: -17.9 mmol/L vs. Control: -6.6 mmol/L, $p=0.029$), higher lactate (AP: 4.8 mmol/L vs. 2.9 mmol/L, $p=0.092$), and higher serum creatinine (AP: 1.6 mg/dL vs. Control: 1.2 mg/dL, $p=0.041$) in blood gas analysis results and laboratory data.

Conclusions: The frequency of AP within 1 week after admission was 4.0% in patients with AH below 32 °C, and risk factors for the development of AP were considered to be alcohol consumption, circulatory failure, and renal dysfunction.

Topic: Metabolism, endocrinology, liver failure and nutrition.

000721

Presence of frailty in ICU survivors and association with clinical outcomes. Preliminary data

S. Andreadou¹, A. Kouvarakos², E. Kalamara¹, E. Ballas¹, A. Karakatsanis¹, I. Patsaki³

¹ICU, Hospital of Chalkida, Chalcis, Greece; ²ICU, Evangelismos General Hospital, Athina, Greece; ³Physiotherapy, University of West Attica, Egaleo, Greece

Correspondence: I. Patsaki

Intensive Care Medicine Experimental 2023, **11(Suppl 1)**:000721

Introduction: The number of ICU patients that survive critical illness has been rapidly increasing. Survivors have been facing a sequel of serious physical problems, as a consequence to their ICU stay. Decreased muscle strength and functionality are well described, yet the past few years a growing interest surrounds the clinical aspect of frailty. Although, as a syndrome is often seen in elderly population, in ICU populations seems to be encountered and in younger patients.

Objectives: The study aims to assess the incidence of frailty in ICU patients and its association with clinical outcomes. Secondary outcomes are muscle strength and level of mobility at ICU discharge.

Methods: All patients admitted in the ICU of General Hospital of Chalkida and Athens General Hospital "Evangelismos" were mechanically ventilated for >48 h and were included in the study. Exclusion criteria were: history of neuromuscular disorders or neurological disease and end of life patients. Frailty was assessed by the Clinical Frailty Scale before ICU admission and after ICU discharge. Manual Muscle Strength Test (MMST) was used to evaluate muscle strength and MRC scale for the clinical diagnosis of ICUaw. Maximal Inspiratory and Expiratory Pressure for the respiratory muscles at weaning period.

Results: Ninety-two critically ill patients (F:46/M:46, 63.8 ± 13.5 years) were included from 02/2022 till 12/2022. The presence of frailty at ICU discharge reached 69% and in patients < 65 years of age reached 71%. Muscle strength was significantly decreased in elderly patients ($p<0.05$) and in patients who developed ICUaw. Frailty was significantly ($p<0.05$) correlated with the days in mechanical ventilation, the duration of ICU stay and the MMST.

Conclusions: These descriptive data underline the increased incidence of frailty even in younger critical ill patients and its serious

effects in their recovery. Further studies are needed to fully investigate the risk factors of these patients and the long term effects.

References

1. Sidiras G, Patsaki I, Dakoutrou M, Karatzanos E, Gerovasili V, Kouvarakos A, Kardara A, Apostolou K, Dimopoulos S, Markaki V, Nanas S. Muscle strength assessment of critically ill patients is associated with functional ability and quality of life at hospital discharge. *Crit Care*. 2012;16(Suppl 1):P529. doi: <https://doi.org/10.1186/cc11136>.
2. Muscedere J, Waters B, Varambally A, et al. The impact of frailty on intensive care unit outcomes: a systematic review and meta-analysis. *Intensive Care Med*. 2017;43(8):1105–1122. doi: <https://doi.org/10.1007/s00134-017-4867-0>

Topic: Critical care organisation, quality management, information systems, outcomes.

000722

Transcriptional activity of individual myonuclei in the atrophic diaphragm of mechanically ventilated ICU patients

W. Claassen¹, A. Bamyani¹, T. Kirby¹, L. Heunks², C. Ottenheijm¹

¹Physiology, Amsterdam UMC, Location VUmc, Amsterdam, Netherlands;

²Intensive Care, Erasmus University Medical Center, Rotterdam, Netherlands

Correspondence: W. Claassen

Intensive Care Medicine Experimental 2023, **11(Suppl 1)**:000722

Introduction: ICU-acquired diaphragm weakness affects more than half of mechanically ventilated ICU patients and may be caused by ventilator over or under assistance, resulting in atrophy and weakness of diaphragm muscle fibers (1). Muscle fibers are multinucleated cells that adapt to mechanical load by increasing or decreasing their nuclear content (2). In diaphragm muscle undergoing atrophy, protein synthesis rates may decrease (3). We recently observed a decrease in myonuclear content in atrophic fibers isolated from diaphragm biopsies of mechanically ventilated ICU patients (4). This raises the question whether transcriptional activity of the remaining nuclei in the atrophic muscle fiber remains static during atrophy. In this study we investigate whether transcriptional activity is diminished in atrophic diaphragm muscle fibers of mechanically ventilated ICU patients.

Methods: Diaphragm biopsies of mechanically ventilated ICU patients (median ventilation duration of 45 h) with established atrophy (cross-sectional myofiber size of <2000 μm²) were compared to biopsies of patients who underwent thoracic surgery for a small, primary, pulmonary nodule (Controls). Using immunofluorescent staining and confocal microscopy, we determined the transcriptional activity of single nuclei within manually isolated single muscle fibers by staining the enzyme responsible for transcription (RNA-polymerase-II) with an antibody specific for a post-translational phosphorylation at Serine 5. This phosphorylation occurs when the enzyme is activated and transcription of DNA into mRNA starts. Hence, fluorescence intensity is a measure of transcriptional activity. Optical slices of fibers were acquired using spinning-disk confocal microscopy and assembled into a 3D image. Nuclei were segmented using lamin A/C staining, and fluorescence intensity of phosphorylated RNA-polymerase-II within each nucleus was quantified in 3D. Furthermore, fluorescence intensity of all nuclei was summed before normalization for myofiber volume.

Results: 5 biopsies of ICU patients with established atrophy and 5 control biopsies were analyzed. From each biopsy, 10 fibers were isolated, stained, and imaged. Total fluorescence of phospho-RNA-Pol-II C-terminal domain (Ser5) staining within individual nuclei from ICU patients (2235) and control patients (2817) was measured. There were no significant differences in transcriptional activity per nucleus between the groups of 401 [222–638] in the ICU group vs 428 [246–615] in the control group arbitrary units (AU), $p=0.89$ (median [IQR]). Furthermore, transcriptional activity normalized to fiber volume was not different across both groups. Finally, variation of transcriptional activity within each fiber was similar in both groups.

Conclusions: These findings indicate that transcriptional activity is not diminished within the atrophic diaphragm of mechanically ventilated ICU patients. This finding does not support the hypothesis that diminished transcriptional output contributes to early diaphragm atrophy in mechanically ventilated patients. Other mechanisms such as impairment of post-transcriptional events and increased proteolysis appear to play a more pronounced role.

References

1. ZonMW Grant 09120011910004
2. 4) Claassen, W., Kirby T.J., Heunks L. Ottenheijm C. ICU-acquired diaphragm weakness; the role of the myonucleus. *ICMx* 10(2): 001192 (2022).
3. 3) Shanely RA, Van Gammeren D, Deruisseau KC, Zengeroglu AM, McKenzie MJ, Yarasheski KE, Powers SK. Mechanical ventilation depresses protein synthesis in the rat diaphragm. *Am J Respir Crit Care Med.* (2004)
4. 2) Kirby, T.J. and Dupont-Versteegden, E.E., Cross Talk proposal: Myonuclei are lost with ageing and atrophy. *J Physiol.* (2022)
5. 1) Dres, M., Goligher, E.C., Heunks, L.M.A. et al. Critical illness-associated diaphragm weakness. *Intensive Care Med* 43, 1441–1452 (2017)

Topic: Translational Medicine

000723

High-risk pulmonary embolism patients treated with flowtrier mechanical thrombectomy: primary endpoint component analysis from the FLAME Study

A. Viana Tejedor¹

¹Cardiology, Hospital Clinico San Carlos, Madrid, Spain

Correspondence: J. Shaw

Intensive Care Medicine Experimental 2023, **11(Suppl 1)**:000723

Introduction: Guidelines for hemodynamically unstable (high-risk or massive) pulmonary embolism (PE) recommend immediate reperfusion treatment due to the associated short-term mortality of over 25%. Systemic thrombolysis is the recommended front-line treatment despite limited evidence and increased risk of major bleeding and intracranial hemorrhage.

The FLAME Study (FlowTrier for Acute Massive PE) is the largest prospective interventional study in high-risk PE and was designed to evaluate outcomes in high-risk PE patients.

Objectives: Overall outcomes from the FLAME study have been previously reported; the objective of this expanded analysis was to evaluate the primary endpoint and its components, each of which was a secondary endpoint, in patients undergoing FlowTrier mechanical thrombectomy compared to an objective performance goal derived from a meta-analysis.

Methods: The FLAME study was a prospective, multicenter, non-randomized, parallel group, observational study of high-risk PE (NCT04795167). Patients were treated with FlowTrier (FT) mechanical thrombectomy (FT Arm) or other contemporary therapies (Context Arm). PE treatment strategy was determined by the treating physician. The primary endpoint was an in-hospital composite of all-cause mortality, bailout to an alternate thrombus removal strategy, clinical deterioration, and major bleeding. Secondary endpoints included each component of the primary endpoint. These endpoints were compared in the FT Arm to an objective performance goal derived from a meta-analysis.

Results: A total of 53 patients were enrolled in the FT Arm and 61 in the Context Arm. The primary endpoint was reached in 9 (17.0%) FT Arm patients, significantly lower than the 32.0% objective performance goal ($P < 0.01$) (Table). Component analysis of the primary endpoint demonstrated significantly lower rates of all-cause mortality (1.9% vs. 28.5%, $P < 0.0001$) and bailout (3.8% vs. 30.3%, $P < 0.0001$) in the FT Arm versus the performance goal components. Clinical deterioration occurred in 15.1% of FT Arm patients and major bleeding in 11.3% of FT Arm patients, both not significantly different than their respective performance goal components. Even in these high-risk PE patients, 19.2% of FT Arm patients did not require an overnight ICU stay following treatment with FT.

The FT Arm Primary Endpoint Compared to the Performance Goal

	FT Arm	Performance Goal (meta-analysis)	P value
Composite Primary Endpoint	17.0%	32.0%	< 0.01
All-cause mortality	1.9%	28.5%	< 0.0001
Bailout	3.8%	30.3%	< 0.0001
Clinical deterioration	15.1%	15.6%	0.460
Major bleeding	11.3%	11.5%	0.484

Context Arm patients were treated with systemic thrombolysis (68.9%), anticoagulation alone (23.0%), catheter-directed thrombolysis (6.6%), and surgical thrombectomy (1.6%). In the Context Arm, the primary endpoint occurred in 39 (63.9%) of patients. Component analysis of the Context Arm primary endpoint showed that all-cause mortality occurred in 29.5% of patients, bailout occurred in 26.2% of patients, clinical deterioration occurred in 21.3% of patients, and major bleeding occurred in 24.6% of patients.

Conclusions: Treatment of high-risk PE with FT was associated with a low rate of adverse outcomes. The significantly lower frequency of the composite primary endpoint in the FlowTrier Arm compared to the objective performance goal was driven by low rates of all-cause mortality and bailouts, although the rates of clinical deterioration and major bleeding were more in line with the expected performance goal rates in these critically ill high-risk patients.

References

1. Inari Medical sponsored the FLAME study.

Topic: Cardiovascular issues in ICU

000724

Reduction of waste after patient discharge from the intensive care unit using results of admission screening for highly resistant microorganisms

C. Haanappel¹, A. Voor In T. Holt¹, F. Westerlaken¹, H. Koene¹, L. Hazelaar², J. Severin¹, N. Hunfeld³

¹Medical Microbiology and Infectious Diseases, Erasmus MC, Rotterdam, Netherlands; ²Intensive Care, Erasmus MC, Rotterdam, Netherlands;

³Intensive Care and Pharmacy, Erasmus MC, Rotterdam, Netherlands

Correspondence: N. Hunfeld

Intensive Care Medicine Experimental 2023, **11(Suppl 1)**:000724

Introduction: There is an urgency to make healthcare more sustainable, without affecting patient safety. To prevent pathogen transmission via the environment at the intensive care unit (ICU), patient rooms are cleaned after patient discharge and unused products are disposed. This generates 3–9 kg waste per patient per room. We hypothesized that the results of ICU admission cultures for highly resistant microorganisms (HRMO), already part of our surveillance program, could be used to decide on the indication of product disposal.

Objectives: We aimed to assess whether a new waste policy could reduce unnecessary waste at the ICU.

Methods: This retrospective study, at the Erasmus University Medical Center, included anonymous patient ICU admission and isolation data between 01–01-2019/30–09-2022. Patients are screened (throat and rectum) for HRMO on admission, e.g. carbapenem-resistant Gram-negatives; negative cultures are known within 72 h. We retrospectively categorized admissions into products to be disposed or not, whereby products could have been disposed after admissions with isolation precautions and after admissions < 72 h. Products could not have been disposed after admissions of > 72 h without isolation precautions during the full admission.

Results: We included 3923 ICU patients, with 4423 admissions. Isolation precautions were applied in 1012 (22.9%) admissions. Admission

duration was >72 h for 2505 (56.6%) admissions, of which 1750 (69.9%) admissions did not require isolation precautions. Therefore, in 2673 (60.4%) of admissions products should have been disposed, while for 1750 (39.6%) this would not have been necessary.

Conclusions: The use of negative ICU screenings cultures to decide whether or not to dispose patient room products could reduce on average 40% of waste (e.g. 10,500 kg waste reduction) after patient discharge from the ICU. The new waste policy was implemented based on these results. This saved 4200 kg of waste per year, with a financial value of €163.333.



References

- Hunfeld N, Diehl JC, Timmermann M, van Exter P, Bouwens J, Browne-Wilkinson S, de Planque N, Gommers D. Circular material flow in the intensive care unit—environmental effects and identification of hotspots. *Intensive Care Med.* 2023 Jan;49(1):65–74. doi: <https://doi.org/10.1007/s00134-022-06940-6>. Epub 2022 Dec 8. PMID: 36480046; PMCID: PMC9734529.

Topic: Critical care organisation, quality management, information systems, outcomes

000725

Acinetobacter outbreak in critical care covid-19 units in a Portuguese Tertiary Hospital Center – retrospective cohort analysis, outbreak dynamics and infection control measures
 J. Rua¹, P. Costa², J. E. Mateus³, S. Neves⁴, C. Nazareth⁴, R. Sousa², A. Marques³, JP. Baptista⁵

¹Intensive Care Medicine, Centro Hospitalar e Universitário de Coimbra, Coimbra, Portugal; ²Serviço de Medicina Intensiva, Centro Hospitalar e Universitário de Coimbra, Coimbra, Portugal; ³Intensive Care Unit, Centro Hospitalar e Universitário de Coimbra, Coimbra, Portugal; ⁴Unidade de Prevenção e Controlo de Infecção e Resistência a Antimicrobianos, Centro Hospitalar e Universitário de Coimbra, Coimbra, Portugal; ⁵Serviço de medicina intensiva, Centro Hospitalar e Universitário de Coimbra, Coimbra, France

Correspondence: J. Rua

Intensive Care Medicine Experimental 2023, **11(Suppl 1)**:000725

Introduction: The Covid-19 pandemic put health care services under pressure, either by the enormous flux of patients or their severity, frequently requiring admission in Intensive Care Units (ICU). Covid-19's proness to superinfections, in addition to the severity of disease and overwhelmed health care workers generated a predisposing environment for outbreaks of multidrug resistant organisms (MDRO). Acinetobacter spp are opportunistic non-fermenting gram-negative bacilli, frequently associated with nosocomial infections in the critically ill. We describe an outbreak of Acinetobacter spp that evolved through our 4 Covid-19 ICUs (46 beds) during the third pandemic wave.

Methods: Retrospective descriptive cohort analysis of patients infected or colonized by Acinetobacter spp during the outbreak duration, from November to February 2021. Distinction of infection vs colonization was based on clinical and analytical deterioration plus assistant physician input. Pneumonia diagnosis on ARDS patients

required also new lung opacities or important reduction of PaO₂/FiO₂ ratio. Analysis of outbreak dynamics, predisposing factors and infection control measures used.

Results: Thirty-one patients were infected or colonized by Acinetobacter spp, from 218 patients admitted. Median age was 58 years old and 78% were men. Acinetobacter spp was identified in 111 samples from different sites, either by culture or molecular testing. A. baumannii was the most identified (N = 105; 94,6%). Resistance to carbapenem, quinolones and gentamycin was present in >99% of isolates. Sixty-six percent of positive microbiological tests were associated with infection, being pneumonia the most common. Ninety-three percent of patients were in the ARDS stage of Covid-19 disease at time of Acinetobacter identification, 41,2% were under ECMO. All had been submitted to corticotherapy and broad-spectrum antibiotics. Colistin plus sulbactam was the most used therapy. Thirty-day mortality was 38,7%, with the decompensation leading to death associated with Acinetobacter infection in 91,7% of those. ECMO patients mortality was 46,2%. Cases were identified during a 3 months period of time, with overworked staff, patient transfer associated with ECMO and staffing logistics as the drivers for its dissemination. Excessive personal protective equipment (PPE) use had a negative impact in basic infection prevention measures compliance, such as hand hygiene, leading to cross contamination. Reeducation on PPE use, staff cohorting and optimized environment decontamination were the main interventions used for outbreak control.

Conclusions: Acinetobacter infections are particularly impactful in severely ill patients as critical Covid-19 patients, contributing to a high mortality rate.

Excessive PPE utilization decreases the adherence and effectivity of basic infection prevention measures, paving the way for outbreaks of MDRO.

This study shows that with implementation of adequate and coordinated actions, outbreaks of MDRO can be successfully controlled.

References

- Risk factors and effect on mortality of superinfections in a newly established COVID-19 respiratory sub-intensive care unit at University Hospital in Rome; Iacovelli et al. *BMC Pulmonary Medicine* (2023) 23:30
- Corticosteroids and superinfections in COVID-19 patients on invasive mechanical ventilation—S. Sovik et al., *Journal of Infection* 85 (2022) 57–63

Topic: Infections and prevention

000726

Pericardial fat is associated with less severe multi-organ failure over time in patients with coronavirus disease-19: the Maastricht Intensive Care COVID cohort

E. Aydeniz¹, V. Weberndorfer², L. Brandts³, MW. Smulders², TT. Van Herpt¹, B. Martens⁴, K. Vernooij², D. Linz², I. Van der Horst¹, JE. Wildberger⁴, BC. Van Bussel¹, R. Driessen¹, C. Mihal⁴

¹Department of Intensive Care Medicine, Maastricht University Medical Center+, Maastricht, Netherlands; ²Department of Cardiology, Maastricht University Medical Center+, Maastricht, Netherlands; ³Department of Clinical Epidemiology and Medical Technology Assessment, Maastricht University Medical Center+, Maastricht, Netherlands; ⁴Department of Radiology and Nuclear Medicine, Maastricht University Medical Center+, Maastricht, Netherlands

Correspondence: E. Aydeniz

Intensive Care Medicine Experimental 2023, **11(Suppl 1)**:000726

Introduction: Pericardial fat (PF) is a fat layer surrounding the myocardium that is divided into epicardial adipose tissue (EAT) and cardiac adipose tissue (CAT) (1). PF and EAT may enhance the pro-inflammatory response and lead to more severe organ failure in Corona virus-19 (COVID-19) patients (2).

Objectives: The aim of this study was to examine the association between the volume of PF and EAT and multi-organ failure over time.

Methods: Consecutive mechanically ventilated COVID-19 patients at Maastricht University Medical Centre with an available chest CT were

included (March-June 2020) (3). PF and EAT volumes were quantified on non-contrast chest CT scans using a volumetric software. Patients were categorized into sex-specific PF and EAT tertiles. Variables to calculate the Sequential Organ Failure Assessment (SOFA) scores were collected daily to indicate multi-organ failure. Linear mixed-effects regression was used to investigate the association between tertiles for PF and EAT volumes separately and serial SOFA scores over time. All models were adjusted for age, sex, Acute Physiology And Chronic Health Evaluation II (APACHE-II) score, cardiovascular risk and chronic liver, lung, and renal disease.

Results: 63 patients were divided into PF and EAT sex-specific tertiles, with median PF volumes of 131.4 ml (IQR 27.6 ml), 199.8 ml (IQR 35.7 ml) and 318.8 ml (IQR 95.0 ml) and median EAT volumes of 69.6 ml (IQR 21.6 ml), 107.9 ml (IQR 10.5 ml) and 163.8 ml (IQR 56.5 ml). Patients in the highest PF tertile had a statistically significantly lower SOFA score over time (1.3 [-2.5; -0.1], $p=0.033$) compared to the lowest PF tertile. EAT tertiles were not associated with SOFA scores over time.

Conclusions: A higher PF volume is associated with less multi-organ failure in mechanically ventilated COVID-19 patients, suggesting that PF might carry a protective function. EAT volumes were not associated with development of multi-organ failure. These results provide more information on the role of organ-specific adiposity and suggest that PF could be used as a marker for multi-organ failure in mechanically ventilated patients. However, more research is required to confirm these results and to establish the clinical implementation.

References

1. This study received no grants or other funding.
2. 3. Tas J, van Gassel RJJ, Heines SJH, Mulder MMG, Heijnen NFL, Acampode Jong MJ, et al. Serial measurements in COVID-19-induced acute respiratory disease to unravel heterogeneity of the disease course: design of the Maastricht Intensive Care COVID cohort (MaastrichtCht). *BMJ Open*. 2020;10(9):e040175
3. 2. Ryan PM, Caplice NM. Is Adipose Tissue a Reservoir for Viral Spread, Immune Activation, and Cytokine Amplification in Coronavirus Disease 2019? *Obesity (Silver Spring)*. 2020;28(7):1191-4.
4. 1. de Wit-Verheggen VHW, Altintas S, Spee RJM, Muhl C, van Kuijk SMJ, Wildberger JE, et al. Pericardial fat and its influence on cardiac diastolic function. *Cardiovasc Diabetol*. 2020;19(1):129.

Topic: Imaging in intensive care

000728

Impact of tele-icu in clinical outcomes of critically ill covid-19 patients in Brazil

T. Dias Midega¹, F. Hohmann¹, R. C. D. F. Chaves¹, I. Tsuji¹, L. J. Rolim Ferraz¹, G. M. Batista De Almeida², V. J. Lima Leoneza³, J. Ferreira Figueiredo Cabral⁴, B. Veloso Vitalino⁵, T. Domingos Corrêa¹, M. C. Santos⁶, R. Albaladejo Morbeck⁷, A. José Pereira⁶

¹Department of Critical Care Medicine, Albert Einstein Israelite Hospital, São Paulo, Brazil; ²Department of Critical Care Medicine, Hospital de Emergência Dr. Daniel Houly, Arapiraca, Brazil; ³Department of Critical Care Medicine, Santa Casa de Misericórdia de Sorocaba, Sorocaba, Brazil; ⁴Department of Critical Care Medicine, Hospital Regional do Cariri, Juazeiro do Norte, Brazil; ⁵Department of Critical Care Medicine, Santa Casa de Misericórdia de São João del-Rei, São João del Rei, Brazil; ⁶Department of Tele-UTI, Albert Einstein Israelite Hospital, São Paulo, Brazil; ⁷Department of Telemedicine, Albert Einstein Israelite Hospital, São Paulo, Brazil

Correspondence: F. Hohmann

Intensive Care Medicine Experimental 2023, **11(Suppl 1)**:000728

Introduction: In Brazil, the high demand for ICU beds during COVID-19 pandemic caused great social impact (1,2). The lack of trained professionals, especially intensivists, motivated the seek for alternatives to provide efficient care (3). The Tele-ICU COVID-19 Brazil program was developed to provide remote intensivists to lead daily multidisciplinary clinical rounds (DMRs) of systematic patient-centered discussions

in public COVID-19 ICUs from Brazil, through a partnership between the Brazilian Ministry of Health and 5 world-class Brazilian hospitals.

Objectives: To evaluate the association between Tele-ICU COVID-19 Brazil program and clinical outcomes [ICU mortality and ICU length of stay (LOS)].

Methods: Prospective study with 16 ICUs participants of Tele-ICU COVID-19 Brazil program (March to November 2020). To explore the Tele-ICU impact, we calculated the proportion of DMRs performed by patient, as follows: DMR patient ratio equals to the number of rounds per patient divided by patient's ICU length of stay. Univariate analyses were performed to identify predictors of ICU mortality and length of stay and the variables tested with a $p>0.20$ were included as fixed effects in the final analysis. We performed a multivariate analyses using multilevel mixed modelling (GLMM) with hospitals as random effect to evaluate independent predictors of ICU mortality and ICU LOS. When $p<0.05$ the test was considered statistically significant. All analyses were performed using the R (R, version 4.1.0, Core Team, Vienna, Austria, 2021) software.

Results: In total, 1680 patients were included in this study. The median (IQR) age was 66 (55-76) years and 56.4% of patients were male. The median (IQR) SOFA was 4 (1-9) and the median (IQR) number of DMRs performed per patient was 3 (2-6). ICU and hospital mortality were, respectively, 49.0% and 51.1%. Median ICU and hospital LOS were, respectively, 8 (4-15) days and 11 (6-20) days. Independent predictors of ICU mortality in the final model were SOFA score, need of mechanical ventilation (MV) vasopressors, while the use of non-invasive ventilation (NIV) and DMR per patient ratio exhibited a protective effect (Table 1). Independent predictors of ICU LOS were SOFA score and the use of MV, while DMR per patient ratio showed a protective effect (Table 2). Duration of the Tele-ICU program in each hospital and the rate of DMR per hospital had no significant impact in clinical outcomes.

Conclusions: During Tele-ICU COVID-19 Brazil program, a higher proportion of daily multidisciplinary rounds was independently associated with lower ICU mortality and lower ICU LOS. Tele-ICU might have improved outcomes by increasing adherence to best practices and improving the continuity of care in the participants ICUs.

Table 2 (abstract 000728) Results of the General Linear Mixed Model (GLMM) with ICU length of stay as predictor and hospital as random effect

Fixed effects	OR	95% CI	P value
SOFA score	1.037	(1.02-1.05)	<0.001
Use of MV	1.228	(1.05-1.43)	0.010
DMR per patient ratio	0.166	(0.13-0.21)	<0.001

Table 1 (abstract 000728) Results of the General Linear Mixed Model (GLMM) with ICU death as predictor and hospital as random effect

Fixed effects	OR	95% CI	P value
SOFA score	1.238	(0.860-1.317)	<0.001
Use of MV	3.222	(2.056-5.043)	<0.001
Use of NIV	0.540	(0.331-0.881)	0.014
Use of vasopressor	1.870	(1.236-2.824)	0.003
DMR per patient ratio	0.520	(0.272-0.993)	0.048

References

1. We thank all the members of the multidisciplinary team of the participants ICUs. Project supported by the Brazilian Ministry of Health – Institutional Developing Support Program of the Brazilian Health Unified System (PROADI-SUS).
2. 1. Van Damme W, Dahake R, Delamou A, Ingelbeen B, Wouters E, Vanham G, et al. The COVID-19 pandemic: diverse contexts; different

epidemics-how and why? *BMJ Glob Health.* 2020;5(7). 2. Bastos LS, Ranzani OT, Souza TML, Hamacher S, Bozza FA. COVID-19 hospital admissions: Brazil's first and second waves compared. *Lancet Respir Med.* 2021;9(8):e82-e3. 3. Vranas KC, Slatore CG, Kerlin MP. Telemedicine coverage of intensive care units: a narrative review. *Ann Am Thorac Soc* 2018;15:1256-64.

Topic: Critical care organisation, quality management, information systems, outcomes

000729

Extracellular vesicles from bone marrow (MSC-EVs) and adipose (ASC-EVs) mesenchymal stem cells restore redox balance and improve barrier integrity in a lung epithelial-endothelial model after challenge with plasma from severe COVID-19 ARDS patients

A. Burello¹, M. Monfroglio¹, J. Kopecka², S. Scrivanti¹, A. Scagliotti³, MAC. Pomatto⁴, C. Gai⁴, G. Sales⁵, F. Collino⁵, A. Costamagna⁵, G. Montrucchio⁵, P. Cappello³, G. Castellano⁶, V. Cantaluppi⁷, C. Riganti², G. Camussi⁴, V. Fanelli⁵

¹Department of Surgical Sciences, University of Turin, Torino, Italy; ²Department of Oncology, University of Turin, Torino, Italy; ³Center for Experimental Research and Medical Studies (CERMS), University of Turin, Torino, Italy; ⁴Department of Medical Sciences, University of Turin, Torino, Italy; ⁵Department of Surgical Sciences, Department of Anaesthesia, Critical Care and Emergency, University of Turin, Torino, Italy; ⁶Department of Clinical Sciences and Community Health, University of Milan, Milan, Italy; ⁷Nephrology And Kidney Transplantation Unit, Department of Translational Medicine, University of Piemonte Orientale, "Maggiore della Carità" University Hospital, Novara, Italy

Correspondence: A. Burello

Intensive Care Medicine Experimental 2023, **11(Suppl 1)**:000729

Introduction: ARDS induced by SARS-CoV-2 has high mortality and few treatments are available. Stem-cell derived extracellular-vesicles (EVs) are emerging as a possible therapeutic strategy.

Objectives: Plasma of severe COVID-19 ARDS patients induces oxidative stress and damage on lung epithelial-endothelial barrier. EVs from bone marrow (MSC-EVs) and adipose (ASC-EVs) mesenchymal stem-cells mitigate these injuries.

Methods: BEAS-2B and HMEC cells were used as lung barrier model. We tested 5 plasmas of healthy volunteers and 10 plasmas of COVID-19 ARDS patients treated with VV-ECMO. BEAS-2B and HMEC were seeded in chamber slides and multiwell plates and challenged with plasma of healthy volunteers or COVID-19 patients. MSC-EVs or ASC-EVs were added simultaneously with plasma or after 6 h. After 24 h, we evaluated oxidation parameters, antioxidant enzymes activity and expression of tight junction proteins ZO-1 and Occludin by immunofluorescence. Mann-Whitney test was performed for statistical analysis.

Results: COVID-19 plasma significantly increased oxidation parameters, the activity of antioxidant enzymes (p<0,001) and attenuated ZO-1 and Occludin expression (p<0,0001) compared to the healthy control in both BEAS-2B and HMEC (Fig. 1). MSC-EVs and ASC-EVs added together with COVID-19 plasma or after 6 h restored redox balance (Tab 1 Data are Median (IQR)) and expression of ZO-1 (MSC-EVs; ASC-EVs p<0,0001) and Occludin (MSC-EVs; ASC-EVs p<0,001) in BEAS-2B and HMEC.

BEAS-2B	Healthy	COVID	COVID + MSC-EV	COVID + ASC-EV	COVID + MSC-EV 6h	COVID + ASC-EV 6h
Total ROS (nmol/mg prot)	0,63 (0,55-0,68)	1,32 (1,12-1,62)	0,93 (0,86-1,20)	0,98 (0,76-1,12)	0,72 (0,58-0,97)	0,77 (0,66-0,86)
Mitochondrial ROS	1,17 (1,12-1,26)	2,16 (1,45-2,63)	1,75 (1,31-1,80)	1,66 (1,16-1,86)	1,13 (0,87-1,28)	1,1 (0,88-1,34)
Lipid peroxidation	0,14 (0,13-0,16)	0,91 (0,84-1,18)	0,74 (0,68-0,75)	0,69 (0,64-0,77)	0,28 (0,24-0,29)	0,33 (0,27-0,47)

BEAS-2B	Healthy	COVID	COVID + MSC-EV	COVID + ASC-EV	COVID + MSC-EV 6h	COVID + ASC-EV 6h
Protein carbonylation	0,29 (0,24-0,34)	0,78 (0,67-0,87)	0,54 (0,40-0,64)	0,56 (0,44-0,67)	0,28 (0,20-0,36)	0,28 (0,23-0,47)
GSH (nmol/min/mg prot)	11,23(9,92-13,46)	4,73 (4,52-6,32)	7,12 (6,51-7,52)	7,11 (5,74-7,65)	9,85 (8,40-10,27)	9,84 (8,18-10,35)
GSSG	2,72 (2,18-3,73)	7,83 (6,60-9,73)	5,81 (5,10-6,51)	6,74 (6,60-9,73)	4,10 (3,61-4,35)	3,87 (2,97-4,53)
SOD1 (nmol/mg prot)	0,68 (0,56-0,75)	1,06 (0,89-1,23)	0,85 (0,83-0,86)	0,82 (0,72-0,92)	0,67 (0,64-0,69)	0,59 (0,50-0,67)
SOD2	0,35 (0,33-0,39)	0,83 (0,73-0,92)	0,7 (0,58-0,82)	0,62 (0,55-0,73)	0,39 (0,35-0,45)	0,38 (0,33-0,45)
GSR (U/mg prot)	1,26 (1,19-1,32)	1,60 (1,42-1,76)	1,24 (1,05-1,44)	1,34 (1,23-1,35)	1,10(1,04-1,15)	1,12 (1,10-1,16)
GPX	2,30 (2,19-2,38)	3,36 (2,96-3,93)	3,61 (3,09-4,04)	2,9 (2,58-3,60)	2,80 (2,38-3,12)	2,34 (2,19-2,96)
TXNRD1	1,38 (1,34-1,45)	2,32 (2,01-2,67)	2,11 (1,82-2,43)	1,9 (1,67-2,11)	1,38 (1,25-1,72)	1,41 (1,24-1,66)

Conclusions: Plasma of severe COVID-19 ARDS patients induces damage and oxidative stress in a cellular model of lung epithelial-endothelial barrier. MSC-EVs and ASC-EVs mitigate this injury, suggesting a potential therapeutic effect.

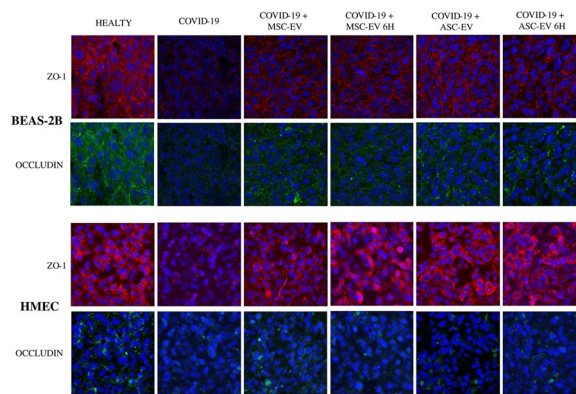

Fig. 1 (abstract 729) Representative images of ZO-1 and Occludin expression in BEAS-2B and HMEC cells. Plasma of severe COVID-19 induced loss of tight junction proteins expression. MSC-EVs and ASC-EVs mitigate this effect when they are added simultaneously with plasma or after 6 h. COVID-19 plasmas tested n = 10 for BEAS-2B n = 5 for HMEC

Topic: Translational Medicine

000730

Voice restoration in the tracheostomised mechanically ventilated patient: a multidisciplinary service review and development of a training resource

A. Kharpal¹, J. Clark², S. Archer³

¹Speech and Language Therapy, Critical Care, Guy's and St. Thomas' NHS Foundation Trust, London, United Kingdom; ²Speech and Language Therapy, Critical Care, Guy's and St Thomas' NHS Foundation Trust,

London, United Kingdom; ³Speech and Language Therapy, Guy's and St Thomas' NHS Foundation Trust, London, United Kingdom

Correspondence: A. Kharpal

Intensive Care Medicine Experimental 2023, **11(Suppl 1)**:000730

Introduction: The consequences of voicelessness in tracheostomised mechanically ventilated (TMV) patients secondary to cuff inflation are well established [1]. Cuff deflation and one-way valve (OWV) placement in-line with ventilation to restore trans-laryngeal airflow and voice is routine practice in our centre. However, introduction of new ventilators across our intensive care unit (ICU) gave rise to safety concerns regarding use of OWVs due to threshold alarms, apnoea ventilation override and potential for human error in managing these. Multidisciplinary team (MDT) review of current practice, available equipment and training resources was completed. Consensus was reached that the new ventilator was not safe, effective or accessible for use with OWVs. A scoping exercise identified Hamilton T1 ventilators as compatible for use with OWVs once specific software is enabled, overcoming safety concerns with the existing ventilator. However, their introduction necessitated new approaches for using OWVs and therefore potentially presented a barrier to access.

Objectives: To determine unmet need regarding the use of OWVs in TMV patients in our mixed cohort ICU and establish approaches to improve this.

Methods: For one month in 2021, Hamilton T1 ventilators were trialled. The number of cuff deflation and in-line OWV sessions completed across all 54 ICU beds was collected. Data also included who delivered these, any safety concerns and the overall number of sessions recommended by Physiotherapy (PT) and Speech & Language Therapy (SLT) to determine unmet need. A MDT steering group comprising of nursing, PT and SLT was formed to establish reasons for unmet need and how to approach this.

Results: 48 sessions of cuff deflation and OWV in-line with ventilation were indicated and 24 were delivered (50% unmet need). All sessions were completed by PT and SLT. The reason for un-delivered sessions was always cited as lack of appropriately trained staff. Steering group review of data and root cause analysis determined staff education and easily accessible training resources as proposed solutions. A standard operating procedure and accessible online guideline was written including a new instructional training video. This was ratified via internal clinical governance process.

Conclusions: Restoration of voice for TMV patients is a priority however ventilator compatibility and safety concerns can limit access. Therefore, having adequately trained staff is essential. A need for education and accessible training materials was established and a novel online training video and guideline has been developed to meet this need. Data is being collected on outcome measures since the launch of the training resources across the MDT.

References

- Wallace, S. et al. (2022). Benefits and options for voice restoration in mechanically ventilated intensive care unit patients with a tracheostomy. *Journal of the Intensive Care Society*, 24(1)

Topic: Acute respiratory failure and mechanical ventilation

000731

Expectations and readiness of ICU physicians to use AI in clinical practice: a multicentre survey study

T. De Corte¹, L. Van Maele², J. Dietvorst², J. Verhaeghe³, A. Vandendriessche⁴, N. De Neve⁵, S. Vanderhaeghen⁶, A. Dumoulin⁷, W. Temmerman⁸, B. Dewulf⁹, N. Van Regenmortel¹⁰, M. Raes¹¹, Y. Debaveye¹², F. Ongenaes¹³, S. Van Hoecke¹³, J. De Waele¹

¹Department of Intensive Care Medicine, Ghent University Hospital, Ghent, Belgium; ²Department of Internal Medicine and Pediatrics - Faculty of Medicine and Health Sciences, Ghent University, Ghent, Belgium; ³Imec, idlab, Ghent University, Ghent, Belgium;

⁴Department of Public Health and Primary Care - Faculty of Medicine and Health Sciences, Ghent University, Ghent, Belgium; ⁵Department of Anesthesiology, Intensive Care and Emergency Medicine, Onze Lieve Vrouweziekenhuis Aalst, Aalst, Belgium; ⁶Department of Intensive Care Medicine, AZ Sint-Lucas, Gent, Belgium; ⁷Department of Intensive Care Medicine, Delta General Hospital, Roeselare, Belgium; ⁸Department of Intensive Care Medicine, AZ Sint-Blasius, Dendermonde, Belgium; ⁹Department of Anesthesia - Critical Care, AZ Sint-Jan, Brugge, Belgium; ¹⁰Department of Intensive Care Medicine, ZNA Stuivenberg, Antwerpen, Belgium; ¹¹Department of Intensive Care Medicine, UZ Brussel, Jette, Belgium; ¹²Department of Intensive Care Medicine, University Hospital Leuven, Leuven, Belgium; ¹³Imec, idlab, IDLab, Ghent University - imec, Gent, Belgium

Correspondence: T. De Corte

Intensive Care Medicine Experimental 2023, **11(Suppl 1)**:000731

Introduction: Although artificial intelligence (AI) is increasingly investigated in the ICU, use in clinical care is currently limited [1]. Besides technical and organizational factors, human readiness and acceptance play an important role in adoption of new applications [2]. To date, little is known about the attitudes of ICU physicians towards the use of AI in clinical practice.

Objectives: To assess the expectations and readiness of ICU physicians regarding the acceptance and use of AI in clinical practice.

Methods: Data was collected between April 2022 and October 2022 from physicians and residents working in an ICU in Flanders (Belgium). 9 out of 10 contacted hospitals participated. Participants completed an online survey assessing basic information such as age, gender, experience, etc. as well as their opinion on statements probing current use of information and communication technology (ICT), AI research, AI use, and their future expectations by means of a 5-point Likert scale ranging from "Completely disagree" to "Completely agree". Statistical analysis was performed using R Studio. Continuous variables are presented as median with interquartile range (IQR, [Q25-Q75]). Categorical variables are presented as percentage of total evaluable instances. Statistical significance was defined as a p-value < 0.05.

Results: Characteristics of the 69 participants are listed in Table 1. Almost all participants thought the use of ICT benefits patient care (94.2%). The majority of the participants expect AI tools to also benefit patient care (75.4% - Fig. 1) and consider the implementation of AI tools in clinical practice inevitable in the future (85.5% - Fig. 2). Participants from academic hospitals were more likely to be interested in AI applications in clinical practice and research than participants from non-academic hospitals (p=0.04). Despite the perceived benefit of using AI in clinical practice, a minority of physicians feels adequately familiar with concepts such as AI or big data (39.1%), or feel competent to use AI in daily clinical practice at this time (15.9% - Fig. 3). Age, gender, working environment and working experience were not associated with the self reported readiness to use AI. Rather than replacing physicians, participants believed that AI would become a tool used by clinicians (91.3% - Figure 4), but not to a point where clinicians who do not use AI tools were replaced by clinicians who do use them (17.4%).

Table 1 (abstract 000731) Descriptive statistics of the study participants (N = 69)

Age (years)	40 [31-49]	Clinical experience (years)	11 [6-23]
Gender (% Female)	42%	ICU experience (years)	6 [1-19]
Role		ICU type	
Consultant	66.7%	Mixed surgical and medical ICU	63.8%
Resident ICU	17.4%	Surgical ICU	29.0%
Resident other specialty	15.9%	Medical ICU	7.2%

Age (years)	40 [31–49]	Clinical experience (years)	11 [6–23]
Basic specialty		Setting	
Anesthesiology	63.8%	Non-academic hospital	62.3%
Internal medicine or subspecialty	26.1%	Academic hospital	37.7%
Emergency medicine	8.7%		
Pediatrics	1.4%		

Conclusions: ICU physicians and residents consider the use of AI in the ICU inevitable and think it will benefit patient care. Clinicians do not yet feel competent enough to start using AI routinely in clinical practice.

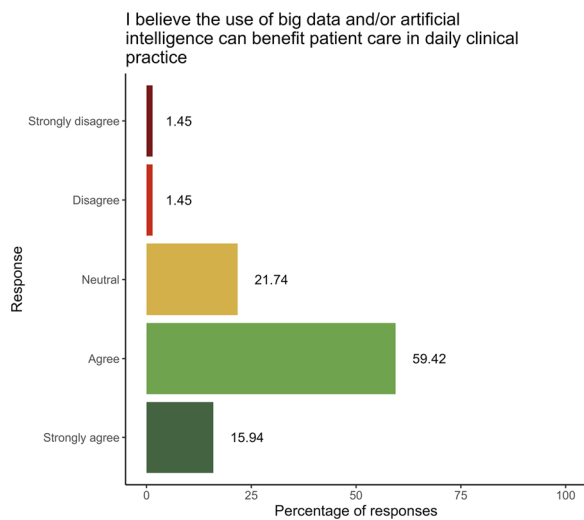

Figure 1

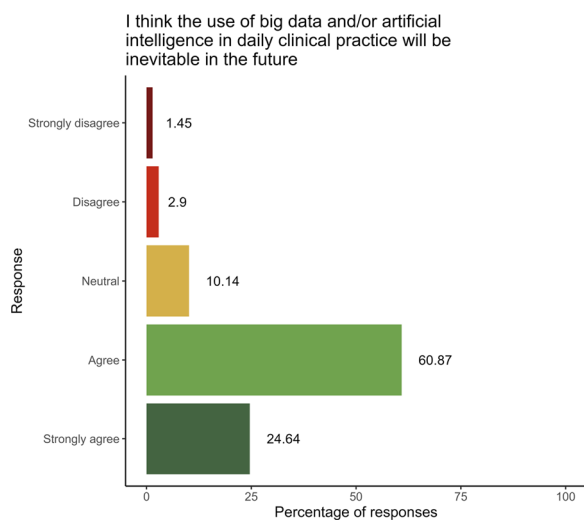

Figure 2

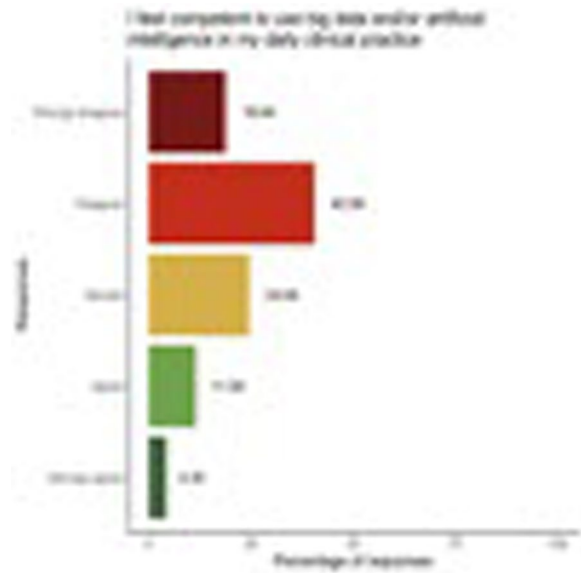

Figure 3

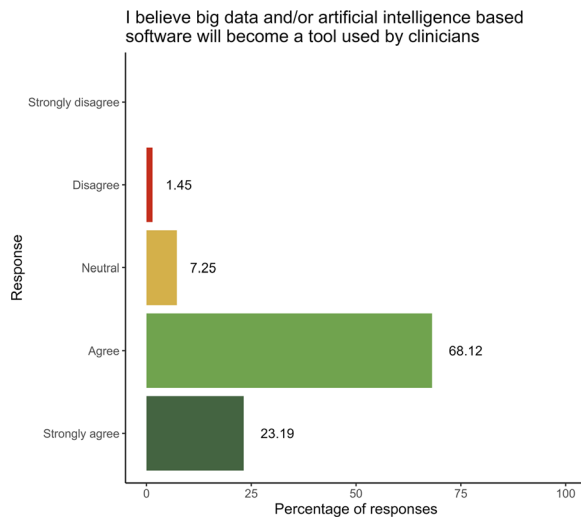

Figure 4

References

- [1] Fleuren LM, Thoral P, Shillan D, et al. (2020) Machine learning in intensive care medicine: ready for take-off? Intensive Care Med 46:1486–1488. doi: <https://doi.org/10.1007/s00134-020-06045-y>
- [2] Erlirianto LM, Ali AHN, Herdiyanti A (2015) The Implementation of the Human, Organization, and Technology–Fit (HOT–Fit) Framework to Evaluate the Electronic Medical Record (EMR) System in a Hospital. Procedia Computer Science 72:580–587. doi: <https://doi.org/10.1016/j.procs.2015.12.166>
- This work was funded by the FWO Junior Research project HEROI2C (Grant nr G085920N), which investigates hybrid machine learning for improved infection management in critically ill patients.

Topic: Data Science

000733

Serial electrical impedance tomography course in different treatment groups; the MaastrICht cohortE. Aydeniz¹, BC. Van Bussel¹, S. De Jongh¹, J. Schellens¹, SJH. Heines¹, S. Van Kuijk², J. Tas¹, F. Van Rosmalen¹, I. Van der Horst¹, D. Bergmans¹¹Department of Intensive Care Medicine, Maastricht University Medical Center+, Maastricht, Netherlands; ²Department of Clinical Epidemiology and Medical Technology Assessment, Maastricht University Medical Center+, Maastricht, Netherlands**Correspondence:** E. Aydeniz*Intensive Care Medicine Experimental* 2023, **11(Suppl 1)**:000733

Introduction: Patients diagnosed with coronavirus disease-19 (COVID-19) may develop respiratory failure, requiring mechanical ventilation (1). Dynamic respiratory system compliance may be a valuable indicator of impaired lung mechanics caused by COVID-19.

Objectives: To describe the effect of dexamethasone and tocilizumab on regional lung mechanics over admission in mechanically ventilated COVID-19 patients.

Methods: In this prospective observational cohort study, invasive mechanically ventilated patients enrolled within the Maastricht Intensive Care Covid (MaastrICht) cohort were included (2). Dynamic compliance, alveolar overdistension and collapse were serially determined using electric impedance tomography (EIT)(3, 4). Patients were categorized into three groups; no anti-inflammatory therapy, dexamethasone therapy, dexamethasone + tocilizumab therapy. The EIT variables were visualized using polynomial regression and evaluated throughout admission using linear mixed-effects models. Moreover, we compared respiratory variables between the three groups, including PaO₂/FiO₂-ratio, driving pressure, optimal positive end-expiratory pressure (PEEP) (the PEEP level with alveolar collapse closest and under 5%), clinically applied PEEP (PEEP set in the clinic when optimal PEEP was not implemented due to the clinical condition), dynamic compliance, alveolar overdistension, and alveolar collapse at the optimal PEEP.

Results: The no anti-inflammatory therapy group (n=92) had 310 EIT measurements, the dexamethasone group (n=60) 130 measurements, and the dexamethasone + tocilizumab group (n=8) 13 measurements. Visual inspection of EIT variables showed a pattern of decreasing dynamic compliance. Overall, optimal set PEEP was lower in the dexamethasone group (-1.4 cmH₂O, -2.6; -0.2). Clinically applied PEEP was lower in the dexamethasone and dexamethasone + tocilizumab group (-1.5 cmH₂O, -2.6; -0.2; -2.2 cmH₂O, -5.1; 0.6). Dynamic compliance, alveolar overdistension, and alveolar collapse at optimal set PEEP did not significantly differ between the three groups.

Conclusions: Optimal PEEP was similar in groups based on treatment, while optimal and clinically applied PEEP were lower in the dexamethasone and dexamethasone + tocilizumab groups. The results suggest that the potential beneficial effects of these therapies do not affect lung mechanics.

References

1. Jafari D, Gandomi A, Makhnevich A, Qiu M, Rolston DM, Gottesman EP, et al. Trajectories of hypoxemia and pulmonary mechanics of COVID-19 ARDS in the NorthCARDS dataset. *BMC Pulm Med.* 2022;22(1):51.
2. Tas J, van Gassel RJJ, Heines SJH, Mulder MMG, Heijnen NFL, Acampode Jong MJ, et al. Serial measurements in COVID-19-induced acute respiratory disease to unravel heterogeneity of the disease course: design of the Maastricht Intensive Care COVID cohort (MaastrICht). *BMJ Open.* 2020;10(9):e040175.
3. Bels JLM, van Kuijk SMJ, Ghossein-Doha C, Tijssen FH, van Gassel RJJ, Tas J, et al. Decreased serial scores of severe organ failure assessments are associated with survival in mechanically ventilated patients; the prospective Maastricht Intensive Care COVID cohort. *J Crit Care.* 2021;62:38–45.
4. Heines SJH, van Bussel BCT, Jong MJA, Bennis FC, van Gassel RJJ, Groven RVM, et al. Pulmonary pathophysiology development of COVID-19 assessed by serial Electrical Impedance Tomography in the MaastrICht cohort. *Sci Rep.* 2022;12(1):14517.
5. This study received no grants or other funding.

Topic: Acute respiratory failure and mechanical ventilation

000734

Effect of different early mobilization interventions within 72 h of admission or intubation of critically ill patients: a systematic review with network-meta-analysisN. Daum¹; N. Drewniok¹; A. Buyukli¹; B. Ulm²; J. Grunow¹; S. J. Schaller¹¹Department of Anesthesiology And Surgical Intensive Care, Charité – Universitätsmedizin Berlin, Berlin, Germany; ²Department of Anesthesiology and Intensive Care Medicine, Klinikum rechts der Isar der Technischen Universität München, München, Germany**Correspondence:** N. Daum*Intensive Care Medicine Experimental* 2023, **11(Suppl 1)**:000734

Introduction: Previous studies demonstrated that an early start of mobilization has a positive effect on different intensive care unit (ICU) outcomes [1]. Since there is no uniform definition of early mobilization (EM) comparing studies is challenging [2].

Objectives: Aim of this systematic review was to investigate the effectiveness of different interventions defined as EM on outcomes.

Methods: Before screening, we registered our systematic review on PROSPERO (CRD42022363584). We conducted a systematic review and network-meta-analysis examining the effect of different EM interventions within 72 h of ICU admission or intubation compared to standard care. Randomized controlled trials were included from inception to October 8th, 2022. EM was defined as any patient intervention that initiates and/or supports passive or active range of motion exercises and aims to promote and/or maintain range of motion [3]. A network meta-analysis was performed using the 'netmeta' package in R (version 4.1.2). Outcomes were pooled using a common-effects model.

Results: Of a total of 29,680 studies screened, 18 studies with a total of 1833 patients met the inclusion criteria and were included in the statistical analysis for ICU length of stay (LOS). We identified 7 different mobilization interventions defined as EM in the time frame of interest. 14 studies with a total of 1587 patients and 4 different mobilization interventions defined as EM could be included in the statistical analysis in relation to the hospital LOS. A network meta-analysis was only possible for ICU and hospital LOS because the number of studies was too small for other outcomes. In the network meta-analysis, EM alone, cycling, and EM with early nutrition showed the greatest weighting in relation to ICU LOS. In relation to hospital LOS, the greatest weighting was shown for EM alone and cycling (see Fig. 1, A and C). The combination of EM and early nutrition as well as EM alone had a significant effect on ICU LOS, while EM alone had a significant effect on hospital LOS (see Fig. 1, B and D). The overall heterogeneity of the studies was moderate with I² = 50%.

Conclusions: This network meta-analysis confirmed the positive effect of EM alone as well as the combination of EM and early nutrition on ICU LOS. Furthermore, EM alone shortened hospital LOS.

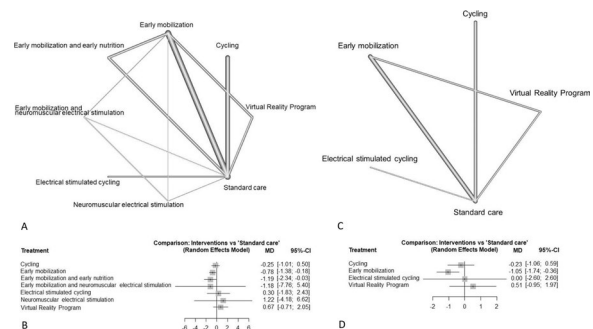
**References**

1. Schaller SJ, Anstey M, Blobner M, Edrich T, Grabitz SD, Gradwohl-Matis I, et al. Early, goal-directed mobilisation in the surgical intensive care unit:

a randomised controlled trial. Lancet. 2016;388(10,052):1377–88 doi: [https://doi.org/10.1016/S0140-6736\(16\)31637-3](https://doi.org/10.1016/S0140-6736(16)31637-3).

- Clarissa C, Salisbury L, Rodgers S, Kean S. Early mobilisation in mechanically ventilated patients: a systematic integrative review of definitions and activities. J Intensive Care. 2019;7:3 doi: <https://doi.org/10.1186/s40560-018-0355-z>.
- Bein T, Bischoff M, Brückner U, Gebhardt K, Henzler D, Hermes C, et al. [Short version S2e guidelines: "Positioning therapy and early mobilization for prophylaxis or therapy of pulmonary function disorders"]. Anaesthetist. 2015;64(8):596–611 doi: <https://doi.org/10.1007/s00101-015-0060-4>.
- There was no funding for this study.

Topic: Nursing care and physiotherapy

000735

Continuous monitoring of Mechanical Power through a clinical information system as a predictor of outcome in critically ill patients

N. Murillo Moreno¹, M. Ruiz-Botella², S. Canelles¹, A. Rodriguez¹, I. Victoria¹, O. Plans¹, M. Samper¹, M. Magrè¹; L. Claverias¹, M. Bodí¹, S. Manrique¹
¹ICU, Hospital Universitari de Tarragona Joan XXIII, Tarragona, Spain; ¹URV, Universitat Rovira i Virgili, Tarragona, Spain

Correspondence: N. Murillo Moreno
Intensive Care Medicine Experimental 2023, 11(Suppl 1):000735

Introduction: In the last decade, it has been postulated that mechanical power (MP) can produce ventilator-induced lung injury (VILI) and has a direct association with increasing mortality, days of invasive mechanical ventilation (IMV), and ICU length of stay (LOS). Most studies only monitor MP once or twice a day. However, IMV is a continuous process, so they may not be a reflection of the real scenario.

Objectives: Analyze if the continuous measurement of MP through the clinical information system (CIS) has prognostic value regarding mortality, days of IMV, and ICU LOS in critically ill patients.

Methods: Retrospective observational study conducted in a 28-bed mixed ICU in Spain. All patients who received more than 24 h of IMV at the ICU from September 2015 to July 2022 were included. All data was collected through the process of extraction, transformation, and loading from the CIS. In particular, respiratory variables were stored in the CIS every two minutes throughout the entire duration of the IMV. Every hour with MP > 18J/min was recorded. Univariate analyses were performed using Chi-square or U-Mann-Whitney tests appropriately. Patients were divided into two groups based on their median days on IMV and ICU LOS. Subsequently, multivariate logistic regression analyses and Pearson correlation were performed. Statistical significance was defined at p < 0.05. The analyses were performed using the R software.

Results: 10,874 patients were admitted on the ICU. 2,623 were included, 1,826 (70%) male, median age of 64 (53–72) years, median SOFA of 5 (4–7), median APACHE of 21 (15–25). 1,868 (64%) medical patients, 2,506 (95%) urgent admissions and 277 (11%) SARS COV-2. The mortality rate was 30% (733), median days of IMV were 6 (3–15) and median ICU LOS was 11 (5–22) days. 552 (21%) tracheostomized and 213 (8%) re-intubated. The median MP was 16 (13–21) and the median hours with MP > 18 J/min were 35 (8–125).

In non-COVID patients (n = 2,282), MP was not independently associated with higher mortality (OR = 1 (95% CI 1–1, p = 0.19)) (AUC 0.73). However, it was associated with > 5 days on IMV (OR = 1.03 (95% CI 1.02–1.03, p < 0.001)) (AUC 0.91) and > 9 days of ICU LOS (OR = 1.02 (95% CI 1.02–1.02, p < 0.001)) (AUC 0.82). The Pearson correlation coefficient between hours with MP > 18 J/min and days of IMV was 0.79 and between hours with MP > 18 J/min and ICU LOS was 0.71.

Similar results were found in COVID patients. MP was not independently associated with higher mortality (OR = 1 (95% CI 1–1, p = 0.18)) (AUC 0.7). However, more hours with MP > 18 J/min were associated

with over 18 days of IMV (OR = 1.01 (95% CI 1.01–1.01, p = < 0.001)) (AUC 0.81) and over 23 days of ICU LOS (OR = 1.01 (95% CI 1.01–1.01, p < 0.001)) (AUC 0.81). The Pearson correlation coefficient between hours with MP > 18 J/min and days of IMV was 0.72 and between hours with MP > 18J/min and ICU LOS was 0.68.

Conclusions: The number of hours with MP > 18J/min is not independently associated with higher mortality, but it is associated with an increased risk of spending more days on IVM and longer ICU LOS, both in COVID and non-COVID patients.

CIS provides an opportunity to obtain information from a scenario closer to reality in a more efficient manner.

UNIVARIATE DATA						
Variables	Died in ICU		Survived in ICU		P values	
	non-COVID (n=623)	COVID (n=82)	non-COVID (n=1659)	COVID (n=195)	non-COVID	COVID
General characteristics and severity of illness						
Male sex, n(%)	441 (71)	53 (65)	1145 (69)	147 (75)	0.44	0.09
Age (years), median (p25-p75)	67 (58-74)	70 (63-75)	62 (50-71)	63 (53-70)	<0.001	<0.001
SOFA, median (p25-p75)	6 (5-8)	5 (3-6)	5 (4-6)	4 (3-6)	<0.001	0.01
APACHE II, median (p25-p75)	24 (19-29)	17 (14-22)	20 (15-25)	14 (11-17)	<0.001	<0.001
SaO2/FiO2 1h within admission, median (p25-p75)	212 (166-274)	130 (118-140)	242 (188-286)	133 (121-151)	<0.001	0.08
Respiratory values						
Reintubation, n (%)	47 (7)	1 (1)	148 (9)	9 (5)	0.33	0.29
Hours with Pplateau >30, median (p25-p75)	2 (0.5-9)	98 (26-150)	1 (0.2-3)	8 (2-46)	<0.001	<0.001
Hours with DP >15, median (p25-p75)	28 (7-95)	218 (73-345)	10 (2-54)	65 (10-252)	<0.001	0.002
Hours with MP>18, median (p25-p75)	35 (10-125)	275 (150-503)	24 (5-84)	144 (61-397)	<0.001	0.004
Hours with TV >8ml/kgPBW, median (p25-p75)	59 (16-158)	75 (21-163)	60 (19-151)	94 (31-273)	0.72	0.1
MULTIVARIATE DATA						
Variables	OR		IC		P values	
	non-COVID	COVID	non-COVID	COVID	non-COVID	COVID
General characteristics						
Age	1.01	1.08	1-1.02	1.04-1.12	0.003	<0.001
SOFA at admission	1.2	1.07	1.1-1.2	0.93-1.23	<0.001	0.33
APACHE II	1.04	1.03	1.02-1.05	0.98-1.09	<0.001	0.25
SaO2/FiO2 1h within admission	1	---	1-1	---	---	0.28
Respiratory variables						
Hours with MP>18	1	1	1-1	1-1	0.19	0.18
Comorbidities						
Chronic kidney disease	1.8	2.59	1.2-2.8	1.04-1.12	0.008	<0.001
Diabetes	1.1	---	0.8-1.5	---	0.49	---
Chronic lung disease	1.2	---	0.8-1.7	---	0.46	---
Chronic heart disease	1.2	---	0.7-1.9	---	0.43	---
Hypertension	1.4	---	1.1-1.8	---	0.005	---

Appendix A. Table of Mortality rate by groups.

UNIVARIATE DATA						
Variables	IMV <7 dias	IMV 7-21 dias	IMV <18 dias	IMV 2-18 dias	P values	
	non-COVID (n=1063)	COVID (n=1219)	non-COVID (n=136)	COVID (n=141)	non-COVID	COVID
General characteristics and severity of illness						
Male sex, n(%)	744 (70)	842 (69)	95 (70)	105 (74)	0.67	0.47
Age (years), median (p25-p75)	64 (52-72)	63 (52-72)	65 (57-71)	65 (55-72)	0.32	0.93
SOFA, median (p25-p75)	5 (4-6)	6 (5-7)	4 (3-6)	5 (3-6)	<0.001	0.03
APACHE II, median (p25-p75)	22 (16-26)	21 (16-26)	15 (11-18)	15 (12-20)	0.4	0.35
SaO2/FiO2 1h within admission, median (p25-p75)	245 (192-286)	225 (167-280)	131 (120-146)	132 (120-146)	<0.001	0.99
Respiratory values						
Reintubation, n (%)	69 (6)	126 (10)	1 (1)	9 (6)	<0.001	0.02
Hours with Pplateau >30, median (p25-p75)	0.4 (0.2-1)	3 (1-12)	6 (1-27)	68 (10-168)	<0.001	<0.001
Hours with DP >15, median (p25-p75)	4 (1-15)	49 (10-145)	23 (5-104)	266 (100-497)	<0.001	<0.001
Hours with MP>18, median (p25-p75)	10 (2-24)	80 (25-183)	94 (39-176)	413 (217-666)	<0.001	<0.001
Hours with TV >8ml/kgPBW, median (p25-p75)	23 (8-46)	143 (62-250)	56 (14-98)	182 (54-374)	<0.001	<0.001
MULTIVARIATE DATA						
Variables	OR		IC		P values	
	non-COVID	COVID	non-COVID	COVID	non-COVID	COVID
General characteristics						
Age	0.99	1	0.98-1	0.97-1.03	0.05	0.97
SOFA at admission	1.05	1.1	1-1.11	0.93-1.3	0.05	0.27
APACHE II	0.97	0.93	0.95-0.99	0.86-0.99	0.001	0.03
Respiratory variables						
Hours with MP>18	1.03	1.01	1.02-1.03	1.01-1.01	<0.001	<0.001
Hours with TV >8ml/kgPBW	1.02	1	1.02-1.03	1-1.01	<0.001	0.02
Comorbidities						
Reintubation	1.31	7.26	0.83-2.05	0.63-123	0.25	0.47
IMC	1	---	1-1	---	0.71	---

Appendix B. Table of days on mechanical ventilation rate by groups.

UNIVARIATE DATA						
Variables	ICU LOS < 9 dias		ICU LOS ≥ 9 dias		P values	
	non-COVID	COVID	non-COVID	COVID	non-COVID	COVID
	(n=1111)	(n=1171)	(n=130)	(n=137)		
General characteristics and severity of illness						
Male sex, n(%)	773 (70)	813 (69)	96 (69)	104 (76)	0.97	0.21
Age (years), median (p25-p75)	64 (53-73)	63 (52-71)	65 (57-71)	64 (54-71)	0.14	0.41
SOFA, median (p25-p75)	5 (4-7)	5 (4-7)	4 (3-6)	4 (3-6)	0.004	0.09
APACHE II, median (p25-p75)	22 (16-26)	21 (16-26)	15 (12-18)	15 (12-20)	0.02	0.46
SO2/FiO2 1h within admission, median (p25-p75)	244 (191-285)	228 (167-281)	130 (118-145)	132 (121-146)	0.003	0.58
Respiratory values						
Reintubation, n (%)	42 (4)	153 (13)	1 (1)	9 (7)	<0.001	0.01
Hours with Pplateau >30, median (p25-p75)	0.5 (0.3-1)	3 (1-12)	7 (1-36)	64 (7-168)	<0.001	<0.001
Hours with DP >15, median (p25-p75)	5 (1-20)	45 (9-149)	30 (5-128)	366 (72-499)	<0.001	<0.001
Hours with MP>18, median (p25-p75)	11 (2-28)	78 (23-189)	101 (40-195)	413 (210-674)	<0.001	<0.001
Hours with TV >8ml/KgPBW, median (p25-p75)	24 (8-54)	142 (57-256)	59 (15-102)	182 (48-371)	<0.001	<0.001
MULTIVARIATE DATA						
Variables	OR		IC		P values	
	non-COVID	COVID	non-COVID	COVID	non-COVID	COVID
General characteristics						
Age	0.99	0.99	0.99-1	0.96-1.02	0.2	0.42
SOFA at admission	0.96	1.06	0.92-1.01	0.9-1.24	0.1	0.5
APACHE II	0.97	0.94	0.93-0.99	0.88-1	<0.001	0.06
SO2/FiO2 1h within admission	1	---	1-1	---	0.9	---
SO2/FiO2 ratio 1 h post intubation	---	1	---	0.99-1	---	0.47
Respiratory variables						
Hours with MP>18	1.02	1.01	1.02-1.02	1.01-1.01	<0.001	<0.001
Hours with TV >8ml/KgPBW	1.02	1	1.02	1-1	<0.001	0.04
Reintubación	4.98	8.08	3.27-7.67	0.9-182.39	<0.001	0.09

Appendix C: ICU length of stay (LOS) rate by groups

Appendix C: ICU length of stay (LOS) rate by groups.

References

- Mojoli F, Pozzi M, Bianzina S, Tavazzi G, Orlando A, Mongodi S, Torriglia F, Braschi A. Automatic monitoring of plateau and driving pressure during pressure and volume controlled ventilation. *Intensive Care Med Exp*. 2015 Oct 1;3(Suppl 1):A998. doi: <https://doi.org/10.1186/2197-425X-3-S1-A998>. PMID: PMC4798316.
- Serpa Neto A, Deliberato RO, Johnson AEW, Bos LD, Amorim P, Pereira SM, Cazati DC, Cordioli RL, Correa TD, Pollard TJ, Schettino GPP, Timenetsky KT, Celi LA, Pelosi P, Gama de Abreu M, Schultz MJ; PROVE Network Investigators. Mechanical power of ventilation is associated with mortality in critically ill patients: an analysis of patients in two observational cohorts. *Intensive Care Med*. 2018 Nov;44(11):1914-1922. doi: <https://doi.org/10.1007/s00134-018-5375-6>. Epub 2018 Oct 5. PMID: 30291378.
- Gattinoni L, Tonetti T, Cressoni M, Cadringer P, Herrmann P, Moerer O, et al. Ventilator-related causes of lung injury: the mechanical power. *Intensive Care Med*. 2016;42(10):1567-1575.

Topic: Acute respiratory failure and mechanical ventilation

000736

Methylprednisolone on intensive care unit patients with COVID-19 on mechanical ventilation

E. De Oliveira¹, J. M. A. D. Sousa², C. V. Gouvea², V. Malacize², L. Lobato², A. Yamaguti³, T. Guimaraes³, R. G. Rodrigues², M. C. S. D. Santos², M. A. Aquino², E. A. D. C. Rezende⁴

¹Pulmonology, INCOR, Brazil; ²Intensive Care Unit, IAMSPE - Instituto de Assistência Médica ao Servidor Público Estadual, São Paulo, Brazil; ³Infectology Department, IAMSPE - Instituto de Assistência Médica ao Servidor Público Estadual, São Paulo, Brazil; ⁴Chief in Charge, IAMSPE - Instituto de Assistência Médica ao Servidor Público Estadual, São Paulo, Brazil

Correspondence: M. A. Aquino

Intensive Care Medicine Experimental 2023, **11(Suppl 1)**:000736

Introduction: Corticoids were widely used to minimize the inflammatory response¹. SARS-CoV2 affects the lungs causing inflammation and diffuse alveolar damage. The corticoids can suppress inflammation and inhibit immune response². The primary objective is to evaluate 28-day mortality in patients in mechanical ventilation with SARS-CoV2. The secondary objectives are to correlate the risk of bloodstream infection and ventilator-associated pneumonia (VAP) and the time of mechanical ventilation, and the length stay in the intensive care unit (ICU) and the hospital.

Methods: A unicentric prospective randomized double-blinded study was designed to access the efficacy and the safety of

methylprednisolone in patients in mechanical ventilation due to COVID-19.

Results: 148 patients with SARS were screened, 112 underwent randomization. 58 to the methylprednisolone group and 54 patients to the placebo group. There was no significant difference in all-cause mortality at 28-days (46.7 in the methylprednisolone group vs 53.3% in the placebo group).

Methylprednisolone group had more extubation (67.2% vs 48.1%, $p=0.042$) and lower number of tracheostomies (5 vs 14, $p=0.015$). The median days in mechanical ventilation were lower in the methylprednisolone group (6 days vs 14 days, IC 95%, $p=0.012$), as well as the mean days in ICU (12.5 days + 10.54 vs 18.76 + 15.1, $p=0.043$). There was no significant difference in length hospital, bloodstream infection, or VAP.

Conclusions: In patients in mechanical ventilation due to SARS-CoV2, the use of methylprednisolone reduces the days in mechanical ventilation, ICU stay and favours early discharge.

References

- Ni YN, Chen G, Sun J, Liang BM, Liang ZA. The effect of corticosteroids on mortality of patients with influenza pneumonia: a systematic review and meta-analysis. *Crit Care* 2019;23:99.
- Arabi YM, Mandourah Y, Al-Hameed F, et al. Corticosteroid Therapy for Critically Ill Patients with Middle East Respiratory Syndrome. *Am J Respir Crit Care Med* 2018;197:757-67.
- Special acknowledgment to the residents whose contributes in data collection.

Topic: Acute respiratory failure and mechanical ventilation

000738

Association of vasopressors dose trajectories with enteral nutrition tolerance in patients with sepsis shock

L. Wang¹, K. Yan¹, W. Qin¹

¹Department of Critical Care Medicine, West China Hospital, Sichuan University, Chengdu, China

Correspondence: L. Wang

Intensive Care Medicine Experimental 2023, **11(Suppl 1)**:000738

Introduction: The optimal time to initiate enteral nutrition (EN) in patients with shock remains controversial. EN preserves intestinal barrier function in patients with septic shock, but introducing EN in the intestine where patients with sepsis shock are inherently at risk of inadequate perfusion may increase the risk of bowel-related complications or even non-occlusive bowel necrosis [1]. Current guideline recommendations and expert consensus suggest that initiating EN in patients with shock receiving low to moderate doses of vasopressors or at vasopressor dose equivalent scores > 12 [2, 3]. Vague definitions of vasopressor doses and the use of unvalidated scoring systems make guidelines and expert consensus less accurate guidance for clinical practice. Studies have reported that EN initiation in patients with shock was safe and feasible, and that the safety threshold of norepinephrine equivalent dose (NEQ) for initiating EN was < 0.3 µg/kg/min [4]. Most studies only reported the dose of norepinephrine or NEQ at a single time point. However, studies, describing the correlations between the long-term patterns of NEQ dose and EN tolerance in patients with shock, are limited.

Objectives: This study aimed to identify the NEQ trajectories and examine its correlations with FI in patients with sepsis shock.

Methods: This study prospectively enrolled the patients with sepsis shock requiring vasopressors from August 2020 to June 2022. The Growth Mixed Model was used to traverse longitudinal NEQ data at 6 h intervals and identify the latent trajectories of NEQ use in these patients. The primary endpoint was the occurrence of FI during the follow-up period (28 days after enrollment). FI was defined as the interruption of EN due to the presence of one of the following indications: vomiting/regurgitation, diarrhea, ileus, and suspected mesenteric ischemia/perforation. Kaplan-Meier survival curve analysis was performed to identify the cumulative risk for FI occurrence, and the log-rank test was used to test the differences among the groups.

Results: A total of 178 eligible patients with sepsis shock were included in this study. Consistent with the results of Growth Mixed Model, the model with three trajectory classes was the best. The trajectories of NEQ use in patients with sepsis shock are shown in Fig. 1 (a). Three trajectories of NEQ dose were identified and characterized by low-dose stable NEQ (L-NEQ, n=83), moderate-dose stable NEQ (M-NEQ, n=76), and rapidly rising NEQ (R-NEQ, n=19) with NEQ doses of 0.2, 0.4 and 0.6 µg/kg/min at EN initiation, respectively. The occurrences of FI within 3 days after EN initiation were 10.84%, 21.05%, and 52.63% in the L-NEQ, M-NEQ, and R-NEQ groups, respectively (P < 0.001). The total incidences of FI were 37.34%, 69.74%, and 73.68% in the L-NEQ, M-NEQ, and R-NEQ groups, respectively (P < 0.001) (Fig. 1(b)). As compared to the L-NEQ group, the risk of FI occurrence increased in the M-NEQ and R-NEQ groups (all P < 0.05) (Fig. 1(c, d)).

Conclusions: The risk of FI was significantly associated with NEQ trajectories in patients with sepsis shock. It might be appropriate to initiate EN when the NEQ dose is stabilized below 0.2 µg/kg/min in patients with sepsis shock.

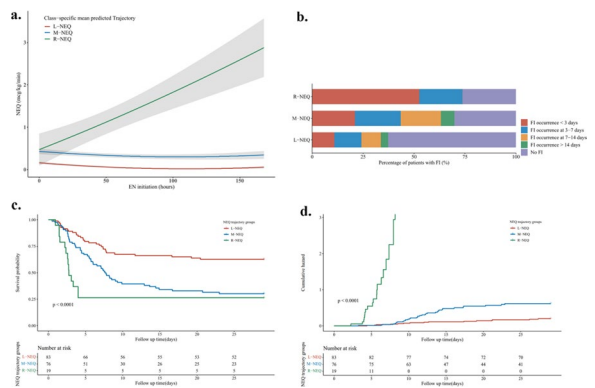

References

1. Patel JJ, Shukla A, Heyland DK. Enteral nutrition in septic shock: A pathophysiologic conundrum. *JPEN J Parenter Enteral Nutr.* 2021;45(S2):74–8. <https://doi.org/10.1002/jpen.2246>
2. Preiser JC, Arabi YM, Berger MM, Casaer M, McClave S, Montejo-Gonzalez JC, et al. A guide to enteral nutrition in intensive care units: 10 expert tips for the daily practice. *Crit Care.* 2021;25(1):424. <https://doi.org/10.1186/s13054-021-03847-4>
3. Bechtold ML, Brown PM, Escuro A, Grenda B, Johnston T, Kozeniecki M, et al. When is enteral nutrition indicated? *JPEN J Parenter Enteral Nutr.* 2022. <https://doi.org/10.1002/jpen.2364>
4. Wischmeyer PE. Enteral Nutrition Can Be Given to Patients on Vasopressors. *Critical care medicine.* 2020;48(1):122–5. <https://doi.org/10.1097/CCM.0000000000003965>
5. National Key R&D Program of China (2022YFC2504500), and the China National Key Research and Development Program (No. 2020AAA0105005).

Topic: Metabolism, endocrinology, liver failure and nutrition

000741

Kefir: the new frontier in critical care nutrition?

S. Rajendraprasad¹, S. Johnson², M. Ozkan¹, W. Freeman³, G. Ognjen¹, B. Bauer⁴, S. Khanna⁵, L. Karnatovskaia¹
¹Division of Pulmonary and Critical Care, Mayo Clinic, Rochester, United States of America; ²Research Services, Mayo Clinic, Rochester, United States of America; ³Division of neurosurgery and critical care, Mayo Clinic, Jacksonville, United States of America; ⁴Division of General Internal Medicine, Mayo Clinic, Rochester, United States of America; ⁵Division

of Gastroenterology, Department Of Internal Medicine, Mayo Clinic, Rochester, United States of America

Correspondence: S. Rajendraprasad
Intensive Care Medicine Experimental 2023, **11(Suppl 1)**:000741

Introduction: Having a diverse gut microbiota plays an integral role in our health. Over 90% of commensal organisms are lost within hours of critical illness. Loss of diversity and expansion of pathogenic strains is known as dysbiosis; it is linked with increased morbidity and mortality. Unlike probiotic supplements, fermented foods increase microbiome diversity in outpatient settings. Their effect on the microbiome of the critically ill has not been evaluated. Kefir (a fermented milk beverage) can be safely administered even via a nasogastric tube.

Objectives: We investigated the composition of the gut microbiome of the critically ill and the effect of giving kefir as a first step to using fermented foods to mitigate dysbiosis in the critically ill. We also assessed for any preliminary associations between antibiotics with anaerobic coverage and microbiota composition.

Methods: An open-label phase I investigation of kefir administered in escalating doses to adult critically ill patients with an intact gastrointestinal tract, starting with 60 mL, then 120 mL 12 h later, and followed by 240 mL/day onwards. We attempted to collect two stool samples at least 72 h apart after initiating kefir.

Results: 52 patients (mean age 64 years (range 23–88), 62% male) were enrolled. 43 patients received antibiotics with anaerobic coverage within 72 h of admission. We collected one stool sample from 26 patients and two samples from 14 patients (54 samples total). Of those, 21 received anaerobic antibiotics and 5 did not (only one patient without anaerobic antibiotic coverage had 2 stool samples). Taxonomic profiling revealed a single dominant phylum at each time point, in contrast to the 5–8 dominant phyla that typically make up the human gut microbiome. 76% of the reads were classified as belonging to 29 species. All timepoint 1 samples exhibited very low species richness (range: 3–29), orders of magnitude lower than a healthy human gut microbiome. Alpha diversity analysis of timepoint 1 samples showed no significant relationships between diversity and anaerobic coverage (Shannon: p = 0.71; Inverse-Simpson: 0.44; species richness: 0.82). Differential abundance analysis did not find any taxa associated with anaerobic coverage (FDR-adjusted p-value < 0.20). Lack of observed effect of anaerobic coverage on diversity could be due to having only one patient with two samples for comparison. Alpha diversity association analyses between timepoints 1 and 2 were inconclusive (Shannon: p = 0.21, Inverse-Simpson: 0.45, Observed: 0.18). Two subjects demonstrated 18 × and 20 × increases in species richness, indicating that a subgroup of patients may recover their microbiome even while in the ICU.

Conclusions: Critical illness is associated with a dramatic decrease in gut microbiome diversity. Randomized comparative studies are warranted to test the effect of kefir on the microbiome of the critically ill.

Taxa overview (Phylum)

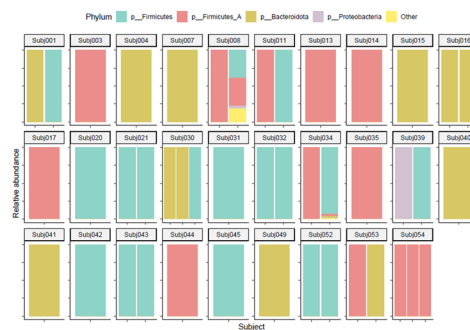

Y axis – phylum; x axis – time points (if one column = first sample only, 2 columns = samples 1 and 2 analyzed).

References

1. Szychowiak P, Villageois-Tran K, Patrier J, Timsit JF, Ruppé É. The role of the microbiota in the management of intensive care patients. *Ann Intensive Care*. 2022;12(1):3. Published 2022 Jan 5. <https://doi.org/10.1186/s13613-021-00976-5>
2. Wang MC, Zaydi AI, Lin WH, Lin JS, Liong MT, Wu JJ. Putative Probiotic Strains Isolated from Kefir Improve Gastrointestinal Health Parameters in Adults: a Randomized, Single-Blind, Placebo-Controlled Study. *Probiotics Antimicrob Proteins*. 2020;12(3):840–850. <https://doi.org/10.1007/s12602-019-09615-9>
3. Rodrigues KL, Caputo LR, Carvalho JC, Evangelista J, Schneedorf JM. Antimicrobial and healing activity of kefir and kefir extract. *Int J Antimicrob Agents*. 2005;25(5):404–408. <https://doi.org/10.1016/j.ijantimicag.2004.09.020>
4. Alberda C, Marcushamer S, Hewer T, Journault N, Kutsogiannis D. Feasibility of a *Lactobacillus casei* Drink in the Intensive Care Unit for Prevention of Antibiotic Associated Diarrhea and *Clostridium difficile*. *Nutrients*. 2018;10(5):539. Published 2018 Apr 26. <https://doi.org/10.3390/nu10050539>
5. Mayo Clinic Critical Care Research Committee
6. ZOLL Foundation Inc

Topic: Metabolism, endocrinology, liver failure and nutrition

000742

The initial fluid volume required for resuscitation of septic shock patients depends on the source of infection

R. Shi¹, S. Cappio Borlino², F. Moretto², E. Rocca², M. Fasan², W. Mongkolpun³, S. Carelli², C. Lai², JL. Teboul², X. Monnet²

¹AP-HP, Service de Médecine Intensive-Réanimation, Hôpital de Bicêtre, Université Paris-Saclay, Guangzhou, China; ²AP-HP, Service de médecine intensive-réanimation, Hôpital de Bicêtre, Université Paris-Saclay, DMU CORREVE, Inserm UMR S_999, FHU SEPSIS, Groupe de Recherche Clinique CARMAS, Le Kremlin-Bicêtre, France; ³Department of intensive care, Erasme Hospital, Université libre de Bruxelles, Bruxelles, Belgium

Correspondence: S. Cappio Borlino

Intensive Care Medicine Experimental 2023, **11(Suppl 1)**:000742

Introduction: The Surviving Sepsis Campaign recommends an initial volume expansion of 30 mL/kg in all septic shock patients. However, the fluid volume required initially may differ with the sepsis source, which induces various degrees of absolute and relative hypovolaemia. **Objectives:** We conducted a prospective observational study in septic shock patients in order to quantify the fluid volume received before the occurrence of preload unresponsiveness, i.e. a state in which fluid infusion does not increase cardiac output significantly.

Methods: In patients at initial phase of septic shock admitted in our intensive care unit, we repeatedly assessed preload responsiveness from inclusion, either through the response of cardiac output to a fluid bolus (143/222 measurements), or through a passive leg raising test (60/222 measurements), an end-expiratory occlusion test (13/222 measurements) or a tidal volume challenge (6/222 measurements). We quantified the volume of fluid received before the first occurrence of preload unresponsiveness.

Results: We enrolled 71 patients, whose demographical and clinical characteristics at baseline are presented in Table 1.

Table 1 (abstract 000742) Demographical and clinical characteristics at baseline

Variables	Study population (n = 71)
Age, years	64 (12)
Male sex, n. (%)	44 (62)
BMI, kg/m ²	27 (7)

Variables	Study population (n = 71)
SOFA score at ICU admission	8 (6–9)
Invasive mechanical ventilation at inclusion, n. (%)	28 (39)
Left ventricular ejection fraction at baseline, %	60 (50–65)
Noradrenaline support at inclusion, n. (%)	53 (75)
Noradrenaline dose at inclusion, mcg/kg/min	0.45 (0.27–1.13)
Volume of resuscitation fluid at inclusion, ml/kg	22 (12–36)

The source of infection was abdomen for 13 (18%) patients, lung for 29 (41%) patients, urinary tract for 15 (21%) patients, skin and soft tissues for 10 (14%) patients and miscellaneous for 4 (6%) patients. The time from shock diagnosis to inclusion was 425 (199–1000) minutes. Forty-four (62%) patients had been previously admitted to the emergency department and 25 (35%) had a history of significant fluid losses.

Only 49 (69%) patients were still preload-responsive at inclusion and, at this time, they had received 19 (12–33) mL/kg. They evolved into a non-responsive state after 29 (21–45) mL/kg of fluid infused from shock diagnosis. This volume was 37 (27–51) mL/kg for abdominal origin, 27 (19–41) mL/kg for pulmonary origin, 34 (23–61) mL/kg for urinary tract origin, 33 (19–36) mL/kg for cutaneous and soft tissues origin (Figure 1). Among the preload-responsive patients, 25 (51%) became preload unresponsive before receiving 30 mL/kg of fluid (median 20 [15–25] mL/kg) (Figure 2): 3 (50%) patients in the abdominal group, 13 (54%) patients in the pulmonary, 4 (50%) patients in the urinary, and 3 (43%) patients in the cutaneous.

Conclusions: The volume of resuscitation fluid required by septic shock patients at the initial phase seems to differ depending on the source of infection, abdominal sepsis requiring more fluid than others. Moreover a relevant number of patients with septic shock required a fluid resuscitation < 30 mL/kg from shock to preload unresponsiveness. The study is ongoing, but these primary results suggest a personalization of initial fluid therapy.

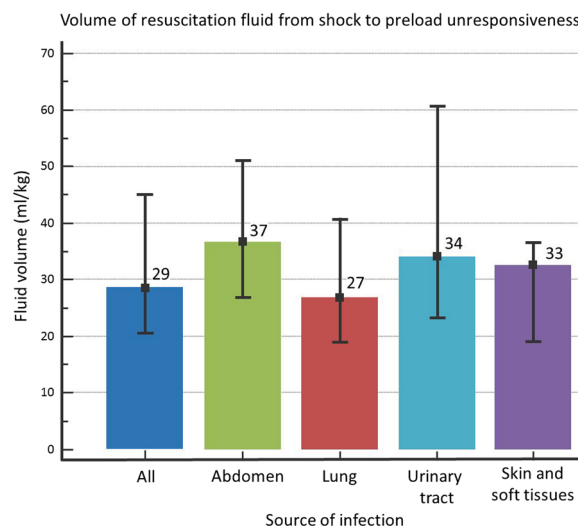

Figure 1 (abstract 000742) Volume of resuscitation fluid from shock to preload unresponsiveness, in patients still preload-responsive at inclusion (n = 49)

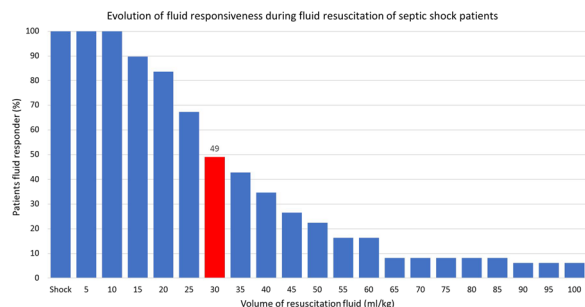

Figure 2 (abstract 000742) Evolution of fluid responsiveness during fluid resuscitation, in patient still preload-responsive at inclusion (n = 49)

Topic: Sepsis

000743

Percutaneous treatment of acute pulmonary thromboembolism, initial experience in the implementation of urgent rescue mechanical thrombectomy at Ramón y Cajal University Hospital

R. Marín Ráez¹, A. A. De Abreu Ramírez¹, M. García Godes¹, D. Muñoz-Mingarro Molina¹, O. González Fernández¹, E. Morales Sorribas¹, L. Fernández², J. Cobos², R. De Pablo¹

¹Intensive Care Medicine, Ramón y Cajal Hospital, Madrid, Spain;

²Radiology, Ramón y Cajal Hospital, Madrid, Spain

Correspondence: R. Marín Ráez

Intensive Care Medicine Experimental 2023, **11(Suppl 1)**:000743

Introduction: Acute pulmonary thromboembolism is a significant cause of morbidity and mortality, with an increasing incidence in recent years. We can use different therapeutic strategies according to the risk and the clinical situation of our patients, including mechanical thrombectomy.

Objectives: Evaluate the efficacy of rescue mechanical thrombectomy for the treatment of acute pulmonary thromboembolism.

Methods: We describe our experience with mechanical thrombectomy in high-risk PE from February 2021 to November 2022.

During this period of time, urgent thrombectomies were performed on 8 patients with high-risk PE, who had an average PESI score of 164, elevated troponin I concentrations with an average of 1.4ng/ml and an average d dimer of 2830 ng/ml.

77.7% of our patients were men, with a mean age of 53 years, 44.4% had HBP, 11.1% had an oncological disease, 33.3% were overweight, 22.2% were COPD, and 44.4% had a history of COVID infection in the last 3 months.

One of our patients had contraindication for fibrinolytic treatment.

Results: The main clots were treated with a fibrinolytic agent bolus and by rotating movements with the indigo[®] system commonly used for pulmonary angiography.

We could observe clinical and mechanical improvement after thrombectomy in 87.5% of our patients. The mean pulmonary artery pressure decreased from 43 to 33 mmHg after mechanical treatment.

3 of our patients suffered cardiorespiratory arrest and 2 of them needed temporary ECMO support.

One of them died 24 h after the procedure due to refractory shock with multiple organ failure after CPR. Another patient died during the procedure due to rethrombosis and technical difficulties. The rest of

our patients presented clinical and ultrasound improvement during their admission to the ICU, showing an improvement in the contractility of the right ventricle, with an average TAPSE before the thrombectomy of 13 mm and 17 mm after the procedure; on average they were on mechanical ventilation for 14 days.

There was no evidence of hemorrhagic complications related to the procedure, including hemorrhagic cerebrovascular events.

Conclusions: Mechanical thrombectomy in high-risk PE is a new therapeutic option that seems to have immediate positive hemodynamic effects. We need more studies to evaluate the efficacy of this therapy as a rescue for patients who have needed fibrinolysis before this procedure.

References

1. Konstantinides SV. 2019 ESC Guidelines for the diagnosis and management of acute pulmonary embolism developed in collaboration with the European Respiratory Society (ERS). *Eur Respir J*. 2019 Oct 9;54(3):1901647. doi: <https://doi.org/10.1183/13993003.01647-2019>. PMID: 31473594.
2. Intensive care medicine, Ramón y Cajal hospital

Topic: Acute respiratory failure and mechanical ventilation

000744

Evaluation of a near-peer multimodal point of care ultrasound course for novice practitioners

J. Mirams¹, W. Jenner¹, A. Osman¹, B. Hollos¹, S. Love¹, J. Davis¹, M. Jeffrey¹, A. W. Martinelli¹, A. Y. K. C. Ng¹

¹Addenbrooke's Hospital, Cambridge University Hospitals NHS Foundation Trust, Cambridge, United Kingdom

Correspondence: A. Y. K. C. Ng

Intensive Care Medicine Experimental 2023, **11(Suppl 1)**:000744

Introduction: The widespread availability of ultrasound machines in secondary care facilities has led to an increase in the use of point of care ultrasound in critical care. The development of unified accreditation frameworks such as FUSIC (The UK Intensive Care Society, ICS) and FAMUS (The UK Society for Acute Medicine) provide a useful training framework for practitioners to accredit in the use of ultrasound for limited applications, including the management of shock, diagnosis of acute lung injury, and for procedural applications. There is thus a growing and unmet need for multimodal ultrasound training courses that are affordable, effective, and deliverable at scale.

Objectives: To establish a course framework for the near-peer ultrasound teaching, and to assess both its efficacy in imparting basic sonographic skills to novice practitioners.

Methods: A standardised one-day course comprising lectures and practical stations was organised to deliver the basic elements of the following point of care modalities: echocardiography, lung ultrasound, vascular ultrasound, and abdominal ultrasound, based on the ICS accreditation framework. We designed a timed, structured assessment to obtain standardised views of normal structures in a healthy volunteer, marked on a 30-point scale, and including all four modalities. Consenting participants underwent this assessment before and after the course, and were marked by an examiner who did not prompt or help the candidates apart from introducing the key functions of the machine to them.

Results: 34 participants underwent our structured pre-course and post-course assessment. The median score of the pre-test assessment was 46.7%, which was evenly distributed amongst the four modalities. Candidates were most familiar with vascular ultrasound with a median score of 64.2%, while candidates were least familiar with abdominal

ultrasound with a median score of 28.6%. Candidate scores improved by 48.3%, achieving a median score of 95% after the course, which was statistically significant ($p < 0.0001$, Wilcoxon), and there was significant improvement in all four modalities.

Conclusions: Here we present evidence that a near-peer ultrasound course significantly and effectively improves novice practitioners' ability to identify key anatomical structures using point of care ultrasound. The cost to deliver the course was £50 per participant, making this a cost effective and economically scalable course. We aim to validate these findings in a wider cohort, and to examine longitudinal retention of these skills in trainees accrediting in point of care ultrasound.

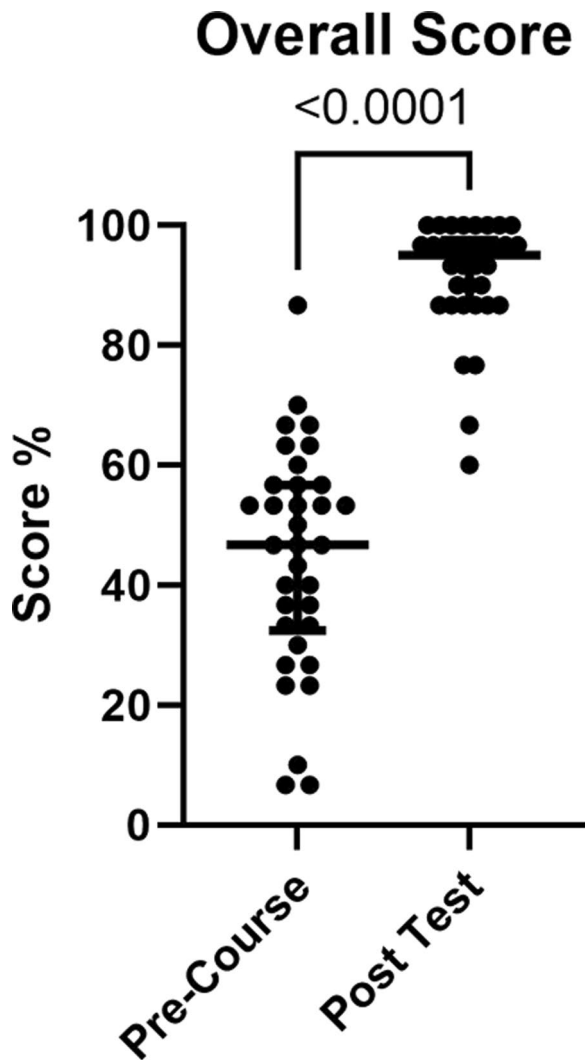

Pre-Course and post-course test scores (percentage) are shown in this Fig. 34 individuals underwent structured assessment scored by non-prompting examiners before and after the course delivery. Individual scores are shown as dots, and the median score and interquartile range are shown as a horizontal line and error bars. There was a significant improvement in performance after sitting the course (Wilcoxon).

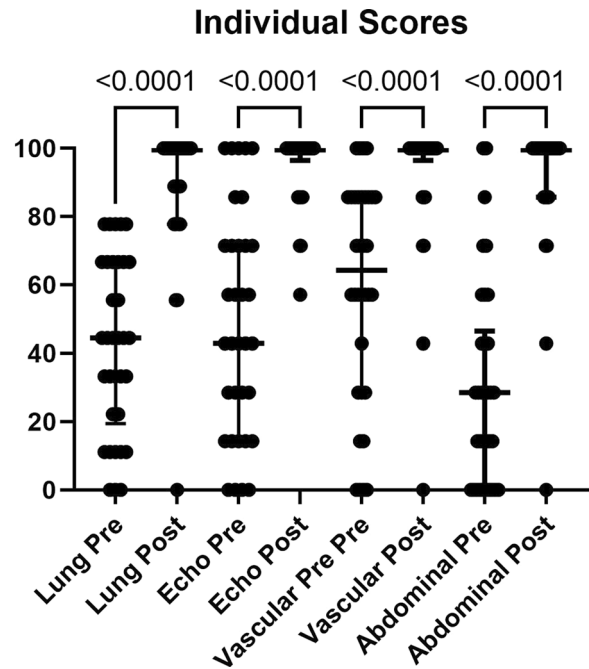

Pre-Course and post-course test scores (percentage) for each individual modality are shown. 34 individuals underwent structured assessment scored by non-prompting examiners before and after the course delivery. Individual scores are shown as dots, and the median score and interquartile range are shown as a horizontal line and error bars. There was a significant improvement in performance after sitting the course (Kruskal–Wallis).

References

1. Zielecki L, et al. Point-of-care ultrasound in intensive care units: assessment of 1073 procedures in a multicentric, prospective, observational study. *Intensive care medicine* 2015;41:1638–47.

Topic: Cardiovascular issues in ICU

000745

Review of Takotsubo cardiomyopathy in orthotopic liver transplantation

S. Kim¹, K. Takhtehchian²

¹Surgery, University of Illinois at Chicago, Chicago, United States of America; ²Anesthesiology and Intensive Care Medicine, University of Illinois Hospital, Chicago, United States of America

Correspondence: S. Kim

Intensive Care Medicine Experimental 2023, **11(Suppl 1)**:000745

Introduction: Orthotopic liver transplantation presents challenges from a preoperative to postoperative standpoint given their underlying comorbidities and large volume hemodynamic changes that occur in the perioperative period. One of the repercussions of such large hemodynamic changes include Takotsubo cardiomyopathy, a transient acute left ventricular dysfunction secondary to nonischemic cardiac stress. Though this condition may occur in the setting of various physiological and psychological stressors, this condition has

previously been thought to be transient with low mortality. However, the known cases in the setting of liver transplants often noted higher levels of morbidity and mortality.

Objectives: Here we do a thorough literary review thus far to discuss the appropriate workup and management of Takotsubo cardiomyopathy and analyze for common risk factors among patients who underwent a liver transplant.

Methods: A systemic literature review was conducted with searches made on databases such as PubMed, Google Scholar, and Embase.

Results: Takotsubo cardiomyopathy in setting of liver transplant patients have been associated with higher morbidity and mortality and often requiring more supportive measures. Despite this higher risk of complications, the current diagnostic approach is similar to that of patients who develop this condition from different etiologies. Even among liver transplant patients, those who developed Takotsubo cardiomyopathy had more complicated underlying cirrhotic disease or perioperative complications.

Conclusions: Many known cases of Takotsubo cardiomyopathy in setting of liver transplantation have been published in case reports and series. Despite this, the leading cause of death in liver transplants, especially in cases of advanced cirrhosis, is cardiovascular complications. Further studies on Takotsubo cardiomyopathy should aim to evaluate predictors of morbidity and mortality and discuss the benefits and risks of mechanical circulatory support as well as continue to highlight this rare diagnosis in this high-risk population.

References

1. Templin C, Ghadri JR, Diekmann J, et al. Clinical features and outcomes of Takotsubo (stress) cardiomyopathy. *N Engl J Med* 2015;373:929–38.
2. Agarwal S, Bean MG, Hata JS, Castresana MR. Perioperative Takotsubo cardiomyopathy: a systematic review of published cases. *Semin Cardiothorac Vasc Anesth* 2017;21:277–90
3. Boyd, Brenton MMSc, PA-C; Solh, Tia MSPAS, PA-C. Takotsubo cardiomyopathy: Review of broken heart syndrome. *JAAPA* 33(3):p 24–29, March 2020. | doi: <https://doi.org/10.1097/01.JAA.0000654368.35241.fc>
4. Authors have no conflicts of interest, financial ties or funding/support to disclose.
5. Caturegli G, Crane MA, Etchill E, Giuliano K, Nguyen M, Philosophe B, Cho SM, Wittstein IS, Whitman GJR. Stress-Induced (Takotsubo) Cardiomyopathy After Liver Transplant Rescued with Venoarterial Extracorporeal Membrane Oxygenation. *ASAIO J*. 2022 Apr 1;68(4):e66–e68. doi: <https://doi.org/10.1097/MAT.0000000000001453>. PMID: 35349528.
6. Vitin AA, Pennington MW, Bowdle TA, Rayhill SC, Sibulesky L, Reyes JD, McCabe JM. Stress (Takotsubo) Cardiomyopathy During Liver Transplantation: Case Study and Literature Review. *Transplant Proc*. 2018 Jan-Feb;50(1):211–216. doi: <https://doi.org/10.1016/j.transproceed.2017.11.017>. PMID: 29407311.
7. Yang J, Rao Z, Hong F, et al. Takotsubo syndrome after liver transplantation: an association with intraoperatively administered epinephrine and fentanyl. *Clin Transplant* 2021;35:e14463.
8. Yataco ML, Difato T, Bargehr J, Rosser BG, Patel T, Trejo-Gutierrez JF, Pungpapong S, Taner CB, Aranda-Michel J. Reversible non-ischaemic cardiomyopathy and left ventricular dysfunction after liver transplantation: a single-centre experience. *Liver Int*. 2014 Jul;34(6):e105–10. doi: <https://doi.org/10.1111/liv.12501>. Epub 2014 Mar 15. PMID: 24,529,030.
9. Zmaili M, Alzubi J, Alkhayyat M, Cohen J, Alkharabsheh S, Rana M, Alvarez PA, Mansoor E, Xu B. Takotsubo cardiomyopathy in orthotopic liver transplant recipients: A cohort study using multi-center pooled electronic health record data. *World J Hepatol*. 2022 Feb 27;14(2):400–410. doi: <https://doi.org/10.4254/wjh.v14.i2.400>. PMID: 35,317,180; PMCID: PMC8891665.
10. Rahman S, Mallett SV. Cirrhotic cardiomyopathy: Implications for the perioperative management of liver transplant patients. *World J Hepatol*. 2015 Mar 27;7(3):507–20. doi: <https://doi.org/10.4254/wjh.v7.i3.507>. PMID: 25,848,474; PMCID: PMC4381173.
11. Bachayev M, Brereton B, Mondal A, Alli-Ramsaroop BA, Dhakal R, Leon MCB, Quinones CM, Abdelal MEO, Jain A, Dhakuk K, Desai R. Takotsubo Syndrome in Orthotopic Liver Transplant: A Systematic Review and Pooled Analysis of Published Studies and Case Reports. *Transplant Proc*.

2023 Feb 27;S0041-1345(22)00778–3. doi: <https://doi.org/10.1016/j.transproceed.2022.11.005>. Epub ahead of print. PMID: 36,858,907.

Topic: Cardiovascular issues in ICU

000746

Telemedicine ICU rounds as a strategy to improve respiratory support practices during COVID-19 pandemics in Brazil

T. Dias Midega¹, L. C. P. D. Azevedo², F. Hohmann¹, R. C. D. F. Chaves¹, I. Tsuji¹, L. J. Rolim Ferraz¹, T. Domingos Corrêa¹, M. C. Santos³, R. Albaladejo Morbeck⁴, E. Araújo Camboim⁵, N. Nogueira Machado⁶, R. F. B. Melo⁷, J. P. O. Feliciano⁸, B. M. Cardoso⁹, A. José Pereira³

¹Department of Critical Care Medicine, Albert Einstein Israelite Hospital, São Paulo, Brazil; ²Academic Research Organization, Albert Einstein Israelite Hospital, São Paulo, Brazil; ³Department of Tele-UTI, Albert Einstein Israelite Hospital, São Paulo, Brazil; ⁴Department of Telemedicine, Albert Einstein Israelite Hospital, São Paulo, Brazil; ⁵Department of Critical Care Medicine, Hospital Metropolitan Sul Dom Helder Câmara, Cabo de Santo Agostinho, Brazil; ⁶Department of Critical Care Medicine, Santa Casa de Misericórdia do Pará, Belém, Brazil; ⁷Department of Critical Care Medicine, Hospital Santa Lúcia, Poços de Caldas, Brazil; ⁸Department of Critical Care Medicine, Dom Orione Hospital, Araguaína, Brazil; ⁹Department of Critical Care Medicine, Hospital Municipal Senhora Santana, Brasília de Minas, Brazil

Correspondence: F. Hohmann

Intensive Care Medicine Experimental 2023, **11(Suppl 1)**:000746

Introduction: Human resource constraints for ICU care during COVID-19 pandemics caused significant burden for patients in Brazil and worldwide (1,2). Lack of experts caused the need for alternative strategies like telemedicine (3). The Tele-ICU COVID-19 Brazil program was created to offer remote assistance to guide daily multidisciplinary rounds (Tele-rounds) discussions in public COVID-19 ICUs in Brazil. The program consisted in daily Tele-rounds of systematic patient-centered discussions with the remote intensivist and the local ICU multidisciplinary team to establish joint therapeutic goals for the next 24 h of care and to improve adherence to evidence-based best practices.

Objectives: To evaluate the association between the participation in the Tele-rounds during Tele-ICU COVID-19 Brazil program, and the use of respiratory support, and protective mechanical ventilation in the participating ICUs.

Methods: Prospective study with 16 ICUs participants of Tele-ICU COVID-19 Brazil program (March to November 2020). To explore the Tele-ICU impact, we calculated *Tele-round ratio*, as follows: the number of rounds per patient divided by patient's ICU length of stay. Tele-round groups were defined as high, intermediate, or low (intensities) when *Tele-round ratios* were higher than 66%, between 33 and 66% or lower than 33%, respectively. Protective mechanical ventilation was defined as the report of Tidal volume < 6 ml/kg and Driving pressure < 15 mmHg during invasive mechanical ventilation (MV). Data were collected by the remote intensivist during Tele-round. We compared the use of invasive and non-invasive ventilation during ICU stay and the use of protective MV between the groups. Two-tailed non-parametric tests were used, and $p < 0.05$ was considered statistically significant.

Results: 1680 patients were included in this study, out of those 769 were submitted to invasive MV. 56.4% were male, the mean age was 66 (55–76) years and SOFA score was 4 (1–9). Hospital mortality was 51.1%. Groups comparisons showed about 150% higher use of non-invasive ventilation high Tele-round group, than and low Tele-round groups ($P < 0.001$) and about 30% less need of invasive mechanical ventilation ($P < 0.008$). Parameters of protective MV were not different between the groups - Table 1.

Conclusions: During Tele-ICU COVID-19 Brazil program, there was a significant association between the proportion of Tele-rounds with more frequently non-invasive ventilation use and less frequent need of invasive MV.

Table 1 (abstract 000746) Comparisons between the defined groups

	Low Tele-round group	Intermediate Tele-round group	High Tele-round group	p [*]
N= 1680	518	747	415	
SOFA score during the first 24h of ICU admission, n=841/1680, (median [IQR])	2 (0-7)	2 (0-5)	2 (0-4)	0.348 [#]
SOFA score during the first 72h of ICU admission, n=1368/1680, (median [IQR])	5 (1-9)	4 (2-8)	3 (0-7)	0.008 [#]
Support during ICU stay, n(%)				
Mechanical ventilation	259 (63.6)	361 (58.6)	149 (45.0)	<0.001 [#]
Noninvasive ventilation	30 (7.4)	81 (13.1)	57 (17.2)	<0.001 [#]
Patients who received invasive MV, n/total n (%)				
Protective MV	187/259 (72.2)	268/361 (74.2)	100/149 (67.1)	0.264 [#]

Values represent median (IQR) or n/n total (%). SOFA score: sequential organ failure assessment score, ranges from 0 to 24, with higher scores indicating more severe organ dysfunction; MV: mechanical ventilation. * P values were calculated using [#]Mann-Whitney U test, [#]X² test.

References

1. Van Damme W, Dahake R, Delamou A, Ingelbeen B, Wouters E, Vanham G, et al. The COVID-19 pandemic: diverse contexts; different epidemics-how and why? *BMJ Glob Health*. 2020;5(7). 2. Bastos LS, Ranzani OT, Souza TML, Hamacher S, Bozza FA. COVID-19 hospital admissions: Brazil's first and second waves compared. *Lancet Respir Med*. 2021;9(8):e82-e3. 3. Vranas KC, Slatore CG, Kerlin MP. Telemedicine coverage of intensive care units: a narrative review. *Ann Am Thorac Soc* 2018;15:1256-64.
2. We thank all the members of the multidisciplinary team of the participants ICUs. Project supported by the Brazilian Ministry of Health – Institutional Developing Support Program of the Brazilian Health Unified System (PROADI-SUS).

Topic: Acute respiratory failure and mechanical ventilation

000747

Imaging of regional ventilation/perfusion ratios using electrical impedance tomography

T. Muders¹, B. Hentze¹, C. Wildström², A. Larsson³, S. Leonhardt⁴, C. Putensen¹

¹Department of Anesthesiology and Intensive Care Medicine, University Hospital Bonn, Bonn, Germany; ²Department of Hospital Physics, Uppsala University Hospital, Uppsala, Sweden; ³Surgical Sciences Department, Hedenstierna Laboratory, Uppsala University, Uppsala, Sweden; ⁴Chair for Medical Information Technology, Helmholtz-Institute for Biomedical Engineering, RWTH Aachen University, Aachen, Germany

Correspondence: T. Muders

Intensive Care Medicine Experimental 2023, **11(Suppl 1)**:000747

Introduction: Electrical impedance tomography (EIT) is a clinically established real-time imaging technique for bedside monitoring of regional ventilation (V) of the lung (1). In addition, EIT allows measurement of regional pulmonary perfusion (Q) (1). Therefore, the determination of regional V/Q ratios using EIT is possible (2). However, validation against a reference procedure is necessary for routine clinical application.

Objectives: To validate EIT-based regional V/Q imaging using single-photon emission computed tomography (SPECT) in a porcine model.

Methods: After approval by the local animal ethics committee (5.8.18–15.771/2017, Uppsala, Sweden), V and Q defects were generated by segmental bronchial and pulmonary arterial balloon blockade, respectively, in 7 anesthetized, ventilated pigs. Regional V and Q measurements were obtained by EIT (Pulmoviata 500) after electrolyte bolus injection (10 ml NaCl 1molar) (3) and SPECT (V: 81mKr gas; Q: 99mTc-MA albumin) (4). We analyzed the similarity of V and Q images (pixel-wise linear image correlation, r) and the regional (3 × 3 regions) agreement (Bland-Altman analysis: correlation coefficient r, limits of agreement LoA) of the quantitative V_Q and V/Q signals between SPECT and EIT, and between SPECT and calibrated EIT (cEIT) after compensation of local EIT imaging errors using pixel-wise backward regression.

Results: Fig. 1 shows example images with detectable V and Q defects, and their effects on the regional V/Q ratio. Image agreement between EIT and SPECT was strong (r = 0.77) for V and moderate r = 0.62 for Q and was significantly improved by calibration of EIT (V: strong, r = 0.89; Q: very strong, r = 0.93). EIT calibration also significantly improved the agreement of regional quantitative analyses of V, Q, and V/Q signals (data as r/LoA. EIT vs SPECT: V: 0.83/9.1%, Q: 0.76/15.4%, V/Q: 0.50/0.87 logV/Q; cEIT vs SPECT: V 0.92/6.0%, Q: 0.95/6.1%, V/Q: 0.85/0.50 logV/Q).

Conclusions: The regional V and Q imaging by means of EIT exhibits small regional aberrations. These are amplified during the pixel-wise division of the individual V and Q signals, which causes a bias of the regional V/Q image. Calibration of the EIT-based V and Q images significantly improves the agreement of the quantitative regional V/Q analysis. While the qualitative detection of V and Q defects, as well as their effects on the regional V/Q, is possible by EIT, the quantitative regional V/Q analysis requires calibration of EIT.

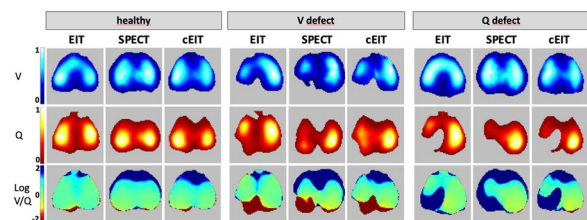

Fig. 1 (abstract 000747) Visualization of regional ventilation and perfusion defects using electrical impedance tomography (EIT), single-photon emission computed tomography (SPECT), and calibrated EIT (cEIT). Top row: relative regional ventilation (V); middle row: relative regional perfusion (Q); bottom row: weighted regional V/Q ratio, logarithmic color scale: Zero corresponds to a V/Q of 1:1, 2 corresponds to V/Q = 100:1 (dead space), -2 corresponds to V/Q = 1:100 (shunt)

References

1. (3) Hentze B, Muders T, Hoog Antink C, Putensen C, Larsson A, Hedenstierna G, et al. A model-based source separation algorithm for lung perfusion imaging using electrical impedance tomography. *Physiol Meas* 2021;42:084001.
2. (4) Muders T, Luepschen H, Meier T, Reske AW, Zinserling J, Kreyer S, et al. Individualized Positive End-expiratory Pressure and Regional Gas Exchange in Porcine Lung Injury. *Anesthesiology* 2020;132:808–824.
3. (1) Putensen C, Hentze B, Muenster S, Muders T. Electrical Impedance Tomography for Cardio-Pulmonary Monitoring. *J Clin Med* 2019;8:1176.
4. (2) Borges JB, Alcalá GC, Mlček M. A Step Forward toward a Bedside and Timely Monitoring of Regional V/Q. *Matching*. *Am J Respir Crit Care Med* 2020;202:1342–1344

Topic: Acute respiratory failure and mechanical ventilation

000748

Nationwide Cohort Study on Coronavirus-19 Associated Aspergillosis in hospitalized patients: Risk factors, incidence, and prognosis using the Spanish National Health System's Hospital Discharge Records Database

S. Barakat Fernández¹, C. Risco Risco², L. Pérez Bastida¹, M. Alvarez Torres¹, A. Corbato García¹, L. E. Benitez Garzon¹, A. González Salamanca¹, M. Ortega Sáez¹, F. J. Manuel Merino¹, E. Domínguez Pardo³, A. Alvarez Ruiz¹, D. Andaluz Ojeda¹

¹Intensive care, General Hospital Río Carrión, Palencia, Spain; ²Internal Medicine, HM Sanchinarro University Hospital, Madrid, Spain; ³Intensive care, HM Sanchinarro University Hospital, Madrid, Spain

Correspondence: S. Barakat Fernández

Intensive Care Medicine Experimental 2023, **11(Suppl 1)**:000748

Introduction: COVID-19-associated pulmonary aspergillosis (CAPA) is a new disease where *Aspergillus* infects COVID-19 patients in critical

states with ARDS and mechanical ventilation. CAPA raises mortality rates, posing a severe threat to affected individuals. Our study examines CAPA incidence, contributing factors, and potential impact on prognosis in patients admitted to all Spanish hospitals during the first three pandemic waves. We aimed to identify risk factors that predict mortality, disease severity, and ICU admission.

Methods: We analyzed data from the Spanish National Health System's Hospital Discharge Records Database (NHSHDRD) of all COVID-19 patients admitted in 2020. We collected data on patients with pulmonary aspergillosis as a secondary infection using ICD-10-CM. Multivariate logistic regression analysis was conducted to design predictive models for CAPA development in COVID-19 hospitalized patients and to identify the main factors related to severity and mortality in this patient subgroup.

Results: Out of 252,114 patients, 0.27% developed *Aspergillus* superinfection, with the majority being male (73.8%) and over 60 years old (78.2%). Mortality was notably higher in patients admitted to the ICU (61.8%) than those who were not (34.5%) ($p < 0.0001$), with an overall mortality rate of 53.3%.

Multivariate logistic regression analysis identified these risk factors for CAPA development: ICU admission (OR 3.857; 95% CI 2.87–5.18), leukemia (OR 5.86; 95% CI 3.86–8.921), lymphoma (OR 2.781; 95% CI 1.495–5.176), multiple myeloma (OR 4.465; 95% CI 2.212–9.02), COPD (OR 2.28; 95% CI 1.846–2.819), transplantation (OR 2.294; 95% CI 1.29–4.07), sepsis (OR 2.144; 95% CI 1.771–2.596), asthma (OR 1.88; 95% CI 1.407–2.534), ARDS (OR 1.894; 95% CI 1.582–2.268), mechanical ventilation (OR 5.91; 95% CI 4.385–7.973), age (OR 1.177; 95% CI 1.10–1.25), and sex (OR 1.374; 95% CI 1.147–1.646); all significant at $p < 0.0001$. Logistic model predicts CAPA development with an AUROC of 0.903.

Additionally, logistic regression analysis identified several predictors of hospital mortality: *Aspergillus* infection (OR 1.913; 95% CI 1.592–2.299), age (OR 2.506; 95% CI 2.477–2.535), sex (OR 1.4; 95% CI 1.365–1.435), admission to the ICU (OR 2.2; 95% CI 2.085–2.331), mechanical ventilation (OR 2.62; 95% CI 2.46–2.79), ARDS (OR 2.436; 95% CI 2.32–2.56), sepsis (OR 4.748; 95% CI 4.469–5.045), leukemia (OR 1.454; 95% CI 1.298–1.628), lymphoma (OR 1.692; 95% CI 1.484–1.928), multiple myeloma (OR 1.958; 95% CI 1.633–2.347), and transplantation (OR 2.273; 95% CI 1.99–2.596), all significant at $p < 0.0001$. Logistic model predicts CAPA mortality with an AUROC of 0.835.

	Aspergillus (N = 675)	No Aspergillus (N = 251,439)	P-value
ICU Admission	466 (69%)	22,491 (8.9%)	$p < 0.0001$
Mechanical Ventilation	449 (66.5%)	15,211 (6%)	$p < 0.0001$
COPD	117 (17.3%)	19,090 (7.6%)	$p < 0.0001$
ARDS	261 (38.7%)	11,682 (4.6%)	$p < 0.0001$
Sepsis	174 (25.8%)	6,227 (2.5%)	$p < 0.0001$
Leukemia	26 (3.9%)	1,786 (0.7%)	$p < 0.0001$
Lymphoma	11 (1.6%)	1,490 (0.6%)	$p < 0.0001$
Multiple Myeloma	9 (1.3%)	687 (0.3%)	$p < 0.0001$
Asma	52 (7.7%)	13,274 (4.3%)	$p = 0.005$

Conclusions: Based on the Spanish NHSHDRD data, the incidence of CAPA among hospitalized patients was low. Our study highlights the significantly elevated risks of mortality, ICU admission, and mechanical ventilation in this patient cohort. We identified several independent risk factors for the development of CAPA and hospital mortality, including age, gender, mechanical ventilation, sepsis, ARDS, leukemia, lymphoma, multiple myeloma, and transplantation. Our findings provide a valuable predictive tool for predicting the emergence of CAPA and unfavorable clinical outcomes in this particular group of patients.

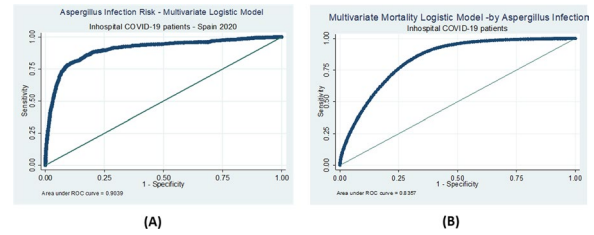

A). Multivariate Logistic Model predicting CAPA development (AUROC = 0.903).
 B). Multivariate Logistic Model predicting CAPA mortality (AUROC = 0.835).

Topic: Infections and prevention

000750

ROX index to predict successful extubation in high-risk postextubation failure patients with high-flow nasal cannula

T. Sathirarat¹

¹Pulmonary and Critical Care Medicine, Phramongkutklao Hospital, Bangkok, Thailand

Correspondence: T. Sathirarat

Intensive Care Medicine Experimental 2023, **11(Suppl 1)**:000750

Introduction: After critically ill patient was extubated, there was a rate of reintubation of 20% within 48 h due to hypoxemia being the primary cause. The use of high-flow nasal cannula (HFNC) is a widely used alternative to prevent intubation, and may result in delayed reintubation. The ROX index (ratio of SpO₂/FiO₂ to breathing frequency) has been validated to predict HFNC success in subjects with hypoxemic respiratory failure. However, this index has not been testing in postextubation patients, may be useful to reduce the chance of unnecessary reintubation or delayed reintubation.

Objectives: Validate test performance of ROX Index and the cut-off value to predict successful extubation in high-risk extubation failure patients treated with HFNC.

Methods: Prospective observational cohort study was conducted from Jan 1, 2022-Jan 1, 2023, with high-risk postextubation patients in medical ICU. The performance of ROX index in predicting successful extubation was evaluated.

Results: 68 subjects were included: 57 in success extubation group and 11 in reintubation group, age 74.5 ± 11.8 years. ROX index at 2 h > 9.9, at 6 h > 10.3 and at 12 h > 10.5 predict successful extubation, with sensitivity 89.7%, 93.1%, and 100%, specificity 54.6%, 72.7%, and 72.7%, area under the ROC values of 0.79, 0.90 and 0.87, respectively.

Conclusions: ROX index has a good diagnosis accuracy. The cut-point values of ROX index in this study presented a good performance to predicts success extubation in the high-risk postextubation failure patients.

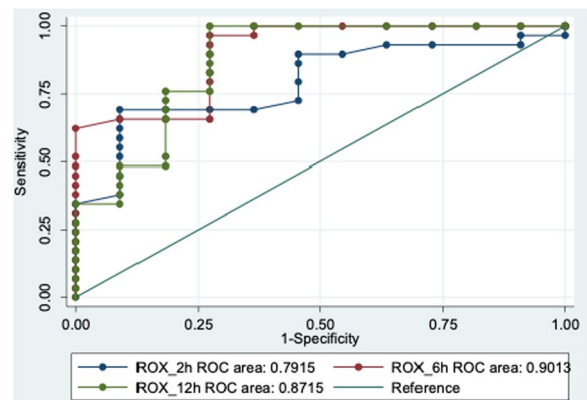

Topic: Acute respiratory failure and mechanical ventilation

000751

Blood-based biomarkers of brain injury: re-application of a prognostic tool for the diagnosis of impaired oxygen diffusion into the brain

R. Hoiland¹, C. Howe², S. Stukas³, T. Gibbons², T. Schoenthal⁴, S. Thiara⁴, J. Cooper³, D. Foster⁴, R. Grey⁴, P. Gooderham⁵, D. Griesdale¹, C. Wellington³, P. Ainslie², M. Sekhon⁴

¹Department of Anaesthesiology, Pharmacology and Therapeutics, The University of British Columbia, Vancouver, Canada; ²School of Health And Exercise Sciences, The University of British Columbia - Okanagan Campus, Kelowna, Canada; ³Department of pathology and laboratory medicine, The University of British Columbia, Vancouver, Canada; ⁴Division of Critical Care Medicine, Department of Medicine, The University of British Columbia, Vancouver, Canada; ⁵Department of Neurosurgery, Vancouver General Hospital, Vancouver, Canada

Correspondence: R. Hoiland

Intensive Care Medicine Experimental 2023, **11(Suppl 1)**:000751

Introduction: Determining if a neuro-critically ill patient is suffering cerebral tissue hypoxia-mediated secondary brain injury is imperative to guiding their clinical care. However, cerebral tissue hypoxia may arise due to a multitude of pathophysiologic factors that manifest as impairments in convective and/or diffusive cerebral oxygen delivery but are as of yet detectable at the bedside.

Objectives: We aimed to determine the utility of blood-based biomarkers of brain injury as a method to detect impairments in the diffusion of oxygen from the cerebral vasculature into the brain (i.e. O₂ diffusion).

Methods: Radial artery and internal jugular vein blood gas and brain injury biomarker analyses were performed in 12 healthy controls and 14 comatose patients with a hypoxic-ischemic brain injury (HIBI) following cardiac arrest. We measured cerebral blood flow (controls & HIBI patients) and brain tissue oxygen tension (PbtO₂; HIBI only) prior to, and during, a ~10 mmHg reduction in arterial carbon dioxide tension (i.e., hypocapnia). The functionality of O₂ diffusion was defined as the slope of the relationship between the hypocapnia induced change in cerebral oxygen extraction fraction (O₂EF) and cerebral blood flow ($\Delta O_2EF\% \cdot \Delta mL^{-1} \cdot min^{-1}$). The mean \pm standard deviation for O₂ diffusion in the controls was used to calculate O₂ diffusion Z-scores for controls and patients. A Z-score > 1.65, indicating an O₂ diffusion that would be worse than 95% of a control population, was considered impaired O₂ diffusion.

Results: O₂ diffusion was impaired in HIBI patients with cerebral tissue hypoxia (PbtO₂ < 20 mmHg; -0.19 [-0.26 - -0.11] % · mL⁻¹ · min⁻¹; P = 0.01), but not patients without cerebral tissue hypoxia (PbtO₂ > 20 mmHg; -0.57 [-1.40 - -0.36] % · mL⁻¹ · min⁻¹; P = 0.99) when compared to controls (-0.60 [-0.75 - -0.39] % · mL⁻¹ · min⁻¹). The serum concentration of Neurofilament-light predicted impairments in O₂ diffusion (Z-score > 1.65) in HIBI patients with a sensitivity of 75% and specificity of 100% (receiver operator curve characteristic analysis area under the curve = 0.92; P = 0.001).

Conclusions: Blood-based biomarkers of brain injury hold promise as a tool for the bedside diagnosis of impairments in the diffusion of oxygen from the cerebral vasculature into the brain. This may help inform patient care and help guide the implementation of treatments that aim to avoid cerebral tissue hypoxia.

References

- Canadian Institutes of Health Research (#437644)

Topic: Cardiac arrest

000753

Characteristics and outcomes of patients with Guillain–Barre Syndrome admitted to the ICU: a retrospective observational study

S. AlQahtani¹, H. Arishi¹, A. Peeran², H.M. Al-Dorzi¹, F. Alenezi¹, J. Jose³, M. Sadat¹, F. Bin Humaid¹, Y. Arabi¹

¹Intensive Care Department, King Saud bin Abdulaziz University for Health Sciences (KSAU-HS), Riyadh, Saudi Arabia; ²Neurology Department, King Saud bin Abdulaziz University for Health Sciences (KSAU-HS), Riyadh, Saudi Arabia; ³Department of Bioinformatics and Biostatistics, King Abdullah International Medical Research Center (KAIMRC), Riyadh, Saudi Arabia.

Correspondence: S. AlQahtani

Intensive Care Medicine Experimental 2023, **11(Suppl 1)**:000753

Introduction: It is estimated that 30% of patients with Guillain–Barre Syndrome (GBS) require intensive care unit (ICU) admission and mechanical ventilation (MV) secondary to acute respiratory failure. The higher tendency toward more complication and longer hospital stay have been reported with fair functional recovery.

Objectives: To evaluate the clinical characteristics and outcomes of patients with GBS admitted to ICU.

Methods: A retrospective observational study of all adult patients with GBS who required ICU admission in a tertiary care hospital in Riyadh, Saudi Arabia from Jan 1999 to Dec 2020. Patients were divided into two groups according to MV requirements. We reported the functional status at maximum follow-up using GBS disability score (Hughes' scale).

Results: During the study period, 43 patients with GBS were admitted to the ICU. Their median age was 44 years (Q1, Q3: 37, 63), 23 patients (53.5%) were males and 26 (60%) had a history of chronic diseases. Seasonal variations were observed with 24 (55.8%) admission during the colder season (Oct–Feb) with no significant difference in outcomes. The most common cause for ICU admission was acute respiratory failure (bulbar dysfunction in 12 patients [27.9%], respiratory distress with hypoxia in 12 [27.9%], and inability to clear airways in 6 [14%]). Most patients (n = 27, 62.8%) received MV for a median duration of 13 days (Q1, Q3: 11, 17). These patients had a significantly lower baseline muscle strength (median medical research council sum score of 18 [Q1, Q3: 2, 36] vs. 36 [Q1, Q3: 28.5, 42] in the non-MV group; P = 0.0043). The MV group had longer median stay in ICU (26 days [Q1, Q3: 22, 42] vs. 6 days [Q1, Q3: 3, 6], P = 0.0001) and hospital (120 days [Q1, Q3: 70, 174] vs. 39 days [Q1, Q3: 11, 91.5], P = 0.0007). MV patients had more complications during ICU and hospital stay (deep vein thrombosis in 2 [4.7%] patients, pulmonary embolism in 2 [4.7%], gastrointestinal bleeding in 2 [4.7%], bacteremia in 5 [11.6%], bed sore in 1 [2.3%], and side effects related to intravenous immunoglobulin in 4 [9.4%] vs. none in the non-MV group for all these complications. Most patients (n = 22, 81.5%) in the MV group had tracheostomy. For all patients, the best Hughes' scale score was zero with full recovery in 11 patients (25.5%), 1–3 in 18 (41.8%), 4–5 in 12 (27.9%), and 6 in 2 (4.6%) who died in the hospital. The median Hughes' scale score was higher in the MV group (3 [Q1, Q3: 3, 5] vs. 0.5 [Q1, Q3: 0, 3], P = 0.0005).

Conclusions: In patients with GBS who were admitted to ICU, higher rates of complications, longer stay, and worse functional recovery were observed among those who received MV. Further research is needed to address this population.

References

1. Yuki, N. and H.P. Hartung, Guillain-Barré syndrome. *N Engl J Med*, 2012. 366(24): p. 2294–304.
2. Sejvar, J.J., et al., Population incidence of Guillain-Barré syndrome: a systematic review and meta-analysis. *Neuroepidemiology*, 2011. 36(2): p. 123–33.
3. Orlikowski, D., et al., Prognosis and risk factors of early onset pneumonia in ventilated patients with Guillain-Barré syndrome. *Intensive Care Med*, 2006. 32(12): p. 1962–9.
4. Sharshar et al.—2003—Early predictors of mechanical ventilation in Guillain-Barré syndrome.pdf > . 5. Lawn et al.—2001—Anticipating mechanical ventilation in Guillain-Barré syndrome.pdf > . 6. Ropper, A.H. and S.M. Kehne, Guillain-Barré syndrome: management of respiratory failure. *Neurology*, 1985. 35(11): p. 1662–5.
7. Sharshar, T., et al., Early predictors of mechanical ventilation in Guillain-Barré syndrome. *Crit Care Med*, 2003. 31(1): p. 278–83.
8. Shrivastava, M., S. Nehal, and N. Seema, Guillain-Barré syndrome: Demographics, clinical profile & seasonal variation in a tertiary care centre of central India. *The Indian journal of medical research*, 2017. 145(2): p. 203–208.
9. Asiri, S., et al., Prevalence and outcomes of Guillain-Barré syndrome among pediatrics in Saudi Arabia: a 10-year retrospective study. *Neuropsychiatr Dis Treat*, 2019. 15: p. 627–635.
10. Zaheer, M., Naeem, Muhammad; and Nasrullah, Muhammad < Seasonal Variation and Sex Distribution Inpatients with Guillain-.pdf > . *Pakistan Journal of Neurological Sciences (PJNS)*, 2008. 3(1). 11. Sriganesh, K., et al., Seasonal variation in the clinical recovery of patients with Guillain Barré syndrome requiring mechanical ventilation. *Neuro India*, 2013. 61(4): p. 349–54.
12. González, P., et al., Experience with Guillain-Barré syndrome in a neurological Intensive Care Unit. *Neurología (English Edition)*, 2016. 31(6): p. 389–394.
13. Foster, R., et al., Use of intravenous immune globulin in the ICU: a retrospective review of prescribing practices and patient outcomes. *Transfus Med*, 2010. 20(6): p. 403–8.
14. Azim, A., et al., Outcome of mechanical ventilation in patients of Guillain-Barré syndrome: An audit from a tertiary care centre. *Sahel Medical Journal*, 2013. 16(2): p. 48–51.
15. de Boisanger, L., Outcomes for patients with Guillain-Barré syndrome requiring mechanical ventilation: a literature review. *Irish Journal of Medical Science (1971 -)*, 2016. 185(1): p. 11–15.
16. Benamer, H.T. and A. Bredan, Guillain-Barré syndrome in Arab countries: a systematic review. *J Neurol Sci*, 2014. 343(1–2): p. 221–3.
17. Yuki, N. and H.-P. Hartung, Guillain-Barré Syndrome. *New England Journal of Medicine*, 2012. 366(24): p. 2294–2304.

Topic: Neurointensive care

000754

Too much of a good thing: magnesium intoxication in patient with HELLP syndrome complicated by acute kidney injury

A. Oliveira¹, R. Curto¹, A. Silva², V. Silveira¹, M. Vera-Cruz¹, J. Gonçalves-Pereira¹¹Intensive Care Unit, Hospital de Vila Franca de Xira, Estrada Carlos Lima Costa, Vila Franca de Xira, Portugal, Vila Franca de Xira, Portugal;²Gynecology and Obstetrics, Hospital de Vila Franca de Xira, Estrada Carlos Lima Costa, Vila Franca de Xira, Portugal, Vila Franca de Xira, Portugal

Correspondence: A. Oliveira

Intensive Care Medicine Experimental 2023, **11(Suppl 1)**:000754

Introduction: Magnesium perfusion is recommended in obstetric emergencies, such as eclampsia and HELLP syndrome (hemolysis, elevated liver enzymes, and low platelet count). Although magnesium high doses are generally safe [1], unrecognized accumulation, due to acute kidney injury (AKI), may cause significant morbidity and even death.

Methods: We present a case report of a patient with HELLP syndrome complicated by AKI. Informed consent was obtained.

Results: A 32-year-old pregnant woman was admitted to the hospital in the 32nd gestational week due to a high fetal cardiac rate and uterine growth restriction. In the next few days, she developed severe HELLP syndrome and preeclampsia. AKI was also noted. An urgent cesarean section was performed. She was started on magnesium sulfate (4 g bolus followed by perfusion 2gr/h). Sixteen hours later, she developed progressive weakness, slurred speech, and tongue paresis,

along with visual disturbances and bradycardia. Magnesium toxicity was suspected and perfusion stopped. (Table 1) Complete neurologic recovery was noted. Nifedipine was started for blood pressure control. HELLP syndrome develops in 0.5–0.9% of all pregnancies. It is complicated with AKI in 36–50%. Admission to Intensive Care is strongly recommended due to the maternal and fetal high risk of death (11.5% and 26–48.2%, respectively) [2].

Clinical signs of magnesium toxicity, including loss of deep tendon reflexes and progressive weakness, including the diaphragm and respiratory muscles, along with hypotension and complete heart block should foster immediate discontinuation of magnesium.

Conclusions: AKI is a common complication of HELLP syndrome, and poses a high risk for toxicity when high magnesium doses are administered. Clinical awareness is crucial to ensure patient safety.

Table 1 (abstract 000755) Blood analytical results, along the first days of internship compared to the day of birth (D0) and last previous results (D -22)

	D (-22)	D0 (Birth)	D 1	D 6
Urea (<50 mg/dl)	30	51 ->44	47	39
Creatinine (0.55-1.02 mg/dl)	1.06	1.84 ->1.56	1.85	0.91
Magnesium (1.8-2.3 mg/dl)	---	1.5 -> ---	8.7	1.1
Potassium (3.5-5.1 mmol/L)	4.18	4.46 -> 4.47	4.64	4.22
Platelets (150-400 10 ⁹ /µL)	146	154 -> 76	202	174
Haemoglobin (12-15 g/dl)	14.3	14.9 ->14.9	16.5	13.3
Aspartate transaminase (15-37 U/L)	---	527 -> ---	324	44
Alanine transaminase (14-59 U/L)	---	983 -> 870	811	159

References

1. Szczepanski J, et al.; *Front Med*. (7):7–22; 2020
2. Poimenidi E, et al.; *J Intensive Care Soc*; 23(3):372–378; 2022

A letter of consent has been received for identifiable patient(s) in this abstract.

Topic: Poisoning/Toxicology/Pharmacology

000756

Diagnostic and prognostic value of neutrophile- lymphocyte ratio in patients with acute cholangitis

J. Fuss¹, A. Voloboyeva², V. Poloviy³¹Department of Surgery, Regional Hospital of Pustomyty, Lviv, Ukraine;²Icu, Communal Municipal Clinical Hospital 8, Lviv, Ukraine; ³General surgery, Bukovinian State Medical University, Chernivtsi, Ukraine

Correspondence: J. Fuss

Intensive Care Medicine Experimental 2023, **11(Suppl 1)**:000756

Introduction: Acute cholangitis is an acute inflammatory disease of the bile duct that occurs when biliary obstruction results in cholestasis and biliary infection. Several studies have investigated predictors of acute cholangitis severity, suggesting procalcitonin, presepsin, and the delta neutrophil index (DNI) as prognostic markers. However, their high cost or dependence on specific analyzers prevents their wide availability. The neutrophil-lymphocyte ratio (NLR) is reportedly predictive of adverse outcomes in acute pancreatobiliary diseases. The NLR is predictive of disease severity, septic shock, organ failure, or ICU admission in acute pancreatitis and cholecystitis. We evaluated the utility of the NLR for predicting the severity of acute cholangitis.

Objectives: We investigated the predictive value of the neutrophil-lymphocyte ratio (NLR) in acute cholangitis.

Methods: We retrospectively evaluated 178 patients with acute cholangitis who underwent biliary drainage. The severity of acute cholangitis was graded according to the Tokyo 2018 guideline. Patients were dichotomized according to the acute cholangitis severity in two groups, and blood culture positivity. The baseline NLR and white blood cell (WBC) count were compared between groups.

Results: The severity of acute cholangitis was graded as mild, moderate, or severe in 59 (33.1%), 89 (50%), and 30 (16.9%) patients, respectively. Positive blood culture (n = 62) was observed more frequently in severe acute cholangitis. The NLR was significantly higher in patients with severe cholangitis and positive blood culture. The area under the curve (AUC) for the NLR and WBC, for severe acute cholangitis was 0.85 and 0.69 respectively. The AUC for the NLR and WBC for positive blood culture was 0.74 and 0.62, respectively; the NLR had greater power to predict disease severity and positive blood culture. The sequential NLR values from admission to 3 days after admission were significantly higher in patients with severe cholangitis.

Table (abstract 000756) Demographic and clinical characteristics of 178 patients diagnosed with acute cholangitis

	Mild-to-Moderate Acute Cholangitis (n = 150)	Severe Acute Cholangitis (n = 28)	p-Value
Age, mean ± SD, years	74.8 ± 12.7	79.5 ± 10.95	0.038
Etiology of acute cholangitis			
Cholelithiasis	132 (74.1%)	18 (10.1%)	0.789
Benign biliary stricture	8 (4.5%)	1 (0.6%)	0.401
Malignant biliary stricture	17 (9.5%)	2 (1.2%)	0.908
Biliary drainage method			<0.001
ERCP	136 (76.4%)	16 (9%)	
PTBD	14 (7.9%)	12 (6.7%)	
Laboratory data			<0.001
WBC count (/μL)	9.5	16.2	
NLR	8.15	24.84	

Conclusions: The ratio of neutrophils and lymphocytes is a reliable predictor in predicting adverse outcomes in patients with acute cholangitis. The high predictive value of PCT, as well as the high availability and low cost of clinical blood testing, make NLR a more promising test in clinical practice.

References

1. Li YX, Chang JY, He MY, et al. Neutrophil-to-lymphocyte ratio (NLR) and monocyte-to-lymphocyte ratio (MLR) predict clinical outcome in patients with stage IIb cervical cancer. *J Oncol.* 2021;2021:2939162. [CrossRef]
2. Meng J, Xu H, Liu X, Wu R, Niu J. Increased red cell width distribution to lymphocyte ratio is a predictor of histologic severity in primary biliary cholangitis. *Med (Baltim).* 2018;97(48):e13431. [CrossRef]
3. Mack CL, Adams D, Assis DN, et al. Diagnosis and management of autoimmune hepatitis in adults and children: 2019 practice guidance and guidelines from the American Association for the study of Liver Diseases. *Hepatology.* 2020;72(2):671–722. [CrossRef]
4. Goet JC, Murillo Perez CF, Harms MH, et al. A comparison of prognostic scores (Mayo, UK-PBC, and GLOBE) in primary biliary cholangitis. *Am J Gastroenterol.* 2021;116(7):1514–1522. [CrossRef]
5. Yamana H, Imai S, Yamasaki K, et al. Prognosis of patients with liver cirrhosis: a multi-center retrospective observational study. *Hepatol Res.* 2021;51(12):1196–1206. [CrossRef]
6. Elaghorri A, Salem PES, Azzam E, Abu Elfotouh N. Ghrelin level in patients WITH liver cirrhosis. *Acta Endocrinol (Buchar).* 2019;5(1):62–68. [CrossRef]
7. Carey EJ, Ali AH, Lindor KD. Primary biliary cirrhosis. *Lancet.* 2015;386(10003):1565–1575. [CrossRef]
2. No acknowledgment

Topic: Infections and prevention

000758

Can surgical prophylaxis influence the outcome of bilateral lung transplant recipients?

S. Congedi¹, M. Nardelli¹, C. Legnaro¹, B. Martina¹, G. Bertoldo¹, I. Paiusco¹, I. Fior¹, G. Gianino¹, N. Cacco¹, E. Pistollato¹, C. Simoni¹, C. Schiavolin¹, P. Navalesi¹, A. Boscolo Bozza¹

¹DIMED, University of Padua, Padova, Italy

Correspondence: S. Congedi

Intensive Care Medicine Experimental 2023, **11(Suppl 1)**:000758

Introduction: Postoperative infections (PI) are one of the most common causes of death after bilateral lung transplant (LT). Overall prevalence of Gram-negative (GN) pathogens is increasing annually (4.33/1000 recipient-days); the prevalence of multidrug-resistant (MDR) GN is around 30% after LT. PI in LT recipients due to GN MDR, are associated with an in-hospital mortality six times greater than recipients experiencing GN bacterial infections with no antimicrobial resistances. Long-term exposure to immunosuppression to prevent graft rejection has been recognized as the most relevant risk factor for increasing vulnerability to infections. However, the benefit of 'personalized' surgical prophylaxis in LT recipients pre-colonized by Gram-negative (GN) bacteria is still unclear.

Objectives: With this retrospective observational study, enrolling LT recipients pre-colonized by GN bacteria, we aimed to assess: *i)* the overall prevalence of MDR GN bacteria, over the whole bacterial isolates, within the first 30 days following bilateral LT; *ii)* the prevalence of infections and colonizations due to MDR GN bacteria; and *iii)* the impact on short- and mid-term outcomes of the exposure to 'standard' or 'targeted' surgical prophylaxis (according to in vitro susceptibility).

Methods: All consecutive bilateral LT recipients admitted to the Intensive Care Unit of the University Hospital of Padua (February 2016–2023) were retrospectively screened. Only patients with pre-existing GN bacterial isolations were enrolled and analyzed according to the antimicrobial surgical prophylaxis ('standard' vs. 'targeted' to preoperative colonizations).

Results: One hundred eighty-one LT recipients were screened, 46 were enrolled. Twenty-two (48%) participants received 'targeted' prophylaxis, while 24 (52%) were exposed to 'standard' prophylaxis. The overall prevalence of postoperative MDR GN bacteria isolation was 65% (30 patients), without differences between surgical prophylaxis (p-value 0.364). The most frequent MDR GN bacteria isolates were *Pseudomonas aeruginosa* and *Klebsiella pneumoniae* from respiratory samples. The prevalence of 30-day infection due to MDR GN bacteria was 50%. Of these recipients, 4 belonged to the 'standard' and 11 to the 'targeted' prophylaxis (p-value 0.027).

Conclusions: The administration of a 'targeted' prophylaxis in LT pre-colonized recipients does not prevent the occurrence of postoperative MDR GN bacteria and infections.

References

1. Ivulich S, Westall G, Dooley M, Snell G. The Evolution of Lung Transplant Immunosuppression. *Drugs.* 2018;78(10):965–82.
2. Chung PA, Dilling DF. Immunosuppressive strategies in lung transplantation. *Ann Transl Med.* 2020;8(6):409.
3. Boscolo A, Dell'Amore A, Pettenuzzo T, Sella N, De Cassai A, Pistollato E, et al. The Impact of New Treatments on Short- and MID-Term Outcomes in Bilateral Lung Transplant: A Propensity Score Study. *J Clin Med.* 2022;11(19):5859.
4. Paglicci L, Borgo V, Lanzarone N, Fabbiani M, Cassol C, Cusi MG, et al. Incidence and risk factors for respiratory tract bacterial colonization and infection in lung transplant recipients. *Eur J Clin Microbiol Infect Dis Off Publ Eur Soc Clin Microbiol.* 2021;40(6):1271–82.
5. Boscolo A, Sella N, Pettenuzzo T, De Cassai A, Crociani S, Schiavolin C, et al. Multidrug-Resistant and Extended-Spectrum β-Lactamase Gram-Negative Bacteria in Bilateral Lung Transplant Recipients: Incidence, Risk Factors, and In-Hospital Mortality. *Chest.* 2022;162(6):1255–64.

- Tebano G, Geneve C, Tanaka S, Grall N, Atchade E, Augustin P, et al. Epidemiology and risk factors of multidrug-resistant bacteria in respiratory samples after lung transplantation. *Transpl Infect Dis Off J Transplant Soc.* 2016;18(1):22–30.
- Lanini S, Costa AN, Puro V, Procaccio F, Grossi PA, Vespasiano F, et al. Incidence of carbapenem-resistant gram negatives in Italian transplant recipients: a nationwide surveillance study. *PloS One.* 2015;10(4):e0123706.
- Congedi S, Navalesi P, Boscolo A. Multidrug-resistant organisms in lung transplant: a narrative review. *Curr Opin Organ Transplant.* 2023.

Topic: Infections and prevention

000759

Procalcitonin to predict severity of acute cholangitis

J. Fuss¹, A. Voloboyeva², V. Polovyj³

¹Department of surgery, Regional hospital of Pustomyty, Lviv, Ukraine,

²Icu, Communal Municipal Clinical Hospital 8, Lviv, Ukraine, ³General surgery, Bukovinian State Medical University, Chernivtsi, Ukraine

Correspondence: J. Fuss

Intensive Care Medicine Experimental 2023, **11(Suppl 1)**:000759

Introduction: Acute cholangitis (AC) is a medical emergency and systemic condition due to biliary infection and obstruction with an associated high mortality rate [1,2].

Previously, the levels of leukocytosis and C-reactive protein (CRP) were assessed for predicting the severity of AC, but neither was found to be useful [1–5]. On the other hand, procalcitonin (PCT) was shown to increase in the first hours after systemic inflammation and peaked earlier than CRP did in the plasma [6].

Objectives: The aim of this study is to evaluate the potential use of PCT level in defining the severity of AC apart from the standard acute-phase reactants.

Methods: A total of 134 patients who were diagnosed with AC between June 2019 and March 2022 were included in the study. We examined the relationship between WBC count, erythrocyte sedimentation rates (ESR), PCT level, CRP level, USI findings, and the disease stage.

Results: 134 patients diagnosed with acute cholangitis were included in the study. 57 of them (42.5%) were male. The mean age of the patients was 58.93 ± 1.96 (min: 19; max: 94). When we classified the patients for the severity grades of acute cholangitis, 52 (38.8%) were allotted to grade 1, 37 (27.6%) to grade 2, and 45 (33.6%) to grade 3.

The laboratory values for PCT, white blood cell (WBC), C-reactive protein (CRP), the international normalised ratio (INR), and platelet, which were measured to determine the severity grade of acute cholangitis, are listed in Table 1.

Univariate analysis of demographical, physiological, and process parameters revealed values of age ($p < 0.001$), PCT ($p < 0.001$), CRP ($p < 0.001$), INR ($p = 0.001$), and platelet ($p = 0.012$) as the factors which affected clinical severity (Table 2).

Table 1 (abstract 000759) Laboratory median values of patients

Laboratory value	Median	Q1–Q3
PCT (ng/ml)	0.333	0.078–1.67
WBC (× 10 ⁹ /L)	11.0	7.7–14.3
CRP (mg/L)	2.39	0.84–8.91
INR	1.07	1.02–1.14
Platelets (× 10 ⁹ /L)	223	169–272

Table 2 (abstract 000759) Univariate analysis of factors affecting the severity of acute cholangitis and relationship between procalcitonin values and acute cholangitis severity levels

	Grade 1 median (Q1– Q3)	Grade 2 median (Q1– Q3)	Grade 3 median (Q1– Q3)	p
Gender				0.436
Male	16	12	29	
Female	36	25	16	
Age	49.50 (36–61.75)	72.00 (48–79)	72.50 (62.75–81)	< 0.001
PCT	0.104 (0.03–0.65)	0.353 (0.09–1.61)	1.466 (0.17–9.00)	< 0.001
WBC	10,550 (8342– 13,100)	12,900 (8010– 18720)	11,280 (6777– 18,225)	0.338
CRP	1.06 (0.31– 2.43)	1.87 (0.97– 4.29)	9.07 (2.90–17.82)	< 0.001
INR	1.04 (1.00– 1.09)	1.09 (1.04– 1.16)	1.11 (1.05– 1.21)	0.001

Conclusions: The higher the severity level of the patients, the higher the PCT levels in patients. We found a difference between the patients' PCT values and their severity grades of acute cholangitis. PCT can be used as an effective laboratory method in the severity assessment of acute cholangitis, yet we need additional studies, which would include a higher number of the patient population.

References

1. Sulzer, J.K.; Ocuin, L.M. Cholangitis: Causes, Diagnosis, and Management. *Surg. Clin. N. Am.* 2019, 99, 175–184. [CrossRef] [PubMed]
2. Kimura, Y.; Takada, T.; Kawarada, Y.; Nimura, Y.; Hirata, K.; Sekimoto, M.; Yoshida, M.; Mayumi, T.; Wada, K.; Miura, F.; et al. Definitions, pathophysiology, and epidemiology of acute cholangitis and cholecystitis: Tokyo Guidelines. *J. Hepatobil. Pancreat. Surg.* 2007, 14, 15–26. [CrossRef] [PubMed]
3. Hamada, B.; Huang, D.T. Procalcitonin: Where Are We Now? *Crit. Care Clin.* 2020, 36, 23–40. [CrossRef]
4. Aloisio, E.; Dolci, A.; Panteghini, M. Procalcitonin: Between evidence and critical issues. *Clin. Chim. Acta* 2019, 496, 7–12. [CrossRef]
5. Yunus, I.; Fasih, A.; Wang, Y. The use of procalcitonin in the determination of severity of sepsis, patient outcomes and infection characteristics. *PLoS ONE* 2018, 13, e0206527. [CrossRef]
6. Wacker, C.; Prkno, A.; Brunkhorst, F.M.; Schlattmann, P. Procalcitonin as a diagnostic marker for sepsis: A systematic review and meta-analysis. *Lancet Infect. Dis.* 2013, 13, 426–435. [CrossRef]
2. No acknowledgment

Topic: Infections and prevention

000760

Evaluation of clinical management in suspected meningitis cases: a dual-center audit

A. J. Rezaee¹, B. Hardy¹, R. Desvignes¹, L. Hodgson¹

¹Department of Intensive Care Medicine, University Hospitals Sussex, Worthing, United Kingdom

Correspondence: A.J. Rezaee

Intensive Care Medicine Experimental 2023, **11(Suppl 1)**:000760

Introduction: Meningitis is an infectious disease affecting the central nervous system, with potentially life-threatening consequences (1). Current evidence suggests that early diagnosis and initiation of appropriate antibiotics are crucial to improve patient outcomes (2). Dexamethasone has also demonstrated a benefit for patients infected with *Streptococcus pneumoniae* in particular (3). This study aims to assess the quality of clinical management in suspected meningitis cases across various intensive care units (ICUs) by evaluating the documentation of symptoms and signs, diagnostic workup, treatment, and patient outcomes.

Methods: We conducted a dual-center, retrospective audit of patients with suspected meningitis admitted to ICUs over a 5-year period (2017–2022) of patients with a diagnosis code including “meningitis” or “meningococcal sepsis”. Important data points were collected: documented symptoms (headache, altered mental status, neck stiffness), signs (fever, rash, abnormal neurology), presence or absence of seizures, signs of shock (HR > 90, SBP < 100, Lac > 2.0), blood cultures sent and results, lumbar puncture (LP) sent and results, referral for intensive care review, administration and timing of antibiotics (Ceftriaxone), antivirals, steroids, survival, and length of stay (LOS).

Results: A total of 16 suspected meningitis cases (9 males: 7 females and an average age of 55.6 years) were identified across participating ICUs. Symptoms of meningitis including headache, altered mental status, and neck stiffness were documented in 15 (94%) of the cases. Signs including fever, rash, and abnormal neurology were documented in all (100%) of the cases. Intensive care review was conducted in 15 (94%) cases within 24 h of presentation. 14 (88%) patients were intubated either in the emergency department or on admission to ICU. Seizures were recorded in 8 (50%) of patients, and signs of shock were present in 9 (56%) patients. Lumbar punctures were performed in 14 (88%) patients, yielding positive results in 9 (56%) cases, of which 7 (44%) isolated *Streptococcus pneumoniae* and 2 (13%) isolated *Neisseria meningitidis*. Blood cultures were sent in all patients (100%), with 12 (75%) returning positive results. 11 (69%) of blood cultures grew *Streptococcus pneumoniae* and 1 (6%) grew *Neisseria meningitidis*. Ceftriaxone was administered in 15 (94%) patients. Additionally, 10 (63%) patients received antivirals and 11 (69%) patients received steroids. The survival rate was 75%, and the median LOS was 14.4 days.

Conclusions: The study revealed variability in the documentation of symptoms and signs, as well as the administration of specific treatments in suspected meningitis cases. Although most cases were managed according to established guidelines, there is room for improvement in some areas, such as the timely administration of antibiotics, antivirals, and steroids. These findings highlight the need for continued education and reinforcement of best practices in meningitis management.

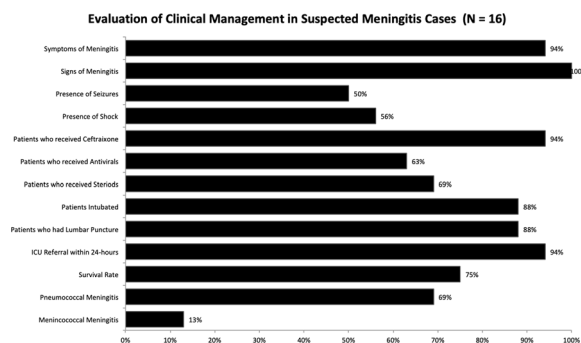

Figure 1

References

1. Fitch, Michael T, and Diederik Van Der Beek. “Emergency Diagnosis and Treatment of Adult Meningitis.” *The Lancet Infectious Diseases* 7, no. 3 (2007): 191–200. doi: [https://doi.org/10.1016/S1473-3099\(07\)70050-6](https://doi.org/10.1016/S1473-3099(07)70050-6).

2. McGill, F, R.S. Heyderman, B.D. Michael, S. Defres, N.J. Beeching, R. Borrow, L. Glennie, et al. “The UK Joint Specialist Societies Guideline on the Diagnosis and Management of Acute Meningitis and Meningococcal Sepsis in Immunocompetent Adults.” *Journal of Infection* 72, no. 4 (April 2016): 405–38. doi: <https://doi.org/10.1016/j.jinf.2016.01.007>.
3. Rayanakorn, Ajaree, Hooi-Leng Ser, Priyia Pusparajah, Kok-Gan Chan, Bey Hing Goh, Tahir Mehmood Khan, Surasak Saokaew, Shaun Wen Huey Lee, and Learn-Han Lee. “Comparative Efficacy of Antibiotic(s) Alone or in Combination of Corticosteroids in Adults with Acute Bacterial Meningitis: A Systematic Review and Network Meta-Analysis.” *PLOS ONE* 15, no. 5 (May 29, 2020): e0232947. doi: <https://doi.org/10.1371/journal.pone.0232947>.

Topic: Infections and prevention

000762

Distribution throughout the years of multidrug-resistant bacteria isolates in our ICU

V. Losada Martínez¹, N. Cruza Leganés¹, F. Arbol Linde¹, D. Fuentes Scott¹, L. Díez Izquierdo², A. M. Biurrun Larralde², M. A. Taberna Izquierdo¹

¹Intensive Care Unit, University General Hospital Nuestra Señora del Prado, Talavera de la Reina, Spain; ²Preventive Medicine, University General Hospital Nuestra Señora del Prado, Talavera de la Reina, Spain

Correspondence: V. Losada Martínez

Intensive Care Medicine Experimental 2023, **11(Suppl 1)**:000762

Introduction: Multidrug-resistant bacteria (MDR) are a major public health problem. Surveillance of microbiological isolates, both colonizations and infections, in Services such as Inte40635_2023_546nsive Care Units (ICU) are crucial for controlling the spread of these bacteria, as well as for choosing empirical antibiotic treatment.

Objectives: To analyze the microbiological isolates of MDR taken in our ICU during the years 2021–2022 and their temporal distribution.

Methods: A retrospective descriptive observational study of MDR isolates from January 1, 2021 to January 29, 2022 from patients admitted to our ICU. It is a multipurpose 12-bed ICU expanded to 24 beds during the pandemic period. Oropharyngeal and rectal exudate samples are collected and the isolates are therefore due to infection as well as MDR colonization.

Results: During the study period we had a total of 892 MDR isolates, 648 (72.64%) in 2021 and 244 (27.35%) in 2022.

Regarding the annual isolates ordered by frequency: in 2021: an outbreak of *Acinetobacter baumannii* (AB) only sensitive to tigecycline appears at the beginning of the year with a total of 374 positive samples (41.92%), between the months of January to May, after which we did not obtain any positive isolates for this MDR again. The second bacterium was multiresistant *Pseudomonas* (MR-P) with 134 isolates (20.67%) followed by *Klebsiella pneumoniae* ESBL (KP-ESBL) with 67 isolates (10.33%). *Enterobacteriaceae* with carbapenemase (EBC) we obtained 41 (6.32%), methicillin-resistant *Staphylococcus aureus* (MRSA) 31 (4.78%), and vancomycin-resistant *Enterococcus* (VRE) 1 (0.15%). In 2022 we obtained by frequency: MRSA with 113 isolates (46.31%) followed by MR-P with 57 (23.36%), KP-ESBL 49 (20.08%), EBC 25 (8.19%) and VRE 0. Regarding the temporal distribution of the isolates: a very clear AB outbreak appears at the beginning of 2021. MR-P has a more constant distribution during 2021 and more intermittent in 2022. KP-ESBL has grouped its isolates into two–three months in both years. MRSA in 2021 presents almost all its cases at the beginning of the year while in 2022 it is more constant throughout the year. EBC has a clear peak in the months of July–August in both years.

Conclusions: The most frequent MDR in our ICU were: AB (41.92%), MR-P (21.41%), MRSA (16.14%) and KP-B (13%). Despite the fact that AB isolates account for 41.92% of the total, after the eradication of the outbreak this MDR was not isolated again.

BMR isolates (except AB, which was an outbreak) change over the years. Bacteria such as MR-P and MRSA have a more continuous distribution while others such as KP-ESBL and EBC have grouped most of their isolates for 2–3 months of the year.

VRE are the least isolated MDR in our ICU, accounting for 0.11% of the total.

Topic: Infections and prevention

000763

Levosimendan in the treatment of cardiogenic shock in septic patients

G. Zakynthinos¹, V. Tsolaki², V. Vazgiourakis², N. Karavidas², D. Makris³
¹3rd Cardiology Clinic, Sotiria Thoracic Diseases Hospital of Athens, Athina, Greece; ²Intensive Care Unit, Larissa General University Hospital, Larissa, Greece; ³Intensive Care Unit, Faculty of Medicine, University of Thessaly, Larissa, Greece

Correspondence: V. Tsolaki

Intensive Care Medicine Experimental 2023, **11(Suppl 1)**:000763

Introduction: Septic cardiomyopathy (SCM) is a frequently encountered entity in the course of a septic shock episode. Current guidelines recommend against the use of levosimendan for the management of septic patients with SCM. Moreover, there are no evidenced based recommendations for the management of cardiogenic shock due to SCM.

Objectives: To evaluate the efficacy of levosimendan administration in the management of septic patients with SCM and cardiogenic shock.

Methods: Observational study of patients admitted in the Intensive Care Unit (ICU) of the University Hospital of Larissa, presenting cardiogenic shock due to severe SCM. Patients were included if they presented severely reduced left ventricular ejection fraction (LVEF < 30%) and signs of circulatory failure (lactate > 2 mmol/Lt, ScvO₂ < 70%).

Results: Twenty three patients were included in the study. The median age was 61 (30, 84) years and 14 (61%) were male. The median time for SCM establishment (from the last known cardiac function level) was 7.5 (2, 56). All patients presented sepsis induced cardiogenic shock as depicted by a depressed EF [median EF 15% (5, 30)], ScvO₂ [median 62% (38, 74)], and increased Pa-vO₂ [median 10.8 (1, 15) mmHg] and lactate [median 4.4 (2, 18) mmol/Lt]. The median troponin levels were 0.38 (0.01, 10) ng/ml. All the patients received noradrenaline and vasopressin.

Fourteen patients (61%) were treated with levosimendan, and the rest received dobutamine (n=2) or only noradrenaline. Patients in the levosimendan group were more severely ill compared to the other treatment group [APACHE II: 27 (14, 37) vs 14 (13, 28), respectively, p=0.012] and there was a trend for more decompensated LV function depicted by the LVEF [15 (10, 20) vs 20 (15, 25), respectively, p=0.061] and the Pa-vCO₂ [12 (10, 15) vs 9 (5, 14), p=0.069], one of the indices indicating more severe circulatory failure. Concerning the response to the treatment administered, patients in the levosimendan group presented significantly higher increase in LVEF after five days [250% (-25, 350) vs 0 (-25, 100), p=0.02], and significant decreases in lactate clearance during the first 12 h [-34.5% (-50, 3) vs 2.2% (-100, 31), p=0.014] and 24 h [-48% (-10, -78) vs 28% (-48, 71), p=0.05] (Table 2). Concerning the ScvO₂ values there was a significant decrease in the levosimendan group across the first 72 h [p=0.002 (ANOVA)], while in the other treatment group the change did not reach statistical significance (p=0.063).

In nine patients in the levosimendan group (64.3%), SCM was resolved vs 2 (22.2%) in the other treatment group (p=0.054). ICU survival was higher in the first group (50% vs 22.2%) although it did not reach statistical significance (p=0.172).

In Cox Regression analysis, the confounders affecting survival were the ejection fraction that the patients presented during the episode of septic cardiomyopathy [HR 0.887 (95% CI 0.790 to 0.996), p=0.042]. On the contrary, the APACHE II score was not identified as a predictor.

Conclusions: Levosimendan can reverse the adverse signs of circulatory failure in patients with circulatory failure due to cardiogenic shock in the course of a septic episode, while it results in higher likelihood of improvement in the left ventricular function.

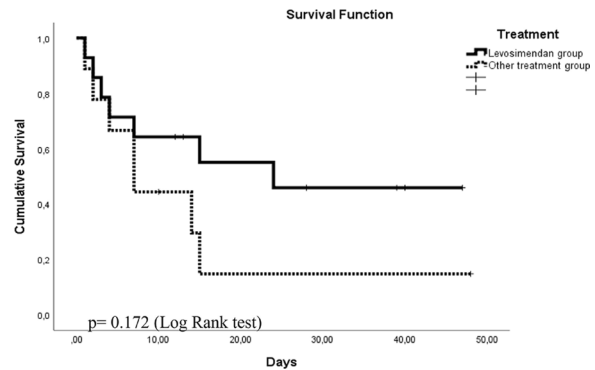

Figure 1 (abstract 000763) Survival function in the two groups

Topic: Cardiovascular issues in ICU

000764

Relationship between hyperoxemia and the incidence of ventilator-associated pneumonia: a prospective single-center study

M. Houard¹, S. Six¹, F. Zerimech², F. Wallet², J. Labreuche³, E. Cailliau³, A. Gaudet⁴, S. Nseir¹

¹Icu, Chu De Lille, Lille, France; ²Centre de Biologie Pathologie, Chu, Lille, France; ³Statistics, Chu De Lille, Lille, France; ⁴Intensive Care, CHU de Lille, Lille, France

Correspondence: M. Houard

Intensive Care Medicine Experimental 2023, **11(Suppl 1)**:000764

Introduction: Enhanced oxidative stress and inflammation are the main pathophysiologic explanations for the relationship between hyperoxemia and ventilator-associated pneumonia (VAP), suggested by a retrospective clinical study [1].

Objectives: The primary objective of this study was to assess the impact of hyperoxemia at ICU admission on VAP occurrence.

Methods: This prospective observational cohort study was conducted in a 50-bed mixed ICU during a four-year period. All adult patients requiring > 48 h of invasive mechanical ventilation were included. Inclusions were discontinued for almost a year due to COVID-19 pandemic. Hyperoxemia at ICU admission was defined as a percentage of time \geq third quartile spent with peripheral capillary oxygen saturation (SpO₂) \geq 98% during the first 24 h. SpO₂ was continuously collected with non-invasive infrared sensor during the whole period of mechanical ventilation. VAP was defined using clinical, radiologic and quantitative microbiological data. The cumulative incidence of VAP according to the presence of hyperoxemia was estimated using the Kaplan-Meier method. The association of hyperoxemia with the probability of VAP event was assessed using Cox's proportional hazard model.

Results: Among the 534 patients included in the analysis, 289 (54,1%) had hyperoxemia at ICU admission. One hundred and twelve (21%) developed at least one VAP episode including 68 (23,5%) in the « hyperoxemia group» versus 44 (18%) in the group without hyperoxemia. Hyperoxemia was significantly associated with VAP occurrence (adjusted HR 1.53 [95%CI 1.03-2,26]) (Figure). VAP episodes were mainly related to Gram-negative bacilli, 27% were polymicrobial and 19.6% related to multidrug resistant bacteria.

Conclusions: Hyperoxemia is significantly associated with increased risk for VAP.

Figure. Cumulative incidence of VAP according to the presence of hyperoxemia at admission.

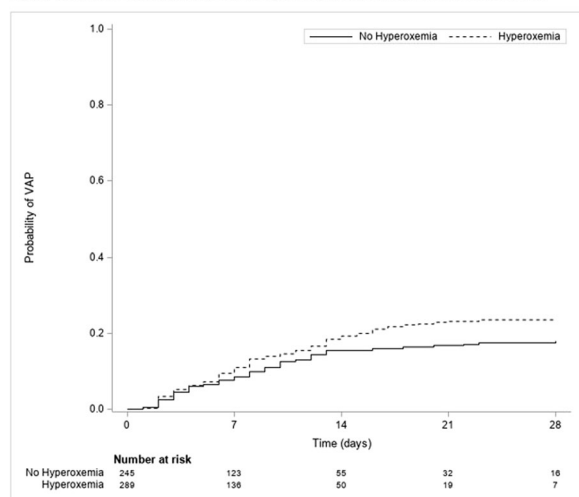

Figure (abstract 000764) Cumulative incidence of VAP according to the presence of hyperoxemia at admission
Abbreviation: VAP = ventilator-associated pneumonia

References

- [1] Six S, Jaffal K, Ledoux G, Jailllette E, Wallet F, Nseir S. Hyperoxemia as a risk factor for ventilator-associated pneumonia. *Crit Care*. 2016 Jun 22;20:195.

Topic: Infections and prevention

000767

Predicting the need for intubation using ROX index in patients with COVID-19 pneumonia requiring long-term High-flow nasal cannula oxygenation

R. Son¹, K. Shigemitsu¹, A. Tsuruoka¹, H. Rinka¹

¹Department of Emergency and Critical Care Medical Center, Osaka City General Hospital, Osaka, Japan

Correspondence: R. Son

Intensive Care Medicine Experimental 2023, **11(Suppl 1)**:000767

Introduction: High-flow nasal cannula oxygenation (HFNC) is a useful non-invasive respiratory support that may reduce the need for invasive mechanical ventilation (IMV) [1]. However, COVID-19 pneumonia may delay intubation because of the long duration of the illness and unawareness of severe hypoxemia [2, 3]. Although some recommend early intubation, the course of hypoxia-induced lung injury in COVID-19 varies [4]. Some patients recover after the inflammatory stage, while others require IMV after acute exacerbation [5]. The need for intubation has been predicted using the ROX index, a fraction of oxygen saturation, FiO_2 , and respiratory rate, during early HFNC in patients with COVID-19 pneumonia [6, 7, 8]. However, there are no reports of ROX index use in patients requiring long-term HFNC.

Objectives: To evaluate the efficacy of ROX index for predicting intubation need in patients with COVID-19 pneumonia-induced respiratory failure requiring long-term HFNC.

Methods: This single-centre retrospective study included patients with COVID-19 pneumonia requiring HFNC, who were admitted to our hospital from September 2020 to April 2022. Patients who received at least 48 h of HFNC were selected. The patients were divided into two groups: those weaned from HFNC (success group) and those that required intubation (failure group). ROX index was evaluated 2, 6, 12, 24, 36, 48, 60, and 72 h after HFNC initiation. The prediction accuracy of the ROX index for intubation was evaluated using the ROC curve and quantified using AUROC.

Results: The study included 120 patients. Among them, 75 patients received HFNC for ≥ 48 h (61 [81%] and 14 [19%] in the success and failure groups, respectively). The median duration of HFNC was 119 and 57 h in the success (time-to-weaning) and failure (time-to-intubation) groups, respectively ($p=0.01$). No significant difference in gender (male: 77 vs 86%, $p=0.72$), BMI (median: 26 vs 25 kg/m², $p=0.74$), smokers (43 vs 64%, $p=0.23$). The respiratory status before HFNC initiation tended to be slightly worse than in the failure group than in the success group: RR (24 vs 26 / min, $p=0.81$), SpO₂ (92 vs 90%, $p=0.02$), and O₂ (8 vs 9 L/min, $p=0.04$). ROX indexes were similar in both groups from 2 to 24 h after HFNC initiation; however, they were significantly lower in the failure group than in the success group from 36 to 72 h. The ROX index since 36 h after HFNC initiation was a useful predictor of HFNC failure (AUROC: 0.82–0.89) (Table 1). ROX index ≤ 7.1 accurately predicted intubation 48 h after HFNC initiation.

Conclusions: Some patients with COVID-19 pneumonia required intubation on deterioration of respiratory condition soon after HFNC initiation. Patients whose condition was stable at first but worsened after 36 h also required intubation. Long-term monitoring of ROX index in patients with COVID-19 pneumonia requiring HFNC could help predict the need for and avoid delays in intubation.

Hours since HFNC (h)	Success (n=61) Median [IQR]	Failure (n=14) Median [IQR]	AUROC [95%CI]	p-value
2	7.7 [6.1, 8.7]	6.9 [6.4, 7.9]	0.57 [0.41 - 0.73]	0.869
6	7.6 [6.6, 9.2]	7.3 [6.7, 8.5]	0.52 [0.37 - 0.68]	0.862
12	7.6 [7.0, 9.6]	7.4 [5.8, 8.4]	0.62 [0.45 - 0.78]	0.131
24	7.8 [6.5, 9.6]	6.6 [5.9, 7.8]	0.66 [0.49 - 0.82]	0.089
36	8.3 [6.8, 10.1]	6.1 [5.8, 7.0]	0.82 [0.70 - 0.93]	<0.001
48	9.6 [7.5, 11.7]	5.8 [5.3, 6.4]	0.89 [0.80 - 0.98]	<0.001
60	9.8 [7.9, 12.3]	6.2 [5.9, 6.7]	0.88 [0.79 - 0.97]	0.003
72	9.4 [7.9, 11.5]	6.3 [6.1, 6.8]	0.88 [0.79 - 0.97]	0.022

Table 1.

References

1. Rello J, et al. High-flow nasal therapy in adults with severe acute respiratory infection: a cohort study in patients with 2009 influenza A/H1N1v. *J Crit Care* 2012;27(5):434–439.
2. Couzin-Frankel J. The mystery of the pandemic's 'happy hypoxia'. *Science*. 2020;368(6490):455–456.
3. de Simone G, et al. COVID-19: timing is important. *Eur J Intern Med* 2020;77:134–135.
4. Gattinoni L, et al. COVID-19 pneumonia: different respiratory treatments for different phenotypes? *Intensive Care Med* 2020; 46(6):1099–1102.
5. Dos Santos, WG, et al.: Natural history of COVID-19 and current knowledge on treatment therapeutic options. *Biomed Pharmacother* 2020;129:110493.
6. Ricard J-D, et al. Use of nasal high flow oxygen during acute respiratory failure. *Intensive Care Med* 2020;46(12):2238–2247.
7. Hu M, et al. Application of high-flow nasal cannula in hypoxemic patients with COVID-19: a retrospective cohort study. *BMC Pulm Med* 2020;20(1):324.
8. Chandel A, et al. High-flow nasal cannula therapy in COVID-19: using the ROX index to predict success. *Respir Care* 2021;66(6):909–919.

Topic: Acute respiratory failure and mechanical ventilation

000768

Efficacy of hemoabsorptive therapy in the management of refractory septic shock in a non-concurrent cohort

R. kemeny¹, A. Giglio¹, A. Ramos¹, A. Arroyo¹, C. Pedreros¹, C. Mondaca², V. Fuentes², A. Ferre¹, J. Dreyse³

¹Programa de Medicina Intensiva, Universidad Finis Terrae - Postgrado, Providencia, Chile; ²Unidad de Nefrología y Diálisis, Clínica Las Condes, Las Condes, Chile; ³Centro de Paciente Crítico, Clínica Las Condes, Las Condes, Chile

Correspondence: R. kemeny

Intensive Care Medicine Experimental 2023, **11(Suppl 1)**:000768

Introduction: Septic shock remains a leading cause of mortality in intensive care units (ICU), with mortality rates ranging between 30–40%.

Despite advances in understanding and management, some patients progress to refractory septic shock with a mortality rate exceeding 90%. Hemoadsorption therapies have emerged as an additional tool to restore immune homeostasis and target cytokine neutralization.

Objectives: To evaluate the effectiveness of hemoadsorptive therapy in treating refractory septic shock in a non-concurrent cohort of patients, building on current knowledge and experience in the clinical setting.

Methods: A non-concurrent review of patients admitted to the ICU with refractory septic shock who received hemoadsorptive therapy over five years was conducted. Clinical variables, including age, gender, APACHE II and SOFA scores, vasopressor requirements, and laboratory parameters, as well as in-hospital mortality and mortality at 30 and 90 days, were analyzed. Descriptive statistics were calculated, and pre- and post-therapy variables were compared using the Mann–Whitney test.

Results: The median age of the cohort was 65.5 years, with a male-to-female ratio of 0.43. Hemoadsorptive therapy was associated with a reduction in vasopressor requirements, with a median initial noradrenaline requirement of 0.7 mcg/kg/min (IQR 0.45–0.8875) decreasing to 0.12 mcg/kg/min (IQR 0–0.225) post-therapy. Median APACHE II scores pre- and post-therapy were 30.5 and 20.5, respectively, while SOFA scores were 13.5 and 11.5, without statistical significance. Median lactate levels decreased by 62%, from 7.86 mmol/l pre-therapy to 2.97 mmol/l post-therapy. Inflammatory parameters, such as C-reactive protein, decreased from 206 mg/dL to 180 mg/dL, and procalcitonin decreased from 58 to 8.91. In-hospital mortality was 0.57, increasing to an index of 0.64 at 90 days of follow-up.

Conclusions: Hemoadsorptive therapy demonstrated encouraging efficacy in the management of refractory septic shock in our non-concurrent cohort of 14 patients. A significant decrease in vasopressor requirements, lactate levels, and inflammatory parameters was observed, although changes in APACHE II and SOFA scores were not statistically significant. These promising results warrant further investigation through larger cohort studies to evaluate the impact of hemoadsorptive therapy on long-term mortality and to explore its potential role as a standard treatment option for refractory septic shock.

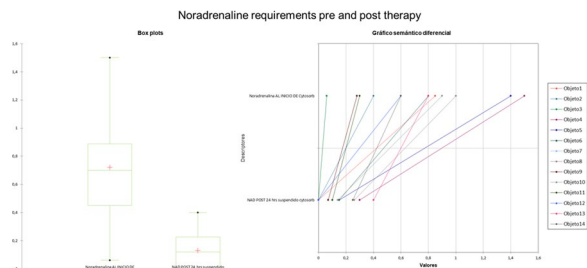

Figure 1 (abstract 000768) Compares median NAD doses using Box plots, prior to and after therapy initiation. On the right-hand side, the trajectory of NAD doses before and after therapy is evaluated using a paired sample graph

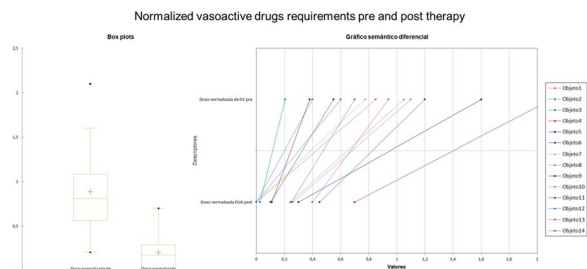

Figure 2 (abstract 000768) Compares median DVA doses using Box plots, prior to and after therapy initiation. On the right-hand side, the trajectory of DVA doses before and after therapy is evaluated using a paired sample graph

References

- Brouwer WP, Duran S, Kuijper M, Ince C, Schaper M, Houdijk AP. Hemoadsorption with CytoSorb® in Critically Ill Patients: Case Series, Review of Literature, and Design of a Prospective Clinical Study. *Blood Purif*. 2017;44(4):346–351. doi: <https://doi.org/10.1159/000478622>
- Cytokine hemoadsorption with CytoSorb® in post-cardiac arrest syndrome, a pilot randomized controlled trial, Céline Monard, Nathan Bianchi, Elettra Poli, Marco Altarelli, Anne Debonneville, Mauro Oddo, Lucas Liaudet & Antoine Schneider, *Critical Care*
- Cytokine removal in human septic shock: Where are we and where are we going?, Patrick M. Honore^{1*}, Eric Hoste², Zsolt Molnár³, Rita Jacobs⁴, Olivier Joannes-Boyau⁵, Manu L. N. G. Malbrain^{4,6} and Lui G. Forni^{7,8}, Honore et al. *Ann. Intensive Care*.

Topic: Sepsis

000769

Relationship between immunosuppression aetiology and incidence, microbiology and outcome of ventilator-associated lower respiratory tract infections: a retrospective multicenter study

C. Bayon¹, L. Kreitmann², A. Rouze³, AS. Moreau³, I. Martin-Loeches⁴, P. Povoas⁵, J. Salluh⁶, J. Labreuche⁷, S. Nseir³

¹Réanimation Médicale, Roger Salengro Hospital, Lille, France; ²Medical Intensive Care Unit, Hospices Civils de Lyon - HCL, Lyon, France; ³Medical Intensive Care Unit, Roger Salengro Hospital, Lille, France; ⁴School of medicine, Trinity College Dublin, Dublin, Ireland; ⁵Polyvalent intensive care unit, São Francisco Xavier Hospital, CHLO, Lisbon, Portugal; ⁶Institute for research and education, D'Or, Rio de Janeiro, Brazil; ⁷Department of Biostatistics, Hospital Center University De Lille, Lille, France

Correspondence: C. Bayon

Intensive Care Medicine Experimental 2023, **11(Suppl 1)**:000769

Introduction: Ventilator associated lower respiratory tract infections (VA-LRTI) are among the most common infectious complications occurring in the intensive care unit (ICU) (1). They include both ventilator-associated tracheobronchitis (VAT) and ventilator-associated pneumonia (VAP). Immunocompromised patients account for a growing proportion of critically ill patients. Using the TAVEM database, we have recently shown that immunocompromised patients had a lower incidence of VA-LRTI when compared to non-immunocompromised patients (2), but the influence of immunosuppression (IS) type on VA-LRTI has not yet been investigated.

Objectives: To determine whether immunosuppression of hematologic cause is a risk factor for developing a VA-LRTI in comparison to other types of immunosuppression.

Methods: We conducted a multicenter, retrospective cohort study to investigate whether the type of IS (hematologic malignancy or other type) had an impact on incidence, microbiology and outcome of VA-LRTI. We merged two multicenter databases, TAVEM (3) and COV-APID (4). Immunocompromised adults requiring mechanical ventilation for more than 48 h were included and classified in two groups: hematologic malignancies and others.

Clinical outcomes and occurrence of a VA-LRTI, VAP and VAT were collected. Patients were followed up until day 28 or ICU discharge if it occurred before. The association of the type of immunosuppression with 28-day cumulative incidence of VA-LRTI, VAP and VAT was assessed by fitting cause-specific Cox models with death and extubation alive as competing risks. Analysis were adjusted for center and pre-specified baseline confounders.

Results: 854 immunocompromised patients were included, among whom 162 had an hematologic malignancy. Mean age was 65 (56 to 74), with 57.6% of male patients. Mean SAPS II at baseline was 53.0 (41.0 to 66.0). Leading causes of ICU admission were pneumonia, respiratory failure, ARDS, sepsis and shock. Hematologic malignancies were associated with a lower 28-day cumulative incidence of VA-LRTI (13.6% versus 20.1% for other patients, cause-specific hazard ratio [cHR] 0.59, 95%CI 0.36 to 0.97, $p = 0.035$) (Figure 1).

VAT incidence did not vary between groups (Figure 2), but VAP tended to be less frequent in hematologic patients (9.3% versus 13.9% for other patients, cause-specific hazard ratio [cHR] 0.55, 95%CI 0.29 to 1.04,

$p=0.064$) (Figure 3). Both extubation alive and ICU discharge alive were less frequent in hematological patients in both adjusted and non-adjusted analysis.

Conclusions: Hematologic patients had a lower 28-day cumulative incidence than other immunocompromised patients of VA-LRTI, mainly due to a lower VAP incidence. Hematologic patients had worse clinical outcomes.

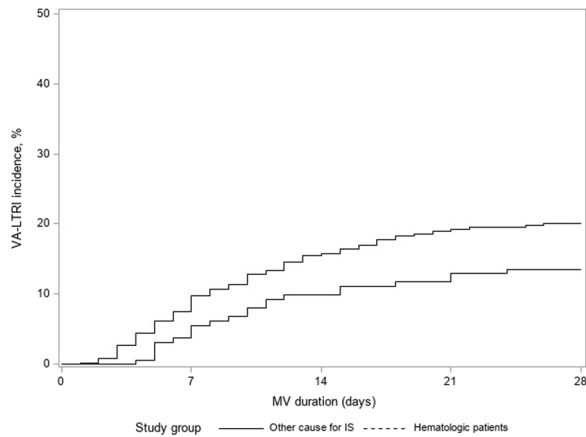

Figure 1 (abstract 000769) 28-day cumulative incidence of VA-LTRI

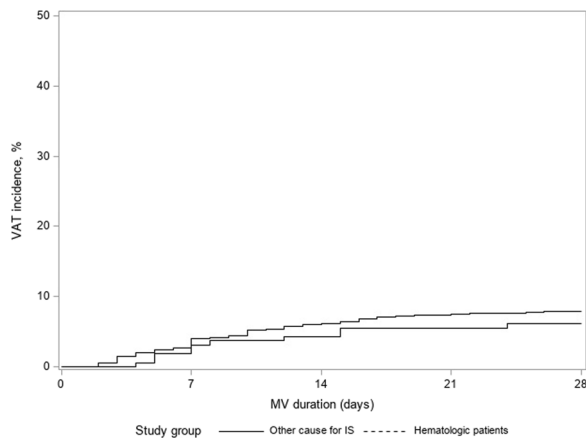

Figure 2 (abstract 000769) 28-day cumulative incidence of VAT

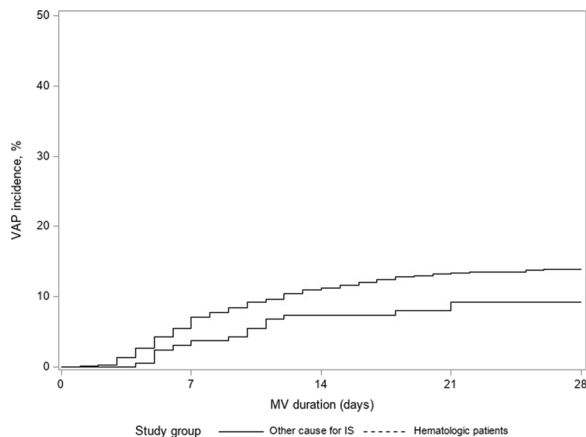

Figure 3 (abstract 000769) 28-day cumulative incidence of VAP

References

1. Magill SS, O’Leary E, Janelle SJ, Thompson DL, Dumyati G, Nadle J, et al. Changes in Prevalence of Health Care–Associated Infections in U.S. Hospitals. *N Engl J Med*. 2018 Nov;379(18):1732–44.
2. Moreau AS, Martin-Loeches I, Povoia P, Salluh J, Rodriguez A, Thille AW, et al. Impact of immunosuppression on incidence, aetiology and outcome of ventilator-associated lower respiratory tract infections. *Eur Respir J*. 2018;51(3).
3. Martin-Loeches I, Povoia P, Rodríguez A, Curcio D, Suarez D, Mira JP, et al. Incidence and prognosis of ventilator-associated tracheobronchitis (TAVeM): a multicentre, prospective, observational study. *The Lancet Respiratory Medicine*. 2015 Nov;3(11):859–68.
4. Rouzé A, Martin-Loeches I, Povoia P, Makris D, Artigas A, Bouchereau M, et al. Relationship between SARS-CoV-2 infection and the incidence of ventilator-associated lower respiratory tract infections: a European multicenter cohort study. *Intensive Care Med*. 2021 Feb;47(2):188–98.
5. The author(s) received no financial support for the research, authorship, and/or publication of this article.

Topic: Haematologic-oncologic issues in the ICU

000770

Outcomes of Health-care-associated infections in Brazilian ICUs

B. Tomazini¹; A. B. Cavalcanti¹; R. H. N. Santos²; F. A. Medrado Jr.²; IM. Collaborators²

¹Hcor Research Institute, Brazilian Research in Intensive Care Network (BRICNet), São Paulo, Brazil; ²Research Institute, HCor, São Paulo, Brazil

Correspondence: B. Tomazini

Intensive Care Medicine Experimental 2023, **11(Suppl 1)**:000770

Introduction: Healthcare-associated infections (HCAs) are the most common adverse event in hospitalized patients worldwide. Although the burden of HCAs in high-income countries is widely known, limited data is available to assess the characteristics and outcomes of HCAs in low and middle-income countries (LMICs). This study was part of the IMPACTO-MR, a Brazilian nationwide platform to assess infections and multidrug resistance in intensive care units.

Objectives: We aimed to assess the impact of HCAI on hospital length of stay (LOS) and mortality in critically ill patients from Brazil.

Methods: This observational prospective cohort study was nested in the IMPACTO-MR platform. We included all adult patients admitted to the 51 participating ICUs from September 2019, to December 2021. We collected baseline and demographic data at ICU admission, daily data on HCAs (ventilator associated pneumonia – VAP, catheter-associated bloodstream infection – CABS, catheter-related urinary tract infection – CAUTI), LOS and vital status at hospital discharge. HCAs were defined based on Brazilian Health Regulatory Agency (ANVISA) criteria. A multi-state model adjusted for age, SAPS 3 and admission type and considering the exposure to HCAs risk as a time dependent variable was built to evaluate hospital LOS. A Cox Model adjusted for age, SAPS 3 and admission type was used to evaluate mortality.

Results: We included a total of 67,473 patients in this analysis. The infection densities were: 2.13 CABS/1000/device-days, 1.5 CAUTI/1000/device-days, and 7.7 VAP/1000/device-days. Patients’ characteristics are shown in the table below. Patients with HCAI were younger, had a higher proportion of males and clinical admission reason, higher SAPS 3 scores, and more COVID-19 diagnosis at ICU admission. The mean Hospital LOS was 17.4 days vs 41.7 days and Hospital Mortality was 24.8% vs. 57.6% in the no-HCAI vs HCAI groups, respectively. Our multi-state model showed an increase in Hospital LOS of 4.1 days (95% CI 3.2; 5.0, $p < 0.001$). HCAs also increased the mortality risk, when compared to patients without HCAs (HR 1.29, 95% CI 1.22; 1.36, $p < 0.001$).

	HCAI	
	No (n = 64,200)	Yes (n = 3273)
Age, y	61.1 ± 17.7	59.5 ± 16.7
Men, n (%)	33,841 (52.7%)	1971 (60.2%)
Admission type at first ICU admission, n (%)		
Clinical	38,288 (66.2%)	2638 (80.7%)
Elective Surgery	14,054 (24.3%)	232 (7.1%)
Emergency Surgery	5534 (9.6%)	398 (12.2%)
Charlson Comorbidity Index	1.4 ± 1.9	1.3 ± 1.9
Modified Frailty Index	1.4 ± 1.3	1.4 ± 1.3
SAPS 3	46.1 ± 16.6	57.8 ± 15.6
COVID-19 at ICU admission, n (%)	5967 (9.3%)	967 (29.5%)
HCAIs, n*	0	4068
CABSI, n (%)	0 (0%)	1133 (27.8%)
CAUTI, n (%)	0 (0%)	688 (16.9%)
VAP, n (%)	0 (0%)	2247 (55.3%)
Hospital LOS, d	17.4 ± 29.9	41.7 ± 32.7
Hospital Mortality	15,195 (24.8%)	1790 (57.6%)

* Each patient might have more than 1 distinct infection
SAPS 3: Simplified Acute Physiology Score 3

Conclusions: Our results show that HCAIs increase both hospital LOS and mortality. To our knowledge, this is the biggest study on this subject in LMICs, adding important and robust information to the literature on the burden of HCAIs. Also, the use of a multistate model evaluating LOS, showed that although HCAIs are associated with longer LOS, its magnitude is lower than previously published.

References

1. This study was funded by the Program to Support Institutional Development of Universal Health System (Programa de Apoio ao Desenvolvimento Institucional do Sistema Único de Saúde - PROADI-SUS) a nationwide program aimed at strengthening and qualifying the Brazilian Universal Health System (SUS) throughout the country.
2. World Health Organization. Report on the Burden of Endemic Health Care-Associated Infection Worldwide. Genève, Switzerland, 2011. 2. Allegranzi B, Bagheri Nejad S, Combesure C, et al. Burden of endemic health-care-associated infection in developing countries: systematic review and meta-analysis. *Lancet* 2011; 377(9761): 228–41. 3. Tomazini B, Nassar A, Lisboa T, et al. IMPACTO-MR: um estudo brasileiro de plataforma nacional para avaliar infecções e multirresistência em unidades de terapia intensiva. *Rev Bras Ter Intensiva* 2023; 34(4). 4. ANVISA. Critérios Diagnósticos das Infecções Relacionadas à Assistência à Saúde – 2021. In: Saúde Md, editor; 2021. 5. Stewart S, Robertson C, Pan J, et al. Impact of healthcare-associated infection on length of stay. *J Hosp Infect* 2021; 114: 23–31.
3. Allegranzi B, Bagheri Nejad S, Combesure C, et al. Burden of endemic health-care-associated infection in developing countries: systematic review and meta-analysis. *Lancet* 2011; 377(9761): 228–41.
4. Tomazini B, Nassar A, Lisboa T, et al. IMPACTO-MR: um estudo brasileiro de plataforma nacional para avaliar infecções e multirresistência em unidades de terapia intensiva. *Rev Bras Ter Intensiva* 2023; 34(4).
5. ANVISA. Critérios Diagnósticos das Infecções Relacionadas à Assistência à Saúde – 2021. In: Saúde Md, editor; 2021.
6. Stewart S, Robertson C, Pan J, et al. Impact of healthcare-associated infection on length of stay. *J Hosp Infect* 2021; 114: 23–31.

Topic: Infections and prevention

000772

Mild hypercapnia does not improve cerebral oxygenation in patients with hypoxic ischemic brain injury following cardiac arrest

T. Schoenthal¹, R. Hoiland², C. Howe³, T. Gibbons³, J. Cooper⁴, S. Stukas⁴, D. Cardim⁵, C. Wellington⁴, P. Ainslie³, S. Thiara⁶, D. Griesdale², M. Sekhon⁶

¹Department of Medicine, The University of British Columbia, Vancouver, Canada; ²Department of Anesthesiology, Pharmacology And Therapeutics, The University of British Columbia, Vancouver, Canada; ³School of health and Exercise Sciences, The University of British Columbia - Okanagan Campus, Kelowna, Canada; ⁴Department of pathology and laboratory medicine, The University of British Columbia, Vancouver, Canada; ⁵Institute for Exercise And Environmental Medicine, UT Southwestern Medical Center, Dallas, United States of America; ⁶Division of Critical Care Medicine, Department of Medicine, The University of British Columbia, Vancouver, Canada

Correspondence: T. Schoenthal

Intensive Care Medicine Experimental 2023, **11(Suppl 1)**:000772

Introduction: Hypoxic ischemic brain injury (HIBI) following cardiac arrest is associated with poor outcomes. Elevations in arterial carbon dioxide tension (PaCO₂), termed hypercapnia, may hold promise for mitigating secondary injury following HIBI by increasing cerebral blood flow (CBF) and oxygen delivery.

Objectives: We aimed to determine the effect of mild hypercapnia on CBF, brain oxygenation, cerebral arterio-venous differences (a-vDIFF) of blood-based brain biomarkers and cerebrovascular CO₂ reactivity in humans with HIBI versus healthy controls.

Methods: Twenty HIBI patients and 14 healthy controls had radial artery and jugular venous bulb catheters placed to measure blood gases and collect blood specimens for the analysis of blood-based brain biomarkers. The a-vDIFF was determined from the arterial and jugular bulb blood samples, where a negative value indicates cerebral release. Jugular venous bulb oxygen saturation (SjvO₂) was measured as an index of brain oxygenation (oximetry), while blood velocity through the middle cerebral artery (MCAv) was measured as an index of CBF (using transcranial Doppler ultrasound). Physiologic data and blood specimens were collected prior to and during mild hypercapnia (+10 mmHg PaCO₂) in the HIBI patients (1 & 2 h of hypercapnia) and healthy controls (5 min of hypercapnia).

Results: In the HIBI patients, hypercapnia led to a modest (~5%) increase in MCAv from 38 [33–48] to 40 [35–52] cm/s (P=0.03; 2 h timepoint); however, SjvO₂ remained unchanged (76 [65–79] vs. 76 [65–83] %; P=0.73). In the healthy controls, hypercapnia increased MCAv (78 [68–97] vs. 105 [87–128] cm/s; P<0.0001) and SjvO₂ (69 [65–72] vs. 80 [78–83] %; P<0.0001). Comparing HIBI patients to controls, cerebrovascular reactivity to CO₂ was markedly (~95%) lower in the HIBI patients (0.14 [–0.01–0.70] vs. 2.97 [2.41–3.82] cm/s/mmHg; P<0.0001). In the HIBI patients, the arterial concentrations and a-vDIFF of blood-based brain injury biomarkers glial fibrillary acidic protein (GFAP), neurofilament light (Nf-L), and Tau remained unchanged. In the healthy controls, arterial concentrations of blood-based brain injury biomarkers Nf-L and Tau remained unchanged, however GFAP increased (66 [56–84] vs. 83 [64–97] pg/mL; P=0.0003). The a-vDIFF of blood-based brain injury biomarkers in the healthy controls remained unchanged with hypercapnia.

Conclusions: Mild hypercapnia in patients with HIBI led to a modest increase in MCAv but lower cerebrovascular CO₂ reactivity than healthy controls. This impairment in cerebrovascular CO₂ reactivity was associated with no improvement in SjvO₂ during mild hypercapnia. Arterial concentrations and a-vDIFF of blood-based biomarkers of brain injury remained unchanged during hypercapnia.

References

1. Canadian Institute of Health Research (No. 437644)

Topic: Cardiac arrest

000776

Trends in neurocritical care: impact of the COVID-19 pandemic
 G. Morales Varas¹, E. Alonso Ciria¹, M. Sanchez Casado¹, J. Romeu Prieto¹, V. Pais Sánchez-Malingre¹, A. Calle Flores¹, FJ. Moran Gallego¹, L. Marina Martínez¹
¹Critical Care, Hospital General Universitario de Toledo, Toledo, Spain
Correspondence: G. Morales Varas
Intensive Care Medicine Experimental 2023, 11(Suppl 1):000776

Introduction: The COVID-19 pandemic has had a significant impact on the care of neurocritical patients. Patients with neurocritical pathology are at high risk for morbidity and mortality, and the pandemic has further exacerbated the challenges of treating these patients.
Objectives: To analyze the impact of the COVID-19 pandemic on the admission and evolution of neurocritical patients.
Methods: Observational study of patients admitted emergently to a trauma and neurocritical care unit between January 2019 and December 2022. The cohort was compared by differentiating the different periods into pre and post-pandemic years. Admission, demographic, severity, evolution and outcomes of patients with subarachnoid hemorrhage (SAH), major trauma (MT); spontaneous intracerebral hemorrhage (SIH), acute ischemic stroke (AIS) were analyzed. Categorical variables are expressed as counts and percentages and were compared using the χ^2 test and Fisher test; continuous variables are expressed as means and standard deviation and were compared ANOVA test, with Bonferroni test post hoc.

Results: There were a total of 2582 trauma and neurocritical admissions, of which 1505 were emergent: SAH (n = 219), MT (n = 590), SIH (n = 285), AIS (n = 411). During the same period, a total of 648 patients were admitted with critical illness due to COVID-19: 2019 (n=0), 2020 (n=292), 2021 (n=324), 2022 (n=32). 62.5% were men and the mean age was 59.3 ± 17.3 years old, with no statistical difference between the different periods. The temporal evolution of admissions is shown in Figure 1. There were no differences in ICU mortality in the whole cohort; however, during the pandemic ICU length of stay (LOS) progressively decreased (2019: 10.4 ± 12.2; 2020: 8.8 ± 13.8; 2021: 8.6 ± 12.1; 2022: 7.2 ± 10.7, days; p = 0.004). MT had a higher number of admissions in 2022 (post-pandemic) and a higher severity estimated by ISS (injury severity score) on admission during the pandemic period (2020, 2021), p = 0.046. AIS had a significant increase in the number of admissions in the post-pandemic period, with an increase in mortality during the pandemic period and a decrease in the post-pandemic period (2019: 17.4%; 2020: 21.7%; 2021: 20.6%; 2022: 7.6%; p = 0.009). The remaining results are summarized in Table 1.

Conclusions: The COVID 19 pandemic has been a major challenge for neurocritical care units. In our cohort, the number of emergent admissions has been maintained throughout the pandemic, with an increase in MT and IAS in the post-pandemic period. During the pandemic the LOS in ICU was lower and the mortality at ICU discharge did not present statistically significant differences.

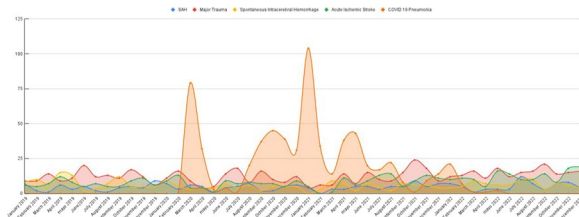

Table (abstract 000776) Multivariate test statistics of serum cortisol under the influence of circadian effective irradiance (EC)

	2019 n=370	2020 n=326	2021 n=345	2022 n=464	p=
Subarachnoid Hemorrhage					
Male, %	n=49	n=53	n=54	n=63	
Age, means (SD), years	21 (42.9%)	21 (39.6%)	20 (37.0%)	30 (47.6%)	0.682
Hunt Hess score, means (SD), pts.	54.7±10.5	58.1±13.9	56.8±14.0	57.2±13.0	0.610
LOS UCI, means (SD), days	2.6±1.4	2.8±1.2	2.6±1.2	2.3±1.2	0.323
Mortality at ICU discharge, %	14.1±14.0	14.6±13.7	12.7±10.8	9.8±10.7	0.148
Major trauma					
Male, %	n=143	n=131	n=137	n=179	
Age, means (SD), years	114 (78.6%)	106 (80.9%)	104 (75.9%)	138 (77.1%)	0.773
Hunt Hess score, means (SD), pts.	51.6±18.5	50.4±18.9	52.5±18.4	51.1±18.5	0.827
LOS UCI, means (SD), days	17.01±8.9	20.25±17.0	21.28±12.0	19.81±12.8	0.046
Mortality at ICU discharge, %	11.5±14.1	8.1±13.0	8.2±10.0	8.1±11.9	0.039
Spontaneous intracerebral hemorrhage					
Male, %	n=92	n=59	n=57	n=77	
Age, means (SD), years	54 (58.7%)	34 (57.6%)	25 (43.9%)	49 (63.6%)	0.138
ICH score, means (SD), pts.	65.1±13.3	63.7±13.2	62.2±15.4	60.9±17.7	0.325
LOS UCI, means (SD), days	2.2±1.4	2.4±1.4	2.5±1.3	2.4±1.3	0.617
Mortality at ICU discharge, %	10.0±11.1	9.7±15.6	11.4±19.7	8.7±12.2	0.752
Acute ischemic stroke					
Male, %	n=86	n=83	n=97	n=145	
Age, means (SD), years	47 (54.7%)	46 (55.4%)	48 (49.5%)	85 (58.6%)	0.579
NIHSS, means (SD), pts.	66.0±12.4	64.4±14.7	68.6±13.8	69.7±12.2	0.016
LOS UCI, means (SD), days	15.5±5.4	16.9±6.5	13.9±7.3	13.3±7.4	0.002
Mortality at ICU discharge, %	6.5±7.2	3.9±6.3	5.2±7.9	4.3±7.1	0.080
Mortality at ICU discharge, %	15 (17.4%)	18 (21.7%)	20 (20.8%)	11 (7.6%)	0.009

Topic: Neurointensive care

000778

An audit of rEEG in an Indian ICU

C. Chakravarty¹, S. Chaudhary²
¹Critical Care Apollo Multispeciality Hospitals, Kolkata, Kolkata, India;
²Critical Care Medicine, Apollo Multispeciality Hospitals, Kolkata, Kolkata, India

Correspondence: C. Chakravarty
Intensive Care Medicine Experimental 2023, 11(Suppl 1):000778

Introduction: Amidst the increasing awareness of the importance of EEG in hospitalised patients with altered sensorium, most are done in the ICU. There are certain specified indications for doing EEG in ICU and most organisations recommend doing a continuous EEG over 30 to 48 h (rarely longer). However, in resource constrained settings, doing cEEG is labor intensive and resource consuming. We wanted to audit 100 patients who underwent rEEG in the year 2021–22 in tertiary care mixed ICU of Kolkata, India. This audit highlights the use and misuse of rEEG, to what extent it could pick up seizures, and how pharmacological agents may affect EEG findings.

Methods: 21–23 lead EEG was done in patients with altered sensorium which was unexplained by available clinical factors as well as physicians' gestalt. Each rEEG was done over 20 min and repeated once more within 48 h if advised, but not on the same day. The rEEGs were interpreted by trained neurologists and reported. The age, comorbidities, neurological diagnosis, infections, antibiotics and anti epileptics were recorded along with the EEG findings.

Results: A statistical analysis was done of the collected data using Pearson Chi square test to find out any significant association between the EEG findings and other factors, viz. leukocytosis or leukopenia

hyponatremia or hypernatremia, calcium level, blood culture positivity, urine culture positivity, sputum culture positivity, antibiotics, neuroimaging and renal failure. Analysis showed the majority of patients were subjected to rEEG because of altered mental status 81% and 9% were done for jerky movements, blank stare or myoclonus. Of these 5% were done after cardiac arrest. Four predominant EEG findings were 1. Encephalopathy 2. Seizure spikes 3. Triphasic waves, 4. Diffuse slowing. Imaging studies revealed 7 strokes, 2 TBI and 1 SOL. Leukocytosis was seen in 10 patients, leukopenia in 1, hyponatremia in 4, hypercalcemia in 1 patient. Most common antibiotic was meropenem in 14 patients. Majority were male patients. 21% of patients were having seizure spikes in EEG. All of them were treated with AED. 7 patients were treated with 2 or more AEDs. Most common EEG findings in these patients were encephalopathy in 54%. Another 19% had diffuse slowing whereas 6% had triphasic waves. Chi square test could not show any correlation between seizures and renal failure or antibiotics (Mero/PolyB) or infections.

Conclusions: The increasing role of EEG in identifying patients with non-convulsive seizures is being recognised in various studies. A recent publication (4) has also questioned the need for cEEG in all ICU patients as compared to rEEG. Continuous EEG picked up more spikes on EEG which qualified as seizure (more than 5 s) but did not change outcome or mortality when compared to rEEG in the other group. The incidence of seizures picked up by rEEG in this study was comparable to our audit although two rEEGs were done in all patients on two consecutive days in this study. Our study found most patients were done for acute change in mental status. In resource limited settings, a rEEG done for 20 min also picked up 21% seizures of which 12% were non-convulsive seizures. Unlike usual belief no correlation was found with sepsis, renal failure or electrolyte imbalance although the numbers were very few. It is also a common practice to assume carbapenems cause seizures and stop it in any patient with mental status change. However, neither meropenem or Polymyxin or any other combination of these two drugs could show any correlation with incidence of seizures. The study was not followed for outcome or mortality hence the effect of rEEG on mortality was not assessed.

References

1. Introduction to interpretation of EEG in intensive care. L. Sewell, A. Abbas, N. Kane. *BJA Educ*. 2019 March; 19(3):74–82.
2. 130 continuous EEG monitoring in Australia's first year audit of practice 2018–2019 of combined hospital epilepsy program in Melbourne. Joshua Laing, Georgia Grant, Cecilia Harb et al. *BMJ Journals* vol 90, Issue 7.
3. An audit of continuous EEG monitoring in the neurological neurosurgical intensive care unit. Nitin K Seth, Beth S, Gacl E Solomon. *J Clin Neurophysiol*. 2014 Oct; 31(5):146–7.
4. Continuous vs routine EEG in critically ill adults with altered mental consciousness and no recent seizure. Andra O. Rossetti, Kaspar Schindler et al. *JAMA Neurol*. 2020; 77(10): 1225–1232.
2. None

Topic: Neurointensive care

000779

Needs and priorities in eHealth follow-up care from the perspectives of patients' relatives in the intensive care unit

E. Berger¹, P. Van Der Meer¹, M. Van Der Veer¹, M. Van Mol¹

¹Department of Intensive Care, Erasmus University Medical Center, Rotterdam, Netherlands

Correspondence: E. Berger

Intensive Care Medicine Experimental 2023, **11(Suppl 1)**:000779

Introduction: For patients' relatives, intensive care unit (ICU) admission is known to be a stressful event [1]. As a result, they are at risk of developing post intensive care syndrome family (PICS-F) [2]. In addition to inpatient follow-up contact, eHealth innovations might be an easy, user-friendly and inexpensive method to self-monitor symptoms of PICS-F [3]. It is unknown which eHealth interventions in ICU follow-up care meet the best the needs of ICU patients' relatives to reduce PICS-F [4].

Objectives: To explore the needs and priorities in eHealth follow-up care from the perspectives of ICU patients' relatives.

Methods: A qualitative multicentre study in four ICUs including one academic medical centre and three general hospitals. One focus group interview was conducted in each participating hospital, and for each interview five to ten relatives were included. A priori, a semi-structured topic list was drafted and followed during the meetings. All interviews were audio-recorded and transcribed verbatim. Data were analysed by two researchers with a thematic approach.

Results: All participants involved in the first two focus groups were partners of former ICU patients (n=10). Median [interquartile range] length of ICU stay of the patients was 24 [17–30] days. The focus group discussion yielded several key themes related to the experiences of patients' relatives. The first theme comprised physical and psychological symptoms experienced by participants including pain, exhaustion, anxiety, stress, insomnia, powerlessness and worrying about their relatives. The second theme that emerged from the discussions was the social dilemma. Participants expressed that the period after ICU discharge was experienced as arduous and restrictive due to concerns and fears of leaving their partner alone. This resulted in decreased social contacts and feelings of guilt, whether or not to do something for oneself. The third theme focused on facilitating recovery after ICU discharge. Participants shared several strategies that helped them cope with their experience, including talking about their ICU experience with their relatives, utilizing an ICU diary and photographs, visiting a general practitioner, going to an acupuncturist, and attending an ICU follow-up clinic. The importance of providing personalized information through a web portal, analogous to a diary, was also emphasized. Finally, participants expressed that sharing their experiences with peers during the focus group interview was helpful and provided a sense of support. The incorporation of peer support into an eHealth application, such as using stories or videos of peers, was suggested as a potential strategy to enhance support for individuals and their relatives following ICU discharge.

Conclusions: Preliminary data suggest that ICU patients' relatives have a need for information and support through an eHealth intervention to mitigate PICS-F and a social dilemma after discharge. A digital diary and peer support were suggested to help to strengthen their coping mechanisms.

References

1. Needham DM, Davidson J, Cohen H, Hopkins RO, Weinert C, Wunsch H, Zawistowski C, Bemis-Dougherty A, Berney SC, Bienvenu OJ, Brady SL, Brodsky MB, Denehy L, Elliott D, Flatley C, Harabin AL, Jones C, Louis D, Meltzer W, Muldoon SR, Palmer JB, Perme C, Robinson M, Schmidt DM, Scruth E, Spill GR, Storey CP, Render M, Votto J, Harvey MA. Improving long-term outcomes after discharge from intensive care unit: report from a stakeholders' conference. *Critical care medicine*. 2012. 40(2): p. 502–509.
2. Van Beusekom I, Bakhshi-Raiez F, de Keizer NF, Dongelmans DA, van der Schaaf M. Reported burden on informal caregivers of ICU survivors: a literature review. *Critical Care*. 2015. 20(1): p. 1–8.
3. Shin JW, Choi J, Tate J. Interventions using digital technology to promote family engagement in the adult intensive care unit: An integrative review. *Heart & Lung*. 2023. 58: p. 166–178.
4. Zante B, Camenisch SA, Schefold JC. Interventions in Post-Intensive Care Syndrome-Family: A Systematic Literature Review. *Critical care medicine*. 2020. 48(9): p. e835–e840.
5. This study received funding from ZonMw (Project number: 10040022110001)

Topic: Nursing care and physiotherapy

000781

The impact of therapeutic plasma exchange on the immune response in septic shock: results from the EXCHANGE trial

A. Sauer¹, K. Stahl², B. Seeliger³, PD. Wendel Garcia⁴, F. Lehmann¹, J. Schmidt⁵, B. Schmidt⁵, T. Welte³, C. Putensen¹, S. David⁴, C. Bode For The Bonha40635_2023_546nza Study Group¹

¹Department of Anesthesiology and Intensive Care Medicine, University Hospital Bonn, Bonn, Germany; ²Department of Gastroenterology,

Hepatology and Endocrinology, Hannover Medical School, Hannover, Germany; ³Department of Respiratory Medicine and German Centre of Lung Research (DZL), Hannover Medical School, Hannover, Germany; ⁴Institute of Intensive Care Medicine, University Hospital Zurich, Zürich, Switzerland; ⁵Department of Nephrology and Hypertension, Hannover Medical School, Hannover, Germany

Correspondence: A. Sauer

Intensive Care Medicine Experimental 2023, **11(Suppl 1)**:000781

Introduction: Septic shock, characterized by a complex dysregulation of the immune system, is among the leading causes of death in the ICU. Despite advances in understanding the underlying pathomechanisms, there is still no specific treatment available. Therapeutic plasma exchange (TPE) represents an emerging adjunctive treatment option to restore an imbalanced immune homeostasis. A recent randomized-controlled trial revealed a rapid improvement in hemodynamics, probably due to the elimination of harmful mediators and replacement of protective plasma proteins.

Objectives: The goal of this study is to further describe the underlying immunomodulatory mechanisms and to predict treatment response based on potential biomarkers.

Methods: After obtaining written informed consent, 53 patients with early septic shock (< 24 h duration) who received norepinephrine (NE) at a rate of ≥ 0.4 $\mu\text{g}/\text{kg}/\text{min}$ were randomized to receive either standard of care (SOC) or SOC + a single TPE. TPE was immediately initiated after randomization. Blood samples were drawn at randomization and 6 h after randomization. Levels of inflammatory mediators (IL-6, IL-8, TNF- α , IL-2Ra), acute phase proteins (CRP and pentraxin3 (PTX3)) and damage-associated molecular patterns (DAMPs) (cell-free DNA (cfDNA), HMGB1) were analyzed via multiplex analysis or ELISA.

Results: TPE caused a significant reduction in acute-phase protein levels (CRP $p=0.0008$, PTX3 $p=0.0008$) while no difference was observed in the SOC group. Serum levels of inflammatory cytokines TNF- α , IL-6- und IL-8 were significantly reduced in both groups, though no significant difference was observed between groups except for IL-2Ra ($p=0.02$). cfDNA und HMGB1 levels were significantly reduced in the TPE group compared to the SOC group ($p=0.004$, $p=0.03$). Treatment responders, defined as a decrease in NE dose of $\geq 50\%$ 6 h post randomization, showed significantly decreased IL-8 and increased cfDNA levels compared to non-responders.

Conclusions: TPE is associated with the removal of inflammatory mediators such as acute-phase proteins and DAMPs that may explain the rapid hemodynamic improvement recently detected in septic shock patients. A dual biomarker approach (increased cfDNA levels in combination with decreased IL-8 levels) may predict treatment response.

Topic: Sepsis

000782

Clinical implication of extremely high hypercytokinemia in septic shock

L. Chiscano¹, A. Ruiz-Sanmartin¹, L. Martín Sánchez¹, C. Palmada¹, I. Bajaan¹, V. Ribas², C. Franco-Jarava³, M. Hernandez-Gonzalez³, R. Ferrer Roca¹, J.C. Ruiz-Rodriguez¹

¹Intensive Care Department, Vall d'Hebron University Hospital, Barcelona, Spain; ²EURECAT, EURECAT, Barcelona, Spain; ³Immunology Department, Vall d'Hebron University Hospital, Barcelona, Spain

Correspondence: L. Chiscano

Intensive Care Medicine Experimental 2023, **11(Suppl 1)**:000782

Introduction: Interleukin-6 (IL-6) is a molecule that has proinflammatory effects in sepsis, and which has been consistently associated with patient outcomes. Patients with extremely high levels of IL-6 have not been previously characterized.

Objectives: To describe the clinical and prognostic profile of a subgroup of patients with septic shock and extremely high hypercytokinemia.

Methods: Single-center, observational, retrospective. Inclusion criteria: septic shock, multiorgan dysfunction and extremely high levels of IL-6 who were activated by Sepsis Code in the period from September 2018 to December 2022. Sepsis-3 criteria were used for the diagnosis of sepsis. IL-6 (analysis performed through electrochemiluminescence immunoassay; Elecsys[®] IL-6, from ROCHE) in a peripheral blood sample was prospectively detected in the first 12 h of shock evolution. There is no agreed definition of extreme hypercytokinemia, so we have arbitrarily defined it as those IL-6 levels greater than 5,000 pg/mL. Demographic variables, severity (APACHE II), organic dysfunction (SOFA), mortality (ICU and hospital) have been collected. The data have been expressed as "n" (%) if they are categorical and as median (interquartile range) or mean (standard deviation) if they are quantitative and were compared using the Student's T test. Multivariate logistic regression was performed for hospital mortality. The study was approved by the Clinical Research Ethics Committee of our center (PR(AG)336/2016).

Results: During the described period, 74 patients met the inclusion criteria: 56.8% women, 64 (17) year-old, SOFA 11 (7), cardiovascular SOFA 4 (1), APACHE II 24 (12), baseline lactate 5.5 (4.2). Table 1 summarizes the characteristics of the included patients. The median IL-6 was 115,705 (251,261) pg/ml and was higher in patients who did not survive (480,406 vs 118,352 pg/ml, $p=0.002$). IL-6 levels greater than 318,738 pg/ml are associated with mortality greater than 60% and a change in the trend is observed when IL-6 exceeds 186,167 pg/ml (Figure 1). In the multivariate analysis, the SOFA scale and IL-6 level were associated with mortality while lactate levels were not. Hospital mortality was 56%, and ICU mortality was 34.7%.

Conclusions: In patients with septic shock and multiorgan dysfunction, extremely high levels of IL-6 are associated with very high mortality. Extreme hypercytokinemia could be considered as a clinical diagnostic tool to select patients with septic shock and multi-organ dysfunction who may be eligible for precision medicine through the application of cytokine hemoadsorption.

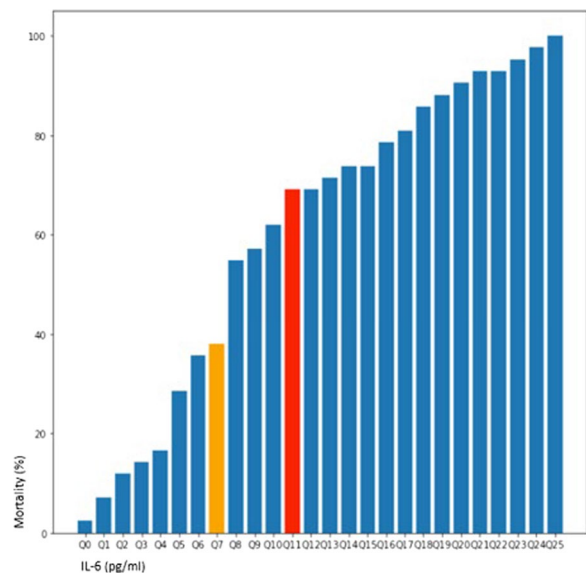

Figure 1 (abstract 000782) Representation by quantiles in relation to accumulated mortality. Mortality exceeds 60% when the IL-6 value exceeds 318,738 pg/ml (red quantile) and a change in trend is observed when IL-6 exceeds 186,167 pg/ml (yellow quantile)

Table 1 (abstract 000782) Characteristics of the study population. The data have been expressed as "n" (%) if they are categorical and as median (interquartile range) or mean (standard deviation) if they are quantitative. The biochemical and analytical variables refer to the initial value after activation of the Sepsis Code. CKD: chronic kidney disease.

		N = 74
Age [m(IQR)]		64(17)
Gender [m(IQR)]		Female 42(56.8) Male 32(43.2)
SOFA [m(IQR)]		11 (7)
SOFA - cardiovascular[m(IQR)]		4 (1)
Septic cardiomyopathy [m(IQR)]		17(23)
APACHE II [m(IQR)]		24(12)
Comorbidities [n(%)]	Immunosuppression	42 (56)
	Cardiac	12 (16)
	Respiratory	8 (10)
	Liver cirrhosis	6 (8)
	CKD	9 (12)
Inflammatory response [n(%)]	Septic shock	74 (100)
Infection source [n(%)]	Respiratory	9 (12)
	Abdominal	33 (45)
	Urinary tract infection	19 (26)
Site of infection acquisition[n(%)]	Community-acquired	31 (42)
	Nosocomial	22 (30)
	Health-care related	15 (20)
Leukocyte count [m(IQR)]		2.6x10e9/L (8.4x10e9/L)
Lymphocyte count [m(IQR)]		200 (200)
Platelet count [m(IQR)]		13000 (121500)
Lactate [m(IQR)]		5.5(4.2)mmol/L
CRP [m(IQR)]		14 (14)mg/dl
PCT [m(IQR)]		29.8 (53.7)
IL-6 [m(IQR)]		115705 (251261) pg/ml
Length of hospital stay [m(IQR)]		29 (29)
In-hospital mortality [n(%)]		42 (56)
ICU mortality [n(%)]		26 (35)

References

1. No funding

Topic: Sepsis

000783

Delirium in intensive care: long-term mental health implication in critical ill COVID-19 survivors

P. Rodríguez Villamizar¹, G. Morales Varas¹, M. Márquez Doblas², A. Cuadra-Calahorra¹, G. Alonso Gómez³, P. Carneiro Pereda¹, M. Vecino Montoya¹, E. Alonso Ciria³, V. Pais Sánchez-Malingre⁴, I. GÓMEZ CANO⁵; J. Guerra Cuervo¹

¹Intensive Care Department, Hospital Universitario de Toledo, Toledo, Spain; ²Intensive Care Unit, Virgin Health Hospital, Toledo, Spain; ³Intensive Care Department, Hospital General Universitario de Toledo, Toledo, Spain; ⁴Intensive Care Unit, Hospital General Universitario de Toledo, Toledo, Spain; ⁵Intensive Care Medicine, Hospital Universitario de Toledo, Toledo, Spain

Correspondence: P. Rodríguez Villamizar

Intensive Care Medicine Experimental 2023, 11(Suppl 1):000783

Introduction: Patients with COVID-19 are at risk for delirium due to several factors (1). Additionally it is well known that delirium may be related to the development of symptoms of Post-Traumatic Stress Disorder (PTSD) (2). In this article, we describe our experience in COVID-19 patients that developed ICU-delirium together with its impact in mental health after one year of ICU discharge.

Objectives: To analyze the impact of ICU-delirium as a complication of the COVID-19 critical infection in mental health after one year of ICU discharge.

Methods: This cross-sectional study among critical ill COVID-19 survivors aged 18 years who presented delirium during intensive care unit admission. Mental health was assessed one year after ICU discharge. Medical records were reviewed and a validated instrument was used: the Post-Traumatic Stress Disorder Checklist-5 (PCL-5), based on the Diagnostic and Statistical Manual of Mental Disorders (DSM-5) for screening PTSD which was administered through phone-based questionnaire. The PCL-5 can determine a provisional diagnosis of PTSD using a cut-point score of 31–33. Categorical variables are expressed

as counts and percentages and were compared using the χ^2 test and Fisher test; continuous variables are expressed as medians and interquartile range (IQR) and were compared using Mann–Whitney U test. A two-sided level of significance of 5% was used. Data analysis was performed using STATA version 13[®] (StataCorp LCC).

Results: A total of 270 patients agreed to answer the phone survey. The 46% of them developed ICU-delirium. One-year mortality didn't differ between patients with or without delirium (7,46% Vs 4,81%, $p=0,2$), but those who developed ICU-delirium have an increased in hospital length of stay (24 Vs 8 days; $p=0$) and ICU length of stay (22 Vs 38 days; $p=0$). There were not significant differences in the demographics baseline. Treatment with psychotropic drugs (antidepressants, benzodiazepines, neuroleptics and opioids) was collected before ICU-admission and after 1 year from ICU discharge. A comparison between patients who didn't developed ICU-delirium and patients who developed it showed that the latter group of patients was taking higher doses of benzodiazepines after 1 year from ICU discharge (1,39% Vs 1,61%; $p=0,01$). With respect to PTSD, our study indicates that it was more frequent in patients who developed ICU-delirium (14,4% Vs 5,52%; $p=0,01$). The items with higher scores were:

1. Repeated, disturbing and unwanted memories of the stressful experience.
2. Repeated, disturbing dreams of the stressful experience.
3. Suddenly feeling as if the stressful experience was actually happening.
4. Having strong physical reactions when something reminded you of the experience.
5. Trouble remembering important parts of the experience.
6. Having difficulties for concentrating.

Conclusions: Patients who developed ICU-delirium were treated with higher doses of benzodiazepines than before admission after one year of ICU discharge. There were not differences in mortality but the group with ICU-delirium had an increase in hospital and ICU length of stay. PTSD as a marker of mental health was more frequent in patients who developed ICU-delirium.

Table 1 (abstract 000783) Baseline characteristics, mortality and length of stay

Characteristics	Not ICU-delirium n = 145 (53,7%)	ICU-delirium n = 125 (46,3%)	Total n = 270	p =
Women (%)	59/145 (40,69%)	42/125 (33,6%)	101/270 (37,41%)	0.2
Man (%)	86/145 (59,31%)	83/125 (66,4%)	169/270 (62,59%)	0,23
Age (years) [IQR]	60 (49-66)	60 (51-68)	60 (49-67)	0,41
BMI [IQR]	29,41 (27-35)	29,7 (26-33,9)	29,4 (26,5-33,9)	0,62
Charlson (median) [IQR]	2 (1-3)	2 (1-3)	2 (1-3)	0,39
Fragility (CFS) [IQR]	2 (2-3)	3 (2-3)	2 (2-3)	0,60
One year mortality (%)	15/201 (7,46%)	9/187 (4,81%)	24/388 (6,19%)	0,27
ICU length of stay (median) [IQR]	8 (4-17)	24 (13-33)	14 (7-28)	0,0
Hospital length of stay (median) [IQR]	22 (14-40)	38 (27-55)	30 (19-47)	0,0

Table 2 (abstract 000783) Psychorotic treatment before and after ICU admission

Psychotropic at one year of follow-up	Not ICU-delirium n = 145 (53,7%)	ICU-delirium n = 125 (46,3%)	p =
Antidepressant			
· Initiated after ICU admission	19/144 (13,19%)	22/124 (17,7%)	p = 0.44
· Same as before ICU admission	5/144 (3,47%)	2/124 (1,6%)	
· Higher doses than before ICU admission	1/144 (0,69%)	0 (0%)	
Benzodiazepines			
· Initiated after ICU admission	33/144 (22,9%)	40/124 (32,2%)	p = 0.01
· Same as before ICU admission	1/144 (0,69%)	8/124 (6,4%)	
· Higher doses than before ICU admission	2/144 (1,39%)	2/124 (1,61%)	
Neuroleptic			
· Initiated after ICU admission	12/143 (8,3%)	11/124 (8,8%)	p = 0.68
· Same as before ICU admission	3/143 (2,1%)	1/124 (0,8%)	
· Higher doses than before ICU admission	0 (0%)	0 (0%)	
Opioid			
· Initiated after ICU admission	12/144 (8,3%)	13/124 (10,4%)	p = 0.82
· Same as before ICU admission	1/144 (0,69%)	1/124 (0,8%)	
· Higher doses than before ICU admission	0 (0%)	0 (0%)	

References

1. Bolton C, Thilges S, Lane C, Lowe J, Mumby P. Post-traumatic Stress Disorder Following Acute Delirium. *J Clin Psychol Med Settings*. 2021 Mar;28(1):31–39. doi: <https://doi.org/10.1007/s10880-019-09689-1>. PMID: 31823162.
2. Koffis K, Williams Roberson S, Wilson JE, Dabrowski W, Pun BT, Ely EW. COVID-19: ICU management during SARS-CoV-2 pandemic. *Crit Care*. 2020 Apr 28;24(1):176. doi: <https://doi.org/10.1186/s13054-020-02882-x>. PMID: 32345343; PMCID: PMC7186945.

Topic: Sedation, analgesia and delirium

000784

Indications, efficacy, and safety profiles of dual treatment with Levosimendan and Sildenafil in critically ill adult patients

U. Ojha¹, M. Chakravarty², K. Guha³, H. Soliman-Aboumarie², S. Kaul²
¹Cardiothoracic Intensive Care, Royal Brompton & Harefield Nhs Foundation Trust, London, United Kingdom; ²Cardiothoracic Intensive Care, Royal Brompton & Harefield Nhs Foundation Trust, London, United Kingdom; ³Cardiology, Portsmouth Hospitals NHS Trust, Portsmouth, United Kingdom

Correspondence: U. Ojha
Intensive Care Medicine Experimental 2023, **11(Suppl 1)**:000784

Introduction: The role of inotropic agents within patients with acute heart failure (AHF) and advanced heart failure (AdHF) remains unclear. Both the phosphodiesterase inhibitor-5 (Sildenafil) and the calcium sensitiser (Levosimendan) may enhance cardiac function within certain patients, when utilised as monotherapies. The combination of these therapies has not been studied previously.

Objectives: To report our clinical experiences regarding the indications, efficacy, and safety profiles of dual treatment with Levosimendan and Sildenafil in critically ill adult patients.

Methods: An observational retrospective analysis was performed for all patients admitted to Intensive Care Unit (ICU) between July 2010 and October 2021 who received both Levosimendan and Sildenafil within seven days of each other. Clinical and mortality data was obtained from the hospital electronic record.

Results: 112 patients received dual treatment with Levosimendan and Sildenafil. The group included 74 (66.1%) males and 38 (33.9%) females, with a mean age of 55.0 ± 16.5 years. Mean body mass index was 27.6 ± 5.5 kg/m². The mean Simplified Acute Physiology (SAPS) II score was 38.4 ± 11.5 . Indications for combined use of Levosimendan and Sildenafil were primarily right ventricular failure (33.9%) and biventricular failure (48.2%). Other indications also included pulmonary hypertension (8.0%), left ventricular failure (7.1%), weaning from intra-aortic balloon pump (0.8%) and weaning from veno-arterial extracorporeal membrane oxygenation (0.8%). The median length of stay on ICU was 27 ([interquartile range (IQR) 16–47] days). The Median vasoactive-inotropic score (VIS) decreased from 13.5 (IQR 3.5–23.0) pre dual therapy to 10 (IQR 1 – 20) after 72 h ($p=0.0005$). Median oxygenation index increased from 38.1 (IQR 26.3–46.3) pre combined treatment to 40 (30.5 – 50) after 72 h ($p=0.019$). 76 patients (69.1%) were discharged from ICU, 3 patients (2.73%) were readmitted to ICU within 48 h and overall hospital survival rate was 55.1%.

Conclusions: The study documents the novel observation of the combination use of sildenafil and Levosimendan. Further work is needed to understand and characterise this novel observation in more detail.

Topic: Cardiovascular issues in ICU

000785

Safe delivery of prolonged thrombolysis treatment for pulmonary embolism using ClotPro viscoelastic test - preliminary results

A. Kállai¹, D. Skultéti¹, A. Párkányi¹, E. Biró¹, A. Fehér², G. Szombath³, Z. Iványi¹, J. Fazakas¹, J. Gál¹

¹Department of Anesthesiology and Intensive Therapy, Semmelweis University, Budapest, Hungary; ²Department of Laboratory Medicine,

Semmelweis University, Budapest, Hungary; ³Department of Internal Medicine and Hematology, Semmelweis University, Budapest, Hungary

Correspondence: A. Kállai
Intensive Care Medicine Experimental 2023, **11(Suppl 1)**:000785

Introduction: The 2019 ESC guideline for the diagnosis and management of acute pulmonary embolism (PE) recommends thrombolytic therapy only in high-risk PE cases because of the bleeding risk [1]. According to the literature, the risk of major haemorrhage is 10% and fatal or intracranial bleeding is 1,7% among patients receiving thrombolysis with rtPA, the most often used drug [2]. The recommended dose is 100 mg over 2 h.

Objectives: Based on our previous observations, this work aimed to increase the safety and efficiency during thrombolysis by using the viscoelastic tests of the ClotPro system.

Methods: Adult patients at Central ICU of the Semmelweis University diagnosed with PE between December 2021 and April 2023 were enrolled in this randomised interventional study.

In the control group viscoelastic measurements were performed without any modification in the thrombolysis.

In the ClotPro guided group EX, IN, FIB, TPA, AP, ECA and RVV tests were performed every hour during thrombolysis. The dose of rtPA was modified based on the FIB and ECA tests' lysis time and maximum clot firmness. Fibrinogen was administered to maintain the FIB MCF over 9 mm. Echocardiography was performed every two hours for right ventricular dysfunction (RVD) signs. If the RVD were reversed, the thrombolysis was terminated.

Results: A total of 21 patients (pts) were eligible. 6 pts were excluded due to active bleeding (2 pts) or intermediate-low risk (4 pts). 6 pts were randomised in the control group (female/male: 3/3; mean age: 67.46 ± 8.95 years); 9 pts in the ClotPro guided group (female/male: 3/6; mean age: 57.89 ± 14.9). Based on the echocardiography, the length of the thrombolysis was different in the ClotPro guided group (mean length: 8.55 ± 1.86 h). The dosage rate and the cumulative dose of rtPA were modified (mean dose: 37.44 ± 11.92 mg). 5 pts needed fibrinogen substitution (1–6 g).

In the control group patients received 100 mg/2h of rtPA. Alteration of the therapy was required because of severe bleeding on two occasions. In one case pericardial hematoma and gastrointestinal bleeding occurred when the thrombolysis was done after non-traumatic CPR. In the other case blood aspiration occurred due to rhinorrhagia. Only 3 pts (50%) in the control group showed early right ventricular function improvement. In two cases the RVD persisted despite the lysis and in one case the right ventricular function wasn't measurable due to the pericardial hematoma. Prolonged (> 12 h), severe functional fibrinogen deficit (FIB MCF 0 mm) was observed on four occasions after thrombolysis.

In the ClotPro guided group RVD was dissolved in all cases. There was one adverse bleeding event, cerebral haemorrhage (the patient denied that he suffered trauma, later it came to our knowledge that he had collapsed before hospital admission).

Conclusions: The new ClotPro guided prolonged thrombolysis's revascularisation effect seems to be efficient and safe. Further randomised controlled studies are needed to validate this observation.

References

1. 1: Konstantinides S. V., et al. (2019). "2019 ESC Guidelines for the diagnosis and management of acute pulmonary embolism developed in collaboration with the European Respiratory Society (ERS): The Task Force for the diagnosis and management of acute pulmonary embolism of the European Society of Cardiology (ESC)." *Eur Heart J* 2019; 41(4): 543–603.
2. 2: Marti C, John G, Konstantinides S, et al. Systemic thrombolytic therapy for acute pulmonary embolism: a systematic review and meta-analysis. *Eur Heart J* 2015; 36: 605–614.
3. The study was supported with ClotPro reagents by Diacare Solutions Kft.

Topic: Cardiovascular issues in ICU

000788

In-hospital cardiac arrest in a county hospital. Epidemiological features and risk factors

M. Salgado¹, A. Alonso¹, M. Cózar¹, A. Alvarez¹, A. Ubeda¹

¹Intensive care unit, Hospital Punta de Europa, Algeciras, Spain

Correspondence: A. Ubeda

Intensive Care Medicine Experimental 2023, **11(Suppl 1)**:000788

Introduction: In-hospital cardiac arrest is associated with a high mortality rate. Despite this, it has received little attention compared with stroke or myocardial infarction.

Objectives: To analyze the epidemiological features as also the factors related to mortality in patients admitted to the ICU after recovery from cardiac arrest (CA).

Methods: Retrospective descriptive analysis on a prospective cohort performed in a 15-bed ICU from 2019 to 2022. Demographic outcomes, comorbidities, severity scores (APACHE II and SAPS II), treatment received, mechanical ventilation (MV), risk factors, ICU acquired infections, antibiotherapy, ICU and hospital length of stay (LOS) and mortality were collected.

Statistical analysis: categorical variables (frequencies and percentages) and quantitative variables (mean and standard deviation or median and interquartile range). Comparisons: X2 test (percentages), Student's t test (means) and Mann-Whitney U test (medians). Multivariate logistic regression. Statistical significance at $p < 0.05$.

Results: 1470 patients were included. CA group (N=50) vs. non-CA group (n=1420) were compared: Age (68.4 ± 14.7 vs 63.1 ± 15.3 , $p = 0.015$). SAPS II ($58.5 [49.25; 69.75]$ vs $28 [19; 42]$, $p = < 0.001$), APACHE II ($23 [18; 27.5]$ vs $10.5 [6; 16]$, $p = < 0.001$); GCS ($15 [8; 15]$ vs $15 [13; 15]$, $p < 0.001$). COVID infection (0 (0) vs 166 (11.6), $p = 0.004$). Risk factors: Central venous catheter (CVC) (98% vs 60%, $p < 0.001$); MV (98% vs 39.7%, $p < 0.001$), Urinary catheter (UC) (100% vs 70.4%, $p < 0.001$). Comorbidities: neoplasia (4% vs 16.5%, $p = 0.016$); Chronic obstructive pulmonary disease (COPD) (18% vs 8.3%, $p = 0.032$). Duration of MV (days) ($5 [1; 11]$ vs $0 [0; 2]$, $p < 0.001$); Duration of CVC (days) ($9 [4; 15]$ vs $1 [0; 6]$, $p = 0.001$). Mortality (60% vs 28.4%, $p < 0.001$).

Survivors and dead were compared: Dead (n=30) vs. survivors (n=20): SAPS II ($66 [54; 75]$ vs $54 [38; 58]$, $p = 0.006$); APACHE II ($25 [20; 32]$ vs $19 [15; 24]$, $p = 0.007$). Duration of MV (days) ($3 [1; 5]$ vs $1 [1; 3]$, $p = 0.040$); ICU-LOS ($3 [1; 5]$ vs $4 [3; 8]$, $p = 0.087$), Hospital-LOS ($4 [2; 12]$ vs $14 [8; 21]$, $p = 0.004$); non-invasive ventilation (NIV) (0 [0; 0] vs 0 [0; 0]; $p = 0.004$); First period of CVC (days) ($2 [1; 4]$ vs $4 [3; 6]$, $p = 0.021$). Location of cardiac arrest ($p = 0.291$): out-of-hospital (23.3% vs 15%), wards (36.6% vs 25%), emergency department (23.3% vs 55%). Initial rhythm ($p = 0.767$): asystole (66.6% vs 65%), Ventricular fibrillation (V-Fib)/Ventricular tachycardia (V-tach) (13.3% vs 25%), Pulseless electrical activity (PEA) (16.6% vs 10%). Multivariate logistic regression: APACHE II (OR 1.12 [1.03–1.26, $p = 0.018$).

Conclusions: Mortality in patients successfully resuscitated from cardiac arrest who were admitted to the intensive care unit is quite high. No differences were found in terms of locations of CA or initial rhythm. Prognosis score APACHE II was associated as an independent risk factor for mortality.

Topic: Cardiac arrest

000791

Use of angiotensin II for refractory vasodilatory shock in intracerebral hemorrhage

N. Zorko Garbajs¹, N. Milivojević¹

¹Department of Vascular Neurology and Intensive Therapy, University Medical Center Ljubljana, Ljubljana, Slovenia

Correspondence: N. Zorko Garbajs

Intensive Care Medicine Experimental 2023, **11(Suppl 1)**:000791

Introduction: Neurogenic shock occurs in patients with acute neurologic injuries, namely acute brain, spinal cord, and rarely peripheral

nerve injuries. Caused by three mechanisms, vasodilatory (distributive), cardiogenic, and adrenal insufficiency, its treatment is accordingly complex. Mostly contributed to cardiogenic shock, hypotension occurs in 3% of subarachnoid hemorrhage patients. Isolated vasodilatory shock, unresponsive to treatment, was described in 1995 by Gipe and McFarland but rarely since. In our neurointensive care unit, although infrequently, we encounter refractory neurogenic vasodilatory shock without other underlying causes, unresponsive to standard treatment with IV fluids, adrenergic vasopressors, and high-dose corticosteroids. Angiotensin II, a peptide endocrine hormone, important in volume and blood pressure control, has been approved in its synthetic, intravenous form for distributive, vasodilatory shock in adult patients. It is a G-protein stimulator at vascular AT1-receptor, whose signaling leads to contraction of vascular smooth muscle and consequential vasoconstriction.

Objectives: In this contribution, we wanted to explore the rationale behind and identify possible intracerebral hemorrhage patients with neurogenic vasodilatory shock, who can benefit from an early application of angiotensin II.

Methods: We searched for all literature describing the use of angiotensin II in neurogenic vasodilatory shock. The search was carried out according to Preferred Reporting Items for Systematic Reviews and Meta-Analyses (PRISMA) criteria. It was conducted using MEDLINE (Pub Med), Embase, and Web of Science from inception through March 31st 2023. It included all studies, case reports, case series and expert opinions on use of angiotensin 2 in adult patients with neurogenic vasodilatory shock.

Results: We found no studies, articles or case reports describing the use of angiotensin II in vasodilatory neurogenic shock. In our experience, angiotensin II is useful in said patients after excluding alternate causes of shock, as the application of initial dose of angiotensin II (20 ng/kg/min) after adequate volume resuscitation, high dose noradrenaline ($> 1,0$ ug/kg/min), argipressin (0,03 IU/min) and high-dose corticosteroids, rapidly resolved profound hypotension and enabled weaning of all vasopressors within 12 h. Literature search suggests the initial surge of catecholamines in intracerebral hemorrhage, however, why this is ineffective in certain remains to be discovered. Theoretically, the laterality of injury to the insular cortex may play a role. In cases where "warm and dry" shock continues despite high concentrations of conventional vasopressors, the application of angiotensin II, whose effect is elicited through its own receptor, seems reasonable.

Conclusions: There is a need to study isolated vasodilatory shock in intracerebral hemorrhage patients, as the application of intravenous angiotensin II is promising in faster hemodynamic stabilization of such patients.

References

- Gipe B, McFarland D. Subarachnoid hemorrhage: an unusual presentation of shock. *Ann Emerg Med* 1995;26:85–89.
- Kassell NF, Torner JC, Haley EC, Jr., Jane JA, Adams HP, Kongable GL. The International Cooperative Study on the Timing of Aneurysm Surgery. Part 1: Overall management results. *J Neurosurg* 1990;73:18–36.
- Muehlschlegel S GD. Neurogenic Shock. In: Gabrielli A LA, Yu M, ed. *Civetta, Taylor, & Kirby's Critical Care*. Philadelphia: Wolters Kluwer/Lippincott Williams & Wilkins, 2009: 925–932.
- No funding was required.
- Jentzer JC, Hollenberg SM. Vasopressor and Inotrope Therapy in Cardiac Critical Care. *Journal of Intensive Care Medicine* 2020;36:843–856.
- Hasegawa Y, Uchikawa H, Kajiwara S, Morioka M. Central sympathetic nerve activation in subarachnoid hemorrhage. *J Neurochem* 2022;160:34–50.
- Forrester SJ, Booz GW, Sigmund CD, Coffman TM, Kawai T, Rizzo V, et al. Angiotensin II Signal Transduction: An Update on Mechanisms of Physiology and Pathophysiology. *Physiol Rev* 2018;98:1627–1738.
- Patel P SD, Morris DL, Kahwaji CI. Angiotensin II[online]. Available at: <https://www.ncbi.nlm.nih.gov/books/NBK499912/>.
- Wakefield BJ, Sacha GL, Khanna AK. Vasodilatory shock in the ICU and the role of angiotensin II. *Curr Opin Crit Care* 2018;24:277–285.

Topic: Neurointensive care

000792

Only 10% of elderly patients with severe pneumonia due to Sars-Cov-19 submitted to mechanical ventilation are discharged from hospital

E. De Oliveira¹, M. A. Aquino², J. M. A. D. Sousa², R. T. Athias³; M. C. S. D. Santos², M. D. M. Ventura³, E. A. D. C. Rezende⁴

¹Pulmonology, INCOR, Brazil; ²Intensive Care Unit, IAMSPE - Instituto de Assistência Médica ao Servidor Público Estadual, São Paulo, Brazil; ³Geriatric Service, IAMSPE - Instituto de Assistência Médica ao Servidor Público Estadual, São Paulo, Brazil; ⁴Chief in Charge, IAMSPE - Instituto de Assistência Médica ao Servidor Público Estadual, São Paulo, Brazil

Correspondence: M.A. Aquino

Intensive Care Medicine Experimental 2023, **11(Suppl 1)**:000792

Introduction: Advanced age is a well-known risk factor for poor prognosis in COVID-19¹. During the Sars-Cov-2 pandemic, there was a difficulty in selecting candidate patients who would benefit from intensive care because the less of intensive care unit (ICU) bed during pandemic demand. This particularity becomes very relevant when it comes to a very elderly population, ≥ 80 years old, due to the reduced life expectancy, multimorbidity, functional impairment and the fragility that can be present in this age group².

Objectives: The aims of this study was to compare mortality between octogenarian patients (age ≥ 80 years old) who were admitted to the ICU using invasive mechanical ventilation (MV) versus those who stayed on the ward receiving less invasive oxygen therapies during Sars-Cov-2 pandemic.

Methods: In this single-center study we enrolled critically ill octogenarian patients with severe pneumonia by SARS-CoV-2 who were admitted to the ICU in invasive MV (group 1) versus those received less invasive oxygen therapies (group 2) between April, 2020 and September, 2020. Primary outcome was mortality between the two groups. Secondary outcomes were defined as length of ICU and hospital stay.

A frailty screening (Katz, Pfeiffer and Modified Frailty Index) was carried out in patients ≥ 80 years old with severe pneumonia by COVID-19, so that less frailty patients were considered candidates for invasive MV and were admitted to the ICU.

Results: Were included 90 patients, 39 in group 1. The means age of the group 1 was 83.18 ± 2.79 versus 85.45 ± 6.19 , $p = 0.036$. Hypertension, Diabetes Mellitus and OCPD were equal in both groups. There was no difference between groups in the Charlson index, however the Katz index was higher in the group 1 (5.79×4.33 , $p = 0.0001$) and the Pfeiffer index was lower in the group 1. The hospital mortality rate was statistically significant very high in group 1, 92.3% (36 patients) and 33.3% in group 2, $p < 0.0001$. There was no difference between groups regarding time of hospital stay (group 1: 11.51 ± 7.018 versus 14.95 ± 13.01 , $p = 0.122$).

Conclusions: Despite patients with greater functionality and less previous frailty, mortality was higher in this group that received invasive MV at ICU, possibly because of the severity of the disease of these patients and your complications like pneumonia associated to MV.

References

- 2- Grasselli, Giacomo et al. "Risk Factors Associated With Mortality Among Patients With COVID-19 in Intensive Care Units in Lombardy, Italy." *JAMA internal medicine* vol. 180,10 (2020): 1345–1355. doi: <https://doi.org/10.1001/jamainternmed.2020.3539>
- 1- O'Driscoll M, Ribeiro Dos Santos G, Wang L, Cummings DAT, Azman AS, Paireau J, Fontanet A, Cauchemez S, Salje H. Age-specific mortality and immunity patterns of SARS-CoV-2. *Nature*. 2021 Feb;590(7844):140–145. doi: <https://doi.org/10.1038/s41586-020-2918-0>. Epub 2020 Nov 2. PMID: 33,137,809.
- Special acknowledgment to the residents whose contributes in data collection.

Topic: Acute respiratory failure and mechanical ventilation

000794

Respiratory drive and inspiratory effort in COVID-19 associated ARDS: a multicentric prospective observational study

E. Balzani¹, M. Pozzi², F. Murgolo³, P. Priani⁴, R. Di Mussi³, G. Romeo¹, U. Simonetti⁵, S. Spadaro⁶, G. Bellani⁷, S. Grasso³; V. Fanelli¹

¹Surgical Sciences Department, University of Turin, Torino, Italy; ²Department of Emergency And Intensive Care, ASST Monza, University of Milano Bicocca, Monza, Italy; ³Department of Emergency and Organ Transplant (DETO), University of Bari Aldo Moro, Bari, Italy; ⁴Medicine, University of Ferrara, Ferrara, Italy; ⁵Surgical Sciences Department, Città della Salute e della Scienza, University of Torino, Turin, Italy; ⁶Department of Morphology, Surgery And Experimental Medicine, University of Ferrara, Ferrara, Italy; ⁷Centre for Medical Sciences-CISMed, University of Trento, Trento, Italy

Correspondence: E. Balzani

Intensive Care Medicine Experimental 2023, **11(Suppl 1)**:000794

Introduction: Monitoring respiratory drive and effort can be useful in critically ill patients under spontaneous assisted breathing to prevent respiratory muscle atrophy and patient self induced lung injury. Acute respiratory distress syndrome (ARDS) commonly causes increased respiratory drive and effort. In COVID-19 related ARDS (CARDS), respiratory drive and effort may be even higher, leading to relapse of acute respiratory failure and worse outcomes (1). Therefore, further research comparing CARDS and ARDS patients is needed to highlight differences in respiratory drive and effort and their impact on clinical outcomes.

Objectives: The first aim was to investigate the changes in respiratory drive and effort using neurally-adjusted ventilatory assist (NAVA) catheters in CARDS patients compared to ARDS patients. The second aim was to evaluate the incidence of the composite outcome of a transition from light to deep sedation (Richmond Agitation-Sedation Scale, RASS from 0/-2 to -4/-5) or from assisted to controlled ventilation within 48 h from spontaneous assisted breathing.

Methods: This multicenter study was conducted in four ICUs in Italy and prospectively recruited patients with CARDS, comparing them to a historical cohort of patients with ARDS. All patients who transitioned from controlled ventilation to assisted ventilation and had a RASS level of 0/-2 were included. The CARDS cohort was divided into 'mild' and 'severe' COVID-19 groups according to P/F ratio at ICU admission (2). Respiratory mechanics variables were recorded for 90 consecutive breaths and 2 end-expiratory occlusions were performed to measure Pmusc/Eadi index (PEI). The study protocol included the assessment of respiratory drive using P0.1vent, and respiratory effort using NAVA catheter (Δ Edi, PmusEdi) (3). Inspiratory pressures in pressure support mode were kept at 10 cmH2O for all patients.

Results: We enrolled 55 patients (10 severe-COVID19, 7 mild-COVID19, and 38 non-COVID19 patients) and analyzed a total of 4301 breaths. Baseline characteristics were reported in Table 1. P0.1vent was significantly different between the three groups (Figure 1). Respiratory effort (Δ Edi, PmusEdi) was markedly different between severe-COVID19 and the other two groups (Figure 1). Within the cohort of severe-COVID19 patients, 70% underwent a transition from assisted to controlled ventilation or from a RASS score of 0/-2 to -4/-5. None of the patients in the mild-COVID19 cohort required such a transition, while 2.6% of the non-COVID-19 cohort experienced this shift.

Conclusions: In severe-COVID19 patients, respiratory drive and effort are markedly altered. Our findings highlight significant differences in clinical outcomes, ventilation duration, ICU mortality, and ICU length of stay among patients with severe CARDS. These results suggest that greater caution should be exercised in implementing spontaneous mechanical ventilation strategies in CARDS patients.

Patient characteristics at baseline, treatments, and outcomes. values are median [interquartile range]	Non-COVID (N=38)	COVID mild (N=7)	COVID severe (N=10)
Age (years)	58 [51-70]	57 [55-63]	52 [50-63]*
BMI	27.7 [24.3-31.1]	28.1 [26.0-29.4]	29.1 [26.3-32.0]
Gender (M/F)	24/14	5/2*	9/1*
SAPS II score	37.50 [31.3-43.8]	30.00 [26.00-36.00]	36.00 [27.00-58.00]
P/F ratio at ICU admission	169.0 [106.2-228.8]	177.5 [156.6-210.6]	89.0 [73.0-128.6] **
PaO ₂ at ICU admission (mmHg)	106.00 [89.25-155.25]	204.00 [135.00-251.50]*	76.00 [73.00-89.00] **
Minute ventilation at ICU admission (ml/min)	8.2 [7.0-10.1]	8.0 [7.4-8.5]	7.5 [3.3-10.0]
PEEP at ICU admission (cmH ₂ O)	11.00 [8.00-16.00]	17.00 [16.00-18.00]*	10.00 [10.00-10.00]*
P _{aw} at ICU admission (cmH ₂ O)	24.5 [15.2-30.0]	31.0 [29.5-32.0]*	25.0 [20.0-27.0]*
Respiratory system compliance at ICU admission (ml/cmH ₂ O)	42.82 [32.33-65.33]	32.00 [28.35-39.86]	28.23 [21.11-52.50]
Propofol before measurement (days)	3.00 [2.00-5.00]	5.00 [5.00-9.00]*	10.00 [5.00-20.00]*
Overall mechanical ventilation duration (days)	9 [5-11]	12 [9-14]	25 [12-53]*
ICU mortality, N(%)	2 (8.7)	0 (0)*	2 (20) **
Switch from RASS -2 to RASS -4 or from assisted to controlled ventilation, N (%)	1 (2.6)	0 (0)*	7 (70) **
ICU length of stay (days)	12 [7-14]	14 [11-17]	40 [14-54]*

* Non-COVID vs COVID mild and COVID severe; # COVID severe vs COVID mild. Abbreviations: BMI: body mass index; ICU: intensive care unit; SAPS II: Simplified Acute Physiology Score; PEEP: positive end expiratory pressure; RASS: Richmond Agitation-Sedation Scale.

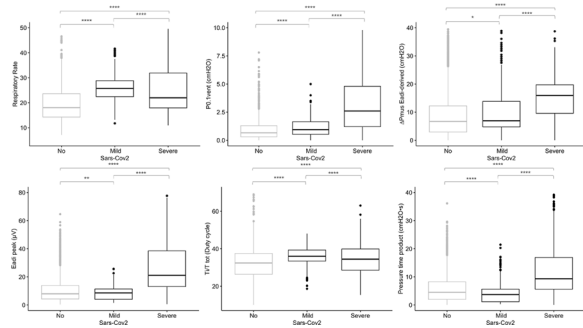

Figure 1 (abstract 000794) Respiratory drive and inspiratory effort among three groups of ARDS patients. Wilcoxonrank sum test and Dunn’s multiple comparison test were used, the respective p-value were performed between COVID-related groups (reference group: non-COVID19) (Signif. codes: 0 ‘****’ 0.001 ‘***’ 0.01 ‘**’ 0.05 ‘*’ 0.1 ‘ns’ 1)

References

1. Esnault P, Cardinale M, Hraiech S, Goutorbe P, Baumstrack K, Prud’homme E, Bordes J, Forel JM, Meaudre E, Papazian L, Guervilly C: High Respiratory Drive and Excessive Respiratory Efforts Predict Relapse of Respiratory Failure in Critically Ill Patients with COVID-19. *Am J Respir Crit Care Med* 2020; 202: 1173–1178
2. Xie J, Covassin N, Fan Z, Singh P, Gao W, Li G, Kara T, Somers VK: Association Between Hypoxemia and Mortality in Patients With COVID-19. *Mayo Clin Proc* 2020; 95: 1138–1147
3. Bellani G, Mauri T, Coppadoro A, Grasselli G, Patroniti N, Spadaro S, Sala V, Foti G, Pesenti A: Estimation of patient’s inspiratory effort from the electrical activity of the diaphragm. *Crit Care Med* 2013; 41: 1483–91

Topic: Acute respiratory failure and mechanical ventilation

000796

Causes for non-completion of organ donation in patients with brain death at the Municipal Hospital Djalma Marques, in São Luís-MA
 H. Sousa Bastos¹, P. Costa Bortolon Melo², GA. Lisboa Oliveira², V. Freire Pereira², V. Freitas Neto², AM. Clayton², MN. Caroline², SS. Luciana², P. De Carvalho Bacelar²

¹Intensive Care, Hospital São Domingos, São Luís, Brazil; ²Intensive Care, Hospital Municipal Djalma Marques, São Luís, Brazil

Correspondence: H. Sousa Bastos

Intensive Care Medicine Experimental 2023, **11(Suppl 1)**:000796

Introduction: Family refusal to donate organs is a serious problem against the improvement of transplant rates in the country. The causes are diverse and are intrinsically linked to the socio-cultural context.

Objectives: The objective is to investigate the profile of potential organ donors and identify the main causes of non-donation of organs in a public hospital in the capital of Maranhão.

Methods: It consists of a retrospective observational study, involving 40 patients admitted to an adult intensive care unit at a tertiary public hospital in São Luís-MA, between January 2022 and July 2022, with confirmed brain death. Data collection was performed by analysis of medical records and data were stored in a Microsoft Excel spreadsheet, with analysis performed in the computer program IBM SPSS Statistics v.20.0. Armonk, NY: IBM Corp.

Results: Of the 40 patients analyzed, 20 reached the end of the brain death diagnostic process. Of these, most are male (55%) and aged between 18 and 45 years (65%). Family refusal occurred in 55% of cases (11). Among the reasons for refusal in the interview, the desire not to donate the potential donor in life presented 45.5%, followed by 27.3% for the desire to have a healthy body and 27.2% did not want to wait for the logistics of the process. Among the reasons for not having been interviewed, it was observed that 35% occurred due to cardiorespiratory arrest before the conclusion of the protocol, followed by refractory sepsis with 30%, contraindicative organ failure with 25% and positive contraindicative serologies in 10%.

Conclusions: There are several causes of family refusal, requiring education strategies to encourage the population to discuss in society about organ donation and the social impact that this attitude carries, in addition to optimizing the maintenance of the potential donor to reduce the number of interviews not carried out. Bring a protocolised process for approaching the families in PD-generating hospitals, with education of doctors, other healthcare professionals and the society is a possible key to overcoming the fear related to the donation of organs and tissues.

References

1. P. Gómez, C. Santiago, A. Getino, A. Moñino, M. Richart, J. Cabrero. The family interview: training in communication techniques. *Nefrología*, 21 (2001), pp. 57–64
2. Molina MI, Toro PA, Manzi E, Dávalos D, Torres K, Aristizábal AM, Gómez C, Echeverri GJ. Main causes of family refusal to organ and tissue donation: 10 years of experience in a latin american center. *Nefrología (Engl Ed)*. 2018 Mar-Apr;38(2):225–227. English, Spanish. doi: <https://doi.org/10.1016/j.nefro.2017.05.004>. PMID: 29,402,459.
3. Organización Nacional de Trasplantes. Programa de Garantía de Calidad del Proceso de Donación. Evolutivo de Resultados de la Autoevaluación 1998–2013. Available from: http://www.ont.es/infesp/DocumentosCalidad/Memoria%20PGC_2013_completa.pdf [accessed 23.01.17].
4. A.L. Simpkin, L.C. Robertson, V.S. Barber, J.D. Young. Modifiable factors influencing relatives’ decision to offer organ donation: systematic review. *BMJ*, 338 (2009), pp. b991

Topic: Brain death, organ donation and transplantation

000797

Characterization of the neurophysiologic differences between phenotypes of traumatic brain injury: an historical cohort study

E. Chow¹, E. Yang¹, E. Ursu¹, R. Hoiland¹, M. Sekhon², D. Griesdale¹
¹Department of Anaesthesiology, Pharmacology and Therapeutics, The University of British Columbia, Vancouver, Canada; ²Medicine, The University of British Columbia, Vancouver, Canada

Correspondence: D. Griesdale

Intensive Care Medicine Experimental 2023, **11(Suppl 1)**:000797

Introduction: Traumatic brain injury is characterized by different pathoanatomic patterns of injury, which include diffuse axonal injury and other phenotypes (contusions, extra-axial collections, and subarachnoid and intraventricular hemorrhage). Although radiographically delineated, the physiologic responses to injury have not previously been characterized. The purpose of this project was to compared

patients with either isolated DAI, mixed DAI (DAI and other pattern of injury) and non-DAI with respect to intracranial pressure (ICP), mean arterial pressure (MAP), and brain tissue oxygenation PbtO₂. In addition, we sought to characterize the response of PbtO₂ to MAP in the three groups.

Methods: This was a single-centre historical cohort study of patients admitted to the ICU at Vancouver General Hospital with a diagnosis of TBI and who underwent invasive multimodal neuromonitoring between September 2014 to November 2022. Admission computed tomography (CT) scans of the head were used to determine following pathoanatomic patterns: isolated DAI (petechial or intraventricular hemorrhage), non-DAI (epidural or subdural hematoma, contusion, and traumatic subarachnoid hemorrhage), or mixed DAI (DAI and one of a non-DAI phenotype). ICP, MAP and PbtO₂ were collected using ICM + Brain Monitoring Software (Cambridge UK). We fitted a linear mixed model (specifying “patient” as a random effect) to estimate the average profiles of PbtO₂, ICP and MAP over time. We used a restricted cubic-splines model to plot the non-linear relationship between PbtO₂ and MAP.

Results: There were a total of 72 patients included in the cohort with the following phenotypes of injury: 22 (31%) with isolated-DAI, 21 (29%) with mixed-DAI, and 29 (40%) with no-DAI. The mean (standard deviation [SD]) of the cohort was 36 (15) years, and 56 (78%) were male. The most frequent etiologies of the TBI were motor vehicular collisions in 28 (40%) and falls in 18 (26%). The median (interquartile interval [IQ]) admission Glasgow Coma Scale Motor was 3 [1–4]. The median duration of invasive monitoring was 4 [2.0–5.5] days. Overall, 16 of 72 (22%) of patients died in hospital, which was highest amongst those who sustained a mixed-DAI phenotype of injury (7 of 21 [33%]). The trajectories of MAP, ICP and PbtO₂ over time are shown in the figure. During the monitoring period, the mean ICP was lower for patients with an isolated-DAI (13 [5]) compared to those with either mixed-DAI (17 [11]) or no-DAI (17 [9]) (P=0.048). There was no difference in either MAP or PbtO₂ comparing the three phenotypes. MAP increased over time in all phenotypes. Overall, 16 of 72 (22%) of patients died in hospital, which was highest amongst those who sustained a mixed-DAI phenotype of injury (7 of 21 [33%]). Finally, there was a non-linear increase in PbtO₂ as MAP increases in all three phenotypes.

Conclusions: Irrespective of phenotype of injury, all patients had similar trajectories of MAP and PbtO₂ over time. ICP was lower in those patients with an isolated-DAI. Our next steps will include 1) examining indices of autoregulation, and 2) comparing therapeutic interventions (e.g., use of hypertonic saline) amongst the three phenotypes of injury.

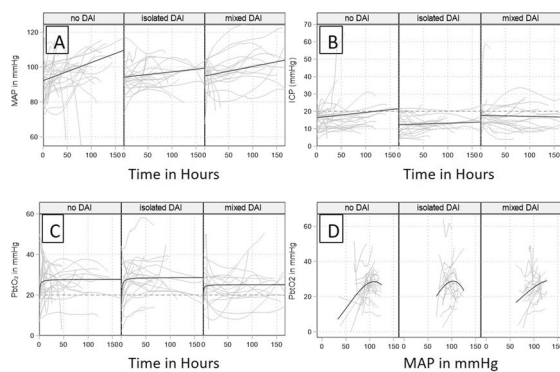

Panels A – C are mean arterial pressure (MAP), intracranial pressure (ICP) and brain tissue oxygen (PbtO₂) are plotted over time. Individual patient Locally Weighted Scatterplot Smoothing (LOWES) plots are shown in light grey. The predicted probabilities are shown in the dark grey line. Panel D shows the non-linear relationship between PbtO₂ and MAP.

References

1. JAMA Neurol. 2021 Sep; 78(9): 1–12.
2. DEG & MS are supported through Michael Smith Health Research BC Health Professional Investigator Award.

Topic: Neurointensive care

000799

Tracheostomy in critically ill patients. Factors related to mortality

M. Salgado¹, A. Alonso¹, M. Cózar¹, A. Alvarez¹, A. Ubeda¹

¹Intensive Care Unit, Hospital Punta de Europa, Algeciras, Spain

Correspondence: A. Ubeda

Intensive Care Medicine Experimental 2023, 11(Suppl 1):000799

Introduction: Tracheostomy is a frequent alternative in patients who require prolonged mechanical ventilation in the ICU. Early tracheostomy has been demonstrated to reduce the duration of mechanical ventilation and length of stay. However, its association with mortality remains ambiguous.

Objectives: To analyze the characteristics of tracheostomized patients during their admission in a intensive care unit (ICU) in Punta Europa Hospital, as also analyze the factors related to mortality in our ICU.

Methods: Retrospective descriptive analysis was performed using a prospective cohort obtained from a 15-beds ICU collected between 2019 and 2022. 2 groups were compared: tracheostomized patients vs. no tracheostomized patients. Demographic variables, comorbidities, prognosis scores (APACHE II and SAPS II), risk factors, microorganism isolated, ICU and hospital length of stay (LOS), antimicrobial therapy used and mortality were collected. Statistical analysis: continuous variables (mean and standard deviation or median and inter-quartile range), categorical variables (percentages and frequencies). Comparison: Chi-square test (percentages) and T-student test (mean) or Wilcoxon-test (median). Multiple logistic regression. Statistical significance was set at p-value < 0.05.

Results: 1470 patients were included. Non-tracheostomized (n = 1388) vs. tracheostomized (n = 82). Age (63.33 [± 15.51] vs. 62.39 [± 12.81], p < 0.001). Covid-19 (1% vs 34%, p < 0.001). Origin (p < 0.001): community (58.3% vs. 23.3%), ward (38.6% vs. 62.2%), other ICU (3% vs. 14.6%). SAPS II (28 [19;43] vs. 33 [27.2;48.7], p < 0.001), APACHE II (11 [6;17] vs. 14 [9.25;19], p < 0.001), GCS on admission (15 [13;15] vs. 15 [7;15], p < 0.001). Comorbidities: neoplasia (15.5% vs. 25.6%, p = 0.024). Risk factors: Previous ATB (28% vs. 58.5%, p < 0.001), urgent surgery (14.3% vs. 43.9%, p < 0.001), central venous catheter (CVC) (59.2% vs. 96.3%, p < 0.001), mechanical ventilation (MV) (38.8% vs. 91.4%, p < 0.001), urinary catheter (UC) (69.8% vs. 98.7%, p < 0.001). ICU LOS (days) (3 [2;6] vs. 29 [12.2;40.7], p < 0.001) and hospital LOS (days) (9 [5;18] vs. 50 [27.5;60.7], p < 0.001). Days of MV (0 [0;2] vs. 22 [10;33], p < 0.001). Mortality (27.7% vs. 58%, p < 0.001).

Survivors (n = 34) and dead (n = 48) were compared: Age (57.3 [± 14.2] vs. 66 [± 10.4], p < 0.001). GCS on admission (9 [3;15] vs. 15 [9;15], p = 0.021). Comorbidities: neoplasia (41% vs. 14.5%, p = 0.009). First ICU-acquired infection (p < 0.032): secondary bacteremia (0% vs. 24.4%), Catheter-related bloodstream infection (CRBSI) (17.8% vs. 20%), Ventilator-associated pneumonia (VAP) (32.1% vs. 13.3%), Catheter-associated urinary tract infections (CAUTI) (7.1% vs. 6.6%). Hospital LOS (days) (59.5 [51.2;82.7] vs. 37.5 [19;51.2], < 0.001). Multivariate analysis (mortality): Age (OR 1,08 [IC 95% 1.04–1.14], p < 0.001), neoplasia (OR 0.12 [IC 95% 0.03–0.41], p < 0.001).

Conclusions: Mortality in tracheostomized patients in ICU is high. Age was a mortality independent predictor, while neoplasia as comorbidity was a protective factor.

Topic: Acute respiratory failure and mechanical ventilation

000801

Impact of a 48-h surveillance protocol on readmission rates of patients transferred from the intensive care unit to the general ward: A retrospective cohort study

J. Lee¹, C. Im²

¹Department of Surgery, ASAN Medical Center, Seoul, Republic of Korea;

²Department of Surgery, Seoul National University Bundang Hospital, Seongnam-si, Republic of Korea

Correspondence: J. Lee

Intensive Care Medicine Experimental 2023, 11(Suppl 1):000801

Introduction: Patients who are transferred from the intensive care unit (ICU) to the general ward are at high risk of complications and readmission to the ICU. There is a need to identify effective strategies to reduce readmission rates and improve patient outcomes.

Objectives: To investigate the impact of a 48-h monitoring protocol on the readmission rates of patients transferred from the ICU to the general ward.

Methods: We conducted a retrospective cohort study of adult patients who were transferred from the ICU to the general ward in a single large academic medical center between January 2020 and September 2021. Data of patients who were monitored for 48 h after transfer to the general ward were collected prospectively. We compared the readmission rates of patients who received 48-h monitoring with those who did not.

Results: A total of 286 patients were included in the study, of whom 102 received 48-h monitoring and 184 did not. The readmission rate in the 48-h monitoring group was 1%, compared to 6% in the group that did not receive 48-h monitoring ($p=0.028$). After adjusting for confounding factors, the odds of readmission were 35% lower in the 48-h monitoring group (OR 0.65, 95% CI 0.48–0.87). There were no statistically significant differences in medical history, demographics or clinical characteristics.

Conclusions: Our study suggests that a 48-h surveillance protocol may be effective in reducing the readmission rates of patients transferred from the ICU to the general ward. Further prospective studies are needed to confirm these findings and evaluate the cost-effectiveness of this approach.

References

- Ball C. Ensuring a successful discharge from intensive care. *Intensive Crit Care Nurs.* 2005 Feb;21(1):1–4.
- Jung YJ, Kim Y, Kyoung K, Keum M, Kim T, Ma DS, Hong SK. The Effect of Systematic Approach to Tracheostomy Care in Patients Transferred from the Surgical Intensive Care Unit to General Ward. *Acute Crit Care.* 2018 Nov;33(4):252–259.
- Rosenberg AL, Watts C. Patients readmitted to ICUs*: a systematic review of risk factors and outcomes. *Chest.* 2000;118:492–502.
- Franklin C, Jackson D. Discharge decision-making in a medical ICU: characteristics of unexpected readmissions. *Crit Care Med.* 1983;11(2):61–6.
- Kaben A, Corrêa F, Reinhart K, Settmacher U, Gummert J, Kalff R, et al. Readmission to a surgical intensive care unit: incidence, outcome and risk factors. *Crit Care.* 2008;12(5):R123.
- Alban RF, Nisim AA, Ho J, Nishi GK, Shabot MM. Readmission to surgical intensive care increases severity-adjusted patient mortality. *J Trauma: Injury, Infection, and Critical Care.* 2006;60(5):1027–31.
- Durbin CG, Kopel RF. A case–control study of patients readmitted to the intensive care unit. *Crit Care Med.* 1993;21:1547–53.
- Russell S. Continuity of care after discharge from ICU. *Prof Nurse.* 2000 May;15(8):497–500.
- Cooper GS, Sirio CA, Rotondi AJ, Shepardson LB, Rosenthal GE. Are readmissions to the intensive care unit a useful measure of hospital performance? *Med Care.* 1999;37:399–408.

Topic: Critical care organisation, quality management, information systems, outcomes

000802

Non-theatre emergency airway management in the paediatric population: a prospective observational study of technique and adverse events across eight acute hospitals in the South East of England

J. Gibson¹, T. Leckie², B. Hardy², S. Tun³, L. Hodgson²

¹Department of Intensive Care Medicine, East Surrey Hospital, Redhill, United Kingdom; ²Department of Intensive Care Medicine, Worthing Hospital, Worthing, United Kingdom; ³Department of Intensive Care Medicine, Royal Sussex County Hospital, Brighton, United Kingdom

Correspondence: J. Gibson

Intensive Care Medicine Experimental 2023, **11(Suppl 1)**:000802

Introduction: Airway management in the paediatric population is known to be challenging [1] with a high rate of adverse events [2]. Whilst gaps exist in optimal management even in tertiary centres [3],

adverse events are more common outside of the tertiary setting [2]. Ways to mitigate adverse events are better evidenced in the adult population, however large bodies of work have provided recommendations for paediatric intubation [1] including the use of capnography and videolaryngoscopy.

Objectives: This study aimed to establish the incidence of adverse events during tracheal intubation of the paediatric patient in the non-theatre setting, and how clinical practice compared with existing recommendations.

Methods: Data relating to any emergency tracheal intubation outside of the theatre environment in children (< 18 years) was recorded on a secure electronic case report form across eight acute NHS hospital sites in the South East of England. Data was collected continuously over six weeks. The project was reviewed by the lead site research department and classified as a service evaluation project, with subsequent local review and adoption at each site. One participating centre included a tertiary children's hospital, whilst the remaining seven were district general hospitals. Data gathered included the age, airway technique and adverse events. Cases managed by dedicated neonatal teams were excluded.

Results: A total of 46 tracheal intubations were recorded, 26 of which were in children aged under 2 years, with six cases in children aged 2 to 5 years and 14 cases in children aged 6 to 17 years. Capnography use was universal across all events. Videolaryngoscopy was used first line for tracheal intubation in 42% of those under 2 years old, 66% in 2 to 5 year olds and in 50% of those aged 6 years and over. Within these age categories, videolaryngoscopy was available for 88%, 100% and 86% of events. Overall, first-pass success of tracheal intubation was 76%, falling to 62% in those under 2 years. In this youngest age group, adverse events included SpO₂ < 80% in 31%, ≥ 3 attempts at intubation in 19% and oesophageal intubation in 8% of cases. One of these was not immediately detected.

Conclusions: Emergency tracheal intubation outside of the theatre environment was common. Those aged under 2 years disproportionately represented the workload. This subset encountered adverse events most frequently, in-keeping with existing literature [2]. The complete use of capnography meets current recommendations during tracheal intubation of the child. However, despite high availability, subsequent use of videolaryngoscopy is markedly less. This may be a factor as to why adverse events were high in those aged under 2 years. Further work should explore reasons for lower rates of videolaryngoscopy within this patient population, with consideration of whether the improved safety profile of videolaryngoscopy observed in adults is also present in the paediatric population.

References

- Cook TM, Woodall N, Harper J, Benger J, Fourth National Audit Project. Major complications of airway management in the UK: results of the Fourth National Audit Project of the Royal College of Anaesthetists and the Difficult Airway Society. Part 2: intensive care and emergency departments. *British Journal of Anaesthesia* 2011; 106: 632–42.
- Matetore A, Ramnarayan P, Jones A, Randle E, Lutman D, O'Connor M et al. Adverse Tracheal Intubation-Associated Events in Pediatric Patients at Nonspecialist Centers: A Multicenter Prospective Observational Study. *Pediatric Critical Care Medicine* 2019; 20(6): 518–26.
- Foy KE, Mew E, Cook TM, Bower J, Knight P, Dean S et al. Paediatric intensive care and neonatal intensive care airway management in the United Kingdom: the PIC-NIC survey. *Anaesthesia* 2018; 73: 1337–44.
- Nil to declare.

Topic: Trauma

000803

Effects of combining mild hypothermia to barbiturate therapy for treatment of increased intracranial hypertension in acute brain injury patients

H. Kim¹, YH. Choo², J. Kim³, Y. Shim⁴, E. Ha⁵

¹Department of Neurosurgery, The Catholic University of Korea Incheon St. Mary's Hospital, Incheon, Republic of Korea; ²Department

of neurosurgery, The Catholic University of Korea Seoul St. Mary's Hospital, Seoul, Republic of Korea; ³Department of Traumatology, Gachon University Gil Medical Center, Incheon, Republic of Korea; ⁴Department of Critical Care, Kangbuk Samsung Hospital, Samsung Medical Center, Seoul, Republic of Korea; ⁵Department of Critical Care, Seoul National University Hospital, Seoul, Republic of Korea

Correspondence: H. Kim

Intensive Care Medicine Experimental 2023, **11(Suppl 1)**:000803

Introduction: Acute brain injury can lead to increased intracranial pressure (ICP), which can cause secondary ischemic insult. Conventional (or first-tier) treatments of increased ICP include proper sedation and pain control, hyperosmolar agents, such as mannitol or hypertonic saline, hyperventilation and CSF drainage. If unresponsive to these methods, second-tier treatments such as decompressive craniectomy, barbiturate infusion and/or mild hypothermia are considered. Barbiturate infusion is effective in reducing ICP but its notorious side effects make it less favorable. Mild hypothermia (body temperature of 32–35 degree C) is relatively safe treatment but its efficacy as a monotherapy in acute brain injury is not clear. Combining barbiturate and mild hypothermia may be synergic in reducing ICP.

Methods: This was a retrospective review of patients admitted at Seoul National University Hospital from 2012 to 2021 with acute brain injury. Patients who had raised ICP despite the conventional treatments underwent unilateral decompressive craniectomy. If ICP was elevated (> 10 mmHg) even after decompressive craniectomy, either thiopental infusion or thiopental infusion and mild hypothermia were started. Primary endpoints included mortality, modified Rankin scores (mRS) at 3 and 6 months. Secondary endpoints included improvement in ICP, complications, length of intensive care unit (ICU) stay, length of hospital stay.

Results: A total of 51 patients with acute brain injury were enrolled (23 in thiopental only group, 28 in thiopental and mild hypothermia group). The mortality was 6% in thiopental only group, 11% in the other group. There was no statistically significant differences in 3- and 6-month mRS.

The initial ICP prior to thiopental /hypothermia was similar between the two groups (11.0 ± 11.6 vs 16.6 ± 9.6 , p-value 0.066) and there was no statistically significant differences in mean ICP during the first 48 h of treatment. After discontinuation of thiopental infusion, ICP remained similar between the groups for the next 48 h.

Body temperature was significantly low in thiopental and mild hypothermia group (36.9 ± 1.2 vs 35.0 ± 1.4 , $p < 0.001$) with higher incidence of fever after discontinuation of thiopental infusion ($BT > 37.8^\circ\text{C}$) in thiopental only group (39.1% vs 3.6%, p-value 0.003).

The duration of thiopental infusion was longer in thiopental only group (7130.4 ± 4164.6 min vs. 4073.3 ± 1918.0 min, p-value 0.003) but there was no statistically significant differences in vasoactive-inotropic score (VIS), incidence of pneumonia, incidence of deep vein thrombosis or pulmonary thromboembolism, length of ICU stay and length of hospital stay.

Conclusions: Combining mild hypothermia to thiopental infusion in patients with increased ICP, despite medical and surgical treatment, had no additional effects on neurological outcomes.

References

3. Majdan M, et al. Barbiturates use and its effects in patients with severe traumatic brain injury in five European countries. *J Neurotrauma*. 2013 Jan 1;30(1):23–9. doi: <https://doi.org/10.1089/neu.2012.2554>. Epub 2012 Dec 6
2. Hawryluk, G.W.J., Aguilera, S., Buki, A. et al. A management algorithm for patients with intracranial pressure monitoring: the Seattle International Severe Traumatic Brain Injury Consensus Conference (SIBICC). *Intensive Care Med* 45, 1783–1794 (2019). doi: <https://doi.org/10.1007/s00134-019-05805-9>
1. Kinoshita, K. Traumatic brain injury: pathophysiology for neurocritical care. *J intensive care* 4, 29 (2016). doi: <https://doi.org/10.1186/s40560-016-0138-3>
4. Hui J et al.; LTH-1 Trial collaborators. Safety and efficacy of long-term mild hypothermia for severe traumatic brain injury with refractory

intracranial hypertension (LTH-1): A multicenter randomized controlled trial. *EClinicalMedicine*. 2021 Jan 28;32:100,732. doi: <https://doi.org/10.1016/j.eclim.2021.100732>.

Topic: Neurointensive care

000805

Elastance-derived plateau transpulmonary pressure and association with barotrauma in COVID-19 ARDS

S. Koba¹, J. Kataoka¹, Y. Igarashi², S. Fujitani²

¹Department of Critical Care Medicine, Nerima Hikarigaoka Hospital, Nerima City, Japan; ²Department of Emergency And Critical Care Medicine, St. Marianna University School of Medicine, Kawasaki, Japan

Correspondence: S. Koba

Intensive Care Medicine Experimental 2023, **11(Suppl 1)**:000805

Introduction: Although a higher PEEP is recommended in patients with ARDS to prevent collapse and atelectrauma, an excessively high PEEP may cause overdistention of nondependent lung and barotrauma.

Methods: Retrospective cohort study on data derived two ICUs in Japan. In this study, we retrospectively collected cases of mechanically ventilated COVID-19 ARDS (CARDS) patients with transpulmonary pressure-guided PEEP setting and investigated whether lung mechanics measured early after intubation, including transpulmonary pressure (PL) derived esophageal pressure (Pes) and elastance-derived plateau PL, are associated with barotrauma.

Results: Fifty-six patients were investigated. The PEEP setting guided by the end-expiratory PL was 14 cmH₂O (12–15), the end-inspiratory PL derived Pes was 13 cmH₂O (11–14) and ΔPL was 11 cmH₂O (10–12). Barotrauma occurred in 8 patients (14%), and among respiratory mechanics, PaO₂/FiO₂ ratio, setting PEEP, plateau pressure, driving pressure, end-inspiratory PL derived Pes and ΔPL were not associated with barotrauma, but higher elastance-derived plateau PL was associated with the development of barotrauma (21 cmH₂O vs. 24 cmH₂O, $p = 0.041$).

Conclusions: The end-inspiratory PL derived Pes were not associated with barotrauma, and monitoring elastance-derived plateau PL may be necessary to prevent barotrauma.

Topic: Acute respiratory failure and mechanical ventilation

000806

Therapeutic removal of cfDNA/NETs using NucleoCapture[®] apheresis in a porcine intensive care sepsis model: a blinded randomised controlled trial

A. Aswani¹, D. Genkin², K. Surkov², P. Skorup³, R. Varsebrouc⁴, M.

Wargnies⁴, J. Candiracci⁴, M. Herzog⁴, J. Micallef⁴, M. Lipcsey⁵

¹Dept of Intensive Care Medicine, Guy's and St Thomas' NHS Foundation Trust, London, United Kingdom; ²Therapeutic apheresis, Santerus AG, Zürich, Switzerland; ³Section Of Infectious Diseases, Department Of Medical sciences, Uppsala University, Uppsala, Sweden; ⁴R&D, Belgian Volition SRL, Isnes, Belgium; ⁵Surgical Sciences, Uppsala University, Uppsala, Sweden

Correspondence: A. Aswani

Intensive Care Medicine Experimental 2023, **11(Suppl 1)**:000806

Introduction: Cell-free DNA (cfDNA)/Neutrophil Extracellular Traps (NETs) are associated with sepsis. We investigated the selective removal of cfDNA/NETs from the circulation in a porcine intensive care model of sepsis using NucleoCapture[®] apheresis in a blinded randomised controlled trial. The NucleoCapture[®] column contains sorbent beads coated with linker histone H1.3 which selectively bind to cfDNA/NETs.

Methods: We induced sepsis in 18 pigs with a 3-h intravenous infusion of E. coli. Nine pigs were randomly allocated to treatment with NucleoCapture[®] selective apheresis for 5 h. Nine pigs were subjected to apheresis with a sham column. The column was used in conjunction

with the Terumo Optia system using regional citrate anticoagulation. The operators were blinded to the column type. We measured cfDNA/NETs using the NuQ H3.1 and H3R8cit nucleosome assays (Volition).

Results: A single pass of septic plasma through the NucleoCapture® column resulted in near complete removal (96–99.1%) of cfDNA/NETs.

There was no evidence of non-specific direct adsorption of proteins such as albumin and cytokines.

The baseline levels of circulating cfDNA/NETs measured in the NucleoCapture® and sham treated pigs prior to the experiment were 11.6 (±4.1) ng/ml and 10.2 (±3.5) ng/ml (mean ±SD), respectively. Infusion of E. coli. resulted in an increase in cfDNA/NETs levels to 68.6 (±24.5) ng/ml and 71 (±53.1) ng/ml, respectively.

The level of cfDNA/NETs in the sham treated pigs rose continuously during the experiment reaching 361.2 (±190.2) ng/ml (Figure 1). In contrast, NucleoCapture® treatment prevented a continuous rise in cfDNA/NETs with levels plateauing at 149.9 (±152.98) ng/ml (p < 0.05). The low cfDNA/NETs levels in the NucleoCapture® treated pigs were consistent with the attenuation of septic shock as evidenced by reduced total norepinephrine required (1,172 (±1,832) µg vs 6,360 (±5,017) µg, p < 0.05, Figure 2), reduced lactate (4.6 vs 6.9 mmol/l, p < 0.05, Figure 3) and improved survival (9/9 vs 7/9). There was also a twofold increase in urine output in the NucleoCapture® group.

No technical difficulties with the use of the NucleoCapture® column or any problems with anticoagulation were found.

Conclusions: In this blinded randomised controlled study, selective cfDNA/NETs apheresis with NucleoCapture® safely and effectively removed cfDNA/NETs from the circulation of septic pigs, resulting in improved organ function and survival. We aim to progress the investigation of NucleoCapture® to clinical trials in sepsis and other indications.

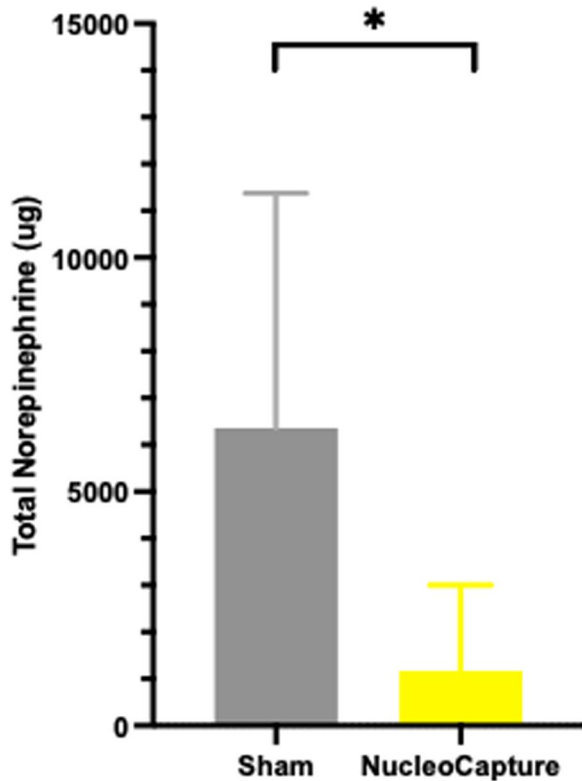

Figure 2 (abstract 000806) NucleoCapture attenuates cardiovascular septic shock. Total norepinephrine dose administered per animal, mean (SD) values shown, * denotes p < 0.05

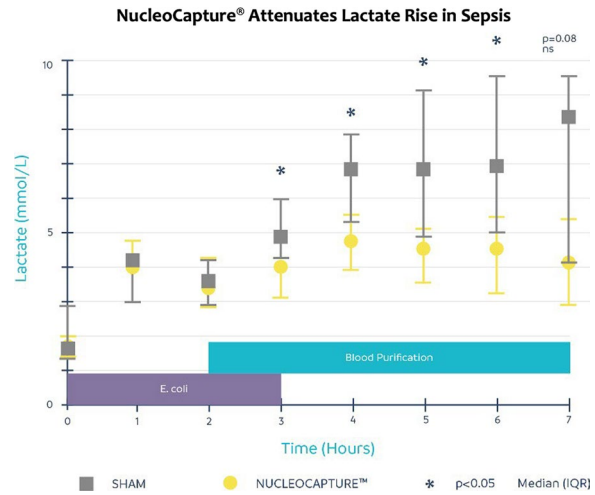

Figure 3 (abstract 000806) NucleoCapture attenuates lactate rise in sepsis. Median (IQR) values shown, * denotes p < 0.05

NucleoCapture® removes cfDNA/NETs from blood

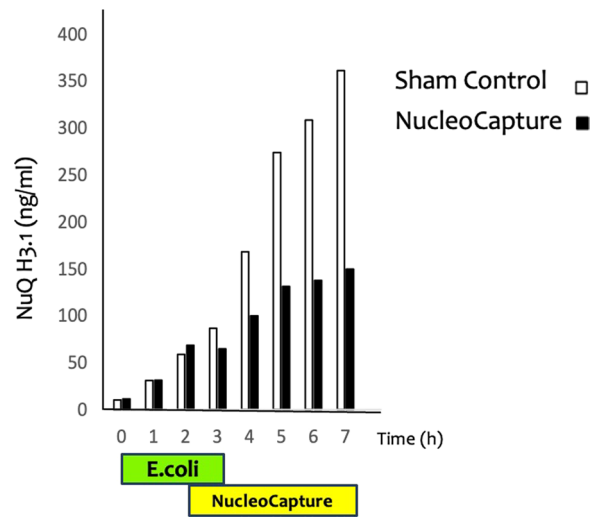

Figure 1 (abstract 000806) NucleoCapture removes cfDNA/NETs from blood in sepsis. NuQ H3.1 ELISA used, mean concentrations shown

References

- Nofi, C.P., Wang, P., and Aziz, M. (2022). Chromatin-Associated Molecular Patterns (CAMPs) in sepsis. *Cell Death Dis* 13, 700. <https://doi.org/10.1038/s41419-022-05155-3>
- McDonald, B., Davis, R.P., Kim, S.-J., Tse, M., Esmon, C.T., Kolaczowska, E., and Jenne, C.N. (2017). Platelets and neutrophil extracellular traps collaborate to promote intravascular coagulation during sepsis in mice. *Blood* 129, 1357–1367. <https://doi.org/10.1182/blood-2016-09-741298>
- Singh, J., Boettcher, M., Dölling, M., Heuer, A., Hohberger, B., Leppkes, M., Naschberger, E., Schapher, M., Schauer, C., Schoen, J., et al. (2023). Moonlighting chromatin: when DNA escapes nuclear control. *Cell Death Differ*, 1–15. <https://doi.org/10.1038/s41418-023-01124-1>
- Clark, S.R., Ma, A.C., Tavener, S.A., McDonald, B., Goodarzi, Z., Kelly, M.M., Patel, K.D., Chakrabarti, S., McAvoy, E., Sinclair, G.D., et al. (2007). Platelet

TLR4 activates neutrophil extracellular traps to ensnare bacteria in septic blood. *Nature medicine* 13, 463–469. <https://doi.org/10.1038/nm1565>

5. Fuchs, T.A., Abed, U., Goosmann, C., Hurwitz, R., Schulze, I., Wahn, V., Weinrauch, Y., Brinkmann, V., and Zychlinsky, A. (2007). Novel cell death program leads to neutrophil extracellular traps. *J Cell Biology* 176, 231–241. <https://doi.org/10.1083/jcb.200606027>
6. AA is Chief Medical Officer of Santerus AG

Topic: Sepsis

000807

Cerebral Perfusion Pressure guided therapy in patients with subarachnoid haemorrhage – a retrospective study

A. Gradyś¹, J. Szrama¹, Z. Molnar², P. Guzik³, K. Kusza⁴

¹Department of Anesthesiology, Intensive Therapy and Pain Management, Poznan University of Medical Sciences, Poznań, Poland;

²Department of Anesthesiology and Intensive Therapy, Semmelweis University, Budapest, Hungary; ³Department of Cardiology - Intensive Therapy, Poznan University of Medical Sciences, Poznań, Poland;

⁴Department of Anesthesiology, Intensive Therapy and Pain Management, Poznan University of Medical Sciences, Poznań, Poland

Correspondence: J. Szrama

Intensive Care Medicine Experimental 2023, **11(Suppl 1)**:000807

Introduction: Avoiding and treating hemodynamic instability and raised intracranial pressure (ICP) in patients with subarachnoid haemorrhage (SAH) is of utmost importance. Brain Trauma Foundation recommend monitoring of ICP and cerebral perfusion pressure (CPP) to optimize cerebral blood flow after head trauma. However there are no guidelines on such treatment algorithms in patients with SAH.

Objectives: The aim of this study was to evaluate the effects of a protocolized CPP guided treatment on mortality and functional outcome in patients admitted to the intensive care unit (ICU) with SAH.

Methods: This was a single center retrospective study performed in an Intensive Care Unit in Poland. Fifty four ICU patients with SAH admitted between March 2019 and December 2021 were included in the study. Patients with cardiac arrhythmias, patients breathing spontaneously, patients with previous neurologic deficits were excluded from the analysis.

In the study group fluid therapy, vasoactive and inotropic drugs, as well as diuretics and osmotherapy was managed according to the treatment protocol guided to maintain CPP above 70 mmHg based on transpulmonary thermodilution hemodynamic monitoring and ICP measurement. In the control group standard monitoring was used to optimize hemodynamic status of the patients.

The primary endpoints of this study were mortality and functional outcome assessed in Rankin and Glasgow Outcome Scale scales after 30 days. The incidence of delayed cerebral ischemia (DCI) constituted secondary outcome.

Results: Values of MAP, as well as cumulative dose of crystalloids and fluid balance were similar in both groups. The incidence of DCI was significantly lower in the study group (14% vs. 64%, $p < 0.01$), and the functional outcome determined by the Glasgow Outcome Scale on 30th day post ictus was also significantly better in the study group (29.0% vs. 5.5%, $p = 0.03$).

Conclusions: The study showed that patients treated with CPP guided therapy had lower incidence of DCI and had a better functional outcome after 30 days.

Topic: Neurointensive care.

000808

Gut microbiota alterations and fecal pH as potential prognostic markers in critically ill patients

H. Wozniak¹, V. Lazarevic², T.S. Beckmann¹, L. Fröhlich¹, C. Le Terrier¹, T. Roachat Negro¹, T. Soccorisi¹, N. Suh¹, C. Chaabane², N. Gaïa², J. Pugin¹, J. Schrenzel², C.P. Heidegger¹

¹Intensive Care Unit, Hôpitaux Universitaires de Genève (HUG), Genève, Switzerland; ²Bacteriology Laboratory, Division of Laboratory Medicine,

Department of Diagnostics, Hôpitaux Universitaires de Genève (HUG), Genève, Switzerland

Correspondence: H. Wozniak

Intensive Care Medicine Experimental 2023, **11(Suppl 1)**:000808

Introduction: Critical illnesses leading to intensive care unit (ICU) hospitalization have been associated with alteration of the gut microbiota, resulting in dysbiosis characterized by lower diversity and richness compared to healthy subjects. Such dysbiosis has been previously associated with poor outcomes in critically ill patients. A prior study suggested that stool pH, which can be easily measured at the bedside, may serve as a simplified biomarker for gut microbiota composition.

Objectives: Our study aimed to investigate early changes in gut microbiota in ICU-admitted patients and their association with overall mortality, hypothesizing that the early development of intestinal dysbiosis is associated with mortality. We also explored if fecal pH could be a simplified biomarker for gut microbiota alteration.

Methods: Fecal samples were collected for gut microbiota and pH assessments on Day 1 (D1) and Day 3 (D3). Fecal pH measurement was conducted by inserting a pH meter directly into the fecal sample. Microbiota analysis was performed using full-length 16S rRNA gene sequencing. The Shannon index and observed (species or genus) richness were used to assess within-sample alpha diversity. Differences between bacterial communities were assessed by Bray–Curtis similarity (overall community, beta-diversity) and DESeq2 (individual taxa). Wilcoxon rank-sum test was used to compare differences between survivors and non-survivors in (i) gut microbiota changes (Bray–Curtis similarity) and (ii) alpha-diversity indices. To test intra-individual differences in alpha-diversity between sampling points we used Wilcoxon signed-rank test. To test the significance of microbiota differences between sampling points or between patient survival outcomes, we used PERMANOVA (for overall microbiota) and DESeq2 (for individual taxa). The association between microbiota and fecal pH was tested using DISTLM. Spearman correlation analysis was conducted to investigate the correlation between gut microbiota changes (Bray–Curtis) and fecal pH changes.

Results: A total of 101 patients were enrolled, and 24 patients died within 60 days. Non-survivors had higher APACHE II scores on ICU admission compared to survivors (27.6 (SD 7) vs. 23.2 (SD 5) $p < 0.01$). The richness and diversity of gut microbiota decreased between D1 and D3 ($p < 0.01$). Overall bacterial communities' profiles at D3 significantly correlated with mortality ($p = 0.014$ for species, $p = 0.036$ for genera). Regarding pH, the delta pH (D3-D1) was of +0.3 (SD 0.6) in non-survivors and of -0.01 (SD 0.9) in survivors. Genus-level bacterial community profiles were associated with pH ($p = 0.013$ at D1, $p = 0.034$ at D3), but there was no significant correlation between gut microbiota changes and fecal pH changes. However, a fecal pH change of ≥ 0.1 was associated with mortality, after adjusting for the APACHE II score at ICU admission (OR 5, 95% CI 1.6–15.3, $p < 0.01$).

Conclusions: Early microbial composition or changes may potentially serve as an early marker for poor prognosis. Fecal pH changes were not associated with changes in bacterial profiles, but were associated with mortality. Further research is warranted to investigate the potential of fecal pH and gut microbiota dysbiosis as prognostic markers in critically ill patients, with larger studies and investigations needed to elucidate the underlying mechanisms and implications for patient outcomes.

Topic: Metabolism, endocrinology, liver failure and nutrition

000809

Extracorporeal membrane oxygenation as the rescue therapy for severe acute respiratory distress syndrome with COVID-19 and other etiologies

S. Kim¹, H. Jinwook², Y. J. Kim³, J. S. Shin², J. H. Kim¹

¹Critical Care Medicine, Korea University College of Medicine, Ansan hospital, Ansan, Republic of Korea; ²Thoracic and Cardiovascular Surgery, Korea University College of Medicine, Ansan Hospital, Ansan, Republic

of Korea; ³Pulmonology, Internal Medicine, Korea University College of Medicine, Ansan Hospital, Ansan, Republic of Korea

Correspondence: S. Kim

Intensive Care Medicine Experimental 2023, **11(Suppl 1):**emphasis>000809

Introduction: Venovenous extracorporeal membrane oxygenation (VV ECMO) has been used as a rescue therapy in severe acute respiratory distress syndrome (ARDS). We compared the clinical course and outcome of patients who received VV ECMO for corona virus disease 2019 (COVID-19) and other etiologies.

Methods: This single center retrospective evaluation enrolled adult patients with severe ARDS receiving VV ECMO during COVID-19 pandemic from March 2020 to February 2023.

Results: There were 22 patients with COVID-19 and 24 patients without COVID-19 who received VV ECMO due to severe ARDS during the study period. They were 60 ± 9 years and eighteen were women. Charlson Comorbidity index was 3 (2–4.25), and SOFA score on the first day of ECMO was 9 (7–12). Days between the first day of mechanical ventilator and ECMO was 2 (0–7), and the duration of ECMO was 13.5 (7.75 – 43.50) days. In patients with COVID-19, SOFA score was lower (10.8 ± 3.8 vs. 8.0 ± 3.6, p = 0.035) and the duration of ECMO was longer (10.5 [3.25–29.25] vs. 24.5 [10–63.25], p = 0.042) than in patients without COVID-19. The weaning rate of ECMO was 24/46 (52.2%) in all; 12/24 (50%) for non-COVID-19 patients and 12/22 (54.5%) for COVID-19 patients (p = 0.78). In multiple cox regression analysis adjusted with age, sex, sequential organ failure assessment score, and Charlson comorbidity index, COVID-19 was a significant parameter related with lower weaning rate of VV ECMO (Hazard ratio 0.284, 95% confidence interval 0.102–0.790, p = 0.016).

Conclusions: In the adjusted Cox regression model, COVID-19 decreased the possibility of weaning from VV ECMO in patients with severe ARDS. Considering the longer treatment period of COVID-19 than other etiologies of ARDS, evidence based patient selection should be followed in this COVID-19 pandemic.

Topic: Acute respiratory failure and mechanical ventilation

000814

Outcomes of obesity and acute kidney injury in sepsis: a nationwide prospective cohort study

S. M. Yoon¹, Y. H. Ahn², J. Lee¹, S. M. Lee¹, D. K. Oh³, L. Su Yeon³, M. H. Park³, C. M. Lim³, H. Y. Lee²

¹Division of Pulmonary and Critical Care Medicine, Department of Internal Medicine, Seoul National University Hospital, Seoul, Republic of Korea;

²Department of Critical Care Medicine, Seoul National University Hospital, Seoul, Republic of Korea; ³Department of Pulmonary And Critical Care Medicine, Asan Medical Center, Seoul, Republic of Korea

Correspondence: S. M. Yoon

Intensive Care Medicine Experimental 2023, **11(Suppl 1):**000814

Introduction: The weight of obesity prevalence is growing in the intensive care unit (ICU). Although obesity is a known risk factor for chronic kidney disease (CKD), its association with acute kidney injury (AKI) and their combined impact on patient outcomes warrant further investigation.

Objectives: To explore the association between obesity, AKI incidence, and clinical outcomes in patients with sepsis.

Methods: This nationwide prospective cohort study analyzed patients with sepsis admitted to 20 tertiary hospital ICUs between September 2019 and December 2021. Patients were categorized by body mass index (BMI), and the primary outcome of AKI incidence during ICU stay was analyzed by logistic regression analysis adjusted for key characteristics and prognostic factors. The secondary outcomes were clinical recovery and mortality.

Results: Of the 4,041 patients included in the study, 1,367 (33.8%) developed AKI. Obesity was associated with a higher incidence of AKI (adjusted odds ratio [aOR], 1.40; 95% confidence interval [CI], 1.15–1.70), as was every 5 kg/m² increase in BMI (aOR, 1.31; 95% CI, 1.19–1.43) (Table 1).

Outcome	Underweight (n = 813)	Normal weight (n = 1668)	Overweight (n = 628)	Obesity (n = 932)	P-value	Adjusted OR (95% CI) per 5 kg/ m ² positive
AKI	201 (24.7)	546 (32.7)	242 (38.5)	378 (40.6)	<0.001	1.31 (1.19–1.43)
Clinical recovery within 30 days	366 (45.0)	818 (49.0)	313 (49.8)	480 (51.5)	0.054	1.07 (0.98–1.16)

While obesity was associated with lower in-hospital mortality in patients without AKI (aOR, 0.81; 95% CI, 0.71–0.93), no difference was observed in those with AKI (aOR, 1.10; 95% CI, 0.94–1.27) (Table 2).

Outcome	Underweight	Normal weight	Overweight	Obesity	Per 5 kg/ m ² positive
ICU mortality	212 (26.1%)	385 (23.1%)	141 (22.5%)	242 (26.0%)	
Adjusted OR (95% CI)	Without AKI 1.66 (1.21–2.27)	1 (ref)	0.78 (0.51–1.19)	0.95 (0.65–1.38)	0.81 (0.69–0.96)
	With AKI 1.16 (0.80–1.70)	1 (ref)	0.99 (0.69–1.43)	1.19 (0.87–1.64)	1.09 (0.94–1.26)
In-hospital mortality	301 (37.0%)	555 (33.3%)	202 (32.2%)	309 (33.2%)	
Adjusted OR (95% CI)	Without AKI 1.46 (1.13–1.88)	1 (ref)	0.85 (0.62–1.16)	0.75 (0.55–1.01)	0.81 (0.71–0.93)
	With AKI 1.27 (0.87–1.86)	1 (ref)	0.84 (0.59–1.20)	1.16 (0.85–1.59)	1.10 (0.94–1.27)

Although obese patients without AKI had better chances of clinical recovery (P < 0.001, log-rank test), the protective effects of obesity were attenuated in those with AKI (P for interaction = 0.047) (Figure 1). **Conclusions:** Obese patients with sepsis have a higher risk of developing AKI. The presence of AKI offsets the possible protective effects of obesity.

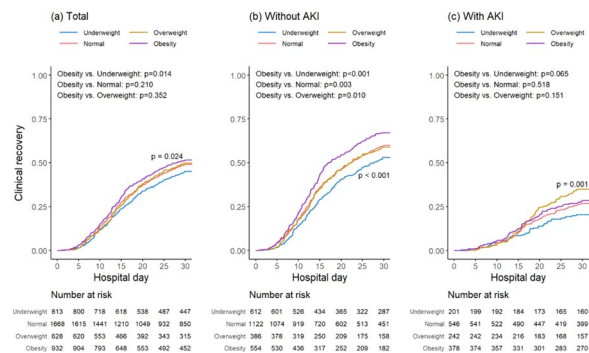

Figure 1 (abstract 000814) Clinical recovery within 30 days according to acute kidney injury status. Clinical recovery was defined as survival to discharge within 30 days.

References

1. Heymsfield SB, Wadden TA. Mechanisms, Pathophysiology, and Management of Obesity. *N Engl J Med.* 2017;376(3):254–66. [PMID: 28099824] <https://doi.org/10.1056/NEJMra1514009>
2. Acknowledgements: The following persons and institutions participated in the Korean Sepsis Alliance (KSA): Steering Committee – Chae-Man Lim (Chair), Sang-Bum Hong, Dong Kyu oh, Su Yeon Lee, Gee Young Suh, Kyeongman Jeon, Ryoung-Eun Ko, Young-Jae Cho, Yeon Joo Lee, Sung Yoon Lim, Sunghoon Park; Participated Persons and Centers – Kangwon National University Hospital – Jeongwon Heo; Korea University Anam Hospital – Jae-myeong Lee; Daegu Catholic University Hospital – Kyung Chan Kim; Seoul National University Bundang Hospital – Yeon Joo Lee; Inje University Sanggye Paik Hospital – Youjin Chang; Samsung Medical Center – Kyeongman Jeon; Seoul National University Hospital – Sang-Min Lee; Asan Medical Center – Chae-Man Lim, Suk-Kyung Hong; Pusan National University Yangsan Hospital – Woo Hyun Cho; Chonnam National University Hospital – Sang Hyun Kwak; Jeonbuk National University Hospital – Heung Bum Lee; Ulsan University Hospital – Jong-Joon Ahn; Jeju National University Hospital – Gil Myeong Seong; Chungnam National University Hospital – Song-I Lee; Hallym University Sacred Heart Hospital – Sunghoon Park; Hanyang University Guri Hospital – Tai Sun Park; Severance Hospital – Su Hwan Lee; Yeungnam University Medical Center – Eun Young Choi; Chungnam National University Sejong Hospital – Jae Young Moon; Inje University Ilsan Paik Hospital – Hyung Koo Kang Hogue CW, Jr., Stearns JD, Colantuoni E, et al. The impact of obesity on outcomes after critical illness: a meta-analysis. *Intensive Care Med.* 2009;35(7):1152–70. [PMID: 19189078] <https://doi.org/10.1007/s00134-009-1424-5>
3. Kalantar-Zadeh K, Block G, Humphreys MH, et al. Reverse epidemiology of cardiovascular risk factors in maintenance dialysis patients. *Kidney Int.* 2003;63(3):793–808. [PMID: 12631061] <https://doi.org/10.1046/j.1523-1755.2003.00803.x>
4. Kalantar-Zadeh K, Block G, Horwich T, et al. Reverse epidemiology of conventional cardiovascular risk factors in patients with chronic heart failure. *J Am Coll Cardiol.* 2004;43(8):1439–44. [PMID: 15093881] <https://doi.org/10.1016/j.jacc.2003.11.039>
5. Tchkonina T, Thomou T, Zhu Y, et al. Mechanisms and metabolic implications of regional differences among fat depots. *Cell Metab.* 2013;17(5):644–56. [PMID: 23583168] <https://doi.org/10.1016/j.cmet.2013.03.008>
6. Fasshauer M, Bluher M. Adipokines in health and disease. *Trends Pharmacol Sci.* 2015;36(7):461–70. [PMID: 26022934] <https://doi.org/10.1016/j.tips.2015.04.014>
7. Anderson MR, Shashaty MGS. Impact of Obesity in Critical Illness. *Chest.* 2021;160(6):2135–45. [PMID: 34364868] <https://doi.org/10.1016/j.chest.2021.08.001>
8. De Jong A, Verzilli D, Sebbane M, et al. Medical Versus Surgical ICU Obese Patient Outcome: A Propensity-Matched Analysis to Resolve Clinical Trial Controversies. *Crit Care Med.* 2018;46(4):e294–e301. [PMID: 29293153] <https://doi.org/10.1097/CCM.0000000000002954>
9. Sakr Y, Alhussami I, Nanchal R, et al. Being Overweight Is Associated With Greater Survival in ICU Patients: Results From the Intensive Care Over Nations Audit. *Crit Care Med.* 2015;43(12):2623–32. [PMID: 26427591] <https://doi.org/10.1097/CCM.0000000000001310>
10. Schetz M, De Jong A, Deane AM, et al. Obesity in the critically ill: a narrative review. *Intensive Care Med.* 2019;45(6):757–69. [PMID: 30888440] <https://doi.org/10.1007/s00134-019-05594-1>

Topic: Acute Kidney Injury and haemofiltration

000815

Dysphagia confirmed by fiberoptic endoscopic evaluation in critical care patients (COVID-19 and non COVID-19): correlation of risk factors and outcomes

L. J. Herrera Parra¹, L. E. Varela Sanchez², J. E. Etulain Gonzalez², Y. F. Borquez Lopez², J. S. Aguirre-Sanchez², BA. Martinez Diaz²
¹Intensive Care Unit, ABC Medical Center, Ciudad de México, Mexico;
²Intensive Care Unit, ABC Medical Center, Ciudad de México, Mexico

Correspondence: L. J. Herrera Parra

Intensive Care Medicine Experimental 2023, **11(Suppl 1)**:000815

Introduction: Swallowing disorders in critically ill patients are an important cause of morbidity and mortality with a reported incidence of more than 80%. Some of the factors associated with these disorders are the progression of the disease, mechanical ventilation, specific drugs, nasogastric tubes and delirium. The guidelines recommend evaluation by endoscopic fibroscopy for its diagnosis and guidance of treatment.

We investigated and compared the predictors and outcomes for these disorders in a cohort of critical care patients hospitalized with COVID-19 and non COVID-19 at a single hospital center.

Objectives: To assess the risk factors and outcomes of COVID-19 and non COVID-19 critical care patients with swallowing disorders.

Methods: We conducted a study of an observational, retrospective cohort, which included patients admitted to our intensive care unit from July 2016 to February 2019 for the non COVID-19 group and from April 2020 to July 2021 for the COVID-19 group, both groups underwent endoscopic fibroscopy with positive result for swallowing disorders. A univariate analysis of selected factors and outcomes was performed, the statistical analysis was prepared in SPSS v.21, frequency measurements were analyzed and the risk factor analysis was performed with Fisher test and $\times 2$ test.

Results: A total of 77 positive endoscopic fibroscopy evaluations were performed. The non COVID-19 group 57.5% (n=33) were males and the COVID-19 group 77.2% were males (n=44, p 0.06). 75.7% of the patients in the non COVID-19 group had prior neurological alteration (p<0.01). 95.5% of the patients in the COVID-19 group were mechanically ventilated (p<0.01). The predominant swallowing disorders in the non COVID-19 group were alterations in the oral phase and in the COVID-19 group alterations of the pharyngeal phase and tracheal aspiration.

Table 1 (abstract 000815) Clinical and therapeutic outcomes

	Non COVID-19 n 33		COVID-19 n 44		p
Days of hospitalization 1	36.1	14–55.5	35.8	28.6 – 43.1	0.96
Days of intubation 1	5.9	2–7.7	15.2	12–18.4	<0.01
Swallowing therapy days 1	19.3	6–30	9.09	5.6–12.54	<0.01
Feeding route at discharge	16	48.4%	35	79.5%	<0.01
2	2	6.0%	0	0%	0.09
Oral	11	33.3%	6	6.8%	0.03
Naso enteral tube	4	12.1%	3	13.6%	0.42
Gastrostomy					
Mixed					

1 Interquartile range for free distribution variables, quantitative variables.

2 Frequencies and proportions, qualitative variables.

Conclusions: Multiple risk factors have been associated with the development of swallowing disorders in the critically ill, in our study we found similar results to prior studies. An outstanding difference between the groups was the presence of neurological alterations in the non-COVID group which may be the cause for a greater percentage of gastrostomy feeding route at discharge and requirement for longer duration of swallowing therapy. The COVID-19 population showed a better recovery rate after deglutition therapy and follow-up.

References

1. Langmore, S. E., Schatz, K., & Olson, N. (1991). Endoscopic and videofluoroscopic evaluations of swallowing and aspiration. *The Annals of otology, rhinology, and laryngology*, 100(8), 678–681.

- Brodsky, M. B., González-Fernández, M., Mendez-Tellez, P. A., Shanholtz, C., Palmer, J. B., & Needham, D. M. (2014). Factors associated with swallowing assessment after oral endotracheal intubation and mechanical ventilation for acute lung injury. *Annals of the American Thoracic Society*, 11(10), 1545–1552.
- Zielske, J., Bohne, S., Brunkhorst, F. M., Axer, H., & Guntinas-Lichius, O. (2014). Acute and long-term dysphagia in critically ill patients with severe sepsis: results of a prospective controlled observational study. *European archives of oto-rhino-laryngology: official journal of the European Federation of Oto-Rhino-Laryngological Societies (EUFOS): affiliated with the German Society for Oto-Rhino-Laryngology—Head and Neck Surgery*, 271(11), 3085–3093.
- Sasegbon, A., & Hamdy, S. (2017). The anatomy and physiology of normal and abnormal swallowing in oropharyngeal dysphagia. *Neurogastroenterology and motility: the official journal of the European Gastrointestinal Motility Society*, 29(11), <https://doi.org/10.1111/nmo.13100>.
- Holdiman, A., Rogus-Pulia, N., Pulia, M. S., Stalter, L., & Thibeault, S. L. (2022). Risk Factors for Dysphagia in Patients Hospitalized with COVID-19. *Dysphagia*, 1–10. Advance online publication.
- Frajkova, Z., Tedla, M., Tedlova, E., Suchankova, M., & Geneid, A. (2020). Postintubation Dysphagia During COVID-19 Outbreak—Contemporary Review. *Dysphagia*, 35(4), 549–557.
- Varela Sánchez, Luis Ernesto, Chávez Requena, Luisa Irina, Sumano Gotóo, Amparo, Pedraza Montenegro, Axel, Sánchez Aguirre, Janet Silvia, & Franco Granillo, Juvenal. (2020). Sospecha clínica del trastorno de la deglución corroborado por fibroscopia endoscópica en pacientes críticos: análisis de utilidad y correlación de los factores de riesgo. *Medicina crítica (Colegio Mexicano de Medicina Crítica)*, 34(2), 138–143. Epub 08 de agosto de 2022.
- The author(s) received no financial support for the research, authorship, and/or publication of this abstract.

Topic: Metabolism, endocrinology, liver failure and nutrition

000816

High dose inhaled nitric oxide in acute hypoxemic respiratory failure: a multicenter phase 2 trial

R. Di Fenza¹, N. Shetty S.², S. Gianni¹, V. Parcha², B. S. Fakhr¹, D. Tornberg³, O. Wall⁴, P. Harbut³, P. S. Lai⁵, J. Z. Li⁶, S. Paganoni⁷, S. Cenci¹, A. L. Mueller⁸, T. T. Houle⁹, O. Akeju¹, A. B. Edward⁹, S. Bose¹⁰, L. K. Scott¹¹, R. W. Carroll¹², F. Ichinose¹, M. Hedenstierna¹³, P. Arora², L. Berra¹

¹Anesthesia, Critical Care and Pain Medicine, Massachusetts General Hospital, Boston, United States of America; ²Cardiovascular Disease, University of Alabama at Birmingham, Birmingham, United States of America; ³Anesthesia and Intensive Care, Danderyd Hospital, Stockholm, Sweden; ⁴Clinical Sciences, Karolinska Institute, Stockholm, Sweden; ⁵Pulmonary and Critical Care Medicine, Massachusetts General Hospital, Boston, United States of America; ⁶Infectious Disease, Brigham and Women's Hospital, Boston, United States of America; ⁷Sean M. Healey and AMG Center for ALS and the Neurological Clinical Research Institute, Massachusetts General Hospital, Boston, United States of America; ⁸Anesthesia Research Center, Massachusetts General Hospital, Boston, United States of America; ⁹Department of anesthesia, critical care and pain medicine, Mass General Hospital, Boston, United States of America; ¹⁰Anesthesia, Critical Care and Pain Medicine, Beth Israel Deaconess Medical Center, Boston, United States of America; ¹¹Pulmonary and Critical Care Medicine, LSU Health Shreveport, Shreveport, United States of America; ¹²Pediatric Critical Care Medicine, Massachusetts General Hospital, Boston, United States of America; ¹³Infectious Disease, Danderyd Hospital, Stockholm, Sweden

Correspondence: L. Berra

Intensive Care Medicine Experimental 2023, **11(Suppl 1)**:000816

Introduction: Prior clinical trials have shown that low-dose, 1 to 20 parts per million (ppm) of inhaled nitric oxide (iNO) leads to short-term (less than 24 h) improvement in oxygenation in critically ill patients with acute lung injury 1–2. Recent studies demonstrated antiviral efficacy of iNO when used at high dose (80 ppm and higher) 3–5.

Objectives: This study tested the hypothesis that antiviral high concentration of iNO administered early after the onset of infection might be beneficial in critically ill patients with acute hypoxemic respiratory failure due to coronavirus disease (COVID-19) pneumonia. This study was designed to evaluate the effect of iNO on systemic oxygenation after 48 h among critically ill and mechanically ventilated patients with COVID-19 in a phase II, multicenter (four sites in the United States and one site in Sweden), single-blind, randomized (1:1), controlled, parallel-arm trial.

Methods: The study enrolled intubated and mechanically ventilated adult patients with SARS-CoV-2 infection. Participants in the treatment arm received inhaled NO at 80 ppm for the first 48 h after enrollment. After the first 48 h of treatment, the gas was reduced to 40 ppm and maintained at this concentration until severe hypoxemia resolved (PaO₂/FiO₂ > 300 mmHg). The primary outcome of this study was the change in arterial oxygenation (PaO₂/FiO₂) at 48 h. The secondary, safety and exploratory outcomes are shown in the results. Sample size calculation demonstrated n = 100 in each group (n = 200 total). The primary and secondary outcomes analysis was conducted using a Bayesian framework that estimates the treatment effect conditional on several pre-specified additional variables included in the model (defined a priori: age, age², sex, BMI, APACHE II score and SMD > 0.20: race, study site, hypertension, diabetes, malignancy, and liver disease). All study outcomes were analyzed in the modified intention-to-treat population.

Results: shown in Table and Figure.

Conclusions: The use of high-dose iNO is safe and resulted in sustained improvement of oxygenation at 48 h compared with usual care in adults with acute hypoxemic respiratory failure due to COVID-19.

This trial also suggests that high doses iNO reduce viral load and have beneficial effects on neurological outcomes. Further studies are required to characterize the antimicrobial properties of high-dose iNO and determine the optimal dosage and duration.

	Treatment Group (94)	Control Group (99)	Difference or Odds Ratio (95% CrI)	
			Adjusted	Unadjusted
Primary Endpoint				
Change in PaO ₂ /FiO ₂ ratio at 48 hours, mmHg	15 [-21, 75]	6 [-36, 39]	31.7 (11.9, 51.9)	36.6 (15.8, 57.5)
Secondary Endpoints				
Mortality within 28 days	27 (28.7%)	27 (27.3%)	OR: 1.07 (0.58 to 2.03)	OR: 0.53 (0.23 to 1.21)
Mortality within 90 days	32 (34.0%)	32 (32.3%)	OR: 1.08 (0.59 to 2.03)	OR: 0.53 (0.24 to 1.21)
Time to Normoxemia, days	5.0 [1.5, 12.0]	8.0 [4.5, 13.0]	-2.07 (-5.67 to 1.61)	-1.44 (-5.0 to 2.26)
Patients reaching Normoxemia	33 [35.1%]	21 [21.2%]	OR: 2.03 (1.06 to 3.90)	OR: 3.90 (1.37 to 9.68)
Safety Outcomes				
Acute Kidney Injury	65 (69.1%)	69 (69.7%)	OR 0.98 (0.53 to 1.80)	OR 0.82 (0.39 to 1.70)
RRT	33 (35.1%)	22 (22.2%)	OR 1.79 (0.97 to 3.35)	OR 1.65 (0.78 to 3.56)
Haemodynamic instability during weaning	0 (0%)			
MetHb above 5%				
Events / Treatment days overall	8/1282			
Events requiring dose reduction	5			
NO: above 3 ppm				
Events / Treatment days overall	1/1282			
Events requiring dose reduction	1			
Exploratory Outcomes				
Requirement for VV-ECMO	4 (4.2%)	5 (5.0%)	OR 0.84 (0.21 to 3.16)	OR 0.70 (0.14 to 3.39)
Neurological Signs and Symptoms (day 90)	4 (4.2%)	17 (17.2%)	OR 0.20 (0.06 to 0.58)	OR 0.17 (0.04 to 0.62)
Motor	4 (4.2%)	12 (12.1%)	OR 0.32 (0.10 to 0.99)	OR 0.36 (0.08 to 1.42)
Sensory	0 (0.0%)	14 (14.1%)	OR 0.02 (0.00 to 0.20)	OR 0.01 (0.00 to 0.12)
Ventilator Time (hours)	409 [264-486]	338 [270-468]	-1.44 (-202.89 to 203.43)	33.73 (-187.52 to 254.18)

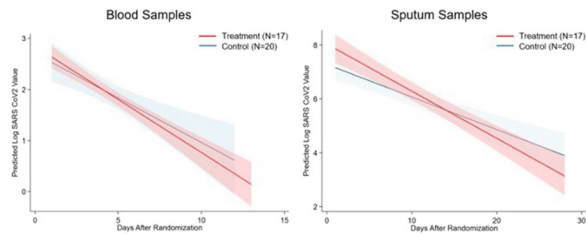

Sputum was collected for up to seven weeks from 37 participants (17 in the treatment group and 20 in the control group) for a total of 82 samples (38 from participants in the treatment group and 44 from participants in the control group). Over time, there was a steeper decline in plasma viral load ($\beta_{\text{time}}: -0.21$, 95% CrI: -0.25 – 0.17 ; $\beta_{\text{group}}: -0.30$, 95% CrI: -1.00 – 0.42) in patients enrolled in the inhaled NO arm compared with those in the control arm ($\beta_{\text{time} \times \text{group}}: -0.04$, 95% CrI: -0.12 – 0.04). Similarly, among the subset of patients from whom sputum samples were taken, there was a greater decline in viral load over time ($\beta_{\text{time}}: -0.13$, 95% CrI: -0.16 – 0.11 ; $\beta_{\text{group}}: 0.29$, 95% CrI: -0.87 – 1.44) in the treatment arm compared with the control arm ($\beta_{\text{time} \times \text{group}}: -0.04$, 95% CrI: -0.09 – 0.01).

References

1. Akaberi D, Krambrich J, Ling J, et al. Mitigation of the replication of SARS-CoV-2 by nitric oxide in vitro. *Redox Biol* 2020; 37: 101,734
2. Goldbart A, Lavie M, Lubetzky R, et al. Inhaled Nitric Oxide for the Treatment of Acute Bronchiolitis: A Multicenter Randomized Controlled Trial to Evaluate Dose Response. *Ann Am Thorac Soc* 2022. doi: <https://doi.org/10.1513/annats.202103-348oc>
3. Valsecchi C, Winterton D, Fakhr BS, et al. High-Dose Inhaled Nitric Oxide for the Treatment of Spontaneously Breathing Pregnant Patients With Severe Coronavirus Disease 2019 (COVID-19) Pneumonia. *Obstetrics & Gynecology* 2022
4. Gerlach H, Keh D, Semmerow A, et al. Dose-Response Characteristics during Long-Term Inhalation of Nitric Oxide in Patients with Severe Acute Respiratory Distress Syndrome. *Am J Resp Crit Care* 2003; 167: 1008–15
5. Taylor RW, Zimmerman JL, Dellinger RP, et al. Low-Dose Inhaled Nitric Oxide in Patients With Acute Lung Injury: A Randomized Controlled Trial. *Jama* 2004; 291: 1603–9
6. Hospital funds, iNO Therapeutics, Linde

Topic: Acute respiratory failure and mechanical ventilation

000817

Comparative performance of intensive care mortality prediction models based on manually curated versus automatically extracted electronic health record data

A. Jagesar¹, M. Otten¹, T. A. Dam², L. A. Biesheuvel¹, D. Dongelmans³, P. J. Thorai¹, A. Girbes¹, V. François-Lavet⁴, H. J. De Groot¹, P. Elbers¹
¹Intensive care adults, Amsterdam UMC, locatie VUmc, Amsterdam, Netherlands; ²Intensive care medicine, Amsterdam UMC, locatie VUmc, Amsterdam, Netherlands; ³Medical informatics, Amsterdam UMC, locatie AMC, Amsterdam, Netherlands; ⁴Department of Computer Science, Vrije Universiteit Amsterdam, Amsterdam, Netherlands

Correspondence: A. Jagesar

Intensive Care Medicine Experimental 2023, **11(Suppl 1)**:000817

Introduction: Intensive care unit mortality prediction models, frequently used for benchmarking for audit and feedback, traditionally

rely on significant manual data entry and curation. The advent of electronic health records and release of intensive care datasets allows for automated data collection. This could circumvent the need for manual data handling and has the potential to facilitate more sophisticated modeling using more data of higher granularity and from wider collection windows. However, automation also requires significant resources. Therefore, it is important to assess the comparative performance of intensive care mortality prediction models based on manually curated versus automatically extracted electronic health record data.

Methods: Data from the freely available highly granular AmsterdamUMCdb intensive care dataset was used for the systematic development and evaluation of mortality prediction models. Using the well-known original APACHE IV model as baseline, aspects in which new models differed included the extent of automatic extraction of variables, classification method, recalibration usage, and size of collection window.

Results: From AmsterdamUMCdb, 13 models were developed based on data from 5,077 admissions divided into a train (80%) and test (20%) cohort. Adding variables or extending variable collection time windows only marginally improved discrimination and calibration. The best performing model using only automatically extracted variables and therefore no diagnosis or comorbidity information was an XGboost model. This model had similar discrimination and calibration as the APACHE IV references models with an AUC of 0.89 and Brier scores of 0.10.

Conclusions: Performance of intensive care mortality prediction models based on manually curated versus automatically extracted electronic health record data is similar. Importantly, our results suggest that variables typically requiring manual curation, such as diagnosis and comorbidities, are not necessary for accurate mortality prediction. These proof-of-concept results require replication using multi-center data.

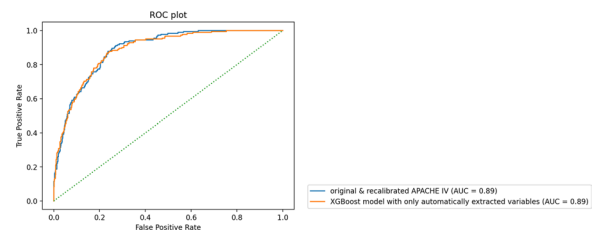

ROC plot of main comparator and APACHE IV mortality prediction models. Note that the original and recalibrated variant of the APACHE IV have the same ROC, as their discrimination does not differ.

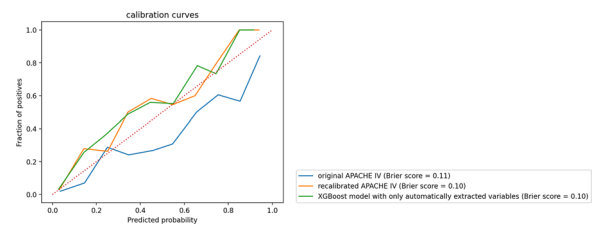

Calibration curves of main comparator and APACHE IV mortality prediction models evaluated on the test set in 10 deciles

References

1. Thorat, P. J., Peppink, J. M., Driessen, R. H., Sijbrands, E. J. G., Kompanje, E. J. O., Kaplan, L., Bailey, H., Kesecioglu, J., Cecconi, M., Churpek, M., Clermont, G., van der Schaar, M., Ercole, A., Girbes, A. R. J., Elbers, P. W. G., Amsterdam University Medical Centers Database, C., & the, S. E. J. D. S. T. F. (2021). Sharing ICU Patient Data Responsibly Under the Society of Critical Care Medicine/European Society of Intensive Care Medicine Joint Data Science Collaboration: The Amsterdam University Medical Centers Database (AmsterdamUMCdb) Example. *Crit Care Med*, 49(6), e563–e577. doi: <https://doi.org/10.1097/CCM.0000000000004916>
2. Brinkman, S., Bakhshi-Raiez, F., Abu-Hanna, A., de Jonge, E., Bosman, R. J., Peelen, L., & de Keizer, N. F. (2011). External validation of Acute Physiology and Chronic Health Evaluation IV in Dutch intensive care units and comparison with Acute Physiology and Chronic Health Evaluation II and Simplified Acute Physiology Score II. *J Crit Care*, 26(1), 105 e111–108. doi: <https://doi.org/10.1016/j.jcrrc.2010.07.007>
3. Zimmerman, J. E., Kramer, A. A., McNair, D. S., & Malila, F. M. (2006). Acute Physiology and Chronic Health Evaluation (APACHE) IV: hospital mortality assessment for today's critically ill patients. *Crit Care Med*, 34(5), 1297–1310. doi: <https://doi.org/10.1097/01.CCM.0000215112.84523.F0>

Topic: Critical care organisation, quality management, information systems, outcomes

000818

Screening and identification of crucial genes that regulate immune imbalance in sepsis

C. Gao¹, C. Jie², H. Qiu¹

¹Jiangsu Provincial Key Laboratory of Critical Care Medicine, Department of Critical Care Medicine, Zhongda Hospital, School of Medicine, Southeast University, Nanjing, China; ²Department of Physiology, School of Medicine, Southeast University, Nanjing, China

Correspondence: C. Gao

Intensive Care Medicine Experimental 2023, **11(Suppl 1)**:000818

Introduction: Sepsis is a severe and often fatal infectious disease, and immune imbalance is a critical factor contributing to its high mortality rate. Investigating the mechanisms behind the immune imbalance in sepsis is crucial to promote its precise treatment and reducing mortality.

Objectives: This study aimed to screen and identify critical genes associated with immune imbalance in sepsis, thereby improving clinical decision-making precision and promoting the development of precision medicine.

Methods: We analyzed the GSE65682 dataset from the Gene Expression Omnibus (GEO) using the ssGSEA algorithm to distinguish immune cell infiltration in different sepsis samples, and the E-MTAB-7581 dataset was used to validate the effect of hydrocortisone in different subgroups. We then used the Weighted Gene Correlation Network Analysis (WGCNA) and protein–protein interaction (PPI) to screen genes most related to immune infiltration. Peripheral blood samples from mice were used to confirm the expression changes of hub genes. We focused mainly on *TBX21*, which encodes the transcription factor T-bet and plays a critical role in the balance of Th1/Th2, and Th17/Treg. Therefore, the genetically engineered mice with specific overexpression of *Tbx21* in CD4+T cells were constructed to verify the role of T-bet in the immune imbalance in sepsis.

Results: Sepsis samples were divided into two sub-groups based on their level of immunity. The group with a higher immunity score, when treated with hydrocortisone, showed a significant reduction in mortality ($P=0.0493$). Additionally, *TBX21*, *PRF1*, *IL2RB*, and *GNLY* were identified as hub genes associated with the immune imbalance in sepsis. The expression of all four hub genes showed significant differences between healthy and septic mice. Furthermore, Kaplan–Meier survival analysis revealed that the high and low expression groups for each hub gene had statistically different outcomes ($P<0.05$). Genetically engineered mice overexpressing *Tbx21* in CD4+T cells exhibited

significantly improved survival compared to the control group after cecal ligation and puncture ($P=0.0152$).

Conclusions: *TBX21*, *PRF1*, *IL2RB*, and *GNLY* are associated with sepsis severity and clinical immune-related indicators. Overexpression of *Tbx21* in CD4+T cells improves sepsis survival, which may be involved in the simultaneous improvement of Th1/Th2, Th17/Treg imbalance in sepsis by T-bet. These findings may help in the development of precision medicine for sepsis treatment.

References

1. This work was supported by the Project supported by the Key Program of the National Natural Science Foundation of China (Grant No. 81930058), Jiangsu provincial key research and development program (BE2019749), Jiangsu province key laboratory of critical care medicine (BM2020004).

Topic: Sepsis

000819

Analysis of pediatric population receiving Home Mechanical Ventilation

E. Ha¹

¹Pediatrics, ASAN Medical Center, Seoul, Republic of Korea

Correspondence: E. Ha

Intensive Care Medicine Experimental 2023, **11(Suppl 1)**:000819

Introduction: Home Mechanical Ventilation (HMV) is one of the alternative option that can replace the mechanical ventilation treatment in the intensive care unit. In the early days, HMV were applied to children with neuromuscular disease. However, not only does the number of patients applying HMV increase, but it is also widely applied in more diverse diagnosis over the years.

Objectives: The aim of this study was to provide a descriptive analysis of pediatric population receiving HMV. So we tried to find out the changes of patients' indications of HMV and the outcomes after HMV application.

Methods: This is a retrospective, observational cohort study of consecutive pediatric patients receiving HMV after admission in Pediatric Intensive Care Unit in Asan Medical Center Children's hospital between January 2003 and December 2022. Data were collected from reviewing the electronic medical records.

Results: Total 160 patients were enrolled and the median age was 5.5 years and male patients accounted for 61.3% ($n=98$). For 20 years, the number of patients applying HMV continued to increase every year, and since 2016, it has more than doubled compared to before. The most common indication for applying HMV was neuromuscular disease (53.1%) and followed by pulmonologic disease. Since 2016, HMV has been applied due to heart failure, and these patients accounted for 10.0%. Compared to neuromuscular diseases, the number of patients applying due to heart failure and respiratory failure showed an increasing trend. 30.6% of patients with HMV died, and the main reason of death was exacerbation of underlying diseases (58.5%). 61.3% of the survivors were in continuous use, and the rest improved and weaned HMV. As the number of patients applied HMV increases, the number of patients in use is also increasing, but the mortality rate is gradually decreasing, and the number of patients who are improving and discontinued HMV is increasing. 45.6% of patients who applied due to heart failure and respiratory failure improved and discontinued HMV, but only 0.07% of patients who applied HMV due to neuromuscular problems stopped HMV.

Conclusions: The results of this study showed changes in patients who applied HMV for 20 years. It could be seen that the patient's prognosis changed by applying HMV to more diverse patients. In particular, patients who applied due to heart failure and respiratory failure improved compared to patients who applied ventilators due to neurological problems, showing a greater possibility of stopping HMV. This is considered to be a very important evidence when making a decision on the application of HMV.

Topic: Acute respiratory failure and mechanical ventilation

000820

Sepsis induced cardiomyopathy assessed by speckle tracking as a predictor of mortality in septic patients. A prospective study in Argentina

F. Daldoss¹, L. Bertorello², A. Sosa³, B. Tort¹, J. Roberti¹, J. Ruiz¹, G. César¹, A. Matarrese¹, M. Castillo¹, J. Osatnik¹, P. Merlo⁴

¹Intensive Care Unit, Hospital Alemán (German Hospital of Buenos Aires), Buenos Aires, Argentina; ²Intensive Care Unit, Hospital Alemán (German Hospital of Buenos Aires), Buenos Aires, France; ³Intensive Care Unit, Hospital Alemán, Buenos Aires, Argentina; ⁴Intensive Care, Hospital General de Agudos B. Rivadavia, Buenos Aires, Argentina

Correspondence: J. Roberti

Intensive Care Medicine Experimental 2023, **11(Suppl 1)**:000820

Introduction: Sepsis-induced myocardial dysfunction (SIMD) is a frequent condition, often overlooked in intensive care units (ICUs). Despite its significance, the extent of its impact on prognosis remains unclear (1,2). Although ejection fraction (EF) is the most used diagnostic method, left ventricular (LV) global longitudinal strain (GLS) by speckle tracking has shown to be more sensitive in detecting early myocardial dysfunction in septic patients (2). When detected by GLS, SIMD has been associated with increased mortality; however, evidence is not conclusive (3–5).

Objectives: To determine whether a decrease in GLS can be used as a predictor of mortality in individuals with sepsis or septic shock in an ICU.

Methods: Prospective cohort study of septic patients admitted to ICU. Myocardial dysfunction was assessed using transthoracic or transesophageal echocardiography within 24 h of septic event (Sepsis 3) (6) using either a General Electric Vivid IQ or PHILIPS CX50 multiplanar TEE probe. Clinical characteristics, cardiac markers including ProBNP and Troponin T were recorded. Relevant variables for multiple regression analysis were selected based on the principle of parsimony and/or $p < 0.1$ values in univariate analysis. Significance was set at $p < 0.05$.

Results: A total of 101 patients were included. Global ICU mortality was 34%, 70% patients met septic shock criteria. The following characteristics were significantly higher in nonsurvivors compared to survivors: age, APACHE II and SOFA scores, proportion of mechanical ventilation, septic shock, PRO-BNP and troponin T levels within the first 24 h, proportion of vasopressor use, heart rate, LVEF by Simpson method, and E/e'. Values of LV ventricular longitudinal strain, left ventricle 2 chamber, 3 chamber, 4 chamber strain and GLS were also significantly different (Table 1).

Table 1 (abstract 000820) Patients' characteristics

Characteristics	Total n = 101	Survivors n = 66	Nonsurvivors n = 35	P value
Age, years	67.0 ± 15.0	63.8 ± 16.3	73.1 ± 9.6	0.0028
Male, n(%)	59(58.4)	38(57.6)	21(60)	0.814
APACHE	15.1 ± 6.8	14.0 ± 5.8	17.2 ± 7.9	0.0206
Heart beat, /min	95.1 ± 21.5	91.0 ± 20.7	102.9 ± 21.1	0.014
ProBNP base, pg/ml	6745.2 ± 10,774.2	4279.5 ± 5721.4	11,078.9 ± 15,420.4	0.0033
Troponine T at baseline, pg/ml	95.3 ± 176.2	55.0 ± 80.3	164.0 ± 258.3	0.0036

In univariate analysis, age, SOFA, EF and GLS were associated with risk of ICU mortality. In the multivariate analysis, controlling SOFA, age and vasopressor therapy, GLS remained the independent predictor of ICU mortality in septic patients (Odds ratio 0.77, 95%CI 0.6297–0.9391; $p = 0.010$). Receiver operating characteristic curve showed an area under curve of 0.78 (Sensitivity: 87.1%, Specificity: 60.3%) using LV GLS of – 15.1% as a predictor of ICU mortality (Table 2).

Multivariate analysis

Variable	OR	SE	P	95%CI
Age	1.11	0.037	0.003	1.0349– 1.18176
SOFA	1.22	0.139	0.081	0.9758 – 1.5259
Vasopres. inotr	8.80	5.800	0.001	2.4205—32.026
LV GLS	0.77	0.078	0.010	0.6297 – 0.9391

Conclusions: Our findings show GLS is a reliable predictor of ICU mortality. These results align with previous research that has shown no correlation between systolic cardiac dysfunction diagnosed by EF and mortality in septic patients (7). GLS can be a valuable tool for diagnosing and predicting outcomes in individuals with SIMD. Further large-scale studies are necessary to establish the optimal cutoff point in this population.

References

1. L'Heureux M, Sternberg M, Brath L, Turlington J, Kashiouris MG. Sepsis-Induced Cardiomyopathy: a Comprehensive Review. *Curr Cardiol Rep.* 2020 May 6;22(5):35. doi: <https://doi.org/10.1007/s11886-020-01277-2>. PMID: 32377972; PMCID: PMC7222131
2. Shahul S, Gulati G, Hacker MR, Mahmood F, Canelli R, Nizamuddin J, Mahmood B, Mueller A, Simon BA, Novack V, Talmor D. Detection of Myocardial Dysfunction in Septic Shock: A Speckle-Tracking Echocardiography Study. *Anesth Analg.* 2015 Dec;121(6):1547–54. doi: <https://doi.org/10.1213/ANE.0000000000000943>. PMID: 26397444.
3. Sanfilippo F, Corredor C, Fletcher N, Tritapepe L, Lorini FL, Arcadipane A, Vieillard-Baron A, Cecconi M. Left ventricular systolic function evaluated by strain echocardiography and relationship with mortality in patients with severe sepsis or septic shock: a systematic review and meta-analysis. *Crit Care.* 2018 Aug 4;22(1):183. doi: <https://doi.org/10.1186/s13054-018-2113-y>. PMID: 30075792; PMCID: PMC6091069.
4. Vallabhajosyula S, Rayes HA, Sakhuja A, Murad MH, Geske JB, Jentzer JC. Global Longitudinal Strain Using Speckle-Tracking Echocardiography as a Mortality Predictor in Sepsis: A Systematic Review. *J Intensive Care Med.* 2019 Feb;34(2):87–93. doi: <https://doi.org/10.1177/0885066618761750>. Epub 2018 Mar 18. PMID: 29552957
5. Chang WT, Lee WH, Lee WT, Chen PS, Su YR, Liu PY, Liu YW, Tsai WC. Left ventricular global longitudinal strain is independently associated with mortality in septic shock patients. *Intensive Care Med.* 2015 Oct;41(10):1791–9. doi: <https://doi.org/10.1007/s00134-015-3970-3>. Epub 2015 Jul 17. PMID: 26183489.
6. Singer M, Deutschman CS, Seymour CW, Shankar-Hari M, Annane D, Bauer M, Bellomo R, Bernard GR, Chiche JD, Cooper-Smith CM, Hotchkiss RS, Levy MM, Marshall JC, Martin GS, Opal SM, Rubenfeld GD, van der Poll T, Vincent JL, Angus DC. The Third International Consensus Definitions for Sepsis and Septic Shock (Sepsis-3). *JAMA.* 2016 Feb 23;315(8):801–10.

doi: <https://doi.org/10.1001/jama.2016.0287>. PMID: 26903338; PMCID: PMC4968574.

7. Sevilla Berrios RA, O'Horo JC, Velagapudi V, Pulido JN. Correlation of left ventricular systolic dysfunction determined by low ejection fraction and 30-day mortality in patients with severe sepsis and septic shock: a systematic review and meta-analysis. *J Crit Care*. 2014 Aug;29(4):495–9. doi: <https://doi.org/10.1016/j.jcrc.2014.03.007>. Epub 2014 Mar 21. PMID: 24746109.

Topic: Sepsis

000821

Association between renal replacement therapy initiated before or after extracorporeal membrane oxygenation cannulation with in-hospital mortality in COVID-19 patients

A. Franci¹, F. Galas¹, H. Fernandes¹, L. Pastore Junior², A. Rosario², L. Baracioli¹, R. Saretta¹, M. Mourao³, J. Moraes¹, M. Dias¹, L. Drager¹; R. Kalil-Filho¹

¹Cardiology, Hospital Sírio Libanes, São Paulo, Brazil; ²Icu, Hospital Sírio Libanes, São Paulo, Brazil; ³Cardiology, Hospital Sírio Libanes, Brasília, Brazil

Correspondence: A. Franci

Intensive Care Medicine Experimental 2023, **11(Suppl 1)**:000821

Introduction: Extracorporeal membrane oxygenation (ECMO) can be a lifesaving measure for patients with severe acute respiratory distress syndrome (ARDS) and was largely employed to support patients with severe forms of COVID-19 infection who evolved with refractory hypoxemia and hypercapnia.[1] Acute kidney injury (AKI) is a frequent complication among patients on ECMO, and around 50% of these patients require renal replacement therapy (RRT) [2] resulting in increased morbidity and mortality.[3] However, the association between timing of RRT initiation (before or after ECMO cannulation) and outcomes is still a matter of debate with conflicting data in the literature. [4–6].

Objectives: The main objective of this study was to evaluate the impact of AKI and timing of RRT initiation on hospital mortality in COVID-19 ECMO-supported patients.

Methods: This was a retrospective study which included consecutive hospitalized adult patients, from April 2020 to August 2021, with a confirmed diagnosis of COVID-19 and severe ARDS requiring support with veno-venous (VV) ECMO, in two hospitals in Brazil. All patients who required RRT were submitted to continuous RRT (CRRT) directly connected to the ECMO circuit. Univariate analysis for the association of AKI, need for RRT, RRT initiated before and after ECMO cannulation with in-hospital mortality were performed using the chi-square and Fisher exact tests when appropriate. These variables were then included in a multivariable stepwise Cox proportional hazards regression analysis model adjusting to patients' baseline characteristics such as age, sex, comorbidities (hypertension, diabetes, dyslipidemia, obesity, coronary artery disease, chronic kidney disease, pulmonary disease and malignancy) and the ICU admission SAPS-3.

Results: Eighty-five COVID-19 critically ill VV-ECMO-supported patients were included during the study period. The mean age was 59 ± 13 years, 15% were women, more than 85% had at least one previous chronic condition, mean SAPS-3 at ICU admission was 54 ± 12 and overall in-hospital mortality was 47%. AKI was diagnosed in 44 (51.8%) patients, 30 (35.3%) patients required RRT, 16 initiated RRT before and 14 after ECMO cannulation. Patients who evolved with AKI were older (63×54 years, $p = 0.001$), had higher SAPS-3 (57×52 points, $p = 0.039$), and had a higher prevalence of hypertension ($64\% \times 40\%$, $p = 0.030$), coronary artery disease ($18\% \times 3\%$, $p = 0.031$) and cancer ($23\% \times 5\%$, $p = 0.028$). There were no significant baseline characteristics differences between patients who initiated RRT before or after ECMO cannulation. In-hospital mortality related to each group of patients is shown in Figure 1. Results from the cox proportional hazards regression analysis are depicted in Table 1, showing that RRT initiated after, but not before

ECMO cannulation, remained independently associated with higher in-hospital mortality.

Table 1 (abstract 000821) Multivariable stepwise Cox proportional hazards regression analysis with predictors associated with in-hospital mortality

	Multivariable analysis		
	HR	95% CI	p-value
Age, per additional year	1.04	1.01 – 1.07	0.018
SAPS-3	1.04	1.01 – 1.07	0.008
AKI	2.06	0.95 – 4.49	0.069
RRT after ECMO	2.73	1.22 – 6.13	0.015
RRT before ECMO	1.05	0.41 – 2.73	0.918

SAPS-3: Simplified Acute Physiology Score III; AKI: acute kidney injury; RRT: renal replacement therapy; ECMO: extracorporeal membrane oxygenation.

Conclusions: In this retrospective analysis, RRT initiated after ECMO cannulation was associated with poor in-hospital outcomes, independently of patients' baseline characteristics, whereas AKI and RRT initiated before ECMO cannulation were not. There is still conflicting data surrounding this issue and efforts should be made to clarify and guide clinical practice on the indication for RRT in ECMO-supported patients. This could lead to a more rational prescription of RRT, identifying patients more likely to benefit from this therapy, and ultimately optimization of technical and personnel resources.

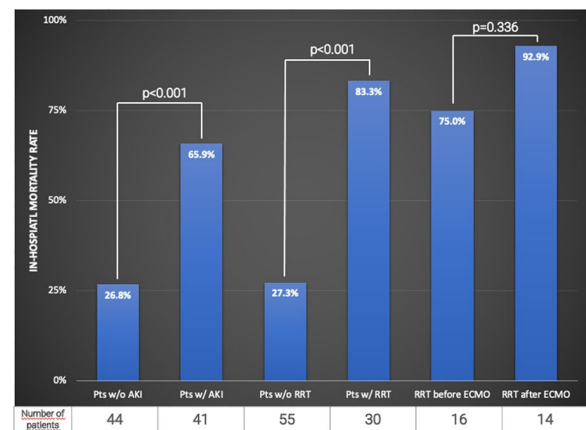

Figure 1 (abstract 000821) In-hospital mortality comparison between patients (pts) with (w/) and without (w/o) acute kidney injury (AKI); patients with and without need for renal replacement therapy (RRT); and RRT initiated before and after extracorporeal membrane oxygenation (ECMO)

References

1. Barbaro RP, MacLaren G, Boonstra PS, et al; Extracorporeal Life Support Organization. Extracorporeal membrane oxygenation support in COVID-19: an international cohort study of the Extracorporeal Life Support Organization registry. *Lancet*. 2020;396(10,257):1071–1078.
2. Combes A, Peek GJ, Hajage D, et al. ECMO for severe ARDS: systematic review and individual patient data meta-analysis. *Intensive Care Med*. 2020;46(11):2048–2057.
3. Thongprayoon C, Cheungpasitporn W, Lertjitbanjong P, et al. Incidence and Impact of Acute Kidney Injury in Patients Receiving Extracorporeal Membrane Oxygenation: A Meta-Analysis. *J Clin Med*. 2019;8(7):981.

4. Haneya A, Diez C, Philipp A, et al. Impact of Acute Kidney Injury on Outcome in Patients With Severe Acute Respiratory Failure Receiving Extracorporeal Membrane Oxygenation. *Crit Care Med.* 2015;43(9):1898–906.
5. Antonucci E, Lamanna I, Fagnoul D, et al. The Impact of Renal Failure and Renal Replacement Therapy on Outcome During Extracorporeal Membrane Oxygenation Therapy. *Artif Organs.* 2016;40(8):746–54.
6. Delmas C, Zapetskaia T, Conil JM, et al. 3-month prognostic impact of severe acute renal failure under veno-venous ECMO support: Importance of time of onset. *J Crit Care.* 2018;44:63–71.
7. Instituto de Ensino e Pesquisa, IEP, Hospital Sírio-Libanês, Sao Paulo, Brazil

Topic: Acute Kidney Injury and haemofiltration

000822

Fluid responsiveness requires context: Coexistence of fluid responsiveness and fluid intolerant states in critically ill patients

F. Muñoz¹, P. Born¹, C. González¹, M. Bruna², R. Ulloa³, V. Philp¹, R. Mondaca¹, J. P. Blanco¹, J. Bakker⁴, F. Miralles⁵, P. Rola⁶, E. D. Valenzuela Espinoza¹, G. Hernandez¹, R. Castro¹, G. A. Ospina-Tascón⁷, E. Kattan¹

¹Departamento de Medicina Intensiva, Pontificia Universidad Católica de Chile, Santiago, Chile; ²Unidad de Cuidados Intensivos, Quilpué Hospital, Quilpué, Chile; ³Unidad de Cuidados Intensivos, Hospital las Higueras, Talcahuano, Chile; ⁴Department of Intensive Care Adults, Erasmus University Medical Center, Rotterdam, Netherlands; ⁵Anesthesia & Surgery Critical Care Service, Hospital Universitario Puerta del Mar, Cádiz, Spain; ⁶Critical care, Santa Cabrini hospital, CIUSSS EMTL, Montreal, Canada; ⁷Department of intensive care, Fundacion Valle del Lili, Cali, Colombia

Correspondence: F. Muñoz

Intensive Care Medicine Experimental 2023, **11(Suppl 1)**:000822

Introduction: Fluid responsiveness (FR) is frequently assessed to guide fluid administration in order to optimize the hemodynamic state of critically ill patients. However, fluid overload is associated with higher mortality, acute kidney injury, and prolonged duration of mechanical ventilation. The novel concept of fluid intolerance (FI) integrates hemodynamic, echographic, and clinical signals to identify the deleterious effects of fluids during the resuscitation process. However, the degree of FR and FI signals coexistence has yet to be established.

Objectives: To describe the coexistence of FR and FI signals in mechanically ventilated critically ill patients within the first 24 h since ICU admission.

Methods: A multicenter prospective observational study was performed at Hospital Clínico UC Christus and Hospital de Quilpué, Chile. The study was approved by the local IRB's. Mechanically ventilated patients > 18 years, requiring vasopressor treatment, an ICU stay < 24 h, and adequate echographic windows were consecutively recruited and assessed at a single time point. Measurements included demographics, hemodynamics, tissue perfusion, FR and FI status. FI was defined by the presence of any of the following: CVP > 12 mmHg, Venous excess ultrasound score (VExUS) equal to or higher than 1, Lung ultrasound score > 10, and E/e' ratio > 10. Results are shown as median [IQR] or n(%). Mann–Whitney U or Fisher's exact test were used when appropriate. A $p < 0.05$ was considered statistically significant.

Results: 50 patients were included, of which 52% were female. Diagnosis: sepsis 34%, neurocritical disease 12%, respiratory failure 22%, hemorrhagic shock 10%, post surgery 16%, other 6%. Age 59 [42–69] y, SOFA score 9 [7–11], and APACHE-II score 16 [11–20]. At recruitment, patients had a fluid balance of 1300 [100–3247] ml, norepinephrine requirements of 0.1 [0.07–0.15] mcg/kg/min, lactate 1.6 [1.1–3.7] mmol/L and CRT 3 [2–4] s.

To test FR, pulse pressure variation was used in 82%, stroke volume variation in 8% and passive leg raising against velocity time integral (VTI) in 8% of cases. 46% of the study population was categorized as Fluid Responsive (FR+). FR+ and FR– had a similar fluid balance (1929 [531–4913] ml vs 1205 [89–2865] ml ($p = 0.5$), respectively). As seen in Fig 1, the presence of at least one signal of FI was similar in FR+ and FR– groups (60% vs 55%, $p = 0.7$). 30% of FR+ patients had an altered VExUS score, while 41% in the FR– group ($p = 0.4$). Echocardiographic LV and RV function was similar in both groups (FAC 67 [48–70.5] % vs 65.8 [56–74.75] %, $p = 0.38$), (TAPSE 19 [18–25] vs 23 [19–25], $p = 0.15$). **Conclusions:** Fluid intolerance signals are present in both fluid responsive and unresponsive patients. In FR+ patients, contextualization of fluid challenges according to FI signals might avoid potential harm. Further studies should assess the clinical relevance of these results and the impact of personalized fluids resuscitation strategies.

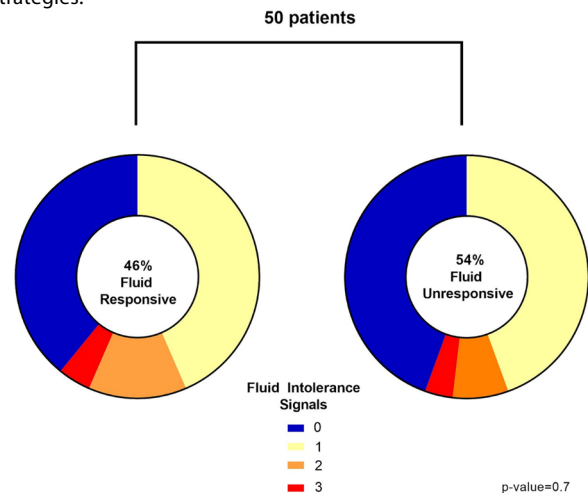

Fig. 1 (abstract 000822) Distribution of fluid intolerance signals in both fluid responsive and fluid unresponsive groups

References

1. Leidi A, Soret G, Mann T, Koegler F, Coen M, Leszek A, et al. Eight versus 28-point lung ultrasonography in moderate acute heart failure: a prospective comparative study. *Intern Emerg Med.* 2022;17:1375–83.
2. De Backer D, Vincent JL. Should we measure the central venous pressure to guide fluid management? Ten answers to 10 questions. *Crit Care.* 2018;23:22.
3. Suárez JC, López P, Mancebo J, Zapata L. Disfunción diastólica en el paciente crítico. *Medicina Intensiva.* 2016;40: 499–510.
4. Kattan E, Ospina-Tascón GA, Teboul JL, Castro R, Cecconi M, Ferri G, et al. Systematic assessment of fluid responsiveness during early septic shock resuscitation: Secondary analysis of the ANDROMEDA-SHOCK trial. *Crit Care.* 2020;23:1.
5. De Backer D, Aissaoui N, Cecconi M, Chew MS, Denault A, Hajjar L, et al. How can assessing hemodynamics help to assess volume status? *Intensive Care Med.* 2022;38:1482–94.
6. Bakker J, Kattan E, Annane D, Castro R, Cecconi M, De Backer D, et al. Current practice and evolving concepts in septic shock resuscitation. *Intensive Care Med.* 2022;48:148–63.
7. Payen D, de Pont AC, Sakr Y, Spies C, Reinhart K, Vincent JL. A positive fluid balance is associated with a worse outcome in patients with acute renal failure. *Crit Care.* 2008;4:12.

8. Kattan E, Castro R, Miralles-Aguier F, Hernández G, Rola P. The emerging concept of fluid tolerance: A position paper. *J Crit Care.* 2022;71.
9. Monnet X, Malbrain MLNG, Pinsky MR. The prediction of fluid responsiveness. *Intensive Care Med.* 2022;3:1
10. Concurso Becario Residente DIEMUC N° PB03-23, PUC
11. FONDECYT Regular Grant N°1230475, ANID

Topic: Cardiovascular issues in ICU

000823

Hand hygiene compliance at intensive care units in Iraq

A. S. J. Al-Allawee¹, Y. Kim², L. A. Hakeem³, J. Jung², J. Choi², B. Yoo⁴
¹Vice Director, Baghdad Teaching Hospital, Baghdad, Iraq; ²International Project Corps., Soonchunhyang University Seoul Hospital, Seoul, Republic of Korea; ³Intensive Care Unit, Ghazi Al-Hariri Hospital For Surgical Specialties, Baghdad, Iraq; ⁴Department of Family Medicine, Soonchunhyang University Seoul Hospital, Seoul, Republic of Korea.

Correspondence: A.S.J. Al-Allawee
Intensive Care Medicine Experimental 2023, **11(Suppl 1)**:000823

Introduction: The incidence of Hospital Acquired Infection (HAI) is high in intensive care units (ICUs) and HAI adversely affects the prognosis of the patient. Hand hygiene (HH) is the most effective and economic way to prevent HAI. HH is more important in countries with limited medical resources such as Iraq. This study was conducted to find improvements from the survey of HH at ICUs in Iraq.

Methods: The Iraq Medical City and Soonchunhyang University Medical Center has performed survey of the project supported by Korea International Cooperation Agency on HH compliance at ICUs (32beds) in Iraq Medical City from from. Survey materials were developed based on the World Health Organization Guideline. The survey on knowledge and perception of HH and hand contamination test was conducted. Based on hand plate criteria, hand contamination was classified into low (1–9 Colony Forming Unit, CFU) and high (> 10 CFU) groups. The HH compliance monitoring was performed by direct observation. Whether to perform only hand rub or wash is expressed as “compliance (yes/no)”, and in all 6 steps as “compliance(yes and 6 steps)”.

Results: The level of HH knowledge and perception of 30 health workers at ICUs were 55.8 ± 10.5 and 58.0 ± 29.0, respectively. In the low hand contamination group, knowledge and perception scores were high, but only perception scores were statistically significant (60.0 ± 0.0 vs 55.3 ± 11.0, P = 0.42, 82.7 ± 12.9 vs 55.3 ± 29.1, P = 0.03). Of 125 cases, compliance (yes/no) was 83%, but compliance (yes and 6 steps) was 18%. Technicians had the lowest rate of compliance (yes/no) (70%) and a compliance (yes and 6 steps) of physical therapist, technician and janitor was 0%. Among the 6 steps of HH procedure, the fingertips (30%) was the lowest.

Conclusions: This study is meaningful to understand the current status of HH activities at ICUs in Iraq. Overall hand hygiene knowledge and perceptions and the 6 step hand hygiene compliance were low. In the future, there will be a need for training and monitoring with a focus on these areas.

Table 1 (abstract 000823) Result of HH knowledge and perception score by Low and high CFU

	Total (N=30)	Low(1-9) CFU (N=3)	High(>9) CFU (N=27)	P-value
HH knowledge	55.8 ± 10.51	60.0 ± 0.0	55.3 ± 11.0	0.42
HH perception	58.02 ± 29.02	82.7 ± 12.9	55.3 ± 29.1	0.03

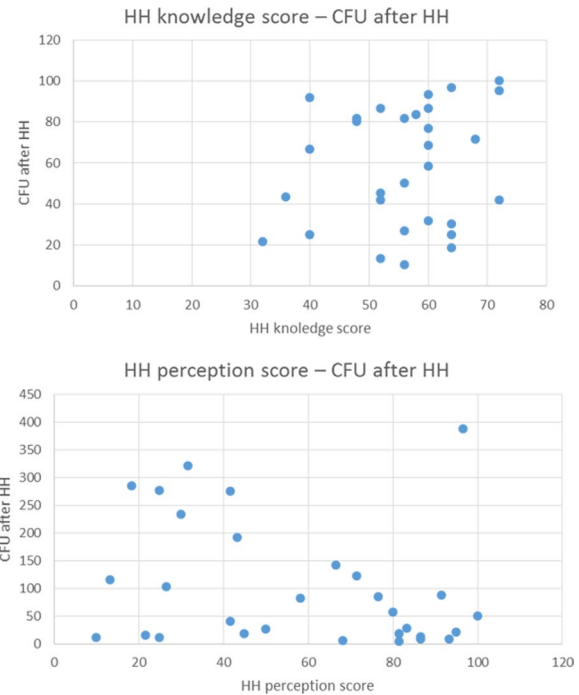

Figure 1 (abstract 000823) Scatter plot between knowledge score, perception score and CFU afer HH

	Variable	Compliance	
		N	%
Overall compliance	Compliance (yes/no only) (N=125)		
	Yes	104	83%
	Compliance (yes and 6 steps) (N=104)		
	Yes	19	18%
Compliance by profession	Compliance (yes/no only) (N=125)		
	Nurse (N=69)	58	84%
	Resident doctor (N=13)	8	62%
	Specialist doctor (N=6)	5	83%
	Pharmacist (N=7)	7	100%
	Physical therapist (N=6)	5	83%
	Technician (N=10)	7	70%
	Janitor (N=4)	4	100%
	Other (N=10)	10	100%
		Compliance (yes and 6 steps) (N=104)	
	Nurse (N=69)	13	19%
	Resident doctor (N=13)	1	8%
	Specialist doctor (N=6)	2	33%
	Pharmacist (N=7)	2	29%
	Physical therapist (N=6)	0	0%
	Technician (N=10)	0	0%
	Janitor (N=4)	0	0%
	Other (N=10)	1	10%
WHO's 5 Moments	Before patient contact	36	35%
	Before aseptic procedure	15	14%
	After body fluid exposure	17	16%
	After patient contact	16	15%
	After patient surrounding contact	20	19%
6 steps HH compliance	Palm to palm	100	96%
	Palm over dorsum	81	78%
	Finger interlaced	65	63%
	Finger interlocked	52	50%
	Thumb	41	39%
	Finger tips	31	30%

Table 2 (abstract 000823) Result of hand hygiene compliance

References

- Stephanie Dancer, Importance of the environment in meticillin-resistant *Staphylococcus aureus* acquisition: The case for hospital cleaning, *Lancet Infect Dis* 2008;8: 101–13
- Kirk Huslage, RN, BSN, MSPH; William A. Rutala, PhD, MPH; Emily Sickbert-Bennett, PhD; David J. Weber, MD, MPH, A Quantitative Approach to Defining “High-Touch” Surfaces in Hospitals, *Infection Control and Hospital Epidemiology*, Vol. 31, No. 8 (August 2010), pp. 850–853
- This research has been supported by Korea International Cooperation Agency.

Topic: Infections and prevention

000824

Physiologic effects of adding pressure support during a spontaneous breathing trial

R. Basoalto¹, L. Damiani², V. Oviedo¹, MC. Bachmann¹, P. Garcia², L. Alegria¹, G. Buggedo¹, J. Retamal¹, Y. Jalil¹, A. Bruhn¹¹Departamento de Medicina Intensiva, Pontificia Universidad Católica de Chile, Santiago, Chile; ²Departamento Ciencias de la Salud, Carrera de Kinesiología, Facultad de Medicina, Pontificia Universidad Católica de Chile, Santiago, Chile

Correspondence: R. Basoalto

Intensive Care Medicine Experimental 2023, **11(Suppl 1)**:000824

Introduction: Spontaneous breathing trials (SBT) may be performed with or without pressure support (PS). Although previous studies have shown that SBT performed with PS and/or PEEP may decrease respiratory effort compared to T-piece, no study has performed a comprehensive evaluation of the physiological effects of inspiratory PS during a SBT.

Objectives: To determine the physiological effects of adding inspiratory PS during a SBT in critically ill patients.

Methods: This was a prospective physiological study approved by the Institutional Scientific Ethics Committee of Pontificia Universidad Católica de Chile. Inclusion criteria were age > 18 years, mechanical ventilation (MV) for at least 48 h for an acute respiratory failure (PaO₂/FiO₂ < 300 mmHg), and whose attending physician planned to perform a SBT. Informed consent was obtained from the legal guardian. Before performing the SBT, a catheter with esophageal and gastric balloons, and electrodes to record the electrical activity of the diaphragm (EAdi), was placed (Neurovent Research Inc). In addition, an electrical impedance tomography (EIT) belt was placed around the chest (Enlight, Timpel). All patients underwent a SBT with positive end-expiratory pressure (PEEP) of 0 cmH₂O and PS of 0 cmH₂O for 30 min, after which the PS was increased to 8 cmH₂O for another 30 min. At the end of each phase waveforms from esophageal and transdiaphragmatic pressures, EAdi, and EIT were analyzed together with usual clinical signs and arterial and venous blood gases.

Results: Fifteen patients (6 female) aged 59 ± 15 years were included. Patients had been on MV for 7 ± 3 days. Inspiratory PS significantly reduced the work of breathing, demonstrated by a decrease in esophageal pressure swings and pressure-time product per minute of 48% (p = < 0.0001) and 45% (p = < 0.0001), respectively. Furthermore, PS significantly reduces respiratory rate (p = 0.004) and rapid shallow breathing index (RSBI) (p = 0.002) and redistributed ventilation towards non-dependent areas, demonstrated by the increased anterior-to-posterior ventilation ratio (p = 0.001). On the other hand, respiratory drive also decreased, demonstrated by a reduction in EAdi (p = 0.038) and P0.1 (p = 0.0001). However, no differences were found in tidal volume, minute ventilation, gas exchange, hemodynamics, or cardiovascular stress biomarkers.

Variable	SBT: PEEP 0 PS 0	SBT: PEEP 0 PS 8	P value
ΔPes, cmH ₂ O	7.98 [5.7–12.1]	3.81 [2.1–8.7]	< 0.0001
PTPmin, cmH ₂ O.s/ min	141 [103–269]	63 [33–156]	< 0.0001

Variable	SBT: PEEP 0 PS 0	SBT: PEEP 0 PS 8	P value
Pdi, cmH ₂ O	8.04 [6.2–10.7]	5.24 [3.1–8.4]	0.0010
Respiratory rate, bpm	26 ± 6	22 ± 5	0.0044
Tidal Volume, ml	370 [321–525]	437 [362–488]	0.1793
RSBI	67 ± 25	53 ± 19	0.0028
ΔEAdi, μV	12 [7.0–16.0]	7 [4.2–14.0]	0.0389
Pdi/ΔEAdi cmH ₂ O/μV	0.74 [0.58–1.26]	0.67 [0.59–1.36]	0.2661
ΔEELIglob, UA	− 6.5 [− 20.9–2.1]	− 5.1 [− 18.5–8.3]	0.5016
A/P Ratio	0.51 ± 0.29	0.76 ± 0.39	0.0011
PaO ₂ /FiO ₂ , mmHg	219 [209–272]	229 [203–250]	0.2952
PaCO ₂ , mmHg	39 [36–43]	37 [34–39]	0.0840
pH	7.43 [7.41–7.47]	7.46 [7.44–7.46]	0.1055
P 0.1	0.9 [0.5–1.7]	0.5 [0.3–0.85]	0.0001
SvcO ₂ , %	77 ± 7	76 ± 5	0.9102
Mean arterial pressure	99 ± 15	99 ± 18	0.7515
Heart rate, bpm	90 ± 14	87 ± 14	0.1875
NT-proBNP, pg/ml	271 [120–369]	260 [117–365]	0.9999
Troponin C, pg/ml	12.6 [6.9–28.4]	11.9 [6.8–29.1]	0.6250

Conclusions: Increasing inspiratory support from 0 to 8 cmH₂O during a spontaneous breathing trial in patients with acute respiratory failure reduces the work of breathing and respiratory drive, while also increasing dynamic lung compliance.

References

- Subirà C, et al. Effect of Pressure Support vs T-Piece Ventilation Strategies During Spontaneous Breathing Trials on Successful Extubation Among Patients Receiving Mechanical Ventilation: A Randomized Clinical Trial. *JAMA*. 2019 Jun 11;321(22):2175–2182
- Sklar MC, et al. Effort to Breathe with Various Spontaneous Breathing Trial Techniques. A Physiologic Meta-analysis. *Am J Respir Crit Care Med*. 2017 Jun 1;195(11):1477–1485.
- FONDECYT N° 1191709
- CONICYT-PFCHA/Doctorado Nacional 2020-folio 21201751

Topic: Acute respiratory failure and mechanical ventilation

000826

Association between single lactate level and lactate dynamics, and neurological outcome in out-of-hospital arrest (OHCA) patients treated with TTM

J. Lee¹¹Emergency Medicine, The Catholic University of Korea Seoul St. Mary's Hospital, Seoul, Republic of Korea

Correspondence: J. Lee

Intensive Care Medicine Experimental 2023, **11(Suppl 1)**:000826

Introduction: Lactate is a product of pyruvate reduction during glycolysis. Increased serum lactate levels in cardiac arrest patients are attributed to anaerobic glycolysis due to tissue hypoxia. Therefore, the level of lactate and lactate clearance rate are likely to be associated with cardiac arrest outcomes. However, the prognostic values of these lactate-related variables on neurological outcomes have not been consistent among different clinical studies.

Objectives: We aim to evaluate the association between serum lactate variables and long-term neurological outcome, and their interactions with cardiac arrest etiology and arrest rhythm.

Methods: This retrospective observational study based on a prospectively collected registry of out-of-cardiac arrest (OHCA) patients was conducted in a single tertiary hospital from February 2009 to September 2022. During the study period, serum lactate levels were serially measured at 0, 12 and 24 h after return of spontaneous

circulation (ROSC). We also calculated lactate clearance ($(\text{lactate level at 0 h} - \text{lactate level at 12 or 24 h}) / \text{lactate level at 0 h} \times 100$) and the time-weighted mean lactate as a marker of cumulative lactate production over time. The primary outcome was poor neurologic outcome (Cerebral Performance Category 3–5) after 6 months. Prognostic performance was assessed by the area under the receiver operating characteristic (ROC) curve (AUC), and the adjusted odds ratios (ORs) of poor neurologic outcomes were calculated in variables multivariate logistic regression models. Interactions between lactate variables and cardiac arrest etiology and arrest rhythm were evaluated by subgroup analysis.

Results: Among the 413 patients with TTM after OHCA, a total of 351 patients were included in this study. After 6 months, 122 patients exhibited a good neurological outcome and 229 patients exhibited a poor outcome. Serum lactate levels at all time points and time-weighted mean lactate levels in the poor outcome group were higher than those in the good outcome group (all p -values < 0.001). Lactate clearance statistically differed between outcome groups at 24 h, but not at 12 h ($p = 0.708$). ROC analysis revealed that serum lactate levels at 0 h, 12 h and 24 h, time-weighted mean lactate, and lactate clearance at 12 h and 24 h had an AUC of 0.68 (95% confidence interval [CI], 0.63–0.73), 0.68 (95% CI, 0.63–0.73), 0.77 (95% CI, 0.72–0.81), 0.74 (95% CI, 0.69–0.78), 0.52 (95% CI, 0.47–0.58) and 0.61 (95% CI, 0.55–0.66), respectively. In multivariate models, higher serum lactate levels at all time points were associated with poor neurologic outcome (OR 1.09 [95% CI, 1.02–1.16], OR 1.16 [95% CI, 1.03–1.30], and OR 1.38 [95% CI, 1.17–1.63], respectively), whereas among lactate dynamics, time-weighted mean lactate was only an independent predictor of neurologic outcome (OR 1.29 [95% CI, 1.12–1.49]). AUCs of single lactate levels and lactate dynamics in OHCA with non-cardiac etiology and non-shockable rhythm were higher than those with cardiac etiology and shockable rhythm.

Conclusions: Single lactate levels, particularly at 24 h following ROSC and time-weighted mean lactate level during 24 h were independent predictors of neurologic outcome in OHCA patients treated with TTM. However, lactate clearance was not associated with neurologic outcome. The prognostic ability of these lactate-related variables varies depending on the etiology of cardiac arrest and the initial rhythm.

References

1. The author(s) received no financial support for the research and authorship of this article.
2. Kokulu, K., & Sert, E. T. (2021, December). The role of the lactate/albumin ratio in predicting survival outcomes in patients resuscitated after out-of-hospital cardiac arrest: A preliminary report. *The American Journal of Emergency Medicine*, 50, 670–674. doi: <https://doi.org/10.1016/j.ajem.2021.09.059>
3. Nishioka, N., Kobayashi, D., Izawa, J., Kiguchi, T., Kitamura, T., Kawamura, T., & Iwami, T. (2019, November 19). Abstract 24: Association Between Serum Lactate During Cardiopulmonary Resuscitation and Survival in Adult Out-Of-Hospital Cardiac Arrest: A Multicenter Cohort Study (The Critical Study in Osaka, Japan). *Circulation*, 140(Suppl_2). doi: https://doi.org/10.1161/circ.140.suppl_2.24
4. Laurikkala, J., Skrifvars, M. B., Bäcklund, M., Tiainen, M., Bendel, S., Karhu, J., Varpula, T., Vaahersalo, J., Pettilä, V., & Wilkman, E. (2019, February). Early Lactate Values After Out-of-Hospital Cardiac Arrest: Associations With One-Year Outcome. *Shock*, 51(2), 168–173. doi: <https://doi.org/10.1097/shk.0000000000001145>
5. Zhou, B. C., Zhang, Z., Zhu, J. J., Liu, L. J., & Liu, C. F. (2018, October 2). Blood Lactate or Lactate Clearance: Which Is Robust to Predict the Neurological Outcomes after Cardiac Arrest? A Systematic Review and Meta-Analysis. *BioMed Research International*, 2018, 1–11. doi: <https://doi.org/10.1155/2018/8014213>
6. Hayashida, K., Suzuki, M., Yonemoto, N., Hori, S., Tamura, T., Sakurai, A., Tahara, Y., Nagao, K., Yaguchi, A., & Morimura, N. (2017, June). Early Lactate Clearance Is Associated With Improved Outcomes in Patients With Post-cardiac Arrest Syndrome. *Critical Care Medicine*, 45(6), e559–e566. doi: <https://doi.org/10.1097/ccm.0000000000002307>

Topic: Cardiac arrest

000828

The effect of the academic turnover on the clinical outcomes of the sepsis patients

S. Lee¹, H. Kim¹, W. Kim¹, K. Sungjin¹, S. Ahn¹, J. Park¹, H. Cho¹

¹Emergency Department, Korea University Ansan Hospital, Jeokgeum-ro, Danwon-gu, Ansan-si, Gyeonggi-do, South Korea, Ansan-si, Republic of Korea

Correspondence: S. Lee

Intensive Care Medicine Experimental 2023, **11(Suppl 1)**:000828

Introduction: Many studies have been conducted on the effect of the academic turnover period. Little has been studied on whether there is a turnover effect in sepsis. It is important to recognize sepsis early and treat it appropriately according to the sepsis bundle. It can be assumed that the prognosis of sepsis patients will deteriorate if a doctor who lacks experience in turnover period quickly does not recognize sepsis and the proper treatment is delayed. We hypothesized that physician turnover has resulted in worse outcomes for sepsis patients admitted in the academic turnover period.

Methods: This study was performed at the general ED of a tertiary teaching hospital with an annual census of 50,000 patients. We used observational data from the prospectively collected sepsis registry from January 2018 to December 2021. In Korea, the post graduate medical education (PGME) consists of a one-year internship, followed by four years of residencies, and one or two years of fellowships. Most new trainees and staffs start their duty on March 1st. Therefore, March is referred to as the turnover period. Patients hospitalized in February were excluded from the analysis because the academic turnover period overlapped. The primary outcome was 30-day mortality. Secondary outcomes included Survival Sepsis Campaign (SSC) bundle adherence. The 30-day mortality, SSC bundle adherence, and hospitalization day were compared between the turnover period and the other periods.

Results: A total of 900 sepsis patients were included in the study, including 105 in the Turnover period. There was no significant difference in APACHE II score and SOFA score between the turnover period and non-turnover period. The 30-day mortality of patients in the turnover period was higher than in the non-turnover period (49.0% vs 28.1%, $p < 0.001$). However, there was no significant difference in SSC bundle adherence (41.9% vs 46.5%, $p = 0.405$). Multivariable Cox proportional hazard regression showed that the turnover period was associated with mortality in sepsis patients after adjusting for confounders (adjusted HR, 1.880; 95% CI 1.357–2.604). Length of ED stay, length of hospital stay, and length of ICU stay showed no significant difference.

Table 1 (abstract 000828) Multivariable Cox proportional hazard regression analysis of 30-day mortality

Variables	aHR (95% CI)	p-value
Age	1.025 (1.014–1.037)	< 0.001
Malignancy	1.724 (1.322–2.248)	< 0.001
Presence of Shock	1.476 (1.062–2.052)	0.021
SOFA Score	1.090 (1.043–1.139)	< 0.001
Initial Serum Lactate	1.119 (1.082–1.157)	< 0.001
Overall SSC Bundle Adherence	0.722 (1.357–2.604)	0.0136
Admission in Turnover Period	1.880 (1.357–2.604)	< 0.001

Conclusions: Academic turnover was associated with 30-day mortality in sepsis patients; however, SSC bundle adherence in the ED was not significantly different depending on the periods. These results suggested that the cause of the increase in mortality in the turnover period may be related to unmeasured in-hospital management. To our

knowledge, this is the first study to report a positive physician turnover effect in patients with sepsis.

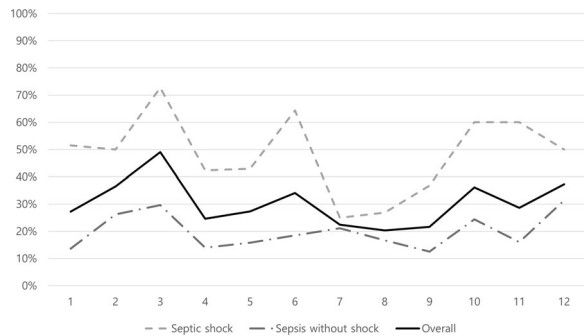

Figure 1 (abstract 000828) The monthly 30-day mortality rate of patients with sepsis who visited the hospital from 2018 to 2021

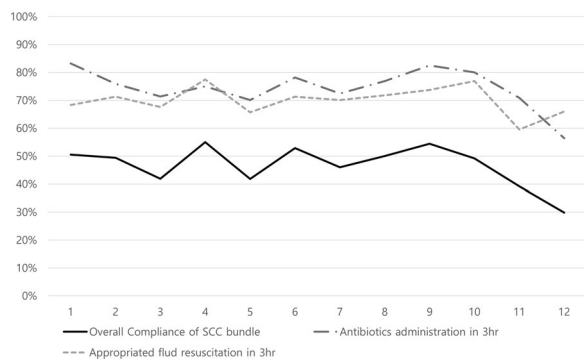

Figure 2 (abstract 000828) The monthly SSC bundle compliance rate of patients with sepsis who visited the hospital from 2018 to 2021

References

- Oh TK, Ji E, Cho Y-J, et al. (2018) Trainee physician turnover and 30-day mortality in Korean intensive care units. *Journal of Critical Care* 46:23–28. doi: <https://doi.org/10.1016/j.jcrc.2018.04.001>
- Saqib A, Ibrahim U, Patel P, et al. (2017) Mortality among high-risk patients admitted with septic shock to U.S. teaching hospitals in July: Does the 'July Effect' exist? *Heart & Lung* 46:110–113. doi: <https://doi.org/10.1016/j.hrtlng.2017.01.010>
- Jen MH, Bottle A, Majeed A, et al. (2009) Early In-Hospital Mortality following Trainee Doctors' First Day at Work. *PLOS ONE* 4:e7103. doi: <https://doi.org/10.1371/journal.pone.0007103>
- Zogg CK, Metcalfe D, Sokas CM, et al. (2022) Reassessing the July Effect: 30 Years of Evidence Show No Difference in Outcomes. *Annals of Surgery*. doi: <https://doi.org/10.1097/SLA.0000000000004805>
- Singer M, Deutschman CS, Seymour CW, et al. (2016) The Third International Consensus Definitions for Sepsis and Septic Shock (Sepsis-3). *JAMA* 315:801–810. doi: <https://doi.org/10.1001/jama.2016.0287>
- Nothing to declare

Topic: Sepsis

000831

Acute respiratory distress syndrome (ARDS) vs COVID-19-associated ARDS (CARDS): clinical characteristics and outcomes in a cohort of Mexican patients

A. Esquivel Pineda¹, P. Palacios Moguel¹, J. S. Aguirre-Sanchez¹, B. A. Martinez Diaz¹

¹Intensive Care Unit, ABC Medical Center, Ciudad de México, Mexico

Correspondence: A. Esquivel Pineda

Intensive Care Medicine Experimental 2023, 11(Suppl 1):000831

Introduction: Classic ARDS exhibit similarities to CARDS, however, it is the latter that has a rapid progression and multiorgan involvement leading to high rates of fatal outcomes. Despite the fact that the start of the COVID-19 pandemic was 4 years ago, there are no comparative studies on ARDS in the Mexican population. We investigated and compared the clinical, echocardiographic and laboratorial outcomes in a cohort of critical patients hospitalized with CARDS and ARDS at a single hospital center.

Objectives: To assess and establish a relationship between the clinical, echocardiographic and laboratorial characteristics and describe the outcomes associated with mortality in CARDS and ARDS critical care patients.

Methods: We conducted a comparative, observational, retrospective study in the ICU of a third-level hospital in Mexico City from March 2020 through March 2022. Clinical, echocardiographic, and laboratory variables were compared between patients with CARDS and those with ARDS due to other etiology. A univariate analysis of selected factors and outcomes was performed, the statistical analysis was prepared in SPSS v.21.

Results: We enrolled 140 patients with a diagnosis of ARDS. The study group of COVID-19 etiology were younger males, higher body mass index, progressed to organ failure, required more frequently renal replacement therapy, and had higher SOFA score. There was no difference in rates of right ventricular dysfunction evaluated by echocardiography.

Table 1 (abstract 000831) Patient characteristics by group

Characteristic	ARDS (n=61)	CARDS (n=79)	p
Sex a	34 (55.7)	62 (78.5)	<0.01
Male	27 (44.3)	17 (21.5)	
Female			
Age a	72 (25–97)	64 (32–89)	0.03
Weight (kg) b	70 (36–130)	80 (44–127)	<0.01
BMI (kg/m ²) b	24.56 (13–43)	27.34 (18–43)	<0.01
SAPS-II score b	32 (6–70)	36 (10–89)	0.07
APACHE-II score b	13 (0–30)	14 (5–38)	0.68
SOFA score b	5 (0–9)	8 (2–18)	0.01
RV failure a	4 (6.6)	5 (6.3)	0.95
Mechanical Ventilation a	22 (36.1)	78 (98.7)	<0.01
Renal Replacement Therapy a	3 (4.9)	13 (16.5)	0.02
ECMO a	0	1 (1.3)	0.37
Duration of Mechanical Ventilation b	0.88 (0–18)	13 (0–64)	<0.01
Days in Critical Care Unit b	2 (0–30)	17 (1–68)	<0.01
In-hospital stay b	6 (1–31)	22 (1–68)	<0.01
Death a	12 (19.7)	33 (41.8)	<0.01

Data presented as: a total of patients (%), b median (interquartile range).

Table 2 (abstract 000831) Outcomes associated with mortality

Outcomes	ARDS (n=12)	CARDS (n=33)	p
Mechanical ventilation a	9 (75)	33 (100)	<0.01
Renal replacement therapy a	1 (8.3)	13 (39.3)	0.04
RV dysfunction a	2 (16.7)	2 (6.1)	0.26

Outcomes	ARDS (n = 12)	CARDS (n = 33)	p
Length of mechanical ventilation b	1 (43.7)	22 (52)	< 0.01
ICU length of stay b	1 (28.1)	28 (47.9)	< 0.01
In-Hospital length of stay b	6 (31.8)	29 (46)	< 0.01

Data presented as: a total of patients (%), b mean (standard deviation). **Conclusions:** In our population CARDS showed higher morbidity and mortality compared to ARDS. The need and duration of MV, length of stay, need of renal replacement therapy and mortality all were higher in the CARDS group, similar to global findings. An outstanding difference to the reported studies in other countries was the lack of risk for right ventricle dysfunction.

References

- Fan, E., Beitler, J. R., Brochard, L., Calfee, C. S., Ferguson, N. D., Slutsky, A. S., & Brodie, D. (2020). COVID-19-associated acute respiratory distress syndrome: is a different approach to management warranted?. *The Lancet. Respiratory medicine*, 8(8), 816–821.
- Li, X., & Ma, X. (2020). Acute respiratory failure in COVID-19: is it "typical" ARDS?. *Critical care (London, England)*, 24(1), 198.
- Xu, Z., Shi, L., Wang, Y., Zhang, J., Huang, L., Zhang, C., Liu, S., Zhao, P., Liu, H., Zhu, L., Tai, Y., Bai, C., Gao, T., Song, J., Xia, P., Dong, J., Zhao, J., & Wang, F. S. (2020). Pathological findings of COVID-19 associated with acute respiratory distress syndrome. *The Lancet. Respiratory medicine*, 8(4), 420–422.
- Marini, J. J., & Gattinoni, L. (2020). Management of COVID-19 Respiratory Distress. *JAMA*, 323(22), 2329–2330.
- Mahida, R. Y., Chotalia, M., Alderman, J., Patel, C., Hayden, A., Desai, R., Beesley, E., Crowley, L. E., Soltan, M., Bangash, M., Parekh, D., Patel, J., & Thickett, D. R. (2020). Characterisation and outcomes of ARDS secondary to pneumonia in patients with and without SARS-COV-2: A single-centre experience. *BMJ Open Respiratory Research*, 7(1).
- ARDS Definition Task Force, Ranieri, V. M., Rubenfeld, G. D., Thompson, B. T., Ferguson, N. D., Caldwell, E., Fan, E., Camporota, L., & Slutsky, A. S. (2012). Acute respiratory distress syndrome: the Berlin Definition. *JAMA*, 307(23), 2526–2533.
- The authors received no financial support for the research, authorship, and/or publication of this abstract.

Topic: Acute respiratory failure and mechanical ventilation

000833

Serum levels of interleukin 6 in patients with sepsis

R. Dominguez Perez¹, MF. Betanzos Castillo²

¹UTI, Hospital San Ángel Inn Patriotismo, Ciudad de México, Mexico;

²Emergency, Hospital San Ángel Inn Patriotismo, Ciudad de México, Mexico

Correspondence: R. Dominguez Perez

Intensive Care Medicine Experimental 2023, **11(Suppl 1)**:000833

Introduction: Some cytokines including IL-6, IL-1, IL8 and TNF- α are important activators of the acute phase inflammatory response. Several biomarkers have been described, such as procalcitonin and CRP related to the severity of sepsis, however they have low sensitivity and specificity. Serum IL-6 level have been reported in healthy people ranging from 0.1–9.7 pg/mL. Elevated serum IL-6 values have been reported in patients with sepsis and septic shock. In critically ill patients, particularly with septic shock, they may exceed 1000 pg/mL.

Objectives:

- Quantify the serum levels of interleukin 6 in patients with sepsis, septic shock and the control group (without infection) on admission to the intensive care unit.
- Associate serum interleukin 6 values with the severity of sepsis in the intensive care unit of Hospital Ángeles Mocel.
- To compare the serum levels of interleukin 6 in the different subgroups of patients with sepsis and septic shock taking into account the source of infection: respiratory, abdominal, urinary, neurological, and soft tissues.

- To identify, through ROC curve analysis, the value with the highest sensitivity and specificity of interleukin 6, in patients with sepsis.

Methods: A prospective, observational and descriptive study was conducted, from January 2021 to January 2022, including information on patients who were admitted to the critical unit of Hospital Ángeles Mocel and who met the following criteria; Indistinct gender, age over 18 years, and a minimum stay of 24 h with a diagnosis of sepsis or septic shock. 3 groups were analyzed; sepsis, septic shock and control.

Serum interleukin 6 values were measured within the first 24 h of admission to the intensive care unit. APACHE II and SOFA scores were calculated in all patients upon admission. The samples were analyzed by ELISA test in the laboratory of Hospital Ángeles Mocel. The statistical analysis was carried out, taking into account the quantitative and qualitative variables, the Excel professional and VassarStats programs were used for the analysis of the results and the graphs.

Results: Information from 32 patients was included. We identified that the mean value of interleukin 6 in the control group patients was 16.5 pg / mL, the sepsis group 103 pg/mL and the septic shock group 409 pg / mL ($p=0.012$).

The average values of interleukin 6 were analyzed in the different subgroups depending on the origin of the infectious focus. The highest value was reported in patients with abdominal sepsis (179 pg/mL) and abdominal septic shock (714 pg/mL).

The ROC curve for interleukin 6 showed that at values of 20 pg/mL, the sensitivity of IL-6 in the diagnosis of sepsis corresponds to 88% and the specificity to 85%, with a VPP of 96%.

Conclusions: Interleukin 6 is a biomarker with high sensitivity and specificity for the diagnosis of sepsis that could be used as a predictor of disease severity.

Our study is the first study in Mexico that quantifies serum levels of interleukin 6 in different subgroups of patients with sepsis and septic shock.

The main limitation of our study was the number of samples and the determination of interleukin 6 was performed in a single moment.

Graph 1. Box plot representing the serum levels of interleukin 6 in patients with sepsis, septic shock and control group of the ICU of the Hospital Angeles Mocel.

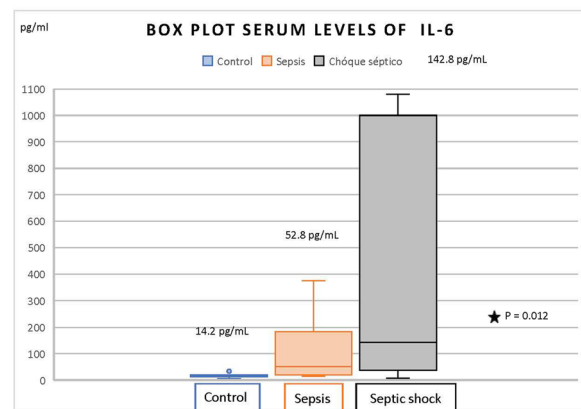

Box plot representing the serum interleukin 6 values (median, first and third quartile) in patients with sepsis, septic shock and control in the ICU of Hospital Angeles Mocel.

It was observed that the difference between the median of control and sepsis/septic shock patients is representative with a p value less than 0.05.(★).

Graph 1 (abstract 000833) .

Box plot representing the serum interleukin 6 values (median, first and third quartile) in patients with sepsis, septic shock and control in the ICU of Hospital Angeles Mocel

It was observed that the difference between the median of control and sepsis/septic shock patients is representative with a p value less than 0.05.()

Graph 2. Serum IL 6 values in the different subgroups of patients with sepsis and septic shock in the ICU of Hospital Angeles Mocel.

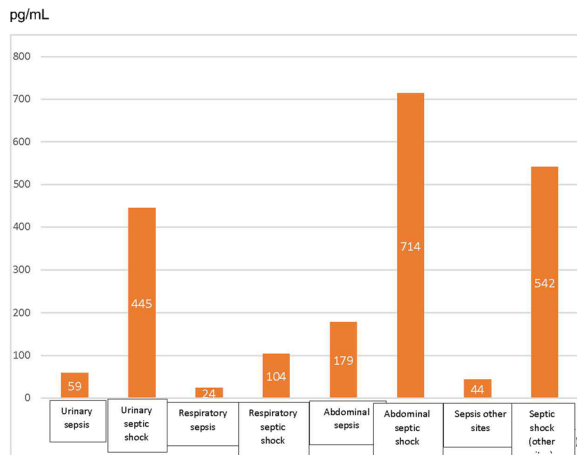

Bar graph that describes the serum levels of interleukin 6, in the different subgroups of patients with sepsis / septic shock; urinary, respiratory, abdominal, other sites (neurologic and soft tissue). The average value of interleukin 6 measured in pg/mL is represented within the bars.

Graph 2 (abstract 000833) .

Graph 3. ROC curve for interleukin 6 in patients with sepsis

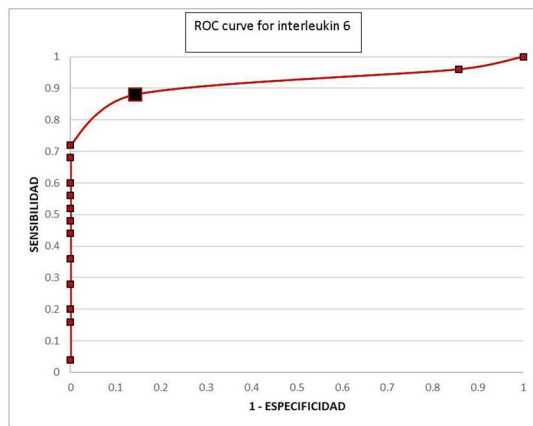

It was observed in the ROC CURVE that the point with the highest sensitivity was 20 pg/mL. Reported sensitivity of 88% and specificity of 85%.

Graph 3 (abstract 000833) .

References

- Journal of Critical Care (2011) 26, 54–64. Predictive value of procalcitonin, interleukin-6, and C-reactive protein for survival in postoperative patients with severe sepsis. *Journal of Critical Care* (2011) 26, 54–64. 2011;26(1):54–64.
- Marta Suárez-Santamaría, Francisco Santolaria, Alina Pérez-Ramírez. Prognostic value of inflammatory markers (notably cytokines and procalcitonin), nutritional assessment, and organ function in patients with sepsis. *Eur Cytokine Netw.* 2010;21(1):19–29.
- Molano Franco D, Arevalo-Rodriguez I, Roqué Figuls M, Zamora J. Interleukin-6 for diagnosis of sepsis in critically ill adult patients. *Cochrane Database of Systematic Review*. 2015;7:1–16.
- Savitri Kibe. KaG. Diagnostic and prognostic biomarkers of sepsis in critical care. *J Antimicrob Chemother.* 2011;66(2):33–40.
- Gotts, J. E., & Matthay, M. A. Sepsis: Pathophysiology and clinical management. *BMJ* 2016;353:i1585. 2016;353(1):1585–1590.
- Derek C. Angus, M.D., M.P.H., and Tom van der Poll, M.D., Ph.D. Severe sepsis and septic shock. *N Engl J Med.* 2013;369(9):840.
- Mervyn Singer, MD, FRCP, Clifford S. Deutschman, MD, MS, Christopher Warren Seymour. The third international consensus definitions for sepsis and septic shock (sepsis-3). *JAMA* February 23; 315(8): 801–810. 2016;315(8):801–810.
- José Ramón Mena-Ramírez¹ José Valdez-Euan² Carlos J Castro-Sansores¹ Germán Martínez-Díaz¹. Análisis de supervivencia en pacientes con choque séptico en una unidad de cuidados intensivos. *Med Int Méx* 2014; 2014;30:399–406.
- Zou Suhua, Zhang Lefeng*, Chen Qingli, Wu Yueying. The prognostic value of serum PCT, hs-CRP, and IL-6 in patients with sepsis. *Open Life Sci.* 2017;12:425–428.
- V. Miguel-Bayarria, *, E.B. Casanoves-Laparra, L. Pallás-Beneyto, S. Sancho-Chinestaa, L.F. Martín-Osorioa, et al. Valor pronóstico de los biomarcadores procalcitonina, interleukina 6 y proteína C reactiva en la sepsis grave. *Med Intensiva* 2012. 2012;36(8):556–562.

Topic: Sepsis

000834

Protein quantification platforms for use in critical care precision medicine trials: a scoping review

K. Reddy¹, C. McGrath¹, R. Dowding¹, M. Smit², V. Scaravilli³, J. Millar⁴, J. Kataoka⁵, L. Hays⁶, B. Blackwood¹, B. Connolly¹, D. McAuley¹

¹Wellcome Wolfson Institute for Experimental Medicine, Queen's University Belfast School of Medicine, Dentistry and Biomedical Sciences, Belfast, United Kingdom; ²Department of Intensive Care, Amsterdam UMC, locatie AMC, Amsterdam, Netherlands; ³Dipartimento di Anestesia, Rianimazione ed Emergenza-Urgenza, Policlinico di Milano, Milano, Italy; ⁴Department of Medicine, The University of Edinburgh, Edinburgh, United Kingdom; ⁵Intensive care medicine, Tokyo Bay Urayasu Ichikawa Medical Center, Urayasu, Japan; ⁶University College Dublin Clinical Research Centre, St. Vincent's University Hospital, Dublin, Ireland

Correspondence: K. Reddy

Intensive Care Medicine Experimental 2023, **11(Suppl 1)**:000834

Introduction: Critical care syndromes demonstrate significant underlying biological heterogeneity. To address this issue, researchers are increasingly using enrichment methods to identify putative treatment-responsive subphenotypes. A parsimonious model for the allocation of acute respiratory distress syndrome (ARDS) subphenotypes has been developed that utilises the plasma cytokines interleukin-6 (IL-6) and soluble tumour necrosis factor receptor 1 (sTNFR1) along with bicarbonate from an arterial blood gas. In order to use models

like this to guide treatment decisions, automated platforms that can quantify these plasma cytokines rapidly are needed. This scoping review aims to identify and collate data on such platforms as an aid to critical care researchers who are planning trials that stratify patients based on plasma biomarkers.

Methods: A protocol for this scoping review was previously published online (<https://doi.org/10.17605/OSF.IO/FU546>). Searches of MEDLINE, Embase, OpenGrey, and the Espacenet patent database were conducted. References relating to automated devices that could be used to quantitatively measure human proteins in the blood, plasma, or serum were included. "Proof of concept" studies, animal studies, and semi-quantitative assays were excluded. Screening was completed by two independent reviewers and disagreements were resolved with a third reviewer.

Results: 489 records met the inclusion criteria (Figure 1). 151 protein measurement devices across 59 manufacturers and several indications were identified. The most cited devices were the Cobas series (Roche, Basel, Switzerland), the ADVIA Centaur series (Siemens, Munich, Germany), the ARCHITECT series (Abbott Laboratories, Abbott Park, Illinois), the AU5800 (Beckmann-Coulter Inc, Pasadena, California), and the LUMIPULSE G1200 (Fujirebio, Tokyo, Japan). Together these comprise most high-throughput hospital laboratory immunoassay devices. All support IL-6 measurement following the COVID-19 pandemic. Multiplex devices supporting simultaneous cytokine measurements were also identified from 7 manufacturers: Ella (BioTechne, Minneapolis, Minnesota), Evidence series (Randox Laboratories, Crumlin, Northern Ireland), IMMULITE 2000 XPi (Siemens, Munich, Germany), AFIAS (BodiTech Med Inc, Chuncheon, South Korea), sqidlite (SQI Diagnostics, Toronto, Canada), READ (EnLiSense, Allen, Texas), and BV (MeMed, Tirat Carmel Park, Israel). All multiplex devices except the MeMed BV can quantify IL-6. The Randox multiSTAT (part of the Evidence series), the BioTechne Ella, and the sqidlite can quantify both IL-6 and sTNFR1.

Conclusions: Multiple automated protein quantification devices are available. Researchers should initially leverage existing multiplex devices for precision medicine trials in critical care. In future, as evidence mounts for critical care subphenotypes, more relevant analytes (such as sTNFR1) should be supported on large high-throughput laboratory analysers.

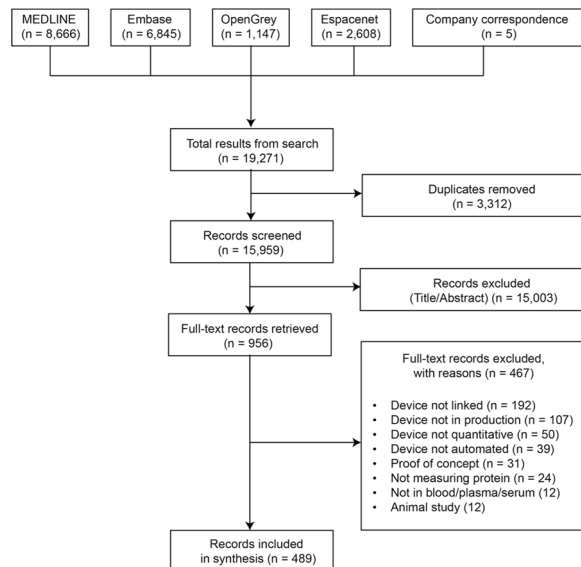

000836

Association between thigh muscle point-of-care ultrasound with panoramic view and mortality in sepsis in emergency department

S. Ahn¹, J. Bo-Yeong², H. Kim¹, J. Park¹, K. Sungjin¹, S. Lee¹, M. Sungwoo¹, H. Cho¹

¹Emergency Department, Korea University Ansan Hospital, Jeokgeum-ro, Danwon-gu, Ansan-si, Gyeonggi-do, South Korea, Ansan-si, Republic of Korea; ²Department of Biomedical Sciences, Seoul National University College of Medicine, Seoul, Republic of Korea

Correspondence: H. Kim

Intensive Care Medicine Experimental 2023, **11**(Suppl 1):000836

Introduction: Decreased muscle mass is associated with mortality and morbidity in various conditions including sepsis. This study aimed to investigate whether the measurement of thigh muscle mass using point-of-care ultrasound with panoramic view in sepsis patients in the emergency department is associated with mortality.

Methods: Between March 2021 to October 2022, this observational study included adult sepsis patients at the emergency department and who underwent lower extremity point-of-care ultrasounds. The cross-sectional area of the quadriceps femoris (CSA-QF) was measured on point-of-care ultrasound using panoramic view to evaluate thigh muscle mass. The primary outcome was 28-day mortality. Multivariable Cox proportional hazard model was performed.

Results: The study included 112 patients with sepsis, mean CSA-QF was significantly lower in the non-surviving group compared to surviving group (49.6 [34.3–56.5] vs. 63.2 [46.9–79.6] cm², $p=0.002$). Each cm² increase in the mean CSA-QF was independently associated with decreased risk of 28-day mortality (adjusted hazard ratio 0.961, 95% Confidence Interval (CI) 0.928–0.995, $p=0.026$) after adjusting for potential confounders. The area under the receiver operating characteristic curve of mean CSA-QF for 28-day mortality was 0.722 (95% CI 0.606–0.838, $p<0.001$). Additionally, each cm² increase in the mean CSA-QF was independently associated with decreased use of mechanical ventilator use within 24 h (adjusted odds ratio 0.95, 95% CI 0.92–0.99; $p=0.020$).

Conclusions: The measurement of quadriceps femoris mass using point-of-care ultrasound with panoramic view may be a promising tool for identifying risk factors for mortality in sepsis patients in the early stages of emergency department.

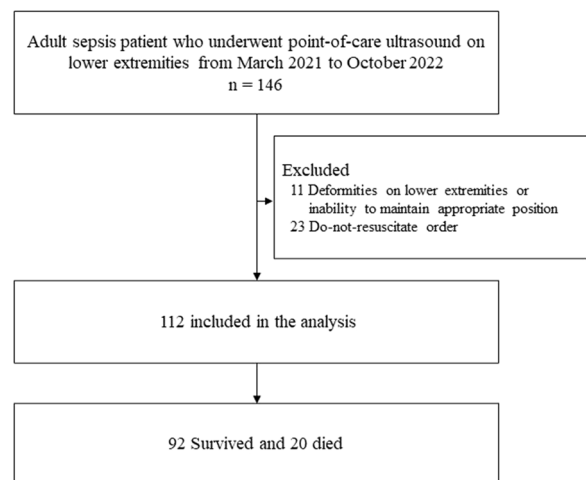

Figure 1 (abstract 000836) Flow diagram of the study population

Topic: Acute respiratory failure and mechanical ventilation

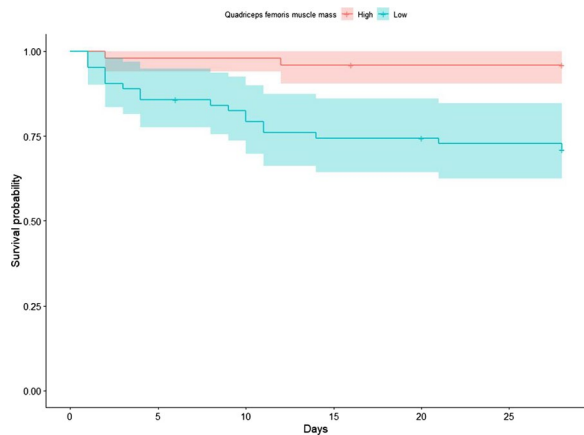

Figure 2 (abstract 000836) Kaplan–Meier curve for 28-day mortality according to optimal cutoff of mean CSA-QF. Abbreviations: CSA-QF, cross sectional area of quadriceps femoris

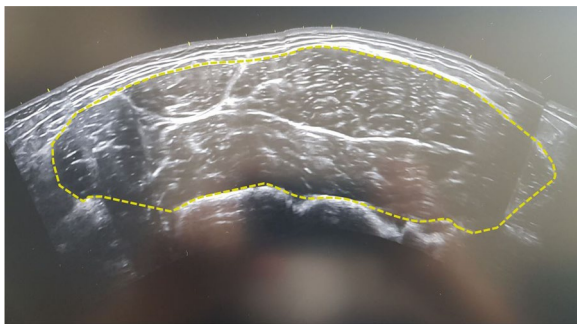

Figure 3 (abstract 000836) An example of measurement of quadriceps femoris mass using panoramic mode. The cross sectional area of quadriceps femoris was 70.75cm²

References

- Hadda V, Kumar R, Khilnani GC, et al. Trends of loss of peripheral muscle thickness on ultrasonography and its relationship with outcomes among patients with sepsis. *J Intensive Care*. 2018;6:81. Published 2018 Dec 12. doi: <https://doi.org/10.1186/s40560-018-0350-4>
- Lee Y, Park HK, Kim WY, et al. Muscle Mass Depletion Associated with Poor Outcome of Sepsis in the Emergency Department. *Ann Nutr Metab*. 2018;72(4):336–344. doi: <https://doi.org/10.1159/000488994>
- Cruz-Jentoft AJ, Bahat G, Bauer J, et al. Sarcopenia: revised European consensus on definition and diagnosis. *Age Ageing*. 2019 Jan 1;48(1):16–31. doi: <https://doi.org/10.1093/ageing/afy169>. Erratum in: *Age Ageing*. 2019 Jul 1;48(4):601. PMID: 30312372; PMCID: PMC6322506.
- Stringer HJ, Wilson D. The Role of Ultrasound as a Diagnostic Tool for Sarcopenia. *J Frailty Aging*. 2018;7(4):258–261. doi: <https://doi.org/10.14283/jfa.2018.24>. PMID: 30298175; PMCID: PMC6208738.
- Franchi MV, Fitze DP, Hanimann J, et al. Panoramic ultrasound vs. MRI for the assessment of hamstrings cross-sectional area and volume in a large athletic cohort. *Sci Rep*. 2020 Aug 24;10(1):14144. doi: <https://doi.org/10.1038/s41598-020-71123-6>. PMID: 32839500; PMCID: PMC7445237.
- Minnehan KS, Dexter WW, Holt CT, et al. Validation of Panoramic Ultrasound Measurement of the Cross-Sectional Area of the Vastus Medialis. *J Strength Cond Res*. 2023 Jan 1;37(1):41–45. doi: <https://doi.org/10.1519/JSC.0000000000004196>. Epub 2022 Jan 12. PMID: 36515588.
- Scott JM, Martin DS, Ploutz-Snyder R, et al. Panoramic ultrasound: a novel and valid tool for monitoring change in muscle mass. *J Cachexia*

Sarcopenia Muscle. 2017 Jun;8(3):475–481. doi: <https://doi.org/10.1002/jcsm.12172>. Epub 2017 Jan 3. PMID: 28052593; PMCID: PMC5476852.

- Zhang J, Huang Y, Chen Y, et al. Impact of Muscle Mass on Survival in Patients with Sepsis: A Systematic Review and Meta-Analysis. *Ann Nutr Metab*. 2021;77(6):330–336. doi: <https://doi.org/10.1159/000519642>
- Shibahashi K, Sugiyama K, Kashiura M, et al. Decreasing skeletal muscle as a risk factor for mortality in elderly patients with sepsis: a retrospective cohort study. *J Intensive Care*. 2017;5:8. Published 2017 Jan 11. doi: <https://doi.org/10.1186/s40560-016-0205-9>

Topic: Sepsis

000837

Sex differences in the host response to SARS-CoV-2 might explain differences in COVID-19 severity and outcome

A. Flikweert¹, N. Keur², I. Ricaño-Ponce², A. Muller Kobold³, S. Van Der Sar-Van Der Brugge⁴, P. Heeringa⁵, I. Rodenhuis-Zybert⁶, K. Le⁷, M. Van Meurs¹, P. Van Der Voort¹, V. Kumar², J. Moser¹

¹Department of Critical Care, University Medical Center Groningen, Groningen, Netherlands; ²Department of Internal Medicine and Radboud Center for Infectious Diseases, Radboud University Medical Center, Nijmegen, Netherlands; ³Department of Laboratory Medicine, University Medical Center Groningen, Groningen, Netherlands; ⁴Department of Pulmonary Medicine, Amphia Hospital, Breda, Netherlands; ⁵Department of Pathology & Medical Biology, University Medical Center Groningen, Groningen, Netherlands; ⁶Department of Medical Microbiology & Infection prevention, University Medical Center Groningen, Groningen, Netherlands; ⁷Department of Genetics, University Medical Center Groningen, Groningen, Netherlands

Correspondence: A. Flikweert

Intensive Care Medicine Experimental 2023, **11(Suppl 1)**:000837

Introduction: Males tend to develop more severe COVID-19 symptoms and are more likely to die. Females have worse functional outcomes after discharge and are more likely to develop long-COVID syndrome. How sex differences influence the host response to SARS-CoV-2 infection and how this relates to outcome remains poorly understood. Understanding and identifying sex-based differences, and the mechanisms involved is crucial to help predict patient outcomes and facilitate clinical decision making in terms of treatment and precision therapies for hospitalized COVID-19 patients. Although, several proteomic studies have been conducted to identify biomarkers that predict COVID-19 severity, most of them corrected for sex in their analysis.

Objectives: This study aimed to identify sex-specific differences in the host response to SARS-CoV-2.

Methods: This project is part of a multi-center prospective study conducted at the University Medical Center Groningen. Longitudinal plasma samples, demographic and clinical information from patients with COVID-19 admitted to the general ward (severe COVID-19, n = 169), and the intensive care unit (critical COVID-19, n = 131) were collected. Forty-one circulating host response markers related to inflammation, endothelial dysfunction, adipokines, coagulation, and organ injury were measured in the plasma using Luminex multiplex assays. Differential abundance analysis was performed in a sex-stratified manner with a linear model including age, body mass index, medical center, diabetes, and corticosteroid administration as covariates.

Results: Most of critical COVID-19 patients (71%) and 54% of severe COVID-19 patients were male, corroborating that males tend to develop more severe disease. Differential abundance analysis identified 16 proteins that were higher in male critical-COVID-19 compared to male severe-COVID-19 patients (IL-8, D-dimer, S100B, IL-6, Angpt2, MMP8, TNFR1, uPAR, uPA, Osteopontin, IL-13, TNFα, Pentraxin-3, P-selectin, Fractalkine, and SP-D). In contrast, only 7 proteins were higher in the plasma of female critical versus severe COVID-19 patients (IL-8, D-dimer, IL-6, Angpt2, Tie2, uPAR, and SP-D). Using a similar analysis, we identified 4 plasma proteins to be associated with mortality in males (D-dimer, IL-6, Pentraxin-3 and S100B) while we did not identify any plasma proteins to be associated with the mortality of females.

Conclusions: These results suggest that as well as common mechanisms in both sexes, differences in the host response to SARS-CoV-2 might underlie the increased susceptibility in men and highlight the need for a sex-based approach to the treatment and management of male and female COVID-19 patients.

References

1. This work was supported by ZonMw (project numbers: 10430012010006 & 10430012010002)

Topic: Infections and prevention

000839

Unlocking the correlation between Lipocalin-2 and interleukin-6 in traumatic brain injury

H. J. Park¹, J. H. Kim², R. J. Kang², M. Kim³, M. K. Han⁴, H. Ryu⁵, J. H. Kim², H. G. Jeong⁶, K. Suk²

¹Neurology, Seoul National University Bundang Hospital, Seongnam-si, Republic of Korea; ²Department of Pharmacology, School of Medicine, Kyungpook National University, Daegu, Republic of Korea; ³Division of Neurocritical Care, Department Neurosurgery and Neurology, Seoul National University Bundang Hospital, Seongnam-si, Republic of Korea; ⁴Department of Neurology, Seoul National University Bundang Hospital, Seongnam-si, Republic of Korea; ⁵Center for Neuroscience, Brain Science Institute, KIST | Korea Institute of Science and Technology, Seoul, Republic of Korea; ⁶Division of Neurocritical Care, Department of Neurosurgery and Neurology, Seoul National University Bundang Hospital, Seongnam-si, Republic of Korea

Correspondence: H. G. Jeong

Intensive Care Medicine Experimental 2023, **11(Suppl 1)**:000839

Introduction: Traumatic brain injury (TBI) is a complex condition that results in physical, cognitive, and emotional impairments. Despite extensive research, effective treatments for TBI remain elusive. Reverse translation research, utilizing clinical data to guide animal studies, is a valuable approach for identifying therapeutic targets for TBI. In this study, we aimed to investigate the correlation between Lipocalin-2 (LCN2) and interleukin-6 (IL-6) in TBI and explore the possibility of cross-regulation between them.

Methods: Plasma samples from acute TBI patients (n = 26) and healthy controls (n = 22) were analyzed for 23 cytokines and LCN2 using Luminex assay. Hierarchical clustering was performed to group the samples. Brain tissue samples from chronic traumatic encephalopathy (CTE) patients were analyzed for LCN2 and IL-6 mRNA expression and correlation. Acute and chronic TBI animal models were established, and mRNA expression and immunostaining were performed for IL-6 and LCN2. In vitro scratch injury models in astrocytes, microglia, or co-cultures were used to measure IL-6 mRNA expression. Recombinant LCN2 or IL-6 proteins were added to measure the expression of IL-6 or LCN2 mRNA, respectively. LCN2 transgenic mice were also used to measure the upregulation of LCN2 and IL-6.

Results: LCN-2 and IL-6 showed a strong correlation (correlation coefficient, 0.804) in plasma samples from acute TBI patients, and hierarchical clustering grouped them together. The expression of IL-6 and its receptors is also upregulated (at mRNA level) in patients with CTE, a few different mouse models of traumatic brain injury, and in vitro scratch injury model. These results suggest an augmented IL-6 signaling in the injured brain. As both LCN2 and IL-6 are secreted proinflammatory mediators, we next explored the possibility of cross-regulation between LCN2 and IL-6. In cultured glial cells, LCN2 enhanced the expression of IL-6 in glia. LCN2 enhancement of IL-6 expression was confirmed in LCN2 transgenic mice; the LCN2 transgenic mice showed elevated levels of IL-6 mRNA and protein release.

Conclusions: The results suggest an important pathological role of LCN2-IL-6 axis forming a neuroinflammation amplification loop in brain injury conditions. The study implies the usefulness of LCN2 and IL-6 as closely related double biomarkers for TBI.

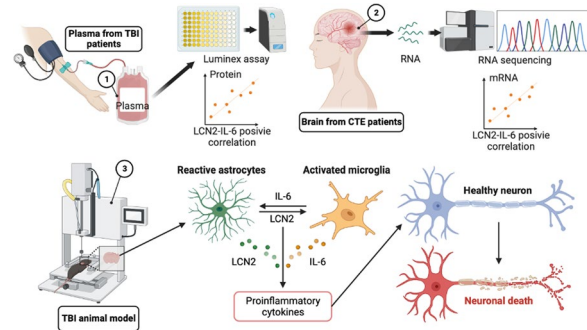

Graphical abstract

Topic: Translational Medicine

000840

Unraveling the complexities of sepsis outcomes: hospital and patient-level factors in bundle-based approaches

B. S. K. Yang¹, S. Park², M. K. Han³, L. Su Yeon⁴, G. Y. Suh⁵, C. M. Lim⁴, S. Y. Lim⁶, H. G. Jeong⁷

¹Division of Interdisciplinary Critical Care Medicine, Department of Neurology, Seoul National University Bundang Hospital, Seongnam-si, Republic of Korea; ²Div. of Pulmonary, Allergy & Critical Care Medicine, Dept. of Internal Medicine, College of Medicine, Hallym University, Hallym University Sacred Heart Hospital, Anyang-si, Republic of Korea; ³Department of Neurology, Seoul National University Bundang Hospital, Seongnam-si, Republic of Korea; ⁴Department of pulmonary and critical care medicine, Asan Medical Center, Seoul, Republic of Korea; ⁵Division of pulmonary and critical care medicine, department of medicine, Samsung Medical Center, Irwon-ro, Irwon-dong, Gangnam-gu, Seoul, South Korea, Seoul, Republic of Korea; ⁶Department of Pulmonary and Critical Care Medicine, Seoul National University Bundang Hospital, Seongnam-si, Republic of Korea; ⁷Division of Neurocritical Care, Department of Neurosurgery and Neurology, Seoul National University Bundang Hospital, Seongnam-si, Republic of Korea

Correspondence: H.G. Jeong

Intensive Care Medicine Experimental 2023, **11(Suppl 1)**:000840

Introduction: Sepsis is a major cause of worldwide mortalities requiring physician's urgent attention. To effectively simplify the decision-making process, the Surviving Sepsis Campaign (SSC) proposes time-point bundle-based approaches, but their universal efficacy is still in question. Despite their adaptation, mortalities vary significantly between hospitals, but whether these variations stem from the innate design of the bundles or hospital factors is unclear.

Objectives: This study attempts to identify hospital-level determinants of mortalities in sepsis patients and examine whether the determinants differ at the patient- and hospital-level.

Methods: Data is pulled from a prospectively collected, ongoing multicenter registry of sepsis patients. Participating hospitals are ranked based on risk-standardized mortality rates (RSMR), adjusting for patient- and hospital-level factors. Associations between the ranks and per-hospital bundle-satisfaction rates are examined. Studied bundles are 1-, 3-, and 6-h bundles with five elements each: measuring serum lactate level, drawing serum samples, administering antibiotics, bolus intravenous fluids, and vasopressors. Adjusted odds ratios of mortality (AOR) for each bundle component are derived and compared to the above associations. Uni- and bivariate analyses used a pairwise deletion, and multivariate analysis used a listwise deletion method.

Results: 11,926 patients from 19 hospitals were included in the analysis. 3,396 (28%) patients suffered in-hospital mortality. Per-hospital crude mortality rates ranged from 20.6% to 46.6%, while per-hospital RSMR ranged from 26.5% to 27.4%. Per-hospital bundle satisfaction rates varied for each element and time point. At each time point, the rates were generally lower for antibiotics and vasopressor administration and higher for bolus intravenous fluid administration and checking serum lactate levels. The rates generally increased as time points delayed. Ranks based on RSMRs showed significant correlations with 3-h lactate bundle (Spearman's $\rho=0.37$, $p=0.042$) and 6-h lactate bundle (Spearman's $\rho=0.47$, $p<0.01$), but not with other bundles. On the patient-level, 1-h intravenous fluids (AOR 0.49; 95% CI: 0.28–0.85), 1-h vasopressor (AOR 0.82; 95% CI: 0.71–0.95), and 6-h serum sampling (AOR 0.66; 95% CI: 0.49–0.87) showed significant associations with mortality.

Conclusions: Bundles having significant associations with mortality were different for hospital- and patient-levels. Despite the limitations of this study, including a major limitation of a small number of participating hospitals, this might suggest that bundle guidelines and their priorities should be differentially set for individual case- and institution-wise approach to sepsis.

References

1. The authors are on behalf of Korean Sepsis Alliance. This work was supported by the Research Program funded by the Korea Disease Control and Prevention Agency (fund code 2019E280500, 2020E280700, 2021–10-026) and supported by Korean Sepsis Alliance (KSA) affiliated with Korean Society of Critical Care Medicine (KSCCM).

Topic: Sepsis

000841

continuous nebulization therapy during simulated adult mechanical ventilation

E. Fernandez Fernandez¹, C. Thomas², M. Joyce², M. Mac Giolla Eain², R. Macloughlin²

¹Medical affairs, Aerogen, Galway, Ireland; ²R&D, Science and Emerging Technologies, Aerogen, Galway, Ireland

Correspondence: E. Fernandez Fernandez

Intensive Care Medicine Experimental 2023, **11(Suppl 1)**:000841

Introduction: The use of continuous nebulization therapy as a means of drug delivery to adult asthma patients has been shown to be an effective treatment option [Buck M]. Some studies suggest that it is, in fact, a better treatment option for acute asthma patients than the intermittent treatment [Rodrigo GL].

Objectives: The aim of this study was to examine the effect of continuous nebulization at different flow rates on aerosol drug delivery in a ventilated adult patient model.

Methods: mechanical ventilator (Servo-I, Maquet, SE) was connected to a dual limb circuit (RT380, Fisher & Paykel, NZ) and a humidifier (MR850, Fisher & Paykel, New Zealand). The ventilator was set to simulate ventilation of a 75 kg adult, using low tidal volume (Vt: 6 mL/kg PWB (450 mL), I:E: 1.0:1.0, RR: 15BPM). An adult closed suction catheter mount (Halyard Health Inc., US) was placed between the wye and the endotracheal tube (ETT) (8.0 mm, Flexicare Medical Ltd., UK). A vibrating mesh nebulizer (VMN) (Aerogen Solo and Pro-X controller, Aerogen Ltd., IE) was placed at the dry side of the humidifier. A continuous nebulization tube set (Aerogen Ltd., IE) was connected to the VMN. A syringe pump (Smith Medical, US) was set at flow rates of 2 mL/hr and 10 mL/hr for a total of 3 h, delivering 5 mg/mL and 1 mg/mL of Albuterol Sulfate solution (Sigma Aldrich, US) respectively. A capture filter (RespirGard II 303, Vyaire, US) was placed between the ETT and a test lung (IMT Medical, Bachs, CH). The filter was analysed every 30 min during the 3-h test period using UV spectrophotometry (276 nm). Results are expressed as a percentage of the nominal dose placed in the nebulizer's medication cup (%). All testing was performed in triplicate.

Results: Results presented in Figure 1.

Conclusions: Both the cumulative (μg) and inhaled dose (%) delivered were greater at the higher delivery flow rate of 10 mL/hr over the three-hour treatment period. However, at the lower delivery flow rate of 2 mL/hr, there was less variation in the inhaled dose (%) delivered to the simulated ventilated adult patient. For both pump flow rates, there was no statistically significant difference between the inhaled doses (%) over the 3-h treatment ($p=0.820$ for 2 mL/Hr and 0.718 for 10 mL/Hr). The findings presented in this study highlight the effects of delivery flow rate on the bronchodilator cumulative dose delivered via continuous nebulisation therapy over a three-hour treatment period.

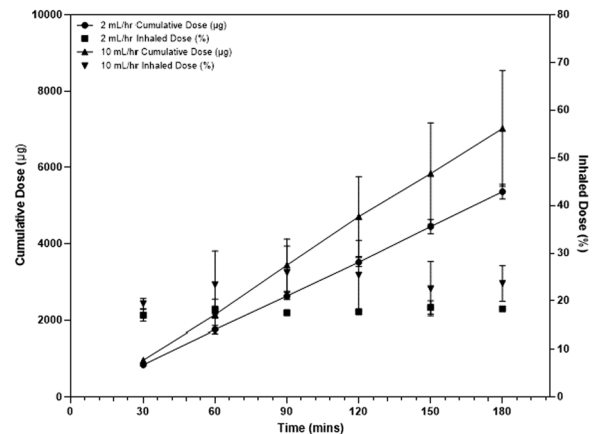

Figure 1. Summary of the cumulative dose (μg) and inhaled dose (%) delivered at 2mL/hr and 10mL/hr over a 3-hour treatment period.

Figure (abstract 000841) .

References

1. Rodrigo GJ, Rodrigo C. Continuous vs intermittent beta-agonists in the treatment of acute adult asthma: a systematic review with meta-analysis. *Chest*. 2002 Jul;122(1):160–5. doi: <https://doi.org/10.1378/chest.122.1.160>. PMID: 12114352.
2. Buck ML. Administration of albuterol by continuous nebulization. *AACN Clin Issues*. 1995 May;6(2):279–86. doi: <https://doi.org/10.1097/00044067-199505000-00011>. PMID: 7743430.

Topic: Acute respiratory failure and mechanical ventilation

000843

prognosis of mechanically ventilated patients with COVID-19 after failure of high-flow nasal cannula: a retrospective multicenter cohort study

ES. Cho¹, JW. Huh¹, S. Park², SH. Lee³, TH. Kim⁴, HJ. Yeo⁴, JH. Jang⁴, WH. Cho⁴

¹Department of Pulmonary And Critical Care Medicine, Asan Medical Center, Seoul, Republic of Korea; ²Div. of Pulmonary, Allergy & Critical Care Medicine, Dept. of Internal Medicine, College of Medicine, Hallym University, Hallym University Sacred Heart Hospital, Anyang-si, Republic of Korea; ³Department of Internal Medicine, Division of Pulmonology and Critical Care Medicine, Yonsei University College of Medicine, Seoul, Republic of Korea; ⁴Division of Allergy, Pulmonary and Critical Care Medicine, Department of Internal Medicine, Pusan National University Yangsan Hospital, Yangsan-si, Republic of Korea

Correspondence: E. S. Cho

Intensive Care Medicine Experimental 2023, **11(Suppl 1)**:000843

Introduction: After the COVID-19 pandemic, the use of High-flow nasal cannula (HFNC) among patients with hypoxic respiratory failure increased rapidly. Given that delayed intubation in the HFNC failure group is known to be associated with increased mortality, it is crucial to ascertain the optimal time for intubation in this group.

Methods: We conducted a 22 multicenter, retrospective, observational study from January 2020 to August 2021 in Korea. COVID-19 patients with acute respiratory failure over 19 years of age using respiratory support (HFNC, mechanical ventilation (MV)) were enrolled. Patients were divided into three groups: HFNC success (HFNC-S) group, HFNC failure (HFNC-F) group, and mechanical ventilation (MV) group for those who underwent intubation immediately without HFNC. We evaluated whether the failure of HFNC influences the mortality of COVID-19 pneumonia patients by comparing the clinical characteristics and mortality of these three groups.

Results: There were a total of 1028 patients enrolled, with 397 in the HFNC-S group, 448 in the HFNC-F group, and 183 in the MV group. The median age was 70, 60.4% of patients were male, and the 28-day mortality rate was 16.8%. Intubation rate among 845 patients using HFNC was 49.5%. HFNC-F group had higher systemic blood pressure (135.0 (122.0–148.0) vs. 128.0 (108.5–143.5), $p=0.001$), higher diastolic blood pressure (76.0 (68.0–85.0) vs. 71.0 (60.5–80.0), $p=0.001$), lower D-dimer (1.32 (0.58–5.56) vs. 3.55 (1.04–19.42), $p<0.001$), and lower lactate (1.57 (1.14–2.20) vs. 1.86 (1.35–2.66), $p<0.001$) compared to MV group. However, there was no statistically significant difference in the 28-day mortality rate (26.8% versus 23.0%, $p=0.270$). In multivariate Cox regression, age and SOFA were associated with 28-day mortality in HFNC-treated patients.

Conclusions: Among COVID-19 patients with hypoxic respiratory failure, the difference in 28-day mortality between the HFNC-F and MV groups was not statistically significant. In these patients, HFNC could be used as a first-line respiratory support device.

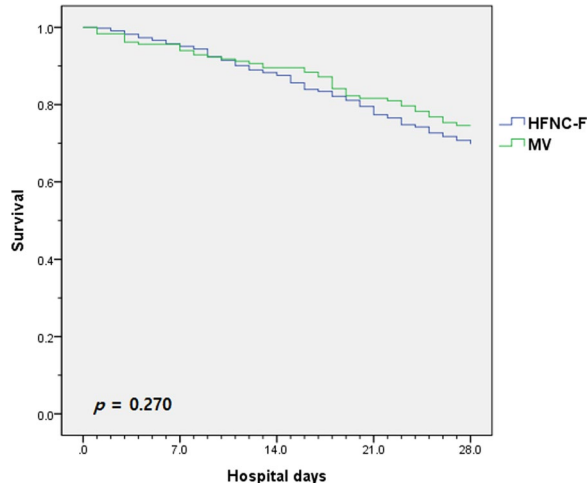

Kaplan–Meier survival estimates for the HFNC-F and MV group

References

1. This study is supported by grant No.(KATRD-S-2021-2) from the Korean Academy of Tuberculosis and Respiratory Diseases)

Topic: Acute respiratory failure and mechanical ventilation

000845

Mortality review in intensive care using a bespoke mortality database, have things changed since the COVID pandemic?

J. Macallan¹, A. Myers¹, T. Samuels¹, F. Lamb¹

¹Critical care, East Surrey Hospital, Redhill, United Kingdom

Correspondence: J. Macallan.

Intensive Care Medicine Experimental 2023, 11(Suppl 1):000845.

Introduction: Our intensive care unit uses a bespoke database to review our patient mortality (1). National guidance recommends that regular, multi-disciplinary mortality reviews are held by intensive care units (2). Local guidance regarding mortality reviews and categorisation of deaths was updated in 2020. All mortality cases where care was felt to be below standard should be discussed at mortality reviews and further case selection should be tailored to the clinical team (3).

Objectives: To evaluate our current mortality review process and to assess any impact that the COVID pandemic has had on this process.

Methods: Retrospective data cases from this database recorded between January 2017 and March 2023 were examined. We reviewed the time between death and presentation of cases at a mortality review between March 2022 and March 2023. Contingency analysis was performed using Fishers Exact test.

Results: A total of 871 cases were examined. Table 1 compares the data from the cases in their respective time periods. There is no significant difference between the cases reviewed and presented between the two 3-year time periods ($p=1.0$). Post-hoc analysis demonstrates a significant difference between the cases reviewed and presented for the years starting Mar 20 and Mar 21 ($p=0.005$). The median time between patient death and presentation at a mortality review meeting for March 2022–23 was 46 days (IQR 27–92 days).

Table 1

Time period	Total cases	Reviewed	Presented	Number of recommendations
Jan 2017 to Mar 2020	437	405 (92.7%)	244 (55.8%)	254
Mar 2020 to Mar 2023	434	317 (73%)	191 (33.2%)	164
Mar 20- Mar 21	155	127 (81.9%)	54 (34.8%)	91 (47 cases)
Mar 21- Mar 22	128	107 (83.6%)	91 (71.1%)	46 (36 cases)
Mar 22- Mar 23	154	86 (55.8%)	49 (31.8%)	29 (23 cases)

Conclusions: There has been a decrease in the overall number of cases being reviewed and presented from March 2020 onwards, but this was not statistically significant compared to the previous 3 years. Nevertheless, this decrease may reflect the additional burden and workload placed on intensive care staff by the COVID pandemic (e.g. fewer recommendations were made, which may reflect the homogeneity of the COVID pandemic population). The significant decrease in the number of cases reviewed and presented following the Mar 20- Mar 21 period is most likely explained by the widespread staff burnout experienced throughout critical care.

Reviewing and presenting all mortality cases would create a significant workload and is not in line with guidance. Our database approach allows us to identify which category cases belong to and to target those cases which require review. The time taken between death and presentation of cases has improved since our initial work which is encouraging (1). Further work is needed to ensure that we are reviewing mortality cases appropriately and effectively to facilitate learning and improvement from these.

References

1. Macallan J, Cavalier A, Myers A, Samuels T, Lamb F. Mortality review process in the intensive care unit (ICU): Are we learning from the past? [abstract]. ESICM Lives; 2019 Sep 28 to Oct 2; Berlin. Intensive Care Medicine Experimental: Springer Open; 2019 Sep 27. 7(Suppl 3):55. Available from: <https://icm-experimental.springeropen.com/counter/pdf/10.1186/s40635-019-0265-y.pdf>.
2. Faculty of Intensive Care Medicine. Guideline for the provision of intensive care services V 2.1 [Internet]. 2022. Available from: <https://fcm.ac.uk/sites/fcm/files/documents/2022-07/GPICS%20V2.1%20%282%29.pdf>. [Accessed 7th April 2023].
3. Surrey and Sussex HealthCare NHS Trust. Learning from deaths [Internet]. 2020. Available from: <https://www.surreyandsussex.nhs.uk/application/files/6516/4155/9075/Learning-from-death-Mortality-Review-policy-Oct-2020.pdf>. [Accessed 7th April 2023].
4. We would like to acknowledge the work of Dr Matt Mackenzie for creation of our bespoke ICU mortality database

Topic: Critical care organisation, quality management, information systems, outcomes

000848

VExUS is a prognostic factor in patient with ARDS

J. C. Gasca-Aldama¹, M. Vidals-Sánchez¹, G. A. Tapia-Cortez¹, E. Rios-Argaiz², P. E. Galindo-Vallejo³, J. López-Fernández⁴, D. Sanabria-Cordero⁵

¹Intensive Care Unit, Hospital Juárez de México, Ciudad de México, Mexico; ²Nephrology, Instituto Nacional de Ciencias Médicas y Nutrición Salvador Zubirán, Ciudad de México, Mexico; ³Nephrology Centro Médico ISSEMyM Ecatepec, Estado de Mexico, Mexico; ⁴Intensive Care Unit, Hospital Regional de Alta Especialidad ISSSTE, Veracruz, Mexico; ⁵Intensive Care Unit, Hospital De Infectología "Dr Daniel Mendez Hernández" IMSS, Ciudad de México, Mexico.

Correspondence: M. Vidals-Sánchez

Intensive Care Medicine Experimental 2023, **11(Suppl 1)**:000848

Introduction: Venous congestion is associated with mortality and can be measured by VExUS (Venous Excess Ultrasound Score). It's described that excessive fluid therapy obtains poor results in resuscitation, however, this isn't documented other than in the patient's registry with high fluid balances, for which VExUS could provide support in the diagnosis of fluid overload and link with worse outcomes in patients with acute respiratory distress syndrome (ARDS).

Objectives: To determine the association with mortality presented by venous congestion by VExUS in patients with ARDS in the Intensive Care Unit (ICU).

Methods: It's an observational, descriptive, retrospective study of a nested sample (N = 23). For the qualitative variables, frequencies and percentages were calculated. For continuous and discrete quantitative variables, Student's T test was used for normal distribution and Mann Whitney U test for free distribution. For categorical and nominal variables, the Pearson Chi Square test was performed, for quantitative variables of free distribution the measure of association was median and interquartile range, the type of distribution was determined using the Shapiro Wilk test. It ended with a Kaplan Meier graph, calculating the Long Rank. In addition to analyzing intervention with furosemide through the calculation of median survival.

Results: Patients with a degree of VExUS ≥ 1 had a survival of 28.6% and 71.4% died. In non-congestive patients (N = 16) 13 patients (81.3%) survived and 3 patients died (18.8%) with 95% CI (Figure 1).

In the secondary outcomes it was demonstrated that the portal vein pulsatility index (PI) of 32.8% and a central venous pressure (CVP) of 12.13 mmHg had a weak positive correlation of 0.383 by Pearson's r. It was also determined that a VExUS ≥ 1 together with a pulmonary artery occlusion pressure (POAP) of 12.39 had a Pearson's r of 0.442. To emphasize the importance of perfusion, a VExUS of 2.04 and a renal resistive index > 0.687 had a Pearson's r = 0.132. Patients who received furosemide had greater survival versus those who did not receive (Figure 2).

Conclusions: VExUS it's a useful tool in the patient with ARDS that allows the identification of fluid overload and, according to this study, it is a factor predictor that can help in making clinical decisions at the patient's bedside about fluid therapy and de-resuscitation.

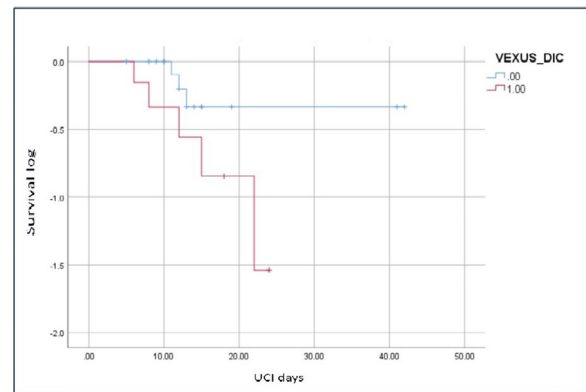

Figure 1. VExUS > 1 versus without venous congestion

Figure 1 (abstract 000848) VExUS > 1 versus without venous congestion

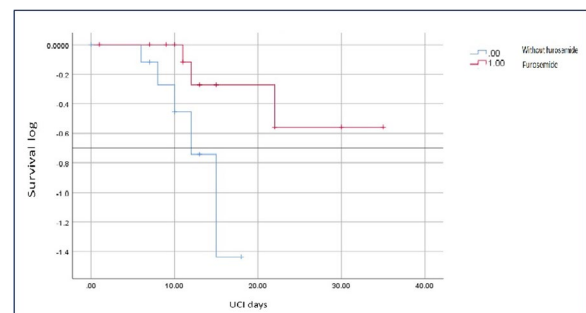

Figure 2. Use of furosemide in Vexus >1 versus no use of furosemide

Figure 2 (abstract 000848) Use of furosemide in Vexus > 1 versus no use of furosemide

References

1. Mendes, R. de S., Pelosi, P., Schultz, M. J., Rocco, P. R. M., & Silva, P. L. (2020). Fluids in ARDS: more pros than cons. *Intensive Care Medicine Experimental*, 8(Suppl 1), 32. doi: <https://doi.org/10.1186/s40635-020-00319-x>

2. Koratala, A., Ronco, C., & Kazory, A. (2020). Need for objective assessment of volume status in critically ill patients with COVID-19: The Tri-POCUS approach. *Cardiorenal Medicine*, 10(4), 209–216. doi: <https://doi.org/10.1159/000508544>
3. Rola, P., Miralles-Aguilar, F., Argaiz, E., Beaubien-Souligny, W., Haycock, K., Karimov, T., Dinh, V. A., & Spiegel, R. (2021). Clinical applications of the venous excess ultrasound (VExUS) score: conceptual review and case series. *The Ultrasound Journal*, 13(1), 32. doi: <https://doi.org/10.1186/s13089-021-00232-8>
4. Argaiz, E. R. (2021). VExUS nexus: Bedside assessment of venous congestion. *Advances in Chronic Kidney Disease*, 28(3), 252–261. doi: <https://doi.org/10.1053/j.ackd.2021.03.004>
5. Gupta, S., & Tomar, D. S. (2020). VEXUS-The Third Eye for the Intensivist? *Indian Journal of Critical Care Medicine: Peer-Reviewed, Official Publication of Indian Society of Critical Care Medicine*, 24(9), 746–747. doi: <https://doi.org/10.5005/jp-journals-10071-23582>
6. Beaubien-Souligny, W., Rola, P., Haycock, K., Bouchard, J., Lamarche, Y., Spiegel, R., & Denault, A. Y. (2020). Quantifying systemic congestion with Point-Of-Care ultrasound: development of the venous excess ultrasound grading system. *The Ultrasound Journal*, 12(1), 16. doi: <https://doi.org/10.1186/s13089-020-00163-w>

Topic: Acute respiratory failure and mechanical ventilation

000849

Facilitators and barriers in the use of a digital diary in the intensive care unit

C. Schol¹, E. Berger¹, C. Leerentveld², D. Gommers¹, M. Van Mol¹, E. Ista³

¹Department of Intensive Care, Erasmus University Medical Center, Rotterdam, Netherlands; ²Department of Intensive Care, Isala, Meppel, Netherlands; ³Department of Internal Medicine, Nursing Science, Erasmus University Medical Center, Rotterdam, Netherlands

Correspondence: C. Schol

Intensive Care Medicine Experimental 2023, **11(Suppl 1)**:000849

Introduction: The application of diaries in the intensive care unit (ICU) is a valuable intervention in the prevention of long-term mental health-related impairments among patients and their relatives (1). An ICU diary is a tool where medical staff or family members record patients' experiences during ICU hospitalization, thus facilitating patients to recollect the hospitalization experience they had during ICU.

Although a digital ICU diary seems to have several advantages over a paper diary, it is challenging to properly implement and maintain this digital intervention in clinical practice. Knowledge of the influencing factors is essential in the development of a tailor-made implementation strategy to integrate the digital diary in the ICU (2).

Objectives: This study aimed to explore the determinants (facilitating and hindering factors) for the implementation of a digital diary in the ICU from the perspectives of ICU professionals, ICU survivors and their relatives.

Methods: A multicenter qualitative design consisting of focus group interviews with ICU professionals and interviews with ICU survivors and relatives was conducted between October 2022 and February 2023. The Consolidated Framework for Implementation Research (CFIR) (3) guided data collection and analysis of determinants. The CFIR identifies five domains (innovation, outer setting, inner setting, individuals and implementation process). We used directed content analysis methods to identify the determinants that could influence the implementation of a digital diary.

Results: We conducted five focus group interviews among ICU professionals (n = 31) and 10 individual or duo interviews including five ICU survivors and nine relatives. Determinants were found in all five CFIR domains. ICU professionals reported as the top three facilitators: 1) a user-friendly and easily accessible diary; 2) sufficient training and information; and 3) feedback from experiences of patients and

relatives. Barriers included: 1) the preference for and advantages of a paper diary; 2) many steps required to access the diary; and 3) resistance to writing the diary by professionals. In contrast, professionals' writing in the diary was highly appreciated among survivors and their relatives. An ambiguous factor seemed sharing the diary with others, as it was reported by ICU survivors and relatives both as valuable and as a privacy issue. Finally, they found the digital diary less personal and less intimate than a paper diary.

Conclusions: This study provides insight into the most important determinants influencing the implementation of a digital diary in the ICU. Strikingly, some factors are both a barrier and a facilitator, such as writing diary entries. When developing the implementation strategy, the found facilitators can be used to overcome the barriers for ICU professionals, ICU survivors, and relatives.

References

1. Sun X, Huang D, Zeng F, Ye Q, Xiao H, Lv D, et al. Effect of intensive care unit diary on incidence of posttraumatic stress disorder, anxiety, and depression of adult intensive care unit survivors: A systematic review and meta-analysis. *J Adv Nurs*. 2021;77(7):2929–41.
2. Haakma T, Tieben R, Sleven B, Buisse M, van Mol M. Experiences of nurses with an innovative digital diary intervention in the intensive care unit: A qualitative exploration. *Intensive Crit Care Nurs*. 2022;70:103197.
3. Damschroder LJ, Reardon CM, Widerquist MAO, Lowery J. The updated Consolidated Framework for Implementation Research based on user feedback. *Implement Sci*. 2022;17(1):75.
4. This study received funding from ZonMw (Project number: 10040032110002).

Topic: Nursing care and physiotherapy

000850

Early vasopressin, prognostic impact in septic shock patients

G. Castañeda¹, R. Ruiz Cacho¹, J. Cui¹, C. Alvarez¹, C. Ramirez¹, N. Cango¹, P. García Olivares¹, J. Cedeño Mora¹, M. Artabe¹, A. Rodríguez¹

¹Intensive care unit, H.G.U Gregorio Marañón, Madrid, Spain

Correspondence: G. Castañeda

Intensive Care Medicine Experimental 2023, **11(Suppl 1)**:000850

Introduction: Septic shock is the most common cause of death in intensive care units and it has a mortality rate of 40 to 60%. Both catecholamine and non-catecholamine vasoactive agents are used in these scenarios. The non-catecholamine agent vasopressin is suggested to either increase MAP or reduce Noradrenaline dose requirements. However, to date, there remain unsettled questions regarding the overall mortality benefit of vasopressin in patients with septic shock.

Objectives: To analyse the prognostic impact of early vasopressin (VAP) use in septic shock patients requiring increasing doses of Noradrenaline (NAD).

Methods: Retrospective observational study, conducted on critically ill patients admitted to the Intensive Care Unit of Gregorio Marañón Hospital, between March and December 2022. As a established protocol, all patients received VAP when NAD exceeded 0.2 µg/Kg/min. Epidemiological data, comorbidities, severity, clinical features, invasive support, complications and outcomes were collected.

Descriptive analyses were expressed as means (standard deviation) for normally distributed quantitative variables, medians (interquartile range) for non-normally distributed variables, and as percentages for categorical data. The NAD dose impact on mortality at which VAP was introduced was evaluated with simple logistic regression, and the dose with the best ability to discriminate the area under the curve (ROC curve). Mortality association was determined by a multiple logistic regression study, adjusted by confounding factors.

Results: Seventy patients were included, 53% were male, mean age 61 ± 16 . Charlson Index 3 (2–4), and to evaluate severity of illness, APACHE II 26 ± 7 , SOFA 12 ± 3 . 80% required invasive mechanical ventilation for 4 days (1–15 days). Time from septic shock diagnose to NAD initiation was 3 h (1–5 h), time from septic shock diagnose to VAP initiation, 8 h (5–15 h). NAD dose when initiating VAP was 0.6 ± 0.4 $\mu\text{g}/\text{Kg}/\text{min}$. Gobar mortality was 49%.

At the univariate analysis, NAD dose when initiating VAP was related to mortality (OR 82.75; CI 95% 7.80–877.37). The NAD dose when initiating VAP has prognostic capability (ROC 0.84; CI 95% 0.74–0.94), being 0.40 $\mu\text{g}/\text{Kg}/\text{min}$ the best mortality discriminating dose. Patients with NAD > 0.40 $\mu\text{g}/\text{Kg}/\text{min}$ when initiating VAP, had higher mortality risk (RR 19.33; CI 95% 5.78–65.69).

In the multivariate analysis adjusted by age, severity, comorbidity, vasopressor timing and lactate, delayed VAP treatment related to NAD dose, was related to a higher mortality risk (Table 1).

Conclusions: Early-vasopressin use (with intermediate NAD dose), could improve septic shock patients pronostic.

Variable	Significance
Age	OR 0,98 (0,94 – 1,03)
Charlson	OR 1,15 (0,87 – 1,51)
APACHE II	OR 1,08 (0,96 – 1,23)
Lactate	OR 1.57 (1.16 – 2.10)
SOFA at ICU admission	OR 1,25 (0,92 – 1,70)
NAD treatment till shock diagnose	OR 0,99 (0,86 – 1,14)
VAP treatment till shock diagnose	OR 0,24 (0,82 – 1,13)
NAD > 0.4 ug/Kg/min at VAP treatment	OR 15.40 (2.87– 82.51)

Table 1

Topic: Cardiovascular issues in ICU

000853

Characteristics of the population admitted to the ICU due to refractory status. The role of continuous electroencephalography in the optimization of its management

S. Martin-Sastre¹, F. Fuentes Gorgas¹, D. Campos², E. Santamaría², M. Sueiras³, V. Thonon³, C. Palmada¹, R. M. Gracia¹, R. Ferrer Roca⁴, A. Sánchez¹

¹Intensive Care Department, Vall d'Hebron Barcelona Hospital Campus, Barcelona, Spain; ²Neurology Department, Vall d'Hebron Barcelona Hospital Campus, Barcelona, Spain; ³Neurophysiology Department, Vall d'Hebron Barcelona Hospital Campus, Barcelona, Spain; ⁴Intensive Care Department, Vall d'Hebron University Hospital, Barcelona, Spain

Correspondence: F. Fuentes Gorgas

Intensive Care Medicine Experimental 2023, **11(Suppl 1)**:000853

Introduction: The EEG signal recollects the process of cortical and subcortical neural networks. Intermittent 30-min routine EEG is the most standard strategy, but multiple centers have assumed continuous EEG (cEEG) monitoring, boosting the examination of the change of brain activity over time. The EEG signal is intricate, and the statement from EEG specialists may be hard to analyze for the intensive care unit (ICU) physicians. Wide-consensus classification of EEG patterns in critical care has been included in the American Clinical Neurophysiology Society (ACNS) standardized terminology. This nomenclature, initially published in 2013 and revised in 2021, has been increasingly adopted in clinical publications, and it contributes to a uniform description of the basic EEG patterns.

Objectives: Analyze the characteristics of a sample of patients admitted to the ICU with refractory status and assess the impact of continuous electroencephalography monitoring.

Methods: Our team collected prospectively in a database every patient with convulsive admitted to the Intensive Care Department. Quantitative variables are represented as mean and standard deviation if they meet normality criteria according to the Kolmogorov–Smirnov test and otherwise as median and interquartile range. Qualitative variables are expressed as frequencies and percentages. In the analytical phase of the study, a hypothesis contrast was performed for the difference in means using the Student's t statistic. The statistical measure was performed using SPSS.

Results: In 2022, the group of neurocritical patients cared for 25 patients with convulsive status admitted to the ICU. The mean age was 57; hospital admission time was 47 days (SD 9.4), ICU 10 days (IQR 5.35), and a mortality of 27%. 76% required invasive mechanical ventilation, with a median of 6 days of connection to the ventilator (IQR 2, 33). Only 28% of patients required a tracheotomy. Structural pathology was evidenced in 69%. Continuous EEG monitored 50% of the patients at some point during admission. 90% of these implied a change in the therapeutic regimen. In continuously monitored patients, the mean duration of mechanical ventilation was 17 days, the mean ICU stay was 20.8 days, and the mean hospital stay was 48.5 days. In patients monitored by conventional EEG, the mean duration of mechanical ventilation was 20 days, the mean ICU stay was 24 days, and the mean hospital stay was 51.7 days. Despite the differences observed, no statistically significant differences were found between the two groups concerning the time on mechanical ventilation or the mean stay in the ICU or hospital.

Conclusions: Continuous EEG monitoring allows the optimization of pharmacological management in most cases. We observed in our sample a shorter duration of mechanical ventilation time and ICU and hospital stay. The lack of statistical power is likely due to the sample size. More research is required on this modality of neuromonitoring and its impact on the clinical outcomes of patients with refractory seizure status.

References

- Westhall E, Rossetti AO, van Rootselaar AF, WesenbergKjaer T, Horn J, Ullen S et al. (2016) Standardized EEG interpretation accurately predicts prognosis after cardiac arrest. *Neurology* 86:1482–1490
- Sandroni C, Cronberg T, Hofmeijer J. EEG monitoring after cardiac arrest. *Intens Care Med.* 2022;48(10):1439–42.
- Hirsch LJ, Fong MWK, Leitinger M, LaRoche SM, et al. (2021) American Clinical Neurophysiology Society's standardized critical care EEG terminology: 2021 version. *J Clin Neurophysiol Off Publ Am Electroencephalogr Soc* 38:1–29

Topic: Neurointensive care

000855

Driving resumption of critical illness survivors: a retrospective cohort study

C. Apps¹, K. Brooks¹, J. C. Larose¹, L. Rose², J. Meyer¹

¹Critical Care, Guy's and St Thomas' NHS Foundation Trust, London, United Kingdom; ²Florence Nightingale Faculty of Nursing, Midwifery and Palliative Care, King's College London, London, United Kingdom

Correspondence: C. Apps

Intensive Care Medicine Experimental 2023, **11(Suppl 1)**:000855

Introduction: Driving resumption is an important component of recovery for many survivors of critical illness, enabling return to work, social activities, and independence. Currently, little data exists about the resumption of driving of survivors of critical illness.

Objectives: To review the resumption of driving in a cohort of critical illness survivors who attended a critical care recovery clinic of a large

tertiary centre in the United Kingdom approximately three months following hospital discharge.

Methods: A single centre retrospective cohort study with data extracted from the medical record. Variables associated with driving resumption were modelled using logistic regression.

Results: We obtained data on 1,341 patients who attended the critical care recovery clinic between December 2017 and July 2022. Of these, 765 (57%) patients held a UK driving licence prior to admission. Patients holding a UK driving license had a mean (SD) age of 54 (14.3) and mean (SD) APACHE II score on ICU admission of 15 (4.9); 199 (26%) required ECMO. The median (IQR) lengths of ICU and hospital stay were 14 (8, 28) and 32 (17, 53) days respectively.

Of the 550/765 patients with data on driving status, 336 (61%) had resumed driving and 55 (10%) patients reported being advised not to drive. Shorter hospital length of stay (odds ratio (OR) 0.985, 95% confidence interval (CI) 0.978 to 0.992) was associated with driving resumption controlling for age and APACHE II score on ICU admission, requirement for ECMO, and ICU length of stay (Table 1).

Qualitative description of reasons why driving had not been resumed within the medical record included physical, psychological, and practical reasons. These included physical weakness, difficulty mobilising beyond the house, fatigue, breathlessness, reduced lower limb sensation, seizures, challenges associated with an ostomy, lack of confidence in driving ability, no need to drive, and no access to a car.

Table 1

Variable	OR	95% CI
Age	0.991	0.976—1.006
APACHE II score	0.987	0.949—1.027
ECMO	1.398	0.891—1.027
ICU LOS	0.995	0.986—1.004
Hospital LOS	0.985	0.978—0.992

Conclusions: Nearly two thirds of patients in our cohort had resumed driving. Driving resumption was associated with shorter hospital length of stay. Reasons for not resuming driving were multifactorial but were frequently due to ongoing physical consequences of critical illness.

Topic: Critical care organisation, quality management, information systems, outcomes.

000858

Renal replacement therapy in severe COVID-19, favourable longer-term outcomes in a single-centre study

H. Mahroof¹, A. Y. K. C. Ng², J. Martin³, A. Conway Morris⁴
¹John Farman ICU, Cambridge University Hospitals NHSF Trust, Cambridge, United Kingdom; ²Department of Medicine, University of Cambridge School of Clinical Medicine, Cambridge, United Kingdom; ³Intensive Care, Addenbrooke's Hospital, Cambridge, United Kingdom; ⁴Division of Anaesthesia, Department of Medicine, University of Cambridge, Cambridge, United Kingdom

Correspondence: H. Mahroof

Intensive Care Medicine Experimental 2023, 11(Suppl 1):000858

Introduction: Acute kidney injury (AKI) is a frequent complication seen in patients with COVID-19 infection admitted to intensive care. Increasing number of organ failures is associated with a higher ICU mortality. UK ICU data shows that 1 in 4 COVID ICU patients require renal replacement therapy (RRT), carrying >60% mortality, leading to some prognostic nihilism preventing escalation to RRT in some patients.

Objectives: To assess the outcome of COVID-19 ICU patients managed with RRT in ICU to assess their mortality on ICU, at 4, 26 and 52 weeks, and their dependence on RRT at 26 and 52 weeks, post ICU discharge for the survivors.

Methods: Contemporaneous electronic medical records were retrospectively reviewed for all patients admitted to ICU with COVID-19 as the main or significant presenting problem over 2 years from March 2020, at a large UK university hospital. AKI was defined as per the KDIGO criteria and renal biochemistry, along with review of medical notes to assess need for RRT.

Results: 106 patients with COVID-19 and requiring RRT were identified, ICU mortality was 61% with 41 surviving to ICU discharge, including 5 patients with previous dialysis dependence. Non-survivors were older (mean age 65 vs 56) and had more severe disease (as evidenced by greater rate of ventilation, higher rate of prone positioning and greater requirement for vasopressors). Of the 41 ICU survivors, 40 (98%) survived to day 28 and 39 (95%) survived to 1 year. Creatinine returned to baseline in 14 (36%) and was less than double baseline in 35 (90%) of 1-year survivors (Figure 1). Only one new dialysis dependence developed in survivors.

Conclusions: Patients with COVID-19 and requirement for renal replacement therapy demonstrated a similar mortality rate to that previously reported in the literature. However survivors demonstrated mostly modest deterioration in renal function relative to baseline and excellent 1-year survival. RRT in ICU was not a predictor of subsequent need to dialysis. Therapeutic nihilism in this cohort is misplaced.

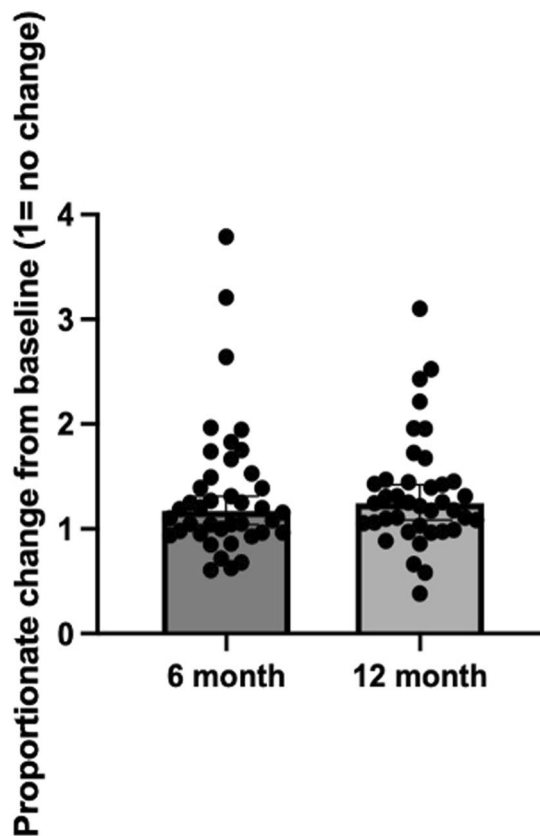

Figure 1: Proportionate change in creatinine from baseline to 6 and 12 months for survivors to 12 months

Figure 1 (abstract 000858) Proportionate change in creatinine from baseline to 6 and 12 months, for survivors to 12 months

References

1. ACM is supported by a Clinician Scientist Fellowship from the Medical Research Council (MR/V006118/1)
2. ICNARC Report on COVID-19 in Critical Care, Feb 2023.
3. Griffiths F, Svantesson M, Bassford C et al. Decision-making around admissions to intensive care in the UK pre-COVID-19: a multicentre ethnographic study. *Anaesthesia* 2021, 76(4): 489–99.
4. De Corte W, Dhondt A, Vanholder R et al. Long-term outcome in ICU patients with acute kidney injury treated with renal replacement therapy: a prospective cohort study. *Critical Care* (2016) 20:256.

Topic: Acute Kidney Injury and haemofiltration

000859

Spectrum of organisms causing blood stream infections in 2 major UK ICUs with resistance patterns over last 8 years

H. Mahroof¹, A. Y. K. C. Ng², J. Martin³, A. Conway Morris⁴

¹John Farman ICU, Cambridge University Hospitals NHSF Trust, Cambridge, France; ²Department of Medicine, University of Cambridge School of Clinical Medicine, Cambridge, United Kingdom; ³Intensive Care, Addenbrooke's Hospital, Cambridge, United Kingdom; ⁴Division of Anaesthesia, Department of Medicine, University of Cambridge, Cambridge, United Kingdom

Correspondence: H. Mahroof

Intensive Care Medicine Experimental 2023, **11(Suppl 1)**:000859

Introduction: Blood stream infections (BSI) are a source of significant morbidity and mortality in ICU patients. Whilst good clinical practices, including line insertion and management have helped reduce BSI, timely appropriate use of antimicrobial agents in suspected BSI is important. Invasive knowledge of local microbiological BSI biome is a useful indicator to base antimicrobial decision making, de-escalation and antibiotic stewardship.

Objectives: To assess all confirmed BSIs 2 large ICUs (General and Neuro ICU) at a single centre large UK university hospital over 8 years from 2015 to end of 2022. To further assess sensitivities and resistance patterns to common antibiotics and in addition to assess such patterns within some common ICU BSI organisms.

Methods: All BSI positive culture records from the above 2 ICUs over 8 years to end of 2022 were reviewed and analysed. The antibiotic sensitivity or resistances reported were also reviewed and their evolution over the 8 years were assessed.

Results: Positive blood cultures were equivalent between the units when adjusted for patient length of stay (10 per 1000 bed days). Rates increased during the COVID pandemic (2020–2021) to 13/1000 bed days in the General but not Neuro ICU. However review of organisms revealed 50% were likely contaminated cultures (Coagulase-negative Staphylococci and Diptheroids/Corynebacteria- Figure 1), giving a 'true' BSI rate of 5 and 4/1000 bed days respectively, with the 'spike' in BSI during COVID confirmed (rising to 6/1000 bed days in the General unit). The dominant organisms differed between the units (Figure 1). Resistance rates showed considerable variability, from <5% for meropenem and amikacin to >70% for ciprofloxacin, with evidence of rising resistance to some agents over time.

Conclusions: Despite differences in patient demographics we observed similar rates of BSI between units. The majority of positive cultures were likely contaminants, emphasising the need to improve technique for drawing blood cultures. COVID was associated with a rise in BSI, with Enterococci and Enterobacteriaceae being the most prevalent groups of organisms in this spike. Resistance rates for some antimicrobials are rising.

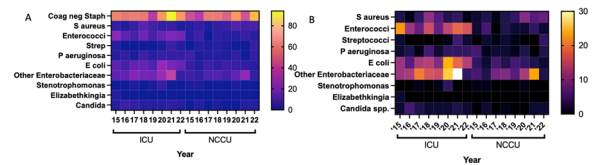

Figure 1: heat maps demonstrating the distribution of organisms identified from blood cultures. Panel A includes all organisms, whilst panel B focuses on highly pathogenic organisms only.

Figure 1 (abstract 000859) Heat maps demonstrating distribution of organisms from blood cultures

References

1. ACM is supported by a Clinician Scientist Fellowship from the Medical Research Council (MR/V006118/1)
2. De Waele J, Akova M, Antonelli M et al. Antimicrobial resistance and antibiotic stewardship programs in the ICU: insistence and persistence in the fight against resistance. A position statement from ESICM/ESCMID/WAAAR round table on multi-drug resistance. *Intensive Care Med* 2018; 44: 189–96.
3. Infection in Critical Care Quality Improvement Programme (ICCCQIP), FICM, UK
4. Yi J, Kim K-H. Identification and infection control of carbapenem-resistant Enterobacterales in intensive care units. *Acute Crit Care* 2021; 36(3):175–84.

Topic: Infections and prevention

000860

Post-traumatic stress disorder among critical ill COVID-19 survivors

G. Morales Varas¹, G. Alonso Gómez¹, P. Carneiro Pereda¹, P. Rodríguez Villamizar¹, M. Vecino Montoya¹, M. Márquez Doblás¹, A. Cuadra-Calahorra¹, J. Guerra Cuervo¹, I. Gómez Cano¹, V. Pais Sánchez-Malingre¹¹Critical Care, Hospital General Universitario de Toledo, Toledo, Spain

Correspondence: G. Morales Varas

Intensive Care Medicine Experimental 2023, **11(Suppl 1)**:000860

Introduction: Post-traumatic stress disorder (PTSD) is common among survivors of critical illness. Coronavirus disease (COVID-19) in its most severe forms may require critical care and different levels of life support. Determining the impact it has had on the mental health of these patients may help to define appropriate mental health resources for the COVID-19 survivors.

Objectives: To evaluate the prevalence of PTSD and factors associated with its development among critically ill COVID-19 survivors.

Methods: This cross-sectional study among critical ill COVID-19 survivors at 1-year of intensive care unit (ICU) discharge. A validated instrument was used: the Post-Traumatic Stress Disorder Checklist-5 (PCL-5) based on the Diagnostic and Statistical Manual of Mental Disorders (DSM-5) for screening PTSD which was administered through a phone-based questionnaire. The PCL-5 can determine a provisional diagnosis of PTSD using a cut-point score of 31–33. Categorical variables are expressed as counts and percentages and were compared using the χ^2 test and Fisher test; continuous variables are expressed as medians and interquartile range (IQR) and were compared using Mann-Whitney U test. A two-sided level of significance of 5% was used. Data analysis was performed using STATA version 13[®] (StataCorp LCC).

Results: A total of 388 patients 1-year after ICU discharge were analyzed; of whom 24/388 (6.18%) died; 86/364 (23.62%) did not respond to the telephone call; and 8/278 (2.88%) refused the survey, leaving

a cohort of 270 patients. 62.59% were male and the median age was 59 (48.5–66) years old, with no differences between groups. PTSD had a prevalence of 9.63% (24/270), with a median PCL-5 Score among those who did not develop the syndrome of 6 (1–14) pts vs 40.5 (34–53) pts among those who suffered the syndrome, $p < 0.001$. Patients with PTSD presented a higher consumption of psychopharmacological drugs during the month prior to the interview (72% vs 36.68%; $p < 0.001$), mainly antidepressants as a new indication (32%, 13.58%; $p = 0.02$). Factors associated with the development of PTSD were delirium in ICU (69.23% vs 43.85; $p = 0.014$); and periods of higher critical care burden (1st, 2nd and 3rd pandemic waves: 96.15% vs 4th, 5th and 6th pandemic waves: 3.85%; $p = 0.006$) (Table 1). Patients with PTSD had a worse perception of their health status as estimated by the Euro-QOL Thermometer (52.5 [45–70] vs 72.5 [50–90]; $p = 0.003$).

Conclusions: PTSD affects a part of the critical ill COVID-19 survivors that is similar to other critical illnesses. It is a problem that conditions a higher consumption of psychopharmacological drugs and its development is associated with ICU delirium and with periods of higher critical care burden of the pandemic.

References

- None.

Topic: Critical care organisation, quality management, information systems, outcomes

000861

Effects of person-centered care and intensive care experience on post-intensive care syndrome in critical care survivors: a multi-center cohort study

J. Kang¹, H. J. Cho¹

¹College of Nursing, Dong-A university, Busan, Republic of Korea

Correspondence: J. Kang

Intensive Care Medicine Experimental 2023, **11**(Suppl 1):000861

Introduction: Critical care Survivors experience post-intensive care syndrome, which consists of mental, physical, and cognitive sequelae, for an extended period of time after discharge, which negatively impacts their and their families' quality of life. Risk factors for post-intensive care syndrome are diverse and mostly unmodifiable, such as demographic characteristics and pre-ICU health conditions. However, the intensive care experience of patients identified in a recent meta-analysis study as one of the risk factors is modifiable and sensitive to nursing care.

Objectives: This study aimed to examine the effects of person-centered critical care and intensive care experiences on the post-intensive care syndrome of critical care survivors.

Methods: In this prospective, multicenter cohort study, 891 adults who had been admitted to one of 19 intensive care units in Busan, Korea, for more than 24 h between May 2019 and July 2021 were included. At the time of ICU discharge, participants completed a person-centered critical care nursing questionnaire and an intensive care experience questionnaire. The Intensive Care Experience questionnaire consists of four sub-tools: "awareness of surroundings," "frightening experiences," "satisfaction with care," and "recall of experiences." Participants responded to the Post-Intensive Care Syndrome questionnaire via telephone interviews at 3, 6, and 12 months after hospital discharge. We analyzed the data of 618 participants who responded

at least once out of a total of three follow-ups; missing values were processed using the multiple imputation method (Fig 1). Pearson's correlation was used to analyze the relationship between person-centered care and the intensive care experience as perceived by the participants. Using a structural equation model, the effect of person-centered care and each component of the intensive care experience on the change in post-intensive care syndrome after discharge was analyzed.

Results: The baseline data of the participants is shown in Table 1. The greater the participants' perception of person-centered care, the greater their perception of their surroundings and satisfaction with care, and the less frightening their experience. There was no significant correlation between person-centered care and the recall of experiences. In the control of demographic and clinical variables, frightening experience had a significant effect on the initial value of post-intensive care syndrome ($B = 0.132$, $p = 0.011$), and person-centered care had a significant effect on its change ($B = -0.151$, $p = 0.035$; Table 2).

Conclusions: The findings of this study suggest that a frightening experience in the intensive care unit may lead to post-intensive care syndrome, while person-centered care can alleviate it.

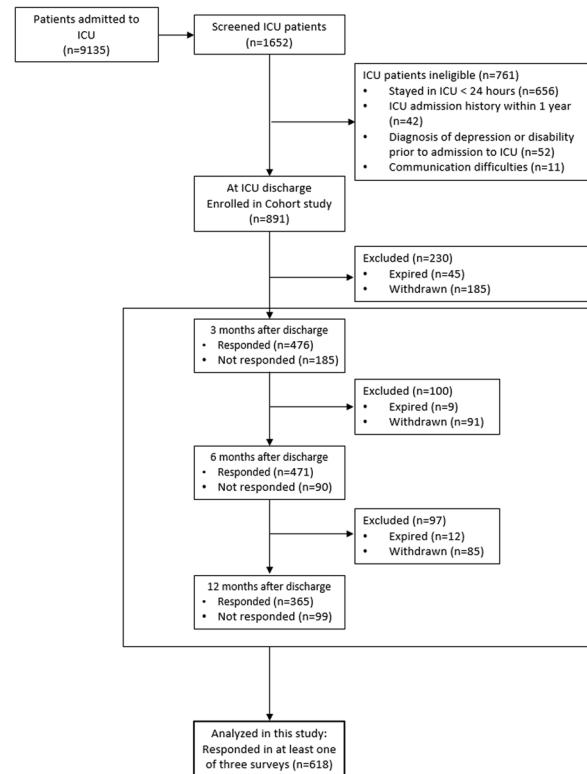

Figure 1. Study flow

Figure 1 (abstract 000861) Study flow

Table 1 (abstract 000861) Baseline characteristics of participants (N = 68)

Table 1. Baseline Characteristics of Participants (N=618)

Variables	Category	n(%)	Mean±SD
Gender	Man	369(59.7)	
	Woman	249(40.3)	
Age	<60	268(43.4)	60.15±13.27
	≥60	350(56.6)	
Informed admission	Yes	478(77.3)	
	No	140(22.7)	
Employment	Yes	285(46.1)	
	No	333(53.9)	
FCI	0	264(42.7)	
	1	205(33.2)	
	≥	149(24.1)	
		105(17.0)	
Diagnosis	Medical disease	181(29.3)	
	Postoperative	166(26.9)	
	Neurologic disease	47(7.6)	
	Musculoskeletal disease	119(19.3)	
	Cardiovascular disease	321(51.9)	
Admission route	Emergency room	297(48.1)	
	Ward		
Disease severity			0.03±0.95
Ventilator	Yes	119(19.3)	
	No	499(80.7)	
Surgery	Yes	338(54.7)	
	No	280(45.3)	
Delirium	Yes	88(14.2)	
	No	530(85.8)	
Discharge place	Home	518(83.8)	
	Others	100(16.2)	

Table 2 (abstract 000861) The effect of person-centered care and intensive care experience on post-intensive care syndrome

Table 2. The Effect of Person-Centered Care and Intensive Care Experience on Post-Intensive Care Syndrome

Dependent variable	Independent variable	B	β	S.E.	C.R.	P
ICEPT	<--- Person-centered care	0.029	0.055	0.028	1.062	0.288
SLOPE	<--- Person-centered care	-0.077	-0.151	0.037	-2.108	0.035
ICEPT	<--- Recall of experience	-0.105	-0.047	0.115	-0.906	0.365
ICEPT	<--- Satisfaction of care	-0.039	-0.02	0.101	-0.388	0.698
ICEPT	<--- Awareness of surrounding	0.018	0.019	0.05	0.367	0.713
ICEPT	<--- Frightening experience	0.117	0.132	0.046	2.551	0.011
SLOPE	<--- Recall of experience	0.106	0.05	0.153	0.697	0.486
SLOPE	<--- Satisfaction of care	0.146	0.079	0.133	1.096	0.273
SLOPE	<--- Awareness of surrounding	-0.073	-0.08	0.066	-1.112	0.266
SLOPE	<--- Frightening experience	-0.041	-0.048	0.061	-0.674	0.5
ICEPT	<--- Gender	-2.246	-0.214	0.541	-4.148	***
ICEPT	<--- Age	0.051	0.132	0.02	2.557	0.011
ICEPT	<--- Employment	-0.884	-0.086	0.533	-1.66	0.097
ICEPT	<--- Informed admission	-1.376	-0.112	0.634	-2.169	0.03
ICEPT	<--- FCI	1.578	0.31	0.262	6.012	***
ICEPT	<--- Medical disease	-0.137	-0.01	0.707	-0.194	0.846
ICEPT	<--- Postoperative	-0.791	-0.07	0.584	-1.356	0.175
ICEPT	<--- Neurologic disease	-0.956	-0.082	0.599	-1.596	0.11
ICEPT	<--- Cardiovascular disease	-0.15	-0.011	0.674	-0.223	0.824
ICEPT	<--- Admission route	-0.123	-0.016	0.407	-0.303	0.762
ICEPT	<--- Disease severity	-0.131	-0.024	0.28	-0.469	0.639
ICEPT	<--- Ventilator	-0.589	-0.045	0.674	-0.874	0.382
ICEPT	<--- Surgery	-0.623	-0.06	0.534	-1.168	0.243
ICEPT	<--- Delirium	2.447	0.166	0.76	3.219	0.001
ICEPT	<--- ICU days	0.001	0.001	0.034	0.026	0.979
ICEPT	<--- Discharge place	-3.158	-0.226	0.721	-4.378	***
SLOPE	<--- Gender	1.087	0.109	0.716	1.518	0.129
SLOPE	<--- Age	0.062	0.167	0.026	2.931	0.02
SLOPE	<--- Employment	-0.175	-0.018	0.705	-0.249	0.804
SLOPE	<--- Informed admission	-0.556	-0.048	0.839	-0.662	0.508
SLOPE	<--- FCI	-0.842	-0.174	0.347	-2.425	0.015
SLOPE	<--- Medical disease	-0.842	-0.065	0.935	-0.9	0.368
SLOPE	<--- Postoperative	-1.289	-0.12	0.772	-1.67	0.095
SLOPE	<--- Neurologic disease	-0.859	-0.078	0.793	-1.084	0.278
SLOPE	<--- Cardiovascular disease	0.052	0.004	0.891	0.058	0.954
SLOPE	<--- Admission route	0.061	0.008	0.538	0.113	0.91
SLOPE	<--- Disease severity	-0.123	-0.024	0.371	-0.332	0.74
SLOPE	<--- Ventilator	-1.143	-0.092	0.891	-1.283	0.2
SLOPE	<--- Surgery	1.426	0.145	0.706	2.021	0.043
SLOPE	<--- Delirium	-0.768	-0.055	1.005	-0.764	0.445
SLOPE	<--- ICU days	0.237	0.377	0.045	5.255	***
SLOPE	<--- Discharge place	0.886	0.067	0.954	0.929	0.353
PICS at 3 month	<--- ICEPT	1	0.686			
PICS at 3 month	<--- SLOPE	0	0			
PICS at 6 month	<--- ICEPT	1	0.724			
PICS at 6 month	<--- SLOPE	0.5	0.343			
PICS at 12 month	<--- ICEPT	1	0.683			
PICS at 12 month	<--- SLOPE	1	0.648			

References

1. This research was supported by a grant of Patient-Centered Clinical Research Coordinating Center (PACEN) funded by the Ministry of Health & Welfare, Republic of Korea (grant number: HC19C0226) and the National Research Foundation of Korea (NRF) grant funded by Korea government (MSIT) (no.NRF-2022R1A2C1011917).
2. Lee M, Kang J, Jeong YJ. Risk factors for post-intensive care syndrome: A systematic review and meta-analysis. *Aust Crit Care.* 2020 May;33(3):287–294. doi: <https://doi.org/10.1016/j.aucc.2019.10.004>.
3. Kang J, Lee M, Cho YS, Jeong JH, Choi SA, Hong J. The relationship between person-centred care and the intensive care unit experience of critically ill patients: A multicentre cross-sectional survey. *Aust Crit Care.* 2022 Nov;35(6):623–629. doi: <https://doi.org/10.1016/j.aucc.2021.10.010>.
4. Kang J, Cho YS. Cross-Cultural Validation of the Intensive Care Experience Questionnaire in Korean Critical Care Survivors. *Asian Nurs Res (Korean Soc Nurs Sci).* 2020 May;14(2):89–96. doi: <https://doi.org/10.1016/j.anr.2020.03.002>.
5. Jeong YJ, Kang J. Development and validation of a questionnaire to measure post-intensive care syndrome. *Intensive Crit Care Nurs.* 2019 Dec;55:102,756. doi: <https://doi.org/10.1016/j.iccn.2019.102756>.
6. Hong J, Kang J. Development and Validation of a Patient Version of Person-Centered Critical Care Nursing Questionnaire: A Methodological Study. *SAGE Open.* 2020;10(2). doi: <https://doi.org/10.1177/2158244020924423>

Topic: Nursing care and physiotherapy

000864

Relationship of passive leg raising compared with hypoperfusion biomarkers and ultrasound parameters in the evaluation of fluid responsiveness

M. Vidals-Sánchez¹, L. A. Gorordo-Delsol¹, J. C. Gasca-Aldama¹, L. A. Plascencia-Zurita², J. Garduño-López¹, M. A. Amezcua-Gutiérrez¹, L. Ortiz-Martínez³, K. H. Lopez Rodriguez¹, D. P. Vidals-Sánchez⁴, C. E. Lopez-Rodríguez¹

¹Intensive Care Unit, Hospital Juárez de México, Ciudad de México, Mexico; ²Intensive Care Unit, Hospital Central Norte Petróleos Mexicanos, Ciudad de México, Mexico; ³Geriatrics, Centro Medico Nacional 20 de Noviembre, Ciudad de México, Mexico; ⁴Internal Medicine, Hospital General Las Américas, Estado de Mexico, Mexico

Correspondence: M. Vidals-Sánchez

Intensive Care Medicine Experimental 2023, **11(Suppl 1)**:000864

Introduction: Hemodynamic optimization through fluid resuscitation is commonly used in critically ill patients with hypoperfusion. Recognition of patients who will benefit from volume administration still seems challenging. Some biomarkers have been related to hypovolemia states, so it is important to assess their ability to predict fluid responsiveness; likewise, the POCUS is a tool that helps to identify these patients; however, its accessibility is limited, and it has less predictive capacity than other tools.

Objectives: To determine the relationship in the evaluation of fluid responsiveness by means of passive leg raising (PLR) compared with hypoperfusion biomarkers and ultrasound parameters.

Methods: Observational, analytical, prospective study of a nested sample of patients with sepsis and/or septic shock admitted to an intensive care unit (ICU) at a Mexico City reference hospital, who were evaluated during the first 48 h of their admission.

Results: Data from 22 consecutive admissions were collected. Descriptive statistics were used to obtain the area under the ROC curve, comparing the PLR dichotomy variable vs hypoperfusion biomarkers (Table 1) or ultrasound parameters (Image 1). It was identified that the echocardiographic parameters were the best variables related to PLR in patients with sepsis and/or septic shock, being the velocity-time integral (VTI) the best parameter with an AUC ROC of 0.918, followed by the VTI variation with an AUC ROC of 0.801, inferior vena cava diameter (IVC) AUC ROC 0.788, peak lateral tricuspid annular systolic velocity (S1) of 0.778 AUC ROC, portal vein pulsatility AUC ROC 0.685 and

finally renal resistive index of 0.561 AUC ROC (image 1). Not finding a relationship between PLR and hypoperfusion biomarkers (Table 1).

Table 1 (abstract 000864) ROC curve for PLR versus hypoperfusion biomarkers. ScvO₂: Central venous oxygen saturation, pCO₂ gap: venous content CO₂ minus arterial content CO₂, CavO₂: arteriovenous oxygen content difference

	Hypoperfusion biomarkers	AUC-ROC
Passive Leg Raising	Serum lactate	0.676
	ScvO ₂	0.431
	pCO ₂ gap	0.401
	pCO ₂ gap/CavO ₂	0.474

Conclusions: Ultrasound variables can predict the outcome of fluid responsiveness assessment by PLR, while hypoperfusion biomarkers are weak in predicting this relationship. Ultrasound determinations can be an acceptable surrogate for PLR when real-time cardiac output measurement is not available.

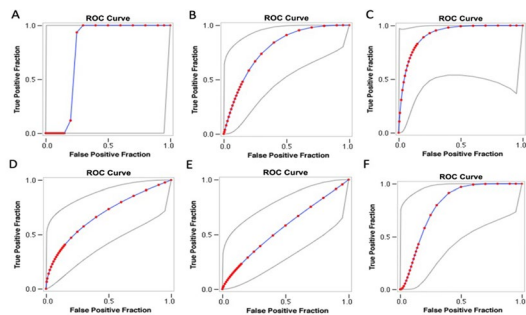

Image 1. ROC curve for PLR versus ultrasonographic measurements. A. PLR vs S1; B. PLR vs IVC; C. PLR vs VTI; D. PLR vs portal vein pulsatility; E. PLR vs renal resistive index; F. PLR vs VTI variation.

Figure (abstract 000864) ROC curve

References

- Miller, A., & Mandeville, J. (2016). Predicting and measuring fluid responsiveness with echocardiography. *Echo Research and Practice*, 3(2), G1–G12
- Horejsek, J., Kunstir, J., Michalek, P., & Porizka, M. (2022). Novel methods for predicting fluid responsiveness in critically ill patients-A narrative review. *Diagnostics (Basel, Switzerland)*, 12(2), 513
- Ünlüer, E. E., Karagöz, A., Bayata, S., Çatalakaya, S., & Bozdemir, H. (2019). A novel prediction of simulated fluid responsiveness by echocardiography assessment of tricuspid annulus tissue velocity with passive leg raising. *J Emerg Med* 102490791984406
- Vincent, J.-L., & Weil, M. H. (2006). Fluid challenge revisited. *Crit Care Med*, 34(5), 1333–1337.
- Hernández, G., Ospina-Tascón, G. A., Damiani, L. P., Estenssoro, E., Dubin, A., Hurtado, J., Friedman, G., et al. (2019). Effect of a resuscitation strategy targeting peripheral perfusion status vs serum lactate levels on 28-day mortality among patients with septic shock: The ANDROMEDA-SHOCK randomized clinical trial: The ANDROMEDA-SHOCK randomized clinical trial. *JAMA* 321(7), 654–664.
- Monnet, X., & Teboul, J.-L. (2018). Assessment of fluid responsiveness: recent advances. *Curr Opin Crit Care* 24(3), 190–195.
- Kattan, E., Castro, R., Miralles-Aguiar, F., Hernández, G., & Rola, P. (2022). The emerging concept of fluid tolerance: A position paper. *J Crit Care*, 71(154070), 154070
- Michard, F., & Teboul, J.-L. (2002). Predicting fluid responsiveness in ICU patients: a critical analysis of the evidence. *Chest*, 121(6), 2000–2008.
- Nassar, B., Badr, M., Van Grunderbeeck, N., Temime, J., Pepy, F., Gasan, G., Tronchon, L., et al., (2021). Central venous-to-arterial PCO₂ difference as a marker to identify fluid responsiveness in septic shock. *Sci Rep* 11(1), 17,256

Topic: Sepsis

000866

Clinical-epidemiological review of CRRT in septic shock patients in a district hospital ICU setting

D. da Costa Oliveira¹, P. Reis Pereira², D. Bento¹, S. Carvalho¹, A. Santos¹, F. Esteves¹

¹Intensive Care Unit, Centro Hospitalar De Trás-Os-Montes E Alto Douro, E.P.E., Vila Real, Portugal; ²Nephrology Department, Centro Hospitalar De Trás-Os-Montes E Alto Douro, E.P.E., Vila Real, Portugal

Correspondence: D. da Costa Oliveira

Intensive Care Medicine Experimental 2023, **11(Suppl 1)**:000866

Introduction: Sepsis and septic shock are major healthcare problems, with elevated mortality rates. In addition to the conventional use of continuous renal replacement therapy (CRRT) in acute kidney injury, CRRT can be a useful tool for immune response modulation in sepsis— influencing circulating levels of inflammatory mediators like cytokines and chemokines, the complement system, as well as factors of the coagulation cascade.

Objectives: We aimed to study the local epidemiological and clinical outcomes of patients with septic shock submitted to CRRT in our intensive care unit (ICU).

Methods: Our sample included patients hospitalized in a level two–three care district hospital ICU from January 2014 to May 2019. Patients with septic shock were defined according to the international consensus definitions at the hospitalization time. These patients were then divided into two groups – those submitted to CRRT versus those not submitted to CRRT during the ICU stay. We evaluated patients’ demographics, length of ICU and hospital stay, rate of mortality, and previous medical history of renal disease.

Results: The prevalence of septic shock in our ICU population during the selected period (n=3253) was 27.4% (n=890), with a median age of 70 years of age. Of these 890 patients, 166 (18.7%) were submitted to CRRT. The median time of ICU stay in patients that survived was 2 days longer in the CRRT group (9 days) when compared to the control group (7 days), but with no statistically significant difference between them. This was also verified when taking into account the total in-hospital stay, accounting for a difference of 3 more days in the CRRT group, with a median of 24 days versus 21 days in the control group. The CRRT group accounted for a statistically significantly higher mortality rate than the control group (p < 0.001), with a mortality rate of 48.2% and 27.3% respectively. In our sample, patients with septic shock and previous medical history of chronic kidney disease (CKD) had a statistically significantly higher mortality rate than those without CKD, with a mortality rate of 34.8% and 29.9% respectively (p < 0.001). In patients submitted to CRRT, those with a history of CKD, did not present with a higher mortality rate when compared to those without a history of CKD.

Conclusions: Patients with septic shock submitted to CRRT had a longer ICU and in-hospital stay than the control group, although this difference was not statistically different. A high mortality rate of 48.2% was verified in patients with septic shock who underwent CRRT. From our population, a medical history of CKD did not seem to be an indicator of higher mortality in patients subject to CRRT, but further analysis must be done with CKD stratification.

Topic: Sepsis

000868

Posterior Reversible Encephalopathy Syndrome (PRES). Analysis of a case series and clinical outcomesF. Fuentes Gorgas¹, S. Martin-Sastre², D. Campos³, E. Santamaría³, M. Sueiras⁴, V. Thonon⁴, C. Palmada², R. M. Gracia², R. Ferrer Roca⁵, A. Sánchez²¹Intensive Care Department, Vall d'Hebron University Hospital, Barcelona, Spain; ²Intensive Care Department, Vall d'Hebron Barcelona Hospital Campus, Barcelona, Spain; ³Neurology Department, Vall d'Hebron Barcelona Hospital Campus, Barcelona, Spain; ⁴Neurophysiology Department, Vall d'Hebron Barcelona Hospital Campus, Barcelona, Spain; ⁵Intensive care department, Vall d'Hebron University Hospital, Barcelona, Spain**Correspondence:** F. Fuentes Gorgas*Intensive Care Medicine Experimental* 2023, **11(Suppl 1)**:000868

Introduction: Posterior reversible encephalopathy syndrome (PRES) is a condition of reversible subcortical vasogenic brain edema in patients with critical neurological signs (seizures, encephalopathy, headache, and visual disorders) in the background of renal failure, blood pressure significant variations, autoimmune diseases, and obstetrics complications. Brain imaging usually shows vasogenic edema, mainly concerning the bilateral parieto-occipital areas. The pathophysiology of PRES concerns endothelial damage associated with drastic blood pressure transitions or immediate effects of cytokines on the endothelium, which conducts to the breakdown of the blood-brain barrier and successive brain edema. This process is commonly reversible and generally has a good prognosis. The increasing use of brain MRI has led to expanded recognition and characterization of the PRES syndrome. However, the lack of data from prospective studies is nevertheless an enormous issue in the knowledge of this condition.

Objectives: Our objective is to analyze the clinical characteristics of the series of PRES cases admitted to the Intensive Care Unit (ICU) of the Vall d'Hebron University Hospital (HUVH) in Barcelona between 2021 and 2022, as well as the repercussions of said diagnosis, about the therapeutic regimen. We hypothesize that critically ill patients who develop complications with PRES have a worse prognosis, increased hospital stay, and require significant modifications in treating the underlying disease.

Methods: During 2021 and 2022, our team diagnosed 7 cases of PRES in patients admitted to the ICU. Their clinical and demographic variables were prospectively analyzed; we followed up on these patients throughout their hospital admission. The primary variable was the requirement of a significant change in their baseline treatment (change/suspension of immunosuppressive medication, clinical decisions on end-of-life). We also evaluated the number of antiepileptic drugs (AEDs) and sedative dosages required during their admission to the ICU. Quantitative variables were expressed as median and interquartile range as they did not meet normality criteria according to the Kolmogorov-Smirnov test. Qualitative variables were expressed as frequencies and percentages. SPSS v15.0 was used.

Results: Our sample consists of 7 patients, with a median age of 42 (21, 64). 57% were women. The median ICU stay was 12 days (8, 15), and the hospital stay was 20 days (16, 107). The median APACHE-II value was 27 (17, 31). During admission, 28% died. Brain MRI could confirm the diagnosis of PRES in 85%. The baseline diagnoses were: a case of SAH during ECMO support due to COVID-19; in 2 cases, treatment with anticalcineurin inhibitors after a lung transplant; a case of severe preeclampsia; a case of polytrauma; a case of neuro lupus; a case of hypertensive crisis. Up to 57% required a significant change in their treatment plan. Specifically, one of the two post-operative double lung transplant patients had to change immunosuppression to rapamycin. In the case of the hypertensive crisis, it led to a deterioration in the level of consciousness that required reconnection to mechanical ventilation. They received 2 AEDs (1, 4) and two simultaneous sedatives (1, 3).

Conclusions: PRES is a rare but severe complication of critically ill patients with multiple underlying pathologies. In many cases, it implies a change in the therapeutic plan and is related to a more extended hospital stay. Its suspected diagnosis is usually confirmed with MRI.

References

- Li Y, Gor D, Walicki D, et al. Spectrum and potential pathogenesis of reversible posterior leukoencephalopathy syndrome. *J Stroke Cerebrovasc Dis* 2012; 21: 873–82.
- Fugate JE, Claassen DO, Cloft HJ, Kallmes DF, Kozak OS, Rabinstein AA. Posterior reversible encephalopathy syndrome: associated clinical and radiologic findings. *Mayo Clin Proc* 2010; 85:427–32.
- Burnett MM, Hess CP, Roberts JP, Bass NM, Douglas VC, Josephson SA. Presentation of reversible posterior leukoencephalopathy syndrome in patients on calcineurin inhibitors. *Clin Neurol Neurosurg* 2010; 112: 886–91.
- Bartynski WS, Boardman JF. Distinct imaging patterns and lesion distribution in posterior reversible encephalopathy syndrome. *AJNR Am J Neuroradiol* 2007; 28: 1320–27.

Topic: Neurointensive care

000871

Extracorporeal liver support in acute-on-chronic liver failure grade 3 – ADVanced Organ Support versus plasma exchangeM. Jahn¹, J. Korth², F. Saner³, A. Nowak³, P. Aurich⁴, F. Griesel¹, A. Katsounas⁴, B. Tyczynski²¹Nephrology, Alfried Krupp Krankenhaus, Essen, Germany; ²Nephrology, Essen University Hospital, Essen, Germany; ³General-, Visceral- and Transplantation Surgery, Essen University Medical Center, Essen, Germany; ⁴Medicine, Universitätsklinikum Knappschaftskrankenhaus Bochum, Ruhr-University, Bochum, Germany**Correspondence:** A. Perez Ruiz De Garibay*Intensive Care Medicine Experimental* 2023, **11(Suppl 1)**:000871

Introduction: Extracorporeal liver support (ECLS) is used to remove toxins and improve liver function in acute-on-chronic liver failure (ACLF). Plasma exchange (PE) is commonly used but has inconsistent results [1–5]. The ADVanced Organ Support system (ADVOS) is a new albumin dialysis system that regenerates albumin using temperature and pH changes and a small amount of albumin solution [6].

Objectives: This retrospective analysis compares survival and surrogate parameters in patients with ACLF grade 3 according to the CLIF criteria [7], treated at intensive care units (ICU) with standard of care and either ADVOS or PE.

Methods: All ACLF grade 3 patients who received either ADVOS or PE in ICUs of the general surgery or internal medicine department at the University Hospital in Essen from 20/03/2017 to 09/06/2022 were included. Demographics and surrogate markers were analyzed for 7 days after the first treatment. Data on extracorporeal treatments, transfusion units, ICU-LOS and LTx-free 28-day mortality rates were also documented.

Results: PE was administered to 31 patients who received 3 (2, 3) sessions in median, while 34 patients received 4 (1, 6) ADVOS sessions. As shown in Table 1, patients had high CLIF-C ACLF scores with a 28-day predicted mortality of 64% and 80% (p=0.079) for PE and ADVOS, respectively. The need for red blood cell (160 vs. 206 units) or platelet concentrate (32 vs. 68 units) transfusions was comparable during intensive care treatment. Patients in the PE group additionally received 1630 units of FFP. The ICU-LOS (10 vs. 8 days, p=0.283) and 28-day LTx-free mortality rates (90% vs. 85%, p=0.294) were comparable for PE and ADVOS groups, respectively. However, compared to the risk stratification by the CLIF-C ACLF score [8], the actual mortality in the PE group was much higher than predicted.

Table 1 (abstract 000871) Demographics, outcome and surrogate markers. Median (IQR)

Parameter	Time	PE	ADVOS	P groups
Age, [years]	Day 1	45 (36, 54)	54 (43, 60)	0.012*
Male gender	Day 1	61% (n = 19)	50% (n = 17)	0.368°
Listed to LTx	Day 1	61% (n = 19)	53% (n = 18)	0.673°

Parameter	Time	PE	ADVOS	P groups
Dialysis	Day 1	77% (n = 24)	85% (n = 29)	0.386°
CLIF-C ACLF Score	Day 1	62.0 (56.1, 71.7)	66.3 (61.8, 71.0)	0.112*
CLIF-C ACLF predicted 28-day mortality	Day 1	64% (44, 93)	80% (63, 92)	0.079*
Actual mortality rate (%)	Day 14	84% (n = 26)	76% (n = 26)	0.543°
	Day 28	90% (n = 28)	85% (n = 29)	0.711°
AUROC CLIF-C ACLF	Day 28	0.821 (0.676; 0.967)	0.544 (0.320; 0.767)	0.1075
p-value Calibration CLIF-C ACLF	Day 28	0.002#	0.198#	
Creatinine [mg/dl]	Day 1	2.26 (1.37, 3.23)	1.95 (1.45, 2.44)	0.335*
	Day 7	1.82 (1.20, 2.71)	1.24 (0.84, 1.48)	0.023*
Albumin [mg/dl]	Day 1	2.7 (2.4, 3.3)	2.8 (2.2, 3.5)	0.772*
	Day 7	2.9 (2.8, 3.3)	3.4 (2.8, 4.7)	0.881*
Bilirubin [mg/dl]	Day 1	21.5 (15.0, 28.9)	12.3 (7.2, 20.4)	0.010*
	Day 7	17.7 (13.8, 23.6)	18.6 (12.6, 28.4)	0.698*

Conclusions: ECLS and PE had comparable survival rates, but predicted mortality rates are significantly different in the PE group. While PE is commonly considered the best ECLS for ACLF [1, 2, 5], this first comparison of PE versus ADVOS does not support this claim. Baseline characteristics of patients differed between the two groups, limiting the evidence of the data and requiring larger trials in these patients. Further analysis is needed to understand the impact of both ECLS in vulnerable cirrhotic patients. The ADVOS system uses a minimal albumin volume, which contrasts with the large plasma substitutions of PE and their associated risks on inflammation and coagulation pathways.

References

2. Ociskay K, Kanjo A, Gede N, et al. Uncertainty in the impact of liver support systems in acute-on-chronic liver failure: a systematic review and network meta-analysis. *Ann Intensive Care*. 2021;11(1):10. Doi: <https://doi.org/10.1186/s13613-020-00795-0>
3. Alshamsi F, Alshammari K, Belley-Cote E, et al. Extracorporeal liver support in patients with liver failure: a systematic review and meta-analysis of randomized trials. *Intensive Care Med*. 2020;46(1):1–16. Doi: <https://doi.org/10.1007/s00134-019-05783-y>
4. Liu H, Zhang Q, Liu L, et al. Effect of artificial liver support system on short-term prognosis of patients with hepatitis B virus-related acute-on-chronic liver failure. *Artif Organs*. 2020;44(10):E434–E447. Doi: <https://doi.org/10.1111/aor.13710>
5. Wan Y-M, Li Y-H, Xu Z-Y, et al. Therapeutic plasma exchange versus double plasma molecular absorption system in hepatitis B virus-infected acute-on-chronic liver failure treated by entecavir: A prospective study. *J Clin Apher*. 2017;32(6):453–461. Doi: <https://doi.org/10.1002/jca.21535>
6. Huber W, Henschel B, Schmid R, Al-Chalabi A. First clinical experience in 14 patients treated with ADVOS: a study on feasibility, safety and efficacy of a new type of albumin dialysis. *BMC Gastroenterol*. 2017;17(1):32. Doi: <https://doi.org/10.1186/s12876-017-0569-x>
7. Moreau R, Jalan R, Gines P, et al. Acute-on-chronic liver failure is a distinct syndrome that develops in patients with acute decompensation of cirrhosis. *Gastroenterology*. 2013;144:1426–1437, 1437 e1–9. Doi: <https://doi.org/10.1053/j.gastro.2013.02.042> [doi]
8. Jalan R, Saliba F, Pavesi M, et al. Development and validation of a prognostic score to predict mortality in patients with acute-on-chronic liver failure. *J Hepatol*. 2014;61:1038–1047. Doi: [S0168-8278\(14\)00408-5 \[pii\] doi: https://doi.org/10.1016/j.jhep.2014.06.012](https://doi.org/10.1016/j.jhep.2014.06.012) [doi]

8. 1. Maiwall R, Bajpai M, Choudhury AK, et al. Therapeutic plasma-exchange improves systemic inflammation and survival in acute-on-chronic liver failure: A propensity-score matched study from AARC. *Liver Int Off J Int Assoc Study Liver*. 2021;41(5):1083–1096. Doi: <https://doi.org/10.1111/liv.14806>

Topic: Metabolism, endocrinology, liver failure and nutrition

000872

Retrospective microbiological study of 336 cannulae after ECMO support

F. Fuentes Gorgas¹, J. Domènech¹, M. Vicente², V. Rodríguez², S. Martín-Sastre¹, A. Mera¹, C. Bonilla¹, A. Pacheco¹, L. Chiscano¹; M. Martínez¹, E. Argudo¹, I. Vazquez¹, A. Benavides¹, G. Padron¹, M. Cobos¹, E. Gallart¹, P. Giron¹, R. Ferrer Roca¹, X. Nuvials¹, J. Riera del Brio¹

¹Intensive Care Department, Vall d'Hebron Barcelona Hospital Campus, Barcelona, Spain; ²Microbiology and Clinics Laboratory Service, Vall d'Hebron Barcelona Hospital Campus, Barcelona, Spain.

Correspondence: F. Fuentes Gorgas

Intensive Care Medicine Experimental 2023, **11(Suppl 1)**:000872

Introduction: Extracorporeal membrane oxygenation (ECMO) is a support strategy for patients with refractory cardiogenic shock or refractory acute respiratory distress syndrome. Nosocomial infection often appears in ECMO patients, although documented rates differ from the different clinical series, varying between 5% and over 60%. The infectious complication could associate with a worse outcome, specially in-hospital mortality. Nowadays, the most frequently documented nosocomial infections in ECMO patients are ventilator-associated pneumonia and bloodstream infection. There is no clear association between bloodstream infections and ECMO-device-related infections, especially cannula-related infections (CRI). While it appears that (CRI) is frequent, few studies have registered this complication, and no considerable study has assessed the factors and prognosis of CRI in patients supported by ECMO. Currently, there are no guidelines for diagnosing and managing CRI. A better knowledge of the characteristics of CRI in patients supported by ECMO could help reduce the risk factors associated with this infection. It could improve the management of affected patients. This study aimed to assess the incidence, microbiological characteristics, and prognosis of CRI in patients supported by ECMO.

Objectives: Colonization of the cannula during ECMO support is a frequent complication associated with worse outcomes when catheter-related infections appear. We aimed to describe the results of the microbiological culture of the cannula tips once the ECMO support finishes. We analyzed cannula colonization's incidence, risk factors, and clinical outcomes.

Methods: A single-center retrospective study including all venovenous and venoarterial ECMO patients admitted to the Vall d'Hebron University Hospital (Barcelona, Spain) between January 2016 and July 2022. Cannulation was either percutaneous by the Seldinger procedure or by open dissection under direct vision by our team. The cannulations were executed at our hospital or other facilities, where the ECMO team traveled by ambulance. The cannulae were removed under sterile conditions at the end of ECMO therapy. The distal portion of the catheter (approximately 5 cm) was sent for microbiological examination. We performed a descriptive analysis by calculating frequencies and percentages of qualitative variables. We did a bivariate statistical analysis by performing a chi2-test.

Results: A total of 292 patients received ECMO support during the study period, and in 51% of patients, cannulae were correctly sent and cultivated in our laboratory. Antibiotic prophylaxis from cannulation until ECMO withdrawal with either Vancomycin or Daptomycin was used in 205 patients (70%). The total number of cannulae cultivated was 336, of which 26% were positive. Almost half of the cultures were positive for coagulase-negative Staphylococci (CNS) (47.7%). The

second microorganism more frequently isolated was *Candida* spp (32%), followed by *Klebsiella* spp (11.36%), *Pseudomonas* spp (4.54%), and *Enterococcus faecium* (3.4%). We did not find statistical significance between the facility of ECMO cannulation or site of cannulation and the incidence of cannula infection. The 28-day survival of patients with at least one cannula infection was 72%, with no statistical difference from the survival of patients with negative cultures.

Conclusions: One in four patients receiving ECMO support may suffer colonization/infection of cannulae, despite antibiotic prophylaxis. This frequency is the same independently of the site of cannulation and the facility where the process was performed. The positivity of cannulae cultures was not associated with higher mortality. Prospective investigations are needed to confirm these findings, and an evidence-based definition of colonization and infection is strongly needed.

References

1. Kim T, Cho WH, Kim D, Jeon D, Kim YS, Yeo HJ. Microbial Colonization of Oxygenator and Clinical Outcomes in Extracorporeal Membrane Oxygenation. *Asaio J*. 2021; Publish Ahead of Print(8):930–4.
2. Thomas G, Hraiech S, Cassir N, Lehingue S, Rambaud R, Wiramus S, et al. Venovenous extracorporeal membrane oxygenation devices-related colonisations and infections. *Ann Intensive Care*. 2017;7(1):111.
3. MacLaren G, Schlapbach LJ, Aiken AM. Nosocomial Infections During Extracorporeal Membrane Oxygenation in Neonatal, Pediatric, and Adult Patients: A Comprehensive Narrative Review. *Pediatr Crit Care Me*. 2020;21(3):283–90.
4. Martínez-Martínez M, Nuvials FX, Riera J. Nosocomial infections during extracorporeal membrane oxygenation. *Curr Opin Crit Care*. 2022; Publish Ahead of Print.
5. Allou N, Pinto HL, Persichini R, Bouchet B, Braunberger E, Lugagne N, et al. Cannula-Related Infection in Patients Supported by Peripheral ECMO. *Asaio J*. 2019;65(2):180–6.

Topic: Infections and prevention

000873

Cold-water immersion reduces intestinal injury caused by exertional heat stroke via regulating gut microbiota in rats

Y. X. Zhang¹, L. Xuan¹

¹Critical Care Medicine, The Eighth Medical Center of Chinese PLA General Hospital, Beijing, China

Correspondence: Y.X. Zhang

Intensive Care Medicine Experimental 2023, **11**(Suppl 1):000873

Introduction: Exertional heat stroke (EHS) is a life-threatening metabolic disorder involving thermoregulatory failure and is typically associated with severe intestinal injury. Growing evidence confirms that dysbiosis of gut microbiota contributes to intestinal injury pathophysiology. Recent studies have indicated that dysbiosis of gut microbiota disrupts the integrity of the intestinal barrier, thereby inducing gut-derived endotoxemia, systemic inflammatory responses, and multiple-organ injury. Thus, intestinal injury caused by dysbiosis of gut microbiota can be considered an important pathological phenotype of EHS progression, and maintaining intestinal homeostasis might prevent EHS onset and subsequent pathology. Cold-water immersion (CWI) is the most effective therapeutic strategy for EHS. Previous studies reveal that CWI exerts the therapeutic effects of EHS by increasing the blood flow to the heart and inhibiting the hypermetabolic state of the organ. However, the effect of CWI on intestinal injury caused by EHS has not been well investigated. Therefore, it is of great significance to study the role of CWI in intestinal injury caused by EHS. This study focuses on clarifying the specific molecular mechanism of EHS intestinal injury and providing new EHS therapeutic targets.

Objectives: To investigate the protective effects of CWI on EHS-inducing intestinal injury, and further determine if CWI achieves its therapeutic effect by modulating gut microbiome.

Methods: The Rat EHS model was established by a previous protocol. The animals were placed in the artificial climate chamber (Temperature: 39.5 °C; relative humidity: 65%). After 40 min, rats were quickly placed on the running wheel for EHS induction. Rats were divided into three groups: control group (CTRL group), EHS group (EHS), and CWI group (EHS + CWI treatment). The pathological changes of the ileum and colon were observed by naked eyes and hematoxylin–eosin (H&E) staining. The composition of gut microbiota was examined by rat fecal gene sequencing. Metabolomics analysis was performed to characterize the metabolic profile differences between the CTRL group, EHS group, and CWI group.

Results: The morphology and H&E staining of the ileum showed that the intestinal injury in the EHS group was more serious, while in the CWI group was significantly less than that in the EHS group. The results of rat fecal microbial analysis exhibited that CWI alleviates EHS-inducing dysbiosis of gut microbiota, in particular, CWI promoted the abundance of probiotics, including *Prevotella*, *Allisonella*, *Megamonas*, and *Succinispira*, while CWI reduced the abundance of pathogenic bacteria, including *Desulfampius*, *Desulfococcus*, and *Desulfovibrio*. Further metabolomic analysis shows CWI attenuated the alteration of metabolic profiles induced by EHS. Moreover, we identified a total of 42 different metabolites between the EHS and CWI groups. And the levels of potential biomarkers, including Inosine, Guanosine, Hypoxanthine, Arabinosylhypoxanthine, Taurine, and Anserine showed significant correlations with gut microbiota.

Conclusions: CWI treatment mitigates the intestinal injury caused by EHS by enhancing the strain ratio of probiotics, while reducing the abundance of pathogenic bacteria, which in turn to improve the energy metabolic state of the intestinal epithelium and enhances small intestinal mucosal repair in EHS rats. The co-regulatory effect of CWI on microbial-metabolites is expected to provide a new basis for the treatment of EHS.

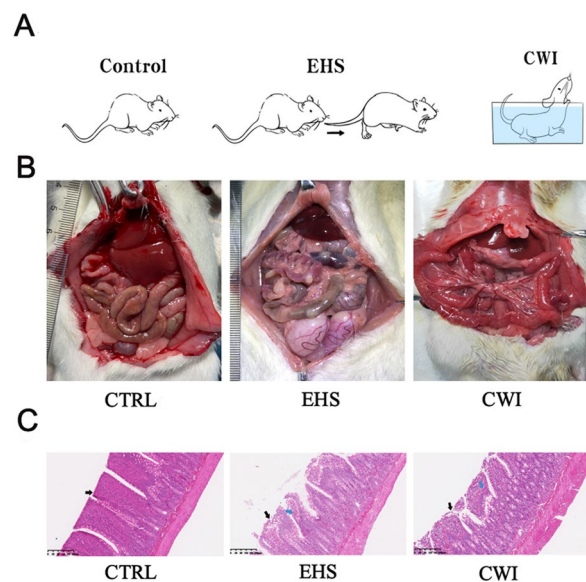

Fig. 1 (abstract 000873) CWI intervention mitigates the EHS-inducing intestinal injury A EHS establishment and CWI intervention protocol. B, C The pathological changes of ileum and colon were observed by naked eyes (B) and haematoxylin–eosin (H&E) staining (C)

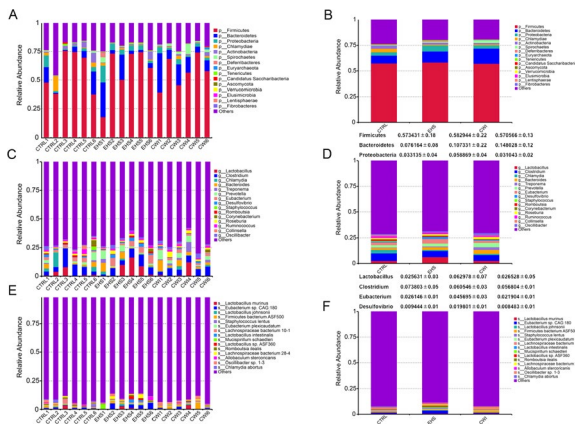

Fig. 2 (abstract 000873) Effect of CWI on intestinal microbial diversity and structure. **A, B** Relative bacterial distribution at the phylum level (top15). **C, D** Relative bacterial distribution at the genus level (top15). **E, F** Relative bacterial distribution at the species level (top15)

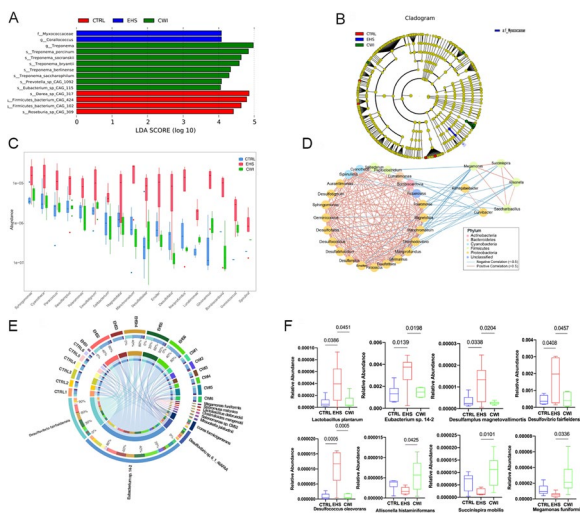

Fig. 3 (abstract 000873) CWI modulated EHS-induced alteration in microbial community. **A** Taxonomic evolutionary branching diagram displayed the phylogenetic distribution of microbiota in each group. **B** LefSe bar graph showed significant differences in bacteria in each group. **C** Differentially abundant genera in each group. **D** Co-occurrence network of the differentially abundant genera in each group. **E** Circos plot graph showed the species-sample (top 10) abundance correlations in each group. **F** Quantification of differentially abundant strains in each group

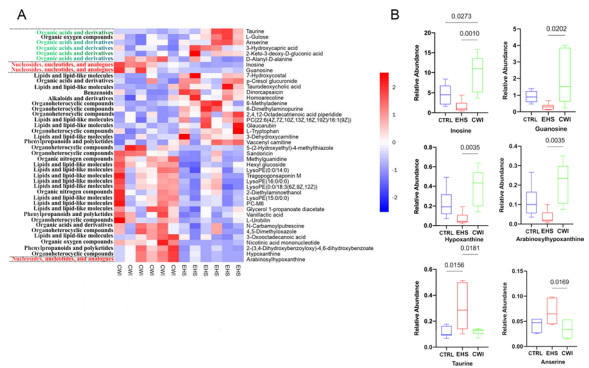

Fig. 4 (abstract 000873) CWI modulated EHS-induced alteration in metabolites. **A** Heatmap of hierarchical clustering analysis based on metabolite z-normalized abundances. **B** Quantification of different intensities of metabolites in each group

References

1. Casa D J, McDermott B P, Lee E C, et al. Cold water immersion: the gold standard for exertional heatstroke treatment[J]. Exercise and sport sciences reviews, 2007, 35(3): 141–149.
2. Hutchins K P, Minnett G M, Stewart I B. Treating exertional heat stroke: Limited understanding of the female response to cold water immersion[J]. Frontiers in Physiology, 2022, 13: 2408.
3. Zou Y T, Zhou J, Wu C Y, et al. Protective effects of Poria cocos and its components against cisplatin-induced intestinal injury[J]. Journal of ethnopharmacology, 2021, 269: 113722.
4. Li X Y, He C, Zhu Y, et al. Role of gut microbiota on intestinal barrier function in acute pancreatitis[J]. World journal of gastroenterology, 2020, 26(18): 2187–2193.
5. Tang J, Xu L, Zeng Y, et al. Effect of gut microbiota on LPS-induced acute lung injury by regulating the TLR4/NF-κB signaling pathway[J]. International immunopharmacology, 2021, 91: 107272.
6. Leyk D, Hoitz J, Becker C, et al. Health risks and interventions in exertional heat stress[J]. Deutsches Ärzteblatt International, 2019, 116(31–32): 537–544.
7. Medical Center of Chinese PLA General Hospital major Project (2021ZD002), (2016ZD-008)
8. Military Medical Innovation Project (18CXZ023)
9. He S, Li R, Peng Y, et al. ACSL4 contributes to ferroptosis-mediated rhabdomyolysis in exertional heat stroke[J]. Journal of Cachexia, Sarcopenia and Muscle, 2022, 13(3): 1717–1730.

Topic: Sepsis

000874

Pubic symphysis sonographic evaluation in trauma patients: a comparison between CT scan and ecographic measurement

E. Binda¹, A. Ongaro¹, D. Gasberti², G. Zocchi², P. Nazerian³, C. Sepe⁴, E. Maffei⁵, B. Castelli⁶, F. Magni⁷, L. Bertù⁸, S. Montani¹, J. Costa⁹, A. Coppola¹⁰, F. G. De¹¹, G. Gini¹²; E. Borotto²

¹Specializzanda in Anestesia, Rianimazione, Terapia Intensiva e del Dolore, Università degli Studi dell'Insubria, Varese, Italy; ²Anestesia e

Rianimazione Neurochirurgica e Generale, the District Hospital - Entrance via Lazio, Varese, Italy; ³Medicina e Chirurgia d'Urgenza e Accettazione, Careggi University Hospital, Firenze, Italy; ⁴U.O.C. Pronto soccorso, Spedali Civili di Brescia, Brescia, Italy; ⁵Laureato in Medicina e Chirurgia, Università degli Studi dell'Insubria, Varese, Italy; ⁶Specializzando in Medicina di emergenza-urgenza, Università degli Studi dell'Insubria, Varese, Italy; ⁷Pronto Soccorso e Medicina d'Urgenza, the District Hospital - Entrance via Lazio, Varese, Italy; ⁸Statistica, Università degli Studi dell'Insubria Scuola di Medicina, Varese, Italy; ⁹Chirurgia Generale d'Urgenza e dei Trapianti, the District Hospital - Entrance via Lazio, Varese, Italy; ¹⁰Radiologia Varese, the District Hospital - Entrance via Lazio, Varese, Italy; ¹¹Ortopedia e Traumatologia Varese, the District Hospital - Entrance via Lazio, Varese, Italy; ¹²U.O.C. Pronto Soccorso, Ospedale Valduce - Como, Como, Italy

Correspondence: E. Binda

Intensive Care Medicine Experimental 2023, **11(Suppl 1)**:000874

Introduction: Pelvic fractures are a relatively rare occurrence in traumatized patients: their prevalence is about 3% of all the skeletal fractures and rises up to 25% in polytraumatized patients.^{1–2} However, their occurrence is characterized by a significant mortality rate, ranging from 10 to 50%.³ In particular, fractures of the pelvic girdle with a pubic symphysis diastasis > 2–2,5 cm are associated with an increase of pelvic volume, thus facilitating the occurrence of life-threatening retroperitoneal haemorrhages.^{4–6}

CT scan currently represents the gold standard for detection of pelvic fractures, however its use can be limited in particular situations, such as in haemodynamically unstable patients. X-ray has a low sensitivity (67%).⁵ US is routinely used in the primary survey in major trauma, however E-FAST cannot detect retroperitoneal haemorrhage.

Objectives: The objective of the present study is to compare CT scan and US measurement of pubic symphysis (PS) diastasis, in order to determine whether sonography allows to perform an accurate early diagnosis of symphyseal diastasis in open book pelvic injuries.

Methods: This is a multicenter, prospective, cohort study, performed on patients admitted to Spedali Civili of Brescia, Ospedale Careggi of Florence and Ospedale di Circolo e Fondazione Macchi of Varese between December 2020 and July 2022. Total body CT scan symphysis measurements were performed by a radiologist; US symphysis measurements (Fig 1) by an experienced operator who used predefined criteria. According to the local protocol, one centre did not report precise symphysis measurement but only recorded data as presence or absence of diastasis (2,5 cm cut-off).

Results: A total of 208 patients were included in the study. In 102 only the presence or absence of diastasis (according to a cut-off of 2,5 cm) was measured, while in the remaining group complete assessment was available. US and CT scan detected PS widening in six patients (2,9%), while 198 (95%) were negative for diastasis after both tests. Discordant results were found in 2 patients (0,9%): in the first case, US did not detect the diastasis but an experienced operator was not available. In the second one, US overestimated symphyseal diastasis, however the patient was haemodynamically unstable and underwent surgery for a diastasis of posterior sacroiliac joint. Using the Bland-Altman plot, we found an excellent agreement between the two diagnostic tests ($r: 0.849$, Fig. 2).

Conclusions: US evaluation of pubic symphysis appears to be a rapid, reliable, bed-side method to allow early identification of symphyseal diastasis in open book injuries, which is associated with a high risk of haemorrhages. Our data suggest that US may overestimate the pubic symphysis measurements in comparison with CT scan, however this difference appears to be minimal below 5 cm of diastasis. This discordance is not relevant above 5 cm, since it does not affect the clinical management of patients. US evaluation can also be performed in pre-hospital settings, thus allowing a better management of the patients and their transfer to the most appropriate hospital and an alternative evaluation tool in hospitals where CT scan and X-ray are not immediately available.

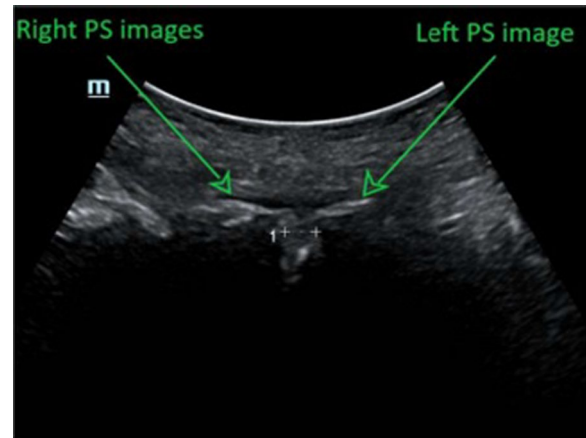

Figure 1 (abstract 000874) US measurement of pubic symphysis

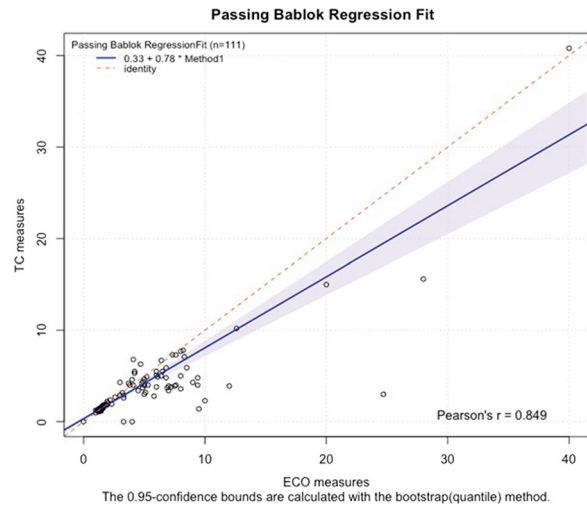

Figure 2 (abstract 000874) Passing Bablok Regression

References

6. Bauman M, Marinaro J, Tawil I, Crandall C, Rosenbaum L, Paul I. Ultrasonographic determination of pubic symphyseal widening in trauma: the FAST-PS study. *J Emerg Med*. 2011 May;40(5):528–33. doi: <https://doi.org/10.1016/j.jemermed.2009.08.041>. Epub 2009 Nov 17. PMID: 19,926,435.
5. Guillaumondegui, O. D. et al. Pelvic Radiography in Blunt Trauma Resuscitation: A Diminishing Role Background: An anteroposterior pel. (2002) doi: <https://doi.org/10.1097/01.TA.0000028858.23677.AB>.
4. Blackmore, C. C. et al. Predicting major hemorrhage in patients with pelvic fracture. *Journal of Trauma—Injury, Infection and Critical Care* 61, 346–352 (2006).
3. Grotz, M. R. W. et al. Open pelvic fractures: Epidemiology, current concepts of management and outcome. *Injury* vol. 36 1–13 Preprint at doi: <https://doi.org/10.1016/j.injury.2004.05.029> (2005).
2. Martinelli, T. et al. Intra-Aortic Ballon Occlusion to Salvage Patients With Life-Threatening Hemorrhagic Shocks From Pelvic Fractures.
1. Coccolini, F. et al. Pelvic trauma: WSES classification and guidelines. *World Journal of Emergency Surgery* vol. 12 Preprint at doi: <https://doi.org/10.1186/s13017-017-0117-6> (2017).
7. None

Topic: Trauma

000875

Extracorporeal multimodal hemoperfusion with Efferon LPS to abrogate cell-free plasma DNA circulation in septic shock patients

V. Pisarev¹, S. I. Rey², V. V. Kulabukhov², A.S. Popov³, O. V. Nikitina², M. A. Magomedov⁴, S. V. Masolitin⁴, O. V. Ignatenko⁵, N. P. Krotenko⁵, A. N. Marysheva⁵, N. I. Chaus⁶, L. V. Ohinko⁶, M. S. Mendibaev⁶, A. G. Chumachenko¹

¹V.A. Negovsky Research Institute of General Reanimatology, Federal Research and Clinical Center of Intensive Care Medicine and Rehabilitology, Moscow, Russia; ²Department of Emergency Surgery, Endoscopy and Intensive Care, N.V. Sklifosovsky Research Institute for Emergency Medicine, Moscow, Russia, Moscow, Russia; ³Laboratory of Stereochemistry of Sorption Processes, Nesmeyanov Institute Of Organoelement Compounds, Russian Academy of Sciences, Moskva, Russia; ⁴ICU, N.I. Pirogov City Clinical Hospital N1, Moscow, Russia; ⁵ICU, S.S. Yudin City Clinical Hospital, Moscow, Russia; ⁶Department of Anesthesiology and Intensive Care, V.P. Demikhov City Clinical Hospital, Moscow, Russia

Correspondence: V. Pisarev

Intensive Care Medicine Experimental 2023, **11(Suppl 1)**:000875

Introduction: Increased cell-free plasma DNA (cfpDNA) levels in critical illness are indicative of cell destruction and associate with endothelial damage, multiorgan failure, metabolomic alterations, proinflammatory signaling and mortality predicting in sepsis (1–4). Independently on causative or associative link of diminishing cfpDNA and/or course and outcome prediction, cfpDNA level represents a valuable biomarker indicative of successfulness of a care strategy in a particular patient.

Objectives: The aim of the study was to determine if the extracorporeal multimodal hemoperfusion (EMH) with Efferon LPS extracorporeal adsorber that binds LPS and proinflammatory mediators [5–7] is capable to rapidly abrogate cfpDNA levels.

Methods: Adult patients with septic shock (Sepsis-3) [8] (n=58) within first 12 h since the start of vasopressors infusion and within 24 h after surgical intervention, were included in the study. Patients undergoing extracorporeal hemoperfusion (ECH, n=36) received two treatments, 24 h apart, and two patients received only one treatment. Control group (CG, n=20) received no ECH, conventional therapy only. ECH was performed using Efferon LPS adsorbers containing mesoporous polymeric scaffold armed with the LPS-selective ligand to sequester both proinflammatory molecules and LPS [5]. Severity of the disease was assessed using clinical scales, hemodynamic parameters, vasopressor use, and oxygenation index. The platelet, leukocyte, lymphocyte, neutrophil counts, levels of C-reactive protein (CRP), procalcitonin (PCT), interleukin-6 (IL-6) and lactate were determined at the baseline and 72 h after inclusion in the study. Endotoxin levels were determined using the kinetic chromogenic LAL test. DNA was purified from quickly-frozen, one-time defrosted plasma samples using organic solvents. DNA concentration was determined by fluorimetry using SYBR green dye. STATA 16.0 (StataCorp, USA) and Excel 2019 with XLStat 2019 add-in (Addinsoft) were employed for statistical analysis.

Results: The median duration of hemoperfusion was 300 (300; 360) minutes for the first treatment and 300 (250; 300) minutes for the second treatment. No differences in clinical and laboratory parameters found between ECH and CG groups at a baseline. There were several clinical benefits in patients underwent ECH: (a) increasing the cumulative hospital survival: sHR=2.2 (1.1–4.3, p=0.029, Grey test); (b) significant decreasing multiorgan failure including SOFA scores values in 72 h after the start of ECH from 7 (7;9) to 3(2;7), p=0.012; (c) the duration of septic shock in the survived patient cohorts significantly differed dependent on the mode of treatment: median time to blood pressure normalization was 57 (37; 80) hours in the ECH group versus 101 (58; 197) hours in the control (sHR=2.20; 95% CI: 1.11–4.34; p=0.029); (d) significant increasing the PaO₂/FiO₂ index in ECH vs CG patients (p<0.001); (e) significant decreasing proinflammatory biomarkers PCT, CRP, IL-6, and reduction of bacterial LPS

concentration (Fig. 1, A-D); (f) significant decreasing the leukocytes and neutrophils count in ECH vs CG patients (p<0.01). To describe DNA elimination, we used the following regression model: $cfpD_{NA72h} = cfpD_{NA0} \times (1-E) + G^*$, where E was the proportion of eliminated cfpDNA in 72 h, G—generation of cfpDNA in 72 h. At R²=0.32, the following estimates of model parameters were obtained: elimination of cfpDNA (E) was 17% and 84%, in CG and ECH group patients, respectively (p=0.003), demonstrating significantly increased elimination of cfpDNA in ECH, but not in CG patients. The concentration of cfpDNA in the CG and ECH groups was not significantly different: G=17 and 63 ng/mL, respectively, p=0.082. Extracorporeal removal of cfpDNA can be estimated as the difference in elimination of cfpDNA with and without ECH, thus the removal of cfpDNA by the Efferon LPS adsorber after two ECH cycles was 67% (95% CI: 22–89). The increased cfpDNA levels in patients possessing the cfpDNA values within the upper quartile before ECH significantly decreased post-ECH (Fig. 1, E). Significant trend in diminishing the cfpDNA levels associated with ESH treatment became more evident when day 0 and day 3 cfpDNA levels from both groups were plotted (Fig. 1, F, p<0.003).

Conclusions: Treatment the septic shock patients with Efferon LPS resulted in decreasing the increased cfpDNA levels associated with significant clinical improvements.

Fig.1. Extracorporeal hemoperfusion with Efferon LPS halts accumulation of inflammatory mediators and cfpDNA in blood

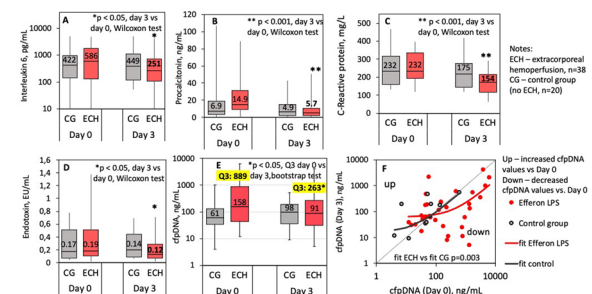

Figure 1 (abstract 000875) .

References

1. Johansson PI, Nakahira K, Rogers AJ, McGeachie MJ, Baron RM, Fredenburgh LE, Harrington J, Choi AMK, Christopher KB. Plasma mitochondrial DNA and metabolomic alterations in severe critical illness. *Crit Care*. 2018 Dec 29;22(1):360. doi: <https://doi.org/10.1186/s13054-018-2275-7>.
2. Faust HE, Reilly JP, Anderson BJ, Ittner CAG, Forker CM, Zhang P, Weaver BA, Holena DN, Lanken PN, Christie JD, Meyer NJ, Mangalmurti NS, Shashaty MGS. Plasma Mitochondrial DNA Levels Are Associated With ARDS in Trauma and Sepsis Patients. *Chest*. 2020 Jan;157(1):67–76. doi: <https://doi.org/10.1016/j.chest.2019.09.028>.
3. Wang L, Zhou W, Wang K, He S, Chen Y. Predictive value of circulating plasma mitochondrial DNA for Sepsis in the emergency department: observational study based on the Sepsis-3 definition. *BMC Emerg Med*. 2020 Apr 16;20(1):25. doi: <https://doi.org/10.1186/s12873-020-00320-3>.
4. Pisarev V.M., Chumachenko A.G., Filev A.D., Ershova E.S., Kostyuk S.V., Veiko N.N., Grigoriev E.K., Elygina E.V., Cherpakov R.A., Tutelyan A.V. Combination of DNA Molecular Biomarkers in the Prediction of Critical Illness Outcome. *General Reanimatology (Obshaya Reanimatologia)*. 2019;15(3):31–47. doi: <https://doi.org/10.15360/1813-9779-2019-3-31-47>.
5. Bessonov I.V., Morozov A.S., Kopitsyna M.N. A polymeric sorbent, preparation and use thereof. Patent WO2018217137A1 / US20200139348A1, 2018 6. Ushakova ND, Tikhonova SN, Rozenko DA. Hemosorption by a Column Adsorber Based on Hyper-Cross-Linked Styrene–Divinylbenzene Copolymer with Immobilized Lipopolysaccharide-Selective Ligand in Combined Intensive Care of Lung Cancer-Related Postoperative Acute Lung Injury (Case Report). *Obshaya Reanimatologiya (General Reanimatology)*. 2020;16(4):14–20. doi: <https://doi.org/10.15360/1813-9779-2020-4-14-20>.
7. Magomedov M.A., Kim T.G., Masolitin S.V., Yaralian A.V., Kalinin E.Yu., Pisarev V.M. Use of Sorbent Based on Hypercrosslinked Styrene–Divinylbenzene Copolymer With Immobilized LPS-Selective Ligand In Hemoperfusion For Treatment of Patients With Septic Shock. *Obshaya Reanimatologiya (General Reanimatology)*.

2020;16(6):31–53. doi: <https://doi.org/10.15360/1813-9779-2020-6-31-53>
 8. Singer M., Deutschman C.S., Seymour C.W. et al. The Third International Consensus Definitions for Sepsis and Septic Shock (Sepsis-3). JAMA; 2016; 315(8): 801–810. doi: <https://doi.org/10.1001/jama.2016.0287>

Topic: Sepsis

000876

Comparing Central vs Peripheral Venoarterial Extracorporeal Membrane Oxygenation (VA ECMO) outcome in a tertiary Cardiac Surgery intensive care unit

M. Antonopoulos¹, D. Elaiopoulos¹, A. Tasouli¹, M. Chronaki¹, I. Vlahodimitris¹, E. Tzatzaki¹, M. Bonios², C. Kindi¹, D. Doubou¹, A. Koliopoulou³, S. Dimopoulos¹

¹Icu, Onassis Cardiac Surgery Center, Kallithea, Greece; ²HF and Transplant Units, Onassis Cardiac Surgery Center, Kallithea, Greece; ³Cardiac Surgery and Transplant Units, Onassis Cardiac Surgery Center, Kallithea, Greece

Correspondence: M. Antonopoulos

Intensive Care Medicine Experimental 2023, **11(Suppl 1)**:000876

Introduction: VA ECMO has emerged as an effective rescue intervention in patients with cardiogenic shock refractory to standard treatment protocols and its use is rising worldwide in the last decade (1). It is also used as a salvage intervention in patients who are undergoing cardiac surgery and cannot be separated from cardiopulmonary bypass despite inotropic, vasopressor and intra-aortic balloon pump counter pulsation (IABP) support. The latter condition known as post cardiomy shock (PCS) occurs in 0.5% to 1.5% of all cardiac surgeries (2). Although experience and availability is growing, outcomes in surgical subjects remain poor (3), partially due to support of older and more complex critically ill patients. There is a need for more robust evidence in order to ameliorate clinical practice and improve outcomes.

Objectives: The study purpose is to examine VA ECMO application at our tertiary care center and compare outcomes between patients who were supported with central versus peripheral configuration.

Methods: We retrospectively reviewed the electronic records of 97 consecutive patients who were supported with VA ECMO at our institution between January 2015 and August 2022. We recorded basic demographic data, clinical indication for support, length of hospitalization and survival outcome. Data were statistically analyzed by SPSS programme. We divided patients according to central or peripheral ECMO configuration.

Results: 97 patients, with a median age of 59 years, were supported with VA ECMO. Central configuration was applied in 62% of the cases and peripheral in 38%. Indication for support was post cardiomy shock (PCS) in 58%, primary graft dysfunction (PGD) in 11%, acute myocarditis in 10%, dilated cardiomyopathy (DCM) in 7%, electric storm in 7%, acute coronary syndrome (ACS) in 3% and cardiopulmonary resuscitation (ECPR) in 2% of the cases. Median length of hospitalization was 15 days and overall survival to discharge was 30%.

Patients supported with Central VA ECMO were older (66 vs 44 years median age) and had shorter length of hospitalization (11 vs 44 days median) than those supported with Peripheral VA ECMO. The indication for support was predominantly PCS (image 1) and their survival outcome was strikingly worse (image 2).

Conclusions: Patients supported with VA ECMO for PCS bare a dismal prognosis (4). We should reconsider patient selection and timing of deployment, although this remains a debatable topic in the literature (5). There is some evidence that peripheral cannulation strategy may favorably affect patient outcomes, but existing data are mainly retrospective (6, 7). Finally, there may be an implication for utilizing shorter life oxygenators, rationalizing this way, the cost of ECMO support in the PCS patient population.

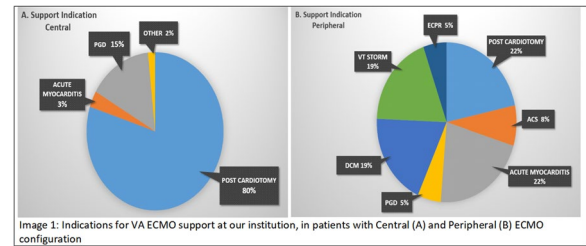

Image 1 (abstract 000876) .

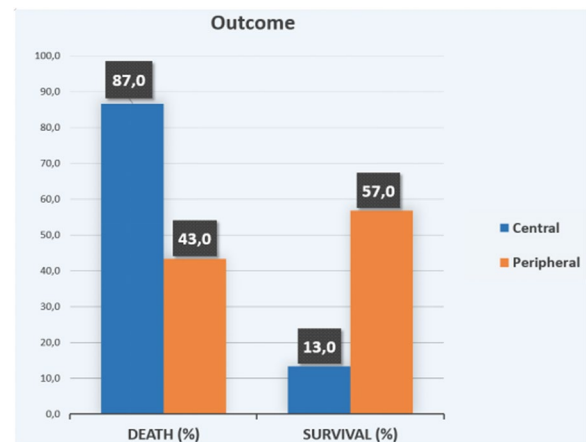

Image 2: Outcome of patients supported with Central vs Peripheral VA ECMO

Image 2 (abstract 000876) .

References

- 6) Mariscalco G, Salsano A, Fiore A, et al. Peripheral versus central extracorporeal membrane oxygenation for postcardiotomy shock: multicenter registry, systematic review, and meta-analysis. *J Thorac Cardiovasc Surg.* 2020;160:1207–16.e44
- 7) Brewer J, Tran A, Yu J, et al. ECMO after cardiac surgery: a single center study on survival and optimizing outcomes. *J Cardiothorac Surg* (2021) 16:264
- 1) Rao P, Khalpey Z, Smith R, et al. Venoarterial Extracorporeal Membrane Oxygenation for Cardiogenic Shock and Cardiac Arrest. *Cardinal Considerations for Initiation and Management.* *Circulation: Heart Failure.* 2018;11:e004905
- 2) Lorusso R, Whitman G, Milojevic M, et al. 2020 EACTS/ ELSO/STS/AATS expert consensus on post-cardiotomy extracorporeal life support in adult patients. *Eur J Cardiothorac Surg* 2021; 59(1): 12–53.
- 3) Whitman GJ. Extracorporeal membrane oxygenation for the treatment of postcardiotomy shock. *J Thorac Cardiovasc Surg* 2017;153:95–101.
- 4) Lorusso R, Raffa G, Alenizy K, et al. Structured review of post-cardiotomy extracorporeal membrane oxygenation: part 1— adult patients. *J Heart Lung Transplant.* 2019;38:1125–43
- 5) Fukuhara S, Takeda K, Garan A, et al. Contemporary mechanical circulatory support therapy for postcardiotomy shock. *Gen Thorac Cardiovasc Surg.* 2016;64:183–91.

Topic: Perioperative care

000877

Traumatic brain injury: how traumatic subarachnoid hemorrhage influences injury severity

E. Alonso Ciria¹, G. Morales Varas², M. Sanchez Casado³, J. Romeu Prieto⁴, A. Calle Flores³, V. Pais Sánchez-Malingre¹, F. J. Moran Gallego³, I. Lopez De Toro³, L. Marina Martínez²

¹Intensive Care Unit, Hospital General Universitario de Toledo, Toledo, Spain; ²Intensive Care Unit, Toledo, Toledo, Spain; ³Icu, Virgin Health Hospital, Toledo, Spain; ⁴Critical Care, Hospital General Universitario de Toledo, Toledo, Spain; ⁵Intensive Care Unit, University Hospital of Toledo, Toledo, Spain

Correspondence: E. Alonso Ciria

Intensive Care Medicine Experimental 2023, **11(Suppl 1)**:000877

Introduction: Traumatic brain injury (TBI) is one of the main causes of disability, especially in young people. It is a pathology with great heterogeneity, which makes it difficult to determine its prognosis. Traumatic subarachnoid hemorrhage (tSAH) is a frequent finding in brain injuries. Understanding the impact it may have on the outcomes of patients with TBI can help define therapeutic strategies.

Objectives: To evaluate the impact of tSAH on outcomes of patients with TBI.

Methods: A cohort of patients with TBI requiring neurocritical care over a 3-year period was analyzed. The cohort was categorized according to the presence or absence of tSAH on initial computed tomography. Demographic variables, mechanism of injury, severity, evolution and outcome were evaluated. Some variables were analyzed, including demographic characteristics, injury mechanism, severity, evolution, and outcomes. Categorical variables are expressed as counts and percentages and were compared using the χ^2 test; continuous variables are expressed as means and standard deviation and were compared using Mann-Whitney U test. A two-sided level of significance of 5% was used. Data analysis was performed using STATA version 13[®] (StataCorp LLC).

Results: A total of 145 patients were admitted with TBI, of which 43% presented tSAH. A 77.9% (113) were men, and the mean age was higher in patients in the tSAH group (56.8 ± 18.2 vs 45.8 ± 18 years old; $p < 0.001$). In the tSAH group, the main mechanism of injury was an accidental fall (61.9% vs 25.5%; $p < 0.001$), and in the non tSAH group, it was a traffic accident (45% vs 27%; $p < 0.001$). Patients with tSAH had higher head Abbreviated Injury Scale (AIS) scores (3.7 ± 1.0 vs 1.4 ± 1.9 ; $p < 0.0001$) and higher Injury Severity Scores (ISS) (25.1 ± 14.3 vs 20.4 ± 12.3 ; $p = 0.038$), with a similar distribution of the Marshall classification ($p = 0.184$). There was no difference in the need for neurosurgery or blood products in the first 24 h. During the evolution in the ICU, patients with tSAH developed more frequent episodes of intracranial hypertension (24.2% vs 6.2%; $p = 0.02$) with a greater need for osmotic treatment (30.2% vs 11%; $p = 0.004$) and decompressive craniectomy (7.9% vs 1.2%; $p = 0.044$). Functional outcome at 6 months and at 1 year showed no difference in the Glasgow Outcome Scale Extended (GOSE). ICU mortality was higher in the tSAH group (23.8% vs 7.3%; $p = 0.018$).

Conclusions: Patients with TBI and initial tSAH did not present different management in the first 24h; however, they more frequently developed episodes of intracranial hypertension and had a greater need for decompressive craniectomy. ICU mortality was higher in patients with tSAH. The optimal management of these patients remains uncertain and represents a challenge for neurocritical care.

Topic: Neurointensive care.

000879

Vasopressin as a secondary vasopressor: mortality related prognostic factors in septic shock patients

G. Castañeda¹, J. Cedeño Mora¹, R. Ruiz Cacho¹, J. Cui¹, C. Alvarez¹, P. García Olivares¹, M. Artabe¹, N. Cango¹, C. Ramirez¹, A. Rodriguez¹, A. Diaz-Tejero Rodriguez²

¹Intensive Care Unit, H.G.U Gregorio Marañón, Madrid, Spain; ²Intensive Care Medicine, Intensive Care Unit, HGU Gregorio Marañón, Madrid, Spain

Correspondence: G. Castañeda

Intensive Care Medicine Experimental 2023, **11(Suppl 1)**:000879

Introduction: Noradrenaline is the recommended first-line vasopressor, although largely effective in reestablishing minimally acceptable mean arterial pressures to maintain organ perfusion, catecholamines have important adverse effects and may even increase mortality rates. Since a relative vasopressin deficiency in septic shock was described, there has been growing interest in the use of vasopressin as an adjunctive agent. Shock characteristics at vasopressin initiation could impact clinical outcomes, being time since shock onset, severity of hypoperfusion, and catecholamine dose requirements particularly interesting.

Objectives: To analyze mortality related factors in septic shock patients, after vasopressin treatment as a second vasopressor associated with noradrenaline.

Methods: Retrospective observational study, carried out after the implementation of vasopressin as a secondary vasopressor treatment protocol (when $NAD > 0.2$ $\mu\text{g}/\text{kg}/\text{min}$). We collected data from all septic shock patients attended at the Intensive Care Unit of Gregorio Marañón Hospital between March and December 2022. Epidemiological data, comorbidities, severity, clinical features, invasive support, complications and outcomes were collected.

Descriptive analyses were expressed as means (standard deviation) for normally distributed quantitative variables, medians (interquartile range) for non-normally distributed variables, and as percentages for categorical data. Univariate analysis was performed using Chi-squared (relative risk) for qualitative variables, and T-student (median comparison) for quantitative ones. Multiple logistic regression was used to determine independent mortality related factors, including significant variables or clinically relevant variables.

Results: Seventy patients were included, 53% were male, mean age 61 ± 16 . 50% had respiratory infection, 33% abdominal. Charlson Index 3 (2–4). To evaluate severity of illness we used APACHE II 26 ± 7 , SOFA 10 ± 3 . 80% required invasive mechanical ventilation for 4 days (1–15 days), and 50% extrarenal depuration.

Time between septic shock diagnose and NAD initiation was 3h (1-5h), time between septic shock diagnose and VAP initiation, 8 h (5-15h). NAD dose when VAP was initiated was 0.6 ± 0.4 $\mu\text{g}/\text{kg}/\text{min}$.

ICU mortality was 49% and hospital mortality was also 49% as all the deceased patients died in the ICU. ICU stay 9 days (3–22), and hospital stay 18 days (3–32).

Mortality related factors adjusted to severity of illness were: age (66 ± 14 vs 56 ± 16 , $p = 0.01$), APACHE II ($23 + /6$ vs 29 ± 8 , $p < 0.01$), and NAD dose when VAP was initiated (0.42 ± 0.26 vs 0.85 ± 0.44 , $p < 0.01$).

Lactate and NAD dose when VAP was initiated were found to be independent mortality factors: lactate (OR 1.57; CI 95% 1.16–2.10) and NAD dose when VAP was initiated (OR 29.70; CI 95% 1.54–570.82).

Conclusions: In our series, lactate levels and Noradrenaline dose when initiating vasopressin were independent mortality risk factors.

Topic: Cardiovascular issues in ICU

000880

Prediction of intracranial hypertension in patients with severe traumatic brain injury using intracranial pressure waveform morphology and deep learningR. van Kaam¹, C. Hoedemaekers¹, M. Aries², J. Tas², T. Frenzel¹, J. Schouten¹, H. Van Der Hoeven¹, M. Gerven³, L. Ambrogioni³¹Intensive Care, Radboud University Medical Center, Nijmegen, Netherlands; ²Department of intensive care, Maastricht UMC+, Maastricht, Netherlands; ³Artificial Intelligence, Donders Institute for Brain, Cognition and Behaviour, Radboud University, Nijmegen, Netherlands**Correspondence:** R. van Kaam*Intensive Care Medicine Experimental* 2023, **11(Suppl 1)**:000880

Introduction: Management of traumatic brain injury (TBI) patients focusses on identification, prevention and treatment of secondary insults of brain injury. A major cause for secondary brain injury is increased intracranial pressure (ICP), also referred to as intracranial hypertension (IH). With increasing intracranial volume, compliance of the brain decreases, resulting in alterations in ICP wave morphology. IH is often difficult to foresee and treatment is started reactively when ICP exceeds threshold values. During the time needed to restore ICP to lower values, IH results in secondary brain injury. Therefore, a proactive approach is desired to limit the impact of IH. Mean ICP and changes in ICP wave morphology may be predictors of upcoming episodes of IH.

Objectives: In this study, we investigated if a deep learning model based on ICP waveform and statistical summaries of ICP and ABP is able to predict IH.

Methods: We performed a retrospective study in adult TBI patients that experienced IH during ICU stay. Data was collected from two Dutch academic hospitals and the CENTER-TBI (high resolution) dataset [1]. Patients with decompressive craniectomy were excluded. IH was identified as >10 consecutive minutes of ICP > 30 mmHg. Target data was selected from the hour prior to IH (pre-IH) and divided in six prediction windows of 10 min. Control segments were isolated two hours from IH and pre-IH segments. After preprocessing, all single ICP waves were extracted and series of 120 consecutive waves were stacked to match the input dimensions of a ResNet50 model. In addition, per input segment, the average ICP waveform of the previous control and IH episode was added. Last, numerical data containing ICU length of stay, time to previous IH event, the number of previous IH events and the mean, median, standard deviation and variance of the 2-h segment of ICP and ABP and per non-overlapping 10 min windows within that segment were added. To artificially increase the training set, 50% and 95% overlap was applied for control and pre-IH input data respectively. Training of the model was done using leave-one-patient-out cross validation and performance of all models was examined with F1 score, sensitivity, specificity and area under the receiving operating characteristic curve (AUC).

Results: 67 patients were included and a total of 201,488 control and 50,193 segments per pre-IH window were extracted as input for the model. Performance of the model was best 0–10 min prior to IH with a median F1 score of 78.6 [IQR 67.2–93.9], sensitivity of 81.9 [IQR 59.1–97.6], specificity of 96.2 [IQR 85.2–99.1] and an AUC of 95.9 [IQR 86.5–99.5]. As prediction windows are further away from IH performance decreases, as can be seen in Figure 1.

Conclusions: In this study we showed a deep learning model is able to predict IH in patients with TBI that experienced IH during ICU stay, using ICP waveform morphology within a clinically relevant time window.

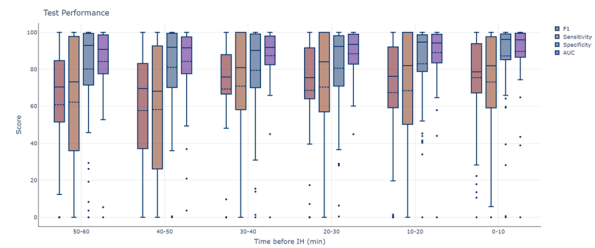

Figure 1 (abstract 000880) Test performance of the model for all prediction windows prior to intracranial hypertension

References

1. Maas AI, Menon DK, Steyerberg EW, Citerio G, Lecky F, Manley GT, Hill S, Legrand V, Sorgner A; CENTER-TBI Participants and Investigators. Collaborative European NeuroTrauma Effectiveness Research in Traumatic Brain Injury (CENTER-TBI): a prospective longitudinal observational study. *Neurosurgery*. 2015 Jan;76(1):67–80. doi: <https://doi.org/10.1227/NEU.0000000000000575>. PMID: 25,525,693.
2. This study was funded by Radboud AI for Health

Topic: Data Science

000881

Ventilator associated lower respiratory tract infection (VA-LRTI) in critical COVID-19, a retrospective Swedish multicenter observational studyG. Forsberg¹, K. Taxbro², L. Elander¹, H. Hanberger³, M. Chew⁴, S. Berg⁵, J. Idh⁶, J. Berkus⁶, A. Ekman⁷, F. Hammarskjöld², K. Niward⁸, Å. Östholm Balkhed⁸

¹Department of Health, Medicine and Caring Sciences, Linköping University, Linköping, Sweden; ²Department of Biomedical and Clinical Sciences, Linköping University, Linköping, Sweden, Länssjukhuset Ryhov, Jönköping, Sweden; ³Department of infectious diseases, Linköping University, Linköping, Sweden; ⁴Anesthesiology and intensive care, Linköping University Hospital, Linköping, Sweden; ⁵Department of cardiothoracic and vascular and department of medical and health sciences, Linköping University Hospital, Linköping, Sweden; ⁶Department of Biomedical and Clinical Sciences, Linköping University, Linköping, Sweden, Västerviks sjukhus, Västervik, Sweden; ⁷Department of Medicine and Optometry, Linnaeus University, Kalmar, Sweden, Länssjukhuset i Kalmar, Kalmar, Sweden; ⁸Department of Biomedical and Clinical Sciences, Linköping University, Linköping, Sweden, Linköping University, Linköping, Sweden

Correspondence: G. Forsberg*Intensive Care Medicine Experimental* 2023, **11(Suppl 1)**:000881

Introduction: Ventilator-Associated Lower Respiratory Tract Infections (VA-LRTI) increases morbidity and mortality in Intensive Care Unit (ICU) patients (1,2). High incidences of secondary VA-LRTI have been reported among ICU-patients with COVID-19 needing invasive mechanical ventilation (3).

Objectives: To describe the clinical characteristics, incidence, microbiology, risk factors and outcome of patients who developed VA-LRTI, as compared to patients who did not, in a population cohort of Swedish ICU patients with severe COVID-19.

Methods: A multicenter, retrospective cohort study of all ICU-patients with COVID-19 requiring invasive mechanical ventilation for at least 48 h between 1 March 2020 and 31 May 2021 from the ICUs serving the Southeast region in Sweden (a population of approximately 1

million). The primary outcome was the first episode of culture verified VA-LRTI. Patient characteristics together with ventilatory support, clinical course, organ support, antibiotics and immunomodulatory medications, microbiological findings, complications and 30-, 60- and 90-day mortality were registered. Logistic regression analysis was conducted to determine factors associated with increased risk for first VA-LRTI.

Results: Of a total of 536 included patients, 153 (28.5%) developed VA-LRTI. Incidence of first VA-LRTI was 20.8 per 1000 days of invasive mechanical ventilation, increasing from 14.5 to 25.8 from the first to the third pandemic wave. Comparing patients with VA-LRTI to those without revealed no difference in age, sex or number of comorbidities. Additionally, no differences were seen in 30- 60- or 90-day mortality. Patients with VA-LRTI had fewer ventilator-free days, longer ICU and hospital stay, were more frequently in prone position ventilation, received more corticosteroids and had more often antibiotic treatments upon intubation. Logistic regression analysis revealed increased odds for first VA-LRTI in patients treated with corticosteroids during hospital stay (OR 2.64 [95% CI 1.31–5.74]), antibiotics upon intubation (OR 2.01 95% CI [1.14–3.66]) and days of invasive mechanical ventilation (OR 1.05 per day of IMV, 95% CI [1.03–1.07]), adjusted for sex, neuromuscular relaxation, BMI, age, number of comorbidities, days to intubation and prone position (Figure 1). In all VA-LRTI cultures, the proportion of gram-positive pathogens were 31.2%, gram-negative 60.7% and fungal/unspecified 8.1% and a total of 1.9% multidrug-resistant bacteria were found.

Conclusions: There was a high incidence of VA-LRTI in this large cohort of critically ill COVID-19 patients, exceeding VA-LRTI incidence found in Swedish non-COVID patients (4), but still lower than found in other international studies (3,5) VA-LRTI increased morbidity but not 30-, 60- or 90-day mortality. Corticosteroid treatment and antibiotics upon intubation were associated with increased OR of first VA-LRTI, further validating earlier studies with similar results regarding corticosteroids in intubated COVID-19 patients.

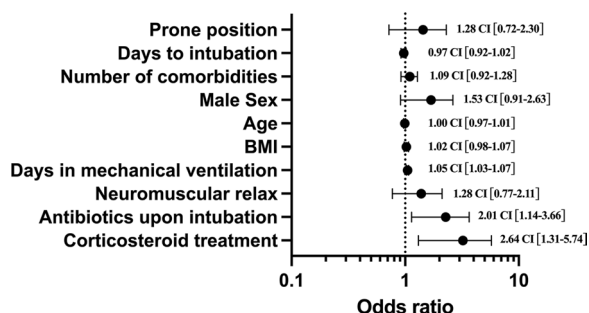

Figure 1 (abstract 000881) Multiple logistic regression analysis with first VA-LRTI as outcome. Data presented as OR [95% CI]

References

- (1)Kalanuria AA, Ziai W, Mirski M. Ventilator-associated pneumonia in the ICU. Crit Care. 2014;18(2):208. Available from: doi: <https://doi.org/10.1186/cc13775>
- The study was funded by Region Östergötland (ref 978201) and FORSS (ref 968674).
- (3) Ippolito M, Misseri G, Catalisano G, Marino C, Ingoglia G, Alessi M, et al. Ventilator-associated pneumonia in patients with COVID-19: A systematic review and meta-analysis. Antibiotics (Basel). 2021;10(5):545. Available from: doi: <https://doi.org/10.3390/antibiotics10050545>
- (2) Niederman MS. What COVID-19 has taught us: Ventilator-associated pneumonia is back! Am J Respir Crit Care Med. 2022;206(2):132–4. Available from: doi: <https://doi.org/10.1164/rccm.202204-0799ED>
- (5) Moreno J, Carvelli J, Lesaux A, Boucekine M, Tonon D, Bichon A, et al. Ventilator acquired pneumonia in COVID-19 ICU patients: A retrospective cohort study during pandemia in France. J Clin Med.

- (4) Hedberg P, Ternhag A, Giske CG, Strålin K, Özenci V, Johansson N, et al. Ventilator-associated lower respiratory tract bacterial infections in COVID-19 compared with non-COVID-19 patients. Crit Care Med. 2022;50(5):825–36.

Topic: Infections and prevention

000882

Challenges in managing out of hospital cardiac arrest in low resource setting – an intensivists perspective

F. Ahmad¹, S. K. Lok¹, M. F. Jones¹, E. Yaakop², S. Cole¹, R. Kadayam Sreenivasan¹, M. Ramali¹, P. Bishop¹, P. Figgis¹, B. Cadet¹, R. Sheherya¹, E. Thompson³, C. S. T. Darren⁴, S. Cox⁵, I. A. Zainal⁶, M. A. Sadiq⁷, S. S. Kassim⁸
¹Department of Intensive Care, Colchester Hospital, Colchester, United Kingdom; ²Department of Cardiology, Serdang Hospital, Kajang, Malaysia; ³Resuscitation Unit, Colchester Hospital, Colchester, United Kingdom; ⁴Department of Internal Medicine, Keningau Hospital, Keningau, Malaysia; ⁵Department of Cardiology, Princess Alexandra Hospital, Woolloongabba, Australia; ⁶Department of Cardiology, Universiti Malaya Medical Centre, Kuala Lumpur, Malaysia; ⁷Department of Cardiology, Sultan Qaboos University Hospital, Muscat, Oman; ⁸Department of Cardiology, Hospital UiTM Sungai Buloh, Sungai Buloh, Malaysia

Correspondence: F. Ahmad

Intensive Care Medicine Experimental 2023, 11(Suppl 1):000882

Introduction: To date, little attention has been paid to the applicability of cardiac arrest care in low resource. Guidelines for resuscitation during cardiac arrest are predominantly based upon evidence from well-resourced, tertiary referral centres.

Objectives: To determine challenges in managing out of hospital cardiac arrest (OHCA) in low-resource settings and to identify key factors preventing optimal resuscitative measures. We consider possible solutions and suggest future avenues of research.

Methods: This was a multicenter retrospective cohort study in a middle sized urban city (estimated population 390,000) served by a single Emergency Medical Services (EMS) system. All records of OHCA above 18 years were reviewed from the Cardiac Arrest Registry from 2015 to 2022. Among data collected were etiology of cardiac arrest, initial cardiac rhythm, time of initiation of cardiopulmonary resuscitation (CPR) and adrenaline administration by EMS team, geographical distances, access to tertiary centre and relevant expertise. Outcomes of interest included return of spontaneous circulation (ROSC) and survival to hospital discharge (STHD).

Results: From the 7-year study period, a total of 889 adults (mean age of 65.3 ± 11.6 yrs) had OHCA with an average mortality of 68.19% [Figure 1]. Of the 889 patients, 488 patients (54.89%) achieved ROSC but only 298 (33.52%) survived to hospital discharge. We observed the further a person lives from a cardiac arrest resuscitation facility, the greater their risk of poor outcome and death [Figure 2]. A rural/urban differences in the management of cardiac arrest and post cardiac arrest were identified with multiple issues that are related to access, transport and transport distances, access to diagnostic testing and treatment in an appropriate facility. Transport of patients to a cardiac centre capable of performing PCI exceeded 90 min in 68.9% of total documented ST elevation myocardial infarct (STEMI) OHCA (OR 42.7; [95% CI], 39.3–48.7; P < 0.005). We identified deficiencies in workforce expertise, complex patterns of comorbid health conditions and infrastructure limitations resulted in patients with Killip Class 3 and 4 having a mortality of 62.8%.

Conclusions: Outcomes from OHCA remained poor. We believe mortality reduction may be driven by adopting a faster reperfusion strategy, more efficient referral or access pathways, improving local workforce capabilities and facilities. Adherence to guideline based management and development of effective resuscitation protocols for low-resource settings should be considered in collaboration with local care teams and the EMS.

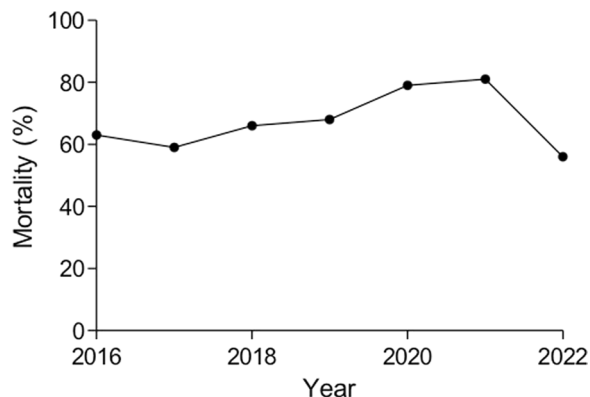

Figure 1

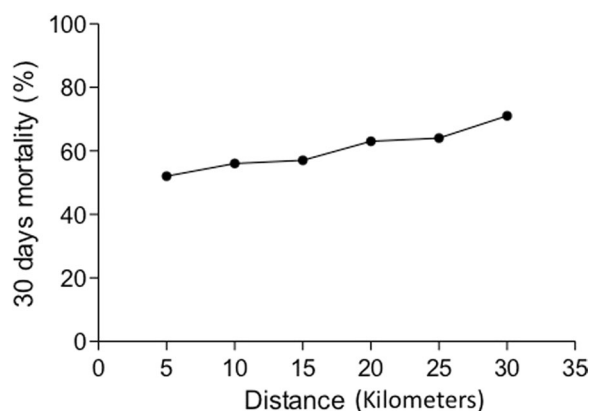

Figure 2

References

- 2] Rao P, Kern KB. *Curr Cardiol Rev.* 2018;14(2):79–84.
- 1] Jordan M, et al. *BMJ Qual Improv Rep.* 2016 Dec 19;5(1)
- N/A

Topic: Cardiac arrest

000883

Factors associated with kidney injury development in critically ill COVID-19 patients: a single-center cohort study

M. Sileli¹, M. Kamaterou¹, E. Kerezidou¹, D. Ntanos¹, A. B. Haidich², K. Bougioukas², K. Porpodis³, N. Kapravelos¹, C. Iasonidou¹
¹B ICU, General Hospital of Thessaloniki "George Papanikolaou", Thessaloniki, Greece; ²Department of Hygiene, Social-Preventive Medicine & Medical Statistics, Aristotle University of Thessaloniki, Thessaloniki, Greece; ³Pulmonary Department, Aristotle University of Thessaloniki, Thessaloniki, Greece

Correspondence: M. Sileli

Intensive Care Medicine Experimental 2023, **11(Suppl 1)**:000883

Introduction: COVID-19 is an ongoing pandemic with varying rates among countries. Renal dysfunction is often recorded with devastating outcomes and health resources consequences.

Objectives: To assess the incidence and risk factors for developing new-onset acute kidney injury (AKI) in critically ill COVID-19 patients admitted to our ICU from the broader area of central Macedonia.

Methods: Single-center, retrospective cohort study in a Greek tertiary-care ICU (March 2020-April 2022). We included all critically ill adult patients who suffered from moderate/severe ARDS caused by PCR-confirmed active SARS-CoV-2 infection. All were treated uniformly according to the national protocol, while none were fully vaccinated. We excluded patients: with underlying Chronic Kidney Disease or on Renal Replacement Therapy (RRT), with a history of nephrectomy or renal transplantation, with readmissions, those with ICU stay ≤ 1 day and immunocompromised. Demographics, medical history, severity scoring, length of ICU stay (LOS), mortality, parameters of invasive mechanical ventilation, administration of nephrotoxic agents, serum creatinine (sCr), estimated glomerular filtration rate (eGFR), vasoactive drugs in high doses (norepinephrine > 0.5 mcg/kg/min), and markers of systemic inflammation (NLR, PCT, D-Dimers, IL-6) at ICU admission were recorded. AKI was defined based on sCr KDIGO criteria. All patients were assigned to two groups (AKI, non-AKI) and were followed for the entire ICU stay. We used Chi-square and Mann-Whitney rank sum tests to assess between-group differences. We performed univariate and multivariate analyses to test potential predictors of AKI. The significance level was set at 0.05. All analyses were performed using the R statistical package.

Results: 163 patients were recorded, predominantly male (67.5%) with a median age of 64 (IQR: 56.5 to 71) years. The non-renal SOFA score was 6 (IQR: 4 to 8), the median APACHE II score was 15 (IQR: 13 to 18), and the mortality rate reached 46%. In our cohort, 57.7% had AKI, (28.7% Stage I, 18.1% Stage II, 53.2% Stage III), whereas 44.6% needed RRT. AKI patients were older, had a longer LOS, and increased mortality ($p < 0.05$). They had a lower admission eGFR and more frequently received high-dose vasoactive substances or nephrotoxic agents/drugs ($p < 0.05$). They also had significantly increased admission values of PCT and IL-6 ($p < 0.05$). No differences in medical history were recorded. Multivariate analysis showed that eGFR (OR = 0.98, 95%CI: 0.97 to 0.99, $p < 0.001$), use of high-dose vasoactive drugs (OR = 10.84, 95%CI: 5.28 to 23.52, $p < 0.001$) and IL-6 (OR = 1.01, 95%CI: 1.01 to 1.02, $p = 0.001$) independently predicted AKI.

Conclusions: AKI was a frequent complication in our cohort. ICU admission eGFR and IL-6 levels, and the need for high-dose vasoactive drugs, were independent predictors of AKI development. Early recognition and mitigation of these factors could help reduce the risk or severity of renal dysfunction.

References

- Schaubroeck H, Vandenberghe W, Boer W et al. Acute kidney injury in critical COVID-19: a multicenter cohort analysis in seven large hospitals in Belgium. *Crit Care* 2022;26(1):225
- None

Topic: Acute Kidney Injury and haemofiltration

000885

Diaphragmatic Tissue Doppler Imaging (TDI) in healthy volunteers breathing at different levels above Functional Residual Capacity (FRC)

C. Nouris¹, E. Soilemezi¹, S. C. Kotoulas¹, P. Morfesis¹, D. Matamis¹
¹ICU, Papageorgiou General Hospital, Thessaloniki, Greece

Correspondence: E. Soilemezi

Intensive Care Medicine Experimental 2023, **11(Suppl 1)**:000885

Introduction: Diaphragmatic TDI has recently gained interest as a tool allowing real-time measurement of the diaphragmatic muscle speed of contraction and relaxation as well as the rate of diaphragmatic relaxation. Very little is known about the changes of the diaphragmatic TDI pattern when the diaphragm does not return to FRC at the end of a passive expiration. The aim of our study was to assess the diaphragmatic TDI pattern when changes at the passive FRC were induced by two different levels of positive end-expiratory pressure (PEEP).

Methods: In twelve healthy volunteers, lung distension above the passive FRC was induced by two levels of PEEP, 6 and 12 cm H₂O. In each subject and during the three conditions (Zero PEEP (ZEEP), PEEP of 6

and 12 cmH₂O), the following parameters were measured: tidal volume (V_t), respiratory rate (RR), minute ventilation (MV), diaphragmatic excursion, diaphragmatic thickness, thickness ratio, TDI peak contraction velocity (PCV), peak relaxation velocity (PRV), slope of diaphragmatic relaxation and the increase in lung volume above passive FRC.

Results: The increase in lung volume induced by PEEP was 556.27 ± 150.98 ml at PEEP 6 and 1218.67 ± 383.06 ml at PEEP 12 (p < 0.001). Diaphragmatic excursion, V_t, RR and MV did not change significantly during the three conditions (p > 0.05). Thickness ratio increased, with the increase in lung volume, from 28.24 ± 14.90% at ZEEP, to 37.22 ± 20.51% at PEEP 6 cmH₂O and to 47.96 ± 38.61% at PEEP 12 cmH₂O (p = 0.21), with the increase in thickness during inspiration becoming significant (p = 0.006). TDI parameters also increased with PEEP; PCV from 2.20 ± 0.49 cm/s to 2.49 ± 0.61 cm/s, and to 2.72 ± 0.68 cm/s, PRV from 1.99 ± 0.54 cm/s to 2.57 ± 0.77 cm/s and to 2.51 ± 0.89 cm/s, and the slope of the diaphragmatic relaxation from 3.86 ± 2.92 cm/s² to 5.57 ± 3.25 cm/s² and to 6.01 ± 3.48 cm/s². All measurements showed a trend towards statistical significance.

Conclusions: Breathing above passive FRC (lung overdistension) induces an increase in the PCV, PRV and in the speed of the diaphragmatic relaxation. Furthermore, the increase in thickness ratio demonstrates that the energy cost of breathing for the same minute ventilation increases.

Topic: Acute respiratory failure and mechanical ventilation

000886

Preliminary clinical validation of a predictive digital twin software for management of cardiogenic shock patients

C. Contarino¹, F. Chifari¹, P. Severgnini², G. Feliciotti², E. Castelnuovo³, C. Zanovello³

¹Research and Development, Computational Life Inc, Wilmington (DE), United States of America; ²Anestesia Rianimazione Cardiologica, ASST Sette Laghi, Ospedale di Circolo e Fondazione Macchi, Varese, Italy; ³Scuola di Specializzazione in Anestesia Rianimazione Terapia Intensiva e del Dolore, Università degli Studi dell'Insubria, Varese, Italy

Correspondence: F. Chifari

Intensive Care Medicine Experimental 2023, 11(Suppl 1):000886

Introduction: Cardiogenic Shock (CS) is a complex and heterogeneous pathological syndrome that occurs when cardiac output is insufficient to ensure adequate perfusion to remote organs. The most frequent cause of CS is acute myocardial infarction (AMI) and every year more than 200,000 people suffer from CS in Europe and the US, with a death rate between 40 and 60% despite progress made in clinical care solutions. Due to the heterogeneity of aetiologies and conditions of CS patients, treatment decisions must be carefully considered, to account for each patient's specific characteristics, comorbidities, and hemodynamic status.

Objectives: We introduce preliminary clinical validation results for an innovative and proprietary ICU information system for decision support that relies on a digital twin technology to provide personalised disease management strategies to CS patients.

Methods: We developed a digital twin software that relies on predictive, multi-scale mathematical models of the whole human physiology and medical treatments, as well as on machine learning algorithms that allow rapid and effective calibration of these models on the patients' specific health status starting from their available clinical measurements. This model's capabilities of 1) automatically creating accurate virtual twins and 2) providing insights on patients' health status and response to treatments were validated using a collection of snapshots of real clinical cases consisting of systematic collections of anonymous data from cardiac intensive care units.

Results: In Figure 1 are shown the results of the twinning process performed on a patient treated with a combination of vasopressors, inotropes, diuretics and mechanical ventilation after AMI. The software successfully calibrated the underlying computational models allowing for a faithful creation of the patient's digital twin throughout the entire ICU recovery phases. The values of the obtained virtual hemodynamic variables faithfully matched variations of the clinical measurements

induced by escalation and/or weaning of the various treatments both in terms of mean values and associated uncertainty. Moreover, the twinning process also produced reliable insights on the trends of non measured variables throughout the entire period of care.

Conclusions: The digital twin model efficiently reproduced the health statuses associated with a wide variety of aetiologies, therapies and parameters availability for multiple patients (data not shown). The versatility and accuracy of this technology in producing a digital copy of a patient could provide a reliable basis for clinicians to: 1) obtain a complete understanding of patients' pathophysiological conditions and evolution, also leveraging the availability of insights on non measured or non measurable clinical variables and 2) test different treatment strategies, predictively assessing patients' response to treatments. These functionalities represent a decisive support to facilitate the adoption of a personalised disease management approach that could result in beneficial impact for CS patients. Further developments are ongoing to extend the validation activities to whole body physiology dynamics and treatment predictions.

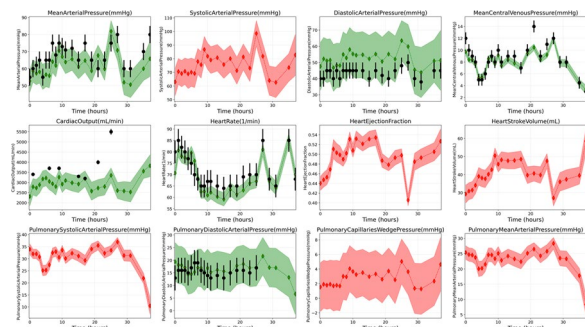

Figure 1 (abstract 000886) Results of the preliminary clinical validation of patient twinning on hemodynamic variables of a patient with mitral and aortic regurgitation admitted in ICU after experiencing AMI. Real clinical measurements are represented with black dots while the black lines indicate measurement uncertainty. The green lines are the in-silico predictions based on the available measurements, while the surrounding coloured bands represent the range of computational uncertainties. The red lines and surrounding coloured bands represent the in-silico predictions and uncertainties for variables with clinical measurements not available. All the results and associated uncertainties are shown as mean ± two standard deviations

Topic: Cardiovascular issues in ICU

000888

Assessment of the effects of tidal volume and respiratory rate on the velocity characteristics of diaphragmatic motion using Tissue Doppler Imaging (TDI)

E. Soilemezi¹, S. C. Kotoulas¹, P. Pisanidou¹, D. Papanikolaou¹, E. Tsiranidou¹, D. Matamis¹

¹ICU, Papageorgiou General Hospital, Thessaloniki, Greece

Correspondence: E. Soilemezi

Intensive Care Medicine Experimental 2023, 11(Suppl 1):000888

Introduction: Tissue Doppler Imaging (TDI) is an echocardiographic technique which uses Doppler to quantify the velocity of tissue rather than blood. Since it directly estimates the velocity of moving tissue, it has been recently applied to assess the velocity of the moving diaphragm. However, the factors that influence the characteristics of the diaphragmatic velocity pattern remain largely unknown. In this study we applied the diaphragmatic TDI technique to determine the distinctive role of the tidal volume and respiratory frequency in the velocity pattern of diaphragmatic tissue motion.

Methods: Diaphragmatic TDI was recorded in 21 healthy adults, who were breathing through a ventilator tubing system (PSV mode with 0 cmH₂O of pressure support and 0 cmH₂O of PEEP) with a nose clip

to avoid leaks and to measure precisely all ventilatory parameters required. In all recordings the following TDI-derived parameters were measured: diaphragmatic peak contraction and peak relaxation velocity, and the slope of the initial steepest part of the velocity waveform during relaxation, ie, the TDI-derived maximal relaxation rate. The pneumotachographic parameters of the corresponding breaths measured included: tidal volume, inspiratory and expiratory times, and duration of each whole breathing cycle, allowing minute ventilation also to be estimated. The study protocol consisted of three phases; i) subjects were instructed to breathe adopting a ventilatory pattern they found comfortable; ii) subjects were instructed to double the tidal volume they adopted during phase i, while maintaining the same respiratory rate; iii) subjects were instructed to double the respiratory rate they adopted during phase i, while maintaining the same tidal volume. The latter two phases were applied randomly in order.

Results: We found significant increases in the diaphragmatic contraction and relaxation velocity and in the maximal diaphragmatic relaxation rate in both high tidal volume phase (+45.72%, +48.56%, +74.22% respectively, $p < 0.001$ for all measurements), and high respiratory rate phase (+72.47%, +77.19%, +319.42% respectively, $p < 0.001$ for all measurements) compared to normal breathing. Diaphragmatic velocities and velocity's rate of change were strongly related to minute ventilation in all stages of the protocol ($R^2 > 0.45$, $p < 0.001$), while the rate of velocity change negatively correlated to expiratory time ($R^2 = 0.63$, $p < 0.001$).

Conclusions: Conclusively, in this study we describe that both increasing the depth and frequency of breathing bears major increases in the diaphragmatic contraction and relaxation velocities and diaphragmatic relaxation rate. These outstandingly high values of velocities, especially in the high frequency phase and its association to respiratory times, clearly reflect the diaphragm's intense effort to rapidly regain a resting position as close to FRC as possible, ensuring a mechanical advantage for an efficient next inspiratory effort.

Topic: Acute respiratory failure and mechanical ventilation.

000889

Effects of dexmedetomidine on agitated delirium duration of non-intubated ICU patients. A multicenter randomized controlled trial (4D Trial)

T. Godet¹, N. Bourguignon², B. Pereira², A. de Jong³, S. Jaber⁴, E. Futier⁵, G. Chanques³, J. M. Constantin⁶

¹Department of Anesthesiology, Intensive Care and Perioperative Medicine, University Hospitals of Clermont-Ferrand—Clermont Auvergne University, Clermont-Ferrand, France; ²Department of Statistics, University Hospitals of Clermont-Ferrand—Clermont Auvergne University, Clermont-Ferrand, France; ³Département d'anesthésie Réanimation b, University Hospital Center Saint Eloi Hospital, Montpellier, France; ⁴(8) Anesthesia And Critical Care Department b, Centre Hospitalier Universitaire Montpellier, Montpellier, France; ⁵Department of Anesthesiology And Intensive Care Medicine, University Hospital of Clermont-Ferrand, Clermont-Ferrand, France; ⁶Department of anesthesiology and intensive care medicine, University Hospitals Pitié Salpêtrière, Sorbonne University, Paris, France

Correspondence: T. Godet

Intensive Care Medicine Experimental 2023, **11(Suppl 1)**:000889

Introduction: Delirium during intensive care unit (ICU) stay is frequent and associated with significant morbidity, mortality and health-care related costs (1). International guidelines suggest its prevention. However, curative treatment remains unclearly established to date (2). Despite a non-unequivocal literature, haloperidol is the first line used neuroleptic (3). Dexmedetomidine, an alpha2-adrenergic receptors agonist has shown its efficiency in the treatment of delirium in intubated patients but also in its prevention. Dexmedetomidine represents a widely used alternative to haloperidol. Only few studies have compared the efficacy of dexmedetomidine in non-intubated ICU patients as a first line curative treatment of agitated delirium (4).

Objectives: Main objective of 4D trial is to demonstrate that dexmedetomidine decreases agitated delirium duration and the requirement of intubation compared to placebo.

Methods: The 4D trial is an investigator-initiated, prospective, multicenter, randomized, double-blinded, two-arm trial, randomizing 300 non-intubated ICU patients with diagnosis of agitated delirium to receive dexmedetomidine or placebo as a cure (5). The primary outcome measure is a composite of duration of agitation and delirium and the use of intubation with deep sedation and mechanical ventilation. Secondary outcomes include mortalities at 7 and 28 days, ICU length of stay and occurrence of adverse effects. One year quality of life has been investigated with SF-36 score. The sample size will allow the detection of a 50% decrease of agitation duration (RASS > 0; 120 min), of an absolute reduction of delirium duration (CAM-ICU positive; 1 day) and of a 50% relative decrease of intubation and mechanical ventilation, with a type 1 error rate of 1.8% (error risk inflation due to components of composite) and power of 90%, assuming a 15% incidence of intubation and mechanical ventilation requirements, an agitation duration of 240 min and a delirium duration of 3 days. One hundred and 10 patients by group will be needed. An intermediate analysis is scheduled and requires the inclusion of 150 patients. 4D ClinicalTrials.gov Identifier NCT03317067.

Results: A total of 151 patients underwent randomization—76 were assigned to the dexmedetomidine group and 74 to the placebo group. A significant effect was observed (-0.49 [-0.81; -0.17], $p < 0.0001$) on main composite outcome in favour of dexmedetomidine group compared to placebo. Items of composite outcome were as follows. Positive RASS score duration (1 [1; 2] vs 2 [1; 7] hours, $p = 0.001$) and CAM-ICU positive (20.0 [12.0; 31.0] vs 23.5 [12.0; 41.0] hours, $p = 0.38$) decreased in dexmedetomidine group. No difference on intubation requirement was observed (2 (2.6%) vs 3 (4.1%), $p = 0.68$), between dexmedetomidine and placebo groups respectively. Due to strong statistical significance and enrollment rate decline related to non-inclusion criteria (administration of dexmedetomidine during previous 72 h and wider use during COVID-19 era), steering committee decided to stop 4D trial after pre-planned intermediate analysis.

Conclusions: Curative dexmedetomidine is effective at reducing a composite of delirium duration, agitation duration and requirement of intubation and mechanical ventilation. Outcome difference were driven by effective control of agitation.

References

- 4D trial has been funded by French healthcare ministry (Programme hospitalier de recherche Clinique - PHRC-I)
- (5) Louis C, Godet T, Chanques G, Bourguignon N, Morand D, Pereira B, Constantin JM; AZUREA network. Effects of dexmedetomidine on delirium duration of non-intubated ICU patients (4D trial): study protocol for a randomized trial. *Trials*. 2018 Jun 4;19(1):307. doi: <https://doi.org/10.1186/s13063-018-2656-x>. PMID: 29866205; PMCID: PMC5987410.
- (4) Carrasco G, Baeza N, Cabré L, Portillo E, Gimeno G, Manzanedo D, Calizaya M. Dexmedetomidine for the Treatment of Hyperactive Delirium Refractory to Haloperidol in Nonintubated ICU Patients: A Nonrandomized Controlled Trial. *Crit Care Med*. 2016 Jul;44(7):1295–306. doi: <https://doi.org/10.1097/CCM.0000000000001622>. PMID: 26925523.
- (2) Devlin JW, Skrobik Y, Gélinas C, Needham DM, Slooter AJC, Pandharipande PP, Watson PL, Weinhouse GL, Nunnally ME, Rochwerf B, Balas MC, van den Boogaard M, Bosma KJ, Brummel NE, Chanques G, Denehy L, Drouot X, Fraser GL, Harris JE, Joffe AM, Kho ME, Kress JP, Lanphere JA, McKinley S, Neufeldt KJ, Pisani MA, Payen JF, Pun BT, Puntillo KA, Riker RR, Robinson BRH, Shehabi Y, Szumita PM, Winkelman C, Centofanti JE, Price C, Nikayin S, Misak CJ, Flood PD, Kiedrowski K, Alhazzani W. Executive Summary: Clinical Practice Guidelines for the Prevention and Management of Pain, Agitation/Sedation, Delirium, Immobility, and Sleep Disruption in Adult Patients in the ICU. *Crit Care Med*. 2018 Sep;46(9):1532–1548. doi: <https://doi.org/10.1097/CCM.0000000000003259>. PMID: 30113371.
- (1) Stollings JL, Kotfis K, Chanques G, Pun BT, Pandharipande PP, Ely EW. Delirium in critical illness: clinical manifestations, outcomes, and management. *Intensive Care Med*. 2021 Oct;47(10):1089–1103. doi: <https://doi.org/10.1007/s00134-021-06503-1>. Epub 2021 Aug 16. PMID: 34401939; PMCID: PMC8366492.

- 6 (3) Andersen-Ranberg NC, Poulsen LM, Perner A, Wetterslev J, Estrup S, Hästbacka J, Morgan M, Citerio G, Caballero J, Lange T, Kjær MN, Ebdrup BH, Engstrøm J, Olsen MH, Oxenbøll Collet M, Mortensen CB, Weber SO, Andreasen AS, Bestle MH, Uslu B, Scharling Pedersen H, Gramstrup Nielsen L, Toft Boesen HC, Jensen JV, Nebrich L, La Cour K, Laigaard J, Haurum C, Olesen MW, Overgaard-Steensen C, Westergaard B, Brand B, Kingo Vesterlund G, Thornberg Kyhnaav P, Mikkelsen VS, Hyttel-Sørensen S, de Haas I, Aagaard SR, Nielsen LO, Eriksen AS, Rasmussen BS, Brix H, Hildebrandt T, Schönmann-Lund M, Fjeldsøe-Nielsen H, Kuivalainen AM, Mathiesen O; AID-ICU Trial Group. Haloperidol for the Treatment of Delirium in ICU Patients. *N Engl J Med*. 2022 Dec 29;387(26):2425–2435. doi: <https://doi.org/10.1056/NEJMoa2211868>. Epub 2022 Oct 26. PMID: 36286254.

Topic: Sedation, analgesia and delirium

000891

Descriptive study on the use of transjugular intrahepatic portosystemic shunt (TIPS) in the management of gastrointestinal bleeding in patients admitted to the Intensive Care Unit of Ramón y Cajal University Hospital

A. A. De Abreu Ramírez¹, M. García Godes¹, D. Muñoz-Mingarro Molina¹, R. Marín Ráez¹, O. González Fernández¹, J. A. Marquez Alonso¹, E. Morales Sorribas¹, R. De Pablo¹

¹Intensive Care, Ramón y Cajal Hospital, Madrid, Spain

Correspondence: A.A. De Abreu Ramírez

Intensive Care Medicine Experimental 2023, **11(Suppl 1)**:000891

Introduction: Portal hypertension is the most feared complication of cirrhosis, due to the higher morbidity and mortality that its appearance entails and that entails complications such as ascites, encephalopathy and variceal hemorrhage. Among them, the most serious complication is hemorrhage, since it is associated with high mortality. In recent decades there have been important advances in the management of variceal bleeding and one of them has been the introduction of TIPS.

Objectives: To describe the clinical and demographic characteristics, as well as the complications of patients who received transjugular intrahepatic portosystemic shunt (TIPS) for gastrointestinal bleeding.

Methods: This is a retrospective descriptive analysis of patients admitted to our intensive care unit due to gastrointestinal bleeding between September 2020 and December 2022.

Results: During this period, TIPS was performed on 26 patients, 21 of whom were male (80.7%), with a mean age of 61 years. Nine of them had active alcoholism at the time of admission. Alcoholic cirrhosis was the leading cause of liver cirrhosis, accounting for 61.5%, while cryptogenic cirrhosis was the second most frequent cause, accounting for 30.7%. 54.1% of the patients had a Child–Pugh B, and the average MELD score was 17 points, with two patients on the waitlist for liver transplantation.

A decrease in portosystemic pressure gradient of 12 mmHg was achieved in 92% of the patients, with an average gradient of 7.19 mmHg. Therefore, the procedure was considered effective in almost all patients.

No hemorrhagic or arrhythmic complications were reported during the procedure.

The main complication after TIPS placement was hepatic encephalopathy, which occurred in 34.6% of the patients (9), with 6 of them in grades I/II and 3 in grades III/IV. Two patients with grades III/IV required TIPS removal.

The second complication was post-TIPS liver dysfunction, which occurred in 15.38% of the patients (4), with a bilirubin elevation of up to 3 times its previous value. One of them eventually required liver transplantation.

No cardiac, infectious, or shunt dysfunction complications were reported after TIPS placement.

Finally, 9 patients (34.6% mortality) died, 6 of them due to gastrointestinal bleeding, 1 due to coagulopathy and bleeding at other levels, and 2 due to multiorgan failure.

Conclusions: Transjugular intrahepatic portosystemic shunt appears to be a useful therapeutic option in patients with portal hypertension and gastrointestinal bleeding requiring rescue treatment. According to our cohort, it is a safe procedure with few complications, with post-TIPS encephalopathy being the most frequent complication and the only one that can result in procedure reversal. The effectiveness of this therapy will need to be evaluated in larger subsequent studies.

References

1. Lv Y, Yang Z, Liu L, Li K, He C, Wang Z, Bai W, Guo W, Yu T, Yuan X, Zhang H, Xie H, Yao L, Wang J, Li T, Wang Q, Chen H, Wang E, Xia D, Luo B, Li X, Yuan J, Han N, Zhu Y, Niu J, Cai H, Xia J, Yin Z, Wu K, Fan D, Han G; AVB-TIPS Study Group. Early TIPS with covered stents versus standard treatment for acute variceal bleeding in patients with advanced cirrhosis: a randomised controlled trial. *Lancet Gastroenterol Hepatol*. 2019 Aug;4(8):587–598. doi: [https://doi.org/10.1016/S2468-1253\(19\)30090-1](https://doi.org/10.1016/S2468-1253(19)30090-1). Epub 2019 May 29. PMID: 31,153,882
2. Intensive care medicine. Ramón y Cajal Hospital

Topic: Metabolism, endocrinology, liver failure and nutrition

000892

Our experience with vasopressin in septic shock patients

J. Cui¹, J. Cedeño Mora¹, P. García Olivares¹, G. Castañeda¹, C. Ramírez¹, C. Alvarez¹, R. Ruiz Cacho¹, N. Cango¹, A. Diaz-Tejero Rodríguez², M. Artabe¹, A. Rodríguez¹

¹Intensive Care Unit, H.G.U Gregorio Marañón, Madrid, Spain; ²Intensive Care Medicine, Intensive Care Unit, HGU Gregorio Marañón, Madrid, Spain

Correspondence: G. Castañeda

Intensive Care Medicine Experimental 2023, **11(Suppl 1)**:000892

Introduction: Sepsis, defined as life-threatening organ dysfunction caused by a dysregulated host response to infection, is an enormous challenge in intensive care units (ICUs). It may lead to septic shock, multiorgan dysfunction or failure, and death, especially if not identified early and treated appropriately. Septic shock, characterized by severe hemodynamic failure, has a high mortality rate of over 40%. Surviving Sepsis Campaign (SSC) Hour-1 sepsis bundle highlights lactate level, blood cultures, broad-spectrum antibiotics, rapid fluid resuscitation, and vasopressors support as a standard strategy for sepsis management. To obtain a targeted mean arterial pressure (MAP) (≥ 65 mmHg) to ensure tissue perfusion, norepinephrine (NE) is currently recommended as the first-line vasoactive drug when fluid resuscitation fails. If MAP is still inadequate, the SSC guideline proposes to start a second-line vasopressor.

Objectives: To describe ICU admitted patients characteristics at a tertiary hospital, who received vasopressin according to the protocol established, from March to December 2022.

Methods: Observational, prospective study, on septic patients admitted to the ICU from March to December 2022. Epidemiological data, comorbidities, clinical features, invasive support, complications, severity scales and outcome were collected. Descriptive analyses were expressed as means (standard deviation) for normally distributed quantitative variables, medians (interquartile range) for non-normally distributed variables, and as percentages for categorical data.

Results: Data from seventy patients were collected, 53% were male, 92% admitted to ICU for medical pathology. Source of infection: 50% respiratory, 3% abdominal, 17% other sources. **Comorbidity:** Charlson 3 (2–4). **Severity scales:** APACHE II at admission 26 ± 7 . SOFA at admission 10 ± 3 , maximum SOFA 12 ± 3 . Time from septic shock diagnose to the start of NAD perfusion was 3 h (1–6); NAD dose when initiating VAP $0,6 \pm 0,4$; time from sepsis diagnosis to VAP initiation 8 h (5–16). Time from NAD initiation to VAP initiation 4 h (2–10); positive response to VAP 63%, total time of VAP perfusion 24 h (16–39); NAD was suspended 12 h after VAP therapy interruption (9–24). **Hemodynamic monitoring:** 60% transthoracic echocardiography, 26% thermodilution, 14% pulse wave analysis. **Cardiac dysfunction:** none 73%, mild 22%, moderate 3%, severe 13%. **Volume expansion:** volume administered in Emergency room (ER) 2000 ml (1500–3000 ml). Volume administered in the first 6 h from ICU admission, 2000 ml (1500–3000 ml).

Volume administered in the first 24 h, 5000 ml (4000-6000 ml). **Diuresis:** median diuresis in the first 24 h: 1100 ml (500-1500 ml); in the first 24 and 48 h the hydric balance was positive 98% and 75% respectively.

Preload optimization: Inferior vena cava 2 cm (1, 4-2, 4), Velocity Time Integral (VTI) 15 ± 4 , cardiac index $3, 2 \pm 1, 4$, dynamic variables (stroke volumen variation / pulse contour) 14 (10-17). Preload was optimized in 72% of patients. **Perfusion:** ER lactate 5 mmol/L (2-8 mmol/L), ICU admission lactate 6 mmol/L (4-8 mmol/L), 6 h ICU Lactate 5 mmol/L (3-12 mmol/L).

Invasive mechanical ventilation: 80%. Total days on mechanical ventilation 4 days (1-15). **Renal replacement treatment (RRT) required** in 50% of our cohort. **Complications:** 8% of patients suffered complications: 7% atrial fibrillation and 3% ischemic events.

ICU stay: 9 days (3-22). **ICU mortality:** 49%.

Conclusions: In our cohort, patients clinical situation was highly severe at admission, leading to high mortality. Despite of it; we have observed a vasopressin favorable response.

Topic: Sepsis

000895

Impact of patient and disease factors on short- and long-term outcomes of patients with haematological malignancy admitted to ICU

E. Mosaad¹, A. Martins¹, A. Yehia¹, S. Akhtar¹, B. Attia¹, A. Khalil¹, T. Pirani¹, V. Metaxa¹

¹Critical Care Medicine, King's College Hospital NHS Foundation Trust, London, United Kingdom

Correspondence: E. Mosaad

Intensive Care Medicine Experimental 2023, **11(Suppl 1)**:000895

Introduction: Outcomes of patients with haematological malignancy (HM) have improved rapidly due to advances in diagnosis and new emerging therapies [1]. Historically, mortality of patients with HM in critical care has been very high (up to 90%) but more recent reports have demonstrated improved outcomes [2]. However, a number of these patients require admission to an intensive care unit (ICU), where mortality, especially after acute respiratory failure (ARF), remains significant [3]. Our aim was to assess the impact of patient demographics and disease-related factors on short- and long-term outcomes of patients with HM admitted to ICU.

Methods: Retrospective observational cohort study of patients with HM, requiring admission to ICU between December 2018-December 2020. Uni- and multi-variate logistic regression analyses were conducted to assess the impact of patient and disease factors on ICU / hospital and 1-year mortality, as well as on treatment escalation discussions.

Results: We analysed 238 patients with HM admitted to ICU. Patient demographics and disease characteristics are shown in Table 1. The most common haematological malignancy was non-Hodgkin lymphoma 75/238 (32.8%), 65/238 patients were on a first line treatment, while 125/238 (53.4%) had two or more comorbidities. End-of-life decisions were made in 86 patients (36.9%). Out of 238 patients, 156 (65.5%) were alive at time of ICU discharge, 131 (56.5%) were alive at time of hospital discharge and 104/238 (45.4%) were alive at one year. Having a diagnosis of lymphoma (OR 2.56; 95%CI 1.21-5.43; $p=0.01$) was associated with increased ICU and 1-year mortality (OR 2.58; 95%CI 1.22-5.48; $p=0.01$). Admitted in ICU with a diagnosis of myeloma was also strongly associated with increased risk for 1-year mortality (OR 2.3; 95%CI 1.08-4.93; $p=0.03$). Disease and transplant status on ICU admission were not independent risk factors, whereas the age of admitted patients significantly affected hospital and 1-year mortality (OR 1.04/year; 95%CI 1.01-1.06; $p=0.003$). Isolating a pathogen for ARF was significantly associated with lower ICU (OR 0.39; 95%CI 0.2-0.72; $p=0.003$) and hospital (OR 0.43; 95%CI 0.29-0.82; $p=0.01$) mortality. Documented discussions around treatment goals occurred

almost three times more often when the ARF diagnosis was known (OR 2.97; 95%CI 1.56- 5.65; $p=0.001$) but no other association was found.

Conclusions: In this retrospective, single cohort study, only haematological diagnosis on ICU admission and an established diagnosis for ARF were statistically significantly associated with ICU/hospital and 1-year mortality. The known association between undiagnosed AFR and mortality was also demonstrated by these data. However, association between less treatment escalation discussions and unknown ARF aetiology has not been previously reported. Whether this represents physicians' reluctance to limit therapy when a diagnosis is lacking or is a random effect requires further investigation.

Table 1: Patient demographics and disease characteristics.

Total Number n(%)	238 (100%)
Gender: n(%)	
Male	115 (63.4%)
Female	123 (52.6%)
Age: m (SD)	57.3 (13.5)
Co-morbidities: n(%)	
No co-morbidities	60 (25.4%)
One co-morbidity	50 (21.2%)
Two or more co-morbidities	125 (53.4%)
Missing	3 (1%)
Type of Malignancy: n(%)	
Leukaemia	
▪ AML	48 (21%)
▪ ALL	14 (6.1%)
▪ CML	10 (4.4%)
▪ CLL	11 (4.8%)
Lymphoma	
▪ HL	7 (3.1%)
▪ NHL	75 (32.8%)
Multiple Myeloma	33 (14.3%)
Other	31 (13%)
Disease Status: n(%)	
New diagnosis	41 (17.7%)
One line of treatment	65 (28%)
Two or more lines of treatment	33 (14.2%)
Disease remission	47 (20.3%)
Uncontrolled disease	43 (18.5%)
Palliative	3 (1.3%)
AML: Acute Myeloid Leukaemia, ALL: Acute Lymphoblastic Leukaemia, CML: Chronic Myeloid Leukaemia, CLL: Chronic Lymphoid Leukaemia, HL: Hodgkins Lymphoma, NHL: Non-Hodgkins Lymphoma.	

References

- (1) Azoulay E., et al. Acute hypoxemic respiratory failure in immunocompromised patients: the Efrain multinational prospective cohort study. *Intensive Care Med.* 2017 Dec;43(12):1808-1819.
- (2) Taheri L., et al. The role of a critical care outreach service in the management of patients with haematological malignancy. *Journal of the Intensive Care Society* 2019, Vol. 20(4) 327-334.
- (3) Bauer PR et al.; Efrain investigators and the Nine-I study group. Diagnosis and outcome of acute respiratory failure in immunocompromised patients after bronchoscopy. *Eur Respir J.* 2019 Jul 25;54(1):1,802,442

Topic: Haematologic-oncologic issues in the ICU.

000896

Metformin-associated lactic acidosis—5-year retrospective study in an Intensive Care Unit

D. da Costa Oliveira¹, P. Reis Pereira², D. Bento¹, M. Sousa¹, P. Pinto¹, A. Santos¹, F. Esteves¹

¹Intensive Care Unit, Centro Hospitalar De Trás-Os-Montes E Alto Douro, E.P.E., Vila Real, Portugal; ²Nefrology Department, Centro Hospitalar De Trás-Os-Montes E Alto Douro, E.P.E., Vila Real, Portugal

Correspondence: D. da Costa Oliveira

Intensive Care Medicine Experimental 2023, **11(Suppl 1)**:000896

Introduction: Metformin is generally regarded as a safe drug. However, one of its rarest but most feared adverse effects is metformin-associated lactic acidosis (MALA), with an associated mortality rate between 30 and 50%. Metformin is frequently contraindicated in patients with advanced stages of renal and hepatic insufficiency, as well as advanced heart failure, as these are known to be at an increased risk of MALA.

Objectives: The aim of this work was to evaluate the epidemiology and clinical outcomes of MALA, as well as the role of continuous renal replacement therapies for the treatment of MALA in our intensive care unit (ICU).

Methods: We selected all patients admitted for MALA in our ICU between 2014 and 2019. We evaluated patients' demographics, rate of mortality, length of hospital stay, treatment with continuous renal replacement therapy (CRRT), modality of CRRT, and previous medical history of renal, heart, or liver disease.

Results: The prevalence of MALA in our ICU patient population during the study period (n = 3825) was 0.05% (n = 20). The average patient age was 75.6 ± 5.7 years and the percentage of female patients was 60% (n = 12). The mortality rate was 10% (n = 2) and the average hospital length of stay was 16 ± 8 days. Twelve patients (60%) were submitted to CRRT; from these, 11 patients were treated with continuous venovenous hemodiafiltration (CVVHD), and 1 patient was treated with sustained low efficient daily diafiltration. In this patient population, chronic kidney disease was present in 75% of the population (n = 15); chronic heart failure in 95% (n = 19) and chronic liver disease in 15% (n = 3) of the population. Average lactate on hospital admission was 13.1 ± 2.8 mmol/L and the average percentage of lactate reduction in the first 24 h of ICU stay was 75 ± 21%. Hospital admission lactate levels and percentage of lactate reduction did not correlate with the length of hospital stay or need for CRRT.

Conclusions: The majority of patients with MALA admitted to ICU had chronic kidney disease or chronic heart failure. CRRT was used to treat a significant proportion of patients. The mortality rate in the ICU environment was lower than overall reported mortality rates for MALA in previous studies.

Topic: Acute Kidney Injury and haemofiltration

000897

Feasibility of 12 region lung ultrasound protocol in critically ill patients: preliminary analysis of a prospective multicentre observational cohort study

A. Mousa¹, S. G. Blok², P. Klompmaker¹, C. Plantinga¹, D. Karssen¹, J. E. Van Hoorn², H. J. De grooth³, A. C. Strang⁴, M. J. Blans⁵, L. Heunks⁶, M. Schultz⁷, F. Paulus⁸, P. R. Tuinman¹

¹Intensive Care, Amsterdam UMC, locatie VUmc, Amsterdam, Netherlands; ²Department of Intensive Care, Amsterdam UMC, locatie AMC, Amsterdam, Netherlands; ³Intensive Care Adults, Amsterdam UMC, Locatie VUmc, Amsterdam, Netherlands; ⁴Department of Intensive Care, Rijnstate, Arnhem, Netherlands; ⁵Intensive Care Medicine, Rijnstate, Arnhem, Netherlands; ⁶Intensive Care, Erasmus University Medical Center, Rotterdam, Netherlands; ⁷Intensive care, Amsterdam University Medical Centers, University of Amsterdam, Amsterdam, Netherlands; ⁸Intensive Care, Amsterdam UMC, Locatie AMC, Amsterdam, Netherlands

Correspondence: A. Mousa

Intensive Care Medicine Experimental 2023, **11(Suppl 1)**:000897

Introduction: Lung ultrasound (LUS) can be used for daily practice to monitor pulmonary pathologies and clinical decision making in critically ill patients (2). However, there is an ongoing debate concerning the optimal number of regions that should be scanned for an accurate assessment of lung pathology in critically ill patients (3). The 12-region LUS protocol is used most often (4). Nonetheless, the feasibility of a 12-region LUS protocol for daily monitoring of critically ill patients is not known.

Objectives: Primary aim of this study is to assess the feasibility of a daily 12-region LUS protocol in critically ill patients. Based on previous research and clinical expertise, we hypothesized that at least 85% of regions could be scanned (5). The secondary aim is to report factors of influence for missing regions.

Methods: This is a prospective multicentre observational cohort study that was performed as part of the 'Effect of lung ultrasound-guided fluid deresuscitation on duration of ventilation in intensive care unit patients' (CONFIDENCE). The CONFIDENCE protocol has been published previously (2). Patients received daily LUS after hemodynamic stabilisation. LUS examinations were performed by trained health-care professionals. A 12-region LUS protocol was used: six points per hemithorax. For each region, the operator scored the lung according to the LUS aeration score (6). If a region could not be assessed the option 'not assessable' could be selected.

Results: A total of 393 lung ultrasound examinations in 69 unique patients were analysed. 4137 (88%) of the 4716 lung regions were scored. The figure shows percentages of successful scored LUS examination per region. The anterior regions had the highest percentage of scored examinations. Regions R1, R2 and L1 were scored in 99% of examinations. L2 was scored less frequently with 96% scored. Mostly, due to the presence of the heart which impedes the assessment of lung tissue. The posterior regions (R5, R6, L5 and L6) were scored least often (72%). Reported factors influencing assessment included (in descending order of occurrence) high diaphragm position, thoracic drains or bandages in situ, lateral positioning of the patients in bed, habitus and discomfort or agitation of the patient.

Conclusions: More than 85% of lung regions can be examined in a 12-region LUS protocol in daily practice for critically ill patients. High diaphragm position, thoracic drains or bandages in situ, lateral positioning of the patients in bed, habitus and discomfort or agitation of the patient were reported as factors of influence for missing regions.

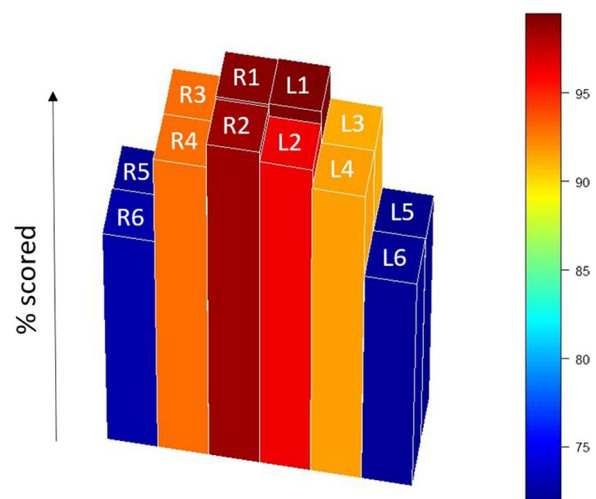

Percentage of successfully scored examinations per region. Each hemithorax is divided in to six regions: upper and lower parts of the

posterior (R5,R6, L5 and L6), lateral (R3, R4, L3 and L4) and anterior (R1, R2, L1 and L2) chest wall.

References

1. The CONFIDENCE-trial is completely funded by The Netherlands Organisation for Health Research and Development (ZonMW). ZonMW does not have any role in the design of the study or in collection, analysis, and interpretation of the data nor in writing the manuscript.
2. 6. Bouhemad B, Zhang M, Lu Q, Rouby JJ. Clinical review: Bedside lung ultrasound in critical care practice. *Crit Care*. 2007;11(1):205. doi: <https://doi.org/10.1186/cc5668>. PMID: 17316468; PMCID: PMC2151891.
3. 5. Robba C, Wong A, Poole D, Al Tayar A, Arntfield RT, Chew MS, Corradi F, Douflé G, Goffi A, Lamperti M, Mayo P, Messina A, Mongodi S, Narasimhan M, Puppo C, Sarwal A, Slama M, Taccone FS, Vignon P, Vieillard-Baron A; European Society of Intensive Care Medicine task force for critical care ultrasonography*. Basic ultrasound head-to-toe skills for intensivists in the general and neuro intensive care unit population: consensus and expert recommendations of the European Society of Intensive Care Medicine. *Intensive Care Med*. 2021 Dec;47(12):1347–1367. doi: <https://doi.org/10.1007/s00134-021-06486-z>. Epub 2021 Oct 5. PMID: 34,787,687; PMCID: PMC8596353.
4. 4. Demi L, Wolfram F, Klersy C, De Silvestri A, Ferretti VV, Muller M, Miller D, Feletti F, Wejnicky M, Buda N, Skoczylas A, Pomiecko A, Damjanovic D, Olszewski R, Kirkpatrick AW, Breikreutz R, Mathis G, Soldati G, Smargiassi A, Inchingolo R, Perrone T. New International Guidelines and Consensus on the Use of Lung Ultrasound. *J Ultrasound Med*. 2023 Feb;42(2):309–344. doi: <https://doi.org/10.1002/jum.16088>. Epub 2022 Aug 22. PMID: 35,993,596.
5. 3. Heldeweg MLA, Lieveld AWE, de Grooth HJ, Heunks LMA, Tuinman PR; ALIFE study group. Determining the optimal number of lung ultrasound zones to monitor COVID-19 patients: can we keep it ultra-short and ultra-simple? *Intensive Care Med*. 2021 Sep;47(9):1041–1043. doi: <https://doi.org/10.1007/s00134-021-06463-6>. Epub 2021 Jun 26. PMID: 34,173,859; PMCID: PMC8233591.
6. 2. Blok SG, Mousa A, Brouwer MG, de Grooth HJ, Neto AS, Blans MJ, den Boer S, Dormans T, Endeman H, Roeleveld T, Scholten H, van Slobbe-Bijlsma ER, Scholten E, Touw H, van der Ven FSLIM, Wils EJ, van Westerlo DJ, Heunks LMA, Schultz MJ, Paulus F, Tuinman PR. Effect of lung ultrasound-guided fluid resuscitation on duration of ventilation in intensive care unit patients (CONFIDENCE): protocol for a multicentre randomised controlled trial. *Trials*. 2023 Mar 24;24(1):226. doi: <https://doi.org/10.1186/s13063-023-07171-w>. PMID: 36,964,614; PMCID: PMC10038369.
7. 1. Robba C, Wong A, Poole D, Al Tayar A, Arntfield RT, Chew MS, Corradi F, Douflé G, Goffi A, Lamperti M, Mayo P, Messina A, Mongodi S, Narasimhan M, Puppo C, Sarwal A, Slama M, Taccone FS, Vignon P, Vieillard-Baron A; European Society of Intensive Care Medicine task force for critical care ultrasonography*. Basic ultrasound head-to-toe skills for intensivists in the general and neuro intensive care unit population: consensus and expert recommendations of the European Society of Intensive Care Medicine. *Intensive Care Med*. 2021 Dec;47(12):1347–1367. doi: <https://doi.org/10.1007/s00134-021-06486-z>. Epub 2021 Oct 5. PMID: 34,787,687; PMCID: PMC8596353.

Topic: Acute respiratory failure and mechanical ventilation

000899

Incidence of abnormal Venous Excess Ultrasound (VExUS) score in critically ill patients

P. Klompmaaker¹, D. Allard¹, A. Mousa², E. Mus³, H. J. De grooth⁴, A. P. J. Vlaar⁵, D. P. Veelo⁶; P. R. Tuinman¹

¹Intensive Care, Amsterdam UMC, locatie VUmc, Amsterdam, Netherlands; ²Intensive Care Medicine, Amsterdam UMC, Locatie VUmc, Amsterdam, Netherlands; ³Anesthesiologie, Amsterdam UMC, Locatie VUmc, Amsterdam, Netherlands; ⁴Intensive Care Adults, Amsterdam UMC, Locatie VUmc, Amsterdam, Netherlands; ⁵Department of Critical Care, Amsterdam UMC, Locatie AMC, Amsterdam, Netherlands; ⁶Anesthesiologie, Amsterdam UMC, locatie AMC, Amsterdam, Netherlands

Correspondence: P. Klompmaaker

Intensive Care Medicine Experimental 2023, 11(Suppl 1):000899

Introduction: Fluid overload is associated with worse outcomes in patients admitted to the intensive care unit (ICU).(1) Venous congestion has been suggested as possible explanation for these worse outcomes.(2) The Venous Excess Ultrasound (VExUS) score has been used to assess venous congestion.(3) However, the incidence of abnormal VExUS-score in the ICU is largely unknown.

Objectives: The aim of this preliminary report is to assess the incidence of abnormal VExUS scores and its components in critically ill patients.

Methods: This is a single-center prospective cohort study in adult ICU patients expected to be admitted for more than 24 h to a tertiary ICU. Within 48 h of ICU admission, VExUS was performed with an interval of 1–2 days, with a maximum of three times. The most abnormal ultrasound measurement was included in our analysis. Primary outcome was incidence of abnormal VExUS scores, defined as a score of 1 or more, and its individual components. Secondary outcome were any associations between patient characteristics and VExUS score.

Results: From January to April 2023 34 patients were included. 62% of the cohort was male, the mean age was 64.5(± 14.0) and 41% of patients were admitted due to sepsis. Of the 34 included patients 56% had an abnormal VExUS score and 3 (9%) patients had a VExUS score of ≥ 2. Incidence of abnormal interlobular renal vein waveforms was highest (53%) followed by abnormal portal vein waveforms (44%) and hepatic vein waveforms (35%) (Table 1). No significant associations between patient characteristics and VExUS scores were found. (p > 0.05 for all). All patients (n = 2), with a VExUS score of 3 died.

Table 1 (abstract 000899) VExUS score and individual parameters

Inferior vena cava diameter (cm), mean(± SD)	2.0(± 0.46)		
Inferior vena cava collapsibility %, median [IQR]	17.8 [6–28]		
Individual waveforms n (%)	Portal vein	Hepatic vein	Interlobular renal vein
<i>Normal</i>	19(56)	22(65)	13(38)
<i>Mildly abnormal</i>	10(29)	10(29)	17(50)
<i>Severely abnormal</i>	5(15)	2(6)	1(3)
<i>Failed</i>	0(0)	0(0)	3(9)
VExUS score, n (%)			
0	15(44)		
1	16(47)		
2	1(3)		

Conclusions: In this general critically ill population the incidence of an abnormal VExUS score was 56%. A score of ≥ 2 was found in 9%. No associations between patient characteristics and abnormal VExUS score were found. This is a preliminary report and the study will continue until the sample size of 136 patients is reached.

References

3. 3. Beaubien-Souligny W, Rola P, Haycock K, Bouchard J, Lamarche Y, Spiegel R, et al. Quantifying systemic congestion with Point-Of-Care ultrasound: development of the venous excess ultrasound grading system. *Ultrasound J*. 2020;12(1):16.
2. 2. Kattan E, Castro R, Miralles-Aguiar F, Hernandez G, Rola P. The emerging concept of fluid tolerance: A position paper. *J Crit Care*. 2022;71:154070.
1. 1. Messmer AS, Zingg C, Muller M, Gerber JL, Schefold JC, Pfortmueller CA. Fluid Overload and Mortality in Adult Critical Care Patients-A Systematic Review and Meta-Analysis of Observational Studies. *Crit Care Med*. 2020;48(12):1862–70.

Topic: Cardiovascular issues in ICU

000901

Text analytics to reduce administrative burden and improve data quality in intensive care: automatic detection of pressure ulcers from nursing reports

D. Van De Sande¹, ME. Van Genderen¹, J. Huiskens², A. Berkel³, J. Van Bommel¹, D. Gommers¹

¹Adult Intensive Care, Erasmus University Medical Center, Rotterdam, Netherlands; ²Healthcare, Microsoft, Schiphol, Netherlands; ³Healthcare, SAS Institute B.V., Huizen, Netherlands

Correspondence: D. Van De Sande

Intensive Care Medicine Experimental 2023, 11(Suppl 1):000901

Introduction: The recent advancements in artificial intelligence (AI) technologies have led to the development of prediction models for clinical decision-making in the intensive care unit (ICU) [1]. However, the availability of high-quality ICU data is fundamental for the development and implementation of these models [2]. While a significant amount of ICU data, such as vital signs or laboratory test results, are automatically collected and easily analyzed, other data, such as clinical complications, still require manual entry through additional checklists, resulting in poor data quality and an enormous administrative burden for ICU professionals [3].

Objectives: This study aimed to determine whether text analytics could reduce administrative burden and improve data quality for registering pressure ulcers in the ICU.

Methods: This study included adult patients (age > 17 years) admitted to the Erasmus University Medical Center ICU between January 1, 2022 and December 31, 2022. Pressure ulcer checklists and nursing reports were automatically extracted from the electronic health record. Natural language processing (NLP) techniques were utilized to extract pressure ulcers from unstructured nursing reports. Pressure ulcer rates were compared between structured checklists and unstructured nursing reports.

Results: The study analyzed a total of 2,524 ICU admissions and 2,286 unique patients, with 216,000 nursing reports and 9,586 checklists analyzed. The combined pressure ulcer rate was 13.6% (343 out of 2,524 admissions); 47/2,524 were identified from checklists and 296/2,524 from nursing reports. The use of NLP techniques improved pressure ulcer detection by 650% (from 1.8% to 11.7%; $p < 0.001$).

Conclusions: Text analytics can successfully be used to extract data from nursing reports and has the ability to improve data quality and to decrease administration fatigue in the ICU. Further research is necessary to explore the impact on ICU professionals' workflow.

References

1. There were no funding sources.
2. [1] van de Sande D, van Genderen ME, Huiskens J, Gommers D, van Bommel J, (2021) Moving from bytes to bedside: a systematic review on the use of artificial intelligence in the intensive care unit. Intensive Care Med 47: 750–760
3. [3] Hesselink G, Verhage R, Hoiting O, Verweij E, Janssen I, Westerhof B, Ambaum G, van der Horst ICC, de Jong P, Postma N, van der Hoeven JG, Zegers M, (2023) Time spent on documenting quality indicator data and associations between the perceived burden of documenting these data and joy in work among professionals in intensive care units in the Netherlands: a multicentre cross-sectional survey. BMJ Open 13: e062939
4. [2] Bellini V, Montomoli J, Bignami E, (2021) Poor quality data, privacy, lack of certifications: the lethal triad of new technologies in intensive care. Intensive Care Med 47: 1052–1053

Topic: Data Science

000902

Incorporating muscle ultrasound in mNUTRIC score as an added tool for nutritional assessment in critically ill patients: a prospective observational study from a tertiary care center

V. Sundarsingh¹, P. Rodrigues¹, M. Kumar¹, N. Baliga¹

¹Critical Care Medicine, Father Muller Medical College, Mangaluru, India

Correspondence: V. Sundarsingh

Intensive Care Medicine Experimental 2023, 11(Suppl 1):000902

Introduction: Loss of muscle mass impairs the physical recovery of critically ill individuals, increasing morbidity and mortality. Catabolism caused by inadequate diet and stress is a significant factor (1). It would be more important to identify at-risk patients early. The modified nutrition risk (mNUTRIC) score, a screening instrument to evaluate nutritional status in critically sick patients, has been proven to be accurate at predicting 28th day mortality (1). Muscle ultrasound (MUS), a nutritional evaluation technique, can be used to screen for sarcopenia to enhance the effectiveness of interventions for people at risk (3). In instances of muscle loss, the quadriceps muscle layer thickness (QMLT) is easy to define and assess, and ultrasonography of the quadriceps muscle also exhibits strong intra- and inter-observer reliability (2).

Objectives: •1) To determine whether adding QMLT to mNUTRIC will increase its capacity for prediction.

2) Finding an association between the mNUTRIC score and the Neutrophil-Lymphocyte ratio (NLR).

3) To determine whether mNUTRIC and ICU outcomes such as ICU length of stay (LOS), Mechanical Ventilation (MV) free days at 28 days, renal Replacement Therapy (RRT) free days at 28 days and duration of antibiotics are correlated.

Methods: All patients with age > 18 years admitted in intensive care unit were included in this study. Only the first ICU admission during a hospital stay were included. Patients with amputated limb, surgery, neurological, or rheumatological problems involving the lower limbs, patients with skin lacerations or wounds in the areas selected for ultrasound evaluation, patients readmitted to the ICU during the same hospital admission and patients transferred to other ICU/hospitals were excluded from the analysis. At admission all patients were scored with mNUTRIC score. They will also be subjected for Quadriceps muscle layer thickness (QMLT). Then mNUTRIC score will be modified with addition of muscle ultrasound (MUS), which will be referred to as mNUTRIC-MUS score. When Quadriceps muscle length ultrasound (QMLT) is used, QMLT > 1.72 cm was given 0 point & QMLT < 1.72 cm was given 1 point. Patients were classified as having a high mNUTRIC score if the sum is (5–9) and low score if the mNUTRIC score is (0–4).

Results: The study population consisted of 50 critically ill patients, with median age of 61 (54–73) years, among whom 37 (74%) were men. The median mNutric of 4 (3–6), and QMLT of 21.08 (16.90–25.54) mm. Secondary outcomes such as mechanical ventilator free days, vasopressor free days, need for RRT were not significantly different between those at high and low risk of malnutrition according to mNUTRIC. ICU length of stay (4 vs 7 days, $p = 0.016$) and NLR ((8.82 vs 17.61, $p = 0.03$) were significantly different between the groups at high and low risk of malnutrition. Receiver operating characteristic curves (ROC) with areas under the curve (AUC) for mNUTRIC AND mNUTRIC-MUS were similar and are described in the table below.

Conclusions: The addition of muscle ultrasonography to the mNUTRIC score had no effect on its predictive ability. In patients at high risk of malnutrition, the neutrophil-lymphocyte ratio was found to be considerably greater. As a result, in future studies, NLR can be explored for nutritional assessment of the critically ill patients.

TABLE-1: BASELINE CHARACTERISTICS OF STUDY POPULATION

CHARACTERISTIC(n=50)	VALUES
MEDIAN AGE	61(54-73)
NO OF MALE	37(74%)
MEDIAN LOS (ICU)	4 days (3-7)
MEDIAN LOS (HOSPITAL)	9 days (6-13)
MORTALITY	14(28%)
MEDIAN APACHE 2	14 (11-20)
MEDIAN SOFA	5 (3-6)
NO OF PATIENTS AT HIGH RISK FOR MALNUTRITION	12(24%)
MEDIAN mNUTRIC	4(3-6)
MEDIAN QMLT mm	21.08(16.9-25.54)
MEDIAN NLR	7.84(4.24-18.02)

TABLE – 2: COMPARISON BETWEEN LOW mNUTRIC AND HIGH mNUTRIC SCORE

PARAMETER	LOW mNUTRIC (<5)	HIGH mNUTRIC (5-9)	P value
Age	59(53-72)	61(54-73)	0.453
Length of stay (ICU)	4(3-5)	7(3.25-30)	0.016
Mortality	4/36	10/14	<0.001
QMLT (mm)	21.25(16.90-25.57)	21.02(16.10-25.02)	0.768
Neutrophil-Lymphocyte Ratio	8.82(3.41-17.07)	17.61(5.65-27.12)	0.030
C-reactive protein (mg/dl)	27.31(2.62-112.09)	132.50(21.61-194.68)	0.097

Fig 1: Receiver operating characteristic (ROC) curves of mNUTRIC & mNUTRIC-MUS

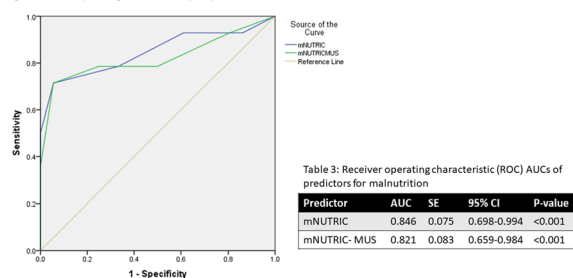

References

1. Ticinesi A, Meschi T, Narici MV, Lauretani F, Maggio M. Muscle Ultrasound and Sarcopenia in Older Individuals: A Clinical Perspective. *J Am Med Dir Assoc.* 2017 Apr 1;18(4):290–300
2. Lopulalan MDA, Airlangga PS, Utariani A. Relationship between modified Nutrition Risk in the Critically Ill (mNUTRIC) Score and nutrition intake with quadriceps femoris muscle thickness in critically ill patients. *Qanun Medika—Medical Journal Faculty of Medicine Muhammadiyah Surabaya.* 2021 Jul 24;5(2)

Topic: Metabolism, endocrinology, liver failure and nutrition

000903

Applications of machine learning models to predict severe sepsis and septic shock among neonates on mechanical intubation for respiratory failure

J. F. Hsu¹, M. H. Tsai², S. M. Chu³

¹Pediatrics, Linkou Chang Gung Memorial Hospital, Linkou, Taiwan;

²Pediatrics, Chang Gung Memorial Hospital, Yunlin, Taiwan; ³Pediatrics, Chang Gung Memorial Hospital, Linkou, Taiwan

Correspondence: M. H. Tsai

Intensive Care Medicine Experimental 2023, **11(Suppl 1)**:000903

Introduction: Early identification of critically ill neonates with risk of severe sepsis can optimize therapeutic strategies, guide empiric antibiotic use and avoid unnecessary broad-spectrum antibiotics. We aimed to examine whether machine learning (ML) methods can help clinicians toward more appropriate decision of empiric antibiotics for neonatal intensive care unit (NICU) patients on intubation due to respiratory failure.

Methods: A total of 1734 neonates with respiratory failure were randomly divided into training (70%, n=1214) and test (30%, n=520) sets. The primary outcome was occurrence of severe sepsis and/or septic shock. The area under the receiver operating characteristic curves (AUCs) of several ML algorithms were compared with that of the

conventional neonatal illness severity scoring systems including the NTISS and SNAPPE-II.

Results: For prediction of severe sepsis, the random forest (RF) model showed the highest AUC (0.930 [0.905–0.956]) for neonates on mechanical intubation with respiratory failure, and the bagged classification and regression tree model demonstrated the next best results (0.892 [0.859–0.924]). The ML methods are better than traditional methods to predict severe sepsis and/or septic shock. The superior performances and net benefit of the RF model were confirmed by the best accuracy (0.908), F1 score (0.714) and better calibration, and the decision curve analysis, respectively. In addition, Shapley additive explanation (SHAP) values were utilized to explain the RF prediction model.

Conclusions: Machine learning methods is applicable with good predictive accuracy to predict severe sepsis and/or septic shock in the NICU, which can help clinicians' decision regarding the choices of empiric antibiotics for critically ill neonates. Future prospective trials are warranted to document its clinical usefulness and benefits on reducing medical resources.

Topic: Sepsis

000905

Pharmacokinetics of minocycline in critically-ill patients with difficult to treat *Acinetobacter baumannii* ventilator-associated pneumonia; a preliminary report

Z. Athanassa¹, S. Manioudaki¹, A. Dimoula¹, I. Petsa¹, V. Charizopoulou¹, A. Dokoumetzidis², V. Koumaki³, A. Sakagianni¹, G. Valsami², A. Tsakris³

¹ICU, Sismanogleio General Hospital, Marousi, Greece; ²Department of Pharmacy, National and Kapodistrian University of Athens, Athens, Greece; ³Microbiology Department, National and Kapodistrian University of Athens, Athens, Greece

Correspondence: A. Sakagianni

Intensive Care Medicine Experimental 2023, **11(Suppl 1)**:000905

Introduction: The prevalence of multidrug resistant (MDR) *Acinetobacter baumannii* (*A. baumannii*) infections is increasing while available treatment options are limited. The lack of new effective antimicrobial agents has led to reintroduction of old antibiotics like minocycline for the treatment of MDR *A.baumannii*.

Objectives: The aim of this study is to assess minocycline pharmacokinetic properties after enteral administration in patients with extensively drug (XDR) and pandrug (PDR) resistant *A.baumannii* ventilator-associated pneumonia (VAP).

Methods: We conducted a prospective study of ICU patients between January 2022 and July 2022. Patients with a diagnosis of VAP due to XDR or PDR *A.baumannii* received minocycline as combination therapy. The diagnosis of VAP was based on observation of purulent secretions, deterioration of blood gas exchange, new infiltrates of chest computed tomography and isolation of XDR or PDR *A.baumannii* heavy growth at semiquantitative endotracheal aspirate (ETAS) cultures. The minimum inhibitory concentration (MIC) of minocycline was determined using broth microdilution. According to CLSI breakpoints, *A.baumannii* susceptibility to minocycline was defined as MIC ≤ 4 µg/ml, while an MIC up to 8 µg/ml was considered as intermediate susceptibility. Eligible patients received minocycline via nasogastric tube in a loading dose of 200 mg followed by 100 mg every 12 h. Blood samples were drawn at 1, 2, 6 and 11.5 h after loading dose. In addition blood samples were received on day 3 at 1, 4, and 8 h after administration of sixth maintenance dose (steady state). Minocycline serum concentration was determined by high performance liquid chromatography (HPLC). Demographics, co-morbidities and duration of treatment with minocycline were recorded. In addition, clinical and laboratory data (fever, haemodynamic instability, PaO₂/FIO₂ ratio, WBC count, CRP, procalcitonin) and cultures of endotracheal suction aspirates (ETSA) were assessed at the onset and end of treatment. End-point outcomes were clinical improvement defined as recession of clinical signs, increase of PaO₂/FIO₂ ratio, and microbiological response defined as no, rare or light bacterial growth in ETSA.

Results: Sixteen patients were included (13 men) with a mean age of 66.6 years. Most patients (15) had documented severe COVID-19 infection on ICU admission. Seven isolates were susceptible (MIC <4 µg/ml) and 9 were intermediately susceptible (MIC 8 µg/ml) to minocycline. The mean duration of treatment with minocycline was 9 days. Minocycline was co-administered with other antimicrobials mainly meropenem and/or colistin. At the end of treatment a favorable clinical response was observed in 12 out of 16 patients (75%), while a favorable microbiological response in 11 patients (69%). Median (IQR) minocycline serum concentrations at 1, 2, 6 and 12 h after administration of loading dose were 0.5 (0.41–1.08) µg/ml, 0.88 (0.46–2.16) µg/ml, 0.75 (0.24–1.08) µg/ml and 0.37 (0.06–0.89) µg/ml respectively. At steady state median (IQR) minocycline serum concentrations were 2.1 (0.95–4.1) µg/ml, 1.82 (0.71–3.6) µg/ml and 0.68 (0.31–1.14) µg/ml respectively at 1, 4 and 8 h after the sixth dose. Minocycline concentrations varied among patients at all sampling periods.

Conclusions: Minocycline serum concentrations peaked at 2 h after enteral administration of 200 mg bolus dose. At steady state, the highest serum concentrations were observed at 1 h after administration. However, even at steady state, minocycline serum concentrations were low compared with *A. baumannii* susceptibility breakpoints to minocycline. The observed variation in minocycline serum concentrations might be attributed to differences in drug absorption and patients' characteristics. Since currently minocycline is available only in enteral formulation in Europe further studies evaluating pharmacokinetics after administration of higher doses are needed.

References

- Lodise TP, Van Wart S, Sund ZM et al. Pharmacokinetic and pharmacodynamic profiling of minocycline for injection following a single infusion in critically ill adults in a phase IV open-label multicenter study (ACUMIN). *Antimicrob Agents Chemother* 2021; 65(3): e01809-20
- Athanasios Tsakris, Vasiliki Koumaki, Aristides Dokoumetzidis, Minocycline susceptibility breakpoints for *Acinetobacter baumannii*: do we need to re-evaluate them?, *Journal of Antimicrobial Chemotherapy*, Volume 74, Issue 2, February 2019, Pages 295–297, doi: <https://doi.org/10.1093/jac/dky448>
- Fragkou PC, Poulakou G, Blizou A et al. The role of minocycline in the treatment of nosocomial infections caused by multidrug, extensively drug and pandrug resistant *Acinetobacter baumannii*: A systematic review of clinical evidence. *Microorganisms* 2019; 7(6): 159

Topic: Infections and prevention

000907

A pilot multicenter randomized controlled trial on individualized blood pressure targets versus standard care among critically ill patients with shock

R. Panwar¹, B. McNicholas², C. Nita², A. Poulter³, L. Ferguson²

¹Intensive Care Unit, John Hunter Hospital, Newcastle, Australia;

²Intensive Care Unit, Galway University Hospital, Galway, Ireland;

³Intensive Care Unit, John Hunter Hospital, New Lambton Heights, Australia

Correspondence: R. Panwar

Intensive Care Medicine Experimental 2023, **11(Suppl 1)**:000907

Introduction: Critically ill patients with shock are often exposed to a significant degree of untreated relative hypotension during vasopressor support. (1) Such relative hypotension, quantified as 'mean arterial pressure (MAP) deficit', is independently associated with adverse clinical outcomes. (1) Whether minimizing such MAP-deficit during vasopressor therapy for shock may reduce the risk of adverse clinical outcomes in ICU needs to be tested in a definitive RCT. However, before embarking on a large RCT, we need to conduct a pilot phase to assess feasibility of this protocol.

Objectives: In this pilot RCT, we assessed feasibility of individualizing MAP targets based on patients' own pre-illness MAP, compared to standard care, during vasopressor support for shock in ICU.

Methods: Eligible patients were adults, aged 40 years or older, who were receiving vasopressor support for a non-hemorrhagic shock state in ICU. Thirty-seven eligible patients were randomly allocated to the standard care group or the intervention group at two tertiary-level academic ICUs in Australia and Ireland. The feasibility endpoint was time-weighted average MAP-deficit during vasopressor therapy. MAP-deficit was derived as the percentage difference between patients' pre-illness MAP and ICU achieved-MAP whilst on vasopressors. Preliminary efficacy outcomes were major adverse kidney events within 14 days (MAKE-14) and 14-day mortality. MAKE was defined as a composite measure of death, new renal replacement therapy, or doubling of serum creatinine level from pre-illness level at day 14.

Results: The cohort comprised of 37 patients (mean age, 65 years; 57% males). Baseline characteristics were overall well matched. The median time-weighted average MAP-deficit in the control group versus intervention group was 17%, [interquartile range (IQR): 10–21] vs. 9%, [IQR: 5–14], $p=0.026$ as shown in Figure 1. The median time-weighted average noradrenaline-equivalent dose in the control group versus intervention group was 0.06 mcg/kg/min [IQR: 0.03–0.11] vs. 0.11 mcg/kg/min [IQR: 0.06–0.15], $p=0.015$. Clinical outcomes and adverse events were similar across both groups (Table 1).

Table 1 (abstract 000907) Outcomes

	Standard (n=20)	Individualised (n=17)	P value
Day 14 all-cause mortality, n (%)	3 (15%)	1 (6%)	0.37
Major Adverse Kidney Event within 14 days, n (%)	4 (20%)	2 (12%)	0.50
Day 90 all-cause mortality, n (%)	4 (24%)	2 (13%)	0.41
Adverse events post-randomisation			
Atrial arrhythmia	3 (15%)	4 (24%)	0.51
Ventricular arrhythmia	3 (15%)	2 (12%)	0.77
Mesenteric or myocardial ischemia	0 (0%)	0 (0%)	-
Takotsubo cardiomyopathy	0 (0%)	1 (6%)	-
Bilateral digital ischemia	0 (0%)	1 (6%)	-
Ischemic stroke	1 (5%)	0 (0%)	-

IQR: Interquartile range; MAP: Mean Arterial Pressure, mmHg;

Conclusions: An individualized blood pressure target strategy during vasopressor therapy in ICU was feasible and safe in this pilot RCT. Adequate level of treatment separation was achieved in-between the two groups.

Study registration: ACTRN12618000571279.

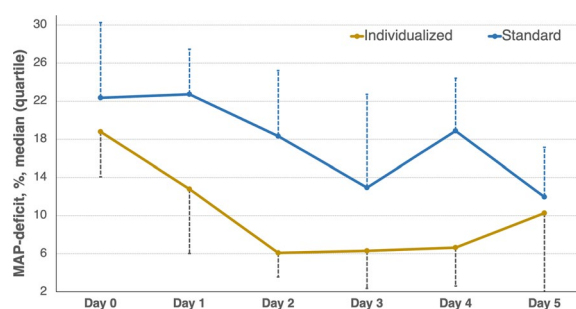

Figure 1 (abstract 000907) Percentage MAP-deficit over time in standard MAP target group versus Individualized MAP target group

References

1. Panwar R, Tarvade S, Lanyon N, Saxena M, Bush D, Hardie M, et al. Relative Hypotension and Adverse Kidney-related Outcomes among Critically Ill Patients with Shock. A Multicenter, Prospective Cohort Study. *Am J Respir Crit Care Med.* 2020;202(10):1407–18.
2. John Hunter Charitable Trust Grant

Topic: Cardiovascular issues in ICU

000909

Non-invasive monitoring of cardiopulmonary function parameters in mechanically ventilated adults

N. Fleming¹, N. Ayoubi², H. McGregor², S. Alexander², S. Bustin²

¹Department of anesthesiology and pain medicine, University of California, Davis, Davis, United States of America; ²Rostrum medical innovations inc., Rostrum Medical Innovations Inc., Vancouver, Canada

Correspondence: N. Fleming

Intensive Care Medicine Experimental 2023, **11(Suppl 1)**:000909

Introduction: Cardiopulmonary function parameters are critical in understanding ventilation-perfusion matching and guiding individual patient care. Pulmonary Blood Flow (PBF), Physiological Dead Space (VD), and Functional Residual Capacity (FRC) are currently measured using time-consuming and invasive methods. PBF is typically measured using thermodilution via a pulmonary catheter minus shunt fraction, VD via volumetric capnography coupled with blood-gas measurements and FRC via nitrogen washout. To overcome the limitations of these traditional methods, the non-invasive, semi-continuous VQm Pulmonary Health Monitor (PHM)TM has been developed to optimize therapy while providing near-real time data.

Objectives: The aim of this study was to evaluate the performance of the VQm PHMTM, a non-invasive cardio-pulmonary health monitor, in measuring PBF, VD, and FRC in mechanically ventilated surgical patients in comparison to established gold standard measurements.

Methods: PBF was estimated using a modified differential Fick equation and compared to the thermodilution cardiac output (TDCO). Shunt fraction was estimated from central venous and arterial blood gases measurements using the Berggren equation and the result was subtracted from TDCO to calculate the reference PBF1. VD was obtained using volumetric capnography and arterial blood gas values, similar to the reference measurement obtained using the GE Healthcare ventilator. FRC was compared to nitrogen washout methods also using the GE Healthcare CARESCAPETM ventilator. Agreement was evaluated using Bland–Altman analysis and concordance was characterized using four-quadrant plot analysis.

Results: 42 patients, mean age 66.7 ± 13.1 years, were included in this analysis. For PBF, 19 patients (17 males) produced 70 measurements. The mean difference between paired PBF values was 0.2 L/min, the 95% limits of agreement were 1.3 and -1.0 L/min (Fig. 1A) with a concordance of 93% (no exclusion zone) (Fig. 1B).

For VD, 19 patients (14 males) produced 89 paired measurements. The mean difference between paired VD values was -1%, the 95% limits of agreement were -13% to 10% (Fig. 2) with a concordance of 77% (2.5% exclusion zone).

For FRC, 23 patients (17 males) produced 98 paired measurements. The mean difference between the paired FRC values was -0.8L, the

95% limits of agreement were 0.4L to -2.1L with a concordance of 85% (2.5% exclusion zone) (Fig. 3).

Conclusions: Our results indicate good agreement and trending for PBF and VD and good trending for FRC measured using VQm and our reference values.

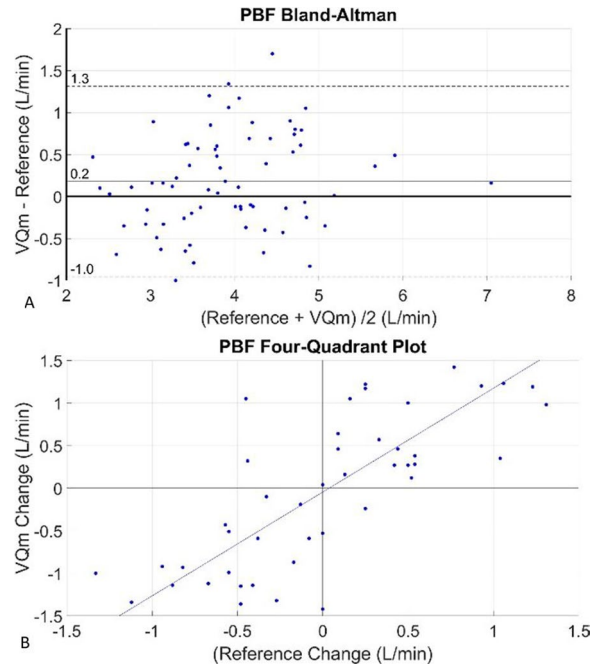

Figure 1 (abstract 000909) (A) Agreement between our reference PBF and values obtained using VQm PHMTM and (B) direction of change between VQm PHMTM PBF and our reference PBF

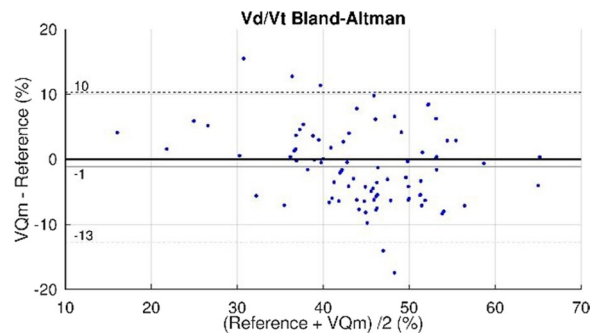

Figure 2 (abstract 000909) Agreement between our reference VD and values obtained using VQm PHMTM

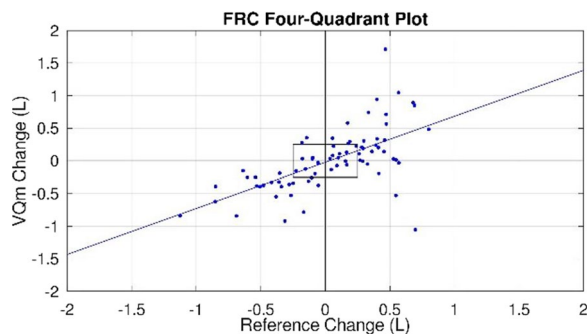

Figure 3 (abstract 000909) Direction of change between VQm PHM™ FRC and our reference FRC

References

1. Berggren SM. The oxygen deficit of arterial blood caused by non-ventilating parts of the lung. *Acta Physiol Scand Suppl.* 1942; 4: 1–92.
2. This study was funded by Rostrum Medical Innovations Inc.

Topic: Acute respiratory failure and mechanical ventilation

000911

Experiences of patient violence in Swedish intensive care units

F. Sjöberg¹, M. Salzmänn-Erikson², E. Joelsson-Alm³, A. Schandl³
¹Department of Anesthesia and Intensive Care, KI Södersjukhuset, Stockholm, Sweden; ²Department of Caring Sciences, Faculty of Health and Occupational Studies, University of Gävle, Gävle, Sweden; ³Department of clinical science and education, Karolinska Institutet, Södersjukhuset, Stockholm, Sweden

Correspondence: F. Sjöberg

Intensive Care Medicine Experimental 2023, **11(Suppl 1)**:000911

Introduction: In the intensive care unit (ICU), every second patient develops acute brain dysfunction and delirium, because of severe illness and/or medical treatment (1). ICU patients may have delusions and even believe that the healthcare personnel try to inflict harm upon them (2). This belief in combination with psychomotor agitation may lead to violent incidents in intense resistance (3). Except for debilitating consequences for patients, violent incidents are major problems in healthcare causing physical and psychological harm to healthcare workers (4–6). However, systematic approaches to describe healthcare workers' experiences and management of aggressive ICU patients are needed.

Objectives: To explore ICU healthcare workers' experiences and perceptions of violent behaviors in patients with acute brain dysfunction.

Methods: A qualitative descriptive design including focus group interviews with 36 ICU healthcare workers (physicians, nurses, nurse assistants and physiotherapists) in 4 Swedish ICUs who had experience of managing aggressive patients with acute brain dysfunction. A six-step reflective thematic analysis was used to analyse data.

Results: Nurses and assistant nurses were perceived to be at an increased risk of being exposed to violence, while physicians were mostly exposed to verbal assaults and threats from relatives. Delusions were perceived to be associated with a higher risk of violence in bedside work. The healthcare workers stated that incidents were under-reported, where only serious threats or physical assaults were reported. Most violent situations were experienced as unavoidable due to the patients' illness.

Conclusions: This study contributes an understanding of workplace violence in the ICU and may serve as a basis for development of violence prevention strategies useful in care and treatment of delirious patients.

References

6. Hahn S, Hantikainen V, Needham I, et al. Patient and visitor violence in the general hospital, occurrence, staff interventions and consequences: a cross-sectional survey. *J Adv Nurs* 2012; 68.
4. Phillips JP. Workplace Violence against Health Care Workers in the United States. *N Engl J Med* 2016; 375: e14.
3. Wharton T, Paulson D, Macri L, et al. Delirium and mental health history as predictors of aggression in individuals with dementia in inpatient settings. *Aging Ment Health* 2018; 22: 121–128.
2. Inouye SK, Westendorp RG, Saczynski JS, et al. Delirium in elderly people—authors' reply. *Lancet* 2014; 383: 2045. 2014/06/17.
1. Girard TD, Exline MC, Carson SS, et al. Haloperidol and Ziprasidone for Treatment of Delirium in Critical Illness. *N Engl J Med* 2018; 379: 2506–2516.
- Supported by a grant from AFA Försäkring
5. Nelson R. Tackling violence against health-care workers. *Lancet* 2014; 383: 1373–1374.

Topic: Sedation, analgesia and delirium

000912

Impact of CCL-14 on fluid management and hemodynamic monitoring of patients with severe AKI

I. Palmares¹, T. Vilaça¹, A. Curto², P. T. Freitas¹, S. Coelho¹

¹Intensive Care Department, Hospital Fernando Fonseca, Amadora, Portugal; ²Nephrology Department, Hospital Fernando Fonseca, Amadora, Portugal

Correspondence: I. Palmares

Intensive Care Medicine Experimental 2023, **11(Suppl 1)**:000912.

Introduction: Severe AKI is a common complication of critically ill patients, frequently observed in the context of multi-organ damage. Fluid management and hemodynamic monitoring can be particularly challenging in these patients. We aim to evaluate the impact of CCL-14, a biomarker of persistent severe AKI, in clinical practice.

Methods: A single-center, prospective, observational study of critically ill patients with AKI stage 2 or 3 by KDIGO criteria on ICU admission was performed. CCL-14 was measured by immunoassay on fresh urine samples within 48 h of admission and repeated after 48 h using the NEPHROCLEAR™ CCL14 Test on the Astute140® Meter (Astute Medical, San Diego, CA). We excluded patients with stage 5D chronic kidney disease; expected length of ICU stay < 48 h, renal replacement therapy (RRT) in the week prior to ICU admission; and patients with a clinical decision to start RRT prior to study inclusion. The assisting physician answered a questionnaire before and after CCL-14 determination.

Results: A total of 50 patients were included, median 71-year-old, 64% male, 88% caucasian, median APACHE 23.5. During ICU stay, 12% needed RRT, 82% vasopressors, 80% mechanical ventilation and 78% had septic shock. Diagnosis of AKI by KDIGO was performed by serum creatinine criteria in 54%, urine output in 28% and by both criteria in 14%. 42% had severe persistent AKI.

Before knowing the CCL-14 result, the assisting physician thought the fluid balance (FB) target should be positive in 46%, neutral 40% and negative 14% (CCL14 values were 1.95, 1.28 and 1.33 ng/ml, respectively). All clinicians answered they wouldn't change the current hemodynamic monitoring.

After knowing the CCL-14 result, the assisting physician thought the FB target should be positive in 38%, neutral 46% and negative 16% (CCL14 values were 0.80, 1.55 and 1.35 ng/ml). A positive FB (versus neutral or negative FB) was considered a target by a lower number of clinicians (Wilcoxon test p-value 0.046). Only 2% of clinicians (n=1) answered they would change the current hemodynamic monitoring.

Conclusions: CCL-14, by predicting persistent severe AKI, may be an additional tool to help clinicians decide the target FB of their patients. In our study, higher CCL-14 values were associated with a less probable choice of a positive FB. There was no difference in the choice of hemodynamic monitoring according to the CCL-14 value.

References

1. Identification and validation of biomarkers of persistent acute kidney injury: the RUBY study. Hoste E et al. *Intensive Care Med.* 2020; 46(5): 943–953.
2. Urinary immune cell phenotype of severe AKI in critically ill patients; Coelho S et al.; *Int Urol Nephrol.* 2022 Aug;54(8):2047–2055.

Topic: Acute Kidney Injury and haemofiltration

000913

Impact of early versus late tracheostomy in critically ill COVID-19 patients: experience of a single-center in Greece

M. Sileli¹; E. Kerezidou¹; M. Kamaterou¹; G. Katsikaki¹; D. Ntantos¹; G. Gogos¹; N. Kapravelos¹; C. Iasonidou¹

¹B ICU, General Hospital of Thessaloniki "George Papanikolaou", Thessaloniki, Greece

Correspondence: M. Sileli

Intensive Care Medicine Experimental 2023, **11(Suppl 1)**:000913

Introduction: In anticipated prolonged invasive mechanical ventilation, elective tracheostomy is indicated in critically ill COVID-19 patients. However, the optimal time to perform a tracheostomy in these patients is still debated.

Objectives: The primary endpoint was to assess the effect of tracheostomy timing on mortality in critically ill COVID-19 patients. The secondary endpoints were to evaluate its impact on invasive mechanical ventilation time (MV), ventilation-associated pneumonia (VAP), secondary infection, and length of ICU stay (LOS).

Methods: We conducted a retrospective, single-center study in a Greek tertiary-care ICU from March 2020 to April 2022. We included all adult patients with moderate to severe ARDS due to PCR-confirmed COVID-19 disease who underwent percutaneous tracheostomy. We recorded demographic data (age, gender, BMI), comorbidities quantified by the Charlson's Comorbidity Index (CCI), severity scoring (APACHE II, SOFA score), pO₂/FiO₂ ratio, days until tracheostomy, MV days, VAP, secondary infections, LOS, and ICU mortality. VAP was defined as clinical suspicion with concomitant positive cultures of tracheal aspirates. All patients were uniformly treated according to the national recommendations. None of them were fully vaccinated. We allocated patients into early and late tracheostomy groups (early ≤ 10 days, late > 10 days) and followed them until discharge or death in the ICU. The chi-square, student t-test, and Wilcoxon-Mann-Whitney U tests were used as appropriate. The p-value was set at 0.05. Statistical analysis was performed using the R statistical package.

Results: We analyzed data from 72 patients who underwent percutaneous tracheostomy with a mean age of 63.9 ± 9.4 years; 65.3% were males. The median Charlson Comorbidity index was 2 (IQR: 2 to 3.2), the mean APACHE II was 15.3 ± 3.3, and the median SOFA was 7 (IQR: 4 to 8). 58.3% of patients met the criteria for severe ARDS. The median LOS was 23 days (IQR: 19 to 33.2), with a mortality rate of 47.2%. None of the ICU healthcare workers was infected by Covid-19 due to the intervention. Twenty tracheostomies (27.8%) were performed early, and the rest late. No differences were observed regarding demographics, comorbidities, severity scores, and ARDS categories between groups (p > 0.05). There was no significant association between early tracheostomy and MV days, the incidence of secondary infections, the overall LOS, and the mortality rate (p > 0.05). Notably, VAP was significantly lower in the early tracheostomy group (p = 0.002) in our patients.

Conclusions: Early tracheostomy was associated with a reduced incidence of VAP in our cohort. However, it had no impact on mortality, duration of MV, the incidence of secondary infections, and faster discharge. These results extend the current observations. Further studies on the optimal time to perform a tracheostomy on COVID-19 patients are mandatory.

References

1. 2) Early vs. late tracheostomy in ventilated COVID-19 patients—A retrospective study. *Am J Otolaryngol* 2021;42:103,102
2. 1) Early versus late tracheostomy for critically ill patients. *Cochrane Database Syst Rev* 2015;1(1):CD007271
3. None

Topic: Acute respiratory failure and mechanical ventilation

000914

Vasopressin impact on the need of renal replacement therapies in septic shock patients

J. Cui¹, G. Castañeda¹, J. Cedeño Mora¹, P. García Olivares¹, C. Ramirez¹, C. Alvarez¹, R. Ruiz Cacho¹, N. Cango¹, A. Rodriguez¹, M. Artabe¹

¹Intensive care unit, H.G.U Gregorio Marañón, Madrid, Spain

Correspondence: G. Castañeda

Intensive Care Medicine Experimental 2023, **11(Suppl 1)**:000914

Introduction: Vasopressor therapy is used in septic shock to increase vascular resistance, raise mean arterial pressure and maintain perfusion of critical body tissues and organ systems. The Vasopressin and Septic Shock Trial (VASST) was the first large randomised comparison of vasopressin with Noradrenaline. Subsequent post hoc analyses and other studies suggested a potential reduction in renal dysfunction with higher dose vasopressin as well as a potentially synergistic interaction with corticosteroid treatment.

Objectives: To analyse the association between vasopressin (VAP) and noradrenaline (NAD) use with the need of Renal Replacement Therapies (RRT) in septic shock patients.

Methods: Observational, prospective study on septic shock patients admitted at Gregorio Marañón Intensive Care Unit (ICU) between March and December 2022, to assess the impact of vasopressin and noradrenaline use in the need of RRT in septic shock patients. Epidemiological data, comorbidities, severity, clinical features, invasive support, complications and outcomes were collected.

Descriptive analyses were expressed as means (standard deviation) for normally distributed quantitative variables, medians (interquartile range) for non-normally distributed variables, and as percentages for categorical data. Univariate analysis was performed using Chi-squared (relative risk) for qualitative variables, and simple logistic regression for quantitative variables. Severity adjusted multiple logistic regression was used to determine independent mortality related factors.

Results: 70 patients were included, 53% male. Mean age 61 ± 16 years. Charlson Index 3 (2–4).

Severity scales: APACHE II 26 ± 7, SOFA score at admission 10 ± 3, maximum SOFA score 12 ± 3.

Organic support: need of invasive mechanical ventilation 80%, mean duration of ventilation therapy 4 days (1–15).

Renal replacement therapy: in 50% of our cohort.

Initial volume expansion: In the ER 2000ml (1500–3000), first 6h at ICU 2000ml (1500-3000ml), first 24h at ICU 5000ml (4000–6000). 98% of patients had positive fluid balance after 24h at ICU. 32% of patients had negative or neutral fluid balance after 48h at ICU.

Effective lactate clearance during the first 24h since ICU admission was achieved in 54% of patients, patients had optimal preload in 72% of cases, and NAD dose at VAP initiation was 0.6 ± 0.4 ug/Kg/min.

Global ICU and in-hospital mortality: 49%

Univariate analysis: there was significant difference between the APACHE II score in patients needing RRT and those who did not need it (27 ± 8; 24 ± 7) p = 0,04, as well as SOFA score (9 ± 3; 12 ± 3), p = 0,01 and in lactate levels (5 ± 3; 12 ± 3) p = 0,03. The differences between the rest of the variables compared (Age, Charlson Index, time from shock to the initiation of VAP or NAD, time between NAD and VAP initiation and the NA dose at the moment of VAP initiation) were not statistically significant.

Conclusions: In our series, septic shock patients receiving NAD, using VAP as a second vasopressor, did not reduce the need of RRT.

Variable	Significance
Age	OR 0,67 (0,92 – 1,05)
Charlson Index	OR 0,57 (0,76 – 1,16)
APACHE II	OR 0,99 (0,91 – 1,10)
Lactate	OR 0,53 (0,99 – 1,47)
SOFA score on ICU admission UCI	OR 0,72 (0,98 – 1,68)
Time from hemodynamic shock to NAD initiation	OR 0,74 (0,74 – 1,01)
Time from hemodynamic shock to VAP initiation	OR 0,11 (0,98 – 1,17)
NAD dose at the moment of VAP initiation	OR 0,51 (0,29 – 11,94)

Topic: Acute Kidney Injury and haemofiltration

000915

ICU acquired weakness incidence and outcome after cardiac surgery

T. Soulele¹, K. Kolovou¹, M. Antonopoulos¹, M. Panoutsopoulou¹, E. Tzatzaki¹, M. Chronaki¹, E. Spiropoulou¹, C. Kindi¹, N. Rouvali¹, M. Georgopoulou¹, S. Dimopoulos¹

¹Icu, Onassis Cardiac Surgery Center, Kallithea, Greece

Correspondence: T. Soulele

Intensive Care Medicine Experimental 2023, **11(Suppl 1)**:000915

Introduction: ICU acquired muscle weakness (ICUAW) is associated with frailty, morbidity, prolonged hospital length and poor quality of life in patients post-critical illness.

Objectives: Aim of this study is to assess incidence of ICUAW in patients admitted in Cardiac Surgery ICU immediately after cardiac surgery and its association with clinical outcome.

Methods: 189 consecutive patients admitted to ICU after cardiac surgery participated in this study. Demographic and clinical characteristics were recorded and ICUAW was evaluated daily using MRC scale until 7th ICU stay or ICU discharge. ICUAW was defined as MRC scale < 48.

Results: 17 patients (9.5%, 67 ± 15 years) developed ICUAW after ICU admittance. These patients had higher EUROSCORE (7 ± 10 vs 2 ± 3, %, p < 0.001) longer cardio-pulmonary bypass (CPB) time (163 ± 65 vs 116 ± 49 min, p = 0.001) and aortic cross-clamp time (112 ± 40 vs 84 ± 41, min, p = 0.01), were more sedated (2139 ± 2131 vs 686 ± 437, min, p < 0.001), received more vasopressors (71 vs 26, %, p = < 0.001) and inotropes (82 vs 59, % p = 0.05), presented more delirium (71 vs 23, %, p < 0.001) and had more acute kidney injury (53 vs 22, %, p = 0.01). ICUAW was associated with longer duration of mechanical ventilation support [73 ± 97 vs 15 ± 10 h, p < 0.001] and ICU stay (129 ± 43 vs 39 ± 28 h, p < 0.001).

Conclusions: Patients post cardiac-surgery admitted in ICU present frequently with ICUAW. ICUAW is associated with adverse outcome and prolonged ICU stay.

Topic: Nursing care and physiotherapy

000916

Service evaluation of compliance with newly implemented ABCDEF bundle

H. Goudie¹, S. Norman¹

¹Center for Medical Education, School of Medicine, Cardiff University, Cardiff, United Kingdom

Correspondence: H. Goudie

Intensive Care Medicine Experimental 2023, **11(Suppl 1)**:000916

Introduction: In response to the increased recognition of long term consequences of surviving critical illness, The Society of Critical Care Medicine's (SCCM) (1) introduced the ABCDEF bundle (Assess, prevent, and manage pain[A]; Both Spontaneous Awakening Trial [SAT] and Spontaneous Breathing Trial [SBT] [B]; Choice of analgesia and sedation [C]; Delirium: assess, prevent, and manage[D]; Early mobility and exercise [E]; Family engagement and empowerment [F]) to incorporate preventative measures of care to reduce the risk of ICU patients developing delirium. The ABCDEF bundle aims to use a multicomponent strategy in preventing delirium and acknowledges the large number of predisposing factors that contribute to delirium in the critically ill patient. The ABCDEF bundle was implemented in the Researcher's unit in January 2022.

Objectives: To undertake a service evaluation to assess the Author's ICU compliance with the ABCDEF bundle to identify its effectiveness in reducing delirium.

Methods: We performed an in-depth literature review to help inform our service evaluation. We then conducted a single centre, retrospective service evaluation (SE) using all consecutive patient data collected from electronic health records to evaluate compliance with the ABCDEF bundle. All patient data was included with the exclusion of end of life (EOL) patients and patients that have been admitted to ICU for < 24 h. Data was collected from four ICUs within a single centre teaching hospital in England. Researcher 1 manually collected the data from electronic patient records during the dates 18/07/22 to 25/07/22, six months post ABCDEF bundle implementation. Each section of the ABCDEF bundle was extracted into a data collection question aimed to assess how compliant the ICU unit was with the bundle. If there is no compliance with a section of the bundle, the Researcher 1 investigated the patients' notes to identify why. This helped us draw conclusions about how to improve compliance with the bundle. Data was collected for each patient over one 24-h period.

Results: A total of 30 patient records met the inclusion criteria and their data was included in this service evaluation. All the patients (n = 30) were assessed for pain using the CPOT score, and of those patients assessed n = 5 was scored as having pain. Eighty-two percent of patients of patients receiving continuous sedation did not receive a sedation hold. Of 82% of patients that did not receive a sedation hold, 34% were too unstable for the sedation hold, 33% were too agitated for the sedation hold, 22% were not prescribed a sedation hold by the ICU doctors and 11% were having a transfer or procedure, therefore a sedation hold was not performed. The majority of patients that were mechanical ventilated received a SBT (69%). Of the patients that did not receive a SBT, 75% were deemed too unstable and 25% because the nurses had not carried out the SBT. The majority of RASS scores (97%) were in line with the correct RASS score prescribed for the patient. The majority of patients did not receive daily CAM-ICU scores (93%). Sixty five percent of patients were not mobilised. Staff not initiating mobilisation was the most common reason why patients were not mobilised (38%), followed by patient refusal (31%), patient instability (15%), nurses not being confident to mobilise the patient without the physiotherapist (8%) or physiotherapist assessing the patient as being too unstable to mobilise. Most patients

had family involvement (73%). Of the 27% percent of patients who did not receive family involvement, 63% of families were unable to visit, 13% refused to visit, 12% were not permitted to visit due to COVID-19 restriction and 12% had no relatives.

Conclusions: This service evaluation found that there were varying levels of compliance with each element of the bundle, with some elements having much better compliance than others. We found that the 'A' 'C' and 'F' elements of the bundle had good compliance, which refuted evidence identified in our review of the literature, where compliance was found to be variable (2, 3). However, the 'B' 'D' and 'E' sections of the bundle had poor compliance, due to several barriers to implementation; this was supported by the literature (2,3,4). We found that further improvement in compliance is needed for the ABCDEF bundle to be effective in reducing delirium in our organisation.

References

3. Frade-Mera, M., Arias-Rivera, S., Zaragoza-García, I., Daniel Martí, J., Gallart, E., José-Arribas, A., Velasco-Sanz, T. and Blazquez-Martinez, E., 2022. The impact of ABCDE bundle implementation on patient outcomes: A nationwide cohort study. *Nursing in Critical Care*, pp.1–12. doi: <https://doi.org/10.1111/nicc.12740>
1. Society of Critical Care Medicine (SCCM). 2020. SCCM | ICU Liberation Bundle (A-F). [online] Available at: < <https://www.sccm.org/ICULiberation/Home/ABCDE-Bundles> > [Accessed 26 June 2022].
2. Brown, J., Querubin, J., Ding, L., Mack, W., Chen-Chan, K., Perez, F., Barr, J., Peden, C. and Cobb, J., 2022. Improving ABCDEF Bundle Compliance and Clinical Outcomes in the ICU: Randomized Control Trial to Assess the Impact of Performance Measurement, Feedback, and Data Literacy Training. *Critical Care Explorations*, 4(4), p.e0679. doi: <https://doi.org/10.1097/cce.0000000000000679>
4. Pun, B., Balas, M., Barnes-Daly, M., Thompson, J., Aldrich, J., Barr, J., Byrum, D., Carson, S., Devlin, J., Engel, H., Esbrook, C., Hargett, K., Harmon, L., Hielsberg, C., Jackson, J., Kelly, T., Kumar, V., Millner, L., Morse, A., Perme, C., Posa, P., Puntillo, K., Schweickert, W., Stollings, J., Tan, A., D'Agostino McGowan, L. and Ely, E., 2018. Caring for Critically Ill Patients with the ABCDEF Bundle. *Critical Care Medicine*, 47(1), pp.3–14 doi: <https://doi.org/10.1097/ccm.0000000000003482>
- Grant Acknowledgement: This work was submitted in part for the MSC Critical Care, Cardiff University, Wales, UK

Topic: Sedation, analgesia and delirium

000917

Improving outcomes from Paediatric cardiac arrest in low resource setting

F. Ahmad¹; SK. Lok¹; MF. Jones¹; E. Yaakop²; E. Thompson³; S. Cole¹; R. Kadayam Sreenivasan¹; P. Bishop¹; P. Figgis¹; M. Ramali¹; B. Cadet¹; CST. Darren⁴; MA. Sadiq⁵; S. Cox⁶; SS. Kassim⁷

¹Department of Intensive Care, Colchester Hospital, Colchester, United Kingdom; ²Department of Cardiology, Serdang Hospital, Kajang, Malaysia; ³Resuscitation Unit, Colchester Hospital, Colchester, United Kingdom; ⁴Department of Internal Medicine, Keningau Hospital, Keningau, Malaysia; ⁵Department of Cardiology, Sultan Qaboos University Hospital, Muscat, Oman; ⁶Department of Cardiology, Princess Alexandra Hospital, Woolloongabba, Australia; ⁷Department of Cardiology, Hospital UiTM Sungai Buloh, Sungai Buloh, Malaysia

Correspondence: F. Ahmad

Intensive Care Medicine Experimental 2023, **11(Suppl 1)**:0009017

Introduction: Both Out of (OHCA) and In Hospital (IHCA) pediatric cardiac arrest has traditionally been considered a futile medical condition with dismal outcomes. This is further magnified by resuscitation protocols are typically articulated from the perspective of an ideal resource environment without much consideration of applicability in district hospitals or non-tertiary centre.

Objectives: To determine clinical outcomes from both paediatric OHCA and IHCA in low-resource settings, to identify shortcomings in relation to resuscitation in these areas, possible solutions and to suggest future research priorities.

Methods: This was a multicenter retrospective study in a middle sized urban city (estimated population 390,000) served by a single Emergency Medical Services (EMS) system. All records of OHPCA under 16 years old were reviewed from the Cardiac Arrest Registry from 2017 to 2022. Data collected included demographic profiles, etiology of cardiac arrest, initial cardiac rhythm, time of initiation of cardiopulmonary resuscitation (CPR) and adrenaline administration by EMS team and duration of CPR. Outcomes of interest included return of spontaneous circulation (ROSC) and survival to hospital discharge (STHD).

Results: From the 5-year study period, 68 children (mean age of 5.8±1.2 years) were included in this study. 22 (32.4%) were infants (< 1 year old) and 7 (10.3%) were neonates (<28 days old). Of those 68 cases, total mortality was observed at 63.23% (n=43). Return of spontaneous circulation (ROSC) was achieved in 9 (13.23%) of patients and 10.29% survived to hospital discharge. OHCA was witnessed in 72 (75.8%) children from total 95 OHCA cases and bystander CPR was delivered only in 19 (20.0%) cases while all IHCA were witnessed. Asystole was recognized as most common (n=35) initial rhythm at scene [Table 1]. A delay in initiating cardiopulmonary resuscitation (CPR) and adrenaline administration were observed in 49 cases of OHCA and 1 in IHCA. The median time from emergency call to CPR and from CPR to first adrenaline administration was 20.4±1.4 min and 2.2±1.8 min for OHCA and 0.7±0.2 min and 1.8±0.7 min for IHCA. Longer time to CPR and adrenaline administration was associated with lower chance of achieving ROSC and STHD. Using multivariate analyses, fewer adrenaline doses (p<0.05), witnessed cardiac arrest (p=0.001), initial rhythm of ventricular fibrillation (p<0.05) and shorter CPR duration (p=0.007) were good prognostic factors for ROSC and STHD.

Conclusions: Outcomes from OHPCA in low resource settings are poor. Unwitnessed OHCA, delays in the initiation of CPR and adrenaline administration were each associated with lower survival. Recognition and timely identification of at-risk patients as well as delivery of high-quality CPR and post-cardiac arrest care are imperative to maximize the chances of achieving favorable outcomes. Effective resuscitation protocols and for low-resource settings should be developed collaboratively involving local experts and the EMS team.

Table 1: Child's demographic and associations with outcome

	All (n=98)	Return to Spontaneous Circulation		Survival to Hospital Discharge	
		YES	NO	YES	NO
Witnessed OHCA	52	22	30	10	42
Bystander CPR	19	12	7	8	11
Time to CPR by EMS (min) [Mean±SD]	20.9±1.2	18.8±1.2	20.7±1.5	18.9±1.3	20.8±1.7
Total CPR period (min) [Mean±SD]		19.3±3.3	31.2±7.7	19.4±4.7	23.8±2.2
Time to 1 st Adrenaline from CPR [Mean±SD]	2.9±1.3	2.9±1.7	3.1±1.9	1.9±2.7	2.1±1.8
Witnessed IHCA	6	6	0	5	1
Time to CPR (min) [Mean±SD]	0.4±0.2	0.4±0.1	0.6±0.1	0.4±0.1	0.6±0.2
Total CPR period (min) [Mean±SD]		11.3±2.2	27.5±2.7	9.9±1.7	26.2±3.7
Time to 1 st Adrenaline (min) from CPR [Mean±SD]	1.5±0.7	1.5±0.3	2.1±0.3	1.5±0.5	2.0±1.6

Table 1

References

- 1] Rajan S, Resuscitation. 2015 Mar;88:12–9.
- 2] McKenzie K. *Front Pediatr*. 2022 Feb 22;10:826294.
- N/A

Topic: Cardiac arrest

000918

Assessment of extra intensive care nurses's skills after target learningI. K. Ben¹, I. Sdiri², F. Essafi³, I. Talik⁴, N. Ben Slimene⁵, M. Kaddour⁶, T. Merhabene⁷

¹Réanimation, Hôpital Régional de Zaghouan, Zaghouan, Tunisia; ²ICU, Hopital Habib Thameur, Ariana, France; ³Intensive Care Unit, Regional Hospital Zaghouan, Zaghuan, Tunisia; ⁴Réanimation médicale, ICU of Zaghouan Regional hospital, Tunis, Tunisia; ⁵Intensive Care Unit, Hôpital Régional de Zaghouan, Zaghouan, Tunisia; ⁶Intensive Care Unit, Zaghouan Hospital, Zaghouan, Tunisia; ⁷Réanimation Médicale, ICU of Zaghouan Regional Hospital, Tunis, Tunisia

Correspondence: I. Sdiri*Intensive Care Medicine Experimental* 2023, **11(Suppl 1)**:000918

Introduction: Extra ICU Nurses report emotional distress and feelings of inadequacy with the complexity of intensive care procedures. The main reported challenge has been the lack of proper training in curative and palliative management.

Objectives: This study aimed to examine healthcare professionals' attainment after target learning of extra ICU nurses.

Methods: This was a cross-sectional pre and post intervention among healthcare professionals of the physical medicine and rehabilitation department of Zaghouan Regional Hospital (Tunisia). The participants answered a 5-item survey evaluating management of different ICU situation and stress level based on the scale EPSS (Educational Practices in Simulation Scale). It was used to assess improvement in knowledge, skills and stress degree before and after special learning.

Results: Twenty four responses were compiled. Median age of participants was 32 years [25–45] with a gender-ratio of 0.84 and a median work of experience of five years [4–18]. The results of the simulated clinical immersions showed significantly improvement in self-efficacy scores ($p=0.02$). A one tailed paired t-test presented a significant increase from pre-test scores ($M=18.5$, standard deviation (SD)=5.9) to post-test scores ($M=33.5$, $SD=3.7$); ($p<0.001$). On another hand, our study showed positive differences between pre- and post simulation, indicating that learning outcomes were attained through simulation. We noted a decrease in the sensation of difficulty to practice some acts demonstrated through the simulation and the stress face some situation ($p=0,04$ and $p=0,02$ respectively). However, the confidence of their skills was decreased after the simulation ($p=0,02$). Finally, we don't found difference in the sensation of irritation and nervosity in pre and post-test ($p=0,1$).

Conclusions: Our study showed that simulated training had a positive impact on the healthcare professionals' acquisition of palliative care. We demonstrated that simulation training was an efficient tool for implementing new protocols, thus bringing benefits to healthcare systems, professionals and patients.

Topic: Data Science

000919

Reducing unnecessary blood testing in intensive care—a quality improvement projectA. Batista¹, O. Jundi¹

¹Anaesthesia and Critical Care Department, Bradford Royal Infirmary, Bradford, United Kingdom

Correspondence: A. Batista*Intensive Care Medicine Experimental* 2023, **11(Suppl 1)**:000919

Introduction: Patients in intensive care units are critically unwell and require close monitoring of physiological and analytical parameters. This has been shown to lead to high volume of blood testing with associated blood loss, anaemia and increased need for red blood cell transfusions (Chant C, 2006). A recent QI study published in the British Medical Journal where they obtained a significant decrease of about 1.4 tubes of blood drawn per patient-day showed a statistically significant decrease in the number of red blood cell transfusions (Bodley

T, 2023). Reducing unnecessary blood tests is not only a cost-saving measure, it also prevents patient harm.

Objectives: With this quality improvement project we aimed to audit phlebotomy volume and design an intervention aimed at reducing unnecessary blood testing.

Methods: Retrospective audit of all patients admitted to our 16-bed district general hospital intensive care unit in the month of September 2022 and number of blood tests collected. A structured approach was used to first identify main factors leading to unnecessary blood test ordering and then design specific interventions to address these. A post-intervention audit is planned to evaluate intervention effect and consider next steps.

Results: During the month of September of 2022 there were a total of 80 patients admitted to the intensive care unit, comprising a total of 373 patient-day episodes. There were an average of 2.67 tubes of blood collected per patient-day and 337 full blood count (FBC) tests done (average of 0.9 per patient-day), 330 coagulation screens (average of 0.88 per patient-day), 333 urea and electrolytes (U&Es) tests (average of 0.89 per patient-day) and 324 liver function tests (LFTs), bicarbonate, chloride, calcium, phosphate and magnesium (average of 0.87 per patient-day). Without taking into account the significant volume of blood taken for blood gas analysis (average of 3.9 per patient-day and other small volume tests done, this constitutes an average of 9.4 mL of blood per patient per day, increased significantly if we could account for the blood discarded as waste when drawing from arterial of central lines. Looking at a randomly selected date 67% of liver function tests and 60% of coagulation screens were likely unnecessary—within physiological range on that date and previous date and not needed for clinical decision making.

Main factor identified as causative is that daily blood tests are requested and collected by the night nursing team before handover and requests are based on electronic order sets. Secondary factors included knowledge gap regarding potential harm and absence of a mechanism to evaluate frequency of blood testing in ward rounds.

We are currently working to change the electronic order sets to a daily profile with only FBC, U&Es and extended electrolytes and an extended order set that includes LFTs and coagulation screen. We are also working to create a night ward round proforma on our electronic system that includes a review of blood test requests and their frequency. Finally, once these are implemented we will start an educational and awareness campaign and audit results over another month to consider how effective this was and next steps.

Conclusions: Unnecessary blood testing is a very relevant issue in current medical practice given the accessibility and ease of request and it is especially important in intensive care units with the acuity of patients and the presence of sampling lines. Education about the potential harms and understanding of the precipitating factors is vital to improve patient care.

References

1. Chant C, Wilson G, Friedrich JO. Anemia, transfusion, and phlebotomy practices in critically ill patients with prolonged ICU length of stay: a cohort study. *Crit Care* 2006;10:R140
2. Bodley T, Levi O, Chan M, et al. Reducing unnecessary diagnostic phlebotomy in intensive care: a prospective quality improvement intervention BMJ Quality & Safety Published Online First: 19 January 2023. doi: <https://doi.org/10.1136/bmjqs-2022-015358>

Topic: Critical care organisation, quality management, information systems, outcomes.

000921

Electrical impedance tomography to monitor and optimize ventilator setting after lung transplantV. Cattaneo¹, J. Fumagalli¹, A. Guzzardella², V. Scaravilli¹, F. Damarco³, C. M. Letizia⁴, G. Grasselli²

¹Department of Anesthesia, Critical Care and Emergency, Fondazione IRCCS Cà Granda Ospedale Maggiore Policlinico, Milan (MI), Italy, Italy;

²Department of Pathophysiology and Transplantation, University of Milan, Milan (MI), Italy; ³Department of Cardio-Thoraco-Vascular Diseases,

Fondazione IRCCS Ca'Granda Ospedale Maggiore Policlinico, Milan (MI), Italy, Italy; ⁴Department of Internal Medicine, Respiratory Unit and Cystic Fibrosis Center, IRCCS Fondazione Ca' Granda—Ospedale Maggiore Policlinico, Milan (MI), Italy

Correspondence: V. Cattaneo

Intensive Care Medicine Experimental 2023, 11(Suppl 1):000921

Introduction: The optimal management of mechanical ventilation after lung transplantation (LUTX) is currently based on expert opinion. Particularly, the distribution of ventilation (V) and perfusion (Q) after LUTX and the effect of Positive End-Expiratory Pressure (PEEP) upon it has not been described, except with pulmonary scintigraphy (REF), which use is limited by invasiveness and availability.

Objectives: To non-invasively evaluate the regional distribution of V and Q (by electrical impedance tomography (EIT) – Enlight, Timpel, BRA) alongside gas exchange, partitioned lung mechanics, at three PEEP levels in the postoperative period of LUTX recipients.

Methods: Consecutive patients who had undergone bilateral LUTX were studied within 24 h after graft reperfusion. Three PEEP levels (14–10–6 cmH2O) were tested throughout a decremental PEEP trial, preceded by a recruitment maneuver. While paralyzed and ventilated (tidal volume: 6 mL/kg donor predicted body weight), V and Q regional distribution, regional lung collapse and hyperdistention were calculated while regional lung Q was assessed by hypertonic saline bolus, according to EIT. In addition, partitioned lung mechanics, gas exchange, and hemodynamics were collected.

Results: Six patients (Table 1) were enrolled from January 1st to April 10th, 2023.

Table 1 (abstract 000921) Patient characteristics at enlistment and at postoperative baseline

Patient	Gen-der	Enlistment			Postoperative baseline					
		Age yr	Disease	LAS score	LS dx %	PEEP cmH2O	CrS, mL/cmH2O	PaO2/FiO2 mmHg	Vd tot/VT, %	Qs/Qt %
1	M	59	IPF	39	44	8	56	334	68	4
2	M	37	CF	36	93	10	54	250	60	13
3	M	66	COPD	37	65	10	64	390	59	4
4	M	55	IPF	40	51	10	55	309	56	7
5	M	59	Systemic scler-osis	43	45	10	56	309	59	7
6	M	37	Sar-coido-sis	37	54	10	48	230	48	13

M, male; LAS, lung allocation score; LS, lung scintigraphy; PEEP, positive end-expiratory pressure; CrS, compliance of the respiratory system; PaO2/FiO2 arterial pressure of O2 / fraction of inspired O2; Vd tot/VT respiratory dead space / tidal volume; Qs/Qt pulmonary shunt fraction.

EIT at all PEEP levels – documented: 1/similar distributions of V between left and right grafts (absence of bronchial anastomosis strictures), 2/re-establishment of Q distribution between grafts (adequate functioning of vascular anastomosis). The Intermediate PEEP resulted in the highest respiratory system compliance (best balance between collapse and hyperdistention) (Figure 1). No difference in shunt level or dead space fraction was observed. A minimal effect of the PEEP level was observed on ventral to dorsal lung perfusion distribution, while the High PEEP level caused a reduction of ventral ventilation (Figure 2).

Conclusions: In the immediate post-LUTX period, EIT is a feasible option to monitor ventilation and perfusion distribution. Intermediate PEEP levels guarantee optimal graft ventilatory mechanical properties and gas exchange without affecting lung perfusion distribution.

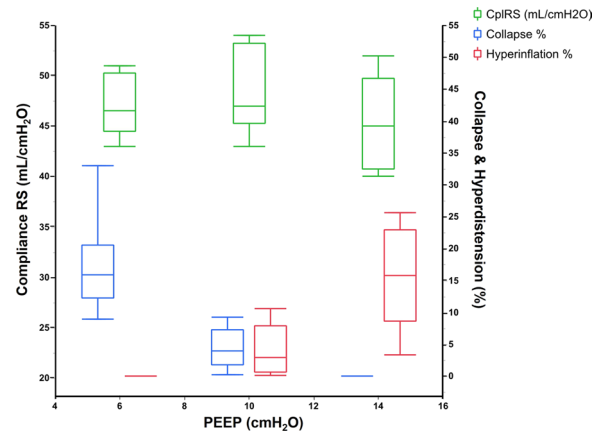

Figure 1 (abstract 000921) Distribution of Crs, collapse and hyperinflation at different PEEP levels. CplRS: respiratory system compliance

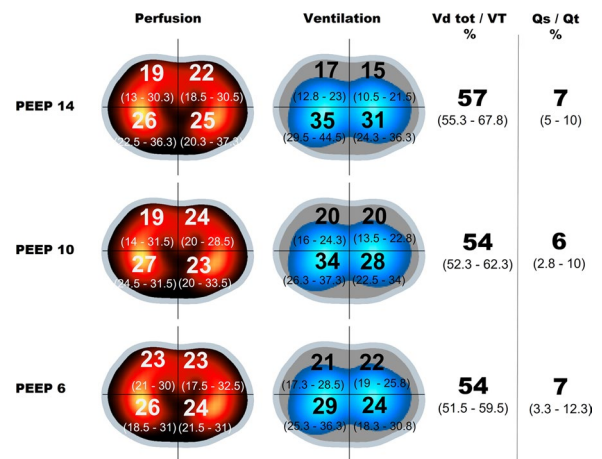

Figure 2 (abstract 000921) Regional distribution of ventilation, perfusion, dead space and shunt at different PEEP levels. Vd tot/VT respiratory dead space/ tidal volume; Qs/Qt pulmonary shunt fraction

References

1. Pinho DF, Banga A, Torres F, Mathews D. Ventilation perfusion pulmonary scintigraphy in the evaluation of pre-and post-lung transplant patients. *Transplant Rev (Orlando)*. 2019 Apr;33(2):107–114.
2. Zaronello F, Sella N, Pettenuzzo T, Andreatta G, Dell'Amore A, Giraudo C, Rea F, Navalesi P. Bedside detection and follow-up of pulmonary artery stenosis after lung transplantation. *Am J Respir Crit Care Med* 2021;204:1100–1102.

Topic: Acute respiratory failure and mechanical ventilation

000922

Divergence in institutional extracorporeal organ support efficacies: insights from COVID-19 pandemic

S. Y. Won¹, B. S. K. Yang², S. Park³, S. H. Lee⁴, H. J. Yeo⁵, W. H. Cho⁵, H. G. Jeong⁶, S. Y. Lim⁷

¹Division of Interdisciplinary Critical Care Medicine, Department of Neurosurgery, Seoul National University Bundang Hospital,

Seongnam-si, Republic of Korea; ²Division of Interdisciplinary Critical Care Medicine, Department of Neurology, Seoul National University Bundang Hospital, Seongnam-si, Republic of Korea; ³Div. of Pulmonary, Allergy & Critical Care Medicine, Dept. of Internal Medicine, College of Medicine, Hallym University, Hallym University Sacred Heart Hospital, Anyang-si, Republic of Korea; ⁴Division of Pulmonary And Critical Care Medicine, Department of Internal Medicine, Severance Hospital, Yonsei University College of Medicine, Seoul, Republic of Korea; ⁵Division of Allergy, Pulmonary and Critical Care Medicine, Department of Internal Medicine, Pusan National University Yangsan Hospital, Yangsan-si, Republic of Korea; ⁶Neurosurgery, Seoul National University Bundang Hospital, Seongnam-si, Republic of Korea; ⁷Department of Pulmonary and Critical Care Medicine, Seoul National University Bundang Hospital, Seongnam-si, Republic of Korea

Correspondence: H. G. Jeong

Intensive Care Medicine Experimental 2023, **11(Suppl 1)**:000922

Introduction: Extracorporeal organ support (EOS) is a radical but necessary solution for severely decompensated physiology, requiring expert knowledge and experience. However, depending on the practicing environments, clinicians might not be granted with sufficient exposure to such unique techniques. This gap between the technique's necessity and providers' preparedness is suspected to be a possible explanation for considerably variable outcomes following the technique's application. A recent devastating pandemic, coronavirus disease 2019 (COVID-19), has led to spiking incidence of multiple organ failures, and the need for EOS accordingly rose. Amid this disaster, our understanding of EOS might have chance to be improved.

Objectives: This study examined the relationship between patient mortality outcome and the indicators of each institution's familiarity with EOS to deduce reasons for variability in its efficacies.

Methods: Data is pulled from ongoing, prospectively collected multicenter registry-based database containing demographic and clinical information of patients treated for severe acute respiratory syndrome coronavirus 2 (SARS-CoV2) infection at participating institutions. For each institution, the ratio of cases where EOS was utilized to the number of entire cases was calculated. EOS modalities of interest included mechanical ventilation (MV), extracorporeal membranous oxygenation (ECMO), and continuous renal replacement therapy (CRRT). For each modality, institutions were ranked based on the respective ratio and classified into either more or less experienced depending on whether it belonged to the upper or lower half ranks. Then, the association between mortality and experience status was analyzed by calculating adjusted odds ratios (AOR).

Results: In total, 1,114 patients from 26 hospitals were included in the analysis. 294 (26%) patients died while admitted, and the mortality rates ranged from 15 to 50%. The extent of experience varied significantly among hospitals. For MV, ECMO, and CRRT, the proportion of EOS utilization respectively ranged from 14.8% to 100%; from 0% to 31.7%; and from 0% to 31.7%. Utilization of every EOS modality was significantly associated with mortality (AOR: MV 4.24 [95% CI: 2.28–8.06]; ECMO 5.0 [95% CI: 2.37–10.8]; CRRT 10.5 [95% CI: 4.83–24.4]). However, the experience status did not show significant associations with mortality (AOR: MV 1.46 [95% CI: 0.82–2.63]; ECMO 1.19 [95% CI: 0.7–2.03]; CRRT 0.76 [95% CI: 0.44–1.32]).

Conclusions: Relative familiarity with each EOS modality did not show associations with mortality outcomes. This futility might reflect our yet incomplete understanding of reasons behind variable EOS efficacies and suggests further investigation.

References

1. The authors are on behalf of Korean Intensive Care Study Group. This study is supported by grant No. (KATRD-S-2021-2) from the Korean Academy of Tuberculosis and Respiratory Diseases)

Topic: Acute respiratory failure and mechanical ventilation

000924

Analysis demographic, baseline characteristics and outcomes

of patients admitted to an Intermediate Care Unit in whom ICU admission was considered futile

D. Muñoz-Mingarro Molina¹, M. García Godes¹, A. A. De Abreu Ramírez², R. Marín Ráez¹, O. González Fernández¹, J. Sainz Cabrejas¹; R. De Pablo³

¹Intensive Care Medicine, Hospital Ramón y Cajal, Madrid, Spain;

²Intensive Care, Ramon y Cajal, Madrid, Spain; ³Intensive Care Medicine, Hospital Ramón Ycajal, Madrid, Spain

Correspondence: D. Muñoz-Mingarro Molina

Intensive Care Medicine Experimental 2023, **11(Suppl 1)**:000924

Introduction: Intermediate care units are increasingly used for their potential to optimize hospital throughput, reduce the pressure on intensive care unit (ICU) beds and reduce ICU mortality [1] However, the diversity in formats of these units is remarkable. Several groups of patients may benefit from admission to these units. Patients whose admission to a full ICU is considered futile represent an important cohort in these units, because despite the patient's frailty, implementation of some support therapies may be beneficial [2].

Objectives: The main objective of this study is to describe demographic, baseline characteristics and outcomes of patients admitted to our Intermediate Care Unit in whom ICU admission was considered futile. As secondary objectives, we intend to record life support therapies required by these patients.

Methods: We performed a retrospective observational study during an 8-month period. All patients admitted to our Intermediate Care Unit in whom ICU admission was considered futile were included. In our Intermediate Care Unit, continuous monitoring, vasoactive drug infusion, high flow nasal cannula, non-invasive ventilation, and hemodialysis are available. Nurse to patient ratio is 1:4.

Results: Quantitative variables are expressed as median and interquartile range (IQR). Qualitative variables are expressed as proportions. Statistical analysis was performed with R 4.2.2 for Windows.

During the study period, 43 patients were included. 63% were male; Median of age was 78 years old (69–81). 6-month survival was 83%. APACHE II and Charlson Comorbidity Index were respectively 18 (15–25) and 7 (5–8). Median length of stay was 4 days (2–6). Septic shock was the most common principal diagnosis at the moment of admission (57%), followed by respiratory failure (18%).

Norepinephrine infusion was required in 54% of patients. Need for high oxygen nasal cannula and non invasive mechanical ventilation were respectively 32 and 27%. In 5% of patients hemodialysis was indicated.

Conclusions: Admission to an Intermediate Care unit of selected patients in whom ICU admission was considered futile may be associated with a high 6 month-survival.

The most frequently life support measures required were norepinephrine infusion and high flow oxygen.

References

1. [2]Torres OH, Francia E, Longobardi V, Gich I, Benito S, Ruiz D. Short- and long-term outcomes of older patients in intermediate care units. *Intensive Care Med.* 2006 Jul;32(7):1052–9.
2. [1]Plate JDJ, Peelen LM, Leenen LPH, Hietbrink F. The intermediate care unit as a cost-reducing critical care facility in tertiary referral hospitals: a single-centre observational study. *BMJ Open.* 2019 Jun 4;9(6):e026359.

Topic: Critical care organisation, quality management, information systems, outcomes

000925

Hypertriglyceridemic pancreatitis- 20 year study of clinical presentation, management and outcomes

V. Ahluwalia¹, J. Agarwal¹, K. Jalagam¹, A. Alkurashi¹, HAH. Albitar¹, V. Ahluwalia¹, S. Hoskote¹, D. Schroeder², D. Hurtado³, J. Winters⁴, V. Simha³, V. Iyer¹

¹Pulmonary and Critical Care Medicine, Mayo Clinic, Rochester, United States of America; ²Department of Clinical Trials and Biostatistics, Mayo Clinic, Rochester, United States of America; ³Endocrinology Diabetes

and Metabolism, Mayo Clinic, Rochester, United States of America;
⁴Laboratory Medicine and Pathology, Mayo Clinic, Rochester, United States of America

Correspondence: V. Iyer
Intensive Care Medicine Experimental 2023, **11(Suppl 1)**:000925

Introduction: Background: Hypertriglyceridemic pancreatitis (HTGP) is a rare entity with significant morbidity and mortality. It is thought that high triglyceride levels are directly toxic to the pancreas and management typically involves efforts at rapid lowering of serum triglycerides (TG). Both plasmapheresis (PL) and intravenous (IV) insulin infusions are often used [Clin 40635_2023_546] for this purpose but have not been compared or studied in large cohorts. Furthermore, the role of IV insulin in patients with HTGP without concurrent diabetes remains unclear. We aimed to investigate these questions in a cohort of patients hospitalized for HTGP at a tertiary care center over a 20-year period.

Methods: A retrospective chart review of patients hospitalized for acute HTGP between January 1, 2002, and December 31, 2022, was performed. Patients were stratified into 4 groups according to treatment modality received: intravenous (IV) insulin infusion alone; plasmapheresis alone; IV insulin followed by plasmapheresis and conservative management. Efficacy of these modalities in lowering serum triglycerides, development of pancreatitis and other organ complications as well as hospital LOS (length of stay), ICU admissions, ICU LOS and mortality were compared between the groups.

Results: A total of 136 patients hospitalized with hypertriglyceridemic pancreatitis (HTGP) were identified over this 20-year time period from Jan 2002 to Dec 2022 with a mean age of 49 (range 21–79) years with 67% being male. Diabetes was noted in 102 (75%) of patients, current alcohol use in 15 (11%), coronary artery disease in 11 (8%) and chronic kidney disease in 8 (6%) of patients. Three patients (6.7% of females) were pregnant at the time of HTGP admission. Mean hospital length of stay (LOS) was 7.8 (range 1–103) days. ICU admission occurred in 38% of the patients with HTGP with a mean ICU LOS of 6 (range 1–43) days. Treatments included either insulin alone (n=90, 66%), conservative treatment methods (n=30, 22%), insulin followed by plasmapheresis (n=12, 9%) and plasmapheresis alone (n=3, 2%). A total of 15/34 (44%) of the non-diabetic patients were treated with IV insulin and 2/34 (6%) were treated with insulin followed by plasmapheresis. Median presenting triglyceride level was 3810 mg/dl (range 1157 to 24,712 mg/dl). Multiple sessions of plasmapheresis were utilized in 2 patients with the other 13 patients undergoing a single session of plasmapheresis. We observed 0% mortality during the admission for HTGP. Pancreatic necrosis was noted in 14 patients (10.3%) and peri-pancreatic fluid collections in 27 (20%). Renal replacement therapy (dialysis) was needed in 11 (8%) and end stage renal disease (ESRD) developed in 7 (5%) of patients. Repeat admissions for HTGP occurred in 31% of patients post index admission for HTGP.

Conclusions: HTGP is a serious condition occurring mostly in males (67% of our cohort) and in those with pre-existing diabetes (75% of the cohort). The majority of patients were treated with IV insulin alone (66%) and this included 44% of non-diabetics who were also treated with IV insulin. About 12% of patients were treated with plasmapheresis. No patient died during the index HTGP admission. However, about 38% of patients required ICU admission with 10% developing pancreatic necrosis, 8% requiring dialysis and 5% developing end stage renal disease (ESRD).

Topic: Metabolism, endocrinology, liver failure and nutrition

000927

Evaluating the response to fluid administration in septic shock: a metabolic cluster analysis

E. Prieto¹, F. Oller¹, C. Espinal¹, E. Cortés¹, A. Gil¹, A. Caballer¹, S. Nogales¹, G. Gruartmoner¹, J. Mesquida¹

¹Àrea de crítics, Parc Taulí Hospital Universitari. Institut d'Investigació i Innovació Parc Taulí (I3PT), Sabadell, Spain

Correspondence: E. Prieto
Intensive Care Medicine Experimental 2023, **11(Suppl 1)**:000927

Introduction: The process of resuscitation in septic shock hinges on the detection of tissue hypoxia, and the subsequent performance of interventions aimed at increasing cardiac output to reverse it. However, there is still an open debate on the choice of the parameter(s) that inform us of tissue hypoxia. The latest Surviving Sepsis Campaign (SSC) guidelines recommend only the use of lactate as a metabolic guide to resuscitation, ignoring the fact that in situations of dysoxia, with defects in oxygen utilization, lactate can be elevated without being due to insufficient cardiac output. Therefore, in these situations, the hemodynamic interventions that would result would not be linked to a benefit for the patient, but rather to the deleterious effects of positive fluid balance.

The present study aims to analyse the value of the integration of different metabolic markers in the evaluation of the response to volume administration in the process of hemodynamic resuscitation of patients in septic shock.

Methods: Retrospective observational study, in a 30-bed general ICU. Adult patients with septic shock in the first 24 h of admission, with a cardiac output monitoring system, and in whom their medical team indicated volume loading (intervention) due to suspected persistent tissue hypoperfusion were included. Hemodynamic and metabolic variables [lactate, central venous saturation (SvCO₂), veno-arterial CO₂ difference (PcvaCO₂) and estimated respiratory quotient (PcvaCO₂/CavO₂)] were collected pre-intervention and at the end of the intervention. A two-stage cluster analysis was performed to group patients according to a metabolic profile, including the pre-intervention metabolic variables. Comparative analysis was performed on the evolution of cardiac output and metabolic parameters, as well as Pearson correlations of the changes in these variables, as a function of the metabolic cluster.

Results: A total of 77 interventions were studied in 55 patients. 62% were male, with a mean age of 62 ± 16 years, baseline lactate was 50 ± 40 mg/dl, 96% required noradrenaline perfusion, and 91% were receiving mechanical ventilation. The reason for volume loading was persistently high lactate (81%) and/or the presence of low SvCO₂ values (42%). The best cluster model was obtained with the inclusion of SvCO₂, PcvaCO₂ and PcvaCO₂/CavO₂, classifying patients into two profiles, and with SvCO₂ as the variable with the greatest weight in the model. Cluster 1 presented lower SvCO₂ values (61 ± 6 vs 77 ± 5%, p < 0.001), higher PcvaCO₂ (8 ± 2 vs 6.2 ± 2.2 mmHg, p < 0.001) and lower PcvaCO₂/CavO₂ (1.5 ± 0.4 vs 2.2 ± 0.7, p < 0.001), with no differences in lactate values. When the response to volume administration was analysed, 65% of patients increased their cardiac output value (75% of cluster 1 and 60% of cluster 2, p ns). Increase in cardiac output was only associated with decrease in lactate in cluster 1 patients (r 0.4, p 0.04; Figure 1). No isolated pre-intervention metabolic variable was associated with lactate evolution.

Conclusions: The integration of the different metabolic variables improves the detection of situations of tissue hypoxia and, therefore, the capacity to detect those patients who may benefit from receiving interventions that increase cardiac output. The use of lactate as the only metabolic marker, although currently recommended by the SSC, could be clearly insufficient, and even misleading, in decision making in the process of resuscitation in septic shock.

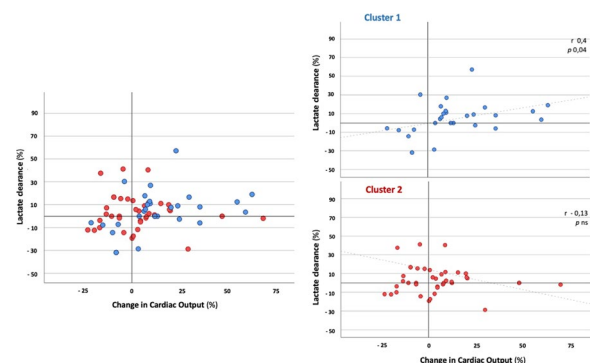

Figure 1

References

- [1] Evans L, Rhodes A, Alhazzani W, Antonelli M, Coopersmith CM, French C, et al. Surviving sepsis campaign: international guidelines for management of sepsis and septic shock 2021. *Intensive Care Med* 2021; 47(11):1181–1247.
- [2] Mesquida J. Non-invasive tools for guiding hemodynamic resuscitation in septic shock: the perfusion vs metabolic issue. *J Clin Monit Comput* 2021;35(3):431–433.

Topic: Cardiovascular issues in ICU

000932

Do SpO2 discrepancies related to oximeter’s brand and skin pigmentation cause ARDS misclassification with SpO2/FiO2 ?

A. Delobel¹, M. A. Blanchet¹, P. A. Bouchard¹, F. Lellouche¹
¹Centre de recherche, Institut Universitaire de Cardiologie et de Pneumologie de Québec-Université Laval, Québec, Canada

Correspondence: F. Lellouche

Intensive Care Medicine Experimental 2023, **11(Suppl 1)**:000932

Introduction: SpO2/FiO2 may be used for ARDS classification¹. It is known that skin pigmentation may induce bias in SpO2- SaO2 bias, and it was recently showed that oximeter brand influences the SpO2 measurements².

Objectives: To evaluate the impact of the SpO2 bias on ARDS misclassification when using SpO2/FiO2.

Methods: We performed a retrospective analysis of the OXYGAP study² using 211 pairs of SpO2 values with Nonin-OEM and Philips-FAST pulse oximeters and related PaO2. We compared the classification provided by PaO2/FiO2 and SpO2/FiO2 with Nonin and Philips. The usual PaO2/FiO2 thresholds were used (300-200-100) and thresholds based on Rice’s equation were used for SpO2/FiO2 (315-235-150). A theoretical set of SpO2/FiO2 values were obtained with SaO2 values going from 88 to 96% and FiO2 going from 25 to 80% with steps of 5%, for Nonin and Philips oximeters (SpO2 bias of -3 and +1%), and for light and dark skinned (SpO2 bias 0 and +3%).

ARDS classifications were compared within the different conditions.

Results: FiO2 were available in patients on invasive mechanical ventilation (n=22), high flow nasal canula (n=15), in patients without respiratory support (n=84, FiO2=21%), or in patients under conventional oxygen therapy (estimated FiO2 based on oxygen flow, n=83). SpO2 were missing for one of the evaluated oximeters in 7 patients. Classification of ARDS based on the different pulse oximeters did not differ much (differences below 3% between groups, Figure), however there were differences in comparison with PaO2/estimated FiO2 and SpO2/FiO2 classifications. In the theoretical set of values, 108 SpO2/FiO2 values were obtained for several conditions (Nonin and Philips oximeters, light and dark skin). ARDS misclassifications were below 5% for Nonin vs. Philips and light vs. dark skin pigmentation. With Nonin and Philips oximeters the classification as No, mild, moderate and severe ARDS were 8, 17, 37, 38% and 11, 17, 38, 34% respectively. With light and dark skin pigmentation, the classification as No, mild, moderate and severe ARDS were 10, 17, 37, 36% and 13, 17, 39, 31% respectively.

ARDS classifications were compared within the different conditions.

Table (abstract 000932) ARDS classification based on theoretical 432 values of SpO2/FiO2 with Nonin, Philips pulse oximeters and with light and dark skin pigmentation

	Nonin	Philips	Light Skin	Dark Skin
No ARDS	8%	11%	10%	13%
Mild	17%	17%	17%	17%
Moderate	37%	38%	37%	39%
Severe	38%	34%	36%	31%

Conclusions: Utilization of SpO2/FiO2 to classify the severity of ARDS is feasible with low number of misclassifications when comparing SpO2/FiO2 with different pulse oximeters or with discrepancies related to skin pigmentation. In the cohort of patients, classifications differed when comparing PaO2/estimated FiO2 and SpO2/estimated FiO2 for No ARDS and mild ARDS categories.

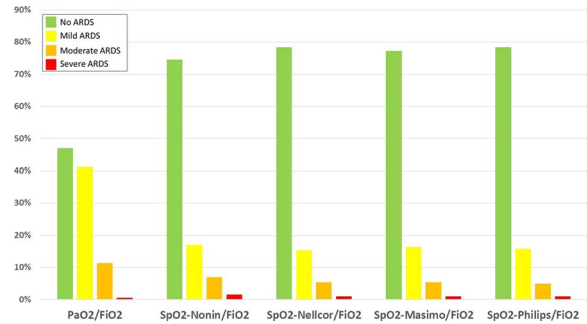

Figure (abstract 000932) ARDS classification based on PaO2/estimated FiO2 or SpO2/estimated FiO2 with different pulse oximeters (Nonin, Nellcor, Masimo, Philips) in the secondary analysis of the Oxygap study and 211 pairs of SpO2 with four pulse oximeters and PaO2

References

1. Wick KD, Matthay MA, Ware LB. Pulse oximetry for the diagnosis and management of acute respiratory distress syndrome. *Lancet Respir Med* 2022; 10(11): 1086–98.
2. Blanchet MA, Mercier G, Delobel A, et al. Accuracy of multiple pulse oximeter brands in stable critically ill patients—Oxygap study. *Respiratory care* 2023.
- Conflicts of Interest: FL is co-inventor of FreeO2 and co-founder of OxyNov. No Grant was provided for the study.

Topic: Acute respiratory failure and mechanical ventilation

000933

Evaluation of the impact of gas humidity on expiratory filtration during invasive mechanical ventilation

V. Brochu¹, M. Veillette¹, N. Turgeon¹, P. A. Bouchard², F. Lellouche², C. Duchaine¹

¹Microbiology, Biochemistry and Bioinformatics, Laval University, Québec, Canada; ²Medecine, Laval University, Québec, Canada

Correspondence: V. Brochu

Intensive Care Medicine Experimental 2023, **11(Suppl 1)**:000933

Introduction: Devices allowing efficient expiratory filtration are required to avoid contamination of the air in ICU rooms of patients under invasive mechanical ventilation. Usual filtration tests are conducted for large particles (3000 nm), while smaller particles may carry several viruses. SARS-CoV-2 virus size is about 100 nm and may be carried with particles of any size, including particles smaller than 1000 nm. The impact of gas humidity to evaluate the filtration efficiency for different particle size is unknown.

Methods: On a test bench simulating dispersion of aerosols with particles ranging from 29 to 5000 nm, we evaluated the filtration efficiency of several devices: an HMEF (heat and moisture exchanger filter) and an HEPA filter (High-Efficiency Particulate Absorbing filter): DAR Hygrobac S (352–5877) and Draeger Twinstar HEPA (MP01801). Filters were placed one at the time in the test bench. Aerosols were generated from a buffer suspension containing two model viruses: φX174 and MS2. Viral aerosols passed through the filter at an air flow rate of 60L/min, with experiments conducted with dry and humid air. Particle counters and air samplers were placed upwind and downwind of the filter. The absolute humidity of dry and humid

gases were respectively approximately 7 and 30 mgH₂O/L. Particles were counted and infectious viruses were quantified upwind and downwind to calculate the filtration efficiency for both particles and viruses. The maximal filtration efficiency sensitivity in this test bench is 99.99%.

Results: Main preliminary results are shown on the figure. For HMEF, the filtration efficiency is reduced for small particles below 1000 nm. With dry gases, filtration is reduced for particles below 1000 nm, while with humid gases, filtration is reduced for particles below 500 nm. For particles of 300 nm, filtration efficiency is below 95%. The filtration efficiency is significantly higher with HEPA filter in comparison with HMEF. The HEPA filter filtration was 99.99%/99.99% with dry air and humid air, while the HMEF filtration was 99.09%/98.87% with dry air and 99.48%/99.56% with humid air for PhiX174 and MS2 respectively.

Conclusions: Gas humidity has an impact on filtration efficiency. Particles under 300 nm are not entirely filtered with the tested HMEF. However, the infectious viruses are present in smaller quantities reflecting that many unfiltered particles do not contain viruses. However, with HMEF, the filtration efficiency based on cultivable viruses do not attain expected results (above 99.999%). The clinical impact of this reduced filtration is unknown.

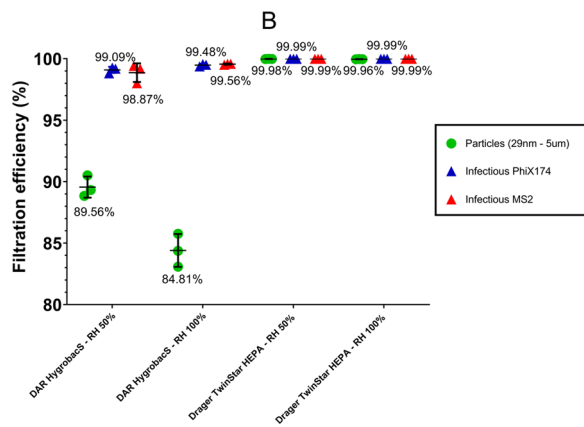

Figure B (abstract 000933) Shows the filtration efficiency for infectious viruses and for particles ranging from 29 to 5000nm. Filtration efficiency means are shown for each triplicate

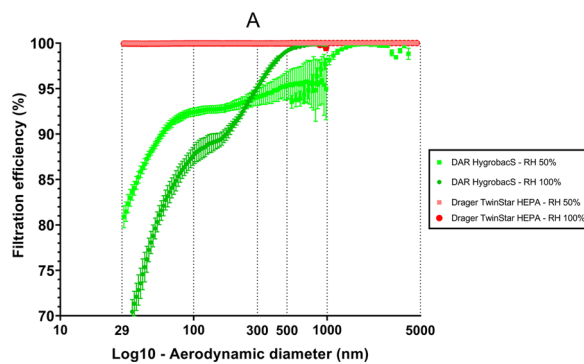

Figure A (abstract 000933) Shows the filtration efficiency regarding the size distribution of particles at different relative humidity. This graph shows particles only

Topic: Acute respiratory failure and mechanical ventilation

000934

Interobserver agreement between chest X-ray and computed tomography scan for acute respiratory distress syndrome diagnosis

M. Joos¹, G. Herpe², J. P. Frat¹, F. Arrivé¹, A. Veinstein¹, D. Chatellier¹, F. Boissier¹, S. Le Pape¹, C. Villaret², A. Thille¹, R. Coudroy¹

¹Service de Médecine Intensive Réanimation, Centre Hospitalier Universitaire de Poitiers, Poitiers, France; ²Service de Radiologie, Centre Hospitalier Universitaire de Poitiers, Poitiers, France

Correspondence: M. Joos

Intensive Care Medicine Experimental 2023, 11(Suppl 1):000934

Introduction: According to the Berlin definition of acute respiratory distress syndrome (ARDS), bilateral infiltrates can be diagnosed using chest X-ray or computed tomography (CT)-scan. However, the inter-individual agreement for the diagnostic of lung infiltrates on chest X-ray is poor and may explain the low rate of ARDS recognition by clinicians. Indeed, as compared to CT-scan, the accuracy of chest X-ray interpreted by a radiologist to identify ARDS was limited. However in daily practice, chest X-rays are interpreted at the bedside by intensivists, not radiologists. We hypothesized that the agreement between chest X-ray interpreted by intensivists and CT-scan interpreted by a radiologist, as reference standard for ARDS diagnosis, was poor.

Methods: From January 2015 to December 2021, we included all CT-scan performed in patients invasively ventilated with PaO₂/FiO₂ ratio ≤ 300 mmHg with positive end-expiratory pressure ≥ 5 cmH₂O on the day of the CT-scan and a chest X-ray performed within the 24 h around the CT-scan. Patients whom hypoxemia was related to cardiogenic pulmonary edema were excluded. CT-scans and chest X-rays were interpreted semi-quantitatively by a senior radiologist and by two senior intensivists (with > 20 years and < 10 years of experience), respectively. The primary outcome was the agreement between chest X-ray and CT-scan for ARDS diagnosis using Cohen's kappa. Secondary outcomes were the sensitivity of chest X-ray for ARDS diagnosis in the overall population, and in the subgroup of focal ARDS, defined as infiltrates in the lower lobes on CT-scan.

Results: Among the 1015 CT-scan performed during the study period, 332 were included in the analysis. Mean age of patients was 62, 74% were males, and 29% were immunocompromised. In-ICU mortality was 41%. CT-scans were performed 3 [1–11] days from intubation. The day of the CT-scan, mean PaO₂/FiO₂ ratio was 165 mmHg. The prevalence of ARDS on CT-scan was 82%. Consolidations were mostly found in inferior lobes whereas ground glass was found evenly in all lobes. The agreement between chest X-ray and CT-scan for ARDS diagnosis was moderate (Cohen's kappa 0.41 [95% confidence interval 0.30–0.51]) with the most experienced intensivist and was fair with the less experienced one (Cohen's kappa 0.29 [95% confidence interval 0.18–0.41]). Sensitivity of chest X-ray for ARDS diagnosis in the overall population was 77% (95%CI 71–82) and 80% (95%CI 75–84) according to each intensivist. In the subgroup of focal ARDS, it was 54% (95%CI 40–67) and 67% (95%CI 53–79), respectively.

Conclusions: Chest X-ray interpreted by intensivists and CT-scan interpreted by a radiologist had fair to moderate agreement for ARDS diagnosis. The performance of chest X-ray was particularly poor in focal ARDS. Systematic CT-scan assessment in hypoxemic patients may improve the likelihood of ARDS diagnosis.

Topic: Acute respiratory failure and mechanical ventilation

000937

The impact of socioeconomic status in predicting in-hospital mortality in patients with acute-on-chronic liver failureP. Keen¹, T. Dixon¹, L. White¹, P. Bassett², S. Ghabina¹, A. Walecka¹, R. Jalan³, B. Agarwal¹, G. Mehta³¹Intensive Care, Royal Free Hospital, London, United Kingdom; ²Statistical Analysis, Statsconsultancy LTD, London, United Kingdom; ³Hepatology, Royal Free Hospital, London, United Kingdom**Correspondence:** P. Keen

Intensive Care Medicine Experimental 2023, 11(Suppl 1):000937

Introduction: Acute-on-chronic liver failure (ACLF) is a critical syndrome occurring in individuals with acutely decompensated cirrhosis, characterised by high short-term mortality and multiorgan failure. Accurate prognostic scores are essential to support ICU treatment and outcomes. Socioeconomic status (SES) is a known, independent contributor to ill health and mortality. This study aims to determine if incorporating SES into the CLIF-C ACLF score, a prognostic tool for ACLF outcomes, adds value in predicting in-hospital mortality in patients with ACLF.

Methods: Data from consecutive patients admitted to the Royal Free London ICU with a complication of cirrhosis, between 2016 and 2017, were obtained from the Royal Free NHS Trust database. CLIF-C ACLF scores were calculated at day 0 and 2 of ICU admission and in-hospital survival was assessed. SES was determined using the English Indices of Deprivation, a validated government tool that utilises individual post-codes to infer a deprivation decile. A higher decile indicates a higher SES and vice versa. Multiple logistic regression was used to examine the joint association between both CLIF-C ACLF and SES upon in-hospital mortality.

Table 1 (abstract 000937) Multiple analyses comparing in-hospital mortality groups

	In-Hospital Mortality				Test used	p-value
	Dead		Alive			
	n	Mean ± SD	n	Mean ± SD		
Age	48	55.8 ± 12.3	83	53.3 ± 15.0	Independent T-Test	0.317
Deprivation Decile	48	4.54 ± 2.90	83	5.30 ± 2.57	Mann-Whitney U Test	0.054
CLIF-C ACLF D0	48	59.9 ± 11.2	83	50.1 ± 9.74	Independent T-Test	<0.001
CLIF-C ACLF D2	32	64.9 ± 10.2	55	50.5 ± 11.3	Independent T-Test	<0.001
Delta (D0 to 2)	32	0.125 ± 9.36	55	-2.49 ± 7.61	Independent T-Test	0.163
	n	Male/ Female	n	Male/ Female	Test used	p-value
Sex	48	27/21	83	54/29	Chi-Squared Test	0.317

Table 2 (abstract 000937) Effect of adding SES to CLIF-C ACLF score on in-hospital mortality prediction at days 0 and 2 of ICU admission: results of binary logistic regression analysis

Day	n	p-value	Odds Ratio	95% CI
0	131	0.048	0.847	(0.718 to 0.999)
2	87	0.041	0.821	(0.664 to 0.992)

Results: The cohort comprised of 851 patients, of which 131 patients have been analysed thus far. There is no significant difference in age or sex between mortality groups (Table 1). SES proved a statistically significant improvement to the CLIF-C ACLF score in predicting in-hospital mortality at day 0 and 2 of ICU admission (Table 2). To add, the odds ratios demonstrate a significant inverse relationship between SES and in-hospital mortality.

Conclusions: Our findings suggest SES can add predictive value to the CLIF-C ACLF score with regards to in-patient mortality, allowing acute care clinicians to more accurately risk stratify patients in ICU. These findings may also have implications for public health strategies for targeting primary and secondary prevention schemes. Validation in larger cohorts is justified.

References

- Engelmann, C., Thomsen, K.L., Zakeri, N., Sheikh, M., Agarwal, B., Jalan, R. and Mookerjee, R.P. (2018). Validation of CLIF-C ACLF score to define a threshold for futility of intensive care support for patients with acute-on-chronic liver failure. *Critical Care*, 22(1). doi: <https://doi.org/10.1186/s13054-018-2156-0>.
- Moreau, R., Jalan, R., Gines, P., Pavesi, M., Angeli, P., Cordoba, J., Durand, F., Gustot, T., Saliba, F., Domenicali, M., Gerbes, A., Wendon, J., Alessandria, C., Laleman, W., Zeuzem, S., Trebicka, J., Bernardi, M. and Arroyo, V. (2013). Acute-on-Chronic Liver Failure Is a Distinct Syndrome That Develops in Patients With Acute Decompensation of Cirrhosis. *Gastroenterology*, 144(7), pp.1426–1437.e9. doi: <https://doi.org/10.1053/j.gastro.2013.02.042>.
- Hernaes, R., Solà, E., Moreau, R. and Ginès, P. (2017). Acute-on-chronic liver failure: an update. *Gut*, [online] 66(3), pp.541–553. doi: <https://doi.org/10.1136/gutjnl-2016-312670>.

Topic: Metabolism, endocrinology, liver failure and nutrition

000938

Effectiveness of Lung Ultrasound training in intensive care unit staff (TRAINER). A prospective multicenter observational cohort studyA. Mousa¹, C. Plantinga², S. G. Blok³, S. Den Boer⁴, L. A. E. Cox⁵, H.Scholten⁶, J. Weenink⁴, L. Heunks⁷, M. Schultz⁸, F. Paulus⁹; P. R. Tuinman²¹Intensive Care Medicine, Amsterdam UMC, Locatie VUmc, Amsterdam,Netherlands; ²Intensive Care, Amsterdam UMC, locatie VUmc,Amsterdam, Netherlands; ³Department of Intensive Care, AmsterdamUMC, locatie AMC, Amsterdam, Netherlands; ⁴Intensive Care, SpaarneGasthuis Haarlem Zuid, Haarlem, Netherlands; ⁵Intensive Care, ADRZAdmiral de Ruyter Medical Center, Goes, Netherlands; ⁶Intensive Care,Catharina Ziekenhuis, Eindhoven, Netherlands; ⁷Intensive Care, ErasmusUniversity Medical Center, Rotterdam, Netherlands; ⁸Intensive care,

Amsterdam University Medical Centers, University of Amsterdam,

Amsterdam, Netherlands; ⁹Intensive Care, Amsterdam UMC, locatie AMC,

Amsterdam, Netherlands

Correspondence: A. Mousa

Intensive Care Medicine Experimental 2023, 11(Suppl 1):000938

Introduction: Lung ultrasound (LUS) has become an essential skill in critical care as part of point of care ultrasonography (1). LUS may be perceived as to require significantly less training compared to more advanced ultrasound (1,2). However, the quality of the acquired image is operator dependent and subjective to interpretive error. Therefore, adequate education and training is indispensable for effective clinical use. As of yet, few studies have been published that specifically study the training effectiveness for interpreting LUS images.

Objectives: The aim of this study was to study the effectiveness of a two-hour training program to learn and understand the basics of LUS. We hypothesized that 80% of the subjects will be able correctly identify 80% of LUS images after a two-hour training program.

Methods: A prospective observational cohort study of intensive care unit (ICU) physicians, both intensivists and residents, and medical students, from different hospitals in the Netherlands. Subjects participated voluntarily. Subjects received a two-hour training program. A test was performed where subjects were asked to correctly interpret

fifteen LUS images with five multiple choice options (A-, B1-, B2- and C-profile and pleural effusion). The test was taken before and after the two-hour training to correct for prior knowledge. Primary outcome was defined as the percentage of subjects who scored 80% or higher in the posttest score. In addition, the learning curve of subjects defined as the increase of percentage points between pre- and posttest was assessed. Lastly, the performance between subjects with and without prior ultrasound knowledge before the start of the training program was assessed. The data of both pre- and posttest was nonparametric. The difference between pre- and posttest was assessed with the Wilcoxon signed-rank test.

Results: Forty-seven subjects were included from four different hospitals. Sixteen subjects were certified in lung ultrasonography, seven subjects had prior experience without any training or certifications and twenty-four subjects did not have any prior experience with LUS. After training 46.8% of the subjects had a score of 80% or higher. Mean pretest score was 47.7 ± 18.5 . Mean posttest score was 74.8 ± 15.3 , Figure 1. There was a significant difference between pretest and posttest score ($p < 0.0001$). The subjects with prior knowledge performed significantly better at the pretest ($p = 0.01$), but scored equally at the posttest compared to the subjects without prior knowledge.

Conclusions: This study shows that after a two-hour training program around 50% of intensivists, ICU residents and medical students reach competence in interpreting LUS images. The hypothesized 80% of subjects who should be able to correctly interpret 80% of LUS images was not reached with the two-hour training program.

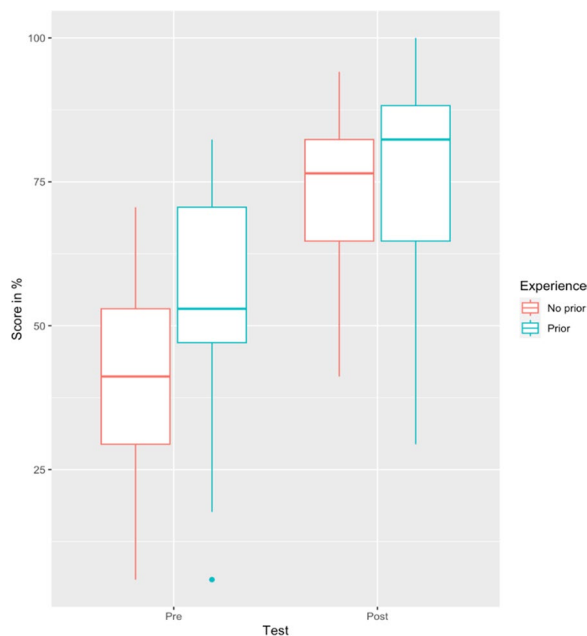

Boxplots of performance (Score in %) on pretest (left) and posttest (right) of subjects without (red) and with (blue) prior knowledge

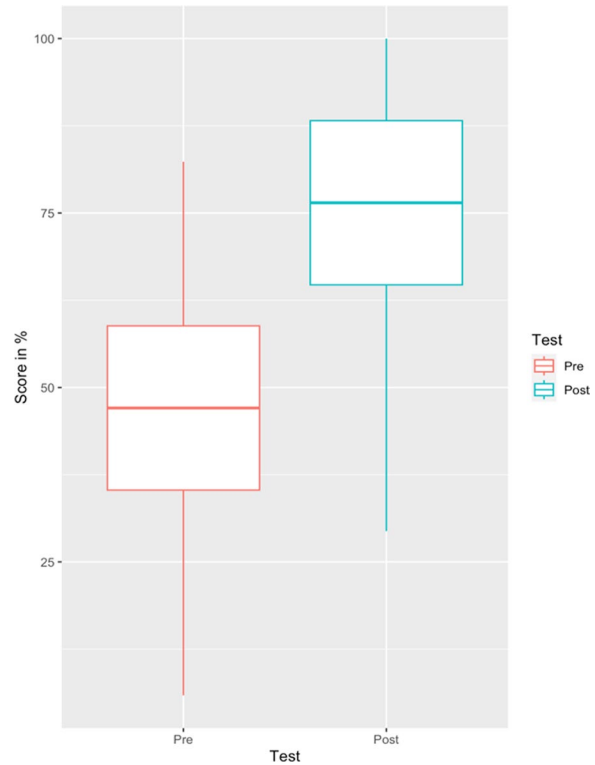

Boxplots of performance (Score in %) on pretest (left) and posttest (right) scores (i.e. before and after the two hour training program).

References

2. Kraaijenbrink BVC, Mousa A, Bos LD, Paulus F, Tuinman PR. Defining basic (lung) ultrasound skills: not so basic after all? *Intensive Care Med.* 2022 May;48(5):628–629. doi: <https://doi.org/10.1007/s00134-022-06666-5>. Epub 2022 Mar 30. PMID: 35355097.
1. Robba C, Wong A, Poole D, Al Tayar A, Arntfield RT, Chew MS, Corradi F, Douflé G, Goffi A, Lamperti M, Mayo P, Messina A, Mongodi S, Narasimhan M, Puppo C, Sarwal A, Slama M, Taccone FS, Vignon P, Vieillard-Baron A; European Society of Intensive Care Medicine task force for critical care ultrasonography*. Basic ultrasound head-to-toe skills for intensivists in the general and neuro intensive care unit population: consensus and expert recommendations of the European Society of Intensive Care Medicine. *Intensive Care Med.* 2021 Dec;47(12):1347–1367. doi: <https://doi.org/10.1007/s00134-021-06486-z>. Epub 2021 Oct 5. PMID: 34787687; PMCID: PMC8596353

Topic: Acute respiratory failure and mechanical ventilation

000940

Implementation of standardised transfer checklists and protocols in a UK District General Hospital

I. Griffiths¹, J. Cadman¹, J. Macallan², J. Chittenden², A. Myers³, T. Samuels⁴
¹Anaesthesia, East Surrey Hospital, Redhill, United Kingdom; ²Critical Care, East Surrey Hospital, Redhill, United Kingdom; ³Icu, East Surrey Hospital, Redhill, United Kingdom; ⁴Critical care, East Surrey Hospital, Redhill, United Kingdom

Correspondence: I. Griffiths
Intensive Care Medicine Experimental 2023, 11(Suppl 1):000940

Introduction: At least 10,000 patients undergo critical care inter-hospital transfer per year in the UK.1 Both inter- and intra-hospital transfers of these patients are associated with risk. Complications are reported during two thirds of intra-hospital transfers.2 One third of inter-hospital transfer complications result in adverse outcomes.3 Training and careful planning are essential to ensure high levels of patient safety. The Association of Anaesthetists of Great Britain and Ireland (AAGBI) suggests training should include attendance at a transfer course.4 The AAGBI and Intensive Care Society (ICS) suggest that transfers should be standardised across networks.1,4 NICE UK recommend the use of standardised protocols, training, equipment, and checklists.5

Objectives: To assess standardisation of training, checklists and protocols for clinical teams involved in providing transfers for critically ill patients in our UK district general hospital.

Methods: Clinical staff involved in critical care transfers were interviewed regarding their training and familiarity with protocols for the transfer of critically unwell patients. Quantitative and qualitative analysis of the survey was performed. Problems were identified using Ishikawa analysis. Aims, objectives and outcome measures outlined. A 'Plan-Do-Study-Act' (PDSA) cycle was subsequently developed.

Results: Analysis from 66 respondents (22 (33%) doctors, 44 (67%) nurses) demonstrated the following (Table 1):

	Yes	No
Attended transfer course	63 (96%)	3 (4%)
Attended transfer course within last 5 years	43 (68%)	20 (32%)
Felt a refresher course would be useful	35 (55%)	29 (45%)
Facilitated a transfer within last 3 months	42 (65%)	23 (35%)
Used a checklist prior to transfer	45 (73%)	17 (27%)
Felt a checklist would be useful	65 (99%)	1 (1%)
Aware of a checklist for transfer within this hospital	58 (88%)	8 (12%)

Table 1

Results also suggest that a checklist should be available in multiple formats. Qualitative analysis of results suggests a need for additional training sessions on transfers, easily accessible and concise checklists using various modalities, and a separate MRI checklist.

Conclusions: This survey reveals that despite clear national guidance, there remains a lack of standardisation in training and protocol use for the transfer of critically unwell patients in our hospital. Our study highlights the need to ensure that staff have up to date transfer training and checklists available. Since many staff rotate through working in critical care, training must be repeated regularly and protocols must be easily accessible to all. The next phase of this study is to carry out PDSA cycle 1 and implement widespread use of checklists for all transfers, with laminated checklists available in transfer kits. Further cycles will be carried out to ensure implementation of these checklists, with the aim of improved patient safety during transfers.

References

1. Intensive Care Society and Faculty of Intensive Care Medicine (2019). Guidance on: the transfer of the critically unwell patient.
2. Lovell, M.A., Mudaliar, M.Y. and Klineberg, P.L. (2001) "Intrahospital transport of critically ill patients: Complications and difficulties," *Anaesthesia and Intensive Care*, 29(4), pp. 400–405.

3. Beckmann, U., Gillies, D.M., Berenholtz, S.M., Wu, A.W. and Pronovost, P. (2004) "Incidents relating to the intra-hospital transfer of critically ill patients," *Intensive Care Medicine*, 30(8), pp. 1579–1585.
4. The Association of Anaesthetists of Great Britain and Ireland (2009). Interhospital transfer.
5. National Institute for Health and Care Excellence (2018). Standardised systems of care for intra- and inter-hospital transfers. Emergency and acute medical care in over 16 s: service delivery and organisation. NICE guideline 94.

Topic: Critical care organisation, quality management, information systems, outcomes

000941

An audit into compliance with lung protective ventilation strategies in a UK District General Hospital

J. Barry¹, J. Mooney¹, M. Aslam²
¹Foundation doctor, George Eliot Hospital, Nuneaton, United Kingdom; ²ITU, George Eliot Hospital, Nuneaton, United Kingdom

Correspondence: J. Barry
Intensive Care Medicine Experimental 2023, 11(Suppl 1):000941

Introduction: Ventilator-induced lung injury (VILI) is a complication of mechanical ventilation that can cause acute lung injury due to volutrauma, barotrauma, and harmful inflammatory processes (1). Protective lung ventilation (PLV), involves giving low tidal volumes (6-8 ml/kg) to patients and is a recommended strategy to help prevent VILI, especially in the context of acute respiratory distress syndrome (ARDS) & COVID-19 (2,3). It is therefore the standard of care that patients should receive PLV in Intensive Care Units (ICU).

Objectives: This retrospective study evaluated the compliance with PLV, as a standard of care, in George Eliot Hospital's ICU in Nuneaton, UK from November 2022 to January 2023. Patient data was analysed to determine if there were complications of mechanical ventilation during or after their ITU stay, and whether there is any association between the incidence of these complications, and the administration of PLV.

Methods: Data was collated for 30 patients who received mechanical ventilation during the aforementioned timeframe, analysing the daily range of tidal volumes they received, and assessing the incidence and severity of complications following extubation and further care. Patients were considered to be on PLV for a given day, if the range of tidal volumes was within the PLV parameters for their ideal body weight. PLV was defined as 6-8 ml/kg of ideal body weight.

Results: 54% of the patients received tidal volumes within PLV boundaries on at least one day during their time spent on mechanical ventilation. Of the patients that received PLV, 16% received PLV for over half the time they were mechanically ventilated. Complications were seen in patients who both did and did not receive PLV, and included acute kidney injury, cardiomyopathy, pleural effusion, and delirium, both during and after admission to ICU.

Of the patients that did not receive PLV, 60% of them had chest x-rays in the days following extubation, each of which showed new pathology, including atelectatic changes, bibasal collapse, consolidation, air-space shadowing, and effusion. Of the patients who received PLV, 67% had chest x-rays in the days following extubation, all of which demonstrated new pathology.

Of the patients that didn't receive PLV, 40% were discharged, 40% are still current inpatients, or have been transferred to different hospitals, and 20% are deceased. Of the patients that did receive PLV, on at least one day during the time they were receiving mechanical ventilation, 67% have been discharged, 16.5% are still inpatients or have been transferred to another hospital, and 16.5% are deceased.

Conclusions: Our findings show that most patients received tidal volumes outside the recommended range for PLV, potentially leading to adverse outcomes including lung volume loss, acute kidney injury, cardiomyopathy, and pleural effusion, both during and after admission. These results highlight the importance of adhering to PLV strategies to reduce the risk of VILI and associated complications.

References

1. Katira B. H. (2019). Ventilator-Induced Lung Injury: Classic and Novel Concepts. *Respiratory care*, 64(6), 629–637. doi: <https://doi.org/10.4187/respcare.07055>
2. Acute Respiratory Distress Syndrome Network, Brower, R. G., Matthay, M. A., Morris, A., Schoenfeld, D., Thompson, B. T., & Wheeler, A. (2000). Ventilation with lower tidal volumes as compared with traditional tidal volumes for acute lung injury and the acute respiratory distress syndrome. *The New England journal of medicine*, 342(18), 1301–1308
3. Mega, C., Cavalli, I., Ranieri, V. M., & Tonetti, T. (2022). Protective ventilation in patients with acute respiratory distress syndrome related to COVID-19: always, sometimes or never?. *Current opinion in critical care*, 28(1), 51–56.

Topic: Acute respiratory failure and mechanical ventilation.

000942

Evaluation of expiratory humidity with different heated humidifiers circuits

F. Lellouche¹, P. A. Bouchard²

¹Research Center, University Institute of Cardiology and Respiriology of Quebec, Québec, Canada; ²Centre de Recherche, Institut Universitaire de Cardiologie et de Pneumologie de Québec-Université Laval, Québec, Canada

Correspondence: F. Lellouche.

Intensive Care Medicine Experimental 2023, **11(Suppl 1)**:000942

Introduction: The optimisation of the inspiratory and expiratory circuits used with heated humidification is necessary to avoid condensation and related problems, such as auto-triggering, difficulties to trigger the ventilator, or increase in expiratory resistances¹.

Objectives: The objective of the study was to compare humidity in several expiratory circuits of different heated wire humidifiers.

Methods: On a bench model simulating humidified expired gas (absolute humidity of 35 mgH₂O/L), we have measured hygrometry of expiratory gases at proximal side (corresponding to the Y-piece), and distal side (ventilator inlet) of expiratory circuits. The circuit evaluated were Inspired ref. 51005683 (Vincent medical), FP950 (ref:950A81J, Fisher&Paykel), MR850 (RT210, F&P) and Evaqua2 (RT380, F&P), at different room temperatures (22–24 °C and 28–30 °C).

The ventilator settings were Assist Control, tidal volume 400ml; respiratory rate 25/min; PEEP 5 cmH₂O; FiO₂ 0.21; Flow 60 lpm.

Hygrometry was measured with the psychrometric method and 3 measurements were performed for each condition.

Expiratory Tidal Volumes in each condition were all recorded from the ventilator screen.

Results: Main results are shown on the Figure. The absolute humidity was reduced along the expiratory circuit with the FP950 and the Evaqua circuits (RT380). To avoid condensation in the expiratory limb, the VHB20 increases the temperature along the expiratory limb (leading to a reduction of relative humidity with stable water content). A similar functioning was observed with the MR850/RT210 circuit. No condensation was found along the expiratory limb for the different tested circuits in the bench study conditions. Results at different ambient temperatures were very closes.

Despite high temperatures at the inlet ventilator, the tidal volumes measured by the ventilator were very closes.

Conclusions: Different strategies are used to avoid the occurrence of condensation in the expiratory limb. Two circuits (FP950 and Evaqua2) use “porous” materials allowing a reduction of the humidity along the expiratory line. Two circuits (VHB20 and RT210) use a strategy of increased temperature allowing a reduction of the relative humidity to limit the risk of condensation. However, this strategy may alter the tidal volume measurements (which has not been shown with the ventilator used in the study), and may increase the resistance if HME filters are used instead of filters (with low hygrophobic/hygroscopic properties)¹.

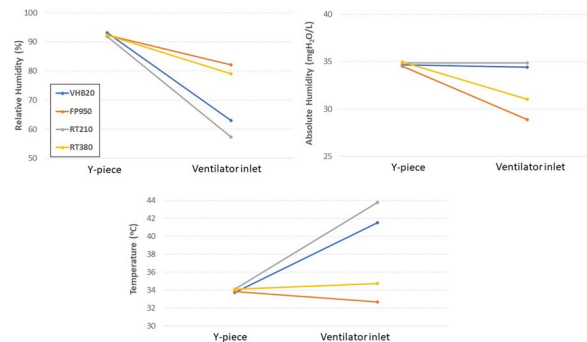

Figure (abstract 000942) Mean Relative Humidity, Absolute Humidity and gas Temperature measured at the Y-piece and at ventilator inlet with different circuits used with VHB20, FP950 and MR850 (RT210 and RT380, Evaqua2) heated humidifiers

References

1. Tonnelier A, Lellouche F, Bouchard PA, L'Her E. Impact of humidification and nebulization during expiratory limb protection: an experimental bench study. *Respiratory care* 2013; 58(8): 1315–22.
2. studies to evaluate humidification devices were funded by Fisher&Paykel and Vincent medical

Topic: Acute respiratory failure and mechanical ventilation

000944

Whispers from the community: differences in primary care utilisation before critical illness

B. Post¹, K. Roman², A. Faisal², S.J. Brett³

¹Department of Bioengineering and Computing, Imperial College London, South Kensington Campus, London, United Kingdom;

²Department of Chemical Engineering, Imperial College London, London, United Kingdom; ³Critical care, Imperial College Healthcare NHS Trust, London, United Kingdom

Correspondence: B. Post

Intensive Care Medicine Experimental 2023, **11(Suppl 1)**:000944

Introduction: Critical illness is associated with significant mortality and morbidity including a risk of long-term disability and functional decline (McPeake 2021, Morgan, 2021). The early identification of patients at risk of critical illness may allow early preventative measures to be instigated to avoid admission and allow individuals to understand the implications of a possible future critical illness. Here we demonstrate that, across the country of Wales, interactions with primary care are significantly different for patients that suffer a critical illness compared to the general population.

Methods: We performed a retrospective observational study using the Secure Anonymised Information Linkage (SAIL) Databank (Ford 2009, Lyons 2009, Jones 2014) which contains billions of linked primary and secondary care, person-based health records and covers over 80% of the population of the country of Wales. We identified all adult patients aged 18–100 in the database for the years 2016–2018 and extracted all dates where at least one data point (e.g., general practice attendance, lab test, prescription, administrative action) was recorded in their primary care electronic healthcare record (EHR). We refer to these dates collectively as General Practice Events (GPEs). Our outcome of interest was emergency ICU admission in the year 2018. For all patients with an emergency ICU admission, we extracted all GPEs up to 24 months prior to their admission. For patients that did not undergo an ICU admission, a random date in 2018 was selected and all GPEs up to 24 months prior were extracted. As such, regardless of outcome, each patient was assigned an *outcome date* and 24 months' worth of preceding GPEs were extracted.

We calculated the total number of GPEs identified for each patient and the median time difference between all sequential GPEs. We report the median and [interquartile range (IQR)], by outcome group, for each of these values. This study was approved by the SAIL independent Information Governance Review Panel (IGRP) (ref 1323).

Results: 1,400,014 individuals met study inclusion criteria. A total of 3268 patients had an emergency ICU admission in the year 2018 (i.e., ICU admission rate of 0.23%). Patients admitted to ICU were slightly older (62 years [23] vs 60 years [27]), had more GPEs in the 2 years prior to ICU admission (128 [165] vs 48 events [52]) and a shorter median time interval between GPEs (5 days [3] vs 9.5 [11]). These differences are more pronounced in younger age groups as the number of GPEs (Figure 1) and median time difference between GPEs (Figure 2) tend to converge for those aged over 85.

Conclusions: We have shown that, in the country of Wales, the patterns of primary care interaction are different for 2 years prior to an emergency critical care admission. Patients interacted more frequently with primary care services if they subsequently underwent an emergency ICU admission, compared to the general population. These findings suggest that the trajectory of critical illness may evolve over years, opening the possibility of very early identification of patients at risk of future deterioration from electronic healthcare records.

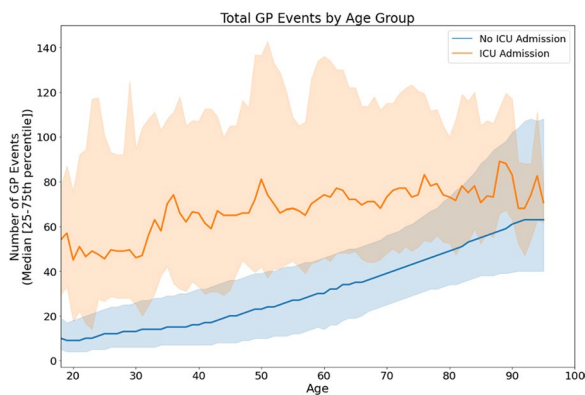

Figure 1 (abstract 000944) Total GP Events Prior to Outcome Date (patients aged >95 not displayed as age-group counts <10 risk individual identification)

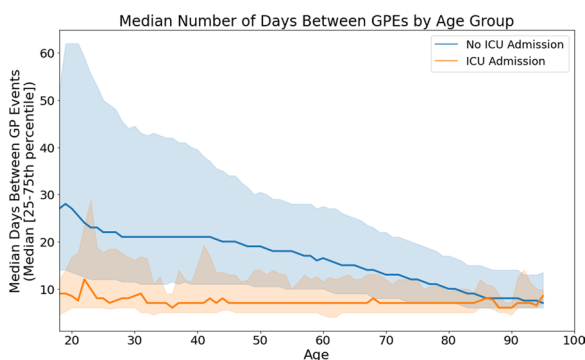

Figure 2 (abstract 000944) Median interevent time between gp events by age group prior to outcome date. (patients aged >95 not displayed as age-group counts <10 risk individual identification)

References

- BP was supported by the UKRI CDT in AI for Healthcare <http://ai4health.io> (Grant No. EP/S023283/1). AAF holds a UKRI Turing AI Fellowship (Grant

- No. EP/V025449/1). This research was also funded by the NIHR Imperial Biomedical Research Centre (BRC), and by Research Capability Funding.
- Jones KH, Ford DV, Jones C, Dsilva R, Thompson S, Brooks CJ, et al. A case study of the Secure Anonymous Information Linkage (SAIL) Gateway: a privacy-protecting remote access system for health-related research and evaluation. *J Biomed Inform.* 2014 Aug;50:196–204.
- Lyons RA, Jones KH, John G, Brooks CJ, Verplancke JP, Ford DV, et al. The SAIL databank: linking multiple health and social care datasets. *BMC Med Inform Decis Mak.* 2009 Jan 16;9(1):3
- Ford DV, Jones KH, Verplancke JP, Lyons RA, John G, Brown G, et al. The SAIL Databank: building a national architecture for e-health research and evaluation. *BMC Health Serv Res.* 2009 Sep 4;9(1):157.
- Morgan A. Long-term outcomes from critical care. *Surg Oxf Oxf.* 2021 Jan;39(1):53–7.
- McPeake J, Iwashyna TJ, Henderson P, Leyland AH, Mackay D, Quasim T, et al. Long term outcomes following critical care hospital admission: A prospective cohort study of UK biobank participants. *Lancet Reg Health—Eur.* 2021 Jul 1;6:100121.

Topic: Data Science

000945

Hygrometric performances of Heat and Moisture Exchangers and Filters—comparison of the psychrometric method and manufacturers data

F. Lellouche¹, P. A. Bouchard¹, J. C. Lefebvre², R. Branson³

¹Centre de Recherche, Institut Universitaire de Cardiologie et de Pneumologie de Québec-Université Laval, Québec, Canada;

²Département d'anesthésiologie et de soins intensifs, Division de soins Intensifs, Laval University, Québec, Canada; ³Department of Surgery, Division Of Trauma & Critical Care, University Cincinnati, Cincinnati, United States of America

Correspondence: F. Lellouche

Intensive Care Medicine Experimental 2023, **11(Suppl 1)**:000945

Introduction: Providing gas humidification greater than 28 mgH₂O/L is mandatory for patients with prolonged intubation, with either heat and moisture exchangers (HME) or heated humidifiers (HH). Several studies showed significant differences between independent measurements of the humidity delivered by the HME and manufacturers data 1-3.

Methods: We tested on a bench, the hygrometric performances of **19 HMEs** and **14 Filters**: We used the psychrometric method to measure hygrometry at steady state, with expiratory humidity of 35 mgH₂O/L simulated as previously described². For each condition, 3 hygrometric measurements were performed with similar conditions for ambient air temperature 25 ± 0.5 °C, and ventilator settings (respiratory rate 20/min, tidal volume 500 ml, FiO₂ 21%, PEEP 5 cmH₂O, square flow 60 l/min).

We compared data obtained on bench with data provided by the manufacturers.

Results: The mean measured absolute humidity in the group of HME and filters were 27.6 and 17.4 mgH₂O/L respectively. For HME, mean humidity data provided by the manufacturers was 33.6 mgH₂O/L (P < 0.01 in comparison with measured humidity). The mean differences between measured humidity and data provided by the manufacturers for HMEs was 5.7 mgH₂O/L, with 6/12 (50%) of devices with differences of 5 mgH₂O/L or above.

The main results are presented on the Figure 2. These results are preliminary.

Conclusions: Few HMEs provided sufficient gas humidity and important differences were found in terms of humidification performances between HMEs and filters. Data provided by manufacturers obtained with gravimetric method may not be reliable.

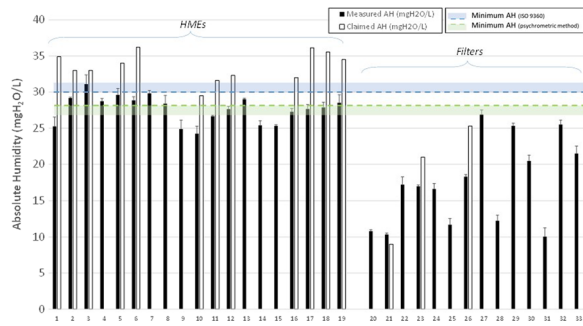

Absolute Humidity according to manufacturer’s (white bars) and to humidity measurements with the psychrometric method (black bars). The humidity of 28 mgH₂O/L (red line) is considered a safe limit for prolonged mechanical ventilation.

Abbreviations: AH: absolute humidity.

HME: **1**-AquaSure HEPABac filter Humidifier **2**-DAR Adult Pediatric Mechanical Filter HME Small – Medtronic **3**-DAR Adult Pediatric Mechanical Filter HME Large – Medtronic **4**-DAR Adult Pediatric Electrostatic Foam Filter HME **5**-DAR Adult Pediatric Mechanical Filter HME Large **6**-Drager-HME HumidStar 55 Plus **7**-Drager_Filtre HME twinstar 90 Plus **8**-Flexicare_Climavent S _Angled HME Small **9**-Intersurgical—Clear Therm3, HMEF **10**-Intersurgical Filtra-Therm **11**-Intersurgical Hydrotherm 3 HME **12**-Intersurgical InterTherm HME **13**-Medisize Climavent S HME Small **14**-Medline ref DYNJAAHME10 **15**-Medline ref DYNJAAHME1B **16**-Pharma system ref Bact HME midi port 6310 **17**-Teleflex humid vent 2S **18**-Teleflex Compact A **19**-Vincen medical—Heat and moisture exchanger filter (HMEF).

Filter: **20**-AquaSure Filter **21**-DAR Electrostatic filter **22**-DAR Mechanical Filter Large **23**-DAR -Mechanical Filter Compact **24**-Drager Safe Star 80 **25**-Flexicare_Ventishield_Adult Bacterial Viral Filter **26**-Flexicare HepaShield **27**-Getinger-Servo guard Filter **28**-Intersurgical Flo-Guard Breathing filter **29**-Intersurgical-Air guard clear **30**-Intersurgical-Hydroguard mini **31**-Medisize Barr Vent S Bacterial viral filter **32**-Pall-BB100E **33**-Pall-BB50TE.

References

1. Lellouche F, Lavoie-Bérard CA, Rousseau E, Bouchard PA, Lefebvre JC, Branson R, et al. How to avoid an epidemic of endotracheal tube occlusion. *Lancet Respir Med* 2021;9(11):1215–1216.
2. Lellouche F, Taille S, Lefrancois F, Deye N, Maggiore SM, Jouvett P, et al. Humidification performance of 48 passive airway humidifiers: comparison with manufacturer data. *Chest* 2009;135(2):276–286.
3. Thiery G, Boyer A, Pigne E, Salah A, De Lassence A, Dreyfuss D, et al. Heat and moisture exchangers in mechanically ventilated intensive care unit patients: a plea for an independent assessment of their performance. *Critical care medicine* 2003;31(3):699–704.
4. Lellouche F, Taille S, Lefrancois F, Deye N, Maggiore SM, Jouvett P, et al. Humidification performance of 48 passive airway humidifiers: comparison with manufacturer data. *Chest* 2009;135(2):276–286.
5. Thiery G, Boyer A, Pigne E, Salah A, De Lassence A, Dreyfuss D, et al. Heat and moisture exchangers in mechanically ventilated intensive care unit patients: a plea for an independent assessment of their performance. *Critical care medicine* 2003;31(3):699–704.
6. No grant for this study

Topic: Acute respiratory failure and mechanical ventilation

000947

Altered atrial strain and diastolic failure in septic cardiomyopathy: a prospective study in an Argentine ICU

B. Tort¹, A. Sosa², L. Bertorello³, F. Daldoss¹, J. Roberti³, P. Merlo⁴
¹Intensive Care Unit, Hospital Alemán (German Hospital of Buenos Aires), Buenos Aires, Argentina; ²Intensive Care Unit, Hospital Alemán, Buenos

Aires, Argentina; ³Intensive Care Unit, Hospital Alemán (German Hospital of Buenos Aires), Buenos Aires, France; ⁴Intensive Care, Hospital General de Agudos B. Rivadavia, Buenos Aires, Argentina

Correspondence: J. Roberti

Intensive Care Medicine Experimental 2023, **11(Suppl 1)**:000947

Introduction: Sepsis is a life-threatening organ dysfunction caused by a dysregulated host response to infection (1). Altered systolic and diastolic functions are associated with increased mortality, with a variable presentation (2–4). Assessment of systolic function usually uses classical echocardiographic variables, whereas assessment of diastolic function in critically ill patients is challenging, as there is no index to assess simultaneous relaxation, left ventricular stiffness and high filling pressures. The left atrium (LA) plays a crucial role in cardiac haemodynamics by regulating left ventricular (LV) filling through its reservoir function, conduction, and contraction, and left atrial strain (LARS) measured by speckle tracking is being investigated as an indicator of diastolic function and left ventricular filling pressures (LVFP) (6,7).

Objectives: to investigate association between the assessment of diastolic dysfunction with left atrial strain (LARS) measured by speckle tracking in patients with sepsis.

Methods: A prospective cohort study in a critical care unit. Inclusion criteria: diagnosis of sepsis or septic shock (Sepsis 3.1), > 18 years of age. Exclusion criteria: previous structural heart disease, ejection fraction (EF) < 50%, types 2, 3 diastolic dysfunction and ultrasound window limitations. Pro-BNP and troponin T were measured as markers of myocardial injury. A transthoracic echocardiogram (TTE) was performed within 24 h of study entry. E/A ratio was recorded by transmitral flowgram, e', using tissue Doppler, E/e' ratio was calculated to assess LV filling pressures, LARS was analyzed in apical four-chamber and two-chamber views, average LA reservoir fraction expressed as percentage. Patients with normal mitral filling pattern or decreased distensibility and E/e' ratio < 8 were classified as normal and those with pseudonormal or restrictive filling pattern with E/e' > 12 were classified as dysfunction type 2 and 3 respectively. GE VVI IQ model with matrix transducer and atrial strain software was used.

Results: A total of 97 patients were included, 53 (54.64%) with normal diastolic function and normal filling pressures and 44 (45.36%) patients with types 2 and 3 diastolic dysfunction and elevated filling pressures. Mortality in the group with normal diastolic function was 17% versus 54.6% in the dysfunction group, P = 0.000. Mean E/E' values were 7.9 vs. 15.5 in the normal function versus dysfunction groups, respectively, P = 0.000. Mean LARS for the group with normal function was 20.89.1% vs. 16.44.7% in the group with dysfunction, P = 0.0129.

Characteristics	Total group N = 97	No dysfunction n = 52	Dysfunction N = 43	P Value
Male, n (%)	58 (59.8)	32 (60.4)	26 (59.1)	0.898
Age, years	67.214.7	62.515.7	72.911.1	0.0004
Apache score	15.16.9	14.36.5	16.07.3	0.2400
SOFA max	6.63.0	6.42.9	6.93.3	0.4737
Heart rate, b/m	95.421.1	93.020.2	98.322.1	0.2199
E/E'	11.44.8	7.91.8	15.54.0	0.0000
Left atrial strain biplane (%)	18.97.8	20.89.1	16.44.7	0.0129
ICU mortality	33 (34.0)	9 (17.0)	24 (54.6)	0.000

Data expressed as number (%) or mean ± SD. EF ejection fraction; E/e' early transmitral velocity to tissue Doppler mitral annular early diastolic velocity ratio

Conclusions: A LARS value < 18% has been shown to be safe for estimating patients with elevated filling pressures, being outside the normal range in all age groups observed. In the setting of sepsis, utility should continue to be evaluated; in our population it was associated with increased mortality.

References

- 1- Singer M, Deutschman CS, Seymour CW, Shankar-Hari M, Annane D, Bauer M, Bellomo R, Bernard GR, Chiche JD, Coopersmith CM, Hotchkiss RS, Levy MM, Marshall JC, Martin GS, Opal SM, Rubenfeld GD, van der Poll T, Vincent JL, Angus DC. The Third International Consensus Definitions for Sepsis and Septic Shock (Sepsis-3). *JAMA*. 2016 Feb 23;315(8):801–10
- 2- Havaladar AA. Evaluation of sepsis induced cardiac dysfunction as a predictor of mortality. *Cardiovasc Ultrasound*. 2018;16: 31. doi: <https://doi.org/10.1186/s12947-018-0149-4>.
- 3- Sarah J. Beesley, Gerhard Weber, Todd Sarge, Sara Nikravan, Colin K. Grissom, Michael J. Lanspa, Sajid Shahul, Samuel M. Brown. *Crit Care Med* 2018 April 46(4):625–634.
- 4- Matteo Cameli, Giulia Elena Mandoli, Ferdinando Loiacono, Frank Lloyd Dini, Michael, Henein, Sergio Mondillo. Left atrial strain: a new parameter for assessment of left ventricular filling pressure. *Heart Fail Rev* (2016) 21:65–76.
- 5- Bogdan A. Popescu, Carmen C. Beladan, Sherif F. Nagueh, and Otto A. Smiseth. How to assess left ventricular filling pressure by echocardiography in clinical practice. *European Heart Journal—Cardiovascular Imaging* (2022) 23, 1127–1129.
- 6- Roberta Ancona, Salvatore Comenale Pinto, Pio Caso, Antonello D'Andrea, Giovanni Di Salvo, Fortunato Arenga, Maria Gabriella Coppola, Vincenzo Sellitto, Maria Macrino and Raffaele Calabrò. Left Atrium by Echocardiography in Clinical Practice: From Conventional Methods to New Echocardiographic Techniques. *The Scientific World Journal Volume 2014, Article ID 451042, 15 pages.*
- 7- Antoine Vieillard-Baron. Septic cardiomyopathy. *Annals of Intensive Care*. 2011, 1:6.

Topic: Sepsis

000948

[18F]FDG PET/CT to identify infections and inflammation in persistent critical illnessB. van Leer¹, K. M. Demenaga², M. W. Nijsten², J. H. Snick¹, A. W. J. M. Glaudemans¹, R. H. J. A. Slart¹, J. Pillay²¹Department of nuclear medicine, University Medical Center Groningen, Groningen, Netherlands; ²Department of critical care, University Medical Center Groningen, Groningen, Netherlands**Correspondence:** B. van Leer*Intensive Care Medicine Experimental* 2023, **11(Suppl 1)**:000948

Introduction: In patients with persistent critical illness (PerCI), prognosis after day 10 is no longer determined by the initial admission diagnosis, but by a cascade of events resulting in new and persistent organ failure.(1) Acquired immune paralysis, resulting in occult infections or persistent inflammation both play a role in PerCI.(2) [18F]FDG PET/CT can be used as a method to image (low-grade) infection and inflammation.(3,4).

Objectives: To investigate the value of [18F]FDG PET/CT in patients with PerCI.

Methods: Patients (≥ 18 years) admitted to the ICU of the University Medical Center Groningen between 2010 and 2023 by whom a [18F]FDG PET/CT was performed ten days or more after ICU admission were retrospectively included. [18F]FDG PET/CT report was evaluated for infection foci and in combination with clinical records therapy change was scored. Therapy change was defined as any therapeutic decision (e.g. starting, stopping, continuing or restricting) reported to be made directly after the [18F]FDG PET/CT. In addition, we assessed whether presence of infection on the [18F]FDG PET/CT was associated with length of ICU stay and all-cause mortality using Kaplan–Meier with Log-Rank test.

Results: 18 patients were included. Clinical signs of Inflammation or infection was the main reason to perform a [18F]FDG PET/CT scan. In 13 (72%) patients an infectious focus was found. [18F]FDG PET/CT was followed by therapy change in 11 patients (61%). In 9 patients a decision was made regarding antibiotic therapy. Corticosteroids were

started in 2. Furthermore, in 2 patients drainage of infected collections was performed and in one patient supportive therapy was limited. Two patients died. Mean ICU admission time was 47 days. No association between presence of infection on [18F]FDG PET/CT and ICU stay and all-cause mortality was observed.

Conclusions: In patients with PerCI and clinical suspicion of inflammation, PET-CT contributes to identification of an infectious or inflammatory focus and results in therapy change. Larger prospective studies are needed to determine the impact of PET/CT on length of stay and mortality in this patient category.

References

1. 2. Zhang B, Han Y, Chen X, et al. Association of Monocyte-to-Lymphocyte and Neutrophil-to-Lymphocyte Ratios With Persistent Critical Illness in Patients With Severe Trauma. *J Trauma Nurs*. 2022;29(5):240–251. doi: <https://doi.org/10.1097/JTN.0000000000000672>
2. 3. Pijl JP, Londema M, Kwee TC, et al. FDG-PET/CT in intensive care patients with bloodstream infection. *Crit Care*. 2021;25(1). doi: <https://doi.org/10.1186/S13054-021-03557-X>
3. 4. Glaudemans AWJM, Gheysens O. Expert opinions in nuclear medicine: Finding the “holy grail” in infection imaging. *Front Med*. 2023;10:320. doi: <https://doi.org/10.3389/FMED.2023.1149925/BIBTEX>
4. 1. Iwashyna TJ, Hodgson CL, Pilcher D, et al. Timing of onset and burden of persistent critical illness in Australia and New Zealand: a retrospective, population-based, observational study. *Lancet Respir Med*. 2016;4(7):566–573. doi: [https://doi.org/10.1016/S2213-2600\(16\)30098-4](https://doi.org/10.1016/S2213-2600(16)30098-4)

Topic: Infections and prevention

000949

Correlation between lung ultrasound score and venous excess ultrasound score in intensive care unit patients: results of a prospective observational studyP. Klomp maker¹, D. Allard¹, A. Mousa², E. Mus³, H. J. De grooth⁴, A. P. J. Vlaar⁵, D. P. Veelo⁶, P. R. Tuinman¹¹Intensive Care, Amsterdam UMC, Locatie VUmc, Amsterdam, Netherlands; ²Intensive Care Medicine, Amsterdam UMC, locatie VUmc, Amsterdam, Netherlands; ³Anesthesiologie, Amsterdam UMC, locatie VUmc, Amsterdam, Netherlands; ⁴Intensive care adults, Amsterdam UMC, Locatie VUmc, Amsterdam, Netherlands; ⁵Department of Critical Care, Amsterdam UMC, Locatie AMC, Amsterdam, Netherlands; ⁶Anesthesiologie, Amsterdam UMC, locatie AMC, Amsterdam, Netherlands**Correspondence:** P. Klomp maker*Intensive Care Medicine Experimental* 2023, **11(Suppl 1)**:000949

Introduction: Abnormalities in Lung ultrasound (LUS) have been shown to correlate with pulmonary edema and fluid overload.(1) Recently, Lung ultrasound has been used to monitor and guide fluid management in intensive care unit (ICU) patients.(2,3) The Venous Excess Ultrasound (VExUS) score has been proposed for monitoring venous congestion.(4) Both the LUS and VExUS score monitor markers of fluid overload.(5) However, their correlation within ICU patients is unknown. We hypothesise that higher LUS score and VExUS score are positively correlated.

Objectives: The aim of this study is to investigate the correlation between LUS and VExUS score.

Methods: This is a single-center prospective cohort study in adult ICU patients expected to be admitted for more than 24 h to a tertiary mixed ICU. Within 48 h of ICU admission, LUS and VExUS were performed with an interval of 1–2 days, with a maximum of three times. We selected LUS score at time of the most abnormal VExUS for analyses. Our primary outcome was the correlation between LUS score and VExUS score. Secondary outcomes were correlation between cumulative fluid balance and LUS score and cumulative fluid balance and VExUS score. Correlations were tested using Spearman or Pearson statistic when appropriate.

Results: From January to April 2023, 36 patients were included. The mean age of the cohort was 64(± 13.9), 61% was male. The most common reason for ICU admittance was sepsis, n = 14 (39%), followed by cardiac reasons, mostly out of hospital cardiac arrest, n = 9 (25%). The median cumulative fluid balance at time of ultrasound was 1342.7 mL. The median LUS score was 6 and the median VExUS score was 1 (Table 1). No significant correlation between LUS score and VExUS score was found: $\rho = 0.10$, $p = 0.55$. No significant correlation between cumulative fluid balance and LUS score or VExUS score was found $\rho = -0.004$ $P = 0.98$ and $\rho = -0.11$ $P = 0.49$ respectively.

Table 1 (abstract 000949) Ultrasound measurements

Lung Ultrasound (LUS) Score	
Median LUS score [IQR]	6[1.5–11.25]
Venous Excess Ultrasound(VExUS) score n %	
Median VExUS score [IQR]	1[0–1]
0	15(42)
1	17(47)
2	2(6)
3	2(6)

Conclusions: In this cohort of ICU patients no significant correlation between LUS score and VexUS score was found. However, due to a relatively small sample size in a mixed ICU population it is too early to accurately assess this correlation.

References

1. Bouhemad B, Mongodi S, Via G, Rouquette I. Ultrasound for “Lung Monitoring” of Ventilated Patients. *Anesthesiology*. 2015;122.2(2):437–47.
2. Beaubien-Souligny W, Rola P, Haycock K, Bouchard J, Lamarche Y, Spiegel R, et al. Quantifying systemic congestion with Point-Of-Care ultrasound: development of the venous excess ultrasound grading system. *Ultrasound J*. 2020;12(1):16.
3. Blok SG, Mousa A, Brouwer MG, de Grooth H-J, Neto AS, Blans MJ, et al. Effect of lung ultrasound-guided fluid deresuscitation on duration of ventilation in intensive care unit patients (CONFIDENCE): protocol for a multicentre randomised controlled trial. *Trials*. 2023;24(1):226.
4. Winkler MH, Touw HR, van de Ven PM, Twisk J, Tuinman PR. Diagnostic Accuracy of Chest Radiograph, and When Concomitantly Studied Lung Ultrasound, in Critically Ill Patients With Respiratory Symptoms: A Systematic Review and Meta-Analysis. *Critical Care Medicine*. 2018;46(7):e707–e14.
5. Agricola E, Bove T, Oppizzi M, Marino G, Zangrillo A, Margonato A, et al. “Ultrasound Comet-Tail Images”: A Marker Of Pulmonary Edema: A Comparative Study With Wedge Pressure And Extravascular Lung Water. *Chest*. 2005;127(5):1690–5.

Topic: Cardiovascular issues in ICU

000950

Changes in the plethysmographic perfusion index during a PEEP-test can reliably assess simultaneous cardiac index changes in mechanically ventilated patients

C. Lai¹, E. Rocca¹, R. Shi¹, F. Moretto¹, D. Rosalba¹, S. Cappio Borlino¹, N. Fage¹, B. Terschiphorst¹, F. Gavelli¹, A. Beurton², M. Dres², J. L. Teboul¹, X. Monnet¹

¹AP-HP, Service de Médecine Intensive-Réanimation, Hôpital de Bicêtre, Université Paris-Saclay, DMU CORREVE, Inserm UMR S_999, FHU SEPSIS,

Groupe de Recherche Clinique CARMAS, Le Kremlin-Bicêtre, France;

²Groupe Hospitalier Universitaire AHP-Sorbonne Université, site Pitié-Salpêtrière, AP-HP, Service de Médecine Intensive-Réanimation, Paris, France

Correspondence: E. Rocca

Intensive Care Medicine Experimental 2023, **11(Suppl 1)**:000950

Introduction: In mechanically ventilated patients with a level of positive end-expiratory pressure (PEEP) ≥ 10 cmH₂O, the PEEP-test, consisting in a transient decrease in PEEP to 5 cmH₂O, has been recently suggested to detect volume responsiveness [1]. In this princeps study, its effects have been assessed on cardiac index (CI) measured with an invasive monitoring device. Changes in perfusion index (PI), which quantifies the amplitude of the plethysmographic signal, has been used as a surrogate of CI variations and might be employed to assess the hemodynamic effects of the PEEP-test.

Objectives: We evaluated if changes in PI could detect a positive PEEP-test.

Methods: In a prospective observational study conducted in an intensive care unit, the PI was measured in 28 patients with acute circulatory failure and no cardiac arrhythmias, under mechanical ventilation with a PEEP level ≥ 10 cmH₂O. PI and CI (pulse contour analysis, PiCCO2 device) were measured before and during a 1-min PEEP-test. A positive PEEP-test was defined by an increase in CI $> 8.6\%$.

Results: Demographical and clinical characteristics at baseline are presented in Table 1. During the PEEP test, PEEP was decreased by 7 (5–10) cmH₂O. In the 14 (50%) patients with a positive PEEP-test, CI and PI increased by 17 (15–20)% and 14 (9–20)%, respectively. These changes were significantly larger than the respective changes in CI and PI in patients with a negative PEEP-test (5 [4–8]% and 0 [0–6]%, respectively) (Figure 1). A significant correlation between maximal changes in CI and PI during the PEEP-test was observed ($\rho = 0.80$ [0.60–0.90], $p < 0.0001$). An increase in PI $> 7\%$ during the PEEP-test reliably detected a positive PEEP-test with an area under the receiver operating characteristic curve of 0.94 (0.78–0.99) ($p < 0.0001$ vs 0.5), a sensitivity of 93 (66–100)% and a specificity of 86 (57–98)% (Figure 2).

Table 1 (abstract 000950) Demographical and clinical characteristics at baseline

Variables	Study population (n = 28)
Age, years	63 (14)
Male sex, n (%)	18 (64)
BMI, kg/m ²	29 (27–32)
SAPS II	40 (35–50)
Norepinephrine, mcg/kg/min	0.16 (0.09–0.6)
Tidal volume, mL/kg	5.9 (0.4)
PEEP, cmH ₂ O	13 (11–15)
Plateau pressure, cmH ₂ O	26 (24–28)
Driving pressure, cmH ₂ O	11 (10–15)
Respiratory system compliance, mL/cmH ₂ O	33 (27–42)

Conclusions: An increase of PI during the PEEP-test $> 7\%$ reliably detects a positive response of CI to the PEEP-test. In patients in whom an invasive monitoring of CI is not available, PI may be used as a surrogate for assessing the PEEP-test effects.

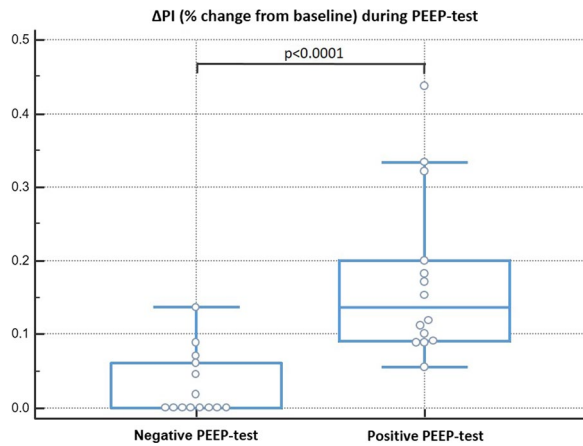

Figure 1 (abstract 000950) Changes in perfusion index (PI) during a PEEP-test according to PEEP-test response

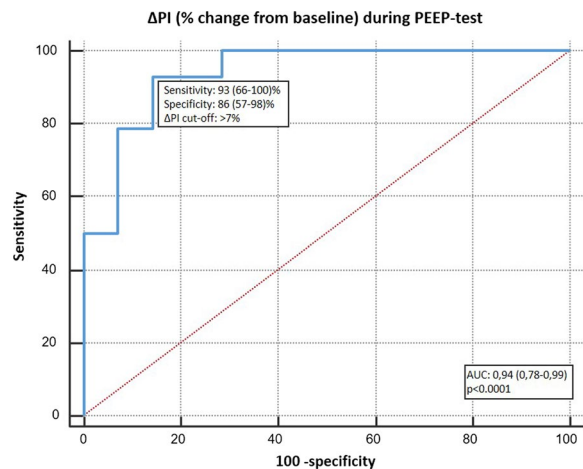

Figure 2 (abstract 000950) Area under the receiver operating characteristic curve generated for the detection of a PEEP-test by the changes in perfusion index (PI)

References

- Lai, C., Shi, R., Beurton, A. et al. The increase in cardiac output induced by a decrease in positive end-expiratory pressure reliably detects volume responsiveness: the PEEP-test study. *Crit Care* 27, 136 (2023). doi: <https://doi.org/10.1186/s13054-023-04424-7>

Topic: Cardiovascular issues in ICU

000952

The SERAPH-100 Microbind blood filter lacks binding affinity to cytomegalovirus

A. Buhlmann¹, V. Kufner², J. T. Kielstein³, R. Andermatt¹, S. David¹
¹Institute of Intensive Care Medicine, University Hospital of Zürich, Zürich, Switzerland; ²Institute of Medical Virology, University of Zurich, Zürich, Switzerland; ³Medical clinic v Nephrology | Rheumatology | blood purification, Academic Teaching Hospital Braunschweig, Brunswick, Germany

Correspondence: A. Buhlmann
Intensive Care Medicine Experimental 2023, **11(Suppl 1)**:000952

Introduction: Reactivation of cytomegalovirus (CMV) occurs in up to one third of critically ill patients (1). Even though its clinical relevance is still under debate, numerous studies have shown an potential increase in mortality (2), duration of hospital stay, days on mechanical ventilation (3) and a greater health system resource utilization (4). Effective anti-viral drugs against CMV are widely available but can have relevant side effects and might be less effective in resistant strains. The hemoperfusion device Seraph 100 Microbind Affinity blood Filter (Seraph-100) can remove certain pathogens, including viruses (5–9). This technology mimics a heparin sulfate rich cell surface, as the pathogens form a nonreversible bind with heparin coated, ultrahigh molecular weight polyethylene beads (9). We have tested the Seraph-100 in a patient with a suspected ganciclovir resistant CMV infection to analyze its adjuvant effectiveness.

Objectives: Explorative analysis to evaluate Seraph-100’s efficacy in reducing CMV viral load by quantitative polymerase chain reaction (PCR) in an immunocompromised patient.

Methods: The general consent to use anonymized data was given by the patient on admission to the University hospital of Zurich. According to our in house standard, the immunocompromised patient received an antiviral treatment with ganciclovir as soon as the elevated CMV viral load was diagnosed, but it increased in the course so that ganciclovir resistance was suspected. Given that the patient was already on a continuous kidney replacement treatment (CKRT) a Seraph-100 was connected in series (post-filter configuration) to the extracorporeal circuit with a blood flow (Q) of 80 ml/min and an ultrafiltration of 250 ml/h. Plasma samples for CMV PCR analysis were taken at start and then hourly over a 4-h course of Seraph-100 treatment both systemically and post-Seraph. CMV clearance rates were calculated as $CI = Q \times (C_{syst} - C_{post}) / C_{syst}$.

Results: To our surprise, we were not able to detect any reduction in CMV viral load. The initial systemic CMV DNA concentration of 1590 IE/ml went up to 1890 IE/ml at the end of the treatment and post-Seraph viral copies were even higher from the first sample on with 2220 UI/ml and increasing up to 2440 IU/ml. Consequently, negative clearance rates were calculated (t0: – 31 ml/min, t1: – 12 ml/min, t2: – 13 ml/min, t3: – 24 ml/min, t4: -23 ml/min).

Conclusions: In this explorative analysis CMV load was not removed by Seraph-100. We interpreted the viral load increase in post-Seraph samples in the context of hemoconcentration due to ultrafiltration during CKRT.

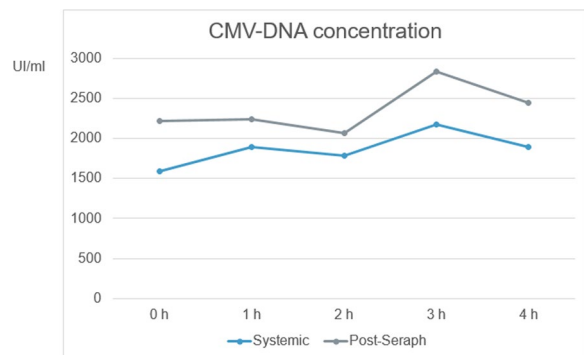

References

- Li X, Huang Y, Xu Z, Zhang R, Liu X, Li Y, et al. Cytomegalovirus infection and outcome in immunocompetent patients in the intensive care unit: a systematic review and meta-analysis. *BMC Infectious Diseases*. 2018;18(1).
- Kalil AC, Florescu DF. Is cytomegalovirus reactivation increasing the mortality of patients with severe sepsis? *Critical Care*. 2011;15(2):138.
- Limaye AP, Kirby KA, Rubenfeld GD, Leisenring WM, Bulger EM, Neff MJ, et al. Cytomegalovirus reactivation in critically ill immunocompetent patients. *JAMA*. 2008;300(4):413–22.
- Lachance P, Chen J, Featherstone R, Sligl WI. Association Between Cytomegalovirus Reactivation

and Clinical Outcomes in Immunocompetent Critically Ill Patients: A Systematic Review and Meta-Analysis. *Open Forum Infectious Diseases*. 2017;4(2). 5. Eden G, Schmidt JJ, Buttner S, Kumpers P, Hafer C, Rovas A, et al. Safety and efficacy of the Seraph(R) 100 Microbind(R) Affinity Blood Filter to remove bacteria from the blood stream: results of the first in human study. *Crit Care*. 2022;26(1):181. 6. Kielstein JT, Borchina D-N, Fühner T, Hwang S, Mattoon D, Ball AJ. Hemofiltration with the Seraph® 100 Microbind® Affinity filter decreases SARS-CoV-2 nucleocapsid protein in critically ill COVID-19 patients. *Critical Care*. 2021;25(1). 7. Olson SW, Oliver JD, Collen J, Bunin J, Gleeson TD, Foster BE, et al. Treatment for Severe Coronavirus Disease 2019 With the Seraph-100 Microbind Affinity Blood Filter. *Crit Care Explor*. 2020;2(8):e0180. 8. Schmidt JJ, Borchina DN, Van't Klooster M, Bulhan-Soki K, Okioma R, Herbst L, et al. Interim analysis of the COSA (COVID-19 patients treated with the Seraph(R) 100 Microbind(R) Affinity filter) registry. *Nephrol Dial Transplant*. 2022;37(4):673–80. 9. Seffer M-T, Cottam D, Forni LG, Kielstein JT. Heparin 2.0: A New Approach to the Infection Crisis. *Blood Purification*. 2021;50(1):28–34.

2. None

Topic: Infections and prevention

000953

Comparison of two oxygenation SpO2 targets with two different oximeters – impact on oxygen flow rates and on oxygenation parameters

F. Lellouche¹, P. A. Bouchard¹

¹Centre de recherche, Institut Universitaire de Cardiologie et de Pneumologie de Québec-Université Laval, Québec, Canada

Correspondence: F. Lellouche

Intensive Care Medicine Experimental 2023, **11(Suppl 1)**:000953

Introduction: SpO2 target influences oxygen utilization¹. It was recently shown that oximeter brand influenced the SpO2 measurements².

Objectives: To evaluate the impact of the combination of SpO2 target and oximeter brand on oxygen utilization, oxygen weaning, occult hypoxemia and occult hyperoxemia.

Methods: We currently conduct a randomized cross-over study in 20 stable ICU patients requiring oxygen therapy delivered through nasal cannula after cardiac surgery. Patients without adequate SpO2 signal are excluded. Four randomized periods of 10 min are conducted in all patients with different SpO2 targets (90 and 94%) and different oximeters (Nonin and Philips). For each period we collect the oxygen flow and oxygen blood gases at the end of the period. We compared the oxygen flow, the rate of occult hypoxemia (SaO2 < 90% with SpO2 ≥ 90%) and occult hyperoxemia (SaO2 > 96% with SpO2 ≤ 96%), oxygen partial weaning (< 0.5L/min) or complete weaning and the rate of high O2 flow requirements (> 5 L/min).

Results: We present preliminary data based on first 18 patients (mean age 69 ± 9 years, 15 were men, all had light skin pigmentation, none had shock). At baseline, SpO2 was 93.2 ± 1.9% and oxygen flow was 2.0 ± 1.5 L/min. Main results for the oxygen flow and oxygenation parameters in the different study periods are displayed in the figure. Differences in mean oxygen flow during Nonin 90 (1.7 ± 2.0 L/min) and Philips 94 (2.1 ± 2.1 L/min) are not statistically different (P = 0.11). However, all other comparisons of the oxygen flow are statistically different. The rate of complete weaning was 50% in the Philips 90 period and 0% in other periods. Oxygenation parameters (SaO2, PaO2) were similar during Nonin 90 (94 ± 1%, 72 ± 5 mmHg) and Philips 94% (94 ± 1%, 72 ± 8 mmHg). Conversely, there were statistically different oxygenation levels with Nonin 94 (97 ± 1%, 91 ± 6 mmHg) and Philips 90 (91 ± 1%, 64 ± 5 mmHg).

Conclusions: In patients requiring conventional oxygen therapy, the SpO2 target, the oximeter brand and even more the combination of both had major impact on oxygen utilization, oxygen weaning and both occult hypoxemia and hyperoxemia. Patients managed with Nonin 90 and Philips 94 had similar oxygen flow and similar arterial oxygenation parameters. These data underline the necessity to use corrected SpO2 targets rather than universal SpO2 targets to manage oxygen therapy.

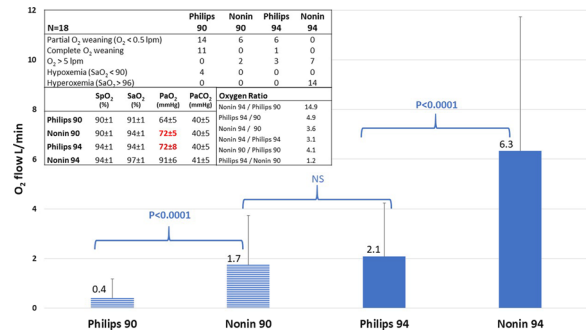

Comparison of oxygen flow utilization in different study conditions: Philips 90, Nonin 90, Philips 94, and Nonin 94) and ratio of oxygen utilization for the different tested conditions.

References

1. Bourassa S, Bouchard PA, Dauphin M, Lellouche F. Oxygen Conservation Methods With Automated Titration. *Respiratory care* 2020; 65(10): 1433–42.
2. Blanchet MA, Mercier G, Delobel A, et al. Accuracy of multiple pulse oximeter brands in stable critically ill patients—Oxygap study. *Respiratory care* 2023 Jan 3;respcare.10582. doi: <https://doi.org/10.4187/respcare.10582>.
3. Conflicts of Interest: FL is co-inventor of FreeO2 and co-founder of OxyNov. No grant was provided for this study

Topic: Acute respiratory failure and mechanical ventilation

000954

Time-related outcomes for intubation of patients with COVID-19: a cohort study

F. Hohmann¹, E. Paolinelli¹, G. Veiga¹, I. Machado¹, F. Galdino¹, M. R. Kraft¹, S. Custodio¹, B. Bravim¹, J. Silva Jr¹

¹Department of Critical Care Medicine, Albert Einstein Israelita Hospital, São Paulo, Brazil

Correspondence: F. Hohmann

Intensive Care Medicine Experimental 2023, **11(Suppl 1)**:000954

Introduction: It is known that Covid-19 has, at least initially, a nonspecific clinical course and that up to 17% of patients may require invasive mechanical ventilation (1). Many patients are initially managed with non-invasive mechanical ventilation through a High Flow Nasal Cannula and Bilevel Positive Airway Pressure (2). The patient is intubated in a decision that may involve level of consciousness, respiratory rate, oxygen saturation, fraction of inspired oxygen and breathing pattern (3). Thus, there may be significant differences between physicians with regard to the correct time to intubate a patient, and this possible delay may impact the clinical outcome (3).

Objectives: To analyze the relationship between intubation day and mortality in COVID-19 patients.

Methods: We performed a cohort study considering all COVID-19 patients consecutively admitted between March 2020 and December 2020 requiring supplemental oxygen. The primary outcome was hospital mortality after intubation, and a Cox model adjusted by SAPS-3 was used to evaluate the effect of time from onset of hospital admission to intubation in mortality.

Results: A total of 250 patients were evaluated and 73.6% were intubated. Overall, the median to intubation was 4 (2–7) days after hospital admission. Mortality occurred in 68 (27.2%) patients in which the intubation was done more than 4 (2.0–5.75) days after hospital admission. Adjusted mortality hazard ratio to the patients intubated before than 4 days was 0.68 (95% CI, 0.52 to 0.88), between 5 and 10 days 1.74 (95% CI, 1.06 to 2.87) and those more than 10 days was 2.74 (95% CI,

1.02 to 7.34). Hospital length of stay was different among intubated patients before and after 4 days [28 (18.7–43.2) vs. 36 (25–56) days], difference 7 days (95% CI, 2 to 12) $P=0.01$. All sensitivity analyses confirmed the robustness of our findings.

Conclusions: An early approach to invasive mechanical ventilation improved outcomes in this cohort of COVID-19 patients, delaying intubation in the course of symptoms may be associated with higher mortality (Figure 1).

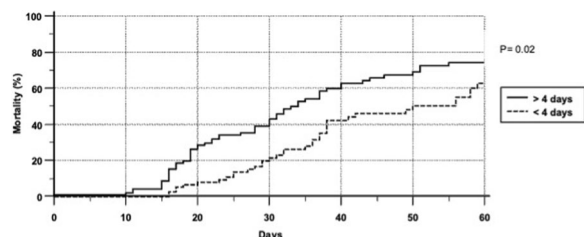

Figure 1 (abstract 000954) Kaplan–Meier curve with estimated mortality in 60 days with intubation performed before and after 4 days

References

3. Delbove A, Darreau C, Hamel JF, Asfar P, Lerolle N. Impact of endotracheal intubation on septic shock outcome: A post hoc analysis of the SEPSISPAM trial. *J Crit Care.* 2015;30(6):1174–8.
2. Sullivan ZP, Zazzeron L, Berra L, Hess DR, Bittner EA, Chang MG. Noninvasive respiratory support for COVID-19 patients: when, for whom, and how? *J Intensive Care.* 2022;10(1):3.
1. Huang L, Han R, Ai T, Yu P, Kang H, Tao Q, et al. Serial Quantitative Chest CT Assessment of COVID-19: A Deep Learning Approach. *Radiol Cardiothorac Imaging.* 2020;2(2):e200075.
4. The authors thank all patients and healthcare personnel involved in the study.

Topic: Acute respiratory failure and mechanical ventilation

000955

Post-ECMO decannulation ultrasound for identifying inferior vena cava thrombosis

J. Han¹, S. Patel², P. Cavaleiro¹, A. Bhajji²; B. Rawal³; S. Singh¹

¹Adult Intensive Care Unit, Royal Brompton & Harefield NHS Foundation Trust, London, United Kingdom; ²Department of Medicine, Chelsea and Westminster Hospital, London, United Kingdom; ³Department of Radiology, Royal Brompton Hospital, London, United Kingdom

Correspondence: J. Han

Intensive Care Medicine Experimental 2023, **11(Suppl 1)**:000955

Introduction: Extracorporeal membrane oxygenation (ECMO) is a method of providing cardiac or respiratory support. The ECMO circuit increases the chances of developing thromboembolism, and most patients during ECMO are treated with heparin with close anti-Xa monitoring.[1] Despite this, cannula-associated deep vein thrombosis (CaDVT) is a recognised and frequently occurring complication.[1] Due to this, ultrasound (US) of deep veins associated with the ECMO circuit, such as the internal jugular veins and femoral veins, is routinely performed post decannulation.[2] The inferior vena cava (IVC) is not analysed routinely, and the incidence and significance of clots in this area has not been fully elucidated. A pre-COVID pandemic study showed 54.9% patients had a thrombotic event, with 29.3% CaDVT, and 46.2% IVC thrombosis.[3].

Methods: Single-centre, retrospective, observational study. 309 patients who had ECMO treatment at Royal Brompton Hospital between November 2019 to March 2022 were analysed. Patients were excluded if they died on ECMO, if they were repatriated before US, or if the post-decannulation US occurred over one week after decannulation. 213 patients were included.

Results: 213 patients (all VV-ECMO) were included. Cannulation sites were evaluated in 213 patients and IVC was evaluated in 128 patients.

A clot is defined as a thrombus or a fibrin sheath. 43% of patients presented with a clot ($n=91$, in IVC, iliac, femoral, jugular, or saphenous veins). The incidence of CaDVT was 29.6% (63/213 for femoral or jugular clot), and IVC clot was 28.1% (36/128), of which 61% (22/36) had isolated IVC clot. 14 patients had both CaDVT and IVC clot. Characterising the IVC clots, 14% (5/36) was a thrombus, and 31/36 (86%) was a fibrin sheath/cast.

Conclusions: The incidence of IVC thrombosis is high in the post-COVID ECMO cohort. The IVC clot occurred independently of CaDVT in the majority of cases (61%). The majority of IVC clots were fibrin sheaths/casts. This is comparable to our previous pre-COVID data on IVC clots. Further research should focus on the clinical significance of an isolated IVC thrombus, and contributing factors in the development of an isolated IVC thrombus.

References

- [1] Iannattone PA, Yang SS, Koolian M, Wong EG, Lipes J. Incidence of Venous Thromboembolism in Adults Receiving Extracorporeal Membrane Oxygenation: A Systematic Review. *ASAIO J.* 2022 Dec 1;68(12):1523–1528.
- [2] van Minnen O, van den Bergh WM, Droogh JM, Koehorst L, Lagrand WK, Raasveldt SJ, Oude Lansink-Hartgring A, Terpstra A, Smit JM, Tuinman PR, Vlaar APJ. Incidence and risk factors of deep vein thrombosis after extracorporeal life support. *Artif Organs.* 2022 Sep;46(9):1893–1900.
- [3] Cavaleiro P, Crescenzi O, Rawal B, McNamara C, Padley S, Desai S, Passariello M, Ledot S, Arachchilage D, Price S, Singh S. EuroELSO 2020 Poster Abstract 305: Thrombosis after ECMO: We should start looking into the inferior vena cava. *Perfusion* 2020, Vol. 35(1S) 93–282
4. The authors received no financial support for the research, authorship, and publication of this work.
5. With acknowledgements to the patients, medical, nursing, radiology and allied health professional staff of the Adult ICU at the Royal Brompton Hospital

Topic: Acute respiratory failure and mechanical ventilation

000956

Utilization of corrected SpO2 or corrected SpO2 target to homogenize the practices regarding management of oxygen therapy

F. Lellouche¹, A. Delobel¹, M. A. Blanchet¹, P. A. Bouchard¹

¹Centre de recherche, Institut Universitaire de Cardiologie et de Pneumologie de Québec-Université Laval, Québec, Canada

Correspondence: F. Lellouche

Intensive Care Medicine Experimental 2023, **11(Suppl 1)**:000956

Introduction: SpO2 target influences oxygen utilization with increased by threefold the oxygen flow with 4% difference in SpO2 target1. It was recently showed that oximeter brand influenced the SpO2 measurements2. Combination of the errors on the SpO2 measurement related to the oximeter brand and choice of different target may have major impact on the clinical management of patients in the clinical practice and during research. One solution may be to use a corrected SpO2 target rather than an universal SpO2 target to homogenize the practices. The other solution is to correct the SpO2 values based on the known SpO2-SaO2 biases.

Objectives: The objective of the study was to evaluate if the utilization of a corrected SpO2 target or of corrected SpO2 values could homogenize the O2 management.

Methods: We performed a secondary analysis of the Oxygap study to evaluate the oxygen utilization (Increase, Decrease or No change of O2 support) in the 211 included patients. The oxygen flow was modified based on individual SpO2 values to maintain (i) a non corrected SpO2 target of 92–96%, using the Nonin, Nellcor, Masimo, Philips and (ii) a corrected SpO2 target with same pulse oximeters. The correcting factors were based on the SpO2-SaO2 bias for each oximeters found in the Oxygap study2, respectively -3.1 , -0.3 , -0.2 and $+0.9\%$. We also evaluated the impact of the utilization of corrected SpO2 values, based on the known SpO2-SaO2 bias.

Results: Based on the values obtained in the Oxygap study with 211 patients, the oxygen management showed significant discrepancies when SpO₂ were not corrected or when SpO₂ target was not corrected (Figure, panel A). When SpO₂ values were corrected (Figure, panel B) or when SpO₂ target were corrected (Figure, panel C), the management of oxygen support was homogenize with reduction of discrepancies.

Conclusions: The utilization of corrected SpO₂ values or corrected SpO₂ target may allow to reduce the large discrepancies in O₂ utilization based on confounding factors related to pulse oximetry measurements. Additional corrections based on skin pigmentation will be required when bias will be adequately evaluated.

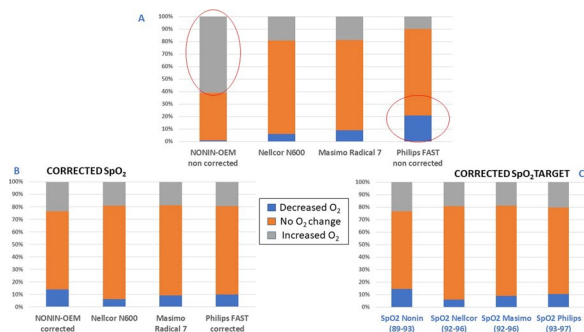

Management of oxygen support in the cohort of 211 patients of the OXYGAP study to maintain SpO₂ within 92–96% with uncorrected SpO₂ (Panel A), with corrected SpO₂ (Panel B) or with corrected SpO₂ target (Panel C)

References

1. Bourassa S, Bouchard PA, Dauphin M, Lellouche F. Oxygen Conservation Methods With Automated Titration. *Respiratory care* 2020; 65(10): 1433–42.
2. Blanchet MA, Mercier G, Delobel A, et al. Accuracy of multiple pulse oximeter brands in stable critically ill patients—Oxygap study. *Respiratory care* 2023 Jan 3;respcare.10582. doi: <https://doi.org/10.4187/respcare.10582>.
3. Conflicts of Interest: FL is co-inventor of FreeO₂ and co-founder of OxyNov. No Grant was provided for this study.

Topic: Acute respiratory failure and mechanical ventilation

000957

Unscheduled return to the paediatric emergency department within 72 h: a follow-up with big data

R. Spiegel¹

¹Department of Acute Medicine (Surgical IMC Unit, Internal Medicine and Emergency Department), University Hospital Basel, Riehen, Switzerland

Correspondence: R. Spiegel

Intensive Care Medicine Experimental 2023, **11(Suppl 1)**:000957

Introduction: The reasons for unscheduled return visits to the paediatric emergency department (PED) within 72 h after PED-discharge are subject to debate, e.g. some studies found that they are mainly justified and occasionally lead to direct admission to the paediatric intensive care unit (PICU), [1], while other studies consider most of them avoidable [2].

Objectives: The following analysis is an ongoing project since 2019. It aims to use big data in order to explore the reasons for unscheduled return visits to the PED. It is continuously updated once new data become available, i.e. once new studies have been published. Earlier analyses have been presented at conferences in Switzerland and Germany [3]-[5]. With almost 30 million cases globally, it belongs to the largest analyses in paediatric emergency medicine.

Methods: A PubMed literature search included all studies until 31st of March 2023 (i.e. the month prior to the ESICM LIVES 2023 abstract deadline). It had the search terms “emergency department”, “return”, “72 h” as well as the two different forms of spelling “pediatric – paediatric.” Publications without restriction to location or language were included. 29 publications with over 29.8 million PED visits and 804,422 unscheduled return visits were identified in 4 continents. These were (in alphabetical order): Africa, Asia, Europe, and North America. To evaluate the causes for PED-return, the reasons identified in each study were put in relation to the total number of studies, e.g. in x studies out of the total number of 29 studies, the reason “clinical condition” was the cause for an unscheduled PED-return. This permitted the calculation of a ratio for each reason. For example, the ratio for the reason “clinical condition” was defined as the number of studies x where the clinical condition was identified as the reason for unscheduled PED-returns, divided by 29. Sometimes several reasons were identified per study, for instance the clinical condition as well as young age (e.g. infants with worsening symptoms). After calculating the ratios, 95 percent confidence intervals of these ratios were computed by applying the modified Wald method (GraphPad, San Diego, CA, USA). The ratios and their confidence intervals permitted an overview of the reasons for unscheduled PED returns.

Results: Irrespective of the size of the study or the location, the main reason for unscheduled PED-returns is the clinical condition with worsening symptoms or failed improvement (21 out of 29 studies, ratio 0.72, 95% CI 0.54–0.86), followed by young age (12/29 studies, ratio 0.41, 95% CI 0.25–0.59), organizational aspects (e.g. reachability of a paediatrician or family physician, 7/29 studies, ratio 0.24, 95% CI 0.12–0.42), failed coping attempts by the caregivers (7/29 studies, ratio 0.24, 95% CI 0.12–0.42), gender aspects (5/29 studies, ratio 0.17, 95% CI 0.07–0.35) and cultural aspects (3/29, ratio 0.1, 95% CI 0.03–0.27).

Conclusions: This big data analysis showed similar results in every continent. Unscheduled return visits to the PED are mostly justified, as the main reason is the clinical condition, i.e. worsening symptoms or failed improvement. This sometimes led to direct PICU-admission due to clinical deterioration. Therefore, it is absolutely vital to take unscheduled return visits seriously. When looking at the confidence intervals, all other identified reasons play a minor role compared to the clinical condition. There is no doubt that an unscheduled PED return is not always justified and might also be avoidable. However, when incorporating as many data from as many regions as possible, there is evidence that on a global level, unscheduled PED returns are generally justified. Further evidence stems from the fact that the main two reasons for PED return (clinical condition and young age) are almost the same in every continent. Similar to a prior analysis [5], limitations are that the period “young age” was not defined equally in every study, with a range from birth up to 6.5 years in some studies. In addition, the study sizes varied substantially. North America not only contributed the largest number of studies, but also had studies with the highest number of PED cases, where for example a single study contributed to more than 25 million cases. Nevertheless, the general findings are robust irrespective of the continent or the number of cases per study.

References

1. [1] Chiang CY, Cheng FJ, Huang YS, Chen YL, Wu KH, Chiu IM. ICU admission following an unscheduled return visit to the pediatric emergency department within 72 h. *BMC Pediatr*. 2019 Aug 2;19(1):268. doi: <https://doi.org/10.1186/s12887-019-1644-y>.
2. [2] Vitello AS, Clavenna A, Cartabia M, Sala D, Biondi A, Bonati M. Evaluation of the Pattern of Use of a Pediatric Emergency Department in Italy. *Pediatr Emerg Care*. 2021 Dec 1;37(12):e1494-e1498. doi: <https://doi.org/10.1097/PEC.0000000000002091>.
3. [3] Spiegel R. Predicting return to the pediatric emergency department within 3 days: a systematic review, poster at the SGNOR online COVID-19 symposium at Emergency Medicine Day, 27 May 2020.
4. [4] Spiegel R. Return visits to the pediatric emergency department within 72 h: a follow-up analysis. *Schweizer Kongress für Notfallmedizin*, 12 to 13 May 2022.
5. [5] Spiegel R. Rückkehr in die pädiatrische Notaufnahme innerhalb von 72 Stunden: eine Follow-up Analyse anhand großer Datenmengen. 22.

Kongress der Deutschen Interdisziplinären Vereinigung für Intensiv- und Notfallmedizin (DIVI) e.V., 30 Nov to 2 Dec 2022.

6. There is no grant related to this project.

Topic: Trauma

000960

Are sonographic measures of the diaphragm at unit admission linked to ventilation outcome?

J. Kleinsmith¹, A. Lupton-Smith¹, L. Gerber¹, C. Koegelenberg², S. Hanekom¹

¹Physiotherapy, Stellenbosch University, Stellenbosch, South Africa;

²Pulmonology, Stellenbosch University, Stellenbosch, South Africa

Correspondence: S. Hanekom

Intensive Care Medicine Experimental 2023, **11(Suppl 1)**:000960

Introduction: The duration of mechanical ventilation is associated with increased mortality and the development of post intensive care syndrome. Sonographic measurements of the diaphragm taken at the time of weaning failure have been used as predictors of successful weaning outcome. However, the importance of monitoring the diaphragm from unit admission is increasingly being recognized. Identifying patients at risk of prolonged intubation at the time of unit admission could allow for focused treatment interventions aimed at prevention of ventilator induced diaphragm dysfunction and reducing time on the ventilator.

Objectives: To explore the associations between sonographic measures of the diaphragm within the first three days of unit admission and ventilation time.

Methods: This prospective observational cohort study was conducted in a tertiary hospital from March 2017 to August 2017, and received approval from the Institutional Health Research Ethics Committee (S16/09/173). Sonographic measurements of the diaphragm were initiated within 24 h of intubation, at the zone of apposition using a 5–12 MHz ultrasound transducer. Diaphragm thickness (Tdi) was measured at end-inspiration and end-expiration, and diaphragm thickening fraction (DTF) was calculated as the percent change between thickness at end-inspiration and end-expiration. All measurements were performed by a single researcher. Data was analysed in consultation with a statistician including correlation analysis using Pearson or Spearman's rho test as indicated and between- group differences using Mann–Whitney U test.

Results: Forty-nine mechanically ventilated participants were assessed within 24 h of intubation, with a mean age of 46.69 ± 18.25 years, mean APACHE score of 16.20 ± 8.96, and n = 13 (27%) of patients died in the ICU. The median time on ventilation was 56.5 h (IQR: 20 – 359.5), with the majority of patients (84%, n = 41) being ventilated for less than seven days. Moderate to strong positive correlations were observed between Tdi inspiration and expiration over the first three days and ventilation time. All correlations were significant. A moderate negative correlation was found between DTF and ventilation time. However, this negative correlation was only significant on Day 3 (Table 1). Additionally, there was a significant difference in day 1 DTF (p = 0.016*) between patients who were extubated within 7 days of unit admission and patients who were intubated for longer than 7 days. APACHE II and C-reactive protein (CRP) on unit admission were moderately correlated with time on the ventilator (Table 2).

Conclusions: Sonographic measures of the diaphragm taken within the first three days of unit admission are associated with ventilation outcome. However, APACHE II score and CRP on unit admission may act as potential confounders. The findings from this study will inform the planning of a study aimed to develop a predictive model that incorporates sonographic measures at unit admission, to estimate the probability of extended time on ventilator. Further investigation is warranted to determine the clinical utility of these findings in the context of patient care.

Table 1

	Spearman's rho	P value (2-tailed)	95% Confidence Intervals (2-tailed) ^{a,b}	
			Lower	Upper
DAY 1 Tdi Inspiration	.580	.000*	.350	.745
DAY 2 Tdi Inspiration	.558	.000*	.321	.729
DAY 3 Tdi Inspiration	.650	.000*	.405	.808
DAY 1 Tdi Expiration	.609	.000*	.388	.763
DAY 2 Tdi Expiration	.494	.000*	.239	.685
DAY 3 Tdi Expiration	.702	.000*	.482	.839
DAY 1 DTF	-.179	.217	-.445	.116
DAY 2 DTF	-.151	.301	-.421	.145
DAY 3 DTF	-.553	.000*	-.748	-.270

LEGEND: Diaphragm Thickness (Tdi) Diaphragm Thickening Fraction (DTF) *significant p<0.05

Table 2

	Pearson Correlation	P value (2-tailed)	95% Confidence Intervals (2-tailed) ^a	
			Lower	Upper
AGE	.153	.298	-.137	.419
APACHE	.363	.014*	.078	.593
C-reactive protein on admission	.388	.034*	.032	.656
Hemo-Glucose Test on admission	.040	.801	-.267	.340
Lactate on admission	.190	.234	-.125	.470

LEGEND: ^a Estimation is based on Fisher's r-to-z transformation. *significant p<0.05

References

1. Petrof BJ. Diaphragm Weakness in the Critically Ill: Basic Mechanisms Reveal Therapeutic Opportunities. *Chest*. 2018 Dec;154(6):1395–1403. doi: <https://doi.org/10.1016/j.chest.2018.08.1028>. Epub 2018 Aug 23. PMID: 30144420 Sigala I, Vassilakopoulos T. Diaphragmatic ultrasound as a monitoring tool in the intensive care unit. *Ann Transl Med*. 2017 Feb;5(4):79. doi: <https://doi.org/10.21037/atm.2017.01.68>. PMID: 28275624; PMCID: PMC5337216. Supinski GS, Callahan LA. Diaphragm weakness in mechanically ventilated critically ill patients. *Crit Care*. 2013 Jun 20;17(3):R120. doi: <https://doi.org/10.1186/cc12792>. PMID: 23786764; PMCID: PMC3840677 Zambon M, Greco M, Bocchino S, Cabrini L, Beccaria PF, Zangrillo A. Assessment of diaphragmatic dysfunction in the critically ill patient with ultrasound: a systematic review. *Intensive Care Med*. 2017 Jan;43(1):29–38. doi: <https://doi.org/10.1007/s00134-016-4524-z>. Epub 2016 Sep 12. PMID: 27620292
2. None

Topic: Nursing care and physiotherapy

000961

Serum proteome profiles in patients treated with targeted temperature management after out-of-hospital cardiac arrestG. Lileikyte¹, A. Bakochi², A. Ali³, M. Moseby-Knappe⁴, T. Cronberg⁴, H. Friberg⁵, G. Lilja⁶, H. Levin⁷, F. Arman², S. Kjellström², J. Dankiewicz⁸, C. Hassager⁹, J. Malmström²; N. D. Nielsen¹⁰

¹Department of Clinical Sciences Lund, Anaesthesia and Intensive Care, Helsingborgs Hospital, Helsingborg, Sweden; ²Swedish National Infrastructure for Biological Mass Spectrometry, Lund University, Lund, Sweden; ³National Bioinformatics Infrastructure Sweden, Lund University, Lund, Sweden; ⁴Department of Clinical Sciences, Neurology, Lund University, Lund, Sweden; ⁵Department of Clinical Sciences, Intensive And Perioperative Care, Lund University, Lund, Sweden; ⁶Department of Clinical Sciences, Neurology, Lund University, Skåne University Hospital, Sweden; ⁷Department of Clinical sciences, Lund University, Lund, Sweden; ⁸Department of Clinical sciences, Cardiology, Lund University, Skåne University Hospital, Sweden; ⁹Department of Cardiology, Rigshospitalet, København, Denmark; ¹⁰Department of Clinical Sciences Lund, Anaesthesia and Intensive Care, Helsingborg Hospital, Helsingborg, Sweden.

Correspondence: G. Lileikyte

Intensive Care Medicine Experimental 2023, 11(Suppl 1):000961

Introduction: Definition of temporal serum proteome profiles after out-of-hospital cardiac arrest may identify biological processes associated with severe hypoxia-ischemia and reperfusion. It may further explore intervention effects for new mechanistic insights, identify candidate prognostic protein biomarkers and potential therapeutic targets.

Objectives: This pilot study aimed to investigate serum proteome profiles from unconscious patients admitted to hospital after out-of-hospital cardiac arrest according to temperature treatment and neurological outcome.

Methods: Serum samples at 24, 48, and 72 h after cardiac arrest at three centres included in the Target Temperature Management after out-of-hospital cardiac arrest trial underwent data-independent acquisition mass spectrometry analysis (DIA-MS) to find changes in serum protein concentrations associated with neurological outcome at 6-month follow-up and targeted temperature management (TTM) at 33 °C as compared to 36 °C. Neurological outcome was defined according to Cerebral Performance Category (CPC) scale as “good” (CPC 1–2, good cerebral performance or moderate disability) or “poor” (CPC 3–5, severe disability, unresponsive wakefulness syndrome or death).

Results: Of 78 included patients [mean age 66 ± 12 years, 62 (80.0%) male], 37 (47.4%) were randomised to TTM at 36 °C. Six-month outcome was poor in 47 (60.3%) patients. The DIA-MS analysis identified and quantified 403 unique human proteins. Differential protein abundance testing comparing poor to good outcome showed 19 elevated proteins in patients with poor outcome (log₂ fold change (FC) range 0.28–1.17) and 16 reduced proteins (log₂(FC) between -0.22 and -0.68), involved in inflammatory/immune responses and apoptotic signalling pathways for poor outcome and proteolysis for good outcome (Figure 1 a-b). Analysis according to level of TTM showed a significant protein abundance difference for six proteins (five elevated proteins in TTM 36 °C (log₂(FC) range 0.33–0.88), one reduced protein (log₂(FC) -0.6)) mainly involved in inflammatory/immune responses only at 48 h after cardiac arrest, with no significant changes during temperature intervention (Figure 1c). In an interaction analysis between neurologic outcome and temperature target, a significant association for the antioxidant extracellular superoxide dismutase was shown. Extracellular superoxide dismutase was elevated in patients with a poor outcome treated at a target temperature of 36 °C.

Conclusions: Serum proteome profiling revealed an increase in inflammatory/immune responses and apoptosis in patients with poor outcome. In patients with good outcome, an increase in proteolysis was observed, whereas TTM-level only had a modest effect on the proteome profiles. Further validation of the differentially abundant proteins in response to neurological outcome is necessary to validate novel biomarker candidates that may predict prognosis after cardiac arrest.

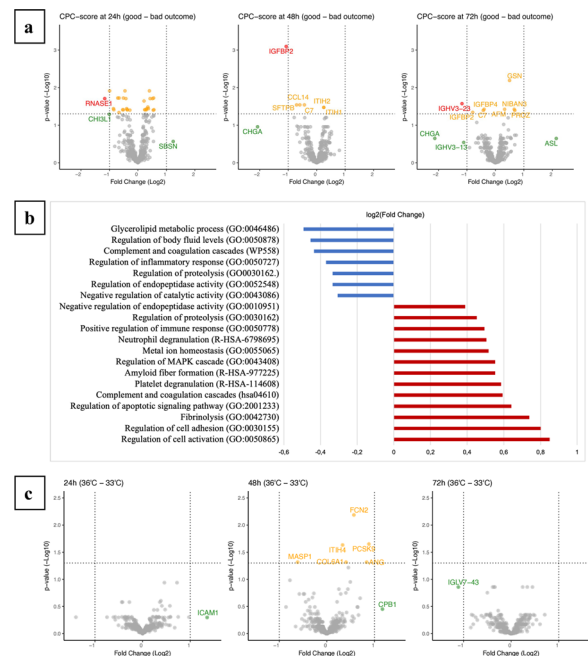

Figure 1 (abstract 000961) Proteomic analysis results for protein abundance according to neurological outcome and temperature treatment. **a**) Volcano plots for the differential abundance of proteins for neurological outcome at 24, 48, and 72 h. Positive log₂(FC) indicates good outcome, negative log₂(FC) indicates poor outcome. Statistically significant proteins (adjusted p-value ≤ 0.05) and regulated proteins (absolute log₂(FC) > 1) are labeled in red. Proteins with a significant adjusted p-value with a log₂(FC) between -1 and 1 are labeled in yellow, and statistically nonsignificant proteins with an absolute log₂(FC) < -1 or > 1 are labeled in green. **b**) Proteins enhanced for neurological outcome were annotated by selected gene ontology terms for biological process. The average log₂(FC) for all proteins included in each term is plotted to show the direction of average change for poor outcome (in red) as compared to good outcome (in blue). **c**) Volcano plots for the differential abundance of proteins between temperature treatment of 36 °C to 33 °C at 24, 48, and 72 h. Positive log₂(FC) indicates treatment with 36 °C, negative log₂(FC) indicates treatment with 33 °C. Proteins with a significant adjusted p-value with a log₂(FC) between -1 and 1 are labeled in yellow, and statistically nonsignificant proteins with an absolute log₂(FC) < -1 or > 1 are labeled in green. Abbreviations: CPC – Cerebral Performance Category; AFM – Afamin; ANG – Angiogenin; ASL—Argininosuccinate lyase; C7—Complement component C7; CCL14—C–C motif chemokine 14; CHGA—Chromogranin-A; CHI3L1—Chitinase-3-like protein 1; COL6A—Collagen alpha-1(VI) chain; CPB1—Carboxypeptidase B; FCN2 – Ficolin-2; GSN – Gelsolin; ICAM1 – Intercellular adhesion molecule 1; IGFBP2—Insulin-like growth factor-binding protein 2; IGFBP4—Insulin-like growth factor-binding protein 4; IGHV3-13—Immunoglobulin heavy variable 3-13; IGHV3-23—Immunoglobulin heavy variable 3-23; IGLV7-43—Immunoglobulin lambda variable 7-43; ITIH1—Inter-alpha-trypsin inhibitor heavy chain H1; ITIH2—Inter-alpha-trypsin inhibitor heavy chain H2; ITIH4—Inter-alpha-trypsin inhibitor heavy chain family member 4; MASP1—Isoform 2 of Mannan-binding lectin serine protease 1; NIBAN3—Protein Niban 3; PCSK9—Proprotein convertase subtilisin/kexin type 9; PROZ—Vitamin K-dependent protein S; RNASE1—Ribonuclease pancreatic; SBSN—Suprabasin; SFTPB—Pulmonary surfactant-associated protein B.

References

1. Funding for the study was provided by the Swedish Research Council, Swedish Heart Lung Foundation, Arbetsmarknadens Försäkringsaktiebolag Insurance Foundation, the Skåne University Hospital Foundations, the Gyllenstierna-Krapperup Foundation, and governmental funding of clinical research within the Swedish National Health System, the County Council of Skåne; the Swedish Society of Medicine; the Koch Foundation; TrygFonden (Denmark); European Clinical Research Infrastructures Network; Thelma Zoega Foundation; Stig and Ragna Gorthon Foundation; Thure Carlsson Foundation; Hans-Gabriel and Alice Trolle-Wachtmeister Foundation for Medical Research; the Swedish Brain Foundation; the Lundbeck Foundation; and the Torsten Söderberg foundation at the Royal Swedish Academy of Sciences. The funders had no role in study design, data collection and interpretation, or the decision to submit the work for publication.

Topic: Cardiac arrest

000962

Regional citrate anticoagulation for continuous renal replacement therapy in the intensive care unit; its' use in patients with shock

A. Duffy¹, E. Carter¹, D. Reddan¹, B. McNicholas²¹Critical Care, University Hospital Galway, Galway, Ireland; ²Intensive Care Unit, Galway University Hospital, Galway, Ireland

Correspondence: A. Duffy

Intensive Care Medicine Experimental 2023, 11(Suppl 1):000962

Introduction: Common anticoagulation strategies in continuous renal replacement therapy (CRRT) are regional citrate anticoagulation (RCA), unfractionated heparin (UFH), and no anticoagulation. The *KDIGO Clinical Practice Guideline for AKI 2012*(1) recommend using RCA, rather than UFH, as first choice anticoagulation for patients without contraindications to RCA. Citrate toxicity is a major complication of RCA (2). Hyperlactatemia predicts RCA accumulation (3), and therefore, universal RCA prescription for CRRT as per current guidelines, may be inappropriate in patients with severe hypoperfusion states, particularly cardiogenic and septic shock.

Objectives: To assess the effect of anticoagulation strategies (RCA, UFH and Nil) in CRRT on haemodynamic status in critically ill AKI patients with shock.

Methods: A retrospective study was carried out in a single tertiary referral centre ICU in Ireland. Data were collected retrospectively from the ICU Electronic Clinical Information System database (Metavision®). The patient cohort included all patients admitted to ICU who received CRRT in 2021 – 93 patients were identified. Demographics, ICU admission indication (categorised by organ failure support type), the presence of shock on CRRT commencement, CRRT anticoagulation type and patient outcomes (including ICU length of stay, and mortality) were all recorded from the database. Vasopressor requirements were recorded on ICU admission and on CRRT commencement. Peak vasopressor requirements within 24 h of CRRT start were also recorded. A Noradrenaline Equivalence (NAE) was calculated for all three aforementioned times.

Results: 93 patients (mean age, 63 years; 69.9% male) were included in the study, categorised by anticoagulation subgroup:

Table 1 (abstract 000962) Anticoagulation Subgroups and ICU Length of Stay (LOS)

Anticoagulant	Number of patients (%)	ICU LOS (days)
RCA	49 (52.7%)	14.38
Nil anticoagulation	19 (20.4%)	5.95
Heparin anticoagulation	11 (11.8%)	9.22
RCA switch	9 (9.7%)	15.24
Nil to anticoagulation switch	5 (5.4%)	16.32

In-ICU mortality occurred in 12 RCA (24.5%, mean 11.92 days), 3 heparin (27.3%, mean 6.11 days), and 10 Nil anticoagulation patients (52.6%, mean 2.58 days). Vasopressor requirements were present in 67.3% RCA (mean NAE 0.262 mcg/kg/min), 45.5% heparin (mean NAE 0.290 mcg/kg/min) and 79.0% nil anticoagulation (mean NAE 0.330 mcg/kg/min) commencing CRRT, increasing to 77.6%, 63.6%, and 89.5%, respectively, within a 24 h period post-commencement. Peak vasopressor requirements in a 24-h-period post CRRT commencement were lower in the RCA group (mean NAE 0.353 mcg/kg/min) than heparin (mean NAE 0.432 mcg/kg/min) or nil anticoagulation (0.465 mcg/kg/min).

Conclusions: This study is ongoing, however, preliminary findings suggest that in critically ill patients with AKI and shock receiving CRRT, RCA does not exacerbate haemodynamic compromise with respect to heparin or nil anticoagulation.

References

1. KDIGO Group, 2012. KDIGO clinical practice guideline for acute kidney injury. *Kidney Int. Suppl.*, 2, p.1.
2. Not applicable – no grants were obtained for the purposes of this study.
3. Tan, J.N., Haroon, S.W.P., Mukhopadhyay, A., Lau, T., Murali, T.M., Phua, J., Tan, Z.Y., Lee, N. and Chua, H.R., 2019. Hyperlactatemia predicts citrate intolerance with regional citrate anticoagulation during continuous renal replacement therapy. *Journal of Intensive Care Medicine*, 34(5), pp.418–425.
4. Schneider, A.G., Journois, D. and Rimmelé, T., 2017. Complications of regional citrate anticoagulation: accumulation or overload?. *Critical Care*, 21, pp.1–7.

Topic: Acute Kidney Injury and haemofiltration

000963

Prognostic factors related to in-hospital mortality in oncohematological patients admitted to the intensive care unit

J. P. Copa Morales¹, B. Mariblanca-Nieves¹, J. E. Romo Gonzales¹, V. Ruiz de Santaquiteria Torres¹, N. Agurto-Rivera¹, W. Chas Brami¹, N. Arriero Fernández¹, Z. Eguileor Marín¹, A. Albaya Moreno¹, R. Viejo Moreno¹, G.A. González Wagner¹, P. C. Benito¹, J. A. Silva Obregón¹, C. Marian Crespo¹
¹Intensive Care Unit, Hospital Universitario de Guadalajara, Guadalajara, Spain

Correspondence: J.P. Copa Morales

Intensive Care Medicine Experimental 2023, 11(Suppl 1):000963

Introduction: In the last decades, the survival of cancer patients has increased exponentially. Taking this fact into account, more cancer patients are admitted to out intensive care units.

Objectives: The main outcome is to analyze the factors related to in-hospital mortality (ICU and hospital ward less than 1 month after discharge from ICU) of oncohaematological patients in the intensive care unit with an active diagnosis of: solid organ tumor, lung neoplasia or haematological malignancies.

Methods: Retrospective descriptive study of oncohematological patients admitted for medical, surgical or coronary reasons in the intensive care unit in the period 2017–2022.

Sociodemographic, clinical-analytical and mortality parameters are described. In addition, specific scales related to oncohematology were calculated: ECOG (quality of life), and MASCC (infectious complications); as well as the Charlson comorbidity scale and the APACHE II prognostic classification scale.

Differences between survivors and deaths (intra-ICU and/or in the first month after being discharged to the ward) were analyzed using statistical analysis with Pearson's Chi-square test or Fisher's exact test for qualitative variables or t-Student's test and Levene's test for quantitative variables. The required significance threshold was 0.05.

Results: A total of 81 patients were included: solid tumors (n=31), lung (n=7) and hematological malignancies (n=43). A total of 33 patients died during their stay in the ICU or in less than a month on the hospital ward.

In the qualitative variables analysis, we found a statistical association between the probability of hospital death and the following variables: treatment with antibiotics in the 48 h prior to admission (OR 4.375; 95% CI 1.640–11.673), neutropenia (OR 3.193; 95% CI 1.174–8.688), hypotension on admission (MAP < 60 mmHg) (OR 2.667; 95% CI 1,029–6,912), the connection to MV (OR 2,889; 95% CI 1,051–7,938) and the duration of MV both in the first 24 h of admission (OR 2,875; 95% CI 1,082–7,367) as beyond 24 h (OR 2.917; 95% CI 1.570–7.311), the diagnosis of ARDS (OR 11.556; 95% CI 4,025–33,175), the prone maneuver (OR 5.5; 95% CI 1,570–19,226) and the use of CRRT (OR 3,807; 95% CI 1,315–11,022).

Table 1 (abstract 000954) Statistically significant quantitative variables

VARIABLES	DEATHS	SURVIVORS	DIFFERENCE OF MEANS	CONFIDENCE INTERVAL(95%)	STATISTICAL SIGNIFICANCE
AGE	60,08	65,55	-5,46	0,43–10,50	0,031
MASCC SCALE	10,46	13,42	-2,78	0,35–5,20	0,02
RESPIRATORY RATE	27,06	22,08	4,97	1,63–8,31	0,006
HEART RATE	107,42	96,71	10,71	0,58–20,845	0,038
GLASGOW COMA SCORE	14,39	12,73	1,66	0,02–3,30	0,026
PLATELETS (MM3)	86,515,15	176,068,75	-89,553,59	51,66–127,452,19	0,001
PCR (MG/L)	226,68	103,35	123,32	26,78–70,01	0,001
LDH (U/L)	582,45	402,29	180,16	60,01–300,31	0,004
FIO2	93,27	65,63	27,64	15,14–40,14	0,001

Conclusions: The factors associated with the probability of death in oncohematological patients are diverse, highlighting the use of invasive respiratory support, shock on admission, CRRT and the MASCC scale.

Topic: Haematologic-oncologic issues in the ICU.

000965

Nitroglycerin infusion improves peripheral perfusion of patients with septic shock

V. B. Felice¹, M. Buhler¹, G. H. Schuster¹, R. B. D. Moraes², J. Bakker³, G. Friedman⁴

¹Intensive Care Unit, Moinhos de Vento Hospital, Porto Alegre, Brazil; ²Intensive Care Unit, Hospital de Clínicas de Porto Alegre, Porto Alegre, Brazil; ³Department of Intensive Care Adults, Erasmus University Medical Center, Rotterdam, Netherlands; ⁴Post-graduation program in pneumological sciences, department of internal medicine, School of Medicine, Universidade Federal do Rio Grande do Sul, Porto Alegre, Brazil

Correspondence: M. Buhler

Intensive Care Medicine Experimental 2023, **11(Suppl 1)**:000965

Introduction: Sepsis and its most severe form, septic shock, has a high fatality rate as a consequence of the evolution to multiorgan dysfunction. A possible explanation for the development of organ dysfunction is the persistence of tissue hypoperfusion, even after the restoration of macrohemodynamic parameters. In addition, improved microcirculation in patients with septic shock appears to be associated with lower mortality. Initial experimental and clinical studies with vasodilator drugs like nitroglycerin suggest that it is possible to improve tissue perfusion in shock states (8–12). The rationale for using vasodilators such as nitroglycerin is based on the potential to recruit microcirculation and lead to improved flow in the microcapillary network. Monitoring peripheral perfusion is a good alternative to assess tissue perfusion and appears to be attractive to assess the effects of

nitroglycerin in septic shock after reaching macrohemodynamic resuscitation targets.

Objectives: To assess whether infusion of nitroglycerin in patients with septic shock improves capillary refill time within the first 24 h of shock diagnosis.

Methods: Prospective interventional pilot study in patients with septic shock admitted to the Intensive Care Units of the Hospital Santa Casa de Porto Alegre. Inclusion criteria: patients > 18 years, with septic shock (norepinephrine need after fluid replacement), with mean arterial pressure (MAP) \geq 65 mmHg, who persist with hyperlactatemia (> 2.0 mmol/l) and capillary refill time (CRT) > 5 s. Informed consent obtained from the legal guardian. Protocol: Initial infusion of 2 mg/h of nitroglycerin (T0), the dose being doubled every 15 min up to a maximum of 16 mg/h in 45 min (T45). Hemodynamic parameters and CRT were evaluated at the same time intervals (T0, T15, T30, T45, T60) and after 30 min of infusion suspension (T90).

Results: 10 patients were included. In one patient NTG was stopped after the start of the infusion and in another patient at increasing the dose from 8 mg/h to 16 mg/h. CRT decreased for nine patients at T60 (T0: 6.5 ± 0.7 s vs. T60: 3.6 ± 0.9 s, $p < 0.001$). Six patients normalized the CRT (≤ 3 s). The norepinephrine dose (T0: 0.52 ± 0.20 mcg/kg/h vs. T60: 0.53 ± 0.23 mcg/kg/h, $p = \text{NS}$) and MAP (T0: 77 ± 6 mmHg vs. T60: 69 ± 6 mmHg, $p = \text{NS}$) remained stable.

Conclusions: Nitroglycerin infusion was shown to be effective to improve capillary refill time in patients with septic shock.

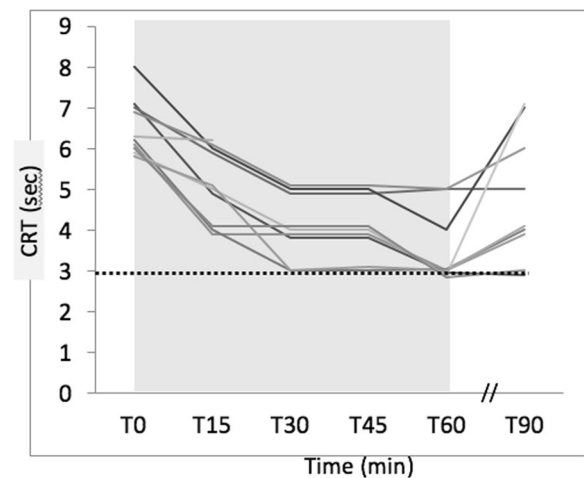

Figure (abstract 000954) Individual time course of capillary refill time (CRT) during the study protocol. Time points are defined as before the start of nitroglycerin infusion (T0), T15, T30, T45 (every 15 min increase in nitroglycerin infusion), T60 maximum dose of nitroglycerin (16mg/h), and after 30 min the end of the nitroglycerin infusion (T90). the dotted line signals the normal value for the CRT. ANOVA for repeated measures # $p < 0.001$ T60 vs initial value (Tukey)

References

- Hernández G, Ospina-Tascón GA, Damiani LP, Estenssoro E, Dubin A, Hurtado J, et al. Effect of a Resuscitation Strategy Targeting Peripheral Perfusion Status vs Serum Lactate Levels on 28-Day Mortality Among Patients With Septic Shock: The ANDROMEDA-SHOCK Randomized Clinical Trial. *JAMA*. 2019 Feb 19;321(7):654–664. doi: <https://doi.org/10.1001/jama.2019.0071>. PMID: 30772908; PMCID: PMC6439620
- Jansen TC, van Bommel J, Schoonderbeek FJ, Sleswijk Visser SJ, van der Klooster JM, Lima AP, et al. Lactate study group. Early lactate-guided therapy in intensive care unit patients: a multicenter, open-label, randomized controlled trial. *Am J Respir Crit Care Med*. 2010 Sep 15;182(6):752–761. doi: <https://doi.org/10.1164/rccm.200912-1918OC>. Epub 2010 May 12. PMID: 20463176
- Lima A, van Genderen ME, van Bommel J, Klijn E, Janssen T, Bakker J. Nitroglycerin reverts clinical manifestations of poor peripheral perfusion

- in patients with circulatory shock. *Crit Care*. 2014 Jun 19;18(3):R126. doi: <https://doi.org/10.1186/cc13932>. PMID: 24946777; PMCID: PMC4229779
- Trzeciak S, McCoy JV, Phillip Dellinger R, Arnold RC, Rizzuto M, Abate NL, et al. Microcirculatory Alterations in Resuscitation and Shock (MARS) investigators. Early increases in microcirculatory perfusion during protocol-directed resuscitation are associated with reduced multi-organ failure at 24 h in patients with sepsis. *Intensive Care Med*. 2008 Dec;34(12):2210–2217. doi: <https://doi.org/10.1007/s00134-008-1193-6>. Epub 2008 Jul 2. PMID: 18594793; PMCID: PMC2821162.
 - Sakr Y, Dubois MJ, De Backer D, Creteur J, Vincent JL. Persistent microcirculatory alterations are associated with organ failure and death in patients with septic shock. *Crit Care Med*. 2004 Sep;32(9):1825–1831. doi: <https://doi.org/10.1097/01.ccm.0000138558.16257.3f>. PMID: 15343008.

Topic: Sepsis

000966

Association of significant elevation of NETosis and nucleosome biomarkers measured by volition Nu.Q® NETs assay with mortality in patients with septic shock

M. Haem¹, F. Bidar¹, A. C. Lukaszewicz², L. Garnier¹, L. Payen-Gay¹, J. Candiracci³, R. Rabeuf³, M. Herzog³, F. Venet⁴, G. Monneret⁴
¹Université Lyon 1, Hospices Civils de Lyon - HCL, Lyon, France;
²Anesthesia & critical care, Hospital Édouard Herriot, Lyon, France; ³R&D, Belgian Volition, Gembloux, Belgium; ⁴Immunology lab, Hospices Civils de Lyon, Lyon, France

Correspondence: G. Monneret

Intensive Care Medicine Experimental 2023, **11(Suppl 1)**:000966

Introduction: Association of Significant Elevation of NETosis and Nucleosome Biomarkers measured by Volition Nu.Q® NETs assay with Mortality in Patients with Septic Shock

Objectives: **Introduction:** Understanding the mechanisms underlying immune dysregulation in sepsis is a major challenge. In vivo development, more individualized therapy, as early and persistent inflammation, as well as immunosuppression, play a significant role in pathophysiology. Neutrophils, release extracellular traps (NETs) as part of the antimicrobial response, which can neutralize and kill microorganisms. However, excessive NETosis may also contribute to pathogenesis, tissue damage and organ dysfunction. This process has been hypothesized to be associated with severity and mortality. Recently, a novel automated assay has been proposed for the routine measurement of nucleosomes, which are fundamental units of chromatin that are released during NETosis.

Objective: The aim was to measure nucleosome levels in septic shock patients and to determine association with mortality.

Methods: 151 septic shock patients (SEPSIS-3 definition, IMMUNOSEPSIS cohort) were included. Plasma samples were obtained at 3 time-points (day (D) 1–2, D 3–4, D 5–8 after admission). Nucleosomes were measured using the chemiluminescent Nu.Q® NETs immunoassay, CE-IVD (Belgian Volition SRL, Belgium). IL-6 was measured with Ella automated immunoassay system (Bio-Techne). Immunological cellular parameters were measured by flow cytometry (Beckman Coulter).

Results: Main patients' characteristics were (as median): age (69), SAPS II (65), SOFA (10), day-28 mortality 45%. Immunological parameters indicated early inflammation (IL-6 = 1335 pg/mL at D 1–2) along with marked immunosuppression (e.g., mHLA-DR = 3853 AB/C and CD4 lymphocytes = 338 /μL at D 3–4). The nucleosome levels were markedly and significantly elevated at all-time points compared to the control group (Fig. 1A). We found significantly positive correlation between nucleosome levels and organ failure and severity scores, IL-6 concentrations and neutrophil count. Significantly higher values (D 1–2 & 3–4) were measured in non-survivor patients (28-day mortality, Fig. 1B). This association was still significant after multivariate analysis and was more pronounced with highest concentration (upper quartile, Fig. 1C). Early (D 1–2) increased nucleosome levels were also independently associated with D5 mortality. At D 5–8, persistent elevated nucleosome levels were negatively correlated to mHLA-DR values.

Conclusions: This study is the first to concomitantly investigate both nucleosomes and immunological parameters in septic shock, and it reports a significant elevation of nucleosome in patients during a one-week follow-up. The nucleosome levels showed correlation with neutrophil count and IL-6 and were found to be independently associated with mortality on day 5 and 28. Therefore, nucleosomes measured by Nu.Q® NETs seems to be a promising biomarker for detecting hyper-inflammatory phenotype upon a patient's admission. Additional investigations are required to evaluate the potential association between NETosis, sustained elevation of nucleosome and the development of sepsis-induced immunosuppression.

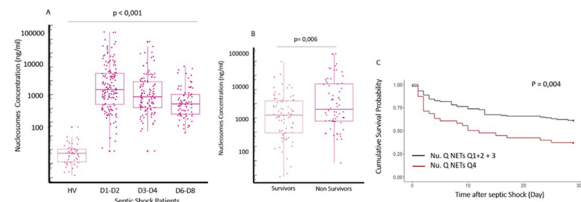

Fig. 1. (A) Level of circulating nucleosome in septic shock patients (n = 151) during first week after ICU admission and healthy volunteers (n = 50), D 1-2 (n = 151), D 3-4 (n = 116) and D 6-8 (n = 78). (B) Nucleosome concentration at D1-2 depending on 28-day mortality (C) Kaplan-Meier curves depicting cumulative incidence of mortality stratified on D1-2 nucleosome concentrations (Q4 = highest quartile vs Q1+Q2+Q3 quartiles).

Figure 1 (abstract 000966) .

References

- Neutrophils and NETs in modulating acute and chronic inflammation. Castanheira FVS, Kubers P. *Blood*. 2019;133:2178–2185.
- NETosis and Nucleosome Biomarkers in Septic Shock and Critical COVID-19 Patients: An Observational Study Morimont et al. *Biomolecules* 2022;12:1038.

Topic: Sepsis

000967

Role of different driving pressure levels and respiratory rate on ventilator induced lung injury in healthy rats undergoing mechanical ventilation

D. Raimondi Cominesi¹, L. Moretto¹, V. Zambelli¹, G. Foti¹, R. Fumagalli¹, G. Bellani², E. Rezoagli¹
¹School of medicine and surgery, University of Milano-Bicocca, Monza, Italy; ²CISMed—Centre for Medical Sciences, University of Trento, Trento, Italy

Correspondence: D. Raimondi Cominesi

Intensive Care Medicine Experimental 2023, **11(Suppl 1)**:000967

Introduction: Mechanical ventilation (MV) is a life support technique in critically ill patients. However, it may lead to ventilator-induced lung injury (VILI). The contribution of driving pressure (DP) and respiratory rate (RR) to VILI was recently reported in patients according to the mathematical formula $4DP + RR$ (2). However, different combination of DP and RR providing the same $4DP + RR$ were not tested in healthy lungs to assess whether they could differently contribute to VILI.

Objectives: The aim of the study is to explore whether DP and RR could differently contribute to VILI despite keeping the same $4DP + RR$ in an experimental model of healthy rats.

Methods: Rats were anesthetized and mechanically ventilated for 4 h with different ventilatory strategies depending on the experimental group and keeping constant $4DP + RR = 140$ as follows: Group 1, DP 10 and RR 100 (n = 4); Group 2, DP 20 and RR 60 (n = 4); Group 3, DP 25 and RR 40 (n = 4); Group 4, DP 30 and RR 20 (n = 4). Other ventilatory parameters were set as follows: I/E 50%, PEEP 2 cmH₂O, and FiO₂ 1.0. A group of healthy non-anesthetized rats was used as control. A recruitment maneuver was performed each hour (30 cmH₂O × 10 s). Hemodynamics and airway pressure were monitored during MV. At

4 h, arterial blood gas analysis and respiratory system static compliance (Cpl,rs) were evaluated; a lobe from right lung was removed for wet to dry ratio (W/D); a lung micro-CT scan and bronchoalveolar lavage (BAL) were performed to evaluate lung density and cell count, respectively.

Results: After 4 h of MV, Group 4 showed a significant reduction in PaO₂/FiO₂ as compared to other groups and trended to a lower Cpl,rs. Edema was more pronounced in Group 4 and – accordingly – lung density was the highest among the groups by the CT evaluation (Table). The number of polymorphonuclear cells (PMNs) in BAL increased over increasing levels of DP and were significantly higher in Group 3 and 4 (Figure).

Table (abstract 000967) Pulmonary function (PaO₂/FiO₂ and Cpl,rs), Edema (W/D) and micro-CT scan after 4 h of MV. *p<0.05 vs Healthy, Group 1, Group 2 and Group 3

	Healthy	Group 1 DP10RR100	Group 2 DP20RR60	Group 3 DP25RR40	Group 4 DP30RR20	ANOVA
PaO ₂ /FiO ₂ (mmHg)	526 ± 24	403 ± 53	432 ± 55	474 ± 29	98 ± 38 *	P < 0.001
Cpl,rs (ml/ cmH ₂ O)	0.55 ± 0.07	0.38 ± 0.07	0.46 ± 0.03	0.44 ± 0.03	0.28 ± 0.10	p = 0.125
W/D	5.77 ± 0.34	6.39 ± 0.40	6.24 ± 0.25	7.04 ± 0.45	11.54 ± 0.82*	p < 0.001
CT (HU)	-570 ± 10	-457 ± 63	-396 ± 52	-406 ± 63	-165 ± 112	p = 0.049

Conclusions: At 4 h, in an experimental model of healthy rats undergoing mechanical ventilation by changing the levels of DP and RR contribution within the same 4DP + RR, the group with the higher DP showed a lower Cpl,rs, lower oxygenation, higher lung edema, density and PMNs infiltrates as compared to the other groups. BAL PMNs seem to gradually increase over increasing levels of DP, while respiratory mechanics, lung weight and density seem to remain stable in the presence of a DP < 25. A higher DP seems a stronger contributor to VILI as compared to a higher RR despite keeping the same 4DP + RR.

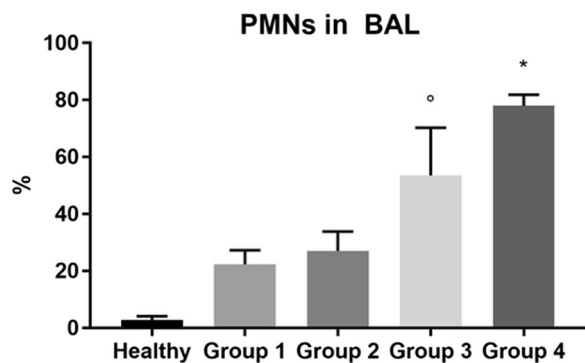

Figure (abstract 000954) PMNs in BAL after 4 h of MV. ANOVA p = 0.0005. *p < 0.05 vs Healthy, Group 1, Group 2. °p < 0.05 vs Healthy and Group 1. BAL = bronchoalveolar lavage; PMNs = polymorphonuclear cells

References

- Costa ELV, et al. Ventilatory Variables and Mechanical Power in Patients with Acute Respiratory Distress Syndrome. *American journal of respiratory and critical care medicine*. 2021;204(3).
- Rezoagli E, et al. Monitoring Lung Injury Severity and Ventilation Intensity during Mechanical Ventilation. *Seminars in respiratory and critical care medicine*. 2022;43(3).

Topic: Acute respiratory failure and mechanical ventilation.

000970

Effect of a low vs intermediate tidal volume strategy on pulmonary complications in patients at risk of ARDS

M. Sonia¹, M. Noto Fabregas¹, N. A. Serpa², G. Gomà³, M. E. González González⁴, A. Ortega López⁵, C. Forteza⁶, F. Frutos-Vivar⁷, R. García⁸, F. D. Simonis⁹, F. Gordo Vidal¹⁰, D. Suarez¹, M. J. Schultz¹¹, A. Artigas¹², C. De Haro¹³

¹Intensive Care Unit, Hospital Parc Taulí Sabadell, Sabadell, Spain;

²Australian and New Zealand Intensive Care–Research Centre, Monash University, Melbourne, Australia; ³Àrea de crítics, Parc Taulí Hospital Universitari. Institut d'Investigació i Innovació Parc Taulí (I3PT), Sabadell, Spain; ⁴Icu, Torrejón University Hospital, Torrejón de Ardoz, Spain;

⁵Intensive Care, Hospital Puerta de Hierro-Majadahonda, Majadahonda, Spain; ⁶Intensive Care Unit, Hospital Son Llàtzer, Palma de Mallorca, Spain, palma, Spain; ⁷Intensive Care Unit, Getafe University Hospital, Getafe, Spain; ⁸Reanimation Unit, Hospital Universitario 12 de Octubre, Madrid, Spain, Madrid, Spain; ⁹Department of Intensive Care, Amsterdam University Medical Centers, Location 'AMC', Amsterdam, The Netherlands, Amsterdam, Netherlands; ¹⁰Intensive Care Unit, H. U del Henares, Madrid, Spain; ¹¹Intensive care, Academic Medical Centre, Amsterdam, Netherlands; ¹²Department of intensive care medicine, Corporacion Sanitaria Universitaria Parc Tauli, Barcelona, Spain; ¹³Àrea de crítics., Parc Taulí Hospital Universitari. CIBER Enfermedades Respiratorias. ISCIII, Sabadell, Spain

Correspondence: M. Sonia

Intensive Care Medicine Experimental 2023, **11(Suppl 1)**:000970

Introduction: Invasive mechanical ventilation is a commonly applied support in critically ill patients with acute respiratory failure. While often life-saving, it has the potential to induce lung injury, especially when too large tidal volumes (VT) are used in patients with existing lung injury, i.e., in patients with acute respiratory distress syndrome (ARDS). There is no consensus on whether ventilation with low VT prevents lung injury in patients at risk of ARDS.

Objectives: To determine whether a low tidal volume (VT) strategy is more effective than an intermediate VT strategy in preventing pulmonary complications in patients at risk of ARDS development.

Methods: A randomized clinical trial was conducted in invasively ventilated patients with a Lung Injury Prediction Score (LIPS) > 4 performed in the intensive care units of ten hospitals in Spain and one in the United States of America (USA) from November 3, 2014 till August 30, 2016. Patients were randomized to invasive ventilation using low VT (≤ 6 ml/kg predicted body weight, PBW) (N = 50) or intermediate VT (> 8 ml/kg PBW) (N = 48). The primary endpoint was development of ARDS during the first 7 days after start of invasive ventilation. Secondary endpoints included development of pneumonia and severe atelectases; length of Intensive Care Unit (ICU) and hospital stay; and ICU, hospital, 28- and 90-day mortality. For analysis of the primary endpoint, risk ratio and the 95% confidence intervals (CI) calculated with the Wald likelihood ratio approximation test and Fisher exact tests for hypothesis testing was used. Secondary binary outcomes, were also reported as risk ratio and 95% CI calculated with the Wald likelihood ratio approximation test and Fisher exact tests.

Results: In total, 98 patients [67.3% male], with a median age of 65.5 years [interquartile range 55–73], were enrolled until the study was prematurely stopped because of slow recruitment and loss of equipoise caused by recent study reports. At day 7, 5 (11.9%) patients in the low VT group, and 4 (9.1%) patients in the intermediate VT group had developed ARDS (risk ratio, 1.16 [95% CI, 0.62–2.17]; P = 0.735). The incidence of pneumonia and severe atelectasis was also not different between the two groups. Use of a low VT strategy did neither affect length of ICU and hospital stay nor mortality rates.

Conclusions: In patients at risk for ARDS, a low VT strategy did not result in a lower incidence of ARDS than an intermediate VT strategy.

References

1. Ranieri VM, Rubenfeld GD, Thompson BT, Ferguson ND, Caldwell E, Fan E, et al. Acute respiratory distress syndrome: The Berlin definition. *JAMA*. 2012 Jun 20;307(23):2526–33.
2. Eisenhuber E, Schaefer-Prokop CM, Prosch H, Schima W. Bedside chest radiography. *Respir Care*. 2012 Mar;57(3):427–43.
3. Simonis FD, Serpa Neto A, Binnekade JM, Braber A, Bruin KCM, Determann RM, et al. Effect of a Low vs Intermediate Tidal Volume Strategy on Ventilator-Free Days in Intensive Care Unit Patients Without ARDS: A Randomized Clinical Trial. *JAMA*. 2018 Nov 13;320(18):1872–80.
4. Determann RM, Royakkers A, Wolthuis EK, Vlaar AP, Choi G, Paulus F, et al. Ventilation with lower tidal volumes as compared with conventional tidal volumes for patients without acute lung injury: A preventive randomized controlled trial. *Crit Care*. 2010;14(1):R1.
5. Gajic O, Dara SI, Mendez JL, Adesanya AO, Festic E, Caples SM, et al. Ventilator-associated lung injury in patients without acute lung injury at the onset of mechanical ventilation. *Crit Care Med*. 2004 Sep;32(9):1817–24.
6. Simonis FD, Neto AS, Schultz MJ. The tidal volume fix and more... *J Thorac Dis*. 2019 Aug;11(8):E117–22.
7. Brower RG, Matthay MA, Morris A, Schoenfeld D, Thompson BT, Wheeler A. Ventilation with lower tidal volumes as compared with traditional tidal volumes for acute lung injury and the acute respiratory distress syndrome. *N Engl J Med*. 2000;342(18):1301–8.
8. Peñuelas O, Muriel A, Abaira V, Frutos-Vivar F, Mancebo J, Raymondos K, et al. Inter-country variability over time in the mortality of mechanically ventilated patients. *Intensive Care Med*. 2020;46(3):444–53.
9. Mehta AB, Syeda SN, Wiener RS, Walkey AJ. Epidemiological trends in invasive mechanical ventilation in the United States: A population-based study. *J Crit Care*. 2015 Dec;30(6):1217–21.
10. Trillo-Alvarez C, Cartin-Ceba R, Kor DJ, Kojicic M, Kashyap R, Thakur S, et al. Acute lung injury prediction score: Derivation and validation in a population-based sample. *Eur Respir J*. 2011;37(3):604–9.

Topic: Acute respiratory failure and mechanical ventilation

000971

Comparing simulation training of bronchoscopy-guided percutaneous dilatational tracheostomy: 3D printer simulator versus Conventional simulator (TRAC-Sim-Study)

M. Wegner¹, F. Dusse², B. Dorweiler¹, F. Beeser¹, N. Leister², M. Lefarth², R. S. Finke, B. W. Böttiger², S. E. Stoll²

¹Vascular and Endovascular Surgery, University of Cologne, Faculty of Medicine and University Hospital, Cologne, Germany;

²Anaesthesiology and Intensive Care Medicine, University of Cologne, Faculty of Medicine and University Hospital, Cologne, Germany.

Correspondence: S.E. Stoll

Intensive Care Medicine Experimental 2023, **11(Suppl 1)**:000971

Introduction: Bronchoscopy-guided percutaneous dilatational tracheostomy (BG-PDT) is a routine procedure in the ICU setting. However, complication rate is about 4% [1] and due to low individual implementation rate, most medical registrars feel unexperienced. This was dramatically revealed in the COVID19 pandemic when BG-PDT was required in critically ill ICU patients under extreme conditions. Simulation training can be an effective tool to reduce the stress level of the proceduralist and to improve the procedural safety for the patient and the operating team. [2, 3] However, there is little data about the efficiency of simulation training in BG-PDT. Moreover, the role of conventional simulators (Csim) versus simulators generated from 3D printers (3Dsim) in simulation scenarios for airway approaches remains controversial. [4, 5].

Objectives: Aim of this study was to assess the efficiency of simulation training in BG-PDT regarding procedural performance and perceived feelings of safety of the proceduralist. Moreover, goal of this study was to assess whether 3Dsim vs Csim is more efficient in simulating BG-PDT.

Methods: TRAC-Sim-Study was conducted as a prospective, randomized, blinded single center cross-over study comparing Csim vs 3Dsim (see image 1) for simulation training of BG-PDT by doctors / medical students. All participants received a standardized theoretical

training (30 min) and a questionnaire (previous implementation rate / perceived feeling of safety regarding BG-PDT). Participants were randomized to (a) Csim training (conventional tracheostomy simulator) or (b) 3Dsim training (models printed with PolyJet technology). Simulation training (20 min) was performed per standardized protocol. After simulation training, participants were assessed by 2 blinded examiners on a porcine tracheal model regarding (1) time required for completion of BG-PDT and (2) score achieved for correct performance. Moreover, participants received a second questionnaire (perceived benefit of simulation). Next, group (a) trained on simulator (b) and vice versa (cross-over design). This was followed by another blinded assessment on the porcine tracheal model/questionnaire (subjective evaluation of the 2 different simulators). The study was approved by the local Ethical Committee (22-1141_1).

Results: In this study, 44 participants (40 doctors, 4 medical students) were included: 24 participants initially trained with Csim and 20 participants with 3Dsim. There was no significant difference regarding sex, work experience (years), previous BG-PDT experience and perceived feelings of safety between both groups. Repetitive simulation training was able to significantly decrease mean procedural time ($p=0.01$) and to increase procedural scores ($p=0.03$) as well as experienced feelings of safety ($p=0.01$) in the post-simulation assessments in both groups with no significant difference between the groups. No participants' preference could be revealed for any of the 2 simulator types.

Conclusions: Simulation training can be beneficial in improving procedural skills in BG-PDT and in reducing procedural stress by increasing perceived feelings of safety. This is independent of the choice of the simulator (Csim or 3Dsim) for training. Larger, randomized multicenter long-term studies are required to prove this effect. Whether the implementation of further improvements of 3Dsim according to participants' feedback can improve efficiency of 3Dsim vs Csim remains to be investigated.

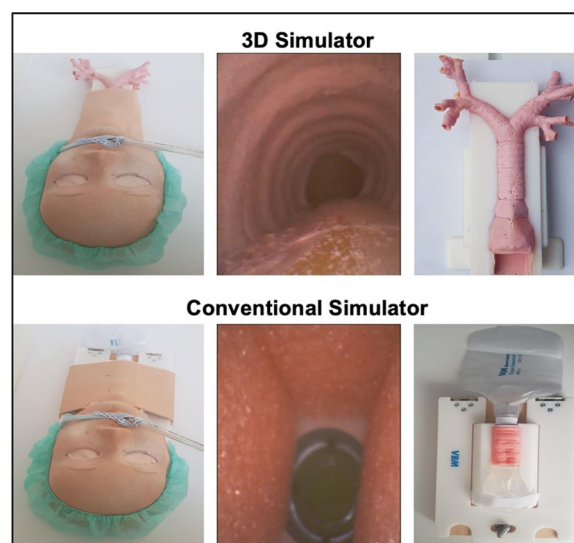

Image 1 (abstract 000971) 3D Simulator (3DSim) versus Conventional Simulator (CSim)

References

1. Dempsey, G.A., C.A. Grant, and T.M. Jones, Percutaneous tracheostomy: a 6 yr prospective evaluation of the single tapered dilator technique. *Br J Anaesth*, 2010. 105(6): p. 782–8.
2. Favier, V., et al., Percutaneous tracheostomy simulation training for ENT physicians in the treatment of COVID-19-positive patients. *Eur Ann Otorhinolaryngol Head Neck Dis*, 2020. 137(4): p. 333–338.
3. Boet, S., et al., Complex procedural skills are retained for a minimum of 1 yr after a single high-fidelity simulation training session. *Br J Anaesth*, 2011. 107(4): p. 533–9.

4. Gauger, V.T., et al., A multidisciplinary international collaborative implementing low cost, high fidelity 3D printed airway models to enhance Ethiopian anesthesia resident emergency cricothyroidotomy skills. *Int J Pediatr Otorhinolaryngol*, 2018. 114: p. 124–128.
5. Katayama, A., et al., A high-fidelity simulator for needle cricothyroidotomy training is not associated with increased proficiency compared with conventional simulators: A randomized controlled study. *Medicine (Baltimore)*, 2019. 98(8): p. e14665.
6. TRAC-Sim Study was supported by an Investment fund for "research and teaching" of University of Cologne, Faculty of Medicine and University Hospital Cologne, Germany

Topic: Acute respiratory failure and mechanical ventilation

000973

An outbreak of severe coagulopathy among users of illicit synthetic cannabinoids adulterated with brodifacoum: an ICU subgroup analysis

A. Miller¹, Y. Nadir², R. Hoffman², E. Efrati³, N. Bar⁴, G. Ring³, D. Sonenfeld⁵, H. Zaidani⁶, A. Strizevsky⁶, M. Asali⁷, O. Lavon⁸, D. Kurnik³, Y. Lurie³
¹Medical Intensive Care Unit, Rambam Healthcare Campus, Haifa, Israel; ²Thrombosis and Hemostasis Unit, Rambam Health Care Campus, Haifa, Israel; ³Section of Clinical Pharmacology and Toxicology, Rambam Health Care Campus, Haifa, Israel; ⁴Department of Radiology, Rambam Health Care Campus, Haifa, Israel; ⁵Police Forensic Laboratory, Israel police, Jerusalem, Israel; ⁶Emergency Medicine Unit, Rambam Health Care Campus, Haifa, Israel; ⁷Institute of Hematology, Hillel Yaffe Medical Center, Hadera, Israel; ⁸Clinical Pharmacology and Toxicology Unit, Carmel Medical Center, Haifa, Israel

Correspondence: A. Miller

Intensive Care Medicine Experimental 2023, **11(Suppl 1)**:000973

Introduction: Adulteration of illicit drugs of abuse is a well-known phenomenon that may expose consumers to unexpected adverse effects. During a 9-month period in 2021–2022 there was a large outbreak of a severe coagulopathy in northern Israel among users of synthetic cannabinoids adulterated with a long-acting anticoagulant, brodifacoum.

Objectives: Herein we describe the subgroup of patients who were admitted to the intensive care units (ICU) of the tertiary center (RMC) that cared for most of the patients affected.

Methods: We performed a retrospective cohort study based on data extracted from the Israeli National Poison Information Center database and the electronic medical patient records of patients admitted to our ICUs. Confiscated drug samples and blood samples obtained at admission in a subgroup of patients were tested for the presence of long-acting anticoagulants.

Results: We identified 98 patients affected by the outbreak. 47 patients were admitted to RMC, and 7 patients (15%) were admitted to one of 4 ICUs. All patients admitted to RMC ICUs had non-clotting blood on coagulation tests and their presenting complaint was overt bleeding in all, most commonly in the urinary (57%) and gastrointestinal tract (42%). Two patients presented with intracranial bleeding with intraventricular involvement. One required intraventricular drainage and the other died without intervention. One patient presented with pericardial bleeding and hemothorax requiring a chest drain. Three patients (42%) were mechanically ventilated, 2 patients developed hemorrhagic shock, and one patient died. Brodifacoum was detected in all available blood samples (median concentration, 201.0 ng/mL, IQR 105.0–335.9, range 19.1–1,117.8 ng/mL), and the drug samples contained both brodifacoum and the synthetic cannabinoid ADB-BUTINACA. All patients were treated by high-dose intravenous vitamin K1 and additionally by packed red blood cell transfusions, fresh frozen plasma, and/or 4-factor prothrombin complex concentrate when indicated. The most frequent vitamin K1 dose regimen was initially 20 mg intravenously every 8 h, and at discharge 20 mg orally three times daily.

Conclusions: Outbreaks of severe coagulopathies in users of synthetic cannabinoids adulterated with a long-acting anticoagulants continue to erupt in different regions of the world. Rapid recognition of an outbreak requires a high index of suspicion when confronting young, otherwise healthy subjects with otherwise unexplained severe coagulopathy. Severe cases may lead to intracranial hemorrhage, hemorrhagic shock and hemothorax and require ICU management and administration of high dose vitamin K1 and blood products.

References

1. Solimini R, Rotolo MC, Pellegrini M, et al. Adulteration Practices of Psychoactive Illicit Drugs: An Updated Review. *Curr Pharm Biotechnol* 2017;18(7).
2. Kelkar AH, Smith NA, Martial A, Moole H, Tarantino MD, Roberts JC. An Outbreak of Synthetic Cannabinoid–Associated Coagulopathy in Illinois. *N Engl J Med* 2018;379(13):1216–23.
3. Devgun JM, Rasin A, Kim T, et al. An outbreak of severe coagulopathy from synthetic cannabinoids tainted with Long-Acting anticoagulant rodenticides. *Clin Toxicol* 2020;58(8):821–8.
4. Watt BE, Proudfoot AT, Bradberry SM, Vale JA. Anticoagulant rodenticides. *Toxicol Rev* 2005;24(4):259–69.
5. World Health Organization & International Programme on Chemical Safety. Brodifacoum: Health and Safety guide [Internet]. World Heal. Organ. 1995 [cited 2023 Jan 31]; Available from: <https://apps.who.int/iris/handle/10665/36901>
6. Feinstein DL, Nosal DG, Ramanathan S, et al. Effects of vitamin K1 treatment on plasma concentrations of long-acting anticoagulant rodenticide enantiomers following inhalation of contaminated synthetic cannabinoids. *Clin Toxicol (Phila)* 2020;58(7):716–24.
7. Lubetsky A, Yonath H, Olchovsky D, Loebstein R, Halkin H, Ezra D. Comparison of Oral vs Intravenous Phytonadione (Vitamin K1) in Patients With Excessive Anticoagulation: A Prospective Randomized Controlled Study. *Arch Intern Med* 2003;163(20):2469–73.

Topic: Poisoning/Toxicology/Pharmacology

000974

The usefulness of filmarray as a diagnostic method for bacterial pneumonia

C. Alegre¹, I. Catalan¹, H. Baquerizo¹, Y. Tua¹, J. López², A. Bartes³, S. Cano¹, G. Trujillo², C. Subirà⁴, R. Fernandez²

¹Intensive Care Unit, Althaia, Xarxa Assistencial Universitària de Manresa, Manresa, Spain; ²Microbiology, Althaia, Xarxa Assistencial Universitària de Manresa, Manresa, Spain; ³Epidemiology, Althaia, Xarxa Assistencial Universitària de Manresa, Manresa, Spain; ⁴Critical care center, Fundació Althaia, Universitat Internacional de Catalunya, Manresa, CIBERES, Manresa, Spain; ⁵Intensive care unit, Fundació Althaia. Xarxa Assistencial Universitària de Manresa, Manresa, Spain.

Correspondence: C. Alegre

Intensive Care Medicine Experimental 2023, **11(Suppl 1)**:000974

Introduction: Early diagnosis of severe pneumonia and appropriate treatment is related to improved survival. The Film Array is a matrix in which the most common pathogens related to community and nosocomial pneumonia are analyzed through PCR. It has been shown to be a valid tool for early diagnosis, although its validity compared to culture (gold standard) is not yet well defined.

Objectives: -Explore the effectiveness of the Film Array as an early diagnostic tool for severe pneumonia versus conventional respiratory secretion culture (gold standard).

-Establish a cut-off point for a positive Film Array (cycles) and culture isolation.

Methods: A retrospective descriptive study was conducted based on lower respiratory tract cultures (BAS, BAL, CTT) obtained from patients with suspected pneumonia on mechanical ventilation who underwent respiratory Filmarray testing between January 2022–March 2023. The presence of legionella and pneumococcus antigenuria was also considered equivalent to positive culture.

Multiplex PCR (Filmarray® BioFire- A Biomérieux Company) was used for the Film Array.

The pneumonia criteria were based: Presence or progression of infiltrate reasonably excluding cardiac insufficiency or hypervolemia. Associated with at least one of the following variables: fever > 38 °C

without other origin, leukopenia ($<4,000/\text{mm}^3$) or leukocytosis ($\geq 12,000/\text{mm}^3$), as well as at least one of the following variables: Purulent sputum, cough dyspnea or tachypnea, suggestive pulmonary auscultation and worsening gas exchange.

Results: A total of 74 samples were identified, of which 10 were discarded due to insufficient sample, exclusion of infection or dissociation between the Filmarray and culture samples. 64 samples were included for analysis, of which 24 (37.5%) were positive by culture. The Filmarray test was positive in 19 of the 24 culture-positive cases (79%) and in 6 of the 40 culture-negative cases (15%).

Equivalence between the microbiological results obtained by culture and the bacterial pathogens identified by the Filmarray was compared using a contingency table, evaluating positive and negative predictive values (Chi square $p < 0.001$, positive predictive value 76%, negative predictive value 87.2%, sensitivity 79.2%, and specificity 85%. Accuracy of 82.8%) as well as the Kappa index (Kappa 0.636, 95% CI 0.39–0.88).

The appearance of the germ in cultures was analyzed with respect to the cycles present in the Filmarray, evaluating the cutoff point for culture isolation. A cutoff point of $10^4.5$ cycles was found for appearance on the culture plate (Significance of Montecarlo (bilateral) $p < 0.002$; 99% CI 0.001–0.003).

Filmarray copies/ culture isolation

			Culture isolation		Total
			No	Yes	
Number of Filmarray cycles in $10^{\wedge}x$	4	Count	7	1	8
	5	Count	2	5	7
	6	Count	0	1	1
	7	Count	2	12	14
Total		Count	11	19	30
Significance of Montecarlo (bilateral) 0.002 (IC 99% 0.001–0.003)					

Conclusions: The Film array has proven to be a highly valid tool for early etiological diagnosis of severe bacterial pneumonia, with high equivalence to cultures. The germs that did not appear on the Filmarray were due to their absence in the matrix, mainly opportunistic, so its use in immunocompromised patients should be interpreted with caution.

References

- Adams J, Ferguson K, Hirschy RA, Konopka E, Meckel J, Benanti G, et al. Antimicrobial Stewardship Techniques for Critically Ill Patients with Pneumonia. *Antibiotics* 2023, Vol 12, Page 295 [Internet]. 2023 Feb 1 [cited 2023 Apr 5];12(2):295. Available from: <https://www.mdpi.com/2079-6382/12/2/295/htm>
- Lee SH, Ruan SY, Pan SC, Lee TF, Chien JY, Hsueh PR. Performance of a multiplex PCR pneumonia panel for the identification of respiratory pathogens and the main determinants of resistance from the lower respiratory tract specimens of adult patients in intensive care units. *Journal of Microbiology, Immunology, and Infection* [Internet]. 2019 Dec 1 [cited 2023 Apr 2];52(6):920. Available from: [/pmc/articles/PMC7185395/](https://pmc/articles/PMC7185395/)
- Foschi C, Zignoli A, Gaibani P, Vocale C, Rossini G, Lafratta S, et al. Respiratory bacterial co-infections in intensive care unit-hospitalized COVID-19 patients: Conventional culture vs BioFire FilmArray pneumonia Plus panel. *J Microbiol Methods*. 2021 Jul 1;186:106,259.
- Murphy CN, Fowler R, Balada-Llasat JM, Carroll A, Stone H, Akerele O, et al. Multicenter evaluation of the BioFire FilmArray Pneumonia/ Pneumonia plus panel for detection and quantification of agents of lower respiratory tract infection. *J Clin Microbiol* [Internet]. 2020 Jul 1 [cited 2023 Apr 1];58(7). Available from: doi: <https://doi.org/10.1128/JCM.00128-20>

Topic: Infections and prevention

000975

Transcriptomic analysis of CD59 expression in PBMCs of COVID-19 patients

M. Detsika¹, M. Sakkou², V. Triantafillidou³, D. Konstantopoulos³, E. Jahaj⁴, I. Dimopoulou⁵, G. Kollias⁶, A. Kotanidou⁷, S. Orfanos⁷

¹1st Department of Critical Care Medicine and Pulmonary Services, National and Kapodistrian University of Athens, School of Medicine, Athens, France; ²Center of New Biotechnologies & Precision Medicine, Department of Physiology, National and Kapodistrian University of Athens, Athens, Greece; ³Institute for Bioinnovation, Biomedical Sciences Research Center "Alexander Fleming", Athens, Greece; ⁴1st Department Of Critical Care Medicine & Pulmonary Services, Evangelismos General Hospital, Athina, Greece; ⁵1st Department Of Critical Care Medicine & Pulmonary Services, Evangelismos Hospital, Medical School, National & Kapodistrian University of Athens, Athens, Greece; ⁶Center of New Biotechnologies & Precision Medicine, Department of Physiology, National and Kapodistrian University of Athens, Athens, Greece; ⁷1st Department Of Critical Care Medicine & Pulmonary Services, Evangelismos Hospital, Medical School, National and Kapodistrian University of Athens, Athens, Greece

Correspondence: M. Detsika

Intensive Care Medicine Experimental 2023, **11(Suppl 1)**: 000975

Introduction: Complement overactivation has been documented in COVID-19 especially in critically ill patients (1) with C5b-9 terminal complement cascade component being a predictor of mortality and disease progression (2). CD59 is a complement regulatory protein which acts exclusively at the final step of the complement cascade by preventing C5b-9 formation and therefore cell lysis.

Objectives: To investigate CD59 expression in peripheral blood mononuclear cell (PBMCs) populations of critically ill COVID-19 patients by single cell RNA sequencing (SC-RNA Seq) analysis.

Methods: The study was approved by the "Evangelismos" Hospital Research Ethics Committee. PBMCs were isolated from COVID-19 patients with mild disease (mild, $n = 4$), severe disease (severe, $n = 4$), and critical disease (critical, $n = 4$) and processed for SC-RNA Seq immediately.

Results: A total of 61,022 single cells passed quality control and were used in the analysis. The mild group consisted of 22,570 sequenced single cells while the severe and critical groups consisted of 7,350 and 15,397 cells respectively. 13 distinct cell populations were identified including CD4+T cells, CD8+T cells, natural killer (NK) cells, CD14+ monocytes, CD14+CD16+ monocytes, CD16+ monocytes, B cells, dendritic cells, hematopoietic stem cells, red blood cells, plasma cells, platelets and granulocytes. A trend of reduced CD59 expression levels in critically ill patients compared to severely ill was observed in the whole PBMC population. Specifically, an increase of CD59 expression was observed in severely ill patients compared to healthy controls and patients with mild COVID-19 followed by a reduction in critically ill. The increase in CD59 expression levels observed in severely ill patients was more profound in the dendritic cell population compared to monocyte, T cell and B cell population CD59 expression. Integrated analysis revealed the same trend of reduced CD59 expression in the monocyte, T cell and B-cell populations of critically ill patients.

Conclusions: Taken together the above observations point towards an inability to sustain increased levels of CD59 in COVID-19 critically ill patients. Failure to sustain increased CD59 expression levels may contribute to the increased C5b-9 levels observed in critically ill COVID-19 patients and prolonged complement overactivation.

References

- Sinkovits G, et al., *Frontiers in immunology*, 2021.
- Detsika MG, et al. *Life* 2022.
- We acknowledge financial support of this work by The Greek Research Infrastructure for Personalised Medicine (pMedGR) (MIS 5002802), funded by the Operational Programme "Competitiveness, Entrepreneurship and

Innovation" (NSRF 2014–2020) and co-financed by Greece and the European Union (European Regional Development Fund). We also acknowledge support by the Hellenic Foundation for Research and Innovation (H.F.R.I.) under the "1st Call for H.F.R.I. Research Projects to support Faculty members and Researchers and the procurement of high-cost research equipment" (project Single.Out, #3780, to GK).

Topic: Translational Medicine

000976

Characteristics, management and outcomes of patients admitted to the ICU with status epilepticus

H. M. Al-Dorzi¹, D. S. Ashgar², E. Balahmar², R. Almulhem², D. Aleesa², R. Almoueteri², N. Masud²

¹Intensive Care Department, King Saud bin Abdulaziz University for Health Sciences (KSAU-HS), Riyadh, Saudi Arabia; ²College of Medicine, King Saud bin Abdulaziz University for Health Sciences (KSAU-HS), Riyadh, Saudi Arabia

Correspondence: H.M. Al-Dorzi

Intensive Care Medicine Experimental 2023, 11(Suppl 1):000976

Introduction: Status epilepticus (SE) has been associated with significant morbidity and mortality but needs further study.

Objectives: This study evaluated the characteristics, management and outcomes of adult patients who had SE leading to ICU admission.

Methods: This was a retrospective study of consecutive patients aged ≥ 14 years who were admitted to the ICU in King Abdulaziz Medical City in Riyadh, Saudi Arabia between 2016 and 2021 because of SE. We described the characteristics, management, and outcomes of these patients. The Status Epilepticus Severity Score (STESS), which ranges between 0 and 6, is calculated from 4 clinical variables (age, level of consciousness, past history of seizures, and type of SE).

Results: During the study period, 115 patients were admitted to the ICU due to SE. Their median age was 38 years (interquartile range [IQR] 26, 59); 62.6% were males; and 59.1% were on prior antiepileptic therapy. At presentation, most patients (85.7%) had generalized tonic clonic seizures, the median Glasgow Coma Scale was 7 (IQR 3, 10) and the median STESS was 4 (IQR: 3, 4). Hypoglycemia (< 3.9 mmol/L) was present in 3 patients (2.6%), hyponatremia (< 120 mmol/L) in 1 (0.9%), hypocalcemia (< 1.9 mmol/L) in 20 (17.4%), hypomagnesemia (< 0.65 mmol/L) in 7 (6.1%), and hypophosphatemia (< 0.6 mmol/L) in 4 (3.5%). Brain CT showed acute/sub-acute stroke in 6 patients (5.2%), intracranial hemorrhage in 3 (2.6%), and brain tumor in 6 (5.2%). Lumbar puncture was performed in 41 patients with cerebrospinal fluid analysis showing high WBC in 8, high protein (> 0.4 g/L) in 22, positive bacterial culture in 2 and positive herpes simplex virus PCR in 2. Electroencephalography was performed for 93 patients. Most patients (80.0%) received lorazepam to abort seizures (median dose 3 mg [IQR 2, 6]). Intubation was needed in 87 patients (median duration of mechanical ventilation was 4 days [IQR 2, 10]). Tracheostomy was performed in 21 patients (18.3%). Five patients (3.5%) died in the ICU and 6 (5.2%) in the hospital. Poor outcome (discharge Glasgow Coma Scale < 14 or death) occurred in 36 patients (31.3%), with no difference pre- and post-COVID-19. On multivariable logistic regression analysis, chronic kidney disease (odds ratio: 10.4, 95% confidence interval: 1.2, 89.2) was a predictor of poor outcome. STESS and need for mechanical ventilation did not predict poor outcome.

Conclusions: Most patients admitted to the ICU due to SE were young; a minority had abnormalities in brain CT or cerebrospinal fluid and most needed mechanical ventilation. One in five patients required tracheostomy and one in 20 patients died in the hospital. STESS at presentation did not predict poor outcome.

References

1. None

Topic: Neurointensive care

000979

A thematic analysis of issues faced by the Multi-Disciplinary Team working in an Intensive Care Unit during the COVID-19 pandemic

C. Angela¹, Z. Van², W. Anna²; A. Donovan³, A. Mulcahy², A. Carter⁴

¹Anaesthesia and Intensive Care, University College London Hospitals Nhs Foundation Trust, London, United Kingdom; ²Intensive Care, University College London Hospitals Nhs Foundation Trust, London, United Kingdom; ³Anaesthesia and Intensive Care, Taunton & Somerset Hospital, Taunton, United Kingdom; ⁴Anaesthesia and Intensive Care, University College London Hospitals Nhs Foundation Trust, London, United Kingdom

Correspondence: C. Angela

Intensive Care Medicine Experimental 2023, 11(Suppl 1):000979

Introduction: On the 31st of January 2020, the World Health Organisation issued a declaration of a global health emergency (1); the pandemic that followed led to an unprecedented burden health care systems and especially intensive care units (ICUs) worldwide. This project was undertaken as part of a wider collaboration with the London Transformation Learning Collaborative (LTLC), commissioned by NHS England/Improvement and Health Education England to support the London region with information sharing and building resilience for the possible future demand for critical care(2).

Objectives: To gain an understanding of issues affecting health care workers in an our intensive care unit during the first wave of the COVID-19. This information was collected with the view of identifying common themes and as a secondary outcome, to derive possible strategies to manage in subsequent waves of the pandemic.

Methods: We performed a qualitative study using methodology akin to that of medical ethnography in a process of clinical engagement, data interrogation, innovation and recommendations (3,4). 36 interviews with health care workers in the multi-disciplinary team (MDT) in an ICU setting were carried out by 3 clinician researchers trained in qualitative data collection. These interviews were conducted face-to-face or virtually, depending on the participant's preferences. Data in the form of field notes was analysed in an inductive and deductive manner and then coded into pre-agreed sub-themes and themes. Our findings were then explored in focus groups with the stakeholders of the intensive care service, and recommendations generated after a process of discussion and collaboration.

Results: Our data analysis was completed using a modified thematic framework approach (5) and we followed the documented stages of the framework in a pragmatic way, in order to produce results in a timely manner, in order for recommendations to be put in to practice. Our thematic analysis revealed four broad categories as revealed from the interviews:

- 1) Communication.
- 2) Staffing.
- 3) Teaching and training.
- 4) Well-being and health.

The findings are summarised in fishbone diagrams in Figures 1–4 with each diagram showing cause and effects elicited from the interviews. Using this information gathered from the interviews, focus group meetings with senior representatives of the MDT took place, and we interrogated these themes using documented methods of innovative and divergent thinking to create recommendations for the department to implement.

Conclusions: Lessons from previous pandemic experiences have helped to inform our preparedness today, and we should leverage our learnings from current events to improve future responses. By carrying out qualitative research identifying these themes in a structured way, working practices can then be adapted to evolve with challenges presented to improve the working lives of the staff at the ICU during these trying times or indeed, improve our responses to similar major events.

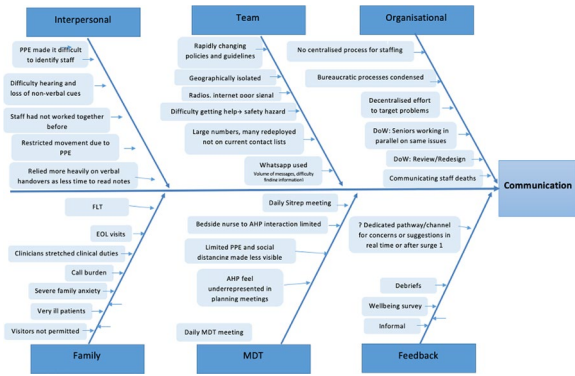

Fig. 1 (abstract 000979) Communication

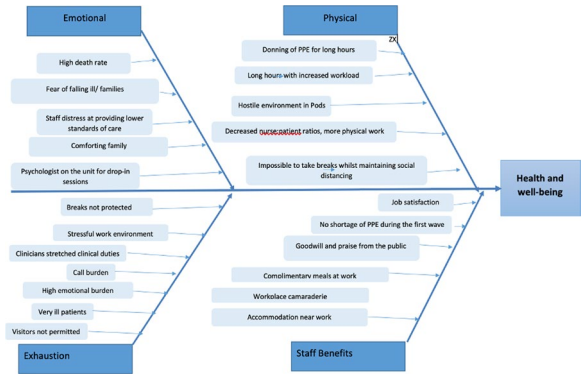

Fig. 4 (abstract 000979) Health and Well-being

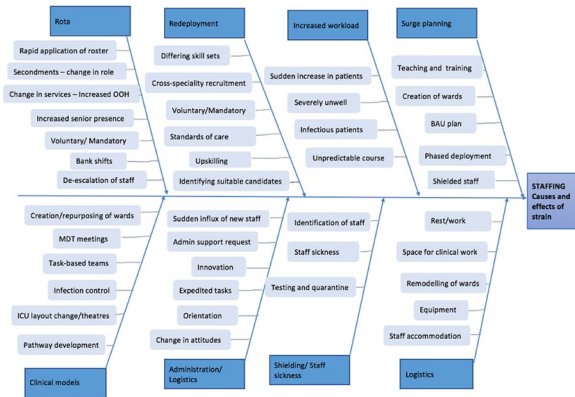

Fig. 2 (abstract 000979) Staffing

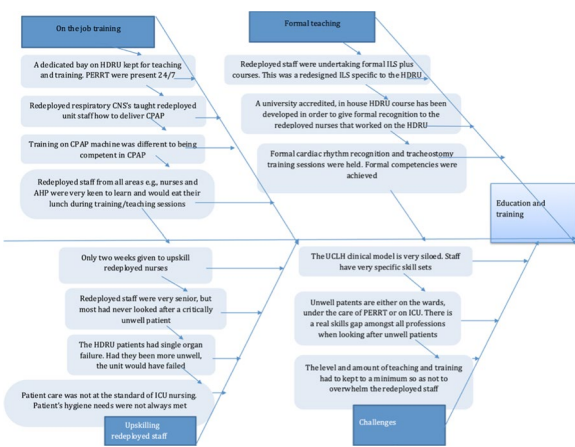

Fig. 3 (abstract 000979) Education and Training

References

1. Braun V, Clarke V. Using thematic analysis in psychology. *Qualitative Research in Psychology*. 2006;3(2):77–101.
2. Corner EJ, Camilleri M, Dholakia S, Gredal C, Hansen T, Jeans J, et al. The clinically led workforce and activity redesign (clear) programme: A Novel Data-Driven Healthcare Improvement Methodology. *BMC Health Services Research*. 2022;22(1).
3. Goodson L, Vassar M. An overview of ethnography in healthcare and medical education research. *Journal of Educational Evaluation for Health Professions*. 2011;8:4.
4. Health Education England. London Transformation and Learning Collaborative (LTL) Critical Care programme <https://www.e-lfh.org.uk/programmes/london-transformation-and-learning-collaborative-ltlc/>. 2021
5. World Health Organization. (2020). Novel Coronavirus (2019-nCoV): Situation report 12. World Health Organization.

Topic: Critical care organisation, quality management, information systems, outcomes

000980

Comparing severe COVID-19 outcomes of first and second/third waves: a prospective single-center cohort study of health-related quality of life and pulmonary outcomes 6 months after infection.

P. Darlington¹, M. Roel¹, M. Cronhjort², G. Hanna³, A. Hedman⁴, E. Joelsson-Alm⁵, A. Schandl⁶

¹Internal Medicine, Södersjukhuset, Stockholm, Sweden; ²Department of Clinical Science And Education, södersjukhuset, Karolinska Institute, Stockholm, Sweden; ³Radiology, Södersjukhuset, Stockholm, Sweden; ⁴Cardiology, Södersjukhuset, Stockholm, Sweden, Sweden; ⁵Department of clinical science and education, Karolinska Institutet, Södersjukhuset, Stockholm, Sweden; ⁶Department of molecular medicine and surgery, Karolinska Institutet, Stockholm, Sweden

Correspondence: M. Roel

Intensive Care Medicine Experimental 2023, **11(Suppl 1)**:000980

Introduction: The purpose of this was to clarify if outcomes have improved with time in intensive care unit (ICU) survivors treated for severe COVID-19, comparing first with second/third waves.

Methods: In this prospective single-center study, adult COVID-19 patients with respiratory distress admitted to two Swedish ICUs were included. Survivors from the first wave (1 March– 1 September 2020) were compared with survivors from the second/third waves (2 September 2020– 1 August 2021). Outcomes were differences in health-related quality of life (HRQL) and pulmonary function between waves. General linear regression and multivariable logistic regression were used to present mean score differences (MSD) and odds ratios (OR) with 95% confidence intervals (CI).

Results: Among the 456 (67%) critically ill COVID-19 patients who survived for at least 90 days after ICU discharge, 278 (61%) attended the follow-up approximately 6 months after ICU discharge. HRQL was similar between the groups, except that the second/third wave survivors scored higher in the role physical domain (MSD 20.2, 95%CI: 7.3–33.1) and lower on bodily pain (MSD 12.2, 95%CI: 3.6–20.8). On the other hand, first wave survivors had better diffusion capacity for carbon monoxide (DLCO) (OR 1.9, 95%CI: 1.1–3.5).

Conclusions: This study indicates that even though intensive care treatment strategies have changed with time, long-term HRQL and impaired respiratory health remain similar at 6 months for patients surviving severe COVID-19 in the first and second/third waves of the pandemic.

Topic: Infections and prevention

000982

Patterns of pre-injury substance use in trauma ICU patients

S. Marks¹, J. Catlin²

¹Medical Scientist Training Program, VCU School of Medicine, Richmond, United States of America; ²Surgery, Virginia Commonwealth University, Richmond, United States of America

Correspondence: S. Marks

Intensive Care Medicine Experimental 2023, 11(Suppl 1):000982

Introduction: Past studies have shown that trauma patients who have a positive blood or urine screen for drugs or alcohol experience differential treatment outcomes. These studies have largely focused on single substances in isolation and have not considered implications for clinical management of patients who have positive screens for multiple substances, particularly in the setting of critical illness. Little is known about patterns of multiple substance use and differences in patient and injury characteristics by the number of substances classes used.

Objectives: To identify the prevalence of polysubstance positive drug and alcohol screens, patterns of polysubstance use, and differences in patient characteristics by number of substances used among trauma ICU patients.

Methods: We used data from the American College of Surgeons' Trauma Quality Improvement Project from 2020 & 2021, a registry with data from over 750 hospitals. We included patients who were in the intensive care unit for three or more days and who received a drug and alcohol screen within 24 h of arrival; patients who tested positive only for substances administered as part of their care were considered to be negative for that substance. We classified substances as stimulants (amphetamine, cocaine, methamphetamine), sedatives (barbiturates, benzodiazepines), hallucinogens (ketamine, phencyclidine), opioids (methadone, opioid, oxycodone), cannabis and alcohol. We used descriptive statistics to examine the prevalence and relationships between different classes of substances and chi-square tests/ANOVA to examine difference in patient characteristics by number of substance classes.

Results: In total, 138,559 patients were included in the analysis dataset. In total, 54.5% (77,553) had positive drug and alcohol screens, with 26.2% (36,275) positive for cannabis, 20.6% (28,600) positive for alcohol, 19.2% (26,632) positive for stimulants, 9.2% (12,761) positive for depressants 6.6% (9,137) positive for opioids and 1.4% (1,990)

positive for hallucinogens. Of those positive for at least one drug and/or alcohol (70,553), 40.3% (30,474) were positive for multiple classes of substances, including 15.5% (7,944) positive for three or more classes of substances. Patterns in polysubstance use is shown in Figure 1. Differences in patient characteristics by number of substances used are shown in Table 1.

Table 1 (abstract 000982) Patient and injury characteristics by number of substance classes used

	Positive for no substances	Positive for one class	Positive for two or more classes
Age (mean (95% CI))*	55.6 (55.4–55.7)	43.3 (43.1–43.4)	39.7 (39.5–39.9)
Gender (%)			
Male	66.1	77.1	80.0
Female	33.9	22.9	20.0
Previously diagnosed substance use disorder (%)*			
Yes	3.7	19.0	34.3
No	96.3	81.1	65.7
ISS (mean (95% CI))*	18.4 (18.3–18.5)	19.8 (19.7–20.0)	19.9 (19.8–20.1)

*p < 0.05

Conclusions: Among a national registry of trauma ICU patients, use of multiple substance classes was common; patients with positive screens for multiple substances were more likely to be younger and have a previously diagnosed substance use disorder. Greater research is needed to understand how the use of multiple substances may influence clinical trajectories and outcomes of critically ill trauma patients.

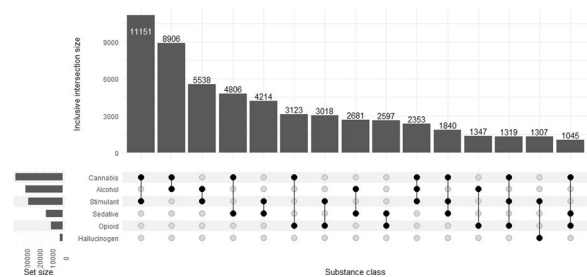

Figure 1 (abstract 000982) Patterns of substance use for patients using more than one class of substances

References

1. Tran, Z., Madrigal, J., Pan, C., Rahimtoola, R., Verma, A., Gandjian, M., Tillou, A., & Benharash, P. (2022). Impact of opioid use disorder on resource utilization and readmissions after operative trauma. *Surgery*, 171(2), 541–548. doi: <https://doi.org/10.1016/j.surg.2021.06.025>
2. Ryb, G. E., & Cooper, C. (2008). Outcomes of cocaine-positive trauma patients undergoing surgery on the first day after admission. *The Journal of Trauma*, 65(4), 809–812. doi: <https://doi.org/10.1097/TA.0b013e318187803f>
3. Cheng, V., Inaba, K., Johnson, M., Byerly, S., Jiang, Y., Matsushima, K., Haltmeier, T., Benjamin, E., Lam, L., & Demetriades, D. (2016). The impact of pre-injury controlled substance use on clinical outcomes after trauma. *Journal of Trauma and Acute Care Surgery*, 81(5), 913. doi: <https://doi.org/10.1097/TA.0000000000001229>
4. Bloom, S. R., Grigorian, A., Schubl, S., Thangathurai, D., Kuza, C. M., Swentek, L., & Nahmias, J. (2022). Marijuana Use Associated with Decreased

Mortality in Trauma Patients. The American Surgeon, 88(7), 1601–1606.
doi: <https://doi.org/10.1177/00031348211069789>

Topic: Trauma

000984

Detecting delirium in critically ill patients with automated EEG; a comparative study

S. Rai¹, M. Tanaka¹, H. Thomas¹, L. Mires¹, C. Gnanalingam¹, R. Sarkar²
¹Intensive Care Medicine, Medway Maritime Hospital, Gillingham, United Kingdom; ²Respiratory medicine and critical care, Medway Maritime Hospital, Gillingham, United Kingdom

Correspondence: S. Rai

Intensive Care Medicine Experimental 2023, **11(Suppl 1)**:000984

Introduction: Delirium is a common and serious condition affecting acutely ill patients of all ages and backgrounds and is a manifestation of acute encephalopathy sustained by these patients. This can be of fluctuating nature, characterised by lack of awareness, attention and altered cognition and is often reversible with treatment of underlying cause. Patients experiencing delirium in the ICU have longer hospital stays, higher mortality rates, and greater long-term cognitive impairment. Despite this, delirium, particularly hypoactive delirium, remains underdiagnosed and undertreated. Different instruments, for example CAM-ICU, are widely used to diagnose delirium in ICU patients, but can lack sensitivity. There is an interest in utilising EEG based diagnosis of acute encephalopathy currently [1], but the feasibility of using this in busy ICU environment needs to be established in wider patient population.

Objectives: We aimed to measure acute encephalopathy with DeltaScan, an automated tool based on electroencephalopathy (EEG), identifying delta waves and comparing its performance to the widely used CAM-ICU tool.

Methods: We conducted a prospective study in our ICU, assessing patients with both DeltaScan and CAM-ICU. Patients who could comply with instructions for the tests were included if they did not have a pre-existing acute diagnosis involving the brain (e.g. stroke, epilepsy). In order to ensure consistency, a team made of four physicians including an advanced critical care practitioner performed CAM-ICU and DeltaScan and collected data, including demographics, length of stay, reason for admission. Within a possible range of scores of 1–5 in DeltaScan, a value between 3 and 5 are considered to be suggestive of acute encephalopathy, while a value of 1 or 2 signifies absence of it. We compared the tools’ ability to detect abnormality suggestive of acute encephalopathy with or without clinically evident delirium and examined test duration for clinical feasibility.

Results: Both CAM-ICU and DeltaScan were simultaneously measured on 187 occasions for 145 patients. A total of 260 attempts were made for CAM-ICU and DeltaScan measurements. For reasons including patient wish and lack of availability, one or both the measurements were not possible on some occasions (Table 3). Median age of the cohort was 69 years, mean length of stay was 1 week and on average, it took 357 s to perform DeltaScan (Table 1). The prevalence of detecting acute encephalopathy with DeltaScan was 40% (n = 75) compared to detection of delirium by CAM-ICU at 14% (n = 26). Of the patients who were positive for acute encephalopathy with Delta Scan, 27% (n = 20) were also positive with CAM-ICU (Table). Of the 60% (n = 112) who did not have acute encephalopathy according to the DeltaScan, 5% (n = 6) were CAM-ICU positive. Physicians agreed with DeltaScan findings in 73% (n = 11) of cases in patients where the results between the 2 modalities were discordant.

Conclusions: In this study within a mixed ICU, it was possible to measure DeltaScan in patients with relative ease. There was concordance between DeltaScan and CAM-ICU in majority of patients. However, it appears that DeltaScan detected more patients with acute

encephalopathy compared to number of patients being detected with delirium by CAM-ICU. It is possible that these additional patients have subclinical cerebral processes of milder encephalopathy that were not manifested by features of delirium. It may therefore be more sensitive in identifying acute encephalopathy. Furthermore, being an objective bedside test, this is less prone to inter or intra-observer variability that might be an issue with CAM-ICU. However, it remains to be proved whether this increased sensitivity equates to improved clinical outcomes in a cost-effective way and suitably designed trials need to be performed to address this issue before this new modality can be embraced as part of routine clinical care.

Table 1 (abstract 000984) Baseline characteristics of patients

Characteristics	Patients (no 145)
Age	Median: 69 years (Range: 25 - 87)
Sex	
Male	76 (52%)
Female	69 (48%)
Speciality	
Medical	56 (39%)
Surgical	89 (61%)
Emergency	114 (79%)
Elective	31 (21%)
Average length of stay	7 days
Range	(1 to 79 days)

Table 2

Table 2 (abstract 000984) Contingency table for concordance between DeltaScan and CAM-ICU

		CAM –ICU		
		Positive	Negative	Total
DELTA	Positive	20	55	75
	Negative	6	106	112
Total		26	161	187

Table 3 (abstract 000984) Feasibility of performing both modalities and reasons for missing observations with Delta scan and CAM-ICU

	CAM-ICU possible	CAM-ICU impossible	CAM-ICU - patient not available	CAM-ICU - patient refused
Delta possible	187	4	0	0
Delta impossible	8	18	0	0
Delta - patient not available	1	1	13	0
Delta - patient refused	2	2	0	24

References

1. Numan T, Van Den Boogaard M, Kamper AM, Rood PJT, Peelen LM, Slooter AJC, Dutch Delirium Detection Study Group. Delirium detection using relative delta power based on 1-min single-channel EEG: a multi-centre study. *Br J Anaesth* 2019; 112: 60–8
2. Prolira provided the DeltaScan device and had no role in designing the service evaluation, data analysis, interpretation or decision to submit for publication.

Topic: Sedation, analgesia and delirium

000985

The incidence of perioperative hypotension in patients undergoing major abdominal surgery with the use of arterial waveform analysis and the hypotension prediction index hemodynamic monitoring

J. Szrama¹, A. Gradyś¹, T. Bartkowiak¹, A. Woźniak¹, A. Lohani¹, N. Jawień¹, K. Zwoliński¹, P. Smuszkiewicz¹, K. Kusza¹

¹Department of Anesthesiology, Intensive Therapy and Pain Management, Poznan University of Medical Sciences, Poznań, Poland

Correspondence: J. Szrama

Intensive Care Medicine Experimental 2023, **11(Suppl 1)**:000985

Introduction: Intraoperative hypotension (IH) is a frequent phenomenon affecting a substantial number of patients undergoing general anesthesia and is related to significant perioperative complications including kidney failure, myocardial injury and even increased mortality. The Hypotension Prediction Index (HPI) algorithm is based on a machine learning systems with the complex analysis of arterial pressure waveform, which is able to inform the clinician of an upcoming hypotension event. There are several, both retrospective and prospective studies showing significant reduction of IH episode with the use of the HPI algorithm.

Objectives: The aim of the study was the comparison of the rate of perioperative hypotension in patients undergoing major abdominal surgery depending on the type of hemodynamic monitoring applied during anesthesia.

Methods: This single center retrospective study was performed in the Department of Anesthesiology and Intensive Therapy in the Poznan University of Medical Science Hospital in Poland. The analysis included 89 patients undergoing major abdominal surgery from October 2021 to November 2022 with invasive arterial pressure hemodynamic monitoring, using either the arterial pressure cardiac output (APCO) technology (FloTrac n=61 patients) or the Hypotension Prediction Index algorithm (n=28). The primary endpoint was the incidence and duration of hypotensive events defined as MAP < 65 mmHg evaluated by time-weighted average of hypotension.

Results: The median time-weighted average of hypotension in the FloTrac group was 0.31 mmHg versus 0.12 mmHg in the HPI group (p=0.002). In the FloTrac group the average time of hypotension was 27,9 min (14,4% of total anesthesia time), while in the HPI group it was 11.4 min (4,4% of total anesthesia time) (p=0.003). Finally, the

average duration of each hypotensive event was 5 min in the FloTrac group compared to 3 min in the HPI group (p=0.003).

Conclusions: The use of the HPI algorithm when compared to an arterial waveform analysis derived cardiac output alone allowed a substantial reduction in the incidence and duration of perioperative hypotension events in patients undergoing major abdominal surgery. This study provides further evidence on the possibilities of changing the perioperative hypotension management from treatment to prevention.

Topic: Perioperative care.

000986

Intercostal Drain Insertion Training – A Pilot Quality Improvement Project at District General Hospital in Greater London

N. Vickery¹, S. Berhane², L. Grauslyte²

¹Anaesthesia/Critical Care Medicine, Barts Health NHS Trust and CCPMRG, Queen Mary University, London, United Kingdom; ²Critical Care Medicine, Barts NHS Trust, London, United Kingdom

Correspondence: N. Vickery

Intensive Care Medicine Experimental 2023, **11(Suppl 1)**:000986

Introduction: Intercostal drain (ICD) insertion, Seldinger and surgical, is a well-established treatment modality for the management of pneumothoraces and pleural effusions. Delay in treating these conditions and incorrect procedure can lead to morbidity and mortality. (1, 2). In the United Kingdom, many doctors leave training without the ICD skills to practice independently. (3). Sim training has shown to improve confidence in skill attainment (4).

Whipps Cross University Hospital is a district general hospital in London with a 17 bedded intensive care unit. After a drain related incident, we decided to plan and institute a sim-based training intervention.

Objectives:

1. to improve the confidence and skills of ICD insertion, both Seldinger and surgical drains
2. to provide all trainees rotating through our critical care unit exposure to ICD insertion skills

Methods: We invited all trainees to one of the multiple skills sessions, with numbers limited to eight persons per session. All participants were sent pre-course materials and they all filled out questionnaires before the course. Practical training consisted of an expert-led demonstration followed by expert-guided individual practise on part task trainers (5). Following the course, the participants filled out post-course anonymised self-reported confidence questionnaires (on a 0 – 10 scale, 10 being the most confident).

Results: We trained 19 junior doctors with grade and training experience shown in Table 1. Nine (47.37%) had had previous training.

Table 1 (abstract 000986) Showing previous training in ICDs

Grade	Previous training in chest drain insertion		Total
	no n(%)	yes n(%)	
core trainee	4 (21.05)	8 (42.11)	12 (63.16)
speciality trainee	3 (15.79)	1 (5.26)	4 (21.05)
senior trainee	3 (15.79)	0 (0)	3 (15.79)
Total	10 (52.63)	9 (47.37)	19 (100)

Most participants had no previous clinical experience of Seldinger (median 0, IQR 2) or surgical (median 0, IQR 0) ICD insertion.

Pre and post course confidences were represented in Figure 1, with an increase in confidence for all, with pre- to post- medians (IQR)

Seldinger increasing from 3(3) – 8 (1.5), and surgical 2 (3) – 7 (2). All 19 participants thought the teaching was helpful.

Conclusions: Reported experience and confidence with intercostal drain insertion is lacking. Our training showed an increased confidence in the procedures. Even without a well-defined relationship between self-reported confidence and competence it appears that simulation based skills sessions can be an adequate tool in improving the safety of ICD insertion and overall safety of care provision in district hospitals. A formal biannual training session is planned.

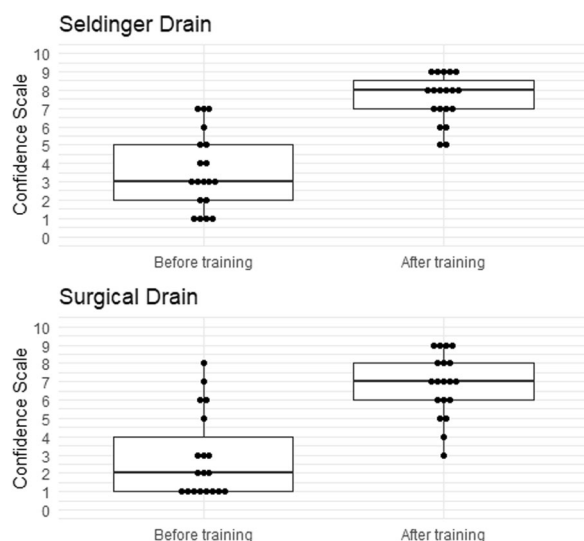

Graph 1 (abstract 000986) A box and whisker plot showing confidence improving after training

References

1. Akram AR, Hartung TK. Intercostal chest drains: a wake-up call from the National Patient Safety Agency rapid response report J R Coll Physicians Edinburgh, 2009; 39:117–20
2. 1. National Patient Safety Agency. Rapid response report: risks of chest drain insertion. London: NPSA; 2008. Available from: <http://www.npsa.nhs.uk/nrls/alerts-and-directives/rapidrr/risks-of-chest-drain-insertion>
3. 5. Adam, Rouilly Chest Drain and Needle Decompression Trainer. Available from: <https://www.adam-rouilly.co.uk/products/clinical-skills-simulators/chest-drain>
4. Vijayakumar B, Hynes G, Kitt J et al. An effective procedure skills training programme for GIM registrars. Future Healthc J Mar 2021, 8 (1) e117-e122
5. 3. Tasker F, Newbery N, Burr B, Goddard AF. Survey of core medical trainees in the United Kingdom 2013—inconsistencies in training experience and competing with service demands. Clin Med (Lond). 2014 Apr;14(2):149–56
6. Nil conflicts of interest. No grant money was used for this training.

Topic: Acute respiratory failure and mechanical ventilation

000987

Effect of a standardised family participation programme in the intensive care unit: a multicentre stepped wedge cluster randomised controlled trial; preliminary results

B. Dijkstra¹, P. Rood², L. Vloet²

¹Radboudumc, Intensive Care Unit, HAN University of Applied Sciences, Research Department Emergency and Critical Care, Nijmegen, Netherlands; ²Research Department Emergency and Critical Care, HAN University of Applied Sciences, Nijmegen, Netherlands

Correspondence: B. Dijkstra

Intensive Care Medicine Experimental 2023, **11(Suppl 1)**:000987

Introduction: Former critically ill patients and their relatives often experience Post Intensive Care Syndrome(-Family). Policies to promote family-centred care to improve family experience have been suggested in recent guidelines. Family participation in essential care may benefit both relatives and patients. Some studies have examined possible effects of standardised family participation programmes, though these effects are currently unclear.

Objectives: The aim of this study was to examine the effect of a programme for family participation in essential care in the ICU on relatives of ICU patients, focusing on satisfaction during ICU stay, and mental health symptoms, and ICU healthcare provider perceptions and experiences.

Methods: ICUs and their ICU healthcare providers from seven hospitals in the Netherlands participated from May 2021 until October 2022. Adult patients, and their relatives were included in the study when admitted to the ICU > 24 h and family participation in essential care was possible. A stepped wedge cluster randomised controlled trial was conducted. ICUs offered usual care in the control period. In the intervention period, after training ICU nurses on the family participation programme, relatives were invited to participate in essential care activities. A standardised menu to facilitate family participation in communication, amusement/distraction, comfort, personal care, breathing, mobilisation and nutrition was implemented. Data on relatives experience, satisfaction and mental health outcomes were collected through surveys at discharge and after three months. ICU healthcare providers completed questionnaires on their experiences.

Results: A total of 306 patient-relative pairs were included in the study. Relatives reported having participated in median 9 [IQR 2–17] of 34 possible activities after implementation of the programme. Data on satisfaction levels, anxiety scores, depression scores, and post-traumatic stress scores are currently analysed and will be available in October. ICU healthcare providers reported that a larger number of relatives knew how to participate in essential patient care: 47% in the intervention period versus 22% in the control period. They also reported that relatives had sufficient knowledge (41% versus 16% and skills (44% versus 25%) to apply family participation, odds ratios are currently calculated and will be available in October.

Conclusions: The effect on satisfaction scores and mental health symptoms in relatives after application of a standardised programme to facilitate family participation in essential care activities will be analysed and available in October. ICU healthcare providers reported increased clarity, knowledge and skills regarding family participation among relatives and ICU healthcare providers. Furthermore, performing a study during the covid-19 pandemic has yielded some unforeseen obstacles, e.g. changing visitation policies and experienced burden on ICU nurses, affecting possibilities for relatives to participate in care.

References

1. This project was funded by the Dutch Research Council (NWO, RAAK-SIA) (RAAK.PUB06.017).

Topic: Nursing care and physiotherapy

000988

Quality of life and cognitive function following COVID-19 infection

E. Bachlitzanaki¹, S. Ilia¹, E. Kondyli², S. Koukias¹, M. Detoraki¹, N.

Papanikolaou³, G. Briassoulis¹

¹Postgraduate Program "Emergency and Intensive Care In Children, Adolescents, And Young Adults", School of Medicine, University of Crete, Heraklion, Greece; ²ICU, University Hospital, School of Medicine, University of Crete, Heraklion, Greece; ³First Department of Internal Medicine, Venizeleio-Pananeio General Hospital, Heraklion, Greece

Correspondence: E. Bachlitzanaki

Intensive Care Medicine Experimental 2023, **11(Suppl 1)**:000988

Introduction: The clinical manifestations diversity of the post-COVID syndrome affects the quality of life of patients and reduces their functionality, making it difficult for them to return to their daily routine. The reduction of cognitive functions that is often observed in patients who had infected with SARS-CoV-2 virus is of particular interest.

Objectives: The main objective of this research is to investigate the SARS-CoV-2 virus impact on the quality of life and cognitive functions of patients with post-COVID syndrome; secondary aims included comparisons among groups and correlations of quality of life and cognitive function scores with clinical characteristics, vaccine coverage (complete, partial, or none), post-COVID symptoms, and comorbidities.

Methods: This is a retrospective study of patients followed-up in the "post-COVID" clinic at the Venizeleio General Hospital of Heraklion-Crete, Greece after being infected with COVID-19. The patients' quality of life was evaluated using the EQ-5D score (EQ-5D-5L, EQ-VAS)₁ and their cognitive function using the Mini Mental State Examination (MMSE)₂ within one to three months after illness. The EQ-5D is a general measure of quality of life that consists of two tools: a descriptive system (EQ-5D-5L) and a visual analogue scale (EQ-VAS). The MMSE is a widely used test of cognitive function that includes tests of orientation, attention, memory, language, and visual-spatial perceptions.

Results: Most (70.1–88.3%) of the enrolled patients (N=250) reported post-COVID symptoms up to 8 months of re-evaluation. Patients with comorbidities (65.2%) had more severe illness and need for mechanical ventilation (50%). Abnormal EQ-VAS and EQ-5D-5L scores were independently associated with the presence of 1-month post-COVID symptoms. The EQ-VAS was lower in patients with serious or critical illness compared to those with moderate disease (69.2% vs. 80%, $p=0.001$). The more severe quality of life symptoms, such as pain/discomfort, stress/distress, were reported by patients with comorbidities (Figure 1A) and females. Cognitive function problems (MMSE < 25) concerned orientation, concentration, recall, and language. Abnormal EQ-5D-5L, EQ-VAS ($p < 0.003$), and MMSE ($r = -0.48$, $p < 0.001$) correlated with prolonged LOS. Age (ROC 0.92 (0.83–0.99), $p = 0.001$) and severity of illness (ROC 0.758 (0.56–0.96), $p = 0.031$) could predict a pathological MMSE score among post-COVID patients (Figure 1B).

Conclusions: The presence of post-COVID symptoms, demographic characteristics, comorbidities, severity of illness, and prolonged length of stay are associated with poor quality of life and cognitive dysfunction following COVID-19 illness.

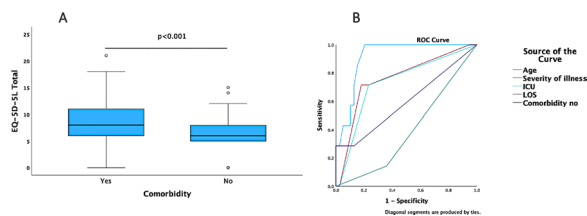

Figure (abstract 000988) 1. A. Poor quality of life (EQ-5D-5L total) for post-COVID patients with comorbidities; B. Old age and severity of illness are strong predictors of cognitive dysfunction after COVID-19 illness

References

1. Rabin R, de Charro F. EQ-5D: a measure of health status from the Euro-Qol Group. *Ann Med*. 2001 Jul;33(5):337–43

2. Folstein MF, Folstein SE, McHugh PR. "Mini-mental state": A practical method for grading the cognitive state of patients for the clinician. *J Psychiatr Res*. 1975 Nov;12(3):189–98

Topic: Infections and prevention

000989

After discharge from intensive care unit: What about outcomes of tracheostomized patients?

M. Kharrat¹, F. Essafi², N. Ben Slimene¹, I. K. Ben¹, M. Chaabani¹, G. Kharrat³, I. Talik¹, M. Kaddour¹, T. Merhabene¹

¹Intensive care unit, Regional Hospital Zaghuan, Faculty of medicine of Tunis, University of Tunis El Manar, Tunisia; ²Intensive care unit, Regional Hospital Zaghuan, Tunis, Tunisia; ³Oto rhino laryngology departement, Hôpital Nabeul, Nabeul, Tunisia

Correspondence: M. Kharrat

Intensive Care Medicine Experimental 2023, **11(Suppl 1)**:000989

Introduction: Tracheostomy is an invasive procedure conducted in ventilation weaning difficulties in intensive care units (ICU). Although it is a life saving measure, it is not risk-free. Therefore, follow up of tracheostomized patients is important to ensure a decent quality of life after discharge ICU.

Objectives: To describe the follow up and the aftermath of patients who were discharged from ICU with a tracheotomy.

Methods: We conducted a prospective observational study in the ICU of Zaghuan hospital, Tunisia between January 1st 2019 and Mars 31st 2023. Were included all patients who were discharged from ICU with tracheotomy and are followed up regularly (for at least 1 year) at the post ICU visit. Quality of life after ICU was evaluated based on need for oxygen therapy and/or resumption of normal activity.

Results: In the study period, 1240 patients were admitted in our unit, among them 531 needed invasive mechanical ventilation. Tracheostomy were indicated in 37 patients, 21 were discharged alive from ICU. Mean age was 56 [15–75 years]. Sex ratio was 2.5. Reasons for ICU admission were respectively trauma secondary to motor vehicular accident (n=10), acute respiratory failure (n=9) and coma (n=2). Intubation was needed in the first day upon admission in most combine cases. Mean time for tracheostomy was day 15 after admission with IQR [12–23]. Mean reasons for tracheostomy were persistent coma (n=9) followed by respiratory weaning difficulties from invasive mechanical ventilation (n=6), tracheal stenosis (n=4) and critical illness weakness (n=2). Mean duration of ICU stay was 41 days [15–96]. Five patients were discharged with at home oxygen therapy, it was stopped in three cases at the time of consultation. Mean time for the first post ICU consultation was 4 weeks. One patient was discharged with at home mechanical ventilation. In the follow up three patients were deceased in a mean time of approximately 6 weeks. Death was due to massif hemorrhage complication of the tracheostomy site in two patients. Mean time for oxygen weaning was six weeks after ICU discharge. Long term complication related to tracheotomy was noted in one patient. It was a tracheal stenosis. Decannulation was conducted in nine patients with a mean time of 2 months after ICU discharge and IQR [1–11.75] months. It was carried out without complications after an otorhinolaryngological examination by nasofibrosopy. Six patients resumed normal every day activities, two still needed help from a third party and three patients did not resume a normal activity.

Conclusions: Tracheotomy is a solution for patients with weaning difficulties in ICU whether it is associated with a respiratory or neurological reason. Follow up is necessary to provide a good quality of life for this category of patients.

Topic: Acute respiratory failure and mechanical ventilation

000991

Optimising capacity—coordination and management of critical care capacity—the Welsh approach

T. Hirst¹, M. Slattery¹

¹ACCTS Cymru, Emergency Medical Retrieval and Transfer Service (EMRTS Cymru), Cardiff, United Kingdom

Correspondence: T. Hirst

Intensive Care Medicine Experimental 2023, **11(Suppl 1)**:000991

Introduction: Provision of critical care is a scarce and precious resource at a hospital, regional and national level. Centralisation of specialist care has inevitably resulted in need for interhospital transfer of critically ill patients to access treatment, but movement between facilities to optimise capacity has traditionally been far less common in UK practice. During the COVID-19 pandemic, critical care networks were forced to move patients both within and between regions to optimise capacity at individual sites. In parallel, transfer of patients has moved from ad-hoc teams of local junior clinicians on unfamiliar vehicles, to dedicated transfer teams, now commissioned across the UK to ensure equity of critical care.

In Wales our Adult Critical Care Transfer Service (ACCTS) provide 2 critical care transfer teams as well as a dedicated transfer nurse practitioner to host a virtual daily meeting of all 13 critical care units nationally. By democratising data on capacity and staffing for all units, and facilitating direct communication between centres, transfers can be arranged in a timely and efficient fashion, allowing optimal patient flow through the network. Centres approaching safe capacity can easily identify sites with receiving capacity, saving valuable time and multiple conversations, and can directly interface with transfer clinicians to allow seamless transfer of care.

Methods: We describe the operation of our daily national critical care sitrep meeting, network capacity and associated interhospital transfer activity for our first commissioned year of operation.

Results: Attendance at the critical care sitrep meeting had a mean attendance of 9 units (69%) with a weekday mean attendance of 11 (85%). Individual unit attendance over the year ranged from 56 to 85%. Units spent a mean of 82 days at or above fully staffed capacity and a mean of 29 days at a level of activity utilising surge beds outside of critical care. During this time we facilitated 279 planned interfacility transfers, accounting for 52% of all interhospital transfer activity.

Conclusions: By combining reporting of critical care capacity across our network with coordination of critical care transfer in an innovative virtual meeting, we have reduced the steps to organising interfacility transfer at a time of unprecedented critical care demand, allowing earlier and more frequent interhospital transfer by our specialist service.

Topic: Critical care organisation, quality management, information systems, outcomes.

000992

Respiratory tract colonization with *Candida* species in cancer patients: epidemiology and prognostic impact

A. Chaari¹, K. Bousselmi¹, M. Bahr¹, S. Kulkarni¹, M. Georgy¹, I. Aboayana¹, A. Radwane¹, V. Kauts¹

¹Critical Care Department, King Hamad University Hospital, Al Sayh, Bahrain

Correspondence: A. Chaari

Intensive Care Medicine Experimental 2023, **11(Suppl 1)**:000992

Introduction: Respiratory tract colonization is common in critically ill patients. However, its epidemiology and prognostic value in patients with hematological / solid organ malignancies is poorly investigated.

Objectives: To describe the epidemiology of respiratory tract colonization with *Candida* species in patients with solid organ cancer or hematological malignancies and to assess its prognostic impact.

Methods: Retrospective study conducted in two intensive care units. All patients with solid organ / hematological malignancies admitted between 01.01.2021 and 31.12.2022 requiring mechanical ventilation for ≥ 48 h were included. We excluded patients considered for end-of-life care. Two groups were compared: patients who grew *Candida spp* in their endotracheal aspirates (*Candida* (+)) and those who had negative endotracheal cultures for *Candida spp* (*Candida* (-)).

Results: We included 131 patients. Mean age was 59.6 ± 15 years. Mean SAPSII was 55.8 ± 20.3 . Mean duration of mechanical ventilation was 19.4 ± 16 days. Eighteen (13.7%) patients had underlying hematological malignancies while 113 patients (86.3%) had solid organ cancer. Forty patients (30.5%) were on active chemotherapy and 7 patients (5.3%) were neutropenic on admission. Twenty patients (15.3%) grew *Candida species* from the respiratory tract (*Candida albicans* and *Candida tropicalis* in 9 patients each and *Candida Dubliniensis* in two patients). Mean ICU length-of-stay was 19.7 ± 17.8 days. 28-day mortality rate was 39.7%.

Baseline characteristics were comparable between both groups. The incidence of ventilator-acquired pneumonia was also similar (40 Vs 41.5%; $p = 0.794$ in *Candida* (+) and *Candida* (-) groups respectively). Candiduria was significantly more common in *Candida* (+) group (55% vs 26.1%; $p = 0.01$). Although bloodstream infection rate was comparable between *Candida* (+) and *Candida* (-) groups (35% Vs 26.3%; $p = 0.195$), the rate of candidemia was significantly higher in *Candida* (+) group (25% Vs 7.2%; $p = 0.029$). The duration of mechanical ventilation and the length of stay in ICU was comparable between *Candida* (+) and *Candida* (-) groups (19.6 ± 11.4 vs 17.5 ± 20.8 days; $p = 0.237$ and 20.8 ± 15 vs 15.3 ± 20 days; $p = 0.666$). 28-day mortality rate was significantly higher in *Candida* (+) group (65% Vs 41.2%; $p = 0.024$).

Conclusions: Respiratory tract colonization is common in patients with underlying malignancies. It is associated with higher incidence of candidemia and higher 28-day mortality rate.

Topic: Sepsis

000993

Factors associated with serious fall-related injuries and deaths in elderly population of South Korea

K. S. Kim¹, G. S. Wang¹, H. Y. Kim², K. HeeJun¹, H. Park³, J. H. Huh¹, S. Han¹, S. J. Baek¹

¹Emergency Medicine, Seoul National University Hospital, Seoul, Republic of Korea; ²Emergency Medicine, Seoul National University Hospital, Seoul, Republic of Korea; ³Department of Emergency Medicine, Seoul National University Hospital, Seoul, Republic of Korea

Correspondence: K.S. Kim

Intensive Care Medicine Experimental 2023, **11(Suppl 1)**:000993

Introduction: Unintentional fall injuries are common in elderly population and cause significant morbidity and mortality worldwide.

Objectives: To identify factors associated with serious fall-related injuries and deaths.

Methods: EDISS (Emergency Department-based Injury Surveillance System) data of Korea Disease Control and Prevention Agency from 2015 to 2018 was retrospectively analyzed. Inclusion criteria were age ≥ 65 years old and fall injuries. Exclusion criteria were intentional injury and missing data. The serious injuries were defined as Injury Severity Score (ISS) over 15 or in-hospital deaths.

Results: A total of 81,768 unintentional fall injuries were observed during study period. Total admission rate, operation rate, intensive care unit admission rate, and mortality rate were 40.9%, 17.4%, 5.6%, and 1.6%, respectively. A total of 36,647 (44.8%) visits were classified as having serious injury. As a result of multivariate logistic regression

analysis, female sex (odds ratio [OR], 0.95; 95% confidence intervals [CI], 0.92–0.98), age group ($65 \leq \text{Age} < 75$ [Reference]; $75 \leq \text{Age} < 85$ [OR, 1.50; 95% CI, 1.45–1.54]; $85 \leq \text{Age}$ [OR 2.05; 95% CI, 1.96–2.14]), insurance status (National health insurance [Reference]; Medical aid [OR, 0.98; 95% CI, 0.93–1.03]; Uninsured [OR, 1.21; 95% CI, 1.07–1.35]), alcohol use (OR, 1.06; 95% CI, 1.00–1.13), and activities at the time of injury (Daily activity [Reference]; Leisure [OR, 0.94; 95% CI, 0.90–0.99]; Sports [OR, 0.62; 95% CI, 0.54–0.70]; Work [OR, 1.07; 95% CI, 0.99–1.15]; Housework [OR, 0.70; 95% CI, 0.67–0.73]; Others [OR, 1.42; 95% CI, 1.29–1.55] were independently associated with serious injury.

Conclusions: In Korean elderly population, 44% of unintentional fall injuries had serious injuries defined as ISS over 15 or in-hospital deaths. Male sex, old age, insurance status, alcohol use, and activities at the time of injury are associated with serious fall-related injuries and death. Based on these findings, active fall prevention interventions are warranted.

References

1. This work was supported by the Korea Disease Control and Prevention Agency (KDCA) and a grant of Patient-Centered Clinical Research Coordinating Center (PACEN) funded by the Ministry of Health & Welfare, Republic of Korea (grant number: HC21C0064)

Topic: Trauma

000995

The effect of increased speech and language therapist staffing on patient centred outcomes following tracheostomy

R. Cherian¹, A. McMahon², A. Murphy¹, B. Marsh¹, R. Morris¹, B. Elgammal², S. Keilthy¹, B. Sam Cherian¹, E. Mckean¹, N. O'leary¹, A. Flannery¹, S. Duggan¹

¹Intensive Care Unit, The Mater Misericordiae University Hospital, Dublin, Ireland; ²Anesthesia and Intensive Care, The Mater Misericordiae University Hospital, Dublin, Ireland

Correspondence: R. Cherian

Intensive Care Medicine Experimental 2023, **11(Suppl 1)**:000995

Introduction: Tracheostomy is the commonest surgical procedure performed in intensive care units (ICUs). The majority are performed to facilitate prolonged ventilatory weaning[1]. Previous research focused on timing, morbidity, and mortality following tracheostomy. Recently, focus has shifted to patient centred outcomes including mobility, communication, and oral intake. These are outcomes that really matter to patients. We have already shown that around two thirds of our patients achieve these outcomes[2]. Tracheostomy patients benefit from multidisciplinary input, including Speech & Language Therapy (SLT). Recent evidence has suggested that centres that do not have ready access to such resources may not see the same benefits in their tracheostomy patients [3].

Objectives: To assess the impact of an uplift in SLT staffing on tracheostomy patient centred outcomes and mortality.

Methods: This a longitudinal observational retrospective single-centre study. Data was collected from November 2020 to July 2022. All consecutive patients undergoing tracheostomy for any indication within 1 year of SLT uplift in staffing from 0.5 full time equivalent (FTE) to 2.5 FTE were included. De-identified patient data was retrieved from existing SLT and Advanced Nurse Practitioner databases and the critical care electronic patient record (IntelliSpace Critical Care and Anaesthesia, Phillips). Information was collected on patient demographics, severity of illness as assessed by APACHE II score, ICU and hospital length of stay (LOS). In addition to mortality, the main outcomes assessed were timing of tracheostomy, time to non-invasive ventilation (NIV), to ventilatory free breathing (VFB), duration of sedation, mobility, and SLT specific patient centred outcomes; days to verbal communication via one way valve (OWV), whether patients required fiberoptic endoscopic evaluation of swallowing (FEES) and ultimately

when they commenced oral intake. We compared outcomes for patients pre and post SLT uplift. Mortality data was compared using Chi-square testing. Non-parametric outcome data was compared using the Mann-Whitney U test. A two-tailed P value of <0.05 for each test was used for statistical significance. Data was analysed using Microsoft Excel and Prism 9 GraphPad.

Results: 96 patients underwent tracheostomy; 43 pre SLT uplift and 53 post. 74% were male, the mean age was 61, and mean APACHE II score was 22. Comparing pre-uplift and post-uplift, ICU mortality was 14% vs 8% ($p < 0.01$), and hospital mortality was 16% vs 23% ($p < 0.01$). Following tracheostomy, days of sedation were reduced from 3 to 1 ($p < 0.01$). Days to decannulation were 20 vs 28.5 ($p = 0.45$). Stepdown to Level 2 care was 10 vs 12 days ($p = 0.64$), days to first NIV trial was 6 vs 2 ($p < 0.01$) and days to 24 h VFB was 16 vs 19 ($p = 0.8$). Days to cuff deflation was 11 vs 4 ($p < 0.01$), OWV was 6.5 vs 5.0 ($p < 0.01$). Days to FEES was 21 vs 12 ($p = 0.07$). Time to verbal communication via OWV was decreased from 7 to 4 days ($p < 0.01$). Days to commencing oral intake was reduced from 18 to 9.5 days ($p = 0.03$). Days to sitting out of bed was 9 vs 7 ($p < 0.06$) and days to standing was 15 vs 14.5 ($p = 0.85$).

Conclusions: An increase in SLT resources reduced the time required to attain patient centred outcomes. We noted earlier SLT assessment and improved access to FEES. Patients had earlier oral intake, less sedation post tracheostomy, earlier NIV and mobilisation and reduced time to restoration of speech.

References

1. Guidance for: Tracheostomy Care. https://www.ficm.ac.uk/sites/default/files/2020-08-tracheostomy_care_guidance_final.pdf
2. Mc Mahon A, Griffin S, Gorman E, et al. Patient-Centred Outcomes Following Tracheostomy in Critical Care. *Journal of Intensive Care Medicine*. 2023;0(0). doi: <https://doi.org/10.1177/08850666231160669>
3. Sutt AL, Tronstad O, Barnett AG, Kitchenman S, Fraser JF. Earlier tracheostomy is associated with an earlier return to walking, talking, and eating. *Aust Crit Care*. 2020;33(3):213–218.
4. The author(s) received no financial support for the research, authorship, and/or publication of this article.

Topic: Acute respiratory failure and mechanical ventilation

000997

Severe preeclampsia and factors affecting the length of stay in the intensive care unit

L. Cortés-Puentes¹, V. Suarez², A. A. Valencia Moreno³, D. Molano⁴, M. Jose¹, R. Xiomara¹, O. Juliana¹

¹Critical Care Unit, Los Cobos Medical Center, Bogotá, Colombia;

²Cundinamarca, Los Cobos Medical Center, Bogotá, Colombia; ³Critical

care, Los Cobos Medical Center, Bogotá, Colombia; ⁴Medicina Crítica y Cuidado Intensivo, Foundation University of Health Sciences, Bogotá, Colombia

Correspondence: L. Cortés-Puentes

Intensive Care Medicine Experimental 2023, **11(Suppl 1)**:000997

Introduction: Patients with severe preeclampsia without complications are admitted to the intensive care unit (ICU) for monitoring during 24 to 48 h. However, an unexpected ICU prolonged stays has been present in the 25% of patients.

Objectives: The main of the present study is to assess the clinical characteristics of patients with severe preeclampsia who had a prolonged stay in the intensive care unit.

Methods: We retrospectively analyzed the patients admitted from January 2021 to December 2022 with diagnoses of severe preeclampsia, who did not meet the help syndrome criteria, without requiring vasopressor or ventilatory support. The clinical characteristics of the patients at ICU admission were analysed.

Results: During the study period, 185 patients were admitted in the intensive care unit, 88 patients met the inclusion criteria. 25% of the patients had a ICU stay for more than 48 h (average of 4.04 days). The age was 34.4 years, the Apache II severity score was 7.56 vs 6 of the patients with an expected stay. The history of hypertension and Diabetes Mellitus type 2 were higher in the group of patients with prolonged stay (36 and 18%, respectively). Likewise, the use of intravenous vasodilators prior to admission to the ICU was higher (40%). The clinical criterials for a prolonged stay were inadequate blood pressure control (36%) and the development of HELLP syndrome criteria (22%). No differences were found in Transaminases, Lactic Deshydrogens or renal function. There was no mortality.

Conclusions: At our institution, intensive care monitoring of patients with severe preeclampsia without complication criteria is less than 48 h. However, in our study, 25% of the patients had longer-than-expected stays, with a history of AHT and Dm, the use of vasodilators prior to ICU admission, and the APACHE II score being factors associated with unexpected prolonged stays.

References

1. Açaçayak E, Bugday R, Peker N, Deger U, Ölmez Kavak G, Evsen MS, Gul T. Factors Affecting ICU Stay and Length of Stay in the ICU in Patients with HELLP Syndrome in a Tertiary Referral Hospital. *Int J Hypertens*. 2022 Apr 18;2022:3366879. doi: <https://doi.org/10.1155/2022/3366879>. PMID: 35479732; PMCID: PMC9038419.

Topic: Systemic diseases

000998

Secondary peritonitis – can we de-escalate?

I. Cordeiro¹, M. Almeida¹, L. Cunha¹, A. Valente¹, P. Lavado¹, A. Baptista¹

¹Intensive Care Medicine Department, Serviço de Medicina Intensiva 2, Centro Hospitalar Universitário do Algarve – Unidade de Portimão, Portimão, Portugal

Correspondence: I. Cordeiro

Intensive Care Medicine Experimental 2023, **11(Suppl 1)**:000998

Introduction: Secondary peritonitis, the most common form of peritonitis, is one of the causes of sepsis in patients in intensive care units globally. It is defined as an acute peritoneal infection resulting from loss of integrity of the gastrointestinal tract. The gold-standart for the treatment consists in draining the septic focus and broad-spectrum antibiotics. Antimicrobial de-escalation is the discontinuation of one or more components of combination empirical therapy, and the change for a narrower spectrum antibiotic.

Objectives: This study aims to evaluate empiric antibiotic prescription in patients with the diagnostic of secondary peritonitis in an Intensive Care Unit in a distrital hospital.

Methods: We performed a retrospective study on patients with the diagnostic of secondary peritonitis admitted in our Intensive Care Unit from 1 January of 2021 until 31 December of 2022. We use SPSS, version 27. In the description of variables, frequencies and percentages were used in categorical variables, medians and quartiles, in continuous variables. The evaluation of the association of categorical variables was performed using the chi-square test, or Fisher's test, in case of non-compliance with Cochran's rules. The evaluation of the association of continuous variables was performed using the Mann-Whitney test, as they were compared between two groups. The significance level considered was 5%.

Results: The total number of patients suffering from secondary peritonitis during the 2 years was 69 with a prevalence of 0,069%. Among the patients enrolled 60% were male. The mean age was 70 y.o. In 71% of the patients the local of perforation was above duodenojejunal flexure. The vast majority went to the operation room (n = 68) and 79% of cases peritoneal fluid was collected but only 68% had blood cultures collected. The most common isolated agent was *Escherichia Coli* which was present in 19 patients (27,5%). The antibiotic therapy most popular between our physicians was ceftriaxone and metronidazole (30,4%) followed by cefuroxime plus metronidazole. Antifungal was empirically prescribed in 10 patients, but only 2 had peritoneal

cultures positive for fungus. Nevertheless, in the group that was not treated with antifungal, 11 patients had peritoneal cultures positive for fungus. Antibiotic de-escalation was possible in just 36% of patients based on cultures and sensitivity tests from the peritoneal fluid. The overall mortality in the ICU was 27,5%. The median number of agents isolated in the peritoneal fluid was 1 in the patients that survived but was 2 in the patients that died, with no statistical significance (p = 0.109). We identified a trend between the de-escalation of antibiotics and the lower number of agents isolated in peritoneal fluid (p = 0.086).

Conclusions: Secondary peritonitis is one of the most common fatal surgical emergencies. The mortality rate is about 20%, even in well equipped and trained environments. Although our study has some limitations, our data suggest that the broad-spectrum antibiotics are the best choice available. Our study also alert us about the incidence of peritoneal cultures positive for fungus. The decision to de-escalate antibiotic therapy remains for a selective group of patients with identified microorganisms and clinical improvement.

References

1. Clements TW, Tolonen M, Ball CG, Kirkpatrick AW. Secondary Peritonitis and Intra-Abdominal Sepsis: An Increasingly Global Disease in Search of Better Systemic Therapies. *Scandinavian Journal of Surgery*.
2. Jin, Y., & Higgins, J. (2020). The power of the chi-squared test and Fisher's exact test under different sampling schemes. *BMC Medical Research Methodology*, 20(1), 1–9. doi: <https://doi.org/10.1186/s12874-020-01104-2>
3. IBM Corp. (2020). IBM SPSS Statistics for Windows (Version 27.0) [Computer software]. IBM Corp.

Topic: Infections and prevention

000999

Improving the electronic documentation of daily reviews in intensive care to comply with the national standards of medical record keeping

G. Vellacott¹, T. Ali²

¹Critical Care, Stoke Mandeville Hospital, Aylesbury, United Kingdom;

²Anaesthetics and Critical Care, Stoke Mandeville Hospital, Aylesbury, United Kingdom.

Correspondence: G. Vellacott

Intensive Care Medicine Experimental 2023, **11(Suppl 1)**:000999

Introduction: Thorough and accurate documentation of the daily patient review is an integral component of intensive care practice. A high standard of documentation is crucial for clear communication between healthcare professionals, monitoring of patient progress, ensuring continuity of care as well as providing valuable evidence in legal settings. There are clear standards outlined by the General Medical Council (GMC) for which all medical record keeping should adhere to (1). The introduction of electronic patient records (EPRs) has become increasingly prevalent in intensive care units due to numerous proposed benefits over traditional paper-based record keeping including improving the clarity and quality of documentation, reducing potential errors and improving patient safety (2). However, despite the recent introduction of an electronic system to our intensive care unit (ICU), inaccuracies and incomplete documentation of the daily reviews persist.

Objectives:

1. To determine whether the documentation of daily reviews on a recently introduced EPR system adheres to national standards in an ICU in a District General Hospital (DGH).
 - a) Specifically, to evaluate whether the daily review documentation includes both the name of the reviewing doctor and the time of the review as outlined by the GMC in Good Medical Practice (1).
2. Improve the documentation of the daily review

Methods: Anonymised data was collected retrospectively from EPRs over a 2-week period both pre and post intervention in a DGH ICU. The intervention involved a departmental teaching session on the standards of medical record keeping and using the new system, department-wide email with the results and regular prompting from the consultant body. Data were analysed using MS Excel. Chi-squared analysis was used for comparing both periods. $P < 0.005$ was deemed statistically significant.

Results: There were 230 and 233 daily reviews included in the pre and post-intervention periods, respectively. 59.13% (136/230) of daily reviews included both the name of the reviewing doctor and the time of the review in the pre-intervention period, compared to 77.25% (180/233) in the post-intervention period. This increase was statistically significant with $P < 0.005$.

Conclusions: These results demonstrate that the introduction of EPRs into our intensive care unit has not completely resolved the inaccuracies and incompleteness associated with traditional paper records. Further improvements are still needed to meet the desired standard of 100% in keeping with the GMC's recommendations. However, this has demonstrated that simple interventions such as raising awareness, senior-led direction and regular prompting led to significantly improved documentation which is necessary to improve communication amongst the multidisciplinary team, protect patient safety and negate medicolegal implications.

References

1. General Medical Council, 2013. Good Medical Practice.
2. Pankhurst, T., Lucas, L., Ryan, S., Ragdale, C., Gyves, H., Denner, L., Young, I., Rathbone, L., Shah, A., McKee, D. and Coleman, J.J., 2023. Benefits of electronic charts in intensive care and during a world health pandemic: advantages of the technology age. *BMJ Open Quality*, 12(1), p.e001704.

Topic: Critical care organisation, quality management, information systems, outcomes

001001

Downtime and FUN/BUN comparison to evaluate the monitoring of the response to continuous renal replacement therapy in critically ill patients

R. Rodríguez Villanueva¹, J. C. Gasca-Aldama¹, J. Garduño-López¹, M. A. Amezcua-Gutiérrez¹, R. D. C. Gutiérrez Góngora¹, K. H. Lopez Rodríguez¹, M. Vidals-Sánchez¹, D. Navarro Martínez¹, N. L. Novoa Santander¹, J. E. Castrejón Sánchez¹, S. I. Alba Cuevas¹

¹Adult intensive care unit, Hospital Juárez de México, Ciudad de México, Mexico

Correspondence: R. Rodríguez Villanueva

Intensive Care Medicine Experimental 2023, **11(Suppl 1)**:001001

Introduction: Continuous renal replacement therapy (CRRT) is a treatment for critically ill patients with acute kidney injury, with the aim of offering support to renal function for a long time, for which its efficacy must be monitored; FUN/BUN ratio, is the relationship between BUN of the effluent liquid and the blood BUN, with a normal value of 1.0 ± 0.2 , which is suggested as a marker of adequate filter efficiency, determining it as an adequate marker to assess the removal of solutes and filter efficiency. Downtime, which is the percentage of time in which the CRRT process is not carried out effectively and entails a dose delivered less than that prescribed, ideally $< 20\%$ being an easily obtainable measure, at no extra cost, and could be considered more effective. To meet the goals of continuous renal replacement therapy, including recovery of renal function and optimization of supplies in places with limited resources. It is suggested that Downtime compared to FUN/BUN is equal or superior for monitoring the response to CRRT in critically ill patients.

Objectives: Compare the Downtime with the FUN/BUN for the response to the CRRT.

Methods: Ambispective, observational, longitudinal study. Through the review of records of patients who have been admitted to the ICU of Hospital Juárez de México from March 2022 to February 2023. Patients > 18 years in the ICU with CRRT requirement for > 24 h are included. The sample is not normal. Spearman's correlation were performed, to evaluate the efficacy of renal replacement therapy.

Results: 14 patients were identified, 8 women (57.2%), SOFA 15.07, APACHE II 28.01, SAPS II 59.7, mortality 43% (6), 87.1% (12) with sepsis, 57.1% (8) with a surgical component, 14.2% (2) neurocritical and 7.1% (1) autoimmune. Initiating continuous renal replacement therapy due to metabolic acidosis in 92.8% (13), hyperkalemia 35.7% (5), fluid overload 21.4% (3), associated with oliguria in 64.2% (9). With initial VEXUS at 1, IVC 1.9 cm, CVP 12.6 mmHg, ureis 0.26 ml/k/h, Renal resistive index (RRI) 0.71. A FUN/BUN ratio of 0.95 was found, Downtime of 7.6% equivalent to 110 min, in a range of 2 to 24%, maintaining an average transmembrane pressure of 75 mmHg, a filtration fraction of 12.6%; In the measurements at 24 h, urea excretion fraction of 36%, VEXUS 0.57, IVC 1.87 cm, ureis 0.24 ml/k/h, CVP 9.6 mmHg, RRI 0.69 and 0.70 are reported. Among the patients who recovered renal function, a total of 60 h was reported for said outcome and a total of 70.6 h for the withdrawal of the CRRT. In the correlation of FUN/BUN with Downtime, no significant difference ($p = 0.054$) was found to assess the efficacy of CRRT. We also found that absence of renal function recovery is associated with higher mortality ($p = 0.035$).

Conclusions: In our study, Downtime is not inferior to FUN/BUN for monitoring the efficacy of CRRT with respect to the response to CRRT.

References

1. Ronco, C., & Reis, T. (2021). Continuous renal replacement therapy and extended indications. *Seminars in dialysis*, 34(6), 550–560. doi: <https://doi.org/10.1111/sdi.12963>
2. Rachoïn, J. S., & Weisberg, L. S. (2019). Renal Replacement Therapy in the ICU. *Critical care medicine*, 47(5), 715–721. doi: <https://doi.org/10.1097/CCM.0000000000003701>
3. Kee, Y. K., Kim, E. J., Park, K. S., Han, S. G., Han, I. M., Yoon, C. Y., Lee, E., Joo, Y. S., Kim, D. Y., Lee, M. J., Park, J. T., Han, S. H., Yoo, T. H., Kim, B. S., Kang, S. W., Choi, K. H., & Oh, H. J. (2015). The effect of specialized continuous renal replacement therapy team in acute kidney injury patients treatment. *Yonsei medical journal*, 56(3), 658–665. doi: <https://doi.org/10.3349/ymj.2015.56.3.658>
4. Legrand, M., & Tolwani, A. (2021). Anticoagulation strategies in continuous renal replacement therapy. *Seminars in dialysis*, 34(6), 416–422. doi: <https://doi.org/10.1111/sdi.12959>
5. Wang, L., Li, J., Sun, S., Du, H., Chen, P., Xu, Y., Shen, Y., Xin, S., Dan, Y., Li, H., Chen, J., Li, Z., & Su, B. (2021). Predictors of successful discontinuation from renal replacement therapy during AKI: A meta-analysis. *Seminars in dialysis*, 34(2), 137–146. doi: <https://doi.org/10.1111/sdi.12936>
6. Ricci, Z., Tolwani, A., & Lumlertgul, N. (2020). Precision renal replacement therapy. *Current opinion in critical care*, 26(6), 574–580. doi: <https://doi.org/10.1097/MCC.0000000000000776>
7. Claire-Del Granado, R., Macedo, E., Chertow, G. M., Soroko, S., Himmel-farb, J., Ikizler, T. A., Paganini, E. P., & Mehta, R. L. (2012). Toward the optimal dose metric in continuous renal replacement therapy. *The International journal of artificial organs*, 35(6), 413–424. doi: <https://doi.org/10.5301/ijao.5000041>
8. Tsujimoto, Y., & Fujii, T. (2022). How to Prolong Filter Life During Continuous Renal Replacement Therapy?. *Critical care (London, England)*, 26(1), 62. doi: <https://doi.org/10.1186/s13054-022-03910-8>
9. Gaudry, S., Palevsky, P. M., & Dreyfuss, D. (2022). Extracorporeal Kidney Replacement Therapy for Acute Kidney Injury. *The New England journal of medicine*, 386(10), 964–975. doi: <https://doi.org/10.1056/NEJMr2104090>

10. Argaiz, E. R., Rola, P., Haycock, K. H., & Verbrugge, F. H. (2022). Fluid management in acute kidney injury: from evaluating fluid responsiveness towards assessment of fluid tolerance. *European heart journal. Acute cardiovascular care*, 11(10), 786–793. doi: <https://doi.org/10.1093/ehjacc/zuac104>

Topic: Acute Kidney Injury and haemofiltration

001002

Therapeutic removal of cfDNA/NETs with NucleoCapture® apheresis in a Prolonged Clinically Relevant Porcine Intensive Care Sepsis Model

A. Aswani¹, D. Genkin², K. Surkov², P. Skorup³, R. Varsebroucq⁴, M. Wargnies⁴, J. Candiracci⁴, M. Herzog⁴, J. Micallef⁴, M. Lipcsey⁵
¹Dept of Intensive Care Medicine, Guy's and St Thomas' NHS Foundation Trust, London, United Kingdom; ²Therapeutic apheresis, Santerus AG, Zürich, Switzerland; ³Section of infectious diseases, department of medical sciences, Uppsala University, Uppsala, Sweden; ⁴VolitionRx, Belgian Volition SRL, Isnes, Belgium; ⁵Surgical sciences, Uppsala University, Uppsala, Sweden

Correspondence: A. Aswani

Intensive Care Medicine Experimental 2023, **11(Suppl 1)**:001002

Introduction: Cell-free DNA (cfDNA)/Neutrophil Extracellular Traps (NETs) are associated with sepsis. We previously demonstrated that NucleoCapture® selective cfDNA/NETs apheresis improved organ function and survival in a 7-h model of porcine sepsis. We therefore investigated the use of NucleoCapture® in an extended 24-h clinically relevant porcine intensive care model of sepsis.

Methods: We induced sepsis in two pigs with a 2-h intravenous infusion of *Pseudomonas aeruginosa*. Antibiotics were administered at either 6 h or earlier if the norepinephrine requirement was greater than 0.1 mg/kg/min. One pig was subjected to NucleoCapture® apheresis using the Terumo Optia system with regional citrate anticoagulation for 8 h, followed by a further dose of antibiotics. A second NucleoCapture® treatment was then applied for another 8 h. The other pig was subjected to the same protocol with sham column apheresis. We measured cfDNA/NETs using the NuQ H3.1 nucleosome assay (Volition).

Results: The baseline levels of circulating cfDNA/NETs measured in the NucleoCapture® and sham treated pigs were 2.52 ng/ml and 1.64 ng/ml, respectively. Infusion of *Pseudomonas aeruginosa* resulted in an increase in cfDNA/NETs to 82.6 ng/ml and 87.4 ng/ml, respectively.

The level of cfDNA/NETs in the sham treated pig rose continuously during the experiment reaching 508.9 ng/ml. In contrast, NucleoCapture® treatment caused a sustained decrease in cfDNA/NET levels to 20.9 ng/ml by the end of the experiment (Figure 1).

The suppressed cfDNA/NETs level in the NucleoCapture® treated pig was consistent with the attenuation of septic shock as evidenced by a marked fourfold reduction in the total norepinephrine requirement: 3,725 µg vs 13,841 µg (Figure 2). The NucleoCapture® treated pig also produced more urine: 3,260ml vs 2,531ml.

Conclusions: In this extended 24 h clinically relevant model of porcine sepsis, which included the use of antibiotics and intensive care support, prolonged selective cfDNA/NETs apheresis with NucleoCapture® effectively removed cfDNA/NETs from the circulation and resulted in improved physiological indicators. We aim to progress the investigation of NucleoCapture® to clinical trials in sepsis and other indications.

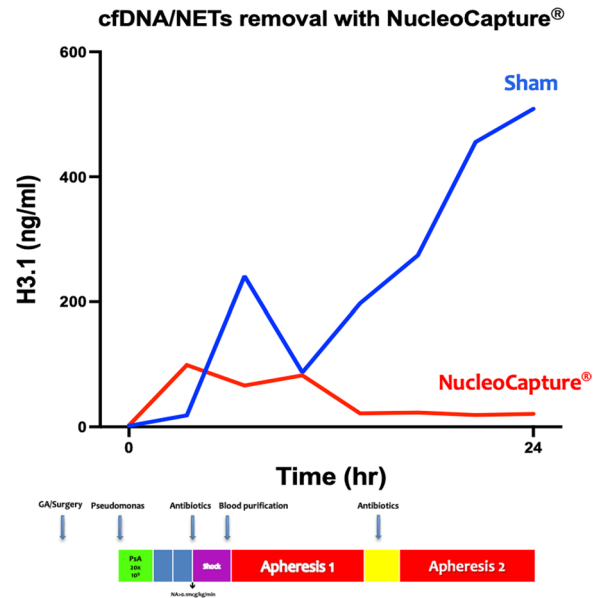

Figure 1 (abstract 001002) Plasma cfDNA/NETs levels in PsA challenged animals over 24h. The NucleoCapture treated animal (red line) showed consistently low levels of cfDNA/NETs as measured by the NuQ H3.1 assay (Volition) compared to the Sham treated animal (blue line)

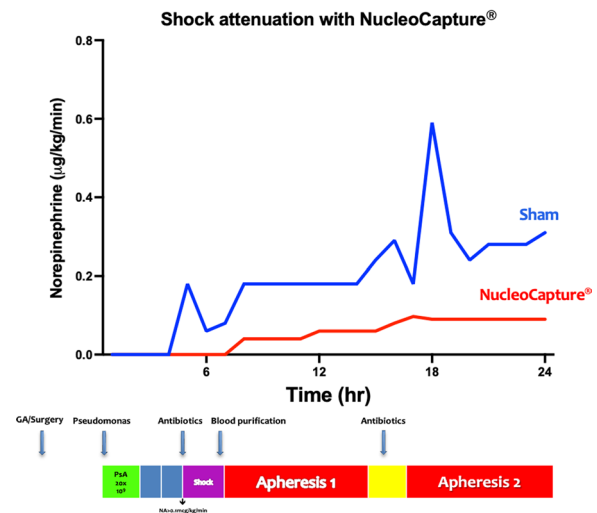

Figure 2 (abstract 001002) Shock attenuation with NucleoCapture. Hourly norepinephrine requirements (mcg/kg/min) are depicted for the NucleoCapture (red line) and Sham treated animals (blue line). The total norepinephrine requirement was 3,725 µg (NC) vs 13,841 µg (Sham)

References

- Singh, J., Boettcher, M., Dölling, M., Heuer, A., Hohberger, B., Leppkes, M., Naschberger, E., Schapher, M., Schauer, C., Schoen, J., et al. (2023). Moonlighting chromatin: when DNA escapes nuclear control. *Cell Death Differ*, 1–15. <https://doi.org/10.1038/s41418-023-01124-1>
- Noñ, C.P., Wang, P., and Aziz, M. (2022). Chromatin-Associated Molecular Patterns (CAMPs) in sepsis. *Cell Death Dis* 13, 700. <https://doi.org/10.1038/s41419-022-05155-3>
- McDonald, B., Davis, R.P., Kim, S.-J., Tse, M., Esmon, C.T., Kolaczowska, E., and Jenne, C.N. (2017). Platelets and neutrophil extracellular traps collaborate to promote intravascular coagulation during sepsis in mice. *Blood* 129, 1357–1367. <https://doi.org/10.1182/blood-2016-09-741298>
- Clark, S.R., Ma, A.C., Tavener, S.A., McDonald, B., Goodarzi, Z., Kelly, M.M., Patel, K.D., Chakrabarti, S., McAvoy, E., Sinclair, G.D., et al. (2007). Platelet TLR4 activates neutrophil extracellular traps to ensnare bacteria in septic blood. *Nature medicine* 13, 463–469. <https://doi.org/10.1038/nm1565>
- Fuchs, T.A., Abed, U., Goosmann, C., Hurwitz, R., Schulze, I., Wahn, V., Weinrauch, Y., Brinkmann, V., and Zychlinsky, A. (2007). Novel cell death program leads to neutrophil extracellular traps. *J Cell Biology* 176, 231–241. <https://doi.org/10.1083/jcb.200606027>
- AA is Chief Medical Officer of Santerus AG

Topic: Translational Medicine

001007

Usefulness of high flow nasal cannulas (HFNC) in the Intensive Care Unit (ICU) in patients with mild to moderate Acute Respiratory Failure (ARF)

R. Carbajal-Serrano¹, A. Sanchez-Calzada¹, P. Mora-Ruiz¹, J. Aguirre Sánchez¹

¹Intensive care unit, The American British Cowdray Medical Center, City Mexico, Mexico

Correspondence: R. Carbajal-Serrano

Intensive Care Medicine Experimental 2023, **11(Suppl 1)**:001007

Introduction: The (HFNC) have demonstrated their usefulness in various clinical scenarios, pulmonary and extrapulmonary pathologies. They provide a flow of up to 60 L/min. The potential benefits of this therapy are: improvement of the respiratory pattern with improvement of the RR and peripheral saturation, the Rox index (SpO₂/FIO₂)/RR has a high sensitivity to predict HFNC failure, greater than 4.88 at 12 h predict success of therapy.

Objectives: To evaluate the usefulness of HFNC in the ICU in patients with mild to moderate ARF.

Methods: Retrospective, observational study. Sociodemographic, clinical, and gasometric data were recorded. Inclusion criteria: both sexes, over 18 years of age, stay of more than 24 h, HFNC therapy for ARI. Exclusion criteria: severe ARF, under 18 years of age, without central venous catheter. ARF was classified as mild (SAFI > 200), moderate (100–200), the qualitative variables are reported in frequencies and percentages, normality tests were performed for quantitative variables, those of normal distribution were reported mean and SD, confidence intervals (CI). For variables of free distribution median and percentiles 25 and 75. For comparison of qualitative variables, X² will be used, quantitative parametric variables t of student, a p < 0.05 as significant.

Results: 71 patients, 59% male (N = 42) and 41% female (n = 29), were analyzed. Mean age was 69 ± 12 (28–96 years), APACHE II mean 16 ± 6 (5–31), SAPS II mean 32 ± 13 (8–71), SOFA at admission 6 ± 3 (1–15), SOFA at the beginning of HFNC 4 ± 2 (1–10). 80% (n = 57) medical admission, 15% (n = 11) surgical; pulmonary pathology 59% (n = 42) and extrapulmonary 41% (n = 29), 60% (n = 43) type 1 insufficiency, 23% (n = 16) type 2. Most frequent site of pulmonary infection 42% (n = 30), abdominal 15% (n = 10). Ventilatory support before HFNC: 73% (n = 52) simple nasal prongs, 3% (n = 2) required IMV. Mean days of HFNC use of 4 ± 3 days, 42% (n = 30) with oncological pathology, most frequent colon cancer 23% (n = 7), days of stay in the ICU median 15 days (1–54) and mortality 19% (n = 14). The most frequent cause of death was septic shock of pulmonary and abdominal origin. At the time of initiation of HFNC therapy, a statistically significant difference was obtained with p < 0.05 in PH, PCO₂,

PO₂, FIO₂, RR, SaO₂/FIO₂ and central venous saturation, no statistically significant difference was obtained in peripheral oximetry.

Conclusions: The HFNC are useful in pathologies such as pneumonia, septic shock (pulmonary and abdominal) and oncology. Patients after the use of HFNC improved both hypoxemic and hypercapnic acute respiratory failure. The corrected blood gas changes were pH, PO₂, PCO₂, respiratory rate, and central venous saturation from the time of HFNC onset.

Table 1. Demographic characteristics of patients with high-flow nasal cannulas	
Characteristics	n=71
Age	69 ± 12.5 (28-96)
Male	59 % (42)
SOFA income	6 ± 3 (1-15)
SOFA at start HFNC	4 ± 2 (1-10)
APACHE income	16 ± 6.4 (5-31)
SAPS II income	32 ± 13 (8-71)
Type of hospital admission	
Medico	80% (n=57)
Surgical	15% (n=11)
Trauma	5% (n=3)
Type of pathology	
Pulmonary Pathology	59% (n=42)
Extrapulmonary Pathology	41% (n=29)
Affected system	
Respiratory	59% (n=42)
Cardiovascular	9% (n=7)
Gastric	21% (n=15)
Neurological	3% (n=2)
Type of respiratory failure	
Type 1 hypoxemic	60% (n=43)
Type 2 hypercapnic	23% (n=16)
Type 3 mixed	17% (n=12)
Infection site	
Pulmonary	42% (n=30)
Abdominal	15% (n=10)
Soft tissues	3% (n=2)
Urinary	2% (n=1)
Oncological	42% (n=30)
Initial oxygen therapy	
Simple nasal prongs	73% (n=52)
BIPAP	21% (n=15)
CPAP	3% (n=2)
Invasive mechanical ventilation	3% (n=2)
HFNC days of use	4 (0-23)
Days of hospital stay	15 (1-54)
Deaths	19% (n=14)

Table 2. Comparison of gasometric and clinical values after the use of HFNC			
	high-flow nasal cannulas		Value p
	HFNC start	1 hour of use of HFNC	
PH	7.40 ± 0.06 (7.22-7.54)	7.42 ± 0.05 (7.30-7.52)	0.001
PO ₂	37 ± 5.92 (26-56)	38 ± 5.93 (28-55)	0.018
PCO ₂	45 ± 9.25 (28-68)	43 ± 8.74 (27-83)	0.014
Central venous saturation	66 ± 8.83 (39-82)	70 ± 8.73 (49-89)	0.000
FIO ₂	52 ± 13.21 (30-100)	61 ± 14.03 (35-100)	0.000
peripheral oximetry	95 ± 3.4 (85-100)	96 ± 4.54 (87-100)	0.063
Breathing frequency	24 ± 4.91 (11-40)	20 ± 3.88 (11-31)	0.000
SaO ₂ /FIO ₂	196 ± 52.23 (96-286)	166 ± 39.71 (98-327)	0.000
Heart rate	82 ± 15.51 (54-125)	81 ± 17.05 (53-156)	0.739
TAM	83 ± 12.10 (56-120)	80 ± 11.893 (56-112)	0.058
Rox index	8.27 ± 2.66 (3.75-16.67)	8.49 ± 2.46 (3.57-17.64)	0.419

References

1. Giarratano A, High flow nasal therapy in immunocompromised patients with acute respiratory failure: A systematic review and meta-analysis. *Journal of Critical Care*. 2019; 50:250–256.
2. Di Mussi R, High-flow nasal cannula oxygen therapy decreases post-tubation neuroventilatory drive and work of breathing in patients with chronic obstructive pulmonary disease. *Critical Care* (2018) 22:180
3. 7. Spoletini G, High-flow nasal therapy versus standard oxygen during interruptions of non-invasive ventilation for acute respiratory failure: a randomized controlled pilot trial. *J Crit Care*. 2018; 48: 418–425
4. 6. Ischaki E, Nasal high flow therapy: a novel treatment rather than a more expensive oxygen device. *Eur Respir Rev* 2017; 26
5. 5. Parke RL, Pressures delivered by nasal high flow oxygen during all phases of the respiratory cycle. *Respir Care*. 2013; 58 (10):1621–4
6. 4. Papazian L, et al. Use of high-flow nasal cannula oxygenation in ICU adults: a narrative review. *Intensive Care Med*. 2016; 42 (9):1336–49.
7. 3. Romero DC, Pathophysiological basis of acute respiratory failure on non invasive mechanical ventilation. *Open Respir Med J*. 2015; 9(Suppl 2):97- 103
8. 2. Azoulay E, Effect of High-Flow Nasal Oxygen vs. Standard Oxygen on 28- Day Mortality in Immunocompromised Patients With Acute Respiratory Failure The HIGH Randomized Clinical Trial. *JAMA*. 2018; 320: 2099–2107

Topic: Acute respiratory failure and mechanical ventilation

001008

Safety of antitumor treatment in critically ill patients in the ICU

V. Nieto¹, D. Molano², A. Martinez³, J. Mojica¹, A. Rojas¹

¹Intensive Care Medicine, Centro de tratamiento e investigación sobre Cáncer Luis Carlos Sarmiento Angulo, Bogotá, Colombia; ²Medicina crítica y cuidado intensivo, Foundation University of Health Sciences, Bogotá, Colombia; ³Public Health department, CES University, Medellín, Colombia

Correspondence: V. Nieto

Intensive Care Medicine Experimental 2023, **11(Suppl 1)**:001008

Introduction: About 25% of oncologic patients will require management in the Intensive Care Unit. Currently, survival is comparable with non-oncologic patients. Survival rates depend on the intensity and timing of interventions, including oncologic treatment (chemotherapy, immunotherapy, and radiotherapy), however, there is uncertainty in the safety of these interventions.

Objectives: To describe the safety of antitumor treatment in critically ill patients in an ICU of a high complexity cancer center in Bogotá.

Methods: Retrospective cohort of patients hospitalized in an oncologic ICU from July 2022 to January 2023. Relative and absolute frequencies were used to describe qualitative variables. For quantitative variables central tendency and dispersion measures were calculated. A bivariate analysis was performed with the calculation of a crude Odds Ratio (OR) for the variables related to sepsis and a multivariate analysis by logistic regression for the calculation of adjusted OR for sepsis and mortality.

Results: 105 patients were analyzed, 47.6% were female, the sample mean age was 60 years SD 15.7. The ratio of medical Vs surgical patients was nearly 1:1, 76.2% of the sample had solid tumors, 56.2% received chemotherapy, 10.5% immunotherapy and 2.9% received radiotherapy in the ICU. Thirty-one patients had sepsis, 30.5% presented with shock and 22.9% received mechanical ventilation. Mortality was 18.1%. In the bivariate analysis the factors associated to sepsis were medical patients, hematological tumor, chemotherapy, immunotherapy, mechanical ventilation and shock. The multivariate analysis showed that the only variable that kept its association with sepsis was medical patient OR 7.9 (95% CI 1.8-7.35). The analysis for mortality showed that medical patient and vasopressor use were the only variables with a role in said outcome. Table 1. Chemotherapy and immunotherapy were not associated with sepsis or mortality.

Table 1 (abstract 001008) Data distribution and adjusted odds ratio for sepsis in oncological patients

Variable	Cohort(105)	No sepsis (74)	Sepsis(31)	p- value	OR (CI 95%)	Adjusted OR for sepsis	Adjusted OR for mortality
Age*	60,3 ± 15,7	59,6 ± 16,1	61,8 ± 14,9	0,5			
Gender	50 (47,6)	37(74)	13(26)	0,45			
Female †							
Medical patient	52 (49,5)	25(48,1)	27(51,9)	0,0001	6,8(2,5–18,2)	7,9 1,8–7,35	17,8 3,2–98,3
Surgical patient	53 (50,5)	49(92,5)	4(7,5)				
Neutropenia	9(8,6)	4(44,4)	5(55,6)	0,07			
Solid tumor	80(76,2)	65(81,3)	15(18,8)				
Hematological	25 (23,8)	9(36)	16(64)	0,0001	3,4(1,9–5,8)		
SAPS III	58,4 ± 21,7	52,1 ± 19,6	58,4 ± 21,7	0,0001			
Type of oncologic treatment received in the ICU†							
chemotherapy	59(56,2)	36(61)	23(39)	0,016	3 (1,2–7,6)	1 0,2–4,0	0,32 0,06–1,5
Immunotherapy	11(10,5)	2(18,8)	9(81,8)	0,0001	14,7(2,9–73,2)	0,10,01–1,6	1,6 0,2–11,2
Radiotherapy	3(2,9)	2(66,7)	1(33,3)	0,88			
Organ dysfunction, supports and outcomes †							
Shock	32(30,5)	12(37,5)	20(62,5)	0,0001	9,3(3,5–24,5)		
Vasopressor	8(45,7)	29(60,4)	19(39,6)	0,03	2,4(1–5,8)		29,7 5,5–160,5
Inotropic	24(22,9)	11(45,8)	13(54,2)	0,003	4,1(1,5–10,7)		
M. ventilation	24(22,9)	10(41,7)	14(58,3)	0,0001	5,2(1,9–13,9)		
Length of stay*	4,3 ± 4	3,7 ± 2,6	5,7 ± 6,1	0,01			
Bacteremia	15(14,3)	7(46,7)	8(53,3)	0,029	3,3(1–10,1)		
Mortality †	19(18,1)	6(31,6)	13(68,4)	0,0001			

* Mean ± standard deviation † Frequency (percentage).

Conclusions: Antitumor treatment was not associated in this cohort with sepsis or death in the ICU suggesting that it is a safe therapy to administer in critically ill patients with cancer that doesn't necessarily increase the risk of critical outcomes.

References

1. Kanji S, MacLean E, Rashid FJ, Pittman M, Trinacty M, Allan D, Rosenberg E. Chemotherapy in the Intensive Care Unit: An Evaluation of Context and Outcomes. *Can J Hosp Pharm*. 2020 Fall;73(4):279–287. Epub 2020 Oct 1. PMID: 33100360; PMCID: PMC7556399.
2. This research did not receive financial support from third parties.

Topic: Haematologic-oncologic issues in the ICU

001010

Mortality difference according to the time difference between rapid response team (RRT) screening to ICU transfer

W. Y. Lee¹, K. C. Cha², Y. I. Rho³, S. W. Park⁴, Y. U. Choi⁵

¹Division of Pulmonary, Allergy, and Critical Care Medicine, Yonsei University Wonju College of Medicine, Wonju Severance Christian

Hospital, Wonju-si, Republic of Korea; ²Emergency Medicine, Yonsei University Wonju College of Medicine, Wonju-si, Republic of Korea; ³Emergency Medicine, Yonsei University Wonju College of Medicine, Wonju, Republic of Korea; ⁴Department of Internal Medicine, Yonsei University Wonju College of Medicine, Wonju, Republic of Korea; ⁵Surgery, Yonsei University Wonju College of Medicine, Wonju, Republic of Korea.

Correspondence: W.Y. Lee

Intensive Care Medicine Experimental 2023, **11(Suppl 1)**:001010

Introduction: The rapid response team (RRT) has the role of early detection of patient liability and managing to prevent patient derangement. After screening the patient by RRT, unstable patients should be transferred to ICU and should be managed actively. Sometimes we can not transfer the patient to the ICU immediately, depending on many circumstances, such as the ICU capability.

Objectives: We observed the ICU mortality rate and 28 days mortality rate according to the time difference from RRT screening to ICU transfer (ICU transfer time).

Methods: We reviewed RRT cohort of Yonsei University Wonju Severance Christian Hospital from March 2022 to January 2023, and analyzed the data of patients transferred to MICU from the general ward. We compare the ICU mortality rate and 28 days mortality rate according to ICU transfer time.

Results: The total analyzed patient number was 260(149 were screened (RRTs), 111 were RRT non-screened (RRTNS). The ICU and 28 days mortality rates of total patients were 27.7% and 30.8%.

The ICU and 28 days mortality rates of RRTs and RRTNS groups were 26.8% vs 28.8%($P > 0.05$) and 30.9% vs 30.6%($P > 0.05$).

ICU mortality and 28 days mortality rates of patients transferred to ICU within the 5th hospital day were lower than after the 5th hospital day (25/121(20.7%) vs 47/139(33.8%), $P = 0.018$).

The median ICU transfer time was 9 h (0.5-24h). Seventy-one patients (52.3%) among 149 RRTs were transferred to MICU within 9 h after RRTs.

The ICU transfer times of ICU survivors and non-survivors were 8.4 ± 4.1 h vs 9.2 ± 4.1 h ($P > 0.05$) and the ICU transfer time of 28 days survivors and non-survivors were 8.4 ± 4.0 days, 8.9 ± 4.2 days ($P > 0.05$).

The ICU and 28 days mortality rates were lower in the shorter ICU transfer time group (≤ 9 h) than longer ICU transfer time group (> 9 h) [(24.4% vs 29.6%)($p > 0.05$), 28.2% vs 33.8%, $P > 0.05$).

Conclusions: The shorter ICU Transfer time after RRT screening seemed to make lower ICU and 28 days mortality rates after ICU transfer.

Topic: Cardiac arrest

001011

Regulation of cerebral blood flow during intra-operative hyperoxia

R. van den Dool¹, L. Batelaan¹; D. P. Veelo¹, J. Schenk¹, M. W. Hollmann¹, A. P. J. Vlaar², N. Sperna Weiland¹, R. Immink¹

¹Anesthesiology, Amsterdam UMC, Locatie AMC, Amsterdam, Netherlands; ²Intensive Care, Amsterdam UMC, Locatie AMC, Amsterdam, Netherlands.

Correspondence: R. van den Dool

Intensive Care Medicine Experimental 2023, **11(Suppl 1)**:001011

Introduction: The recommendation of the World Health Organization to increase the intraoperative fraction of inspired oxygen (FiO₂) to 0.8 throughout surgery has sparked much debate (1). Although meant to decrease the incidence of surgical site infections (SSI) (1–3), its safety is controversially discussed (4). Hyperoxia may be detrimental to the brain, as some studies have reported an association between hyperoxia and increased mortality in neurocritical care patients (5, 6). The effect of hyperoxia on cerebral hemodynamics during general anesthesia is still not fully elucidated. While hyperoxia leads to a small reduction in CBF in awake patients, it is unknown

whether anesthetics could affect this relationship. Furthermore, there is circumstantial evidence that increased cerebrovascular tone leads to an improved cerebral autoregulation (CA) (7–9). Here, we quantified the effect of intra-operative hyperoxia (FiO₂ of 1.0) compared to FiO₂ 0.4 on CBF and cerebral autoregulation (CA). We hypothesize that during hyperoxia and general anesthesia, CBF is lowered and dynamic CA improves.

Objectives: The aim of this study was to quantify the effect of intraoperative hyperoxia on CBF and CA during general anesthesia.

Methods: We studied ASA I/II patients undergoing non-cardiothoracic, non-neurosurgical and non-laparoscopic surgery under general anesthesia. During stable hemodynamic conditions, we increased FiO₂ from 0.4 to 1.0. Mean middle cerebral artery blood velocity (MCAV_{mean}) was measured to estimate changes in CBF. Dynamic CA was determined using transfer function analysis and expressed as the phase lead (°) between MAP and MCAV_{mean} oscillations, created with positive pressure ventilation with a frequency of 6 min⁻¹.

Results: Thirty-five patients were included for this study. Twelve patients received propofol-based anesthesia, and 23 patients received sevoflurane-based anesthesia. No statistically significant differences in cerebral hemodynamics were found between FiO₂ 0.4 and 1.0 during general anesthesia.

Conclusions: CBF and CA did not differ within patients in the presence of FiO₂ 0.4 and 1.0 during general anesthesia. Cerebrovascular changes induced by hyperoxia seem relatively small compared to changes already induced by anesthesia. However, because arterial oxygen content is increased, a beneficial effect is possible.

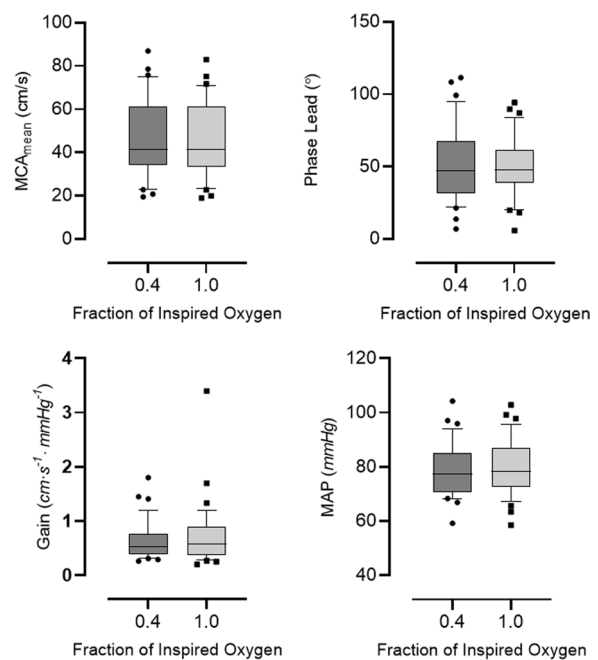

Box-plots of MCAV_{mean}, phase lead, gain and MAP between FiO₂ 0.4 and 1.0. Data points outside the 10-90th percentile are displayed individually

References

1. 6. Damiani E, Adrario E, Girardis M, Romano R, Pelaia P, Singer M, et al. Arterial hyperoxia and mortality in critically ill patients: a systematic review and meta-analysis. *Critical Care*. 2014;18(6):1–16.

2. Rincon F, Kang J, Maltenfort M, Vibbert M, Urtecho J, Athar MK, et al. Association between hyperoxia and mortality after stroke: a multicenter cohort study. *Crit Care Med*. 2014;42(2):387–96.
3. Hedenstierna G, Perchiazzi G, Meyhoff CS, Larsson A. Who can make sense of the WHO guidelines to prevent surgical site infection? *Anesthesiology*. 2017;126(5):771–3.
4. Sepehrvand N, Ezekowitz JA. Oxygen Therapy in Patients With Acute Heart Failure: Friend or Foe? *JACC Heart Fail*. 2016;4(10):783–90.
5. Ball L, Lumb AB, Pelosi P. Intraoperative fraction of inspired oxygen: bringing back the focus on patient outcome. *Br J Anaesth*. 2017;119(1):16–8.
6. Weenink RP, de Jonge SW, van Hulst RA, Wingelaar TT, van Ooij PAM, Immink RV, et al. Perioperative Hyperoxyphobia: Justified or Not? Benefits and Harms of Hyperoxia during Surgery. *J Clin Med*. 2020;9(3):642.
7. Strebel S, Lam AM, Matta B, Mayberg TS, Aaslid R, Newell DW. Dynamic and static cerebral autoregulation during isoflurane, desflurane, and propofol anesthesia. *Anesthesiology*. 1995;83(1):66–76.
8. van den Dool RE, Immink RV, van der Ster BJ, Hermanides J, Hol-Imann MW, Preckel B, et al. The influence of carbon dioxide on cerebral autoregulation during sevoflurane-based anesthesia in patients with type 2 diabetes. *J Neurosurg Anesthesiol*. 2023;35(1):65–73.
9. Rokus E.C. van den Dool NHSW, Jimmy Schenk, Eline Kho, Denise P. Veelo, Björn J.P. van der Ster and Rogier V. Immink. Dynamic cerebral autoregulation during step-wise increases in blood pressure during anaesthesia: a non-randomised interventional trial *Eur J Anaesthesiol*. 2023; Accepted for publication.
10. R. van den Dool received a grant from Edwards Lifesciences outside the submitted work. D. Veelo and A. Vlaar received of personal fees and other from Edwards Lifesciences outside the submitted work.

Topic: Neurointensive care

001012

Journey to accreditation: Enhancing skills of the critical care outreach team through point of care echocardiography (POCUS) training for nurses

F. Logan¹, D. Hadfield², J. Dainton³, R. Fisher², A. Jordan³, M. Langan³, H. Lansangan³, E. Madine³, L. Mchugh³, P. McDougall³, V. Metaxa², J. Mecklenburgh³, S. Hadfield³

¹Critical Care Outreach, Kings College Hospital NHS Foundation Trust, London, United Kingdom; ²Critical care, King's College Hospital, London, United Kingdom; ³Critical Care Outreach, King's College Hospital, London, United Kingdom

Correspondence: F. Logan

Intensive Care Medicine Experimental 2023, **11(Suppl 1)**:001012

Introduction: In acute patient deterioration, point-of-care-ultrasound (POCUS) can inform early targeted management, potentially improving patient outcomes 1,2. Part of a wider project evaluating nurse-led POCUS in acute sepsis, here we describe the feasibility of POCUS training for nurse members of a critical care outreach team (CCOT) in a large teaching hospital.

Objectives: Among a sample of CCOT nurses:

1. To evaluate the feasibility of POCUS training.
2. To explore barriers and facilitators to POCUS training.

Methods: To gain POCUS accreditation, nurses were required to complete the UK Resus Council's Focused Echocardiography in Emergency Life Support (FEEL) course, consisting of a one-day taught course and 50 assessed echocardiogram scans. Feasibility was assessed as numbers achieving accreditation. An electronic survey explored barriers and facilitators to accreditation. Descriptive data are presented. Appropriate institutional approvals were obtained.

King's College Hospital is a large, 950 bed, multi-specialty, tertiary referral and teaching hospital. The CCOT provides 24/7 specialist support and stabilisation for the most unwell patients on the wards. The CCOT is multi-disciplinary consisting of critical care trained nurses and doctors and a consultant lead.

Results: A total of 10 nurses commenced the FEEL course: six in 2021 and four in 2022. All completed the taught one-day course. Amongst the 2021 cohort at 18 months, 3 nurses (50%) had completed 50 assessed scans and achieved full accreditation, 1 nurse (17%) is likely to achieve accreditation within 24 months, 1 nurse (17%) re-located and 1 nurse (17%) paused their studies due to personal reasons. Amongst the 2022 cohort at 6 months, 3 nurses (75%) had completed >50% of scans, but none had achieved accreditation. Survey responses (n = 10) revealed that lack of confidence, prioritising other work, and general time constraint amongst nurses and assessors were the main barriers to training completion (Chart 1). Back-fill cover facilitated by charity funding, was a main facilitator as this reduced time constraints. All survey respondents reported that the FEEL course had improved their job satisfaction.

Conclusions: Training CCOT nurses in POCUS is feasible. The process required significant commitment from the nurses, supervisors and managers, and would not have been possible without a charity grant that allowed an additional nurse to back fill study time.

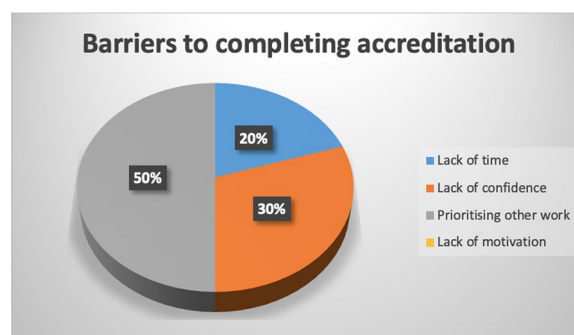

Legend on chart.

References

1. Leech M, Bissett B, Kot M, et al. Physiotherapist-initiated lung ultrasound to improve intensive care management of a deteriorating patient and prevent intubation: a case report. *Physiotherapy theory and practice*, 2015. 31(5): p. 372–6. doi: <https://doi.org/10.3109/09593985.2014.1003629>
2. Zieleskiewicz L, Lopez A, Hraiech S, et al. Bedside POCUS during ward emergencies is associated with improved diagnosis and outcome: an observational, prospective, controlled study. *Crit Care* 25, 34 (2021). doi: <https://doi.org/10.1186/s13054-021-03466-z>
3. This work was supported by the Burdett Trust for Nursing (Grant no. SB\ZA\101010662\824101).

Topic: Nursing care and physiotherapy

001013

Mobilisation in the EveNing to TreAt delirium: a qualitative study of patient and staff perceptions on acceptability

E. King¹, O. Gustafson¹, D. Barghouthy², D. McWilliams³

¹Oxford Allied Health Professions Research and Innovation Unit, John Radcliffe Hospital, Headington, United Kingdom; ²Critical Care, University Hospitals Coventry & Warwickshire, Coventry, United Kingdom; ³Centre for Care Excellence, University Hospital Coventry & Warwickshire, Coventry, United Kingdom

Correspondence: E. King

Intensive Care Medicine Experimental 2023, **11(Suppl 1)**:001013

Introduction: Delirium is a common complication for patients admitted to intensive care units (ICUs) and is associated with an increase in

mortality and hospital length of stay, and poor long-term outcomes. [1,2]. Non-pharmacological interventions such as care bundles are recommended for the management of ICU acquired delirium [3]. However, evidence for specific interventions is lacking. We recently completed a feasibility trial to evaluate the impact of evening mobilisation (delivered between 7 and 9 pm) to improve sleep and reduce the incidence of delirium [4]. The provision of evening physiotherapy and mobilisation is not routine practice in the UK. Therefore, it is essential to establish its acceptability to both patients and staff.

Objectives: To explore the acceptability of patients receiving and staff delivering additional evening mobilisation in ICU.

Methods: A UK-based bi-centre qualitative study of patients recruited to the MENTAL trial. We purposively sampled patients who received the evening mobilisation intervention and staff who were involved in its delivery. Qualitative data was collected through semi-structured interviews which were audio-recorded and transcribed verbatim. The interviews were thematically analysed.

Results: We completed interviews with seven patients and nine staff members (three nurses and six physiotherapists). Four key themes were identified; balancing fatigue; spinning plates with time and care needs; normalising 24-h routines and late-night staffing. Whilst some logistical challenges and competing priorities were cited as barriers, positive feedback and the perceived benefits of evening mobilisation were identified from participants and staff. It was suggested that evening mobilisation could increase the amount of time that patients were active during the day, which may better reflect their usual daytime pattern and could increase their rehabilitation dosage. An interplay between physical and non-physical health promotion was also recognised through increased patient motivation and facilitating patient recovery in ICU.

Conclusions: Additional evening mobilisation in ICU was considered acceptable to both patients and staff. Benefits included increasing the patient's active day and supporting evening routines which might aid natural sleep. Staff suggested it could increase the rehabilitation dosage on ICU and could indicate an evolution of rehabilitation provision. These findings can be used to inform the design of interventions to reversible potential factors of ICU-acquired delirium.

Table 1. Patient and staff quotes.

Themes	Quotes
Balancing fatigue	'Some days it was good and some days I was too knackered...' (Patient one)
Spinning plates with time and care needs	'Seven and nine...we'll be doing our final writing, our shift reviews. (Staff four, nurse)
Normalising 24-hour routines	'...a better routine for them. So they won't routinely be in bed for four, five, six hours a day...' (Staff one, physio)
Late-night staffing	'There's quite a lot of operational challenges associated with deploying the intervention.' (Staff nine, physio)

References

1. Mehta S, Cook D, Devlin JW, Skrobik Y, Meade M, Fergusson D, Herridge M, Steinberg M, Granton J, Ferguson N, Tanios M. Prevalence, risk factors, and outcomes of delirium in mechanically ventilated adults. *Critical care medicine*. 2015 Mar 1;43(3):557–66.
2. Pandharipande PP, Girard TD, Jackson JC, Morandi A, Thompson JL, Pun BT, Brummel NE, Hughes CG, Vasilevskis EE, Shintani AK, Moons KG. Long-term cognitive impairment after critical illness. *New England Journal of Medicine*. 2013 Oct 3;369(14):1306–16.
3. Needham DM, Davidson J, Cohen H, Hopkins RO, Weinert C, Wunsch H, Zawistowski C, Bemis-Dougherty A, Berney SC, Bienvenu OJ, Brady SL. Improving long-term outcomes after discharge from intensive care unit: report from a stakeholders' conference. *Critical care medicine*. 2012 Feb 1;40(2):502–9.

4. McWilliams D, King E, Nydahl P, Darbyshire JL, Gallie L, Barghouthy D, Bassford C, Gustafson O. Mobilisation in the Evening to Treat delirium (MENTAL): protocol for a mixed-methods feasibility randomised controlled trial. *BMJ open*. 2023 Feb 1;13(2):e066143.
5. This research received no specific grant from any funding agency in the public, commercial or not-for-profit sectors. OG, Clinical Doctoral Research Fellow, NIHR301569, is funded by Health Education England (HEE)/National Institute for Health Research (NIHR). The views expressed are those of the authors and not necessarily those of the NIHR, NHS or the UK Department of Health and Social Care.

Topic: Nursing care and physiotherapy

001014

Non-invasive evaluation in acute heart failure for early predicting adverse events in critically cardiological patient

P. Trambaiolo¹, A. D'ambrosi², M. Salvati¹, T. Mazza², I. Figliuzzi¹, S. Romano³, A. Granatelli²

¹ICCU, Hospital Sandro Pertini, Roma, Italy; ²Cardiology, Hospital Sandro Pertini, Roma, Italy; ³Cardiology, University of L'Aquila, Coppito, Italy

Correspondence: P. Trambaiolo

Intensive Care Medicine Experimental 2023, **11(Suppl 1)**:001014

Introduction: The evaluation of prognosis in patients (pts) with Acute Heart Failure (HF) is based on Ejection Fraction (EF), whereas Cardiac Output (CO), essential for organ perfusion, with relevant diagnostic, prognostic and therapeutic implications is not usually measured due to its complexity.

Objectives: The aim of this study was to evaluate in pts admitted to the Intensive Cardiac Care Unit patients (ICCU) the predictive value of left ventricular output tract velocity time integral (LVOT VTI) for a composite in-hospital outcome and to assess the accuracy of different markers of ventricular function in predicting the risk for adverse events.

Methods: We enrolled 446 consecutive pts admitted to the ICCU in Pertini Hospital of Rome and University Hospital of Pisa with diagnosis of Acute Heart Failure (AHF), Cardiogenic Shock (CS) and Acute Myocardial Infarction (AMI). We measured left ventricular dimension, LVOT VTI, left ventricular Ejection Fraction (LVEF) and we collected intra-hospital events as respiratory Failure (RF), Acute Kidney Injury (AKI), Multi-Organ Failure (MOF) and Death). We divided the population, according to the EF (> or < 40%) and into two groups respect the presence or not of intrahospital events.

Results: The group of pts who developed intra-hospital events (N: 254—57,1%) showed significant lower LVOT VTI value respect to control group [AKI (LVOT VTI 19,4 ± 4,5 vs 17,1 ± 5,6; p < 0.001), RF (LVOT VTI 18,6 ± 4,9 vs 5,9; p < 0.001), MOF (LVOT VTI 18,7 ± 4,9 vs 16,2 ± 6,6; p = 0.006) and Death (LVOT VTI 18,6 ± 4,9 vs 15,8 ± 6,8; p = 0.004)]. Among the group of pts with EF > 40%, the mortality was higher according to LVOT VTI value (LVOT VTI > 10 cm 50%; in LVOT VTI 10–15 cm 7,5%, and in LVOT VTI > 15 cm 3,1%; p < 0,001).

Conclusions: LVOT VTI could represent an alternative and complementary method which satisfies the need for an effortless parameter in acute setting to predict intra-hospital events. We were able to measure LVOT VTI in all patients and it has proven to be a non-invasive tool, easily available and a reliable managing pathophysiological approach for critical patients. In a mare magnum of technologies, increasingly advanced and sophisticated, we tried to rediscover a simple and basic parameter that was useful in the management of critical patients. However, it needs to be tested in larger series of patients and multivariate adjustments for other prognostic predictors.

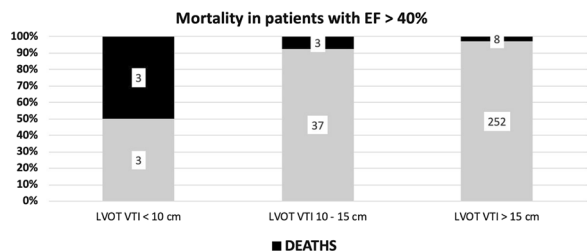

References

1. None
2. None. I agree that this information can be used as submitted and made available online within the context of ESICM

Topic: Cardiovascular issues in ICU

001015

Incidence of early onset Group B Streptococcus sepsis in term neonates with second line prophylaxis of maternal intrapartum antibiotics: A multi-center retrospective study

J. M. Low¹, J. H. Lee², H. Foote³, C. Hornik⁴, R. Clark⁵, R. Greenberg⁶
¹Neonatology, NUHS, Singapore, Singapore; ²Children's Intensive Care Unit, KK Women's and Children's Hospital, Singapore, Singapore; ³Pediatric Cardiology, Duke University, Durham, United States of America; ⁴Pediatric Critical Care Medicine, Duke University, Durham, United States of America; ⁵Center for Research and Education, Pediatrix Medical Group, Sunrise, United States of America; ⁶Neonatal-Perinatal Medicine, Duke University, Durham, United States of America

Correspondence: J.H. Lee

Intensive Care Medicine Experimental 2023, **11(Suppl 1)**:001015

Introduction: Group B Streptococcus (GBS) is a major cause of neonatal infection. The difference in incidence of GBS early onset sepsis (EOS) in term neonates whose mothers receive first versus second-line intrapartum prophylaxis remains poorly described.

Objectives: To compare the incidence and outcomes of term neonates with GBS EOS whose mothers received first versus second-line intrapartum prophylaxis.

Methods: We queried the Pediatrix Medical Group Clinical Data Warehouse1 to evaluate the outcomes of term neonates born to GBS positive mothers between 1997 and 2020. Primary outcome was GBS EOS (i.e. <7 days of life); secondary outcomes were maternal antibiogram and occurrence of neonatal morbidities. First line antibiotics were penicillin, ampicillin and ampicillin/sulbactam; others were considered second line. Data were summarized as count (percentage) and mean (standard deviation) for categorical and continuous variables, respectively. Multivariable logistic regression adjusting for maternal and infant factors was performed to calculate the risk of GBS EOS based on intrapartum prophylaxis received.

Results: Among 547,194 term neonates, 112,250 (20.5%) were born to GBS positive mothers. Out of these GBS positive mothers, 49,234 (43.8%) and 12,679 (11.3%) mothers received first-line and second-line intrapartum prophylaxis, respectively. 50,607 (45.0%) mothers had no or received unspecified antibiotic therapy. Maternal antibiotic usage for first line prophylaxis were 54%, 45% and 1% for penicillin, ampicillin and ampicillin/sulbactam, respectively. Commonly used antibiotics for second-line prophylaxis were cefazolin (46%), clindamycin (28%), and vancomycin (9%). Incidence of GBS EOS among all term neonates with maternal GBS carriage was 0.23% (263/112,520). Term infants whose mothers received second-line intrapartum antibiotics and unknown/no prophylaxis had higher risk of GBS EOS compared to first-line intrapartum antibiotics [adjusted odds ratio (aOR)

3.50 (95% confidence interval (CI) 1.43–8.54) and aOR 2.11 (95% CI 1.04–4.29) respectively]. There was no significant difference in the risk of GBS EOS in term infants born to mothers who received second line and unknown/no prophylaxis [aOR 0.60 (95% CI 0.28–1.32) compared to second line]. There was no difference in neonatal mortality, pressor or invasive ventilator use in first week of life across all groups.

Conclusions: There appears to be increased risk of GBS EOS with use of second-line compared to first-line maternal GBS prophylaxis. Notably, there was no significant difference in EOS GBS incidence between second line versus unknown/no treatment in mothers with GBS carriage. Future work needs to be carried out to delineate utility of second-line antibiotics in GBS prophylaxis.

Topic: Infections and prevention

001016

Comparing therapy intensity level in traumatic brain injury among different age groups: a CENTER-TBI analysis

B. Noè¹, M. Consonni², F. Graziano¹, M. Amigoni³, P. Mangili³, J. Pizzagalli³, A. Vargiolu³, F. Mulazzani¹, G. Pastore¹, G. Citerio⁴
¹School of Medicine And Surgery, University of Milano-Bicocca, Milano, Italy; ²School of Medicine and Surgery, Vita-Salute San Raffaele University, Milano, Italy; ³Fondazione IRCCS San Gerardo dei Tintori, Neuroscience Department, NeuroIntensive Care Unit, Milano, Italy; ⁴School of medicine and Surgery, University of Milano-Bicocca, Monza, Italy

Correspondence: B. Noè

Intensive Care Medicine Experimental 2023, **11(Suppl 1)**:001016

Introduction: Traumatic brain injury (TBI) in pediatric population is a major cause of disability and death. The anatomical and physiological differences between adults and pediatrics may entail different presentations and important implications for the management and care of TBI.

Objectives: This study objective is to compare the intensity of treatment for intracranial pressure (ICP) among pediatrics, adults and elderly.

Methods: CENTER-TBI patients admitted to the Intensive Care Unit (ICU) and with ICP monitoring were included. Pediatric patients (< 18yrs) were compared with adults (18-65yrs) and elderly (> 65yrs). Clinical data considered for the analysis were ICP and daily Therapy Intensity Level (TIL) for each patient during the first week of ICU stay. A five-category scale was used for TIL classification [1]. Specific TIL variables were described in detail, focusing on neuromuscular blockade, metabolic suppression for ICP control, hypocapnia, hyperosmolar therapy and secondary decompressive craniectomy. Clinical variables were expressed by mean (standard deviation), or frequency (%).

Results: Among 2138 patients admitted to the ICU (132 pediatrics, 1480 adults, 526 elderly), we included patients with ICP monitoring who were not treated with primary decompressive craniectomy (n=814; 6% pediatrics, 73% adults, 21% elderly). Fig*0.1 shows the daily TIL trend in patients from day 1 to day 7 of ICU stay. Pediatrics and adults showed an increase of intensity level of treatment during the first day in the ICU. High TIL (TIL3-4) were less performed in elderly, with low increase in frequency during the first week of ICU stay. Comparing specific levels of treatment, significative differences were found between pediatrics and elderly; similar trends were found comparing pediatrics with adults (Table 1).

Table 1 (abstract 001016) Differences in Therapy Intensity Level among pediatrics, adults and elderly

	Pediatrics	Adults	Elderly	p
n	49	595	170	
Secondary DC (%)	4(8)	68(11)	16(9)	0.626
High dose of barbiturates or propofol (%)	12(24)	205(34)	36(21)	0.003
Neuromuscularblockade (%)	19(38)	205(34)	31(18)	<0.001

	Pediatrics	Adults	Elderly	p
Mild Hypocapnia (PaCO ₂ 35–40 mmHg) (%)	28(57)	321(53)	67(39)	0.003
Moderate Hypocapnia (PaCO ₂ 30–35 mmHg) (%)	16(33)	149(25)	21(12)	0.001
Intensive Hypocapnia (PaCO ₂ < 30 mmHg) (%)	4(8.2)	43(7.2)	6(3.5)	0.202
Hyperosmolar therapy with Mannitol up to 2 g/kg/24 h (%)	11(22.4)	122(20)	31(18)	0.743
Hypertonic saline up to 0.3 g/kg/24 h	17(34.7)	191(32)	38(22)	0.04

Conclusions: Children are less aggressively treated during the first day of ICU stay, reflecting a more conservative approach to therapy in this category. In the elderly, a TIL4 is less represented compared to adults and pediatrics, with no increase in trend of high TIL performed in ICU, probably refers to poor prognosis.

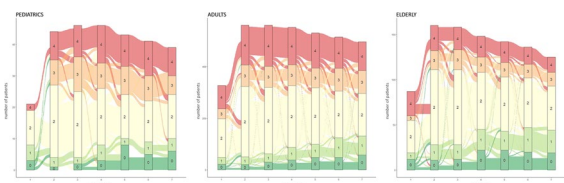

References

1. Maas AI, Harrison-Felix CL, Menon D, Adelson PD, Balkin T, Bullock R, Engel DC, Gordon W, Langlois-Orman J, Lew HL, Robertson C, Temkin N, Valadka A, Verfaellie M, Wainwright M, Wright DW, Schwab K. Standardizing data collection in traumatic brain injury. *J Neurotrauma*. 2011 Feb;28(2):177–87. doi: <https://doi.org/10.1089/neu.2010.1617>. Epub 2011 Feb 5. PMID: 21,162,610; PMCID: PMC3037806.

Topic: Neurointensive care

001017

The impact of the Covid-19 pandemic on delivery timelines of the EMPRESS feasibility randomised controlled trial

H. Golding¹, A. Bates², L. Denehy³, N. Hart⁴, I. Reading², M. Chorooglou², Z. van Willigen¹, A. Dushianthan¹, M. Grocott², R. Cusack¹

¹Critical Care, University Hospital Southampton NHS Foundation Trust, Southampton, United Kingdom; ²Faculty of Medicine, University of Southampton, Southampton, United Kingdom; ³Physiotherapy, The University of Melbourne, Carlton, Australia; ⁴Lane fox unit, Guys & St Thomas Nhs Foundation Trust, London, United Kingdom

Correspondence: H. Golding

Intensive Care Medicine Experimental 2023, **11(Suppl 1)**:001017

Introduction: We conducted the EMPRESS randomised controlled trial to assess the feasibility of delivering a protocolised early rehabilitation in three ICUs in the UK. The study was open when delivery of clinical research was widely impacted by the COVID-19 pandemic. Protocol amendments enabled some trials to mitigate this impact, however significant modifications were not possible with the EMPRESS protocol (1) due to trial design and patient population. Our only amendment was to extend the duration of recruitment.

Objectives: To understand how the delivery of EMPRESS was impacted by the COVID-19 pandemic and explore mitigating strategies.

Methods: We used fortnightly video operational meetings between sites to evaluate progress of the study and to identify challenges. We proactively developed strategies to facilitate optimal delivery as the study and the pandemic progressed.

Results: EMPRESS was recruiting at two sites when all non-COVID research was suspended in response to the pandemic. The trial was paused on 12th March 2020, just 10 days after the second site opened to recruitment. Recruitment to EMPRESS recommenced in August 2020. The third site opened to recruitment in October 2021 and approval of a study extension allowed recruitment at the second and third site until July 2022 as in Figure 1. Whilst the pause to recruitment spanned five months, the impact of the pandemic persisted for the duration of the study. Specific barriers impacting the study and mitigation strategies are described in Table 1.

Table 1 (abstract 001017) Barriers and mitigations to the delivery of EMPRESS following the pause to recruitment due to Covid-19

Barriers	Mitigations
Covid-specific research prioritised, preventing recruitment of otherwise eligible participants	Sought co-enrolment agreements as soon as possible
Study funded staff redeployment led to them embedding into the clinical team	Education of clinical colleagues on purpose of role and importance of protecting research time
Patients transferred to ICUs out of area	Follow up data obtained from summary care records
Patients transferred to other site recovery wards	Therapy assistant travelled to perform hospital discharge assessments
Patient restrictions or concerns attending hospital for three month follow up	Completion of PROMs over the telephone where possible
Advances in treatment of Covid-19 meant less patients were intubated and ventilated	NIHR and HRA approval of recruitment extension to allow for higher numbers of eligible patients to be admitted to ICUs
Government recommendations: lockdowns, shielding, self-isolation, mask wearing and social distancing, meant less incidence of common ICU admissions	
Site C R&D staff redeployed to covid-specific research	Proactive engagement of newly appointed EMPRESS project manager with Site C R&D department and Sponsor to overcome barriers to opening the site

Conclusions: Whilst we acknowledge there are often challenges and delays at many stages of research studies regardless of the pandemic, we have identified multiple COVID-specific limitations and recommend mitigating strategies, which may promote resilience in future clinical trial delivery.

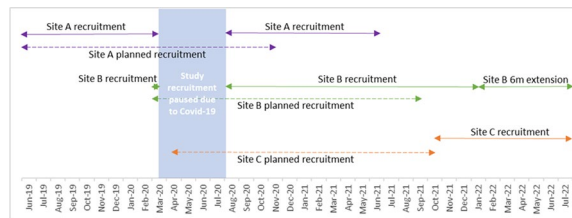

Figure 1 (abstract 001017) Contrast between actual and planned recruitment timelines at Sites A, B and C

References

1. Cusack R, Bates A, Mitchell K, et al. Improving physical function of patients following intensive care unit admission (EMPRESS): protocol of a

randomised controlled feasibility trial. *BMJ Open* 2022;12:e055285. doi: <https://doi.org/10.1136/bmjopen-2021-055285>.

The EMPRESS project received funding from the National Institute of Health and Social Care Research under the Research for Patient Benefit (RfPB) programme under grant reference number PB-PG-0317–20045.

Topic: Nursing care and physiotherapy

001019

Electromagnetic stimulation of the phrenic nerve to generate contraction of the diaphragm in anaesthetised and intubated patients with obesity – a proof-of-concept study

M. A. Verfuß¹, A. Panelli¹, H. G. Bartels¹, A. Grimm¹, S. Krause², J. Grunow¹, T. Niederhauser², S. Weber-Carstens¹, S. J. Schaller¹

¹Department of Anesthesiology And Surgical Intensive Care, Charité – Universitätsmedizin Berlin, Berlin, Germany; ²Institute for Human Centered Engineering, Bern University of Applied Sciences, Biel/Bienne, Switzerland

Correspondence: M.A. Verfuß

Intensive Care Medicine Experimental 2023, **11(Suppl 1)**:001019

Introduction: Critically ill patients are at high risk to develop ventilator-induced diaphragm dysfunction (VIDD), leading to a deterioration of clinical outcomes, such as mortality and weaning success [1]. Diaphragm training by repetitive bilateral phrenic nerve stimulation in mechanically ventilated patients might prevent or ameliorate diaphragm atrophy or VIDD. The feasibility to generate diaphragm contractions via non-invasive electromagnetic phrenic nerve stimulation (NEPNS) was successfully demonstrated in normal-weight healthy anaesthetised patients [2]. However, as the effect decreased linearly with increasing distance to the phrenic nerve, it is uncertain whether the technique is feasible in obese patients as well.

Objectives: The aims of this analysis were to investigate (1) the time to find an adequate stimulation point and (2) the influence of positional changes of the stimulation coils using NEPNS in anaesthetised and intubated patients with obesity.

Methods: Five obese patients (Body Mass Index of ≥ 35) without severe general illness scheduled for elective surgery received bilateral NEPNS following induction of general anaesthesia and endotracheal intubation. For this purpose, coils intentionally designed for NEPNS were used. Time to achieve an adequate stimulation was measured. The position of the coils was changed in anterior–posterior and cranio-caudal direction in three 5 mm movements away from the initial stimulation point. Per position three stimulations were performed at 50% intensity and the tidal volume was documented by the ventilator.

Results: The time to find the adequate stimulation point of the phrenic nerve was 35 ± 30 s. The tidal volume declined with increasing coil distance from the initial stimulation point. (Absolute decline of tidal volume from 0 mm; mean \pm standard deviation; anterior–posterior manoeuvre: -1.79 ± 1.06 , -1.67 ± 0.96 , -2.50 ± 0.31 ml/kg ideal body weight [IBW] per 5, 10 and 15 mm, respectively; cranio-caudal manoeuvre: -1.31 ± 1.68 , -1.49 ± 1.66 , -1.82 ± 0 ml/kg IBW per 5, 10 and 15 mm, respectively). There was a linear relationship between increasing distance in the anterior–posterior direction and decreasing tidal volume ($p=0.011$, Figure 1A), whereas this could not be confirmed for the cranio-caudal direction ($p=0.0504$; Figure 1B), most likely due to the limited number of measurements caused by the anatomical limitations (i.e., restricted neck size).

Conclusions: Finding an adequate stimulation point to perform NEPNS in obese patients was feasible within one minute. An anterior–posterior change of the stimulation point resulted in a linear decrease of the stimulated tidal volume, whereas in the cranio-caudal direction anatomical restrictions did not demonstrate such a relationship statistically.

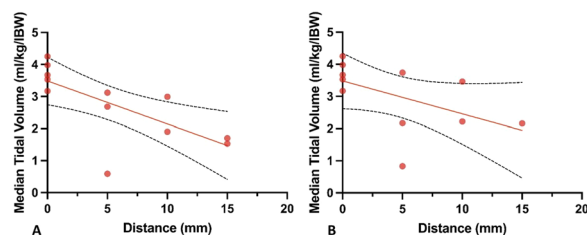

Figure 1 (abstract) Linear relationship between median tidal volume (ml/kg/IBW) induced by bilateral non-invasive electromagnetic phrenic nerve stimulation with increasing anterior–posterior distance (mm) (A; $r^2=0.495$, $p=0.011$) but not cranio-caudal distance (mm) (B; $r^2=0.331$, $p=0.0504$) to the initial stimulation point. Limited by anatomical restrictions, positional changes were feasible for anterior–posterior manoeuvres in $n=3$, $n=2$, $n=2$ and for cranio-caudal manoeuvres in $n=3$, $n=3$, $n=1$ patients per 5mm, 10mm and 15mm, respectively. IBW: Ideal Body Weight

References

- Panelli A, Bartels HG, Krause S, et al. First non-invasive magnetic phrenic nerve and diaphragm stimulation in anaesthetized patients—a proof-of-concept study. *Intensive Care Med Experimental*. 2023;accepted for publication. doi: <https://doi.org/10.1186/s40635-023-00506-6>
- Dres M, Jung B, Molinari N, et al. Respective contribution of intensive care unit-acquired limb muscle and severe diaphragm weakness on weaning outcome and mortality: a post hoc analysis of two cohorts. *Critical care* (London, England). 2019;23(1):370.

Topic: Acute respiratory failure and mechanical ventilation.

001020

Retrospective clinical study: computed tomography and inflammatory markers as outcome predictors in Covid-19 infection

F. Hohmann¹, F. Galdino¹, M. R. Kraft¹, S. Custodio¹, E. Paolinelli¹, G. Veiga¹, I. Machado¹, B. Bravim¹, J. Silva Jr¹

¹Department of Critical Care Medicine, Albert Einstein Israelita Hospital, São Paulo, Brazil

Correspondence: F. Hohmann

Intensive Care Medicine Experimental 2023, **11(Suppl 1)**:001020

Introduction: It is known that Covid-19 has, at least initially, a nonspecific clinical course and that up to 17% of patients may require invasive mechanical ventilation (1). Chest computed tomography scans with ground-glass opacities and consolidations, as well as C-Reactive Protein (CRP), D-Dimer, Lactic Dehydrogenase, Ferritin and Interleukin-6 (IL-6) can be considered important tools in discriminating clinical worsening in patients with Covid-19 (2, 3, 4).

Objectives: To analyze whether lung tomographic changes as well as inflammatory markers may be associated with a higher risk of intubation in patients with Covid-19.

Methods: We performed a cohort study considering all COVID-19 patients consecutively admitted between March 2020 and December 2020 requiring supplemental oxygen. The primary outcome was the need for tracheal intubation. An adjusted regression model was used to assess the effect of changes in chest CT and inflammatory markers on the intubation outcome.

Results: A total of 250 patients were evaluated and 73.6% Covid-19 patients were intubated. Overall, the median to intubation time was 4 (2–7) days after hospital admission. Among all inflammatory markers, only higher IL-6 mensuration was associated to the need for intubation, 37.5 (16–102) vs 63 (25–172) difference 19 (95% CI, 6.0

to 36). When we assess pulmonary involvement on chest computed tomography, an involvement greater than 50% of the parenchyma corresponded to 60 (50.4%) patients intubated vs 11 (25%) non intubated. Adjusted intubation odds ratio to IL-6 was 1.002 (95% CI, 1.001 to 1.003) and pulmonary involvement > 50% was 2.42 (95% CI, 1.13 to 5.18).

Conclusions: Higher IL-6 (Figure 1) and pulmonary involvement in chest tomography greater than 50% (Figure 2) may be associated with higher risk of intubation in Covid-19 patients.

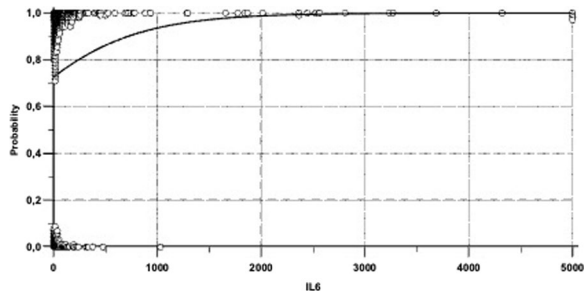

Figure 1 (abstract 001020) Odds Ratio for intubation vs IL-6

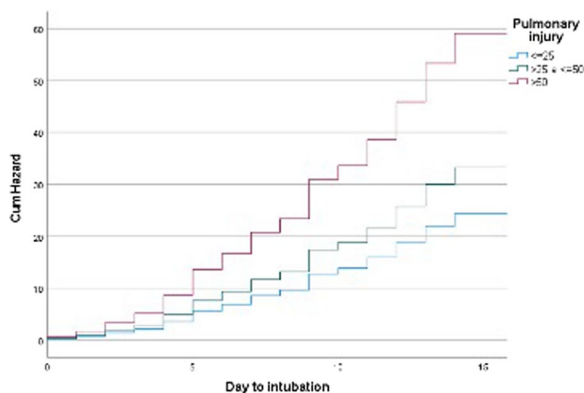

Figure 2 (abstract 001020) Kaplan–Meier curve demonstrating cumulative hazard at 16 days for intubation according to lung involvement $\leq 25\%$, $> 25\%$ and $\leq 50\%$, $> 50\%$

References

3. Ayanian S, Reyes J, Lynn L, Teufel K. The association between biomarkers and clinical outcomes in novel coronavirus pneumonia in a US cohort. *Biomark Med.* 2020;14(12):1091–7.
2. Li X, Ma X. Acute respiratory failure in COVID-19: is it "typical" ARDS? *Crit Care.* 2020;24(1):198.
1. Huang L, Han R, Ai T, Yu P, Kang H, Tao Q, et al. Serial Quantitative Chest CT Assessment of COVID-19: A Deep Learning Approach. *Radiol Cardiothorac Imaging.* 2020;2(2):e200075.
- The authors thank all patients and healthcare personnel involved in the study.

Topic: Acute respiratory failure and mechanical ventilation.

001021

Serum biomarkers in traumatic brain injury in different age groups: a CENTER-TBI analysis

M. Consonni¹, B. Noè², F. Graziano³, G. Pastore², F. Mulazzani², A. Addis⁴, G. Citerio²

¹School of Medicine and Surgery, Vita-Salute San Raffaele University, Milano, Italy; ²School of Medicine And Surgery, University of Milano-Bicocca, Milano, Italy; ³Bicocca Bioinformatics Biostatistics and Bioimaging Center B4, University of Milano-Bicocca, Milano, Italy; ⁴Neuroscience Department, NeuroIntensive Care Unit, Fondazione IRCCS San Gerardo dei Tintori, Monza, Italy

Correspondence: M. Consonni

Intensive Care Medicine Experimental 2023, **11(Suppl 1)**:001021

Introduction: Providing an accurate prognosis in traumatic brain injury (TBI) patients is challenging. Besides clinical and radiological evaluation, serum biomarkers are promising to assess the severity of TBI. However, literature on biomarkers' prognostic and predictive value is limited, with scarce evidence on pediatric patients.

Objectives: This study aims to correlate the presence and the concentration of blood-based biomarkers in TBI with the severity of damage among age groups. The second aim is to associate biomarkers concentration with 6-month unfavorable neurological outcomes and mortality.

Methods: Patients from CENTER-TBI admitted to the ward or Intensive Care Unit (ICU) were included. Six admission biomarkers for each patient were considered for the analysis. We compared pediatrics (< 18y) to adults (18-65y) and elderly (> 65y), and age groups in pediatrics were compared (0-4y, 5-12y, 13-17y). The effect of the biomarker on outcomes was assessed by a logistic regression model adjusted for patients' characteristics at baseline (age, Glasgow Coma Scale, pupils' state, and Injury Severity Score).

Results: Among 3661 patients included, 1523 (95 pediatrics, 957 adults, 471 elderly) were admitted to the ward, and 2138 (132 pediatrics, 1480 adults, 526 elderly) were admitted to ICU. Fig*0.1 shows the distribution of biomarkers among ICU and non-ICU patients and age groups. Overall, ICU patients show a higher concentration of every biomarker detected compared to patients admitted to the ward, with a significant difference among age groups for NSE ($p < 0.001$), Neurofilaments light (NFL) ($p = 0.004$), Glial Fibrillary Acid Protein (GFAP) ($p < 0.001$), and Ubiquitin Carboxyl-terminal Hydrolase isoenzyme L1 (UCH-L1) ($p = 0.007$). Adults and elderly have a significant increased level of all serum biomarkers except for S100B. Increased neuron-specific Enolase (NSE) is the most represented biomarker in pediatrics, both in the ward and ICU ($p < 0.001$), even if its concentration is not associated with mortality or unfavorable neurological outcome. Unfavorable neurological outcomes (Glasgow Outcome Scale-Extended, $GOSE \leq 4$) in ICU patients were associated with significantly higher levels of GFAP, UCH-L1 and, in pediatrics, Tau protein. Similar results are obtained considering 6-month mortality. In ICU pediatric patients, a lower level of UCH-L1 and GFAP are associated with a 6-month good recovery ($GOSE \geq 7$). The model confirmed the association of UCH-L1 and NFL on 6-month unfavorable neurological outcomes and mortality in the overall population.

Conclusions: ICU patients show a higher release of all the serum biomarkers. UCH-L1 and NFL might play a role in predicting prognosis in TBI patients in ICU.

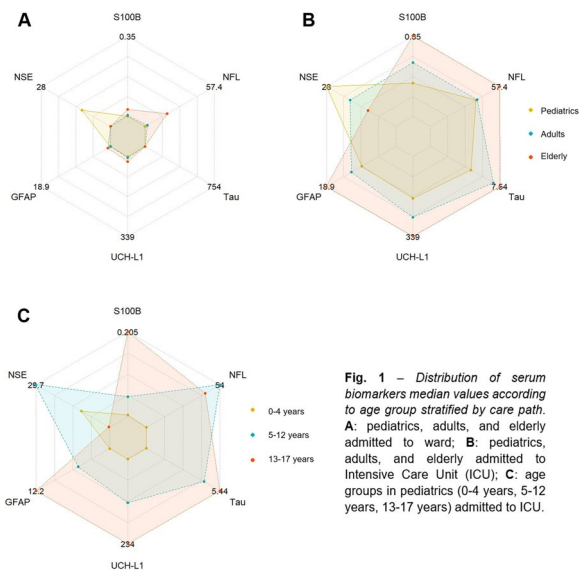

Figure 1 (abstract 001021) .

Topic: Neurointensive care

001025

Implementing a post-ICU follow-up protocol in a single-center university hospital in Portugal

R. F. Gomes¹, M. Sá Machado¹, M. Maneira Sousa¹, J. M. Ribeiro¹

¹Intensive Care Medicine Department and ECMO Referral Center, Centro Hospitalar Universitário Lisboa Norte, Lisboa, Portugal

Correspondence: R. F. Gomes

Intensive Care Medicine Experimental 2023, **11(Suppl 1)**:001025

Introduction: Post-intensive care syndrome (PICS) affects up to 80% of intensive care unit (ICU) survivors, leading to reduced quality of life and increased consumption of health care resources. Current evidence supports the implementation of follow-up strategies, but there are no standardized recommended approaches, demanding the need for a personalized protocol for each country and center.

Objectives: To implement a multi-professional and multidisciplinary follow-up protocol in a single-center university hospital to identify patients at risk of developing PICS, prevent post-ICU morbidity, and improve the overall quality of life.

Methods: The ICU medical staff approved and implemented the protocol in October 2022, based on the *Society of Critical Care Medicine* recommendations and in recent single-center studies, using validated scores for the Portuguese population. Social and nutritional evaluations were also warranted. Inclusion criteria were defined as ICU length-of-stay > 5 days, highest SOFA score > 5 points, and average life expectancy > 6 months. The protocol is performed at five different time points: 1) ICU admission, 2) ICU discharge, 3) 2 weeks after ICU discharge, by phone call or in person if the patient remains hospitalized, 4) 2 months after ICU discharge, and 5) 4–6 months later, according to medical evaluation. The inclusion of other patients is allowed, according to an individual medical decision. Each time point has a standardized assessment (Figure 1), and referrals to other medical specialties are made whenever deemed necessary.

Results: A total of 34 patients were included from 27th October 2022 to 6th April 2023. 61.8% were males, the mean age was 50.2 ± 11.3 years-old, and the mean SAPS II was 44 ± 19 points. All patients underwent mechanical ventilation, 26.5% (n=9) renal replacement therapy, and 14.7% (n=5) ECMO. ICU-AW was diagnosed in 76.5% (n=26) and cognitive deficit in 67.6% (n=23), mainly in the patients who had delirium during ICU stay (23.5%, n=8). A total of 21 patients were evaluated

2 weeks after ICU discharge (M1) and 11 patients at 2 months (M2). The preliminary data points to an improvement in physical (ICU-AW 18.8% at M2) and cognitive (cognitive deficit 18.2% at M2) impairments, probably reflecting the role of rehabilitation, monitored during the follow-up period. However, the incidence of positive screening for post-traumatic stress disorder increased from M1 (n = 7, 33.3%) to M2 (n = 5, 45.5%).

Conclusions: This personalized follow-up protocol is in constant update. Closer collaboration with psychiatry/psychology, the implementation of ICU diaries, and the overall management in an outpatient clinic are under evaluation. Further, we plan to develop a prospective study protocol to evaluate the impact of this approach on quality of life and physical, mental, cognitive, and nutritional outcomes.

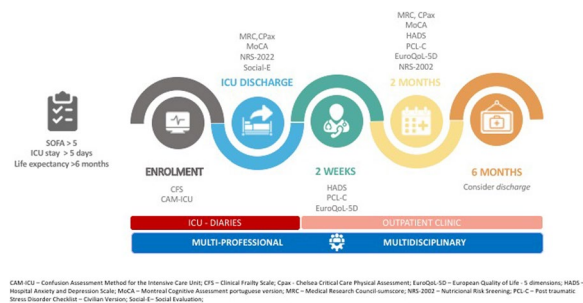

Figure 1 (abstract 001025) .

References

1. Puthuchery Z, Brown C, Corner E, et al. The Post-ICU presentation screen (PICUPS) and rehabilitation prescription (RP) for intensive care survivors part II: Clinical engagement and future directions for the national Post-Intensive Care Rehabilitation Collaborative. *J Intensive Care Soc.* 2022 Aug;23(3):264–272. doi: <https://doi.org/10.1177/1751143720988708>
2. Herridge MS, Azoulay É. Outcomes after Critical Illness. *N Engl J Med.* 2023 Mar 9;388(10):913–924. doi: <https://doi.org/10.1056/NEJMra2104669>
3. Mikkelsen ME, Still M, Anderson BJ, et al. Society of Critical Care Medicine's International Consensus Conference on Prediction and Identification of Long-Term Impairments After Critical Illness. *Crit Care Med.* 2020 Nov;48(11):1670–1679. doi: <https://doi.org/10.1097/CCM.00000000000004586>
4. Rohr M, Brandstetter S, Bernardi C, et al. Piloting an ICU follow-up clinic to improve health-related quality of life in ICU survivors after a prolonged intensive care stay (PINA): study protocol for a pilot randomised controlled trial. *Pilot Feasibility Stud* 7, 90 (2021). doi: <https://doi.org/10.1186/s40814-021-00796-1>
5. Schofield-Robinson OJ, Lewis SR, Smith AF, et al. Follow-up services for improving long-term outcomes in intensive care unit (ICU) survivors. *Cochrane Database Syst Rev.* 2018 Nov 2;11(11):CD012701. doi: <https://doi.org/10.1002/14651858.CD012701.pub2>
6. Griffith DM, Salisbury LG, Lee RJ, Lone N, Merriweather JL, Walsh TS; RECOVER Investigators. Determinants of Health-Related Quality of Life After ICU: Importance of Patient Demographics, Previous Comorbidity, and Severity of Illness. *Crit Care Med.* 2018 Apr;46(4):594–601. doi: <https://doi.org/10.1097/CCM.0000000000002952>

Topic: Critical care organisation, quality management, information systems, outcomes

001026

Impact of a systematic and periodic spiritual care intervention in the prevention of psychological disorders associated with PICS-F: preliminary results

C. Ruiz¹, P. Repetto², L. Alegria³, D. Manriquez⁴, P. Olivares⁵, M. P. Pineiro⁴, P. Taboada⁵, V. Rojas⁶

¹Intensive Care, Pontificia Universidad Católica de Chile, Santiago, Chile;

²Escuela de Psicología, Pontificia Universidad Católica de Chile, Santiago, Chile;

³Departamento de Medicina Intensiva, Pontificia Universidad

Católica de Chile, Santiago, Chile; ⁴Unidad de Paciente Crítico, COMPLEJO ASISTENCIAL DR SOTERO DEL RIO, Puente Alto, Chile; ⁵Medicina interna, Pontificia Universidad Católica de Chile, Santiago, Chile; ⁶Medicina intensiva, Universidad de Chile, Santiago, Chile

Correspondence: C. Ruiz

Intensive Care Medicine Experimental 2023, **11(Suppl 1)**:001026

Introduction: Post-intensive care syndrome (PICS) affects critically ill patients and their families. Family PICS (PICS-F) can have a prevalence close to 50% and includes psychological disorders such as anxiety, depression, post-traumatic stress disorder (PTSD) and complicated grief. We report the preliminary results of a study that explored spiritual care at preventing PICS-F.

Objectives: To compare the effect of systematic and periodic spiritual care (SPSC) versus standard spiritual care (SSC), on the rate of psychological disorders associated with PICS-F.

Methods: Relatives of invasively ventilated patients without treatment limitations, admitted in the ICU of Complejo Asistencial Dr. Sótero del Río, Chile, were included. The study had a quasi-experimental design, with 2 groups and a follow-up of 3 months. Relatives recruited in the first group received the SSC provided by the hospital (chaplain assistance at request of the family). Relatives recruited in the second group received the study intervention (SPSC), that included telematic, trans-religious, spiritual accompaniment (3 Zoom sessions), delivered by trained volunteers (1 volunteer/relative). The SPSC was given while the participants' loved ones were in the ICU. SSC and SPSC groups were evaluated via psychological tests (telephone interview), at the time of recruitment and after 3 months. The Hospital Anxiety and Depression Scale (HADS) was used to assess depressive symptoms and anxiety, and the Impact of Event Scale-Revised (IES-R) to assess PTSD. Socio-demographic variables of the participants and relevant clinical data from the patients were registered. Results are described using mean \pm standard deviation (SD) and percentages, and are compared with Student's t-test and ANOVA. The study was approved by the hospital Institutional Review Board.

Results: 61 relatives were recruited in the SSC group and 51 in the SPSC group (1 relative/patient), between November 2021 and May 2022. Fifty relatives in the SSC group and 43 in the SPSC completed the 3-month evaluation. Most of the participants were women (79%), with a mean age of 47 ± 12 years, 51% had a formal employment and 21% had a previous history of mental health problems. The patients' mean age was 57.3 ± 16.6 years and 45% were women. The most frequent diagnoses for ICU admission were acute respiratory failure (40%), half of them due to COVID-19, and septic shock (23%). Participants of the SPSC group had a higher baseline score in the HADS anxiety subscale. No other differences in baseline characteristics were found, between relatives or patients. The IES-R score was significantly lower in the SPSC group compared to the SSC group at 3 months (Table 1). In each group the HADS scores decreased during the study period, without statistical significance. However, a significant difference over the 3 month-period was found in the IES-R score in the SPSC group (P value = 0,002).

Table 1 (abstract 001026) Results of the psychological tests at recruitment (baseline) and at 3 months

Psychological test	SSC baseline results (mean + SD)	SPSC baseline results (mean + SD)	P value (baseline comparison)	SSC 3months results (mean + SD)	SPSC 3months results (mean + SD)	P value (3months comparison)
HADS (anxiety subscale)	11.9 + 4.6	13.5 + 4.2	0.04	10.9 + 4.3	10.4 + 4.8	0.57
HADS (depressive symptoms subscale)	8.2 + 3.8	8.7 + 4.1	0.52	7.7 + 3.9	6.8 + 4.3	0.28
IES	45.1 + 15.3	44.1 + 15.1	0.69	46.1 + 15.2	38.2 + 20.5	0.03

The results are compared with Student's t-test.

HADS: A cutoff of 8 points in each subscale indicates a possible case of anxiety or depressive symptoms.

IES-R: A cutoff of 23 points suggests a case of moderate PTSD and cutoff of 43 a case of severe PTSD.

Conclusions: A SPSC intervention could decrease the rate of PTSD related to PICS-F.

References

- Caamaño L, Fuentes D, González L, Melipillán R, Sepúlveda M, Valenzuela E. (2011). Adaptación y validación de la versión chilena de la escala de impacto de evento-revisada (EIE-R). *Revista médica de Chile*, 139 (9), 1163–1168.
- Azoulay E, Resche-Rigon M, Megarbane B, Reuter D, Labbé V, Cariou A et al. (2022) Association of COVID-19 Acute Respiratory Distress Syndrome With Symptoms of Posttraumatic Stress Disorder in Family Members After ICU Discharge. *JAMA*, 327(11):1042–1050.
- Terol M, Cabrera V, Martín M. (2015). Revisión de estudios de la Escala de Ansiedad y Depresión Hospitalaria (HADS) en muestras españolas. *Anales de psicología*, 31 (mayo): 494–503.
- Inoue S, Hatakeyama J, Kondo Y, Hifumi T, Sakuramoto H, Kawasaki T et al. (2019). Post-intensive care syndrome: its pathophysiology, prevention, and future directions. *Acute Medicine & Surgery*, 6 (3), 233–246.
- This study was founded by a grant of Pontificia Universidad Católica de Chile (105,675/DPCC2020).

Topic: Critical care organisation, quality management, information systems, outcomes

001027

Coagulopathy following traumatic brain injury: what are the respective contributions of head and extra-head injury severities?

M. Rustin¹, L. Wildenberg², J. Kallout³, J. D. Moyer⁴, P. Esnaul⁵, M. Pissot⁶, A. Godier⁷, J. L. Hanouz⁸, T. Geeraerts⁹, D. Garrigue¹⁰, M. Leone¹¹, V. Legros¹², G. Audibert¹³, T. Clavier¹⁴, P. Abback¹⁵, A. Harrois¹⁶, S. Figueiredo¹⁷, G. Traumabase¹⁸

¹Anesthesiology and Intensive Care, Paris-Saclay University, Bicetre Hospital, Le Kremlin-Bicêtre, France; ²Anesthesiology and intensive care, Bicetre Hospital AP-HP, Le Kremlin-Bicêtre, France; ³Département d'Anesthésie Réanimation, Rouen Hospitals University Hospital Emergency Department, Rouen, France; ⁴Anesthesiology and Critical Care, Beaujon Hospital, Clichy, France; ⁵Fédération anesthésie-réanimation-brûlés, Hôpital d'Instruction des Armées Sainte-Anne, Toulon, France; ⁶Service d'Anesthésie-Réanimation, Percy Army Training Hospital, Clamart, France; ⁷Service d'Anesthésie Réanimation, INSERM UMRS-1140, Université de Paris, European Hospital Georges Pompidou, Paris, France; ⁸Pôle réanimations-anesthésie-Samu, University Hospital Center of Caen, Caen, France; ⁹Pôle anesthésie-réanimation, Hospital Center University De Toulouse, Toulouse, France; ¹⁰Pôle d'Anesthésie Réanimation, Hospital Center University De Lille, Lille, France; ¹¹Department of anesthesiology and intensive care medicine, Hospital Nord, Marseille, France; ¹²Département d'Anesthésie Réanimation, CHU of Reims—Maison Blanche Hospital, Reims, France; ¹³Département d'Anesthésie Réanimation, C.h.u. De Nancy, Nancy, France; ¹⁴Medical Intensive Care Unit, Rouen University Hospital, Rouen, France; ¹⁵Département d'Anesthésie Réanimation, Chru Hospitals Of Tours, Tours, France; ¹⁶Anesthesiology and intensive care, Bicetre Hospital AP-HP, Le Kremlin-Bicêtre, France; ¹⁷Anesthesiology and intensive care, Equipe ReSist, INSERM U1184, Bicetre Hospital, Le Kremlin-Bicêtre, France; ¹⁸Association traumabase, Association Traumabase, Paris, France

Correspondence: M. Rustin

Intensive Care Medicine Experimental 2023, **11(Suppl 1)**:001027

Introduction: Following traumatic brain injury (TBI), coagulopathy upon hospital admission is found in about 25–35% of patients, with a wide range of 7 to 97% reported among series(1). The contributions of head injury and concomitant extracranial lesions to coagulopathy have been poorly investigated. We hypothesized that the risk of coagulopathy on hospital admission following TBI would increase with

increasing head injury severity, and to a greater extent with severe associated extra-head injuries as compared to no associated extra-head injury.

Objectives: To determine at hospital admission: 1/the incidence of post-TBI coagulopathy, according to the presence or absence of associated severe extracranial injuries, and 2/ the independent risk factors for post-TBI coagulopathy.

Methods: Observational study from a multicenter prospective French trauma registry (Traumabase®). All adult patients directly admitted to one of the participating centers from January 2012 to December 2021 following TBI (AIS (Abbreviated Injury score) head ≥ 1) were included. Post-TBI coagulopathy was defined by at least 1 of the following criteria: prothrombin ratio < 70% or platelets < 100 G/L or fibrinogenemia < 1.5 g/L on hospital admission. Severe associated extracranial lesions were defined by at least 1 of the AIS extra-head scores ≥ 3. To identify risk factors independently associated with admission coagulopathy, bivariate and multivariate analyses were performed.

Results: Among 33,875 patients admitted to 22 trauma centers, 9610 patients had TBI and were included in the analysis. The overall incidence of admission coagulopathy was 28.5%. Coagulopathic patients were significantly more severely injured (higher ISS, extracranial AIS, SAPS2, serum lactate, base excess) and especially more severely head-injured (lower prehospital GCS, higher AIShead and osmotherapy requirement), when compared to non-coagulopathic patients. Figures 1 and 2 show the relationship between admission coagulopathy and the severities of head and extra-head injuries. The higher the AIShead, the higher the proportion of patients exhibiting coagulopathy (p < 0.001), whatever the presence of extracranial lesions. When compared to patients with AIShead = 1, the increased incidence of coagulopathy with TBI severity was observed at an earlier stage of TBI severity when severe extracranial lesions were present (Figure 1). In multivariable analysis, severe extracranial injury was independently associated with the risk of post-TBI coagulopathy (OR 2.0 (1.8 – 2.3), P < 0.001) (Table 1).

Table 1 (abstract 001027) Risk factors independently associated to admission coagulopathy in TBI patients

Variable	OR (IC 0.95)	P value
Unstable pelvic trauma	2.2 (1.7–2.8)	< 0.001
AIS extrahead ≥ 3	2.0 (1.8–2.3)	< 0.001
Male	2.0 (1.7–2.3)	< 0.001
Gunshot	1.6 (1.1–2.5)	0.03
Osmotherapy	1.6 (1.3–1.9)	< 0.001
AIS head ≥ 3	1.4 (1.2–1.6)	< 0.001
Prehospital shock index ≥ 1	1.4 (1.2–1.6)	0.001
Vasopressors at admission	1.3 (1.1–1.5)	0.002
Open extremities trauma	1.3 (1.1–1.5)	0.005
Pupillary abnormality	1.3 (1.1–1.5)	0.012
Prehospital intubation	1.3 (1.1–1.6)	0.007
Serum lactate at admission	1.2 (1.1–1.2)	< 0.001
Age	0.98 (0.97–0.99)	< 0.001

Conclusions: In the present study, a continuously graded association between the severity of head injury and coagulopathy at hospital admission was shown, and this increased incidence of coagulopathy was observed at earlier stage of TBI severity when severe extracranial lesions were present. The presence of severe extracranial injuries was one of the most important risk factors for coagulopathy following TBI.

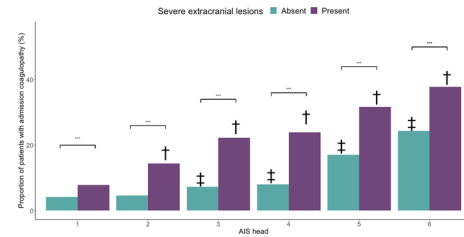

Figure 1 (abstract 001027) Incidence of coagulopathy on hospital admission according to the severity of TBI (assessed by AIShead) and the presence (purple) or absence (blue) of severe extracranial lesions. *** P < 0.001 severe extracranial lesions absent vs present. + P < 0.001 vs AIShead = 1 and severe extracranial lesions present. ± P < 0.001 vs AIShead = 1 and severe extracranial lesions absent

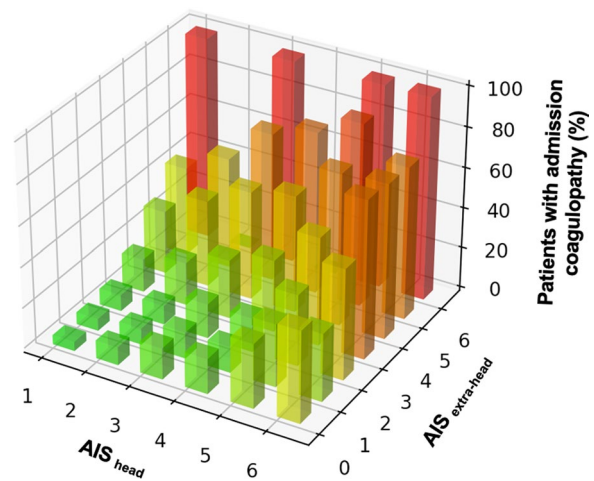

Figure 2 (abstract 001027) Relationship between admission coagulopathy and the severities of head (assessed by AIShead) and extra-head injuries (assessed by the maximum value of extracranial AIS)

References

1. Maegele M et al. Coagulopathy and haemorrhagic progression in traumatic brain injury: advances in mechanisms, diagnosis, and management. Lancet Neurol. 2017;16(8):630–47.

Topic: Trauma

001030

Acute kidney injury in critically ill COVID-19 patients in Tyrol, Austria

T. Mayerhöfer¹, F. Perschinka¹, M. Joannidis¹

¹Division of Intensive Care and Emergency Medicine, Department of Internal Medicine, Medical University Innsbruck, Innsbruck, France

Correspondence: T. Mayerhöfer

Intensive Care Medicine Experimental 2023, 11(Suppl 1):001030

Introduction: Acute kidney injury (AKI) is frequently seen in critically ill COVID-19 patients and associated with increased mortality. Reports of the incidence of AKI in COVID-19 varied widely between different cohort studies and the Acute Disease Quality Initiative (ADQI) expressed the need for more detailed epidemiological data (1).

Objectives: The aim of this analysis was to investigate the incidence, outcome and risk factors of AKI in critically ill COVID-19 patients in Tyrol, Austria.

Methods: This multicenter prospective registry study included all patients with a SARS-CoV-2 infection confirmed by polymerase chain reaction, who were treated in one of the 12 dedicated ICUs (from 8 hospitals in Tyrol, Austria) during the period from 1st February 2020 until 1st May 2022 of the COVID-19 pandemic. AKI was classified according to the Kidney Disease: Improving Global Outcomes (KDIGO) guidelines as increased serum creatinine or decreased urine output. Risk factors were evaluated with logistic regression analysis.

Results: In total, 1042 patients were included during the study period. The median age of the overall cohort was 66 years. Of the included patients, 244 (23.2%) developed AKI during the ICU stay. According to the KDIGO classification 7.8% had AKI stage 1, 5.0% AKI stage 2 and 11% AKI stage 3. Patients with AKI were older, had more often the pre-existing diagnosis of hypertension, cardiovascular disease, or a known renal comorbidity (Table 1). Compared to patients without AKI, patients with AKI had higher SOFA and SAPS-3 scores at admission and stayed significantly longer in the ICU (19 days vs. 9 days, $p < 0.001$) and in the hospital (28 days vs. 20 days, $p < 0.001$). In total 126 (12.3%) required renal replacement therapy (RRT) and the median duration was 9 (3–18) days. In patients with AKI the IMV rate was significantly higher with 88% ($n = 227$) compared to 41% ($n = 312$) in the no AKI group ($p < 0.001$). The most important risk factors for AKI were IMV (OR = 4.5 $p < 0.001$), age (OR = 1.01, $p = 0.013$), vasopressor use (OR = 3.13, $p < 0.001$) and renal comorbidities (OR = 2.17, $p < 0.001$) in a multivariable logistic regression analysis. Overall hospital and ICU mortality in our cohort were 26.4% and 23.1% respectively and significantly higher in the AKI group (Figure 1).

Table 1 (abstract 001030) Patient characteristics

	Overall	no AKI	AKI	<i>p</i> value
n	1042	761	267	
Sex = male/ female (%)	710/332 (68.1/31.9)	507/254 (66.6/33.4)	193/74 (72.3/27.7)	0.088
Age (median [IQR])	66 [56–75]	65 [54–74]	70 [59–78]	<0.001
Hypertension (%)	600 (57.6)	406 (53.4)	186 (69.7)	<0.001
Cardiovascu- lar (%)	387 (37.1)	252 (33.1)	131 (49.1)	<0.001
Renal comor- bidities	197 (18.9)	110 (14.5)	83 (31.1)	<0.001
SAPS III score (median [IQR])	53 [46–61]	51 [46–60]	58 [51–65]	<0.001
IMV (%)	545 (52.4)	312 (41.0)	227 (85.0)	<0.001
RRT (%)	126 (12.3)	16 (2.1)	110 (41.4)	<0.001
ICU LOS (median days [IQR])	11 [5–22]	9 [4–17]	19 [10–33]	<0.001
Hospital LOS (median days [IQR])	21 [13–36]	20 [13–32]	28 [15–47]	<0.001
Death in ICU (%)	241 (23.1)	112 (14.7)	126 (47.2)	<0.001
Death in Hos- pital (%)	275 (26.4)	131 (17.2)	139 (52.1)	<0.001

Conclusions: As in non-COVID-19 patients AKI was associated with an increased mortality in critically ill COVID-19 patients in our cohort. Among known risk factors IMV has been an independent predictor for AKI in our analysis. Therefore, the prevention of invasive ventilation may be an important strategy in the reduction of AKI in critically ill COVID-19 patients.

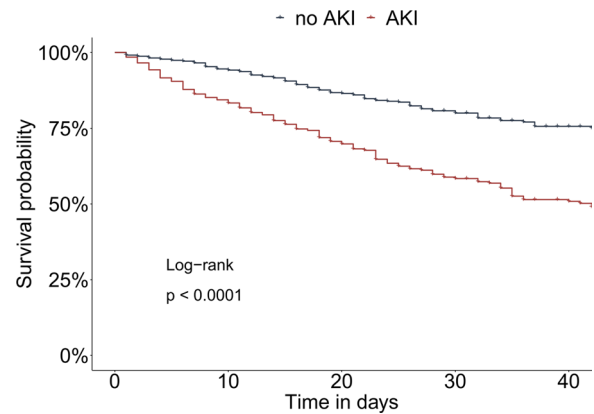

Figure 1 (abstract 001030) Kaplan–Meier survival curve: total cohort grouped by presence of Acute Kidney Injury

References

1. Nadim MK, Forni LG, Mehta RL, Connor MJ Jr, et al. COVID-19-associated acute kidney injury: consensus report of the 25th Acute Disease Quality Initiative (ADQI) Workgroup. *Nat Rev Nephrol.* 2020 Dec;16(12):747–764. doi: <https://doi.org/10.1038/s41581-020-00356-5>. Epub 2020 Oct 15.
2. The registry study was supported by the Tyrolean Government.

Topic: Acute Kidney Injury and haemofiltration

001032

End-tidal carbon dioxide monitoring during noninvasive ventilation in patients with acute respiratory failure due to cardiopulmonary edema: a pilot clinical study

M. Sakuraya¹, W. Iwata¹

¹Department of emergency and intensive care medicine, JA Hiroshima General Hospital, Hatsukaichi, Japan

Correspondence: M. Sakuraya

Intensive Care Medicine Experimental 2023, **11(Suppl 1)**:001032

Introduction: In the previous study (shown in references), we demonstrated that the end-tidal partial pressure of carbon dioxide (PETCO₂) can be used among patients undergoing noninvasive ventilation (NIV) to prevent postextubation respiratory failure. However, the usefulness of PETCO₂ monitoring is unclear among patients with respiratory failure.

Objectives: This pilot study aimed to investigate the usefulness of PETCO₂ monitoring during NIV among patients with acute respiratory failure due to cardiopulmonary edema.

Methods: Eight patients who underwent NIV for acute respiratory failure due to cardiopulmonary edema between October and December 2022 were included. We collected patient characteristics and following data up to 24 h or NIV separation, whichever shorter: NIV parameters (e.g., mode, settings, tidal volume, minute ventilation, PETCO₂, and leakage), respiratory rate, blood pressure, heart rate, and blood gas analysis.

Results: Two patients were male, and median age (interquartile range) was 90 (74.5–92.5) years old. One patient had chronic obstructive

pulmonary disease (COPD) as a comorbidity. The ratio of arterial oxygen partial pressure to fractional inspired oxygen (P/F ratio), pH, arterial partial pressure of carbon dioxide (PCO₂) and minute ventilation at a NIV initiation were 193 (133–293), 7.31 (7.29–7.37), 38.4 (35.2–41.4) mmHg, and 10.1 (8.0–17.3) L/min, respectively. All patients were managed at care units for critically ill patients and avoided intubation for worsening respiratory failure. Among 7 patients, excluding one patient with COPD, the difference between PCO₂ and PETCO₂ was 9.6 (6.9–11.2) mmHg at a NIV initiation. After starting NIV, we observed a decrease in the difference (4.9 [4.2–7.7] mmHg at 1–2 h and 2.7 [0.2–5.8] mmHg at 4–6 h). Meanwhile, the difference remained around 15 mmHg in the patient with COPD.

Conclusions: In patients with acute respiratory failure due to cardiopulmonary edema, the difference between PCO₂ and PETCO₂ was decreasing gradually with improvement in respiratory status after NIV was applied. However, the difference remained high in the patient with COPD.

References

1. Sakuraya M, Douno E, Iwata W, et al. Accuracy evaluation of mainstream and sidestream end-tidal carbon dioxide monitoring during noninvasive ventilation: a randomized crossover trial (MASCAT-NIV trial). *J Intensive Care*. 2022;10:17.

Topic: Acute respiratory failure and mechanical ventilation

001033

Mortality in patients with chronic kidney disease admitted to the ICU of a county hospital

M. Salgado¹, A. Alonso¹, M. Cózar¹, A. Alvarez¹, A. Ubeda¹

¹Intensive care unit, hospital Punta de Europa, Algeciras, Spain

Correspondence: A. Ubeda

Intensive Care Medicine Experimental 2023, **11(Suppl 1)**:001033

Introduction: The prevalence of chronic kidney disease is increasing. These patients have a higher risk of developing critical illness and also have a higher prevalence of comorbid disease that puts this population at higher risk for worse outcomes following ICU admission compared to the general population.

Objectives: To analyze factors associated to mortality in patients with Chronic kidney disease (CKD) admitted to the Intensive Care Unit (ICU) of the Hospital Universitario Punta de Europa.

Methods: Retrospective descriptive analysis on a prospective cohort performed in a 15-bed ICU from 2019 to 2022. Demographic outcomes, comorbidities, severity scores (APACHEII and SAPSII), treatment received, mechanical ventilation (MV), risk factors, ICU acquired infections, antibiotherapy, ICU and hospital length of stay (LOS) and mortality were collected. Statistical analysis: categorical variables (frequencies and percentages) and quantitative variables (mean and standard deviation or median and interquartile range). Comparisons: X2 test (percentages), Student's t test (means) and Mann-Whitney U test (medians). Multivariate logistic regression. Statistical significance at $p < 0.05$.

Results: 1470 patients were included: Patients with CKD (n = 183) vs. non-CKD (n = 1287) were compared: Male (57.9% vs. 66.5%, $p = 0.027$), age (71.7 [± 12.1] vs. 62.0 [± 15.4], $p < 0.001$). SAPS II (40 [30;52] vs. 27 [18;41], $p < 0.001$), APACHE II (16 [11;23] vs. 10 [6; 16], $p < 0.001$). GCS at admission (15 [11;15] vs. 15 [13;15], $p < 0.001$). Comorbidities: Diabetes mellitus (DM) (64.4% vs. 27.2%, $p < 0.001$); Immunosuppression (9.8% vs. 4.1%, $p = 0.001$); Chronic obstructive pulmonary disease (COPD) (15.3% vs. 7.6%, $p = 0.001$). Risk factors: Prior antimicrobial therapy (48 h) (36.6% vs. 28.7%, $p = 0.036$); Total parenteral nutrition (TPN) (25.1% vs. 14.6%, $p < 0.001$); Renal Replacement therapies (RRT) (20.7% vs. 5.9%, $p < 0.001$); central venous catheter (CVC) (74.8% vs. 59.4%, $p < 0.001$); Urinary catheter (UC) (88.5% vs. 68.9%, $p < 0.001$). Hospital-LOS (13 [7; 27] vs. 9 [5; 19], $p < 0.001$). ICU-LOS (4 [2; 9] vs. 3 [2; 7], $p = 0.010$). Days of CVC (3 [0; 8] vs. 2 [0; 6], $p = 0.006$), first period of CVC (days) (3 [0; 7] vs. 2 [0; 5], $p = 0.003$). Days of UC (4 [2; 8] vs. 3 [0; 7], $p < 0.001$). Mortality (44.2% vs. 27.3%, $p < 0.001$).

Survivors (n = 102) vs. dead (n = 81) were compared: SAPS II (36 [26; 45] vs. 47 [32; 59], $p < 0.001$), APACHEII (13 [9; 20] vs. 18 [13; 25], $p < 0.001$). GCS at admission (15 [15; 15] vs. 15 [7; 15], $p < 0.001$). Comorbidities: COPD (9.8% vs. 22.2%, $p = 0.034$). Risk factors: Prior antimicrobial therapy (48h) (28.4% vs. 46.9%, $p = 0.015$), TPN (17.6% vs. 34.5%, $p = 0.014$), CVC (61.7% vs. 91.3%, $p < 0.001$), UC (81.3% vs. 97.5%, $p < 0.001$), MV (19.6% vs. 64.1%, $p < 0.001$), RRT (12.7% vs. 30.8%, $p = 0.004$). Tracheostomy (0% vs. 8.6%, $p = 0.002$). ICU-LOS (4 [2; 7] vs. 6 [2; 12], $p = 0.018$). Days of MV (0 [0; 0] vs. 1 [0; 7], $p < 0.001$). Duration of CVC: total (2 [0; 6] vs. 5 [1; 11], $p < 0.001$), 1st CVC period (2 [0; 5] vs. 5 [1; 9], $p < 0.001$). Days of UC (4 [2; 7] vs. 6 [2; 11], $p = 0.006$). Days of Arterial catheter (AC) (0 [0; 0] vs. 1 [0; 5], $p < 0.001$). Multivariate logistic regression: RRT (OR 2.45 [1.07–5.77], $p < 0.036$), MV (OR 4.98 [2.44–10.46], $p < 0.001$), SAPS II (OR 1.02 [1.00–1.05], $p = 0.041$).

Conclusions: ICU mortality in patients suffering from CKD was 44.2%. SAPS II score, the need for MV as also for RRT were observed as independent risk factors for mortality.

Topic: Acute Kidney Injury and haemofiltration

001034

Comparison between invasive versus non-invasive respiratory support treatment and inflammatory biomarkers in COVID and non-COVID Acute Respiratory Distress Syndrome (ARDS)

R. Muñoz-Bermúdez¹; J. Ravelo Barba¹; M. Campano Garcia¹; D. Bujosa Ferragut¹; M. Villalonga Camps¹; B. Jove Comas²; FJ. Parrilla¹; A. Castellví-Font¹; I. Dot Jordana¹; C. Vilà-Vilardell¹; JR. Mascians Enviz³

¹Critical Care Department, Hospital del Mar, IMIM-GREPAC, Barcelona, Spain; ²Universitat Autònoma de Barcelona, Universitat Pompeu Fabra, Barcelona, Spain; ³Critical Care Department, Hospital del Mar, IMIM-GREPAC, Universitat Pompeu Fabra, Barcelona, Spain

Correspondence: R. Muñoz-Bermúdez

Intensive Care Medicine Experimental 2023, **11(Suppl 1)**:001034

Introduction: Acute respiratory distress syndrome (ARDS) is a common cause of hypoxemic acute respiratory failure (HARF). There are some emerging causes, such as viral pneumonia, specifically during the COVID-19 pandemic, that have increased the incidence of ARDS, which is now known as CARDS (COVID-associated ARDS). The pathophysiology of ARDS is very complex and not entirely understood since it involves numerous lung injuries and inflammation pathways. The most accepted definition of ARDS was the 2011 Berlin criteria. Although most of the patients with HARF included in high-flow nasal cannula (HFNC) treatment meet most of the Berlin criteria, it remains debated whether these patients can actually be designated as having ARDS. Amid the COVID-19 pandemic, it has been found that between 20–67% of patients with pneumonia and severe hypoxemia associated with SARS-CoV-2 infection develop ARDS. Our research group developed a study in 2017 with the aim of determining the existence of differences or similarities between mechanically ventilated (MV) patients and HFNC-treated patients. To do so, levels of epithelial, endothelial, and inflammatory plasma biomarkers were analyzed and no significant differences were found, supporting the idea that patients treated with HFNC, with HARF and bilateral radiologic infiltrates could be diagnosed with ARDS.

Objectives: The current project's main goal is to identify, in COVID patients with CARDS, differences between invasive and non-invasive respiratory support and to identify, comparing COVID and non-COVID-ARDS, differences between biomarker concentrations of systemic, epithelial and endothelial inflammation in order to find similarities in MV COVID patients and those treated with HFNC.

Methods: An uncentered prospective cohort study was performed during 3-year (2020–2022), recruiting patients admitted to a general ICU who met the Berlin definition for ARDS. Hypoxemic non-intubated patients (PaO₂/FiO₂ ≤ 300 or pulseoximetry SpO₂/FiO₂ ≤ 315) with bilateral radiographic opacities not fully explained by cardiac failure who were treated with HFNC were also included. Baseline-recorded data included demographic, comorbidities, and general respiratory and hemodynamic variables. Blood samples were collected 24 h after the onset. The biomarkers concentrations analyzed were systemic

inflammatory (interleukin-6 [IL-6] and interleukin-8 [IL-8]), epithelial (receptor for advanced glycation end products [RAGE] and surfactant protein D [SP-D]), and endothelial (angiopoietin-2 [Ang-2]). Baseline characteristics were matched based on age, sex, APACHE II, PaO₂/FIO₂ to compare biomarker plasma levels. The results of COVID patients were compared with non-COVID ARDS patients from the a previous project of our group. CEIC: 2020/9657.

Results: 135 patients with CARDS were enrolled. 22 patients needs MV at ARDS onset, whereas 113 where initially treated with HFNC. The MV group was older (72 vs 59; $p < 0.001$), with higher severity scores (APACHE II: 19.5 vs 13; $p < 0.001$ and SOFA: 7 vs 3; $p < 0.001$), worse PaFi (126 vs 156; $p < 0.029$) and worse outcomes as length of stay (19 vs 9; $p < 0.001$) and mortality (68.2% vs 12.4%; $p < 0.001$). After the performed matching by age, sex, PaFi and severity, 22 MV patients and 44 treated with HFNC were compared and no significant differences in biomarkers analyzed (RAGE, SP-D, Ang-2, IL-6 and IL-8) were found. In the HFNC matched group, 28(63.6%) patients needed to be intubated during their ICU stay (HFNC failure). Comparing biomarkers concentrations we found, in HFNC failure group, higher levels RAGE biomarker (5260 vs 1974; $p = 0.001$) and lower levels inIL-6 (403 vs 476; $p = 0.041$). We also identify that levels of RAGE ≥ 3338.5 pg/mL was an independent predictor of need of HFNC failure, even adjusted by severity (APACHE II and SOFA score) and IL-6 levels. Comparing COVID with non-COVID ARDS we found that patients with CARDS were older (68 vs 60; $p < 0.001$) and with better PaFi (141 vs 107; $p = 0.003$). About biomarker levels, RAGE (3591 vs 2394; $p = 0.003$) and IL-6 (315 vs 106; $p < 0.001$) were higher and SP-D (8.4 vs 13.6; $p = 0.009$) and Ang-2 (3359 vs 7075; $p < 0.001$) lower in COVID patients.

Conclusions: COVID patients with HARF presented similar patterns of biomarkers of inflammation and injury to ARDS patients undergoing MV. This suggests that patients treated with HFNC could be considered ARDS patients also when infected with SARS-CoV-2.

Topic: Acute respiratory failure and mechanical ventilation

001035

Role of neuromuscular electrical stimulation to prevent respiratory muscle weakness in critically ill patients and its association to changes in myokines profile. An exploratory randomized clinical trial

Y. Jalil¹, L. Damiani¹, R. Basoalto², V. Oviedo², D. Soto², E. D. Valenzuela Espinoza², P. García¹, M. C. Bachmann³, G. Buggedo², J. Retamal², J. A. Escalona Solari², L. Alegria², A. Bruhn²

¹Departamento Ciencias de la salud, Carrera de Kinesiología, Facultad de Medicina, Pontificia Universidad Católica de Chile, Santiago, Chile;

²Departamento de Medicina Intensiva, Pontificia Universidad Católica de Chile, Santiago, Chile; ³Carrera de Kinesiología, Facultad de Medicina, Universidad de los Andes, Santiago, Chile

Correspondence: J. Yorschua

Intensive Care Medicine Experimental 2023, **11**(Suppl 1):001035

Introduction: Critically ill patients hospitalized at Intensive Care Units (ICU) are characterized by an accelerated muscle wasting, particularly of respiratory muscles, occurring early due to mechanical ventilation (MV). Although active muscle activation may prevent these alterations, it is usually not available at early stages of care because of sedation, favoring a vicious circle. Neuromuscular electrical stimulation (NMES) represents an alternative to achieve muscle contraction in this setting, being able to prevent local muscle wasting, and according to some reports, has the potential to shorten MV time, suggesting a systemic effect through myokines, a diverse range of chemokines secreted by myocytes during contraction. However, no studies have evaluated whether NMES applied to peripheral muscles in critically ill patients can exert distant muscle effects over the diaphragm, and if such effects are associated to changes in myokine concentrations.

Objectives: To determine the effects of NMES on myokine plasma concentrations, and on peripheral and respiratory muscle function and structure, in mechanically ventilated ICU patients when initiated at an early phase of their critical illness.

Methods: Exploratory randomized controlled trial of NMES applied twice a day, for 3 days, in comparison to standard care. For myokine characterization (IL-6, BDNF, Myostatin and Decorin), blood samples were obtained at baseline (T0), at the end of NMES session (T1), and 2 and 6 h later (T2 and T6). This sampling was repeated on days 1 and 3. For the control group (CG) blood were obtained only at T0 and T6. Muscle characterization [ultrasonography of quadriceps muscle layer thickness (MLT), and diaphragmatic thickening fraction (TFdi), along with tracheal tube pressure derived from phrenic nerve magnetic stimulation (Ptr,tw, for diaphragmatic function)] were performed at days 1 and 3 (T0 and T6 respectively).

Results: 11 patients were randomized: 6 to CG and 5 to NMES. No differences were observed between groups at baseline [Median of 57 and 64 years old for CG and NMES, respectively (p -value of 0.57); median Body Mass Index of 26.5 and 24.8 kg/m² for CG and NMES, respectively (p -value of 0.79); median of 48 h of MV for both groups (p -value of 0.29); and a median APACHE II score of 27.5 and 27, respectively (p -value of 0.89)]. The median quadriceps MLT of CG decreased 27% from day 1 to day 3 [from 1.78 cm (1.3–2.7) at day 1, to 1.3 cm (1.1–2.4) at day 3, with a p -value < 0.01], while no significant change was observed in the NMES group, which experienced a 13% decrease in MLT from day 1 to day 3 [1.7 cm (1.3–2.3) at day 1, to 1.5 cm (1.1–2.3) at day 3, with a p -value < 0.06], (Figure 1). With regard to TFdi, no significant change was found between days 1 and 3 for either the CG or NMES group (p -value of 0.06 and 0.31 respectively). Interestingly, the NMES group exhibited a slight increase in TFdi (from a median of 19.5% to 22%), while the CG showed a slight decrease (from a median of 25.2% to 15%). For Ptr,tw a median decrease of 1.73 cmH₂O from day 1 to 3 was observed in the CG (p -value of 0.03), with no significant change in the NMES group (p -value = 0.19) (Figure 2). There was no significant difference between NMES and CG at either day 1 or day 3 for MLT (p -value of 0.66 and 0.83, respectively), TFdi (p -value of 0.52 for both days), or Ptr,tw (p -value of 0.25 and 0.9, respectively). Regarding myokine's plasmatic concentrations, there were no significant differences between NMES group and CG at any time point, or within either group (p -value of 0.92 and 0.62 for Decorin in the NMES and CG, respectively; p -value of 0.92 and 0.41 for Myostatin in the NMES and CG, respectively; p -value of 0.71 and 0.92 for IL-6 in the NMES and CG, respectively; and a p -value of 0.33 and 0.13 for BDNF in the NMES and CG, respectively).

Conclusions: Preliminary results from this exploratory randomized study, showed a peripheral muscle preservation, indicated by an amelioration of quadriceps MLT decrease, as well as improved diaphragm function (significant increase of Ptr, Tw) in the NMES group. No significant change was found regarding myokines in response to NMES. However, more data are needed from a larger number of patients to establish a more clear conclusion.

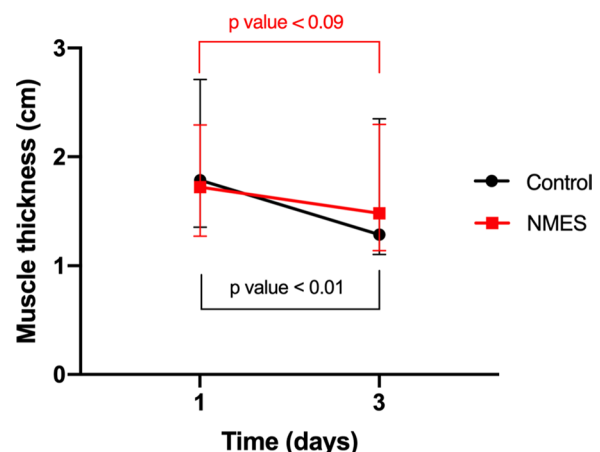

Figure 1 (abstract 001035) Quadriceps muscle layer thickness. In red lines median values for muscle layer thickness (right and left leg

combined), from day 1 to 3, in the neuromuscular electrical stimulation group (NMES). In black lines, median for quadriceps muscle layer thickness in control group, also for right and left leg combined. P value for intragroup comparison

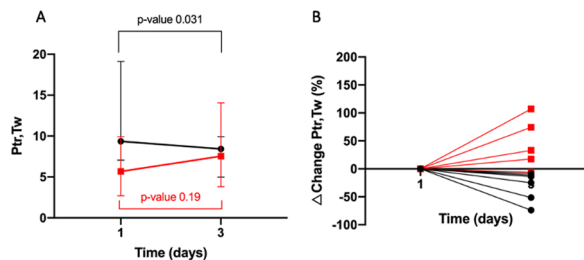

Figure 2 (abstract 001035) Twitch tracheal pressure. A) Absolute changes in twitch tracheal pressure (Ptr,Tw) from day 1 to 3. B) Relative changes for Ptr,tw from day 1 to 3. In red the neuromuscular electrical stimulation group (NMES). In black, changes in control group (CG). All individual values has been normalized according to baseline values and expressed as percent

References

- Piccirillo R. Exercise-induced myokines with therapeutic potential for muscle wasting. *Front Physiol.* 2019;10
- Dres M, Goligher EC, Heunks LMA, Brochard LJ. Critical illness-associated diaphragm weakness. *Intensive Care Med.* 2017;43(10):1441–52.
- Wall BT, Dirks ML, Snijders T, Senden JMG, Dolmans J, Van Loon LJC. Substantial skeletal muscle loss occurs during only 5 days of disuse. *Acta Physiol.* 2014;210(3):600–11.
- Gruther W, Benesch T, Zorn C, Paternostro-Sluga T, Quittan M, Fialka-Moser V, et al. Muscle wasting in intensive care patients: Ultrasound observation of the M. quadriceps femoris muscle layer. *J Rehabil Med.* 2008;40(3):185–9.
- Kress JP, Hall JB. ICU-acquired weakness and recovery from critical illness. *N Engl J Med.* 2014;370(17):1626–35.
- IV CONCURSO DE APOYO A LA INVESTIGACION. Departamento de Ciencias de la Salud, Facultad de Medicina, Pontificia Universidad Católica de Chile Santiago
- Karavidas AI, Raisakis KG, Parissis JT, Tsekoura DK, Adamopoulos S, Korres DA, et al. Functional electrical stimulation improves endothelial function and reduces peripheral immune responses in patients with chronic heart failure. *Eur J Prev Cardiol.* 2006;13(4):592–7.
- outsu C, Gerovasili V, Vasileiadis I, Karatzanos E, Pitsolis T, Tripodaki E, et al. Electrical muscle stimulation prevents critical illness polyneuropathy: A randomized parallel intervention trial. *Crit Care.* 2010;14(2).
- Abu-Khabber HA, Abouelela AMZ, Abdelkarim EM. Effect of electrical muscle stimulation on prevention of ICU acquired muscle weakness and facilitating weaning from mechanical ventilation. *Alexandria J Med [Internet].* 2013;49(4):309–15. Available from: doi: <https://doi.org/10.1016/j.ajme.2013.03.011>
- Pedersen BK, Steensberg A, Fischer C, Keller C, Keller P, Plomgaard P, et al. Searching for the exercise factor: Is IL-6 a candidate? *J Muscle Res Cell Motil.* 2003;24(2–3):113–9.
- Lightfoot AP, Cooper RG. The role of myokines in muscle health and disease. *Curr Opin Rheumatol.* 2016;28(6):661–6.

Topic: Nursing care and physiotherapy

001037

Assessing the benefit of high frequency chest wall oscillation therapy (HFCWO) in ICU patients suffering from COPD by using electrical impedance tomography: InVESTigate-Study

S. E. Stoll¹, E. Underberg¹, F. Dussé¹, S. J. Sharma², U. Werra³, B. W. Böttiger¹, A. Mathes¹

¹Anaesthesiology and Intensive Care Medicine, University of Cologne, Faculty of Medicine and University Hospital, Cologne, Germany; ²ENT,

University of Cologne, Faculty of Medicine and University Hospital, Cologne, Germany; ³Vascular and Endovascular Surgery, University of Cologne, Faculty of Medicine and University Hospital, Cologne, Germany

Correspondence: S.E. Stoll

Intensive Care Medicine Experimental 2023, **11(Suppl 1)**:001037

Introduction: Patients suffering from chronic obstructive pulmonary disease (COPD) requiring mechanical ventilation and admission to ICU after elective surgery are prone to airway infections caused by airway obstruction from hypersecretion of inflamed airways. [1] As a consequence, patients with COPD present with a higher mortality rate, a longer interval of MV and an increased length of ICU- stay.[2–4] High frequency chest wall oscillation (HFCWO) can improve the mobilization of airway secretions and reduce the amount of atelectasis in patients with COPD.[5, 6] However, so far, there is little data about the benefit of HFCWO in patients with COPD in the ICU setting.

Objectives: Aim of this study was to assess, whether HFCWO plus standard ICU care including chest physiotherapy versus sole standard ICU care including chest physiotherapy is able (a) to reduce the rate of pneumonia, (b) to diminish the length of MV/ICU- stay and (c) to improve distribution of lung ventilation (monitored by electrical impedance tomography (EIT)) in adult patients with COPD admitted to ICU after elective surgery.

Methods: Prospective, randomized, single center pilot study including adult patients with COPD, admitted electively after surgical treatment to a German ICU of a quaternary care hospital from 12/2022- 04/2023. Planned total sample size of the pilot study: 50 patients (student-T-test, power 80%, alpha 0.05, effect size 0.4). Prior to study inclusion severity of COPD (FeV1, Bode- index, mMRC-Score) is assessed. Patients with contraindications for the use of HFCWO / EIT are excluded from the study. All patients are randomized to either (a) control group with standard ICU care with chest physiotherapy or to (b) interventional (HFCWO) group including standard ICU Care with chest physiotherapy plus HFCWO (15Herz, 2 mbar, 15 min once daily for 5 days or until discharge from ICU). Primary endpoints of the study: Length of MV and length of ICU- stay. Secondary endpoints: Rate of pneumonia and results from EIT-monitoring (Win of compliance in %). This study was approved by the local Ethical Committee (22-1140_1).

Results: So far, 20 patients could be included (interventional group n = 12, control group n = 8), tolerating HFCWO well without any side effects. In the HFCWO group 10/12 patients were male vs 3/8 in the control group (p = 0.04). There was no significant difference regarding age, body mass index, SOFA-Score, COPD- severity (FeV1, Bode-Index, mMRC) in HFCWO vs control group. The rate of pneumonia was higher in the control- (n = 4) vs HFCWO- group (n = 1; p = 0.04). Regarding EIT-monitoring, win of compliance (%) after treatment was higher in the HFCWO group (32.03 ± 18.79%) vs control group (6.5 ± 4.12%; p = 0.05). However, HFCWO was not associated with a reduction of length of MV or ICU stay.

Conclusions: HFCWO as an additional treatment of patients with COPD in the ICU-setting after elective surgery can potentially reduce the rate of pneumonia and improve respiratory compliance by reducing atelectasis. However, in this study, HFCWO plus chest physiotherapy versus sole chest physiotherapy was not able to reduce length of MV or ICU- stay. After completion of the pilot study, a larger, randomized, multicenter study is required to prove this association.

References

1. Chuang, M.L., et al., Instantaneous responses to high-frequency chest wall oscillation in patients with acute pneumonic respiratory failure receiving mechanical ventilation: A randomized controlled study. *Medicine (Baltimore)*, 2017. 96(9): p. e5912.
2. Svenningsen, S., et al., Oscillatory Positive Expiratory Pressure in Chronic Obstructive Pulmonary Disease. *COPD*, 2016. 13(1): p. 66–74.
3. Nseir, S., et al., Impact of ventilator-associated pneumonia on outcome in patients with COPD. *Chest*, 2005. 128(3): p. 1650–6.

4. 4. Funk, G.C., et al., Prevalence and prognosis of COPD in critically ill patients between 1998 and 2008. *Eur Respir J*, 2013. 41(4): p. 792–9.
5. 5. Nicolini, A., et al., Effectiveness of treatment with high-frequency chest wall oscillation in patients with bronchiectasis. *BMC Pulm Med*, 2013. 13: p. 21.
6. 6. Bhowmik, A., et al., Improving mucociliary clearance in chronic obstructive pulmonary disease. *Respir Med*, 2009. 103(4): p. 496–502.
7. 7. To the hard work and devotion to patient care of all ICU doctors and nurses, enabling this study.

Topic: Acute respiratory failure and mechanical ventilation

001038

Diffusion and users' experience assessment of the electronic health records in the Italian intensive care units: a national survey

J. Montomoli¹, F. Saglietti², M. M. Bitondo¹, L. Ramahi³, V. Bellini⁴, E. Gamberini¹, V. Agnoletti⁵, E. Bignami⁴

¹Anesthesia and Intensive Care, Ospedale "Infermi" di Rimini, Rimini, Italy; ²Department of Emergency and Critical Care, Azienda Ospedaliera S. Croce e Carle Cuneo, Cuneo, Italy; ³Anestesia e rianimazione, Università La Sapienza, Roma, France; ⁴Anesthesiology, Critical Care and Pain Medicine Division, Department of Medicine and Surgery, University of Parma, Parma, Italy; ⁵Surgical and major trauma department, maurizio bufalini hospital, Unit of anesthesia and resuscitation, Cesena, Italy

Correspondence: J. Montomoli

Intensive Care Medicine Experimental 2023, **11(Suppl 1)**:001038

Introduction: Since 2011 the implementation towards the acquisition of Electronic health records (EHR) has been a priority for Europe (1). EHRs hold the promise of significantly improving clinical outcomes by merging information, introducing prescription's monitoring and safety alerts, providing clinical decision support systems, and improving data availability for research purposes, particularly in Intensive Care Units (ICUs).

Objectives: The actual diffusion of EHRs and user experience evaluation in Italian ICUs have not been assessed yet (2, 3). We, therefore, carried out a survey to investigate the prevalence of EHRs adoption in Italian ICUs and their performance evaluation by healthcare workers.

Methods: The survey was launched on social networks (Facebook, Twitter, LinkedIn, and Whatsapp) and shared by email from May 17th, 2022 and was closed on October 30th, 2022. The survey consisted of an anonymous questionnaire on Google Forms and was addressed to consultants, residents, and nurses working in Italian ICUs. Participants were asked to rate the overall experience with EHRs on a scale of 1 to 10 and individual tasks on a scale of 1 to 5.

Results: A total of 1,047 questionnaires were filled, with a completion rate of 100%. Health workers employed in 20 different Italian regions (out of 21) took part in the survey: 47.7% were consultants, 29% residents, and 23.3% nurses. Among participants, 58.2% declared to use EHRs while the remaining 41.8% declared to still use paper records. The prevalence of participants using EHRs was not homogeneous, being higher in Central (71.2%) and Northern (67.2%) Italy and markedly lower in the south (15.7%). The overall evaluation of EHRs had a median score 8 (IQR 6–8). However, all individual tasks got a median score below or equal to 3 (Table).

Conclusions: The majority of participants declared to use EHRs, however the diffusion seems to be not uniform in different Italian regions. Overall, participants reported high levels of satisfaction in EHRs use, however, analysing individual functions critical issues emerged. Individual tasks received low scores and seem not to fulfil users' expectations. This suggests that while EHRs are perceived as beneficial, there may be room for improvement in specific tasks performance.

Easy to use	3 (2-4)
Interfacing with monitoring and infusion systems	2 (1-4)
Data acquisition from other software (PACS, laboratory tests, etc.)	3 (2-3)
Possibility of customization	3 (2-3)
Prescription control systems	3 (2-3)
Clinical decision support	2 (1-3)
Customer service (troubleshooting)	2 (2-3)
Acquisition of local forms/modules	2 (2-3)

Tab 1. Individual function scores

References

1. None
2. 1) Stroetmann, Karl A., et al. "European countries on their journey towards national eHealth infrastructures." Luxembourg: Office for official publications of the european communities (2011).
3. 3) DesRoches CM, Campbell EG, Vogeli C, et al. Electronic health records' limited successes suggest more targeted uses. *Health Aff (Millwood)* 2010;29(4):639–646.
4. 2) Ehrenfeld, Jesse M., and Jonathan P. Wanderer. "Technology as friend or foe? Do electronic health records increase burnout?." *Current Opinion in Anesthesiology* 31.3 (2018): 357–360.

Topic: Critical care organisation, quality management, information systems, outcomes

001039

The microcirculation network research group: moving towards the use of microcirculation monitoring at the bedside

J. Montomoli¹, M. P. Hilty², E. Favaron³, P. Guerci⁴, B. Ergin³, C. Ince³

¹Anesthesia and Intensive Care, Ospedale "Infermi" di Rimini, Rimini, Italy; ²Medical Intensive Care Unit, University Hospital of Zurich, Zürich, Switzerland, Switzerland; ³Department of Intensive Care, Erasmus MC, University Medical Center, Rotterdam, Netherlands; ⁴Département d'anesthésie-réanimation, institut lorrain du cœur et des vaisseaux, CHRU Nancy, Nancy, France

Correspondence: J. Montomoli

Intensive Care Medicine Experimental 2023, **11(Suppl 1)**:001039

Introduction: Handheld vital microscopy is a largely used technology for scientific research in the Intensive care setting. However, due to previous technological limitations, mainly related with the images analysis, and lack of consistent results regarding its application at the bedside, its use is still limited to research. In 2019, our group developed MicroTools, the first validated software for automatic analysis of images of the microcirculation [1]. Subsequently, we developed the rationale for the application of the "three pillars of digital transformation" in the field of microcirculation by developing the Microcirculation Network Research Group (MNRG) [2]. The mission of the MNRG is to finally bring the technology of microcirculation monitoring to the bedside.

Objectives: To test the entire MNRG concept and its workflow in two different scenario including 1) the development of a new parameter and 2) the validation of an AI-based algorithm.

Methods: The MNRG workflow includes the following steps illustrated in the Figure: 1) the signature of a collaboration agreement, 2) the transfer of the data and images to a cloud and the images analysis by MicroTools, 3) the definition of the rationale to be explored with the definition of the approach (prototyping), 4) the validation of the hypothesis on the data, 5) the publication of the results, 6) the availability of the algorithm for external validation and further improvements. All data are stored in a relational database with limited and regulated access and includes quality gates. The entire process warrants a continuously growing dataset with complete information and containing data standardized and of high-quality.

Results: The two concepts tested in the MNRG regarded 1) the validation of a new parameter aimed to provide a unique number describing the overall perfusion of the observed tissue by red blood cells defined as tissue Red Blood Cell perfusion (tRBCp) and 2) the development and validation of an AI-based algorithm able to differentiate severe COVID-19 patients from volunteers only by the assessment of the sublingual microcirculation. The rationale and the development of tRBCp was described in an individual paper [3] and subsequently clinically validated on data from patients undergoing noncardiac surgery from Hamburg [4]. The rationale, development, and validation of the AI algorithm detecting COVID-19 patients was obtained from data provided by four different centers and published on the Critical Care [5]. Each individual step for both projects is described in the Figure. Nowadays, the MNRG is actively collaborating with 23 centers in 11 countries on 26 different projects and it is continuously expanding.

Conclusions: The MNRG together with the recent technical and methodological developments including the introduction of a validated software for automatic analysis, will markedly contribute to the technological transfer of microcirculation monitoring from a research tool to a clinical decision support system to use at the bedside with defined and validated clinical applications able to guide therapeutic decision with a significant impact on patient prognosis. Other potential implications will involve the identification of microcirculatory patterns, the investigation of compensatory mechanisms, the development of new parameters and applications.

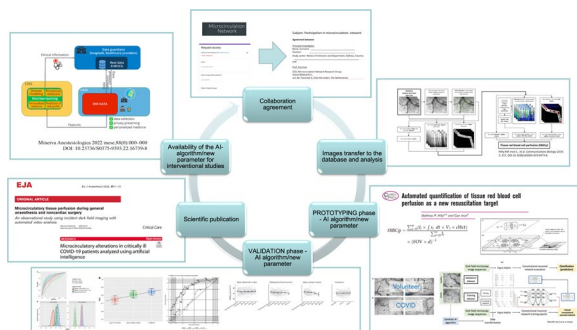

Image providing the standardized workflow of the Microcirculation Network Research Group (MNRG) reporting two examples of collaborations regarding the development of a new parameter and the development and validation of an algorithm based on artificial intelligence distinguishing severe COVID19 patients from health volunteers based on sublingual microcirculation.

References

- None
5. Hilty MP, Favaron E, Wendel Garcia PD, Ahiska Y, Uz Z, Akin S, et al. Microcirculatory alterations in critically ill COVID-19 patients analyzed using artificial intelligence. *Crit Care*. 2022;26:311
4. Flick M, Schreiber T-H, Montomoli J, Krause L, de Boer HD, Kouz K, et al. Microcirculatory tissue perfusion during general anaesthesia and non-cardiac surgery: An observational study using incident dark field imaging with automated video analysis. *European Journal of Anaesthesiology* [Internet]. 2022 [cited 2022 Jun 27]; Available from: <https://journals.lww.com/10.1097/EJA.0000000000001699>
3. Hilty MP, Ince C. Automated quantification of tissue red blood cell perfusion as a new resuscitation target: Current Opinion in Critical Care. 2020;26:273–80.
2. Montomoli J, Hilty MP, Ince C. Artificial intelligence in intensive care: moving towards clinical decision support systems. *Minerva Anesthesiol*. 2022;
1. Hilty MP, Guerci P, Ince Y, Toraman F, Ince C. MicroTools enables automated quantification of capillary density and red blood cell velocity in handheld vital microscopy. *Communications Biology* [Internet]. 2019 [cited 2019 Aug 18];2. Available from: <http://www.nature.com/articles/s42003-019-0473-8>

Topic: Translational Medicine

001040

Antimicrobial stewardship pathway in the ICU: quality improvement collaborative for addressing the aftermath of the COVID-19 pandemic

C. I. Loudet¹, F. Jorro-Barón², V. Rodríguez², W. Cornistein³, E. García Elorrio², I. Suárez-Anzorena², C. Meregalli⁴, M. V. Rodríguez³, M. Lescano², J. Roberti², A. P. Rodríguez², M. Guglielmino², M. P. Arias López⁵, M. E. Ratto⁵, L. Cabana⁶, E. Cunto⁷, R. Villegas⁸, C. Balasini⁹, F. Perre¹⁰, M. Rivet¹¹, G. Izzo¹², R. Corral¹³

¹Intensive Care Unit, HIGA San Martín, Argentina Intensive Care Society (SATI), La Plata, Argentina; ²Quality department, [IECS] Instituto de Efectividad Clínica y Sanitaria, Buenos Aires, Argentina; ³Quality Department, Sociedad Argentina de Infectología (SADI), Buenos Aires, Argentina; ⁴Terapia intensiva, Argentina Intensive Care Society (SATI), Buenos Aires, Argentina; ⁵Intensive Care Unit, Argentina Intensive Care Society, Buenos Aires, Argentina; ⁶Intensive care unit, Hospital Pablo Soria, San Salvador de Jujuy, Argentina; ⁷Intensive Care Unit, Hospital Muñoz, Buenos Aires, Argentina; ⁸Intensive Care Unit, Francisco Lopez Lima Hospital, General Roca, Argentina; ⁹Intensive care unit, Hospital General de Agudos Dr. Pirovano, Buenos Aires, Argentina; ¹⁰Intensive care unit, neuquen Provincial Hospital Dr. Castro Rendon, Neuquén, Argentina; ¹¹Intensive Care Unit, Hospital Rivadavia, Buenos Aires, Argentina; ¹²Intensive Care Unit, Hospital Simplemente Evita, González Catán, Argentina; ¹³Intensive Care Unit, Hospital Interzonal de Agudos Evita, Lanús, Argentina

Correspondence: C. I. Loudet

Intensive Care Medicine Experimental 2023, **11(Suppl 1)**:001040

Introduction: Antimicrobial resistance (AR) is the inevitable result of antimicrobial (AM) use, and it is exacerbated by its inappropriate use and overuse. ICUs are areas with more risk of AR. An increase in the incidence of AR posed collateral damage during and after the COVID-19 pandemic. Antibiotic Stewardship Programs (ASP) have been developed for optimizing the treatment of infections, reducing infection-related and limiting the appearance of multidrug-resistant organisms (MDROs). In this research, a Quality Improvement Collaborative (QIC), preceded by a formative phase was proposed to improve the use of AM using stewardship strategies.

Objectives: To implement a multifaceted intervention to enhance the quality of AM prescription throughout the reduction of AM days of therapy (DOT) and AM defined daily dose (DDD), and the increase in AM de-escalation compliance.

Methods: Quasi-experimental design, before-after analysis, carried out in 9 ICUs of the public sector in Argentina, from March 2022 to February 2023. The QIC followed the Institute for Healthcare Improvement's Breakthrough Series Model.

There were 16 and 32 weeks of measurements in Pre-Intervention period (Pre-IP) and Intervention period (IP). Inclusion criteria was AM requirement within 28 days of ICU admission. The IP included learning sessions and periods of action using Plan-Do-Study-Act (PDSA) cycles. The Antibiotic Stewardship Program consisted of audit and feedback of antibiotics use, facility-specific treatment guidelines or clinical pathway, infection-based interventions-focused on improving diagnostic accuracy-, pharmacy-based interventions, education, tailoring of therapy to culture results, and optimization of the duration of treatment (antibiotic timeout). Medians of weekly proportions of AM DDD/1000

patient-days, AM DOT/1000 occupied bed-days, and compliance with AM de-escalation (proportion of empirical therapy changed to pathogen-directed therapy up to 24hs after culture results became available) were compared between both periods using Wilcoxon rank-sum test or Chi2. A p value ≤ 0.05 was considered significant for all comparisons.

Results: A total of 912 patients were included, 357 in Pre-IP and 555 in IP. Patient characteristics in Pre-IP and IP were Age 51 [34–64] vs 50 [36–65]; Sex fem 143 (40%) vs 213 (38%); APACHE-II score 15[11–20] vs 17[12–21]; SOFA 5[3–8] vs 6[4–9]; mechanical ventilation (MV) requirement 270 (76%) vs 420 (76%); MV-days 10[4–18] vs 9[4–18]; renal failure 118 (33%) vs 231 (42%); septic shock 185 (34%) vs 325 (40%) and ICU mortality 94 (26%) vs 189 (34%).

There were not significant differences in AM DOT/1000 occupied bed-days Pre-IP: 1149 [p251042-p751272] vs IP 1112 [p251073-p751163], p=0.54; neither in AM DDD/1000 patient-days: 1192 [p251066-p751399] vs IP 1163 [p251056-p751309], p=0.62. Compliance with AM de-escalation improved from 45 to 61% (p=0.004) (Fig*0.1).

Conclusions: The QIC was effective to improve compliance with ATM de-escalation as part of an Antibiotic Stewardship Program. It was not possible to reduce AM DDD/1000 patient-days, and AM days of therapy (DOT)/1000 occupied bed-days. However, population in the IP presented more severity of illness and these results will possibly benefit of an illness severity adjustment. This first initiative highlights the need to continue working on how to address and improve topics of antimicrobial resistance.

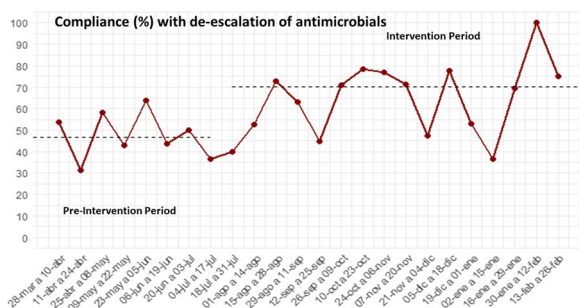

Compliance with antimicrobial de-escalation.

References

- Global Pfizer® Grant

Topic: Infections and prevention

001041

Association of C reactive protein/procalcitonin ratio with mortality in patients with septic shock in the ICU

V. A. Martha Mayoral¹, C. Zarate-Rodriguez², A. Sanchez-Calzada³, B. A. Martinez Diaz³, J. S. Aguirre-Sanchez⁴

¹Medicina Crítica, ABC Observatory Medical Center, Ciudad de México, Mexico; ²Medicina Crítica, ABC Medical Center, Ciudad de México, Mexico; ³Intensive Care Unit, ABC Medical Center, Ciudad de México, Mexico; ⁴Critical care unit, ABC Medical Center, Ciudad de México, Mexico

Correspondence: V.A. Martha Mayoral

Intensive Care Medicine Experimental 2023, **11(Suppl 1)**:001041

Introduction: Septic shock is the more severe form of sepsis that, in spite of advances in diagnosis and treatment, remains with a high mortality ratio in all intensive care units around the world. Many scores are used to assess severity at admission, which reflects in prediction of mortality, although sepsis related serum biomarkers C- reactive protein and procalcitonin are a useful diagnostic tool, evidence is controversial about if they could be used to predict mortality, and there is

currently little or no evidence that the ratio between both biomarkers could be used to predict mortality.

Objectives: Describe association between C reactive protein/Procalcitonin ratio and mortality in patients with septic shock.

Methods: A retrospective, observational, transverse, single tertiary care center study in patients with septic shock admitted between January 2022 and January 2023 was conducted. Demographic, laboratory and microbiological data were analyzed and pooled.

Results: A total of 142 patients were enrolled, of which 113 survived (79.6%) and 29 died (20.4%). In the survivor group, 26 (18.3%) had a < 0.5 CRP/PCT ratio vs 87 (61.3%) of the > 0.5 group, while in the non-survivor group, 11 (37.9%) had a < 0.5 CRP/PCT ratio vs 18 (62.1%) of the > 0.5 group (RR 0.489, CI 0.205–1.166, p=0.107).

Conclusions: Although not statistically significant, we found that lower CRP/PCT ratios could correlate with a higher mortality rate. Larger populations would be needed to correlate this association.

References

- Póvoa P, Coelho L, Dal-Pizzol F, Ferrer R, Huttner A, Conway Morris A, et al. How to use biomarkers of infection or sepsis at the bedside: guide to clinicians. *Intensive Care Medicine*. 2023 Jan 2;49(2):142–53.
- Singer M, Deutschman CS, Seymour CW, Shankar-Hari M, Annane D, Bauer M, et al. The Third International Consensus Definitions for Sepsis and Septic Shock (Sepsis-3). *JAMA*. 2016 Feb 23;315(8):801.
- No grant was provided to fund this investigation
- Hahn W-H, Song J-H, Kim H, Park S. Is procalcitonin to C-reactive protein ratio useful for the detection of late onset neonatal sepsis? *The Journal of Maternal & Neonatal Medicine*. 2017 Mar 9;31(6):822–6.
- Sproston NR, Ashworth JJ. Role of C-Reactive Protein at Sites of Inflammation and Infection. *Frontiers in Immunology*. 2018 Apr 13;9.
- Suberviola B, Castellanos-Ortega A, González-Castro A, García-Astudillo LA, Fernández-Miret B. Prognostic value of procalcitonin, C-reactive protein and leukocytes in septic shock. *Medicina Intensiva (English Edition)*. 2012 Apr;36(3):177–84.
- Wacker C, Prkno A, Brunkhorst FM, Schlattmann P. Procalcitonin as a diagnostic marker for sepsis: a systematic review and meta-analysis. *The Lancet Infectious Diseases*. 2013 May;13(5):426–35.
- Hamade B, Huang DT. Procalcitonin. *Critical Care Clinics*. 2020 Jan;36(1):23–40.
- Godínez-Vidal AR, Alcántara-Gordillo R, Aguirre-Rojano VI, López-Romero SC, González-Calatayud M, González-Pérez LG, et al. Evaluación de la proteína C reactiva, la procalcitonina y el índice PCR/PCT como indicadores de mortalidad en sepsis abdominal. *Cirugía y Cirujanos*. 2020 Feb 20;88(2).
- Vincent J-L, Jones G, David S, Olariu E, Cadwell KK. Frequency and mortality of septic shock in Europe and North America: a systematic review and meta-analysis. *Critical Care*. 2019 May 31;23(1).
- Minne L, Abu-Hanna A, De Jonge E. Open Access Evaluation of SOFA-based models for predicting mortality in the ICU: A systematic review. *Critical Care*. 2008;12(6):161.

Topic: Sepsis

001042

A descriptive retrospective study: micronutrient intake levels in critically-ill patients on enteral tube feeding

R. G. J. Ramos¹, C. J. Balalta¹, N. Mustofa¹

¹Internal Medicine, Asian Hospital and Medical Center, Muntinlupa, Philippines

Correspondence: R. G. J. Ramos

Intensive Care Medicine Experimental 2023, **11(Suppl 1)**:001042

Introduction: Most enteral nutrition (EN) formulas are designed also to meet the increased micronutrient needs in critically-ill patients. For this reason, determining the potential excess or deficiency of certain micronutrients is essential especially for patients on enteral formula tube feeding. Despite the widespread use of EN, both in hospitals and at home, studies on the micronutrient compositions in the enteral mixtures are deficient, thus an evaluation of the amount of vitamins

and trace elements in the currently used enteral feedings requires consideration.

Objectives: GENERAL OBJECTIVE To describe the micronutrient intake levels among ICU patients who were tube fed for at least three days at AHMC and identify the percentage of ICU patients achieving the recommended energy and nutrient intake on micronutrient intake.

SPECIFIC OBJECTIVES 1) To describe the demographic profile of critically-ill patients with enteral feeding. Age, Gender, Co-morbidities 2) To determine the type of tube feeding formula used and average three-day amount of micronutrient intake levels among ICU patients 3) To determine the percentage of patients who achieved the Recommended Energy and Nutrient Intake for Filipinos.

Methods: This is a descriptive retrospective study (using chart review of admissions last January 1 to December 31, 2020) conducted at the Asian Hospital & Medical Center, a 296-bed capacity tertiary hospital in Muntinlupa, Philippines. All patients admitted at the Asian Hospital & Medical Center Intensive Care Unit from January 1, 2020 to December 31, 2020, who had enteral feedings for at least three days were included in the review. Descriptive statistics were used to summarize the demographic characteristics and pertinent variables needed for the study. One-way Analysis of Variance was used to compare the average three-day amount of micronutrient intake levels among ICU patients according to the type of feeding. Pairwise comparison using Least Significant Difference (LSD) was carried out to determine pairwise comparison.

Results: 60 patients were included in the study, with a mean age of 68.72 years, with most patients in the 61–70 years age group (20 (33%)). Majority of the patients were male (34 (56.7%)) and the rest were female (26 (43.3%)). Arterial hypertension (65%) and diabetes mellitus (insulin and noninsulin requiring, 50%) were the most commonly reported co-morbidities among included patients. The macro minerals included in this study are potassium, sodium, phosphorus and magnesium. The average potassium level intake of ICU patients reached at least 45% of the RNI, magnesium levels were able to attain 69% of the RNI, phosphorus levels reached 72%, sodium levels exceeded the RNI by 129%. Trace minerals included in the study were zinc and selenium. Both zinc and selenium exceeded RNI by 180% and 129%, respectively. For vitamin C, it also exceeded by 184%, while vitamin B1 also exceeded by 129%, vitamin B6 levels were at 168% and vitamin B12 also exceeded it by 179%. Among tube fed patients, Vitamin A attained 115% of the recommended intake and Vitamin D levels were at 64% of recommended intake.

Conclusions: In this study, enteral feeding is able to achieve the percentage of recommended intake on certain micronutrients which included sodium, zinc, selenium, Vitamin C, Vitamin A, Vitamin B1, Vitamin B6 and Vitamin B12. However, low intake levels of certain micronutrients were also documented which included potassium, magnesium, phosphorus and Vitamin D which may signify need for proper supplementation.

Topic: Metabolism, endocrinology, liver failure and nutrition

001043

Machine learning based early identification of patients at risk of respiratory failure

W. Y. Chung¹, J. E. Park², Y. J. Jung², C. Han³, D. Yoon³

¹pulmonology, Ajou University, Suwon-si, Republic of Korea;

²Pulmonology, Ajou University, Suwon-si, Republic of Korea; ³Department of biomedical systems informatics, Yonsei University College of Medicine, Yongin-si, Republic of Korea

Correspondence: W. Y. Chung

Intensive Care Medicine Experimental 2023, **11(Suppl 1)**:001043

Introduction: Acute respiratory failure (ARF) is associated high mortality. Early identification of patients at risk for developing respiratory failure could give the clinician opportunity to conceive strategies for preventions. We developed machine learning models mainly using biosignals to predict the development of respiratory failure in patients visiting emergency department (ED).

Methods: We collected biosignals and clinical data of patients after admission to the ED for four hours, excluding those already receiving mechanical ventilation support within collection time.

We built our ML model based on convolutional recurrent neural networks (CRNN) which integrate feature extraction from continuous biosignals and sequence modeling (Fig. 1).

Results: A total of 4068 patients' data and biosignals were analyzed and ARF occurred in 1078 patients (mean age: 67.34 years old; 59.4% male patients).

Our ML models performed well in predicting ARF with an area under receiver operating curve (AUROC) up to 0.818~0.840, area under the precision-recall curve (AUPRC) up to 0.470~0.560, sensitivity up to 0.728~0.769, PPV up to 0.315~0.415 while maintaining high NPV of 0.923~0.954 in the best performing model.

Conclusions: we created a highly predictive AI model for ARF that occurs within 4 to 72 h in patients without ARF within 4 h of hospitalization using only biological signals and initial clinical data (age, gender, consciousness, and body temperature).

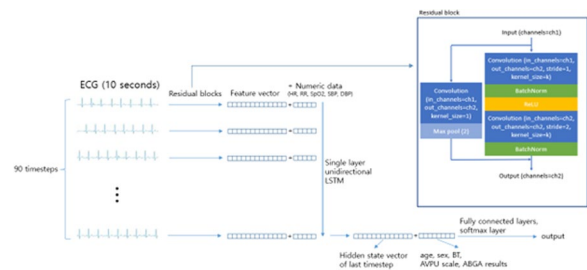

Figure 1 (abstract 001043) Architecture of the AI model. The AI model architecture was based on convolutional recurrent neural networks (CRNN), which integrate feature extraction from the ECG (convolutional neural network [CNN] part) and sequence modeling (recurrent neural network [RNN] part). AI: artificial intelligence. ECG: electrocardiogram. HR: heart rate. RR: respiratory rate. SBP: systolic blood pressure. DBP: diastolic blood pressure. LSTM: long short term memory. BT: body temperature. AVPU: alert, verbal responsive, pain responsive, unresponsive. ABGA: arterial blood gas analysis

Topic: Data Science

001044

Factors associated with positive response to prone positioning in intubated patient with COVID-19 induced ARDS

L. Jelinski¹, M. Combet¹, C. Lai¹, F. Lardet¹, R. Shi¹, F. Moretto¹, A. Pavot¹, Q. Fossé¹, T. Gobe¹, N. Fage¹, G. Roger¹, L. Guerin¹, J. L. Teboul¹, X. Monnet¹, T. Pham¹

¹AP-HP, Service de médecine intensive-réanimation, Hôpital de Bicêtre, Université Paris-Saclay, DMU CORREVE, Inserm UMR S_999, FHU SEPSIS, Groupe de Recherche Clinique CARMAS, Le Kremlin-Bicêtre, France

Correspondence: T. Pham

Intensive Care Medicine Experimental 2023, **11(Suppl 1)**:001044

Introduction: Prone positioning was shown to decrease mortality in patients with the most hypoxemic forms acute respiratory distress syndrome (ARDS) [1]. The factors associated with gas exchange improvement during prone position are currently not well identified.

Objectives: Our main objective was to determine variables associated with positive response to prone positioning. We also wanted to identify impact of the response to the first proning session on the patients' ICU survival.

Methods: This single-center observational study was performed in the medical ICU of Kremlin-Bicêtre Academic hospital between March 2020 and May 2021. Patients receiving mechanical ventilation for COVID-19 induced ARDS (C-ARDS) who underwent at least one session of prone position with respiratory mechanics measurement and arterial blood gas drawn before and at the end of sessions were included. We considered patients to be positive prone responders if they

fulfilled at least one of the following criteria: a PaO₂ to FiO₂ (PF) ratio increase ≥ 20 mmHg; a PF ratio increase $\geq 20\%$; and/or a decrease in PaCO₂ ≥ 5 mmHg. To take into account repeated measurement (most patients had several sessions), we performed a mixed effect level logistic regression to determine covariables associated with our outcome of interest. This two-level random intercept binary logistic regression comprised session related covariates and patients related covariates. We also performed a single level logistic regression including demographic, variables and first prone position characteristics to identify factors associated with ICU survival.

Results: During the inclusion period, 145 intubated patients with C-ARDS underwent at least 1 session of prone positioning in our ICU. Among them, 121 patients were included in this analysis, aged [mean (\pm SD)] 63 (\pm 12), with a BMI of 29.6 (\pm 5.6) kg/m², admission SAPS-2 of 39.0 (\pm 14.2) and median [IQR] SOFA of 4 [3;6]. Most of them (76.9%) presented at least one comorbidity, mainly hypertension (47.1%), obesity (38.0%) diabetes (28.1%) and/or chronic kidney disease (15.7%). First proning session occurred at day 1 [1;3] after intubation.

These patients underwent a total of 628 sessions of proning and we analyzed the results of the 551 prone sessions with available data (87.8%). Most sessions (71.5%) led to a positive response. In the multivariable analysis, adjusting on age, sex, frailty, presence of chronic obstructive pulmonary disease (COPD), body mass index (BMI), delay from intubation to the session of proning, pre-proning arterial partial pressure of CO₂ and pre-proning static airway compliance, only a lower PF ratio (OR = 0.82 [0.75;0.89] for 10 mmHg) and a lower SAPS-2 at admission (OR = 0.75 [0.57;0.99] for 10 points) were associated to a positive response to prone positioning (Figure 1).

ICU survival at day 28 was 40.5%. After adjustment on age, SAPS-2, BMI, and change of driving pressure during the first proning session, we found that a only a PF ratio improvement was associated with a better survival (OR = 1.07 [1.01;1.13] for 10 mmHg).

Conclusions: In this single center study including patients with COVID-19 related ARDS treated with prone position, patients with most severe hypoxemia before prone positioning and those with lower admission severity seem to benefit the most from this technique with greater improvement of gas exchange. The amplitude of the response in terms of oxygenation to the first session of proning seems to be associated with better survival and should be investigated in further studies.

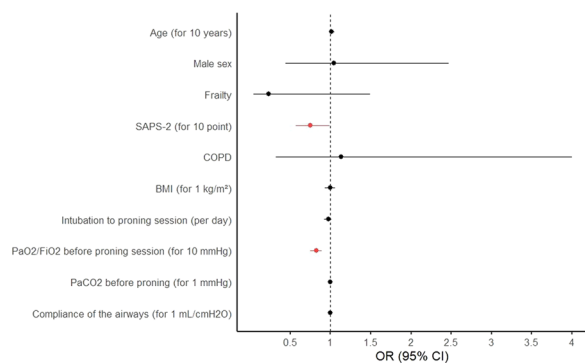

Figure 1 (abstract 001044) Odds ratio (95% CI) of association with positive response to prone positioning in a multi-level multivariable analysis. SAPS-2, simplified acute physiology score 2; COPD, chronic obstructive pulmonary disease, BMI, body mass index

References

- [1] Guérin C, Reignier J, Richard JC, Beuret P, Gacouin A, Boulain T, et al. Prone positioning in severe acute respiratory distress syndrome. *N Engl J Med*. 2013 Jun 6;368(23):2159–68

Topic: Acute respiratory failure and mechanical ventilation

001046

Perioperative outcome prediction using cardiopulmonary exercise testing (CPET) and machine learning (ML)

P. Arina¹, M. R. Kaczorek², E. B. Mazomenos², J. Whittle³, M. Singer¹
¹Bloomsbury institute of intensive care medicine, University College London, London, United Kingdom; ²Wellcome/EPSCRC Centre of Interventional and Surgical Sciences and Department of Medical Physics, UCL Main Campus, London, United Kingdom; ³Human Physiology and Performance Laboratory, Centre for Perioperative Medicine, University College London, London, United Kingdom

Correspondence: P. Arina

Intensive Care Medicine Experimental 2023, **11(Suppl 1)**:001046

Introduction: Approximately 16% of patients experience serious complications following surgery¹. Preoperative cardiopulmonary exercise testing (CPET) can identify patients at higher risk of complications². Machine Learning (ML) algorithms have the potential to improve the predictive accuracy of CPET and develop useful clinical tools.

Objectives: To design a machine learning-based clinical tool that combines patient data with CPET data to improve prediction of adverse outcomes after major surgery.

Methods: A single-centre database of 1190 patients who underwent a diverse range of surgery over 10 years at University College Hospitals NHS Trust, London, UK was analysed. Outcomes examined included a postoperative morbidity survey (POMS) and 1 year mortality. The Physiological and Operative Severity Score for the enumeration of Mortality and morbidity (P-POSSUM) was used as a comparator risk model. Using Python, data were processed for feature selection. Preliminary data analysis used linear regression and clustering to examine the relationship between features and outcomes. We then developed and evaluated four machine learning models—logistic regression (LR), support vector classifier (SVM), k-nearest neighbours classifier (KNN), and neural network (NN)—for their performance in a classification task.

Results: Cumulative POMS scores for patients on postoperative day 3 revealed a correlation between oxygen consumption at aerobic threshold and cumulative POMS score (r^2 : 0.68, p :0.001). Feature ranking analysis identified CPET-derived features as the most important. Machine learning models demonstrated superior performance to P-POSSUM in classifying patients at day 3 with the neural network performing the best (AUC: 0.944, Accuracy: 0.866, Sensitivity: 0.853, Specificity: 0.842, F1-Score: 0.862). For 1-year mortality (6%), all models outperformed P-POSSUM, with the SVM model performing the best (AUC: 0.817, Accuracy: 0.782, Sensitivity: 0.688, Specificity: 0.788, F1-Score: 0.294). All models had low sensitivity for mortality, indicating a high number of false positives.

Conclusions: Using preoperative CPET, we created a ML-based tool that could predict, with high discrimination, surgical patients at risk of morbidity. While predictions of mortality were superior to those made using P-POSSUM, the models were affected by low discrimination regarding true and false positives. To improve these results, we will investigate CPET time series with ML models and deep learning.

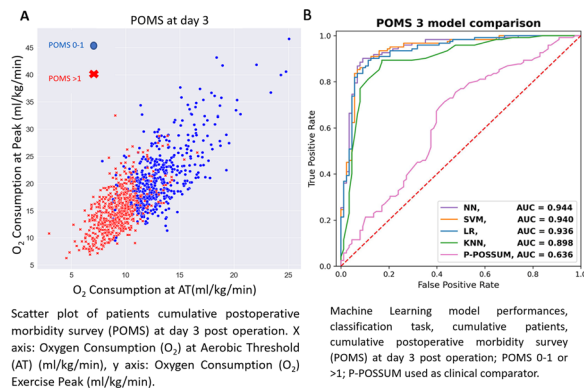

References

- (2) Levett DZH et al. *BJA* 2018; 120: 484–500
- (1) Dencker EE et al. *BMC Surg* 2021; 21, 1–10; (2)
- This research received no specific grant from any funding agency in the public, commercial, or not-for-profit sectors. All authors collaborated in project creation, data collection, analysis and interpretation. Ethical approval was obtained with the codes IRAS 12/LO/0192 and 19/LO/1371.

Topic: Perioperative care

001047

A retrospective analysis of life-threatening complications of maxillofacial space infection in a tertiary care hospital

M. García Marín¹, M. Gascón Castillo¹, M. Fernández Caro¹, T. Villalobos Herrera¹

¹Medicina Intensiva, Virgen del Rocío University Hospital, Sevilla, Spain

Correspondence: M. García Marín

Intensive Care Medicine Experimental 2023, **11**(Suppl 1):001047

Introduction: Infections of the maxillofacial space, with extension to deep tissues, are a significant cause of morbidity and mortality in previously healthy patients, frequently requiring admission to intensive care, according to the potential development of serious complications that can be life-threatening. We present a case report of patients admitted to a tertiary ICU for this pathology.

Methods: We reviewed the medical record of 65 patients with a diagnosis of maxillofacial space infection requiring admission to Intensive Critical Unit at Virgen del Rocío Hospital (Sevilla, Spain), from January 2019 to January 2023. Age, personal history, need for surgical intervention and reintervention are collected, as well as the characteristics of the antibiotic treatment used, microbiological isolates and mortality. The SOFA and APACHE II scores were obtained within the first 24 h after admission.

Results: 65 patients were included in the study, all of them requiring urgent surgery within the first 24 h of admission to the ICU.

Among our patients, the mean age was 47 years (17–77), with a mean ICU stay of 10 days, with a wide range (1–79). 23% of patients were treated with prior prolonged antibiotic therapy, understood as >7 days of broad-spectrum antibiotic.

Twenty-eight percent were admitted in a situation of septic shock, with a relatively low SOFA in the first 24 h of admission (average SOFA of 2), APACHE-II at 24 h on average of 8. 25% required more than 1 surgical intervention for adequate focus control.

Initial empirical treatment was performed with ceftriaxone + clindamycin in 83%, based on local antimicrobial therapy guidelines, with 34.6% of patients requiring antibiotic escalation at some point during admission. Intraoperative cultures were taken in 98% of patients, microbiological isolation was obtained in 63.5% of these. The isolates were usually polymicrobial (81.3%), 69% of these also included

anaerobic microorganisms. Mean antibiotic treatment was 27 days, performing de-escalation or sequential treatment at discharge during this period in 89% of patients. Only 6 patients had complications with associated thrombophlebitis, and 3 of them with mediastinitis. 3 patients died during their hospital admission.

Conclusions: Infections of the maxillofacial area are a relevant disease, with potentially fatal complications, and frequently affects young patients with low comorbidity, commonly requiring several surgical interventions during admission, who probably benefit from multidisciplinary management, as well as management specific in an intensive care unit. An antimicrobial policy based on the local flora is necessary, as well as established protocols for optimal management of our patients.

References

- Cabral M, Kapasi FT, Ameerally P. Management of oral and maxillofacial infections in a regional unit: a seven day service? *British Journal of Oral and Maxillofacial Surgery*. 2018 Jul 1;56(6):501–4.
- Taub D, Yampolsky A, Diecidue R, Gold L. Controversies in the Management of Oral and Maxillofacial Infections. *Oral Maxillofac Surg Clin North Am*. 2017 Nov 1;29(4):465–73.
- Han X, An J, Zhang Y, Gong X, He Y. Risk Factors for Life-Threatening Complications of Maxillofacial Space Infection. *J Craniofac Surg*. 2016;27(2).
- Neal TW, Schlieve T. Complications of Severe Odontogenic Infections: A Review. *Biology* 2022, Vol 11, Page 1784 [Internet]. 2022 Dec 8 [cited 2023 Apr 15];11(12):1784. Available from: <https://www.mdpi.com/2079-7737/11/12/1784/htm>
- Bali RK, Sharma P, Gaba S, Kaur A, Ghanghas P. A review of complications of odontogenic infections. *Natl J Maxillofac Surg* [Internet]. 2015 [cited 2023 Apr 15];6(2):136. Available from: [/pmc/articles/PMC4922222/](https://www.ncbi.nlm.nih.gov/pmc/articles/PMC4922222/)

Topic: Sepsis

001048

Comparison of nursing workload tools and relation to severity of illness and outcome in a Pediatric ICU

G. Sinani¹, G. Briassoulis¹, A. S. Nieri², E. Asimina³, E. Akoumianaki⁴, S. Ili¹

¹Postgraduate Program "Emergency and Intensive Care in Children, Adolescents, and Young Adults", School of Medicine, University of Crete, Heraklion, Greece; ²Department of Nursing, National and Kapodistrian University of Athens, Athens, Greece; ³Pediatric Intensive Care Unit, University General Hospital of Heraklion, Heraklion, Greece; ⁴Intensive Care Unit, School of Medicine, University of Crete, Heraklion, Greece

Correspondence: S. Ili

Intensive Care Medicine Experimental 2023, **11**(Suppl 1):001048

Introduction: The increased time required to care for ICU children translates into a nursing workload (NW) and is greater than in other nursing departments. Nursing workload can affect both the quality of care provided and patient safety. The use of tools to assess the nursing workload that can contribute to the proper utilization of logistical and human resources expressed by the ratio of patients per nurse in pediatric ICUs is important. Correlating nursing workload with severity and risk scales of pediatric ICU patients is also important because they are particularly susceptible to experiencing adverse events when NW is high.

Objectives: The present study aims to measure and quantify the burden of nursing workload (NW) with reliable scales, to compare them, and to correlate NW with indicators of clinical severity and outcome of pediatric patients hospitalized in an academic PICU and in the calculation of optimal staffing.

Methods: This is a prospective cohort study conducted in the Pediatric ICU (PICU), University Hospital of Heraklion, Greece. Children aged 1 month to 18 years, who were hospitalized between June and December 2021 were eligible. The pediatric scales NAS (Nursing Activities Score), TISS-28 (Therapeutic Intervention Scoring System 28) and NEMS (Nine Equivalents of nursing Manpower use Score) were used to measure the nursing workload. Clinical severity scales were Glasgow Pediatric Scale, pediatric logistic organ dysfunction (PELOD-2) the Pediatric Mortality Index III (PIM III) and PRISM III/IV. Optimal nurse

staffing was measured in hours per patient per day needed (NAS score of 100 equals to one registered nurse per 8-h shift).

Results: In the total population studied (N=106), 60% were boys, median age was 3.7 (0.7–11.8) years, emergency admissions were 69.1%, median length of stay was 5 (3–16) days, comorbidities were found in 41.8%, clinical severity (PELOD-2) scale showed that the risk of death was 4.91% and crude mortality was 7.3%. Mean NAS score was 76.75 (± 15.18) corresponding to a mean provided nursing care time of 1105.27 (± 218.64) minutes, TISS-28 score was 26.78 (± 6.84) that is 851.67 (± 217.61) minutes, and NEMS was 27.41 (± 7.01) minutes, equivalent to 871.66 (± 222.76) minutes. TISS-28 scale was found to have a moderate positive statistically significant linear correlation with the NAS scale ($r=0.543$, $p<0.001$) and a strong positive correlation with the NEMS scale ($r=0.764$). The Bland–Altman concordance test showed that 5.4% of the total recordings differed from the upper and lower limits of agreement of the P-NAS and TISS-28 scales. Patients admitted to PICU from the Emergency Department had a significantly higher daily NAS nursing workload compared to patients admitted from the Operating Room [76.64 (± 10.29) vs. 67.82 (± 10.67), $p=0.003$]. NAS nursing workload was found to have a positive linear statistically significant correlation with the length of stay of patients in PICU ($r=0.562$, $p<0.001$), that is, patients with a higher NAS score tended to have a longer length of stay. The discriminative ability of the severity and outcome prognostic scale scores and nursing workload scales between patients who survived and those who died was high (AUC 0.929, 95% CI 0.849–1.0, $p<0.001$) (Fig. 1). According to NAS scale, shortage of registered nurse staffing were identified in all rotation shifts; morning shift -0.70 (± 0.99) nurses, evening shift -0.84 (± 0.95), and night shift -0.85 (± 0.94) (all $p<0.001$).

Conclusions: NAS, TISS-28 and NEMS proved to be reliable and valid tools in pediatric ICUs. The NAS scale is superior to others in assessing nursing workload. The discriminative ability of the severity and outcome prognostic scale scores and nursing workload scales between patients who survived and those who died was high. Additionally, NW scales demonstrated that optimal nurse staffing in the PICU requires additional nurses.

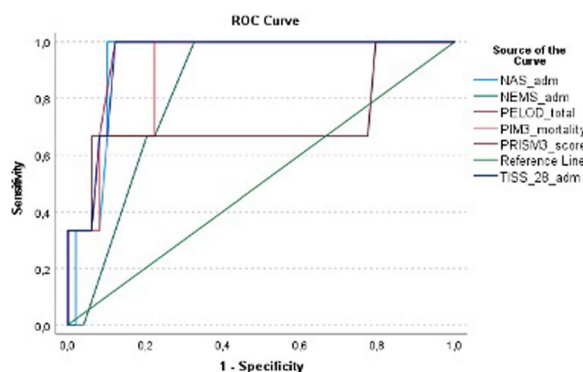

Fig. 1 (abstract 001048) ROC analysis. Discriminative ability of Nursing Workload Tools of clinical severity and outcome in critically ill children

References

- Nieri AS, Manousaki K, Kalafati M, Padilha KG, et al. Validation of the nursing workload scoring systems "Nursing Activities Score" (NAS), and "Therapeutic Intervention Scoring System for Critically Ill Children" (TISS-C) in a Greek Paediatric Intensive Care Unit. *Intensive Crit Care Nurs*. 2018 Oct;48:3–9. doi: <https://doi.org/10.1016/j.iccn.2018.03.005>

Topic: Critical care organisation, quality management, information systems, outcomes

001049

Risk factors and impact on long-term outcomes of early systemic insults after TBI. A CENTER-TBI study

G. Pastore¹, F. Graziano¹, C. Robba², M. Sivero¹, F. Mulazzani¹, B. Noè¹, M. Consonni³, E. Colombo⁴, M. G. Abate⁴, D. Savo⁴, C. Quaranta⁴, G. Citerio¹
¹School of Medicine and Surgery, University of Milano-Bicocca, Milano, Italy; ²Department of Anesthesia and Intensive Care, University of Genoa, Genova, Italy; ³School of Medicine and Surgery, Vita-Salute San Raffaele University, Milano, Italy; ⁴Neurointensive Care Unit, San Gerardo Hospital, ASST-Monza, Monza, Italy

Correspondence: G. Pastore

Intensive Care Medicine Experimental 2023, **11(Suppl 1)**:001049

Introduction: Traumatic Brain Injury (TBI) outcomes are determined by the severity of the primary injury and secondary injuries (SIs) – such as hypoxia and hypotension [1–2]. SIs can boost the initial damage and ultimately worsen long-term disability and mortality [3–4].

Objectives: This study explores the incidence of early SIs and their association with derangements in metabolic profile, the higher therapeutic burden in the acute phase, six-month mortality, and neurological outcome.

Methods: This is an observational analysis of adult TBI patients admitted to the Intensive Care Unit enrolled in the CENTER-TBI study [5]. To detect the occurrence of early SIs, we examined data recorded in the prehospital setting and at hospital arrival. A hypotensive episode was defined as a measured systolic blood pressure (SBP) <90 mmHg or a clinical definition of shock. A hypoxic episode was described as an estimated arterial partial pressure of oxygen (PaO₂) <60 mmHg and/or peripheral oxygen saturation (SpO₂) <90% or as evidenced by cyanosis, apnea, or respiratory distress.

According to the occurrence of secondary insults, patients were allocated into four different groups: "Hypoxia", "Hypotension", "Both" and "None". For each group, we evaluated: demographics, TBI mechanism, Glasgow Coma Scale at admission, Marshall CT score, strategy for intracranial pressure management, presence of extracranial injuries, need for neurosurgery and extracranial surgery (e.g., damage control interventions), need for mechanical ventilation (and eventually tracheotomy), rate of blood transfusions, biochemical profile. Comparison between the characteristics of the groups was conducted by chi-squared or Wilcoxon rank sum test – depending on the nature of the variables.

Glasgow Outcome Scale – Extended (GOSE) was used to determine 6-month neurological outcome and mortality; any value ≤ 4 was considered as an "unfavorable outcome".

Results: Among the study population ($n=1,695$ patients), a hypoxic event was reported in 158 (9.3%) patients, a hypotensive event in 142 (8.4%), and both hypoxia and hypotension in 115 (6.8%).

Both SIs were associated with the most deranged biochemical profile and the highest rate of extracranial injury. Hypotension alone or combined with hypoxemia was independently associated with the need for extracranial surgery and unfavorable neurological outcome (Figure 1). Ultimately, a higher 6-month mortality was observed among patients suffering from both SIs.

Conclusions: The incidence of early SIs was lower compared to previous studies [6–7]. However, SIs still represent an important factor contributing to patient's outcomes. Thus, prompt recognition of SIs and their risk factors can be pivotal in early and ICU clinical management.

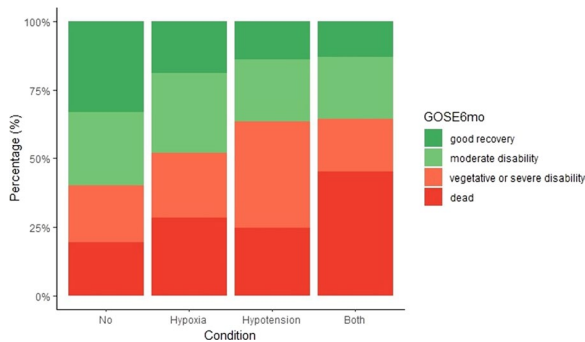

Figure 1 (abstract 001049) Outcome distribution in patients with and without SIs. GOSE6mo: Glasgow Outcome Scale—Extended at 6 months from TBI. GOSE 1: dead (red). GOSE 2–4: vegetative state or severe disability (orange). GOSE 5–6: moderate disability (light green). GOSE 7–8: good recovery (dark green)

References

- Lazaridis C, Rusin CG, Robertson CS. Secondary brain injury: Predicting and preventing insults. *Neuropharmacology*. 2019;145(Pt B):145–152. doi: <https://doi.org/10.1016/j.neuropharm.2018.06.005>
- Maas AIR, Marmarou A, Murray GD, Teasdale SGM, Steyerberg EW. Prognosis and clinical trial design in traumatic brain injury: the IMPACT study. *J Neurotrauma*. 2007;24(2):232–238. doi: <https://doi.org/10.1089/neu.2006.0024>
- Chesnut RM, Marshall LF, Klauber MR, et al. The role of secondary brain injury in determining outcome from severe head injury. *J Trauma*. 1993;34(2):216–222. doi: <https://doi.org/10.1097/00005373-199302000-00006>
- McHugh GS, Engel DC, Butcher I, et al. Prognostic value of secondary insults in traumatic brain injury: results from the IMPACT study. *J Neurotrauma*. 2007;24(2):287–293. doi: <https://doi.org/10.1089/neu.2006.0031>
- Maas AIR, Menon DK, Steyerberg EW, et al. Collaborative European NeuroTrauma Effectiveness Research in Traumatic Brain Injury (CENTER-TBI): a prospective longitudinal observational study. *Neurosurgery*. 2015;76(1):67–80. doi: <https://doi.org/10.1227/NEU.0000000000000575>
- Gravesteyn BY, Sewall CA, Stocchetti N, et al. Prehospital Management of Traumatic Brain Injury across Europe: A CENTER-TBI Study. *Prehospital Emerg care*. 2021;25(5):629–643. doi: <https://doi.org/10.1080/10903127.2020.1817210>
- Volpi PC, Robba C, Rota M, Vargiolu A, Citerio G. Trajectories of early secondary insults correlate to outcomes of traumatic brain injury: results from a large, single centre, observational study. *BMC Emerg Med*. 2018;18(1):52. doi: <https://doi.org/10.1186/s12873-018-0197-y>

Topic: Neurointensive care

001050

A novel extracorporeal carbon dioxide removal technique with regional citrate-based anticoagulation: an experimental model

C. Valsecchi¹, M. Battistin², L. Vivona², V. Vago², V. Botti², A. Rosati², S. M. Colombo¹, G. Florio¹, M. Di Feliciano², D. Dondossola³, A. Pesenti¹, G. Grasselli², A. Zanella²

¹Department of Anesthesia, Critical Care and Emergency, IRCCS Cà Granda Foundation Ospedale Maggiore Policlinico, Milano, Italy; ²Department of Pathophysiology And Transplantation, University of Milan, Milano, Italy; ³Liver Transplant and General Surgery Unit, Fondazione IRCCS Cà Granda Ospedale Maggiore Policlinico, Milano, Italy

Correspondence: S.M. Colombo

Intensive Care Medicine Experimental 2023, **11(Suppl 1)**:001050

Introduction: Extracorporeal carbon dioxide removal (ECCO2R) allows protective ventilation in patients with acute respiratory failure (1, 2), but requires systemic anticoagulation with subsequent increased risk of hemorrhage, especially with low blood flows (3). In clinical setting, citrate represents the most widespread molecule used for regional anticoagulation (RA); however, because of limited clearance, citrate can only be applied to extracorporeal blood flows lower than the ones required for ECCO2R. New techniques have been proposed to overcome these limitations (4).

Objectives: This study aims to evaluate feasibility, safety, and efficacy of a new extracorporeal technique that combines a low flow ECCO2R and continuous renal replacement therapy (CRRT) using a RA with citrate and a novel system for citrate removal.

Methods: Six healthy swine (39 ± 7 kg) were mechanically ventilated and connected to a low-flow (0.35 L/min) custom-made venous-venous extracorporeal circuit for ECCO2R and CRRT which includes anionic ion-exchange resins charged with chloride for citrate removal, and cationic resins charged with sodium for calcium removal. Hydro-electrolytic balance was achieved through ultrafiltration (1000 ml/h) and three different anionic ion-exchange resins (100% bicarbonate (HCO₃⁻); 100% hydroxide (OH⁻); 60% HCO₃⁻ and 40% OH⁻) tested in a randomized 1-h steps. A 0.2 M solution of sodium citrate (66%) and citric acid (34%) was continuously infused at the circuit inlet (4 mmol/L). Plasma citrate and free calcium concentrations were measured on arterial blood, and on extracorporeal blood inlet (downstream of citrate infusion) and outlet. Minute ventilation (MV) was changed to maintain a constant arterial pressure of carbon dioxide (50 ± 2 mmHg). Samples were collected at the end of each step for blood gas, electrolytes, and citrate dosage. Data were also collected at baseline before connection to the extracorporeal circuit.

Results: During ECCO2R, MV decreased from 7.27 ± 1.31 l/min to 3.4 ± 0.70 l/min, and it remained stable during 60%HCO₃⁻/40%OH⁻ (3.05 ± 0.64 l/min, *p* 0.68), further decreased during 100% OH⁻ step (1.86 ± 1.04 l/min, *p* < 0.01), and slightly increased during 100% HCO₃⁻ (4.23 ± 0.91 l/min, *p* 0.04, Figure 1). During citrate infusion, regional free calcium concentrations remained below the RA threshold, while citrate concentration, downstream the infusion port, was 5.51 ± 0.68 mmol/L and decreased after the citrate-removal system (Table *). At the end of the study, the arterial total calcium/ionized calcium ratio was 1.99 ± 0.25. Minimal changes occurred in arterial pH and sodium concentration, but not in chloride concentration. The blood outlet pH during OH⁻ step was significantly higher compared to all the others.

		Baseline	ECCO2R	100%HCO ₃ ⁻	60%HCO ₃ ⁻ - 40%OH ⁻	100%OH ⁻	<i>p</i>
ARTERY	Ca ⁺⁺ (mmol/l)	1.44 ± 0.07	1.30 ± 0.08	1.32 ± 0.08	1.28 ± 0.07	1.27 ± 0.07	< 0.01
	Citrate (mmol/l)	0.05 ± 0.03	/	0.60 ± 0.21	0.64 ± 0.14	0.73 ± 0.17	< 0.01
	pH	7.41 ± 0.02	7.42 ± 0.02	7.45 ± 0.03	7.44 ± 0.02	7.43 ± 0.03	< 0.01
	Na ⁺ (mmol/l)	136.3 ± 2.5	137.7 ± 2.6	138.8 ± 2.0	139.5 ± 1.6	138.7 ± 1.6	< 0.01
INLET	Ca ⁺⁺ (mmol/l) /		1.32 ± 0.08	0.35 ± 0.03	0.33 ± 0.14	0.33 ± 0.10	< 0.01
	pH /		7.39 ± 0.01	7.08 ± 0.03	7.05 ± 0.11	7.04 ± 0.09	< 0.01
OUTLET	Ca ⁺⁺ (mmol/l) /		1.00 ± 0.05	0.25 ± 0.03	0.20 ± 0.02	0.21 ± 0.03*	< 0.01
	Citrate (mmol/l) /		/	1.13 ± 0.13	1.17 ± 0.24	1.32 ± 0.30	0.05
	pH /		7.84 ± 0.04	7.71 ± 0.05	7.88 ± 0.06	8.14 ± 0.11	< 0.01

Conclusions: Combining ECCO2R with blood flow of 0.35 l/min and CRRT with citrate regional anticoagulation and a novel ion exchange resin-based system for citrate removal was feasible. System for citrate removal based on ion exchange resins was feasible and enabled a reduction in MV. The OH⁻ anion exchange resulted in the most significant reduction in MV, albeit with the lowest safety profile.

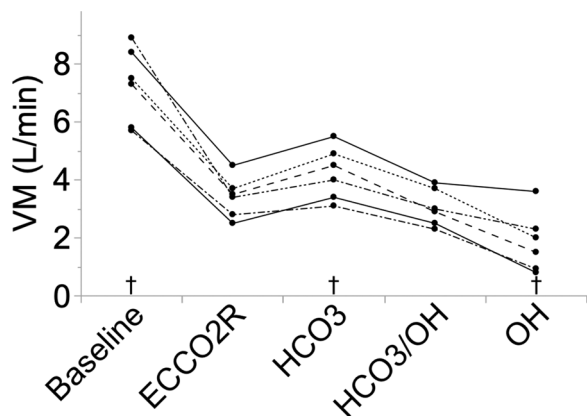

Figure 1 (abstract 001050) Minute Ventilation (VM) of each swine before extracorporeal CO₂ removal initiation (“Baseline”), during standard extracorporeal CO₂ removal run (“ECCO2R”), and after novel citrate removal system initiation. For citrate removal, anions have been exchanged with only bicarbonate (100% bicarbonate, “HCO₃⁻”), with a solution of bicarbonate/hydroxide 60%/40% respectively (60%/40% bicarbonate/hydroxide, “HCO₃⁻/OH⁻”), and with only hydroxide (100% hydroxide, “OH⁻”). Linear mixed model fit by maximum likelihood. †=P<0.05 in the post hoc analysis (Tuckey’s range test) vs ECCO2R step

References

1. Terragni PP, Sorbo L Del, Mascia L, Urbino R, Martin EL, Birocco A, Fagiano C, Quintel M, Gattinoni L, Ranieri VM. CRITICAL CARE MEDICINE Tidal Volume Lower than 6 ml/kg Enhances Lung Protection Role of Extracorporeal Carbon Dioxide Removal. 2009;at <<http://pubs.asahq.org/anesthesiology/article-pdf/111/4/826/248574/0000542-200910000-00026.pdf>>.
2. S. Crotti, A. Lissoni, D. Tubiolo, S. Azzari, P. Tarsia, L. Caspani, L. Gattinoni. Artificial lung as an alternative to mechanical ventilation in COPD exacerbation. Eur Respir J 2012;212–215.at <<https://erj.ersjournals.com/content/erj/39/1/212.full.pdf>>.
3. McNamee JJ, Gillies MA, Barrett NA, Perkins GD, Tunnicliffe W, Young D, Bentley A, Harrison DA, Brodie D, Boyle AJ, Millar JE, Szakmany T, Bannard-Smith J, Tully RP, Agus A, McDowell C, Jackson C, McAuley DF, Investigators R, Adedoyin T, Adeniji K, Aherne C, Iyer GA, Andreou P, Andrew G, Angus I, Arbane G, Austin P, Austin K, et al. Effect of Lower Tidal Volume Ventilation Facilitated by Extracorporeal Carbon Dioxide Removal vs Standard Care Ventilation on 90-Day Mortality in Patients With Acute Hypoxemic Respiratory Failure: The REST Randomized Clinical Trial. JAMA 2021;326:1013–1023.
4. **4. Zanella A, Vivona L, Galli A, Battistin M, Biancolilli O, Dondosola D, Colombo S, Anzanello C, Protti I, Busana M, Pesenti A. A novel technique to increase extracorporeal citrate clearance to achieve regional anticoagulation of high blood flows. Intensive Care Med Exp 2019;7(Suppl3):280–281.

Topic: Translational Medicine

001051

Impact of robot-assisted early mobilization of critically ill patients on proinflammatory cytokines compared with standard of care

N. Langer¹, N. Daum², B. Annika³, M. Lorenz⁴, S. J. Schaller⁵
¹Department for Anesthesiology, Charité Universitätsmedizin Berlin, Berlin, France; ²Department of Anesthesiology and Operative Intensive Care Medicine (CVK, CCM), Charité – Universitätsmedizin Berlin, Berlin, Germany; ³Department for Anesthesiology, Charité – Universitätsmedizin Berlin, Berlin, Germany; ⁴Anesthesiology and operative intensive care medicine, Charité – Universitätsmedizin Berlin, Berlin, Germany;

⁵Department of anesthesiology and surgical intensive care, Charité – Universitätsmedizin Berlin, Berlin, Germany

Correspondence: N. Langer

Intensive Care Medicine Experimental 2023, 11(Suppl 1):001051

Introduction: The consequences of intensive care unit acquired weakness (ICUAW) are a major long-term problem of surviving critically ill patients. Inflammation and therefore proinflammatory cytokines may contribute to muscular changes in the critically ill [1]. To counteract these perturbations, mobilization (e.g., passive mobilization by in-bed cycle ergometry) seems to be promising [2]. Currently, there are no studies on the kinetics of proinflammatory cytokines induced by robotic mobilisation compared to standard treatment.

Objectives: The primary aim of this randomized controlled feasibility study was to investigate the influence of robot-assisted early mobilization compared to standard care. Here we present the analysis of the secondary objective concerning the influence of mobilisation by robotics on proinflammatory cytokines.

Methods: For the feasibility study 20 invasive mechanically ventilated critically ill patients (age > 18 years, invasive ventilation, and planned intensive care stay of more than 24 h) were randomized 1:1 into intervention and control group.

The intervention group received five days of early mobilization twice daily for at least 20 min using the Vemotion® system (Reactive Robotics GmbH, Munich, Germany), which enables mobilization in the own bed and verticalization up to 90 degrees during mobilization. The control group received standard of care without robotic support.

For the cytokine analysis, a blood sample was taken immediately before and after mobilization of the first day. We measured IL 6, IL 8, TNF alpha using LUNARIS™ Reader 96/384 (Ayoxxa Biosystems, USA). We analysed the cytokine change within each group using the Wilcoxon-cox test, and the group difference using the Mann-Whitney-U test. The significance level was set at 0.05. The statistical analysis was performed in SPSS 27 (IBM, USA).

Results: A total of 21 were randomized, with 1 patient withdrew his consent, i.e., 20 patients were analysed. The patients were 65 [IQR 53–78.75] years old, 1.77 [1.65–1.80] cm high, weighed 80 [60.88–84.25] kg, with a Charlson Comorbidity Index of 4.0 [1.3–5.0], an APACHE II score of 27 [21–35] and a SOFA score of 10 [8–11]. There was a trend of reduction of all cytokines compared to a trend towards increase in the control group without significance. Between groups there was a significant difference in the IL-6 level change and a positive trend in the TNF-alpha change (Figure 1).

Conclusions: The kinetics of proinflammatory cytokines during robot-assisted mobilization showed no change nor a signal of harm compared to standard care.

Figure 1. Dynamics of proinflammatory cytokines in the context of robot-assisted mobilization compared to the standard procedure.

Variable	Intervention* (n = 10)	Control* (n = 10)	p-value
Interleukin 6			
Pre-intervention	75.90 [37.38 – 136.48]	52.90 [28.35 – 194.73]	
Post-intervention	58.75 [23.13 – 120.55]	70.80 [27.13 – 179.90]	
Δ Post-Pre	-4.65 [-13.00 – 3.83]	3.70 [-1.30 – 28.88]	0.049
Interleukin 8			
Pre-intervention	15.85 [10.10 – 44.70]	15.50 [4.85 – 32.15]	
Post-intervention	13.30 [9.25 – 29.70]	19.15 [7.95 – 31.08]	
Δ Post-Pre	0.60 [-13.38 – 3.35]	0.50 [-4.05 – 4.13]	0.65
TNF-Alpha			
Pre-intervention	24.25 [20.18 – 31.00]	22.05 [15.43 – 35.18]	
Post-intervention	21.00 [15.60 – 29.85]	28.35 [7.88 – 34.43]	
Δ Post-Pre	-5.75 [-8.18 – 1.85]	1.65 [-3.52 – 5.70]	0.17

Figure 1 (abstract 001051) .

References

1. Witteveen E, Sommers J, Wieske L, Doorduyn J, van Alfen N, Schultz MJ, et al. Diagnostic accuracy of quantitative neuromuscular ultrasound for the diagnosis of intensive care unit-acquired weakness: a cross-sectional

observational study. *Ann Intensive Care*. 2017;7(1):40 doi: <https://doi.org/10.1186/s13613-017-0263-8>.

2. França EET, Gomes JPV, De Lira JMB, Amaral TCN, Vilaça AF, Paiva Júnior MDS, et al. Acute effect of passive cycle-ergometry and functional electrical stimulation on nitrosative stress and inflammatory cytokines in mechanically ventilated critically ill patients: a randomized controlled trial. *Braz J Med Biol Res*. 2020;53(4):e8770 doi: <https://doi.org/10.1590/1414-431x20208770>.

Topic: Nursing care and physiotherapy

001053

Combination of an AGTR1 rs275651 polymorphism and plasma angiotensin II level as a pathogenic binary candidate biomarker to predict outcome in sepsis

V. Pisarev¹, A. G. Chumachenko¹, A. V. Ilyichev¹, E. K. Grigoriev¹, A. V. Grechko¹

¹V.A. Negovsky Research Institute of General Reanimatology, Federal Research and Clinical Center of Intensive Care Medicine and Rehabilitology, Moscow, Russia

Correspondence: V. Pisarev

Intensive Care Medicine Experimental 2023, **11(Suppl 1)**:001053

Introduction: Dysregulation of blood pressure (BP) significantly impacts the course of a life-threatening septic shock. Octapeptide angiotensin II (AngII), the key player of the renin-angiotensin system, significantly contributes to vasoconstriction, sodium and water retention. These effects are mediated via two distinct types of AngII surface receptors, type 1 (AGTR1) and type 2 (AGTR2) [1]. In a caucasian population, single-nucleotide polymorphism of *AGTR1* gene T/A in promoter region (rs275651) associates with hypertension and increased promoter activity [2,3]. Recently we have shown that carriage of a minor allele A *AGTR1* rs275651 in sepsis patients with comorbidity is associated with septic shock development and increased lethality [4]. However, no studies were performed to clarify if polymorphism in Ang II receptor gene and plasma concentration of the receptor ligand, AngII, in combination may affect outcome of sepsis.

Objectives: Determine whether both AngII concentration in plasma and *AGTR1* polymorphism contribute to sepsis outcome in ICU patients.

Methods: Study cohort included 75 ICU patients diagnosed with sepsis (SEPSIS-3, 2016); 34 patients were diagnosed with type 2 diabetes (T2D), 28 patients had cardiovascular disorders (CVD). Sixty percent of patients had septic shock. The levels of AngII in plasma were determined on admission using enzyme-linked immunosorbent assay. Patient's DNA was isolated from the whole blood using organic solvents. Genetic polymorphism of *AGTR1* (rs275651) was studied using tetra primer PCR followed by gel electrophoresis. Means/SD, medians/odds ratios (OR), logrank test, Fisher exact test (FET)/Mann-Whitney U test were computed and employed to reveal group differences and their significance at $p < 0.05$.

Results: Plasma Ang II levels were significantly decreased in non-survived patients with sepsis compared to survived patients (Fig., A). However, the significant decrease was evident only in a group of patients with severe comorbidity (T2D and/or CVD). Since our recent study had demonstrated the significantly increased mortality in patients with comorbidity carrying the minor allele of Ang II receptor genetic variant, *AGTR1* rs275651 (Fig. B), here we evaluated the contribution of *AGTR1* genotype and Ang II levels in plasma to outcome of sepsis patients with and without severe comorbidity. First, we found that carriers with sepsis and genotype TT *AGTR1* rs275651 displayed significantly increased levels of Ang II (Fig., C). Second, in sepsis patients, angiotensin II amount in plasma over 200 pg/ml exhibited significant association with favorable outcome ($P = 0.0012$; FET, OR = 5.1, 95% CI: 1.9- 13.7, $n = 75$). Logrank test confirmed this evidence, however, a significant link between mortality and Ang II level was revealed only in the group with comorbidity whereas similar trend in patients with sepsis and no comorbidity (no T2D and/or CVD) was

not statistically significant (Fig., D). Finally, the association of enhanced survival in sepsis and increased level of AngII in plasma (> 200 ng/ml) was statistically significant only in a group of sepsis patients with the *AGTR1* TT genotype (Fig., E). Therefore, in homozygous sepsis patients (genotype TT), major allele T in a promoter region of *AGTR1* (rs275651) gene associated with the increased transcription of the gene [2,3], contributes to survival of those patients who exhibit increased AngII levels in circulation. We believe that in combination the *AGTR1* functional polymorphism and AngII level might represent valuable binary candidate biomarker to stratify sepsis patients with comorbidity for in-time personalized prevention or treatment of septic shock to improve survival. Further studies are needed to reveal if patients with sepsis, D2D and/or CVD, rs275651 TT *AGTR1* genotype and low Ang II may represent the targeted candidate cohort to deliver clinical benefit from treatment with AngII.

Conclusions: ICU patients with T2D and/or CVD comorbidity and homozygosity for rs275651 major allele T in *AGTR1* gene (genotype TT) are most resistant to adverse outcome of sepsis if plasma Ang II levels are high.

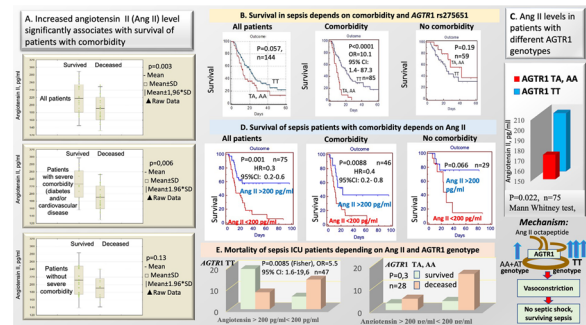

Figure (abstract 001053) Angiotensin II levels and *AGTR1* rs275651 polymorphism in sepsis patients

References

1. Mottl A.K., Shoham D.A., North K. E. Angiotensin II type 1 receptor polymorphisms and susceptibility to hypertension: a HuGE review. *Genet Med*. 2008 Aug;10(8):560–74. doi: <https://doi.org/10.1097/gim.0b013e3181809613>; 2. Kumar A, Prater A, Li Y, et al. A haplotype of the angiotensin-II receptor subtype-1 is associated with hypertension in caucasian women. *Circulation* 2005;111:E52. 3. Jain S., Prater A., Pandey V., Rana A., Puri N., Kumar A. A Haplotype of Angiotensin Receptor Type 1 Associated with Human Hypertension Increases Blood Pressure in Transgenic Mice *Journal of biological chemistry*. 2013; 288(52):37048–56. doi: <https://doi.org/10.1074/jbc.M113.520023>. 4. Chumachenko A.G., Grigoriev E.K., Pisarev V.M. Contribution of *AGTR1* Promoter Region Polymorphism to the Progression and Outcome of Sepsis in Patients with Various Comorbidities. *General Reanimatology*. 2021;17(5):35–51. doi: <https://doi.org/10.15360/1813-9779-2021-5-35-51>.

Topic: Sepsis

001055

CAUTI prevention in intensive care. Is it time to apply a nurse driven protocol?

S. Lo Gaglio¹, E. Conoscenti², M. Campanella², G. Enea³, S. Caruso², G. Arena⁴, R. Lombardo⁵, M. Piazza⁶, M. Ziino⁷, D. I. La Milià⁸

¹Rn ASU, ISMETT, Palermo, Italy; ²Rn infection control dept., ISMETT, Palermo, Italy; ³Physical Therapist, ISMETT, Palermo, Italy; ⁴Chief of Nursing, ISMETT, Palermo, Italy; ⁵Rn Education Dept., ISMETT, Palermo, Italy; ⁶ASU Coordinator, ISMETT, Palermo, Italy; ⁷ASU Educator, ISMETT, Palermo, Italy; ⁸Epidemiologist, Chief of Staff, ISMETT, Palermo, Italy

Correspondence: S. Lo Gaglio

Intensive Care Medicine Experimental 2023, **11(Suppl 1)**:001055

Introduction: Catheter Associated Urinary Tract Infection (CAUTI) represents approximately 40% of all Hospital-Acquired Infections (HAI). Approximately 17%–69% of CAUTIs are reported to be preventable (1). A key factor in reducing CAUTI has been described as the assessment of readiness to remove the device (2). At our transplant center, the bundle of CAUTI has been introduced in 2021 and the adherence to preventive measures has been audited in 2022 to assess whether a catheter was promptly removed when appropriate, as per guidelines. The target infection rate for CAUTI was set in 2021 by the hospital acquired infection committee at $\leq 1.8\%$.

Objectives: Evaluate the unnecessary prolonged use of indwelling urinary catheters and the possibility to prompt removal.

Methods: Institutional CAUTI prevention policy based on HICPAC 2009 (3), has been reviewed. A dedicated infection control link nurse retrospectively reviewed 20 patient's charts with a diagnosis of CAUTI from January 2022 to December 2022. The adherence to the prevention bundle was verified. Descriptive statistics and a quality improvement plan are presented. As CDC definitions, infection rate indicator is structured by:

Numerator = Number of CAUTI cases in all units included.

Denominator = Number of catheter (foley) days in all units included $\times 1000$.

Criteria for foley indication are presented on table 1.

Results: The incidence of CAUTI in 2022 was 1.86‰ with 20 CAUTI events and 10.744 foley days. Incidence in 2022 had an overlapping percentage to 2019 with 1.8‰ incidence and 19 CAUTI over 10.704 foley days. Time frame average between foley insertion and the onset of infection was 21 days with $SD \pm 30$. The predominant number of CAUTI was sustained by GRAM – bacteria as confirmed in literature, no GRAM + were reported in our surveillance. Details are reported on table 2 (2). Among the 20 CAUTI, N°8 (40%) of the 20 patients developed sepsis. N°10 (50%) were transplanted patients. N°7 (35%) were developed during ICU stay, N°13 (65%) were hospitalized in step down unit. Three of the 7 ICU patients (57,1%) required accurate output measurement, 1 required strict immobilization post-surgery, 1 had urinary incontinence and a sacral wound. In step down unit: 1 of 13 patients (7,69%) had urinary incontinence with a sacral wound, 1 patient had urinary retention, 4 (30,76%) needed accurate output measurement. 9 patients (45%) out of 20 CAUTI cases did not meet the criteria for maintaining indwelling catheter. A multidisciplinary working group with surgeons, nephrologists, anesthesiologists led by Infection Control Nurse called "Nurse Driven Protocol" (NDP) has been discussed; electronic medical documentation has been updated which will allow nurses to remove the device if criteria are met.

Conclusions: Criterion for continuous catheterization and readiness for early removal was not evaluated during the studied time as the taskforce was not active yet, however the analysis shows that 9 patients could have benefited from an early removal of the device. Findings from literature generally support the acceptability of a NDP (4), particularly in higher-acuity units (5). And implementation of a nurse-driven protocol for the assessment of readiness to remove device as part of a multimodal CAUTI intervention strategy can result in measurable decreases of CAUTI incidence (6).

Table 1 (abstract 001055) Criteria for foley indication

Criterion	N patient
1 Urinary retention including obstruction and neurogenic bladder	1
2 Short perioperative use in selected surgeries	0
3 Required highly accurate output measurements in ICU	7
4 Placed by urology service	0
5 Assist healing of severe perineal and sacral wounds	2
6 Required strict immobilization for trauma or surgery	1
7 Hospice/comfort care or palliative care	0

Table 2 (abstract 001055) Microorganisms associated with CAUTIs

	fungus	GRAM +	GRAM -	MDR
<i>Klebsiella oxytoca</i>			1	
<i>Enterobacter aerogenes</i>			1	
<i>Pseudomonas Aeruginosa</i> MDR				1
<i>Escherichia Coli</i> ESBL				3
<i>Pseudomonas aeruginosa</i>			3	
<i>Candida albicans</i>	1			
<i>Acinetobacter baumannii</i> MDR				1
CRE - Carbapenem resistant enterobacteriaceae				2
<i>Klebsiella pneumoniae</i>			1	
<i>Escherichia Coli</i> ESBL				1
<i>Klebsiella pneumoniae</i> ESBL				3
<i>Citrobacter koseri</i>			1	
<i>Morganella morganii</i>			1	
	1	0	8	11

References

1. Jeyashree K, Arunagiri R. Impact of Care Bundle Implementation on Incidence of Catheter-associated Urinary Tract Infection: A Comparative Study in the Intensive Care Units of a Tertiary Care Teaching Hospital in South India. *Indian J Crit Care Med.* 2020 Sep 5;24(7):544–50. 2. Chenoweth CE, Gould CV, Saint S. Diagnosis, Management, and Prevention of Catheter-Associated Urinary Tract Infections. *Infect Dis Clin North Am.* 2014 Mar;28(1):105–19. 3. CDC—Center for Disease Control and Prevention. Guideline for Prevention of Catheter-Associated Urinary Tract Infections (2009) [Internet]. Available from: <https://www.cdc.gov/infectioncontrol/guidelines/cauti/index.html> 4. Agency for Healthcare Research and Quality (AHRQ). Toolkit for Reducing CAUTI in Hospitals [Internet]. Available from: <https://www.ahrq.gov/hai/tools/cauti-hospitals/index.html> 5. Blodgett TJ, Sheets C. Perceptions of a Nurse-Driven Urinary Catheter Removal Protocol in a Hospital Setting. *Clin Nurse Spec.* 2021 Mar;35(2):73–9. 6. Tyson AF, Campbell EF, Spangler LR, Ross SW, Reinke CE, Passaretti CL, et al. Implementation of a Nurse-Driven Protocol for Catheter Removal to Decrease Catheter-Associated Urinary Tract Infection Rate in a Surgical Trauma ICU. *J Intensive Care Med.* 2020 Aug;35(8):738–44.

Topic: Infections and prevention

001057

Evolution of intra-ICU infections in a tertiary hospital: from the period before COVID-19 to current days

L. Fernandez Ruiz¹, I. Cruz Valero², A. Fuentes Calatayud³
¹Hospital Santa Ana de Motril, Intensive care unit, Motril, Spain; ²Hospital Santa Ana de Motril, Intensive care, Granada, Spain; ³Hospital Santa Ana de Motril, Intensive care unit, Granada, Spain

Correspondence: L. Fernandez Ruiz

Intensive Care Medicine Experimental 2023, **11(Suppl 1)**:001057

Introduction: COVID-19 pandemia meant an important increase of intra-ICU infections. After it, the way to work in our ICU is trying to recover its normal activity, committing all the bundles for the prevention of intra-ICU infections in an effort to reach the rates before pandemia.

Objectives: Analyze main intra-ICU infection rates in our ICU, stressing on the evolution after the years of highest incidence of COVID-19.

Methods: Prospective, descriptive study, carried out in the ICU of Santa Ana Hospital in Motril in the period from 2019 to 2022. Demographics, severity index SAPS II and APACHE II, and different intra-UCI infections rates were collected.

Results: 857 patients admitted to the ICU at least for 24 h were recruited:398 in 2019, 178 in 2021 and 281 in 2022. 67% were

men, medium age 64 ± 17 years, SAPS II $32,51 \pm 17$ and APACHE II $11,41 \pm 8,1$. Medium stay in 2022 was 4,74, vs 7,32 in previous years. In relation to risk factors in 2022 vs previous years: artificial airway 26,33 vs 28,65, urinary catheter 54,80% vs 60,67%, central venous catheter 38,08% vs 42,13% and parenteral nutrition 2,85% vs 2,25%. In ICU 54,8% of patients in 2022 vs 56,18% in previous years, received antibiotics and had received them before the admission 13,17% vs 14,04%. 3,30% vs 1,12% were immunodeficient and 0,36% vs 0,56% presented neutropenia. Including secondary bacteremia due to other focus infection, in 2022 the rate of intra-ICU infection was 12,90 infections per 1000 days of ICU stay, in front of 321,42 in 2021 and 3,95 in 2019. In 2019 ventilator-associated pneumonia (VAP), urinary infections and Catheter-Related Bloodstream Infection (CRBI) had the same incidence (28,57%). In 2021 VAP supposed 42,86% of infections, urinary infections 22,86% and primary and secondary bacteremia related to catheter 17,14%. In 2022 NAVM continues to be the main intra-ICU infection, with bigger importance, supposing 76,47%. After it, with same incidence (5,88%) urinary infections related to catheter and bacteremia. We present the rates according to location in 2019,2021 and 2022. Ventilator-associated pneumonia (VAP): 3,16 per 1000 days of MV, 23,04 and 17,83. Catheter-Related Bloodstream Infection (CRBI): 1,68 bacteremia per 1000 days of CV, 4,94 and 1,29. Urinary infections: 1,84 per 1000 days of urinary catheter, 8,65 and 1,56.

In VAP *Paeruginosa* was the most frequent isolated in the three periods. In 2021 and 2022 *Serratia marcescens* was the second microorganism in NAVM. In relation to Catheter-Related Bloodstream Infection (CRBI), in 2022 *S.epidermidis* caused 100%, while in 2021 the most frequent isolated microorganism was *Paeruginosa*(33%) follow by *S.epidermidis* (33%) and *C.albicans* (16,67%) and in 2019 only gram-negative bacilli were isolated. Finally, in relation to urinary infections, the most frequent isolated microorganism in 2022 was *Serratia marcescens*, whereas in 2021 was *Candida spp.* (33%) follow by *Enterococcus faecalis* (11,11%) and *E.coli* (11,11%) and in 2019 100% was caused by *Paeruginosa*.

Conclusions: Normalisation of work conditions in ICU, with the decrease of COVID-19 incidence in 2022, has suppose an important decrease of intra-ICU infections rates, far away from previous rates before pandemia yet.

References

- 2019, 2021 and 2022 ENVIN-HELICS registry.
- All colleagues of intensive care in Santa Ana Hospital in Motril.

Topic: Infections and prevention

001058

Epidemiological research of Open Chest Management in postoperative management for Congenital Heart Disease—Retrospective observational study at a single institution

T. Tanabe¹, K. Motono¹, T. Kawasaki¹

¹Department of Pediatric Critical Care, Shizuoka Children's Hospital, Shizuoka, Japan

Correspondence: T. Tanabe

Intensive Care Medicine Experimental 2023, **11(Suppl 1)**:001058

Introduction: It has been reported that open chest management (OCM) is useful in management after cardiac surgery. The usefulness of OCM for congenital heart disease (CHD) has also been advocated empirically while OCM is said to carry the risk of infection. But epidemiological studies of OCM in children are limited, and actual management methods vary greatly in different institutions. Furthermore, the details and infection risk have not been revealed.

Objectives: The purpose of this study was to clarify the clinical practice of OCM and to analyze risk factors for the occurrence of infections after OCM.

Methods: Patients who underwent OCM at Shizuoka Children's Hospital were selected. The study period was from January 1, 2011 to December 31, 2022. We assigned patients who underwent OCM after CHD surgery to the extracorporeal membrane oxygenation (ECMO)

group and the non-ECMO group. Exclusion criteria were those who underwent slide tracheoplasty, OCM due to mediastinitis, and OCM after the second hospitalization in the same hospital. The primary outcome was the occurrence of surgical site infection (SSI) requiring surgical intervention, ventilator-associated pneumonia, or catheter-related bloodstream infection after OCM management. The secondary outcomes were in-hospital mortality, length of hospital stay and length of ICU stay. In addition, univariate and multivariate analyses were performed to analyze risk factor of any of those serious infections after OCM.

Results: A total of 3419 cardiac surgeries were performed during the study period. 324 cases of OCM were eligible. 69 cases met the exclusion criteria, and 255 cases were included in the study; 35 were assigned to the ECMO group and 220 were assigned to the non-ECMO group. Comparing the interventions during the OCM between the ECMO and non-ECMO groups, median OCM duration was 258 h (IQR 108 to 571 h) vs 188 h (14 to 437 h) ($p < 0.05$); post-OCM infections were 13 (37.1%) vs 38 (17.3%) ($p < 0.05$). In-hospital mortality was higher in ECMO group (13 (37.1%) vs 27 (12.3%) ($p < 0.05$)), and length of ICU stay was longer in ECMO group (57 days (IQR 14 to 415 h) vs 28 days (5 to 409 h) ($p < 0.05$)). In multivariate analysis, only OCM duration over 72 h was significantly associated with post-OCM infection (odds ratio 3.2; 95% confidence interval, 1.26 to 8.12).

Conclusions: Compared with the non-ECMO group, the ECMO group had longer OCM duration and length of ICU stay, and more post-OCM infections and in-hospital deaths. In multivariate analysis, only OCM duration over 72 h was a risk factor for post-OCM infection. Further investigation is required for risk analysis of post-OCM infection.

References

- None
- 3 S Ram Kumar, et al. *Ann Thorac Surg.* 2018 Aug;106(2):581–586.
- 2 Emre Ozker, et al. *Journal of Cardiothoracic Surgery* 2012, 7:102.
- 1 Joshua K Wong, et al. *J Thorac Cardiovasc Surg.* 2017;154(3):915–924.

Topic: Cardiovascular issues in ICU

001059

Delirium and inflammation biomarkers in critically ill covid-19 patients

S. Stauffacher¹, Z. Ltaief¹, J. D. Chiche¹, N. Ben Hamouda¹

¹Adult intensive care, CHUV Centre Hospitalier Universitaire Vaudois, Lausanne, Switzerland

Correspondence: N. Ben Hamouda

Intensive Care Medicine Experimental 2023, **11(Suppl 1)**:001059

Introduction: Delirium in the ICU is common and is associated with increased mortality and length of stay (LOS). In critically ill patients with COVID-19, delirium occurred in more than 50%. Whereas some risk factors have been reported in this population [1], the role of systemic inflammation in the pathogenesis of delirium and acute brain dysfunction has not yet been fully explored in patients with COVID-19.

Objectives: The aim of the study is to investigate the relationship between the advent of delirium and biomarkers of inflammation in critically ill patients with COVID-19.

Methods: We studied critically ill adult patients with confirmed SARS-CoV2 infection admitted to the Centre Hospitalier Universitaire Vaudois (CHUV, Lausanne) between March 2020 and May 2021. Patients with acute brain injury diagnosis on admission or with an ICU Length of stay < 48 h were excluded.

We measured serum cytokines and soluble cytokine receptors (IL-1 α , IL-1 β , IL-1RA, IL-2, IL-4, IL-5, IL-6, IL-7, IL-9, IL-10, IL-12p70, IL-13, IL-15, IL-17A, IL-18, IL-21, IL-22, IL-23, IL-27, IL-31, IFN- α , IFN- γ and TNF α), chemokines (CCL2, CCL3, CCL4, CCL5, CCL11, CXCL1, CXCL8, CXCL9, CXCL10, CXCL12, CXCL13 and TNF- β) and growth factors (NGF- β , BDNF, EGF, FGF-2, HGF, LIF, PDGF-BB, PIGF-1, SCF, VEGF-A, VEGF-D, BAFF, GM-CSF and G-CSF) by multiplex bead assay as previously described [2]. A positive CAM-ICU during the ICU stay defined the presence of delirium.

Results: 314 patients were enrolled. Mean age was 63 ± 12 years. ARDS was the primary diagnosis in 57% of the population. The incidence of delirium was 35.7% in the cohort and 68% in mechanically ventilated patients. For the immunomodulatory drugs, 21% of the patients received tocilizumab (no difference between both groups), and dexamethasone was administered in 70% of the patients included (group delirium- 75% versus group delirium + 60%, $p = 0.005$).

TNF- β (Tumor necrosis factor), FGF-2 (fibroblast growth factor), BAFF (B-cell activating factor) were not detected in all the patients evaluated. Among all chemokines and cytokines analyzed, CCL11 (C-C motif Chemokine ligand), CCL4, IL-1 β , IL-6, IL-15, IL-17A profiles showed an association with the diagnosis of delirium (Figure 1). With regard to growth factors, G-CSF was higher in the delirium group. No association was found between complement and delirium. IBM SPSS 23.0, student's t test, Mann-Whitney U test and Pearson's χ^2 tests were used for statistics, level of significance $p < 0.05$.

Conclusions: We have identified in this cohort factors involved in the systemic inflammation and whose levels could be associated with delirium in critically ill patients. These inflammatory factors would be responsible (or partly responsible) for the generation of a neuroinflammation and the activation of the microglia and clinically manifested by the occurrence of a delirium.

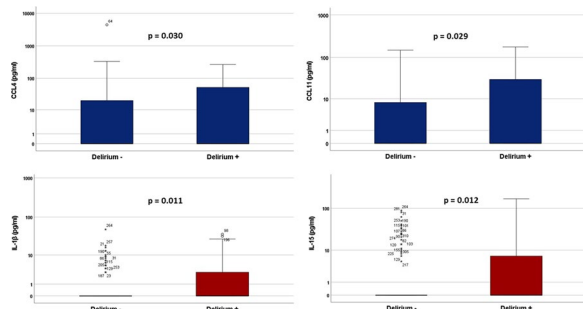

References

1. Pun BT, et al. (2021) Prevalence and risk factors for delirium in critically ill patients with COVID-19 (COVID-D): a multicentre cohort study. *Lancet Respir Med* 9:239–250.
2. Perreau M, et al. (2021) The cytokines HGF and CXCL13 predict the severity and the mortality in COVID-19 patients. *Nat Commun* 12:4888.

Topic: Sedation, analgesia and delirium.

001061

Polymicrobial bloodstream infections per se do not increase mortality compared to monomicrobial bloodstream infections: A Korean nationwide sepsis cohort

L. Su Yeon¹, M. H. Park¹, D. K. Oh¹, C. M. Lim¹

¹Department of pulmonary and critical care medicine, Asan Medical Center, Seoul, Republic of Korea

Correspondence: L. Su Yeon

Intensive Care Medicine Experimental 2023, **11(Suppl 1)**:001061

Introduction: It is presumed that polymicrobial bloodstream infections may have worse outcomes than monomicrobial bloodstream infections. But there is limited information about the outcomes of polymicrobial bloodstream infections in sepsis patient. We aimed to investigate outcomes of polymicrobial bloodstream infections compared to monomicrobial bloodstream infections.

Methods: This study used data from the Korean Sepsis Alliance Registry, a nationwide database of prospective observational sepsis cohort. In this registry, adult patients with sepsis from September 2019 to December 2021 at 20 tertiary or university-affiliated hospitals in South Korea were enrolled. Patients with polymicrobial bloodstream

infections and those with monomicrobial bloodstream infections were compared in this study.

Results: Among the 3,823 patients with bloodstream infections, 429 of them (11.2%) had polymicrobial bloodstream infections. The crude hospital mortality of patients with sepsis with polymicrobial bloodstream infection and monomicrobial bloodstream infection was 35.7% and 30.1%, respectively ($p = 0.021$). Polymicrobial bloodstream infections per se were not associated with hospital mortality by multivariate cox proportional hazard analysis (HR 1.15, $p = 0.11$). The inappropriate use of antibiotics was associated with increased mortality (HR 1.37 [1.19–1.57], $p < 0.001$), and source control was associated with decreased mortality (HR 0.51 [0.42–0.62], $p < 0.001$).

Conclusions: Polymicrobial bloodstream infections per se were not associated with hospital mortality in patients with sepsis as compared to monomicrobial bloodstream infections. The appropriate use of antibiotics and source control were associated with decreased mortality in bloodstream infections regardless of the number of microbial pathogens.

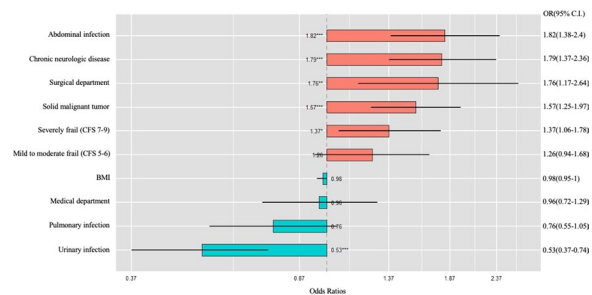

Figure 1 (abstract 001061) Factors associated with occurrence of polymicrobial bloodstream infections. (OR, odds; CI, confidence interval; BMI, body mass index; CFS, Clinical Frailty scale)

Topic: Sepsis

001063

The living experience of surviving out-of-hospital cardiac arrest: a phenomenological study

M. Karanikola¹, M. Aristidou², E. Kusi-Appiah³, A. Koutroubas¹, U. Pant³, F. Vouzavali⁴, E. Lambrinou¹, E. Papathanassoglou³

¹Department of Nursing, Cyprus University of Technology, Vragadinou str-Limassol, Cyprus; ²Department of Nursing, European University Cyprus, Nicosia, Cyprus; ³Faculty of Nursing, University of Alberta, Edmonton, Canada; ⁴Faculty of Nursing, National and Kapodistrian University of Athens, Athens, Greece

Correspondence: U. Pant

Intensive Care Medicine Experimental 2023, **11(Suppl 1)**:001063

Introduction: A significant number of out-of-hospital cardiac arrest (OHCA) survivors experience subsequent cognitive, physical, and emotional impairments impacting their quality of life and functionality (Sawyer et al., 2020; Wagner et al., 2021; Yaow et al., 2022). Recognizing the psychosocial and spiritual concerns of surviving out-of-hospital cardiac arrest is important in identifying care priorities, and supporting OHCA survivors and their families to live well. Qualitative studies investigating the experiences of out-of-hospital cardiac arrest survivors illuminated several common themes across cultures (Aristidou et al., 2018), along with variabilities likely due to culture-specific interpretations and language filters (Greyson, 2015; Martial et al., 2019). Therefore, a qualitative exploration to understand how Greek-Cypriot out-of-hospital cardiac arrest survivors make meaning of their experiences can help inform health care.

Objectives: The aim of the study was to understand the meaning of surviving OHCA and its aftereffects among Greek speaking survivors in Cyprus.

Methods: We employed a hermeneutical phenomenological method based on Heidegger's philosophy to inform data collection and analysis. The participants were recruited from the Registry of Cardiac Arrest of a metropolitan General Hospital in Cyprus using purposive sampling. The sample size was based on achievement of a comprehensive description and interpretation of participants' experiences, and thematic saturation. Data were collected through 60–90 min interviews guided by open-ended questions.

Results: Seven males and one female between the ages of 45 and 69 participated. Analysis revealed five themes: "The unexpected attack", "Experiencing a different world: Transformation of Body, Time, Emotion and Sensation", "Restoration of the re-embodied self", "Life transformation", and "Personal transformation". The themes were commensurate with transcultural components of Near-Death Experiences. Surviving out of hospital cardiac arrest was perceived as "a divine gift" and a chance to continue "living in a more conscious and meaningful way".

Conclusions: Despite participants' physical and psychosocial challenges, our results show that OHCA is experienced as a powerful process of transformation, starting with the cardiac arrest episode itself, and permeating every aspect of survivors' life. A profound transformation of survivors' lives and existence was central in the experience of surviving OHCA, with strong spiritual elements, and themes bearing transcultural components of Near-Death experiences.

References

1. Aristidou, M., Vouzavali, F., Karanikola, M. N., Lambrinou, E., & Papathanasoglou, E. (2018). A Meta-ethnography of Out-of-Hospital Cardiac Arrest Survivors' Meanings on Life and Death. *The Journal of cardiovascular nursing*, 33(3), E10–E20. doi: <https://doi.org/10.1097/JCN.0000000000000467>
2. Büssing, A., Ostermann, T. & Matthiessen, P.F. Role of religion and spirituality in medical patients: Confirmatory results with the SpREUK questionnaire. *Health Qual Life Outcomes* 3, 10 (2005). doi: <https://doi.org/10.1186/1477-7525-3-10>
3. Wagner, M. K., Berg, S. K., Tang, L. H., Stenbaek, D. S., Hassager, C., & Missel, M. (2021). Understanding the lived experiences of short- and long-term consequences on daily life after out-of-hospital cardiac arrest. A focus group study. *Journal of advanced nursing*, 77(3), 1442–1452. doi: <https://doi.org/10.1111/jan.14707>
4. Yaow, C. Y. L., Teoh, S. E., Lim, W. S., Wang, R. S. Q., Han, M. X., Pek, P. P., Tan, B. Y., Ong, M. E. H., Ng, Q. X., & Ho, A. F. W. (2022). Prevalence of anxiety, depression, and post-traumatic stress disorder after cardiac arrest: A systematic review and meta-analysis. *Resuscitation*, 170, 82–91. doi: <https://doi.org/10.1016/j.resuscitation.2021.11.023>
5. This research received no funding.
6. Greyson, B. (2015). Western Scientific Approaches to Near-Death Experiences. *Humanities*, 4(4), 775–796. doi: <https://doi.org/10.3390/h4040775>
7. Heidegger M. (1962). *Being and Time*. UK: Blackwell Publishing.
8. Hennink, M. M., Kaiser, B. N., Atkinson, P., Delamont, S., Cernat, A., Sakshaug, J. W., & Williams, R. A. (2020). *Saturation in qualitative research*. SAGE Publications Ltd.
9. Martial, C., Cassol, H., Charland-Verville, V., Pallavicini, C., Sanz, C., Zamberlan, F., Vivot, R. M., Erowid, F., Erowid, E., Laureys, S., Greyson, B., & Tagliazucchi, E. (2019). Neurochemical models of near-death experiences: A large-scale study based on the semantic similarity of written reports. *Consciousness and Cognition*, 69, 52–69. doi: <https://doi.org/10.1016/j.concog.2019.01.011>
10. Sawyer, K. N., Camp-Rogers, T. R., Kotini-Shah, P., Del Rios, M., Gossip, M. R., Moitra, V. K., Haywood, K. L., Dougherty, C. M., Lubitz, S. A., Rabinstein, A. A., Rittenberger, J. C., Callaway, C. W., Abella, B. S., Geocadin, R. G., Kurz, M. C., & American Heart Association Emergency Cardiovascular Care Committee; Council on Cardiovascular and Stroke Nursing; Council on Genomic and Precision Medicine; Council on Quality of Care and Outcomes Research; and Stroke Council (2020). Sudden Cardiac Arrest Survivorship: A Scientific Statement from the American Heart Association. *Circulation*, 141(12), e654–e685. doi: <https://doi.org/10.1161/CIR.0000000000000747>

Topic: Cardiac arrest

001064

Predicting patient stability in the ICU using artificial intelligence

I. Pessach¹, A. Lipski², N. Ayala³, C. Lilly⁴, A. Edwards⁵, D. Kirk⁵, J. Blum⁶

¹Pediatric Critical Care, Safra Children Hospital, Ramat Gan, Israel;

²Emergency Medicine, Emek Medical Center, Afula, Israel; ³Analytics, Clew

Medical, Netanya, Israel; ⁴Critical Care, UMass Memorial Medical Center

Memorial Campus, Worcester, United States of America; ⁵Critical Care,

WakeMed Raleigh Campus, Raleigh, United States of America; ⁶Division

of Critical Care, The University of Iowa, Iowa City, United States of America

Correspondence: I. Pessach

Intensive Care Medicine Experimental 2023, **11(Suppl 1)**:001064

Introduction: Predicting patient stability in the ICU is critical for effective patient care as it enables providers to allocate attention to the most critical patients. Recent studies have focused on developing various tools that predict patient deterioration and complications while in the ICU. However, predicting patient stability, i.e., identifying which patients are unlikely to deteriorate, also holds significant value for ICU providers. In this study, we describe the development of a gradient boosting classifier to predict which patients would not require intervention in the next 14 h. We further evaluate the model's performance in prospectively identifying ICU patients at low-risk for respiratory failure or hemodynamic instability.

Methods: The model development study utilized 53,071 patient ICU stays from 7 ICUs within the UMass Memorial Health Care system from 2006 to 2017. The population was divided into three cohorts. The model was trained using 42,737 stays, with hyper-parameter tuning conducted using a validation set of 5,167 stays. The performance of the model was then evaluated using a study set of 5,167 stays.

Following retrospective model development, a prospective, observational study was conducted including all patients admitted to the WakeMed tele-ICU program between May–July 2020. All clinical data, including vital signs, medication records, laboratory data, and all other electronic medical record entries, were prospectively collected and analyzed. Each stay was divided into 1-h evaluation periods, excluding the first 12 h and stays of patients defined as DNI/DNR. Respiratory failure and hemodynamic instability events were prospectively tagged by a senior on-site clinician. The model's performance was evaluated by comparing its ability to predict low risk of deterioration with expert tagging of each period.

Results: Following model training, we demonstrated that at a given moment in time, $38.8 \pm 0.06\%$ of patients across the UMass Memorial system were not in need of intervention within the following 14 h. The model was able to classify these patients as stable with a sensitivity of 0.63, precision of 0.993, and an AUC of 0.83 over the study set of 5,167 stays. The model accurately identified 2,951 twelve-hour shifts that did not require intervention, and 1,659 stays (32% of all stays) that required no significant intervention throughout the entire stay.

Following the retrospective model validation phase, we prospectively evaluated the model performance on 514 adult ICU stays across 3 ICUs covered by the WakeMed tele-ICU program. A total of 21,391 one-hour periods were analyzed. These included 19,375 (90.7%) periods with low risk for deterioration and 1,989 (9.3%) periods of instability, in which the patients experienced either respiratory failure or hemodynamic instability. The model performance in predicting the low-risk periods included a sensitivity, specificity, and PPV of 0.46, 0.97, and 0.99, respectively. Events in which patients deteriorated while the model predicted they were stable were extremely rare, with only 59 (0.27%) mislabeled periods. However, more than 40% of the periods were labeled as stable by the model.

Conclusions: This predictive model successfully identified a significant portion of the ICU patient population as low-risk for significant deterioration both retrospectively and in a real-life prospective environment. Such a prediction can enable providers to focus on the more unstable patients, leading to improved care and better patient outcomes. The model's high sensitivity, specificity, and PPV, with an

extremely low prevalence of mislabeled periods, suggest that it could be a valuable tool in clinical settings. However, further studies are necessary to validate the model's performance and assess its impact on patient outcomes.

Topic: Data Science

001065

Retrospective cohort study on the impact of adrenaline dosage on clinical outcomes of in-hospital cardiac arrest

C. H. Ng¹, S. J. Pang², Y. H. E. Ching², K. L. C. Leong³, J. C. C. Tien⁴

¹Lee Kong Chian School of Medicine, Lee Kong Chian School of Medicine, Singapore, Singapore; ²Clinical Quality and Performance Management, Singapore General Hospital, Singapore, Singapore; ³Respiratory and Critical Care Medicine, Singapore General Hospital, Singapore, Singapore; ⁴Surgical Intensive Care, Singapore General Hospital, Singapore, Singapore

Correspondence: J.C.C. Tien

Intensive Care Medicine Experimental 2023, **11(Suppl 1)**:001065

Introduction: Adrenaline is the first-line medication given in advanced cardiac life support. However, its impact on resuscitation outcome is unclear. Cumulative doses of adrenaline was shown to be associated with unfavourable outcome and increased mortality in patients with non-shockable rhythms. The objective of this study is to investigate the effect of adrenaline doses on return of spontaneous circulation (ROSC) and 30-day survival after an episode of in-hospital cardiac arrest (IHCA).

Methods: This retrospective cohort study collected and analysed 170 patients who suffered from cardiac arrest within a tertiary hospital in Singapore from 1st January 2020 to 31st December 2020. The primary variable was adrenaline doses categorised into quartiles, which was analysed against primary outcome of ROSC and secondary outcome of 30-day survival.

Results: The univariate and multivariate analyses are shown in table 1 for the primary outcome of ROSC. The multivariate analysis showed that patients given more than 5mg of adrenaline had a statistically significant reduced chances of ROSC (adjusted odds ratio (OR) 0.125 (0.03–0.54) and 0.016 (0–0.11) for 3rd and 4th quartile doses). The effect of adrenaline dosage was not found to be statistically significant on 30-day survival post-IHCA.

Table 1 (abstract 001065) Univariate and multivariate analysis on primary outcome of ROSC

PATIENT ROSC	UNIVARIATE		MULTIVARIATE	
	Odds Ratio (95% CI)	p value	Odds Ratio (95% CI)	p value
Adrenaline quartile				
1st (0–3 mg)				
2nd (4–5 mg)	0.339 (0.08–1.49)	0.152	0.321 (0.06–1.65)	0.174
3rd (6–10 mg)	0.099 (0.03–0.32)	<0.05	0.125 (0.03–0.54)	<0.05
4th (10–38 mg)	0.013 (0.00–0.05)	<0.05	0.016 (0.00–0.11)	<0.05
Sex				
Female	1.028 (0.54–1.96)	0.934	0.786 (0.31–2.01)	0.615
Age	0.995 (0.97–1.02)	0.720	0.982 (0.95–1.02)	0.339
Initial Rhythm				
Asystole				

PATIENT ROSC	UNIVARIATE		MULTIVARIATE	
	Odds Ratio (95% CI)	p value	Odds Ratio (95% CI)	p value
Pulseless electrical activity (PEA)	3.097 (1.55–6.17)	0.001	3.353 (1.28–8.78)	0.014
Ventricular fibrillation (VF)	5.322 (1.08–26.24)	0.040	10.295 (1.03–103.08)	0.047
Ventricular tachycardia (VT)	2.129 (0.36–12.46)	0.402	2.489 (0.18–35.16)	0.500
Length of resuscitation (min)	0.950 (0.93–0.97)	<0.05	0.988 (0.96–1.02)	0.404
Time to 1st adrenaline (min)	0.976 (0.92–1.04)	0.458	0.962 (0.88–1.05)	0.401

Conclusions: The results of the study show that patients that receive more doses of adrenaline (> 5 mg) are less likely to have ROSC.

References

1. Girotra S, Nallamothu BK, Spertus JA, Li Y, Krumholz HM, Chan PS. Trends in survival after in-hospital cardiac arrest. *New England Journal of Medicine*. 2012;367(20):1912–20.
2. Xiao A, Callaway CW, Coppler PJ. Long-term outcomes of post-cardiac arrest patients with severe neurological and functional impairments at hospital discharge. *Resuscitation*. 2022;174:93–101.
3. Soar J, Böttiger BW, Carli P, Couper K, Deakin CD, Djävrv T, et al. European Resuscitation Council guidelines 2021: Adult Advanced Life Support. *Resuscitation*. 2021;161:115–51.
4. Bakhsh A, Safhi M, Alghamdi A, Alharazi A, Alshabibi B, Alobaidi R, et al. Immediate intravenous epinephrine versus early intravenous epinephrine for in-hospital cardiopulmonary arrest. *BMC Anesthesiology*. 2021;21(1).
5. Andersen LW, Kurth T, Chase M, Berg KM, Cocchi MN, Callaway C, et al. Early administration of epinephrine (adrenaline) in patients with cardiac arrest with initial shockable rhythm in hospital: Propensity score matched analysis. *BMJ*. 2016;i1577.
6. Grunau B, Kawano T, Scheuermeyer FX, Drennan I, Fordyce CB, van Diepen S, et al. The association of the average epinephrine dosing interval and survival with favorable neurologic status at hospital discharge in out-of-hospital cardiac arrest. *Annals of Emergency Medicine*. 2019;74(6):797–806.
7. Shao H, Li C-S. Epinephrine in out-of-hospital cardiac arrest. *Chinese Medical Journal*. 2017;130(17):2112–6.
8. Huan L, Qin F, Wu Y. Effects of epinephrine for out-of-hospital cardiac arrest. *Medicine*. 2019;98(45).
9. Homma Y, Shiga T, Funakoshi H, Miyazaki D, Sakurai A, Tahara Y, et al. Association of the time to First Epinephrine administration and outcomes in out-of-hospital cardiac arrest: SOS-Kanto 2012 Study. *The American Journal of Emergency Medicine*. 2019;37(2):241–8.
10. Lundin A, Rylander C, Karlsson T, Herlitz J, Lundgren P. Adrenaline, ROSC and survival in patients resuscitated from in-hospital cardiac arrest. *Resuscitation*. 2019;140:64–71.
11. Arrich J, Sterz F, Herkner H, Testori C, Behringer W. Total epinephrine dose during asystole and pulseless electrical activity cardiac arrests is associated with unfavourable functional outcome and increased in-hospital mortality. *Resuscitation*. 2012;83(3):333–7.
12. Gough C, Nolan J. The role of adrenaline in cardiopulmonary resuscitation. *Critical Care*. 2018;22(1).
13. Tang W, Weil M, Sun S, Noc M, Yang L, Gazmuri R. Epinephrine Increases the Severity of Postresuscitation Myocardial Dysfunction. *Circulation*. 1995;92(10):3089–3093.
14. Stiell I, Hebert P, Weitzman B, Wells G, Raman S, Stark R et al. High-Dose Epinephrine in Adult Cardiac Arrest. *Survey of Anesthesiology*. 1994;38(2):118–119.
15. Morales-Cané I, Valverde-León M, Rodríguez-Borrego M. Epinephrine in cardiac arrest: systematic review and meta-analysis. *Revista Latino-Americana de Enfermagem*. 2016;24(0).
16. Behringer W. Cumulative Epinephrine Dose during Cardiopulmonary Resuscitation and Neurologic Outcome. *Annals of Internal Medicine*. 1998;129(6):450.
17. Perkins G, Ji C, Deakin C, Quinn T, Nolan J, Scopin C et al. A Randomized Trial of Epinephrine in Out-of-Hospital Cardiac Arrest. *New England Journal of*

Medicine. 2018;379(8):711–721. 18. Ewy G, Bobrow B, Chikani V, Sanders A, Otto C, Spaite D et al. The time dependent association of adrenaline administration and survival from out-of-hospital cardiac arrest. *Resuscitation*. 2015;96:180–185. 19. Hansen M, Schmicker R, Newgard C, Grunau B, Scheuermeyer F, Cheskes S et al. Time to Epinephrine Administration and Survival From Nonshockable Out-of-Hospital Cardiac Arrest Among Children and Adults. *Circulation*. 2018;137(19):2032–2040. 20. Sigal A, Sandel K, Buckler D, Wasser T, Abella B. Impact of adrenaline dose and timing on out-of-hospital cardiac arrest survival and neurological outcomes. *Resuscitation*. 2019;139:182–188. 21. Donnino M, Saliccioli J, Howell M, Cocchi M, Giberson B, Berg K et al. Time to administration of epinephrine and outcome after in-hospital cardiac arrest with non-shockable rhythms: retrospective analysis of large in-hospital data registry. *BMJ*. 2014;348(may20 2):g3028-g3028. 22. Silverman M, Scirica B. Cardiac arrest and therapeutic hypothermia. *Trends in Cardiovascular Medicine*. 2016;26(4):337–344. 23. Bassiakou E, Xanthos T, Papadimitriou L. The potential beneficial effects of beta adrenergic blockade in the treatment of ventricular fibrillation. *European Journal of Pharmacology*. 2009;616(1–3):1–6. 24. Gottlieb M, Dyer S, Peksa GD. Beta-blockade for the treatment of cardiac arrest due to ventricular fibrillation or pulseless ventricular tachycardia: A systematic review and meta-analysis. *Resuscitation*. 2020;146:118–25. 25. de Oliveira FC, Feitosa-Filho GS, Ritt LE. Use of beta-blockers for the treatment of cardiac arrest due to ventricular fibrillation/pulseless ventricular tachycardia: A systematic review. *Resuscitation*. 2012;83(6):674–83. 26. Grunau B, Reynolds JC, Scheuermeyer FX, Stenstrom R, Pennington S, Cheung C, et al. Comparing the prognosis of those with initial shockable and non-shockable rhythms with increasing durations of CPR: Informing minimum durations of resuscitation. *Resuscitation*. 2016;101:50–6. 27. Kim JG, Shin H, Cho JH, Choi HY, Kim W, Kim J, et al. Prognostic value of changes in the cardiac arrest rhythms from the prehospital stage to the emergency department in out-of-hospital cardiac arrest patients without prehospital returns of spontaneous circulation: A nationwide observational study. *PLOS ONE*. 2021;16(9). 28. Sedgwick P. Retrospective cohort studies: advantages and disadvantages. *BMJ*. 2014;348(jan24 1):g1072-g1072. 29. Abella B. High-quality cardiopulmonary resuscitation. *Current Opinion in Critical Care*. 2016;22(3):218–224. 30. Lin P, Shi F, Wang L, Liang Z. Nighttime is associated with decreased survival for out of hospital cardiac arrests: A meta-analysis of observational studies. *The American Journal of Emergency Medicine*. 2019;37(3):524–529.

Topic: Cardiac arrest

001066

Antibiotic selection based on microbiology of bile from gallbladder of patients with acute cholangitis

J. Fuss¹, A. Voloboyeva², V. Polovyy³

¹Department of Surgery, Regional Hospital of Pustomyty, Lviv, Ukraine;

²Icu, Communal Municipal Clinical Hospital 8, Lviv, Ukraine; ³General surgery, Bukovinian State Medical University, Chernivtsi, Ukraine.

Correspondence: J. Fuss

Intensive Care Medicine Experimental 2023, **11(Suppl 1)**:001066

Introduction: Acute cholangitis is a life-threatening condition, usually caused by obstruction of the biliary system or/and ascending pathogens due to an incompetent or resected sphincter of Oddi [1, 2]. The early interventional restoration of the bile flow, mostly achieved by endoscopic retrograde cholangiography (ERC), and the early antibiotic therapy are the 2 treatment pillars in the management of acute cholangitis [3–7].

Objectives: This study aimed to provide profiles of microorganisms isolated from bile and antibiotic susceptibility patterns of biliary tract infections (BTIs) in our hospital.

Methods: Patients were included when a bile culture for microbiological assessment was obtained during ERC between January 2018 and December 2022. During this period, bile cultures from 258 patients were available for analysis.

Results: Patients with an age of ≥ 65 years were the majority of the participants (198/258; 76.75%). The majority primary diseases were benign (86.4%; n = 223), while 13.6% were malignant. A total of 310 strains of microorganisms were isolated.

Microbial isolates	Total number	%
Gram-negative bacteria		
<i>Escherichia coli</i>	98	31,5
<i>Klebsiella pneumoniae</i>	45	14,5
<i>Pseudomonas aeruginosa</i>	23	7,5
<i>Enterobacter</i>	15	4,9
<i>Acinetobacter baumannii</i>	11	3,5
<i>Proteus mirabilis</i>	9	2,8
<i>Citrobacter freundii</i>	4	1,4
ESBL-producing <i>Klebsiella pneumoniae</i>	3	0,95
<i>Proteus vulgaris</i>	3	0,95
ESBL-producing <i>Klebsiella oxytoca</i>	2	0,7
<i>Stenotrophomonas maltophilia</i>	2	0,7
<i>Aeromonas</i>	2	0,7
<i>C. faecalis</i>	1	0,5
<i>Enterobacter aerogenes</i>	1	0,5
Gram-positive bacteria:		
<i>Enterococcus faecalis</i>	42	13,8
<i>Staphylococcus epidermidis</i>	18	5,8
<i>Streptococcus viridis</i>	12	3,6
MRSE	6	1,7
<i>Streptococcus bovis</i>	6	1,7
<i>Staphylococcus aureus</i>	5	1,6
<i>Enterococcus faecium</i>	2	0,7

Of all isolates, 219 were Gram-negative bacteria (71.1%), 91 were Gram-positive bacteria (28,9%). No anaerobes were detected in our study.

As can be seen from our studies, *Escherichia coli* were highly sensitive to ertapenem, imipenem and amikacin, with a high sensitivity rate of over 85%.

K.pneumoniae was completely sensitive to ampicillin, and ertapenem, and antibiotics with higher susceptibility rates include imipenem (90%), cefoperazone/sulbactam (98%).

Conclusions: Bacterial resistance increases continuously with the overuse of antibiotics, which make the treatment of BTIs more problematic. Therefore, the rational use and standard management of antibiotics are extremely necessary. Based on the timely drainage and relief of biliary tract obstruction, β -lactamase inhibitors or carbapenems should be given for acute severe BTIs.

Topic: Infections and prevention.

001067

Sex differences in the use of mechanical ventilation in a neurointensive care population: a retrospective study

F. Stretti¹, D. Utebay¹, S. Y. Bögli², G. Brandt¹

¹Intensive Care Medicine, University Hospital of Zürich, Zürich, Switzerland;

²Neurology, University Hospital of Zürich, Zürich, Switzerland

Correspondence: F. Stretti

Intensive Care Medicine Experimental 2023, **11 (Suppl 1)**:001067

Introduction: Women receive less invasive mechanical ventilation (IMV) 1–4. In neurocritical care, these differences between sexes have been less investigated, but they might contribute to the sex-related differences in mortality⁵. The aim of this retrospective single center study was to compare the frequency of respiratory support between sexes in a neurocritical care population.

Table 1 (abstract 001067) .

	Total	Male	Female	p-value
n (%)	963	532 (55.2)	431 (44.8)	0.0013
Age (years, mean \pm SD)	59 \pm 17	59 \pm 17	60 \pm 16	0.379
SAPS (median [IQR])	32 [19, 48]	33 [19, 48]	32 [18, 48]	0.581
Any cerebral hemorrhage	480 (49.8)	245 (46.1)	235 (54.5)	0.010
Subarachnoid hemorrhage	280 (29.1)	116 (21.8)	164 (38.1)	<0.001
Traumatic brain injury	23 (2.4)	19 (3.6)	4 (0.9)	0.009
Ischemic stroke	164 (17.0)	109 (20.5)	55 (12.8)	0.002
Cerebral tumor	126 (13.1)	59 (11.1)	67 (15.5)	0.044
Other	223 (23.2)	131 (24.6)	95 (22.0)	0.698
Respiratory comorbidity (n (%))	387 (40.2)	225 (42.3)	162 (37.6)	0.07

Methods: This retrospective study included adults treated at the neurocritical care unit (NCCU) of the University Hospital Zurich between 01.2018 and 08.2021. We collected data on demographics, intubation, re-intubation, tracheotomy, and duration of IMV or other forms of respiratory support from the Swiss ICU registry or medical records. Baseline and outcome characteristics were compared by sex in the whole population and in subgroup analysis (SPSS v. 26).

Results: A total of 963 patients were included. There was no difference in baseline characteristics, except for diagnosis (Table 1). Women had a longer ICU and hospital stay (Table 2). There was no difference between sexes in the provision of IMV but there was a difference in the duration of oxygen support. The subgroup analysis yielded similar results.

Table 2 (abstract 001067) .

	Male	Female	p-value
Reintubation (n (%))	38 (7.1)	20 (4.6)	0.133
Tracheotomy (n (%))	91 (17.1)	68 (15.8)	0.601
Ventilation support (shifts, mean \pm SD)	13 \pm 21	15 \pm 23	0.151
Oxygen support (number of shifts, mean \pm SD)	11 \pm 12.5	13 \pm 13.9	0.018
LOS Hospital (days, mean \pm SD)	18 \pm 13	20 \pm 15	0.010
LOS ICU (days, mean \pm SD)	8 \pm 9	10 \pm 10	0.011
ICU mortality (n (%))	37 (7)	35 (8.1)	0.494

Conclusions: Differences in mechanical ventilation according to sex have been confirmed in a recent metanalysis⁶, where studies investigating individual diagnostic cohorts were excluded, leading to potential biases. As an example, in the subgroup of sepsis or burn patients, sex had no influence on ICU treatment or mortality^{7,8}.

In our cohort, women received oxygen supplementation for a longer time. This can be explained with the higher prevalence of SAH in women. In our protocol, we aim for a higher partial pressure of oxygen due to the specific risk of delayed cerebral ischemia.

Women had a significantly longer LOS in the ICU and in the hospital. Again, we can attribute this to the higher prevalence of SAH: these patients are monitored for a longer time due to the risk of vasospasm. As limitation of the study, it is a single center study in a high-income country. Most data on sex differences in medicine come from higher income countries⁶, where there could be now more awareness to possible sex-related biases.

In our NCCU population, we found no difference in invasive mechanical ventilation between sexes. Women received a longer duration of other forms of respiratory support (oxygen supplementation through High Flow therapy, mask or nasal cannula) and had a longer length of stay in the ICU and in the hospital, due to the higher prevalence of subarachnoid hemorrhage (SAH).

References

3. Lemos-Filho LB, Mikkelsen ME, Martin GS, et al. Sex, race, and the development of acute lung injury. *Chest*. Apr 2013;143 (4):901–909. <https://doi.org/10.1378/chest.12-1118>
2. Valentin A, Jordan B, Lang T, Hiesmayr M, Metnitz PG. Gender-related differences in intensive care: a multiple-center cohort study of therapeutic interventions and outcome in critically ill patients. *Crit Care Med*. Jul 2003;31 (7):1901–7. <https://doi.org/10.1097/01.CCM.0000069347.78151.50>
3. 1. Fowler RA, Sabur N, Li P, et al. Sex-and age-based differences in the delivery and outcomes of critical care. *CMAJ*. Dec 4 2007;177 (12):1513–9. <https://doi.org/10.1503/cmaj.071112>
4. 8. Ederer IA, Hacker S, Sternat N, et al. Gender has no influence on mortality after burn injuries: A 20-year single center study with 839 patients. *Burns*. 2019;15:205–212.
5. 7. Reina Failla K, Connelly CD. Systematic Review of Gender Differences in Sepsis Management and Outcomes. *J Nurs Scholarsh*. 2017;49 (3):312–324. <https://doi.org/10.1111/jnu.12295>
6. 6. Modra LJ, Higgins AM, Abeygunawardana VS, Vithanage RN, Bailey, Michael J, Bellomo R. Sex Differences in Treatment of Adult Intensive Care Patients: A Systematic Review and Meta-Analysis. *Critical Care Medicine*. 2022;50 (6):913–923. <https://doi.org/10.1097/CCM.00000000000005469>
7. 5. Rexrode KM, Madsen TE, Yu AXY, Carcel C, Lichtman JH, Miller EC. The Impact of Sex and Gender on Stroke. *Circulation Research*. 2022;130 (4):512–528. <https://doi.org/10.1161/CIRCRESAHA.121.319915>
8. 4. Shen HN, Lu CL, Yang HH. Women receive more trials of noninvasive ventilation for acute respiratory failure than men: a nationwide population-based study. *Crit Care*. Jul 25 2011;15 (4):R174. <https://doi.org/10.1186/cc10323>

Topic: Neurointensive care

001068

The National Early Warning Score Plus (NEWS Plus) model to prognosticate severe COVID-19 pneumonia

K. Trongtrakul¹, A. Deesomchok¹, P. Tajareernmuang¹, A. Limsukon¹, T. Theerakittikul¹, N. Niyatiwatchanchai¹, K. Surasit², P. Glunriangsang³, C. Liwsrisakun¹, C. Bumroongkit¹, C. Pothirat¹, J. Inchai¹, W. Chaiwong¹
¹Internal Medicine, Faculty of Medicine, Chiang Mai University, Chiang Mai, Thailand; ²Internal medicine, Nakornping Hospital, Chiang Mai, Thailand; ³Internal Medicine, Sansai Hospital, Chiang Mai, Thailand

Correspondence: K. Trongtrakul

Intensive Care Medicine Experimental 2023, **11** (Suppl 1):001068

Introduction: Early identification and appropriate triaging those patients with severe COVID-19 pneumonia is very crucial in a resource-limited setting.

Objectives: We aimed to validate a simple physiological score, named the National Early Warning Score (NEWS), in its property for discriminating the patients with severe COVID-19 pneumonia from those with non-severe. We also aimed to investigate the performance of the updated NEWS Plus model with common risk factors at time of hospital admission in determining severe cases.

Methods: We retrospectively analyzed all adult patients (age \geq 18) with COVID-19 infection from the Registry for COVID-19 patients of Chiang Mai, Thailand. The data were collected during the outbreak of COVID-19 between April 2021 and October 2021 from three centers in Chiang Mai including Sansai, Nakornping, and Maharaj Nakorn Chiang Mai hospitals. The patients with severe COVID-19 pneumonia were defined corresponding to the WHO Working Group for COVID-19 infection ordinal scale from six to nine [1]. We used logistic regression analyses to determine risk factors at hospitalization associated with the severe condition and assigned the score corresponding to their coefficient in the logit model. We used the concordance statistic (C-statistic) to analyze the model performance and the Youden index to determine the best cut-off point in identifying severe cases.

Results: A total of 725 adult patients with COVID-19 infection were involved. Of these, 350 (48.3%) patients suffered severe COVID-19 pneumonia. Age and body mass index (BMI) were two significant risk factors associated with severe COVID-19 pneumonia, besides NEWS. We assigned a score of 3 and 4 for an age of 40–59 and \geq 60,

respectively, and a score of 2 and 4 for a BMI of 25.0–29.9 and ≥ 30.0 , respectively. After adding these two variables into the traditional NEWS (maximal score of 20), therefore, the maximal score for the NEWS Plus (NEWS + age + BMI) model would be 27. The use of NEWS showed the C-statistic value of 0.80; 95% CI, 0.77–0.83 in determining the patients with severe COVID-19 pneumonia. While the NEWS Plus model had a better discriminative ability, with the C-statistic of 0.82; 95% CI, 0.79–0.85. It was significantly better in the C-statistic values ($p = 0.012$) when comparing these two models (Figure 1). The best cut-off point for the traditional NEWS and the NEWS Plus was five and eight scores, respectively. The NEWS Plus model provided slightly higher values of sensitivity and negative predictive value than the traditional NEWS, with the value of 88.0% vs. 83.7% and 84.1% vs. 80.7%, respectively.

Conclusions: The addition of age and BMI into the traditional NEWS provided more satisfaction in discriminating the patients with severe COVID-19 pneumonia from those with non-severe. A score of seven from the NEWS Plus supported physicians for early decision-making since the hospital admission and could deliver an appropriate place for admission in a resource-limited setting.

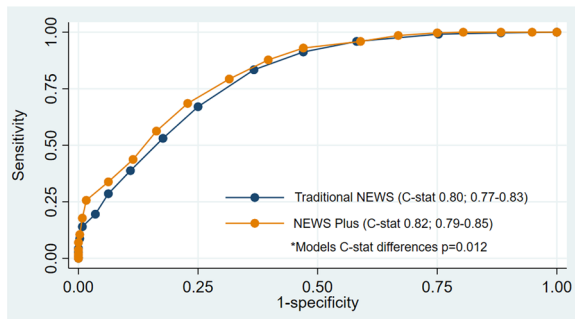

References

1. A waiver for the documentation of consent was applied according to the research was involved with no more than minimal risk and was performed as a secondary data analysis.
2. Our study was supported by the Faculty of Medicine Chiang Mai University Research Fund, grant no.157/2564.
3. Marshall JC, Murthy S, Diaz J, Adhikari NK, Angus DC, Arabi YM, et al. A minimal common outcome measure set for COVID-19 clinical research. *The Lancet Infectious Diseases*. 2020;20 (8):e192-e7.
4. The study was approved by the Research Ethics Committee of the Faculty of Medicine, Chiang Mai University, Thailand, Study code: MED-2564–08109, on May 3, 2021.

Topic: Acute respiratory failure and mechanical ventilation

001069

Hormonal response following hemorrhagic shock in severe trauma: an observational study

M. Werner¹, H. Joulia¹, E. Pussard², J. Duranteau¹, B. Vigué¹, A. Harrois¹
¹Anesthesiology and Intensive Care, Bicetre Hospital AP-HP, Le Kremlin-Bicêtre, France; ²Service de Génétique Moléculaire, Pharmacogénétique et Hormonologie, Bicetre Hospital AP-HP, Le Kremlin-Bicêtre, France

Correspondence: M. Werner
Intensive Care Medicine Experimental 2023, **11 (Suppl 1)**:001069

Introduction: Following traumatic hemorrhagic shock, several physiological mechanisms are involved to maintain blood pressure and organ perfusion. Several hormonal systems contribute to these adaptive mechanisms but remain poorly described yet.

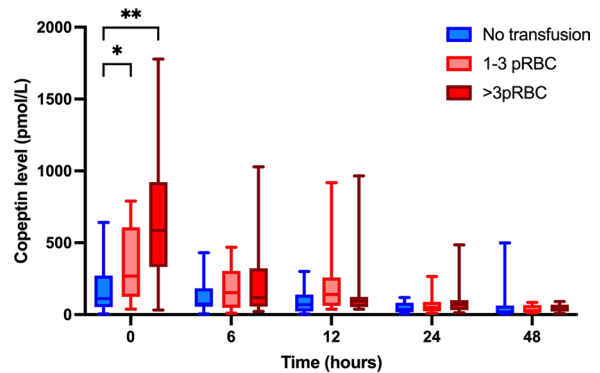

Figure 1 (abstract 001069) Copeptin evolution during the first 48 h of ICU according to the number of pack of red blood cells (pRBC) transfused.

Objectives: The main goal of this study was to explore pituitary and adrenal hormone responses to severe trauma.

Methods: We conducted a prospective and observational study in a French level I trauma center. Patients admitted to the trauma bay following severe trauma with an Injury Severity Score (ISS) > 9 were included. Vasopressin assessed through copeptin secretion, cortisol, renin and aldosterone were measured at intensive care unit (ICU) admission, and at 6-, 12-, 24- and 48-h following ICU admission. Hormone concentrations were compared over the first 48 h of admission between patients transfused with at least one pack of red blood cells (pRBC) and non-transfused patients.

Results: Sixty-six patients were included with a median Injury Severity Score of 25 (19–30). Twenty-eight (43%) patients received at least one pRBC. Evolution of copeptin level was different over the 48 h of admission between transfused and non-transfused patients ($p < 0.001$). Copeptin was maximum at ICU arrival and was greater in transfused than in non-transfused patients (486 ± 433 pmol/L et 208 ± 206 pmol/L; $p < 0.001$). Copeptin decreased rapidly thereafter, without difference between transfused and non-transfused patients from H6. Admission copeptin was significantly greater in patients receiving higher quantity of pRBC (no transfusion: 208 ± 206 pmol/L vs. 1–3 pRBC: 346 ± 283 pmol/L vs. >3 pRBC: 606 ± 509 pmol/L, $p < 0.001$). There was no difference between transfused and non-transfused patients regarding levels of cortisol ($p = 0.06$), renin ($p = 0.3$) and aldosterone ($p = 0.3$) over the first 48 h of admission. Eleven (19%) patients had low cortisol (lower than the lower limit) and 44 (67%) patients presented mineralocorticoid deficiency (renin/aldosterone ≤ 2) over the first 48 h of ICU.

	All patients (n = 66)	Non-transfused patients (n = 38)	Transfused patients (n = 28)	p
Age—years	46 ± 20	47 (20)	46 (21)	0.88
Women—n (%)	18 (27)	10 (26)	8 (29)	0.84
ISS	25 (19–30)	25 (20–32)	25 (18–30)	0.90
Parameters on admission to trauma bay				
HR—bpm	86 (75–102)	84 (72–100)	90 (84–119)	0.01*
MBP—bpm	80 ± 18	89 (76–96)	69 (62–84)	0.006*
Hb—g/dl	11.8 ± 2.3	12.8 (1.6)	10.3 (2.27)	< 0.001*
Lactate—mmol/l	2.1 (1.4–3.6)	1.7 (1.3–2.9)	2.5 (2–5.4)	0.01*

	All patients (n = 66)	Non-transfused patients (n = 38)	Transfused patients (n = 28)	p
Catecholamine—n (%)	17 (25)	9 (24)	8 (29)	0.65
Evolution				
Fluid balance > 4 L H6	17 (25)	8 (3)	14 (50)	< 0.001*
Hemostatic surgery	20 (30)	2 (5)	18 (64)	0.01*
Embolisation	7 (11)	0 (0)	7 (25)	0.001*
Mortality	14 (21)	10 (26)	4 (14)	0.24

Conclusions: Vasopressin secretion is the predominant and earliest hormonal response to traumatic hemorrhagic shock. Its level is increased in patients requiring transfusion at ICU admission but decreased rapidly in the following hours. Glucocorticoid and mineralocorticoid deficiencies seem common and need further exploration. Hormonal measurement could have a prognostic and therapeutic interest for hemorrhagic shock management in trauma patients.

References

1. Tolstoy NS, Aized M, McMonagle MP, Holena DN, Pascual JL, Sonnad SS, et al. Mineralocorticoid deficiency in hemorrhagic shock. *J Surg Res.* avr 2013;180 (2):232-7.
2. Sims CA, Guan Y, Bergey M, Jaffe R, Holmes-Maguire L, Martin N, et al. Arginine vasopressin, copeptin, and the development of relative AVP deficiency in hemorrhagic shock. *Am J Surg.* oct 2017;214 (4):589-95.
3. Salvo F, Luppi F, Lucchesi DM, Canovi S, Franchini S, Polese A, et al. Serum Copeptin levels in the emergency department predict major clinical outcomes in adult trauma patients. *BMC Emerg Med.* 24 févr 2020;20 (1):14.

Topic: Trauma

001070

Surveying satisfaction and the quality of a peer-to-peer tele-medicine service for critical care physicians in Pakistan

M. A. Khan¹, K. Niazi¹, S. Sohani¹, H. Atiq², A. Latif²
¹Dean's Office, Aga Khan University, Karachi, Pakistan; ²Department of Anaesthesiology, Aga Khan University, Karachi, Pakistan

Correspondence: M.A. Khan

Intensive Care Medicine Experimental 2023, **11 (Suppl 1)**:001070

Introduction: Pakistan has a lack of accredited critical care programs and physicians, a problem which was exacerbated during the COVID-19 pandemic. Many things were done to rapidly expand critical care capacity in the short term, from online seminars to workshops to tele-medicine with unknown degrees of effectiveness. In particular, there is a dearth of understanding on physician acceptability of tele-medicine, specifically with regards to peer-to-peer models or its use in critical care settings in low and middle income countries (LMICs).

We established a tele-critical care consultation service to help local providers manage critically ill patients that would not otherwise have access to specialized intensivists. This was set up as a "peer-to-peer" consultation service. We assessed the tele-critical care consultation service for acceptability and satisfaction to help guide future work in this area.

Objectives: Our objective is to assess perceptions of the Tele-ICU service among the physicians that use it using a structured questionnaire. Our secondary objective is to assess the quality of our service and identify areas of improvement.

Methods: We utilize a "hub-and-spoke model" of peer-to-peer tele-medicine, in which physicians in ICUs across Pakistan consult critical

care experts at our facility. To date, we have treated 1615 patients with 5427 tele-consultations. The study was a cross-sectional survey of end-users of the Tele-ICU project, which were on-site physicians who had utilized the Tele-ICU service at least once in a two year period from April 1st, 2020, to December 31st, 2022.

The survey form captured participants' socio-demographic data and experience in critical care, along with qualitative feedback. Questions regarding the Tele-ICU service were adapted from the guidelines by the American Telemedicine Association and organized in line with its three main themes into clinical, process, and technical. These were answered using a 5-point Likert scale, with the options being "strongly disagree," "disagree," "neutral," "agree," and "strongly agree." These responses were given incremental values from 1–5 respectively, which were then aggregated into scores for each question by calculating the mean of the responses out of 5. A net promoter score was also calculated as a metric for user satisfaction.

Results: The service was used by 360 unique physicians at 48 centers. We had current contact information of 219 total physicians, out of which we received responses from 145 (66.2%) from 39 different facilities. The vast majority of these (63.4%) were between the ages of 25–34, with 33.8% having 1–2 years of experience in critical care and 32.4% having worked for 3–5 years. 43.4% were residents, and 27.6% were medical officers. In terms of specialties, 28.3% were working in anesthesia and 26.2% in internal medicine. 52.4% participated in 1–10 tele-consultations, while 22.8% were involved in 11–20.

The three highest rated aspects of respondents' perception of our service from the clinical section were that working with Tele-ICU physicians added to their medical knowledge (4.64), that it helps them manage difficult/complicated patients (4.63), and they felt that it helped them improve patient outcomes (4.56). With regards to the process section, respondents felt that patient summaries provided by the Tele-ICU were helpful (4.52) and that they were satisfied with the teamwork during tele-consultations (4.37).

24.1% of physicians either disagreed or strongly disagreed that their internet connection was adequate enough for tele-consultations, a finding which varied significantly between provinces on Kruskal-Wallis analysis ($p = 0.004$) and possibly reflected geographical variation in infrastructure. When asked to qualitatively describe any shortcomings of the service, 10.3% participants felt that the requisite investigations and drugs that were advised for patients were not available. One physician said that the "treatment and management shared by the team is most of the times not available in far-flung areas." When asked if physicians would recommend the Tele-ICU service to their peers, the calculated net promoter score was 59, with 75 promoters, 54 passives, and 16 detractors.

Conclusions: The survey participants were broadly satisfied with the tele-ICU service, attesting that it improved patient care and that it was easy to utilize. Our tele-consultation model can be applied to other LMICs which require bolstering of trained critical care human resources.

References

1. The Tele-ICU Project is fully funded by the Bill & Melinda Gates Foundation (INV-017820)

Topic: Critical care organisation, quality management, information systems, outcomes

001071

The effect of lateral tilting on lung ventilation homogeneity assessed by electrical impedance tomography: a pilot prospective study

V. Spatenkova¹, A. Mejstrik², M. Mlcek², M. Popkova², L. Cisar¹, E. Kurišćák³
¹Neurointensive Care Unit, Regional Hospital, Liberec, Czech Republic; ²Institute of Physiology, First Faculty of Medicine Charles University, Prague, Czech Republic; ³Institute of physiology, Charles University, 1st Medical Faculty, Prague, Czech Republic

Correspondence: V. Spatenkova

Intensive Care Medicine Experimental 2023, **11 (Suppl 1)**:001071

Introduction: Ventilation management maintaining normoxemia and normocapnia is an important strategy in neurocritical care. Body positioning changes the regional transpulmonary pressures, promotes postural alveolar recruitment which could improve lung ventilation homogeneity and pulmonary blood flow distribution [1].

Objectives: We attempted to quantify the effect of the standard protocol of lateral body position on parameters of lung ventilation homogeneity and compliance obtained by electrical impedance tomography (EIT). Two types of lateral tilting were used: manual positioning of the body by a nurse versus bed tilting (15° lateral tilt, LINET Eleganza 5).

Methods: 69 acute adult mechanically ventilated neurocritical care patients were continuously monitored by EIT over three days on average. We evaluated altogether 908 positions with exact times of tilting manually reviewed. Every two hours the position of the patient was changed ('supine'/'left side'/'supine'/'right side') during which lung ventilation homogeneity was evaluated by Global Inhomogeneity index (Gli, [2]). The Gli of both lungs, the left lung, and the right lung was estimated by minute-wise averages, starting 60 min before, and ending 120 min after each position change. We also evaluated the course of mechanical lung compliance, EIT-based regional ventilation delay inhomogeneity index, and electrical lung compliance. SpO2 and EtCO2 parameters were compared before and after each position change (registered hourly).

Results: Tilting our patients transiently decreased the value of Gli and increased the value of lung compliance. The Gli returned to baseline within 20 min after the change of body position ($P < 0.01$), whereas the lung compliance returned to baseline after 50 min on average ($P < 0.05$), showing the dynamics of measured parameters due to the body positioning (see. Figure). SpO2 and EtCO2 parameters measured hourly did not change statistically significantly.

Conclusions: In neurocritical care patients with healthy lungs, the EIT-based lung ventilation inhomogeneity index Gli showed a temporary improvement of lung ventilation homogeneity lasting less than 20 min on average after a body position change. The increase of lung compliance lasted roughly 50 min on average.

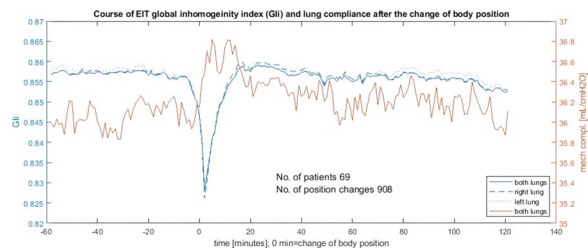

Global Inhomogeneity index (Gli) and lung compliance.

References

2. Zhao Z, Steinmann D, Frerichs I, Guttman J, Möller K. PEEP titration guided by ventilation homogeneity: a feasibility study using electrical impedance tomography. Crit Care. 2010;14 (1):R8. <https://doi.org/10.1186/cc8860>. Epub 2010 Jan 30. PMID: 20113520; PMCID: PMC2875520.
1. Borsellino B, Schultz MJ, Gama de Abreu M, Robba C, Bilotta F. Mechanical ventilation in neurocritical care patients: a systematic literature review. Expert Rev Respir Med. 2016 Oct;10 (10):1123–32. <https://doi.org/10.1080/17476348.2017.1235976>. Epub 2016 Sep 21. PMID: 27635737.
- TAÇR FW01010679

Topic: Neurointensive care

001072

Sequelae of patients admitted to ICU due to severe SARS COV 2 pneumonia

A. Estella¹, P. Ruiz Leal², T. Begoña Fernández³
¹University Hospital of Jerez. INIBICA, Intensive Care Unit. Medicine Department University of Cádiz, Jerez, Spain; ²University of Cádiz,

Medical School, Cádiz, Spain; ³University Hospital of Jerez, Emergency Department, Jerez de la Frontera, Spain

Correspondence: A. Estella

Intensive Care Medicine Experimental 2023, 11 (Suppl 1):001072

Introduction: The SARS CoV2 pandemic has been a real challenge for the scientific community facing a disease hitherto unknown. The most severe clinical form of clinical presentation has been the development of severe pneumonia with respiratory distress syndrome, requiring this population admission to the ICU.

Objectives: The aim of this study is to analyze physical and psychological sequelae in patients admitted to the ICU due to severe SARS CoV2 pneumonia.

Methods: Observational, descriptive and qualitative interview study based on the collection of data from patients admitted to the ICU of a community Hospital for SARS-CoV-2 in the period from March 2020 to December 2021. A structured telephone interviews was conducted to know the symptoms and to assess activities of daily living at the time of the assessment. Statistical analysis: Data were analyzed by SPSS 20, quantitative variables were expressed as a mean ± standard deviation and qualitative by percentage.

Results: 106 patients were admitted to the ICU, 16 patients did not respond or could not be located, finally a total of 90 patients were included, 45.6% of whom were in employment. The clinical characteristics of patients are summarized in Table 1. Telephone interview was performed 65 ± 20 weeks after discharge from ICU. 81.11% were found to have some symptoms related to the past infection (Figure 1) while 18.89% reported being asymptomatic. Some degree of dependence or disability to carry out basic activities of daily living was found in 18.8%. Table 2 shows degree of dependence by Rankin scale.

Table 1 (abstract 001072) Clinical characteristics of patients included in the study

Patients discharged from ICU after severe SARS CoV2 Pneumonia. n: 90	
Age (years)	58.9 ± 11.85 years
Gender: Male/ Female	59 (65.6%)/ 31 (34.4%)
Obesity/ Hypertension/Diabetes/Dyslipidemy	22 (24.4%)/50 (55.5%)/ 26 (28.8%)/42 (46.7%)
Heart disease / Respiratory disease/ Chronic Kidney disease	24 (26.7%)/ 11 (12.2%)/6 (6.6%)
Mean length of ICU stay (days)	15.58 ± 15.69
Invasive Mechanical ventilation requirements	56 (62.2%)

Table 2 (abstract 001072) Degree of dependence measured through the Rankin scale

Grade	Frequency	Percentage
No symptoms	73	81.1%
No significant disability. Able to carry out all usual activities, despite some symptoms		
Slight disability. Able to look after own affairs without assistance, but unable to carry out all previous activities	10	11.1%
Moderate disability. Requires some help, but able to walk unassisted	4	4.4%
Moderately severe disability. Unable to attend to own bodily needs without assistance, and unable to walk unassisted	3	3.3%

Conclusions: Months after admission to the ICU for severe SARS-CoV-2 pneumonia, most patients reported symptoms related to the past infection, with dyspnea, myalgia, amnesia and anxious-depressive mood being the most frequent.

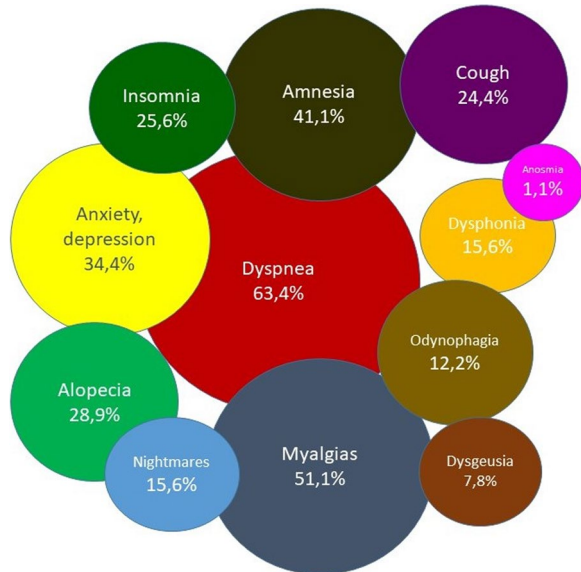

Symptoms after ICU admission due to SARS-CoV2 pneumonia.

Topic: Critical care organisation, quality management, information systems, outcomes

001073

Brain oxygenation response to hypercapnia in acute brain injured patients

M. Anderloni¹, S. Schuind², M. Salvagno³, K. Donadello⁴, L. Peluso³, F. S. Taccone³, E. Bogossian³

¹Anestesia e rianimazione B, University of Verona, AOUI-University Hospital Integrated Trust of Verona, Verona, Italy; ²Service de neurochirurgie, Hospital Erasme, Bruxelles, Belgium; ³Soins intensifs, ULB Erasme, Anderlecht, Belgium; ⁴Anesthesia and Intensive Care B Unit, University of Verona, AOUI-University Hospital Integrated Trust of Verona, Verona, Italy

Correspondence: M. Anderloni

Intensive Care Medicine Experimental 2023, **11** (Suppl 1):0001073

Introduction: Cerebral hypoxia is a frequent cause of secondary brain injury in patients with acute brain injury 1. Although hypercapnia can increase intracranial pressure, it may have beneficial effects on tissue oxygenation 2. We aimed to assess the effects of hypercapnia on brain tissue oxygenation (PbtO₂) 3.

Methods: This single-center retrospective study (November 2014-June 2022) included all patients admitted to the Intensive Care Unit (ICU) at Erasme Hospital (Bruxelles) after an acute brain injury who required multimodal monitoring including PbtO₂ and who underwent induced hypercapnia according to the decision of the treating physician. Patients with imminent brain death were excluded. "Responders" to hypercapnia were defined as an increase of at least 20% in PbtO₂ values when compared to baseline levels.

Results: On a total of 163 eligible patients, we identified 23 (14%) patients who underwent induced hypercapnia during the study period; 6 patients had traumatic brain injury (TBI) and 17 subarachnoid hemorrhages (SAH). There was a significant overall increase in the median PbtO₂ values from baseline [21 (19–26) to

24 (22–26) mmHg; $p = 0.02$] after the reduction in minute ventilation. There was a small increase ($p = 0.63$) in ICP after hypercapnia from 8 (7–18) to 10 (8–20) and a non-significant ($p = 0.39$) reduction in CPP from 113 (99–121) to 106 (88–118). There was no correlation between increases in CO₂ (delta CO₂) and changes in PbtO₂ (delta PbtO₂): $r_{\text{spearman}} = -0.028$ (95% CI – 0.0446 to 0.0399). Responders ($n = 14/23$, 61%) after induced hypercapnia had numerically lower mortality rate than others. [4/14 (29%) vs 3/9 (33.3), $p = 0.88$].

Conclusions: In this study, a heterogeneous response of brain tissue oxygenation to induced hypercapnia was observed, but without any deleterious elevations of ICP.

References

- 3 Stetter C, Weidner F, Lilla N, et al. Therapeutic hypercapnia for prevention of secondary ischemia after severe subarachnoid hemorrhage: physiological responses to continuous hypercapnia. *Sci Rep.* 2021;11 (1):11715. <https://doi.org/10.1038/s41598-021-91007-7>
- 2 Hays LMC, Udy A, Adamides AA, et al. Effects of brain tissue oxygen (PbtO₂) guided management on patient outcomes following severe traumatic brain injury: A systematic review and meta-analysis. *Journal of Clinical Neuroscience.* 2022;99:349–358. <https://doi.org/10.1016/j.jocn.2022.03.017>
- 1 Gouvea Bogossian E, Battaglini D, Fratino S, et al. The Role of Brain Tissue Oxygenation Monitoring in the Management of Subarachnoid Hemorrhage: A Scoping Review. *Neurocrit Care.* Published online February 17, 2023. <https://doi.org/10.1007/s12028-023-01680-x>

Topic: Neurointensive care

001074

Novel extracorporeal therapy device using reactive oxygen species scavenging microbeads for effective sepsis treatment

P. Im¹, D. Kim², J. Kim¹, H. G. Jeong²

¹School of Chemical Engineering, Sungkyunkwan University, Suwon-si, Republic of Korea; ²Division of Neurocritical Care, Departments of Neurosurgery and Neurology, Seoul National University Bundang Hospital, Seongnam-si, Republic of Korea

Correspondence: H.G. Jeong

Intensive Care Medicine Experimental 2023, **11** (Suppl 1):0001074

Introduction: Sepsis is a life-threatening condition that has been challenging to treat. Despite the initial excitement surrounding extracorporeal hemoperfusion devices that remove endotoxin or cytokines, they have ultimately been deemed ineffective and are not recommended for use in guidelines.

Objectives: We aimed to develop an extracorporeal therapy device using microbeads that could effectively treat sepsis by removing excessive reactive oxygen species.

Methods: The mesocellular silica foams (MCF) microbeads were synthesized using a modified template method, while the Ceria nanoparticles (CeNP) were synthesized in an aqueous phase using 6-aminohexanoic acid. CeNP-loaded MCF microbeads (CeMCF) were obtained by mixing CeNPs solution with MCF microbeads, and the resulting product was PEGylated using methoxy PEG-amide-succinimidyl glutarate 5000. The surface morphology, element composition, pore size, pore volume, and surface area of the microbeads were characterized. reactive oxygen species scavenging properties of the microbeads were evaluated in both wells and cartridge systems. Male Sprague–Dawley rats ($n = 3$; CeMCF, $n = 3$; control) were used in animal experiments. Rats were anesthetized, intubated, and mechanically ventilated, and cannulation with a 24 gauge catheter was performed in the right common carotid artery, right common femoral artery, and left common femoral vein. An extracorporeal hemoperfusion circuit was set up using tubing, 3-way connectors, a peristaltic pump, and a microbead cartridge connected to the cannula in the common carotid artery and common femoral vein. To induce septic shock, a lethal dose of lipopolysaccharide (20 mg/kg) was intravenously injected. Hemoperfusion was performed for 4 h at a flow rate of 1 to 3 ml/min, and

intravenous norepinephrine was used when hypotension occurred. The serum lactic acid level was measured at the end of hemoperfusion therapy.

Results: MCF with a size of approximately 500 μm and high surface area (244.73 m^2/g) and pore volume (0.56 cm^3/g) were synthesized. 1 g of MCF was mixed with 5 mg/mL CeNPs, resulting in 100% loading efficiency confirmed by inductively coupled plasma mass spectrometry, scanning electron microscope and energy-dispersive X-ray spectroscopy (Ce 12.54 wt% in CeMCF microbeads). The resulting CeMCF microbeads had sufficient reactive oxygen species scavenging properties in hydrogen peroxide and hydroxyl radical assays, with CeMCF exhibiting up to 90% scavenging efficiency at a concentration of 10 mg . In cartridge system tests, CeMCF microbeads showed significant hydrogen peroxide removal efficiency, with approximately 40% removal after 1 cycle, approximately 50% after 2 cycles, and approximately 70% after 3 cycles, while MCF microbeads showed no significant removal. Hemoperfusion treatment for 4 h in an animal sepsis model using lethal dose of LPS significantly reduced lactic acid levels (4.4 mmol/L in CeMCF microbeads vs. 7.1 mmol/L in the control, $P < 0.01$) and intravenous norepinephrine demand (mean 0.08 ± 0.03 $\text{mcg}/\text{kg}/\text{min}$ in CeMCF microbeads vs. mean 0.49 ± 0.14 $\text{mcg}/\text{kg}/\text{min}$ in the control, $P = 0.02$).

Conclusions: In conclusion, we have developed a novel extracorporeal therapy device using microbeads that effectively scavenges reactive oxygen species and reduces lactic acid levels in a rat sepsis model. Our CeMCF microbeads demonstrated high scavenging efficiency in both well and cartridge system tests, and significantly reduced lactic acid levels and intravenous norepinephrine demand in the animal sepsis model. Our findings suggest that CeMCF microbeads could be a promising therapy option for sepsis treatment, and warrant further investigation for potential clinical applications.

References

1. This work was supported by the National Research Foundation of Korea (NRF) grant funded by the Korea government (MSIT) (No. 2022R1C1C1009610)

Topic: Translational Medicine

001075

Cerebrospinal fluid analysis of metabolites cannot replace microdialysis measurements in acute brain injured patients

M. P. G. Bellettieri¹, M. Anderloni², V. Rass,³ P. Kindl³, K. Donadello², F. S. Taccone¹, R. Helbok³, E. Bogossian¹

¹Soins intensif, ULB Erasme, Anderlecht, Belgium; ²Anesthesia and Intensive Care B, University of Verona, AOUI-University Hospital Integrated Trust of Verona, Verona, Italy; ³Department of neurology, Medizinische Universität Innsbruck, Innsbruck, Austria

Correspondence: M. Anderloni

Intensive Care Medicine Experimental 2023, **11** (Suppl 1):001075

Introduction: Cerebral microdialysis (CMD) has become an established bedside monitoring modality 1 but its implementation remains complex and costly and is therefore performed only in a few well-trained academic centres.

Objectives: This study investigated the relationship between cerebrospinal fluid (CSF) and CMD glucose and lactate concentrations 2 -3.

Methods: Two-center retrospective study of prospectively collected data. Consecutive adult (> 18 years) acutely brain injured patients admitted to the Intensive Care Unit between 2010 and 2021 were eligible if CSF and CMD glucose and lactate concentrations were concomitantly measured at least once.

Results: Of 113 patients being monitored with an external ventricular drainage and CMD, 49 patients (25 from Innsbruck and 24 from Brussels) were eligible for the final analysis, including a total of 96 measurements. Median CMD glucose and lactate concentrations were 1.15 (0.51–1.57) mmol/L and 3.44 (2.24–5.37) mmol/L , respectively; median CSF glucose and lactate concentrations were 4.67 (4.03–5.34) mmol/L and 3.40 (2.85–4.10) mmol/L , respectively. For the first measurements, no correlation between CSF and CMD glucose concentrations

($R^2 < 0.01$; $p = 0.95$) and CSF and CMD lactate concentrations ($R^2 = 0.16$; $p = 0.09$) was found. Considering all measurements, the repeated measure correlation analysis showed also no correlation for glucose (rrm = -0.01; 95% Confidence Intervals - 0.306 to 0.281; $p = 0.93$) and lactate (rrm = -0.11; 95% Confidence Intervals - 0.424 to 0.236; $p = 0.55$).

Conclusions: In this study including acute brain injured patients, no correlation between CSF and brain tissue measurements of glucose and lactate was observed. As such, CSF measurements of such metabolites cannot replace CMD findings.

References

1. 3 Taccone FS, Badenes R, Arib S, Rubulotta F, Mirek S, Franchi F, et al. Cerebrospinal Fluid Glucose and Lactate Levels After Subarachnoid Hemorrhage: A Multicenter Retrospective Study. *J Neurosurg Anesthesiol* 2020; 32 (2):170–176
2. 1 Hutchinson PJ, Jalloh I, Helmy A, Carpenter KL, Rostami E, Bellander BM, et al. Consensus statement from the 2014 International Microdialysis Forum. *Intensive Care Med* 2015; 41 (9):1517–28.
3. 2 Lozano A, Franchi F, Seastres RJ, Oddo M, Lheureux O, Badenes R, Scolletta S, Vincent JL, Creteur J, Taccone FS. Glucose and Lactate Concentrations in Cerebrospinal Fluid After Traumatic Brain Injury. *J Neurosurg Anesthesiol* 2020; 32 (2):162–169.

Topic: Neurointensive care

001076

Mechanical ventilation and communication barriers in intensive care units: a qualitative study

S. Brambilla¹, D. Ausili², G. Bellani³, M. Luciani²

¹Scienze infermieristiche, University of Milano Bicocca, Monza, Italy;

²Department of Medicine and Surgery, University of Milano Bicocca, Monza, Italy;

³Department of Anesthesia and Intensive Care, University of Trento, Trento, Italy

Correspondence: S. Brambilla

Intensive Care Medicine Experimental 2023, **11** (Suppl 1):001076

Introduction: Mechanically ventilated patients are unable to verbally communicate due to the presence of the endotracheal tube or the tracheostomy, rendering them temporarily “voiceless” [1]. With the emergence of a new paradigm based on light/no sedation, more and more patients are conscious during mechanical ventilation. Communicating with conscious voiceless patients can be complex and frustrating and lead to negative outcomes and experiences for patients, caregivers, and healthcare professionals [2,3].

Objectives: To explore the negative effects of conscious voiceless patients’ inability to communicate verbally in Intensive Care Units (ICUs).

Methods: This qualitative study uses *Interpretive Description* methodology [4]. Semi-structured interviews were conducted with patients, caregivers, nurses, and physicians. Data were collected at two ICUs in Italy from August 2021 to September 2021. Data were analyzed using the *Rapid and Rigorous qualitative data analysis—RADaR* [5].

Results: Forty-three people were interviewed (10 patients, 13 caregivers, 13 nurses, and 7 physicians). Three major themes were identified: “Patient isolation due to lack of interaction”, “Inadequate care due to communication barriers: missed care and overtreatment”, and “Short- and long-term negative psychological and emotional consequences”. The findings indicated that communication difficulties in ICU have negative emotional and psychological consequences for all participants. Most patients reported experiencing fear, anger, irritation, and frustration as a result of continuous communication failures and a lack of understanding of their needs. Such experiences often led patients to isolate themselves and feel disconnected from reality. Healthcare professionals’ inability to understand patients and communicate effectively resulted in feelings of inadequacy and impacted patients’ care negatively. The study found that healthcare professionals often reported that misunderstandings led to incorrect or unnecessary treatments, especially for patients who were agitated and difficult to interact with. Due to the inability to communicate during

the hospitalization, patients declared to suffer from post-traumatic stress symptoms, that persist beyond discharge from ICU. Patients continue to have nightmares and unpleasant memories for months, which negatively affects their daily lives.

Conclusions: This study confirmed that communication plays a crucial role in patients' care and recovery process, while also affecting caregivers' stress and healthcare professionals' frustration. Our findings emphasized the need to develop new communication methods and tools that can facilitate communication with conscious voiceless patients.

References

5. Watkins D. C. (2017) Rapid and Rigorous Qualitative Data Analysis: The "RADaR" Technique for Applied Research. *International Journal of Qualitative Methods* 16: 1–9.
4. Thorne S. *Interpretive Description: Qualitative Research for Applied Practice*. New York: Routledge, 2016
3. Leung C.C., Pun J., Lock G., Slade D., Gomersall C.D., Wong W.T., Joynt G.M. (2018) Exploring the scope of communication content of mechanically ventilated patients. *Journal of Critical Care*, 44, 136–141.
2. Ijssennagger C., Ten Hoorn S., Wijk V., Van den Broek J., Girbes A., Tuinman P. (2018) Caregivers' perceptions towards communication with mechanically ventilated patients: The result of a multicenter study. *Journal of Critical Care*, 48: 263–268.
1. Holm A., Viftrup A., Karlsoon V., Nikolajsen L., Dreyer P. (2020) Nurses' communication with mechanically ventilated patients in the intensive care unit: Umbrella review. *The Journal of Advanced Nursing*, 76: 2909–2920.
- This study received no external funding

Topic: Nursing care and physiotherapy

0001078

Performance of diaphragm ultrasound in monitoring patients with acute respiratory failure

F. Essafi¹, S. Ben othmane¹, K. Benismail¹, I. Talik¹, N. Ben Slimene¹, M. Kaddour¹, T. Merhabene¹

¹intensive care unit, Regional Hospital Zaghouan, Faculty of medicine of Tunis, University Tunis El Manar, Tunisia

Correspondence: F. Essafi

Intensive Care Medicine Experimental 2023, **11 (Suppl 1)**:001078

Introduction: Diaphragmatic Ultrasound (DU) became an additional tool for monitoring critically ill patients admitted for respiratory failure. Its effectiveness in critical care units (ICU) is widely explained in view of it's a non-invasive technique, easy to use and rapidly available at the bedside.

Objectives: to determine performance of diaphragmatic ultrasound by measuring different parametres (diaphragmatic excursion (DE), inspiratory time (IT), and thickening fraction (TF)) in dyspneic patients admitted to ICU with acute respiratory failure.

Methods: We conducted a prospective observational study from January 1st to March 31th 2023, including non intubated patients admitted with acute respiratory failure in ICU of Zaghouan's regional hospital, Tunisia. DU were performed daily by the same operator by mesearing DE, IT and TF. Measurements were made in a sitting position and were averaged from at least three different respiratory cycles. Subsequently obtained ultrasound measurements and clinical parametres were recorded and analyzed. 2 groups were identified: G1 = patients who need only oxygen support until discharge and G2 = use of invasive mechanical ventilation.

Results: A total of 25 consecutive patients were enrolled, with a total of 70 DU. Median age was 60 years [31–90]. Gender ratio was 4. DU was performed overall on noninvasive ventilation (14 on high flow nasal cannula and 11 on high concentration oxygen mask). Acute respiratory failure were respectively secondary to: community acquired pneumonia (n=19), acute pulmonary edema (n=3), pulmonary embolism (n=2) and post-traumatic pulmonary contusion (n=1). Eight patients required invasive ventilation (G 2).

In comparasion the 2 groups characteristics at admission we noted that DE was greater in G1 (1.8 cm [1.10–3.6] vs 1.42 cm [0.8–2.00], $P=0.14$) and IT was longer in group 1 (0.7 s [0.40–1.18] vs 0.55 s [0.35–0.70] with no

significant difference. TF were similar in both groups (25.75% vs 25.50%). In group 1, repeated DU revealed a progressive improvement of the DE and a lengthening of the IT without modification of the TF (Table 1).

Conclusions: In non intubated adult patients admitted with acute respiratory failure, the use of ultrasonographic assesment of DE, IT and TF seems to be feasible, useful and an accurate tool to detect and monitor respiratory function. Further studies are needed to evaluate its impact on clinical practice.

Table 1 (abstract 001078)

Time	Day 1			Day 2			Day 3			Day 4		
	DE cm	IT s	TF %	DE cm	IT s	TF %	DE cm	IT s	TF %	DE cm	IT s	TF %
Group1	1.8	0.70	25.75	1.78	0.73	31	2	0.71	25.7	1.96	0.77	31.5
Group2	1.4	0.55	25.5	-	-	-	-	-	-	-	-	-

DE : Diaphragmatic Excursion ; IT : Inspiratory Time ; TF : Thickening Fraction; Cm:centimeters ; s: second

Topic: Acute respiratory failure and mechanical ventilation

001079

Deep learning in COVID-19 LUS analysis—what can we use for the future?

F. A. Gonzalez¹, J. Leote², M. Sequeira³, R. Varudo⁴, J. Bacariza¹, R. Gomes¹, R. Meireles¹, C. Martins¹, I. Ribeiro¹, L. Krippahl³, R. Bispo³, A. Fernandes¹
¹Serviço de Medicina Intensiva, Hospital Garcia de Orta, Almada, Portugal; ²Intensive Care, Hospital Garcia de Orta, Almada, Portugal; ³Math and Statistics Department, NOVA School of Science and Technology (FCT NOVA), Caparica, Portugal; ⁴Intensive medicine, Hospital Garcia de orta, Almada, France

Correspondence: F.A. Gonzalez

Intensive Care Medicine Experimental 2023, **11 (Suppl 1)**:001079

Introduction: One of the determining factors for the COVID-19 course of treatment is disease severity. Medical imaging, particularly CT scans and X-rays, is frequently used in this assessment. However, these methods have significant downsides. Lung ultrasound has recently gained recognition as an alternative to CT scans and X-rays due to the advantages presented by the exam. Lung ultrasounds are cost-effective, portable, fast, non-invasive, easily repeatable, and do not expose patients to radiation. These aspects are particularly relevant in the context of low-resource healthcare providers.

Objectives: This study proposes a framework for automated severity analysis of COVID-19 lung ultrasounds, intended to detect frames presenting alterations indicative of the disease and provide its subsequent severity classification.

Methods: The process included two approaches for dimensionality reduction. One combined the use of IPCA (Incremental Principal Component Analysis) and UMAP (Uniform Manifold Approximation and Projection), and the other explored the usage of an autoencoder. The lower dimensional representations obtained were then clustered using the K-Means and GMM (Gaussian Mixture Models) algorithms. According to the pipeline, the obtained clusters would be tested on their ability to improve classification performance. However, since such evaluation isn't possible, the process was carried out to demonstrate the concept.

Results: The elected Pleura, B-Lines, Subpleural Consolidation, and Lobar Consolidation classifiers achieved very high evaluation metrics. The Pleura classifier obtained an accuracy of 99% and an average F1-Score of 99%. The B-Lines model attained an accuracy of 96% and an average F1-Score of 96.5%. The Subpleural Consolidation achieved an accuracy of 99% and an average F1-Score of 96.5%. Finally, the Lobar Consolidation classifier achieved perfect metrics, obtaining perfect accuracy and an F1-Score score. These results prove that having pre-selected informative frames makes it possible to train a classifier to reproduce the doctor-attributed scores.

Conclusions: Based on these findings, the study concluded that by having pre-selected informative frames, it's possible to train a classifier to reproduce the doctor-attributed scores, which could ease the learning process of healthcare providers and enable them to obtain expert-level LUS severity assessments even in low-resource situations.

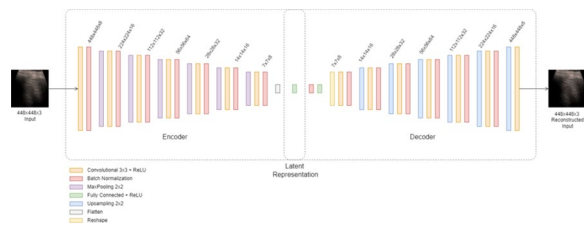

Figure 1 (abstract 001079) .

References

1. M. La Salvia et al. "Deep learning and lung ultrasound for Covid-19 pneumonia detection and severity classification". In: Computers in Biology and Medicine 136 (2021), p. 104742

Topic: Acute respiratory failure and mechanical ventilation

001080

Post intubation laryngotracheal complications: should we routinely look for it?

F. Essafi¹, G. Kharrat², M. Chaabani³, N. Ben Slimene³, K. Benismaïl³, H. Chaâbouni³, S. Essaghayer³, I. Talik³, M. Kaddour³, T. Merhabene³

¹Intensive Care Unit, Regional Hospital Zaghuan, Tunis, Tunisia;

²Otorhinolaryngology Department, Mohamed Tahar Maamouri University Hospital, Faculty of Medicine of Tunis, University of Tunis El Manar, Tunisia;

³Intensive Care Unit, Regional Hospital Zaghuan, Faculty of Medicine of Tunis, University of Tunis El Manar, Tunisia

Correspondence: F. Essafi

Intensive Care Medicine Experimental 2023, **11 (Suppl 1)**:001080

Introduction: Laryngotracheal injuries are a common cause of disability following invasive mechanical ventilation in intensive care units (ICUs). Its incidence is underestimated specially if symptoms occur after discharge from ICU.

Objectives: In this study, we investigated the rate of laryngotracheal complications in patients discharged from ICU after orotracheal intubation (OTI).

Methods: It was a prospective observational follow-up study. Patients who were treated with endotracheal intubation, in the ICU of Zaghuan's regional hospital between November 2021 and November 2022, and who underwent systematic laryngotracheal evaluation using a flexible endoscope after extubation or tracheostomy by otolaryngologists, were included in this study. Clinical data, conditions of intubation as well as the characteristics stay in ICU were recorded.

Results: During the study period, 77 patients were intubated, 43 of them were discharged and 34 died. Thirty-two patients met the inclusion criteria. Mean age was 41.5 years \pm 21 [15–80] and sex ratio was 3.5. Mean SAPS II and APACHE II scores were respectively 34.4 \pm 15.6 and 15.3 \pm 10. Mainly reason for OTI was neurologic distress in 19 patients, respiratory failure in 8 cases and hemodynamic failure in 5 cases. Chronic obstructive pulmonary disease, diabetes mellitus and hypertension were the most frequent comorbidities. Six patients had a medical history of anterior OTI. At admission, OTI was performed with video-laryngoscopy in 11 cases. Immediate complications of IOT were: esophageal intubation (n=4), oral injuries (n=7), two or more failed attempts (n=5) barotrauma (n=1). Mean duration of OTI and ICU length of stay were respectively 10 [1–28] and 20 days [2–84]. Two patients required orotracheal reintubation during hospital stay. Self extubation Occurred in 5 patients. Five patients had undergone tracheostomy and were discharged with.

Otorhinolaryngology examination was performed in patients approximately 3 weeks after extubation. Of the total number of patients examined (n=27), Adverse consequences were found in 11 patients. It was laryngotracheal stenosis in 6 patients, Unilateral vocal fold immobility in 3 cases, laryngeal oedema and tracheomalacia in one case each. only one tracheotomized patient developed tracheal stenosis.

Following factors presenting statistical significance for the development of laryngotracheal injuries: duration of OTI (P=0.004), mal-lampati class III and IV (P=0.008), esophageal intubation (P=0.02), dysphonia developed after extubation (P=0.03), swallowing disorder (P=0.026).

Outcome was favorable in 27 patients, four patients still tracheotomized and only one patient died.

Multivariate analysis showed that duration of OTI \geq 10 days was independent risk factor of laryngotracheal injuries.

Conclusions: Post-intubation laryngotracheal damage was frequent and of poor prognosis despite systematic and early diagnosis. Systematic follow-up after discharge and patient education is essential.

Topic: Acute respiratory failure and mechanical ventilation

001081

Routine monitoring of clonal spread of gram-negative bacteria at the Department of Anaesthesiology, Resuscitation and Intensive Care, University Hospital Olomouc, Czech Republic in the period of March-December 2022

L. Doubravská¹, O. Klementová¹, M. Htoutou Sedlaková², T. Stosová², J. Halek³, R. Rao⁴

¹Department of Anesthesiology, Resuscitation and Intensive Care, University Hospital Olomouc and Palacký University, Olomouc, Czech Republic; ²Department of Microbiology, University Hospital Olomouc and Palacký University, Olomouc, Czech Republic; ³Department of Neonatology, University Hospital Olomouc and Palacký University, Olomouc, Czech Republic; ⁴Department of Microbiology, Palacký University Olomouc, Olomouc, Czech Republic

Correspondence: L. Doubravská

Intensive Care Medicine Experimental 2023, **11 (Suppl 1)**:001081

Introduction: Healthcare-associated infections (HAIs), especially in critically ill, are related to an increased length of hospitalization and significant increases in morbidity, mortality, and economic costs [1]. The incidence of HAIs in the intensive care units (ICU) is reported to be around 22% [2], while a higher proportion of multidrug-resistant (MDR) strains is also documented here [3]. Although most HAIs are of endogenous origin, bacteria can be also transmitted between patients either through droplets, contaminated objects, or the hands of staff and cause HAIs exogenously. Monitoring the spread of identical bacterial clones on wards is an important component in the prevention of HAIs. Early detection of the spread of MDR strains can prevent an infectious outbreak and help to guide antibiotic stewardship.

We present our experience with the McRAPD (Melting curve of Random Amplified Polymorphic DNA) typing technique based on combination of two previously described methods (see also www.typingforlife.cz) at the Department of Anaesthesiology, Resuscitation and Intensive Care (KARIM), University Hospital Olomouc, Czech Republic. We believe the technique has the potential to become a fast and relatively cheap screening tool for identification of suspected bacterial clones and it can prevent the emerging outbreaks. Based on the results obtained, system gaps or non-adherence to the epidemiological regimes can be detected and their correction can be carried out.

Methods: All isolates of gram-negative bacteria obtained as part of routine microbiological diagnostics between March and December 2022 from KARIM patients were identified using MALDI-TOF MS. The first isolate of each species detected from each patient was included in weekly strain typing. Authorized workers from KARIM and the Department of Hospital Hygiene received the results in the form of a regular report.

Results: At KARIM, the most significant pathogens identified were *Klebsiella pneumoniae* and *Klebsiella variicola*. During the 6 months of the project 55% of all cases of *K. pneumoniae/variicola* colonization or infection at KARIM were caused by clonal isolates of these two closely related species, of which in 61% patients multiresistant clones—ESBL+ or AmpC+—were detected.

The highest proportion of clonal spread was found in *Burkholderia multivorans* showing the clonal spread in all cases, but two. Two

clones were identified. One dominant (32 patients) and one minor (7 patients).

Conclusions: During the monitoring a high rate of clonal spread of bacteria was noted at KARIM; e.g. transfer between neighbouring patients, a succession of beds or during transfer of patients between units. The information obtained was used to revise the hygienic-epidemiological regimes and for evaluation of compliance with local guidelines. From our observation it seems that most of the clonal spread goes unnoticed and is not recorded by traditional methods of surveillance.

References

1. Brusselsaers, N., Vogelaers, D., Blot, S.: The rising problem of antimicrobial resistance in the intensive care unit. *Annals of Intensive Care* [online]. 2011, 1 (1) [cit. 2023-04-13]. ISSN 2110-5820. Available from: <https://doi.org/10.1186/2110-5820-1-47>
2. Vincent, J.-L., Sakr, Y., Singer, M., et al.: Prevalence and Outcomes of Infection Among Patients in Intensive Care Units in 2017. *JAMA* [online]. 2020, 323 (15) [cit. 2023-04-13]. ISSN 0098-7484. Available from: <https://doi.org/10.1001/jama.2020.2717>
3. Supported by Ministry of Health, Czech Republic—conceptual development of research organization (FNOL, 00098892)
4. DE Angelis, G., Murthy, A., Beyersmann, J., Harbarth, S.: Estimating the impact of healthcare-associated infections on length of stay and costs. *Clinical Microbiology and Infection* [online]. 2010, 16 (12), 1729-1735 [cit. 2023-04-13]. ISSN 1198743X. Available from: <https://doi.org/10.1111/j.1469-0691.2010.03332.x>

Topic: Infections and prevention

001082

Resting energy expenditure measured by indirect calorimetry—Why should it take precedence over predictive methods

D. C. Gomes¹, M. Nascimento², M. Adao-Serrano³, J. Ribeiro³
¹Intensive Medicine Department and Intensive Medicine University Clinic, Centro Hospitalar Universitário Lisboa Norte-Hospital de Santa Maria and Lisbon University, Lisbon, Portugal; ²Dietetics and Nutrition Department, Centro Hospitalar Universitário Lisboa Norte, Lisbon, Portugal; ³Intensive Medicine Department, Centro Hospitalar Universitário Lisboa Norte-Hospital de Santa Maria, Lisbon, Portugal

Correspondence: D.C. Gomes

Intensive Care Medicine Experimental 2023, **11 (Suppl 1)**:001082

Introduction: Indirect calorimetry (IC) is considered the gold standard for measuring resting energy expenditure (REE) in critically ill patients and has shown to significantly reduce short-term mortality (1). Recent guidelines have therefore strongly recommended its use over predictive methods (2). However, IC has several limitations and is not always feasible. Furthermore, there are no validated protocols for its use, and those existing are guided mainly by expert opinions.

Objectives: We sought to confirm the hypothesis that REE in critically ill patients measured by IC significantly differed from that estimated by predictive methods. We then aimed to identify factors associated with resting energy expenditure variability and with the postulated inaccuracy of predictive methods.

Methods: Retrospective cross-sectional cohort study in a level 3 ICU. All valid IC measurements performed from October 2022 to April 2023 were included. IC was performed in invasively ventilated patients with an expected length of stay > 72 h using Q-NRG + device. Exclusion criteria were $\text{FiO}_2 > 70\%$, $\text{PEEP} > 10$ mmHg, air-trapping, air-leak, ECMO or CRRT. REE was measured by IC and simultaneously estimated using both weight based predictive method (25 kcal/kg/24 h) and Mifflin-St Jeor predictive equation (MSJ). Significant difference between measured and estimated REE was defined as a $\pm 10\%$ difference from IC. Statistical analysis was performed using Qui-square, T-student and Mann-Whitney U tests. Correlations were evaluated using Pearson or Spearman tests.

Results: A total of 45 IC measurements were performed in 29 patients (maximum 3 per patient) and were included in the study. REE estimated by weight based predictive method and MSJ equation was

accurate in only 31.1% and 20% of measurements respectively. Mean measured REE was $20.1 (\pm 6.2)$ Kcal/kg/24 h and was significantly lower in patients with body mass index (BMI) > 30 (17.5 vs 21.4, $p < 0.05$). Measured REE (Kcal/kg/24 h) was positively correlated with day of ICU stay ($r = 0.305$, $p < 0.05$) and negatively correlated with age ($r = -0.484$, $p < 0.001$) and ideal body weight ($r = -0.376$, $p < 0.05$). Weight based predictive method performed worse at estimating REE in obese patients ($p < 0.001$) and in the early phases of ICU stay (6.3th vs 10.4th day of ICU stay, $p = 0.005$). REE estimated by MSJ equation was inaccurate across all tested variables.

Conclusions: IC should be performed to measure REE whenever possible in critically ill patients to guide energy delivery, as recommended by recent guidelines, given the variability and consequent inaccuracy of currently available predictive methods. Our study confirmed that this is particularly relevant in obese patients and in the early phases of critical illness, where estimated REE by weight based predictive method (25 kcal/kg/24 h) performs worse. A valid method for predicting REE in critically ill patients whenever IC is either unfeasible or unavailable is urgently needed.

References

1. (1) Duan JY, Zheng WH, Zhou H, et al. Energy delivery guided by indirect calorimetry in critically ill patients: a systematic review and meta-analysis. *Crit Care*. 2021 Feb 27;25 (1):88
2. (2) Singer P, Blaser AR, Berger MM, et al. ESPEN guideline on clinical nutrition in the intensive care unit. *Clin Nutr*. 2019 Feb;38 (1):48-79

Topic: Metabolism, endocrinology, liver failure and nutrition

001083

Assessment of urinary chloride levels and renal function in resuscitated cardiac arrest patients

S. Zorzi¹, C. Righy Shinotsuka¹, M. Anderloni¹, I. Cavalli¹, F. S. Taccone¹
¹Soins intensifs, ULB Erasme, Anderlecht, Belgium

Correspondence: M. Anderloni

Intensive Care Medicine Experimental 2023, **11 (Suppl 1)**:001083

Introduction: Acute Kidney Injury (AKI) is a clinical condition that develops in more than 40% of patients after cardiac arrest (CA). Few studies have evaluated the role of urinary electrolytes on the recurrence of AKI after CA.

Objectives: To assess whether urinary chloride levels as well as chloride load and balance are associated with the development of AKI in CA patients.

Methods: Retrospective single center study including all comatose adult patients admitted to the Intensive Care Unit (ICU) after cardiac arrest (CA) from January 2007 to December 2014. Inclusion criteria were: age ≥ 18 ; non-traumatic arrest; complete data available on serum and urinary samples for at least 3 days; survival ≥ 24 h after admission. Patients with previous AKI, anuria and on chronic haemodialysis were excluded.

We collected chloride levels on daily serum (SCI) and urinary (UCI) analyses; chloride load (Clload) was calculated by considering the amount of chloride present in the IV fluids and nutrition administered daily to the patient, while chloride balance (Clbalance) was calculated as: $\text{Clload} - \text{Cloutput}$, where $\text{Cloutput} = \text{UCI} \times \text{daily urine output}$. AKI was defined according to the latest AKIN criteria.

Results: Of the 404 eligible patients, 165 met the inclusion criteria and were analyzed. Out of CA occurred in 102 (62%) patients, median time to ROSC was 15 [10-25] minutes, 74 (45%) patients had a shockable initial rhythm. ICU mortality was 48% ($n = 80$). Patients with favorable outcome (CPC 1-2) at 3 months were 75 (45%). 70 patients (42%) developed AKI after a median of 2 [2-3] days since admission; 20 of them (12%) also needed continuous renal replacement therapy. No differences in the daily fluid balance was observed between AKI and non-AKI patients, however, despite a similar Clload, patients with AKI had a lower Cloutput (43 [12-142] vs. 177 [72-292] mmol; $p < 0.001$) and UCI (66 [32-92] vs. 102 [60-137] mEq/L; $p < 0.001$) than others. This resulted in a higher serum chloride levels in the AKI group. These differences were maintained during the first five days of ICU stay.

Conclusions: After CA, AKI occurred in 42% of patients and was associated with a significant difference in renal chloride elimination, already on admission.

References

1. Umbrello M, Formenti P, Chiumello D. Urine Electrolytes in the Intensive Care Unit: From Pathophysiology to Clinical Practice. *Anesth Analg*. 2020 Nov;131 (5):1456–1470. <https://doi.org/10.1213/ANE.0000000000004994>. PMID: 33079869.
2. Kirkegaard H, Grejs AM, Gudbjerg S, Duez C, Jeppesen A, Hassager C, Laitio T, Storm C, Taccone FS, Skrifvars MB, Søreide E. Electrolyte profiles with induced hypothermia: A sub study of a clinical trial evaluating the duration of hypothermia after cardiac arrest. *Acta Anaesthesiol Scand*. 2022 May;66 (5):615–624. <https://doi.org/10.1111/aas.14053>. Epub 2022 Mar 28. PMID: 35218019; PMCID: PMC9311071.
3. Tujjar O, Mineo G, Dell'Anna A, Poyatos-Robles B, Donadello K, Scolletta S, Vincent JL, Taccone FS. Acute kidney injury after cardiac arrest. *Crit Care*. 2015 Apr 17;19 (1):169. <https://doi.org/10.1186/s13054-015-0900-2>. PMID: 25887258; PMCID: PMC4416259.

Topic: Cardiac arrest

001084

Prediction of extubation outcome with cough peak flow: a prospective pilot study in a Tunisian ICU

E. Rachdi¹, I. Sdiri², H. Fitouri³, E. Ibn Elbalad³, F. Jarraya⁴, N. Ben Mrad³, S. Ayed⁵, M. Besbes⁴, A. Jamoussi⁴, J. Ben Khelil⁴

¹Intensive Care, Hôpital Abderrahman Mami, Ariana, Tunisia; ²Intensive Care, Hôpital Abderrahman Mami, Ariana, Tunisia; ³Intensive Care, Hôpital Abderrahman Mami, Ariana, Tunisia; ⁴Intensive Care, Hôpital Abderrahman Mami de pneumo-physiologie, Ariana, Tunisia; ⁵Intensive Care, Abderrahman Mami Hospital, Ariana, Tunisia

Correspondence: E. Rachdi

Intensive Care Medicine Experimental 2023, **11 (Suppl 1)**:001084

Introduction: A crucial step in the transition from mechanical ventilation (MV) to extubation is the successful performance of a spontaneous breathing trial. Successful weaning from MV depends on the patient's ability to cough efficiently. Evaluation of cough strength via objective measures using peak expiratory flow rate is a non-invasive and easily reproducible way that may predict extubation failure.

Objectives: We aimed to predict extubation outcome using an overall model, including cough performance with a cough peak expiratory flow (PEF) measurement assessed by a ventilator flow meter.

Methods: A prospective observational study was conducted from January 2018 to December 2019. After a successful spontaneous breathing trial, subjects were encouraged to cough as strongly as possible before freezing the ventilator screen to assess cough peak measurement. Epidemiological, clinical, biological, and therapeutic data were captured from medical records.

Results: During the study period, we enrolled 43 patients. The mean age was 61.8 ± 15 years and the sex-ratio was 1.88. The mean IGSII and APACHE II scores were respectively 39.5 ± 13.8 and 17.1 ± 6.15 . The most prevalent morbidities were chronic obstructive pulmonary disease (46.5%) and asthma (9.3%). All patients required extubation after a mean duration of MV of 24.4 ± 29 days and mean duration of volume-controlled assisted ventilation mode was 15.9 ± 30 days. The mean number of weaning trials was 1.42 ± 0.7 [1–4] carried out by T-piece weaning trial in 76.9%. Reintubation was noted in 26.8% of cases and the mortality was 16.7%.

The mean of PEF was 63.2 [35–120] l/min and it was correlated with the extubation failure ($p = 0.03$). The mean PEF in the sub group of extubation failure was 53.1 ± 16 . A cut-off value of 45 l/min was identified as a predictive value of extubation failure (sensitivity 96.7%

and 54.5% of specificity and area under the curve ROC = 0.703) (Figure 1).

Conclusions: PEF measured using the flow meter of an ICU ventilator above 45 l/min was able to predict extubation outcome with very high sensibility. External validation of this value is mandatory.

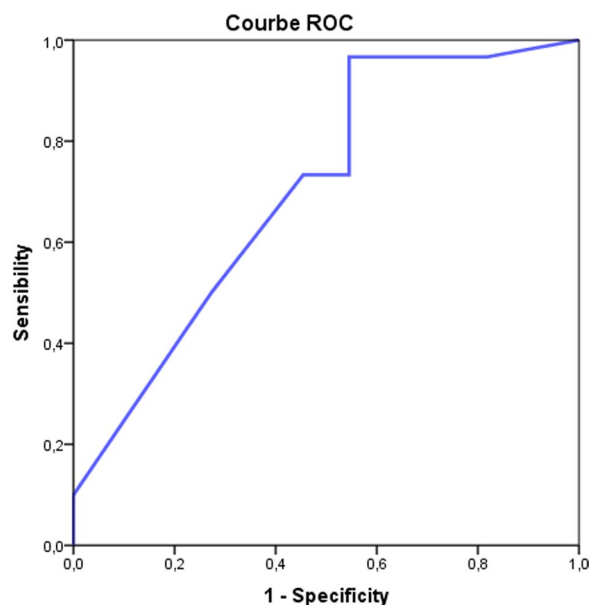

Topic: Acute respiratory failure and mechanical ventilation

001085

Who cares for those who care? Burnout in a tertiary ICU—results from pilot study

G. C. Almeida¹, M. P. Vidal¹, J. E. Mateus¹, I. Santos¹, A. Martinho¹, A. Catarino¹, M. Simões¹, P. Martins¹

¹Intensive Care Unit, Centro Hospitalar e Universitário de Coimbra, Coimbra, Portugal

Correspondence: G.C. Almeida

Intensive Care Medicine Experimental 2023, **11 (Suppl 1)**:001085

Introduction: Continued confrontation with persistent and often silent professional stressors can lead to burnout syndrome, despite ineffective coping attempts. Burnout is a psychological syndrome, characterized by high emotional exhaustion, high depersonalization and low professional achievement, which leads to the erosion of personal, professional and health values. An estimated 15% of working-age adults have a mental disorder at any point in time and the health sector is particularly affected by this.

Individuals with burnout generally have a reduction in the quality of professional performance, with a higher probability of medical error, higher rates of absenteeism, less commitment to the function and to the employer, decreased job satisfaction, higher occurrence of medical leave, greater personal distress and increased interpersonal conflicts involving bosses, colleagues, and family, alcohol and other psychotropic abuse, and lower levels of physical exercise or other healthy lifestyle activities.

Intensive care physicians are a group very susceptible to this disorder, especially due to the complexity and severity of patients, excessive workload, high technical demand, advanced communication skills and management of strong emotions.

Objectives: The aim of this study was to evaluate the levels of burnout among physicians in the intensive care unit of a tertiary hospital in Portugal and to investigate related risk factors and consequences of this syndrome.

Methods: An online questionnaire was sent for voluntary and anonymous completion to all physicians working in the hospital's intensive care unit. Sociodemographic characterization questions, including risk factors for burnout, assessment of the incidence of burnout and professional and personal consequences were asked. The last part of the questions aimed at collecting suggestions and wishes for improvement of mental health in the professionals surveyed. The Maslach Burnout Inventory—Human Services Survey (MBI-HSS) was used in its validated translation for Portuguese as an objective measure in quantifying the prevalence of burnout, consisting of 22 items that involve the three dimensions of this syndrome: emotional exhaustion, disbelief/depersonalization and professional achievement. Each item was classified on a numerical scale between 0 (never) and 6 (every day). For each category, the sums of the scores were calculated and classified as low, intermediate or high risk.

Results: A total of 32 responses were obtained. 6 (18,8%) physicians scored Low Risk in the 3 components, especially specialist physicians (5/6), male and with less time working in this intensive care unit. Only one (3,1%) doctor scored High Risk for the 3 categories of burnout and three for at least two of them. The decrease in professional achievement was the one that most often scored as High Risk in the variables analyzed. In terms of the consequences of burnout, most respondents revealed that working in the intensive care unit has an impact on their health (physical and/or mental), on their family relationships and even on the appearance of medical error in their professional practice.

Conclusions: Among physicians working in this intensive care unit, the prevalence of burnout can be considered relevant. Regular measures to identify, prevent and resolve this syndrome should be implemented to increase the personal and professional fulfillment of these workers and reduce the possible consequences (personal and organizational).

In the future we expect to increase research in this area and make a comparison with other units of other national hospitals.

References

- Maslach, C., Jackson, S. E., & Leiter, M. P. (1996). Maslach burnout inventory manual (3.^a ed). Palo Alto, CA: Consulting Psychologists Press
- Marques Pinto, A., Jesus, E. H., Mendes, A.M.O.C., & Fronteira, I.S.E. (2014). Estudo RN4Cast em Portugal: Work engagement dos enfermeiros. Revista Investigação em Enfermagem, 10 (2), 26–37
- WHO guidelines on mental health at work, ISBN 978–92–4–005305–2 (electronic version), World Health Organization 2022
- Zhang Q, Mu MC, He Y, Cai ZL, Li ZC. Burnout in emergency medicine physicians: A meta-analysis and systematic review. Medicine (Baltimore). 2020 Aug 7;99 (32):e21462

Topic: Critical care organisation, quality management, information systems, outcomes

001086

Predictive values of neutrophil-to-lymphocyte ratio dynamics on mortality in critically ill covid-19 patients

N. Habbachi¹, E. Rachdi², F. Jarraya³, N. Ben Mrad², S. Ayed⁴, M. Besbes³, A. Jamoussi³, J. Ben Khelil³

¹Intensive Care, Hôpital Abderrahman Mami, Ariana, Tunisia; ²Intensive Care, Hôpital Abderrahman Mami, Tunis, Tunisia; ³Intensive Care, Hôpital Abderrahman Mami de pneumo-physiologie, Ariana, Tunisia; ⁴Intensive Care, Abderrahman MAMI Hospital, Ariana, Tunisia

Correspondence: E. Rachdi

Intensive Care Medicine Experimental 2023, **11** (Suppl 1):001086

Introduction: SARS-CoV2 infection is a systemic infection in which the development of a severe form is thought to be related to an imbalance in the innate and adaptive immune response. Neutrophil-to-lymphocyte (NLR) ratio is a strong indicator for the early detection of patients

at risk of developing a severe form. Its contribution in critically ill patients admitted to the ICU remains controversial.

Objectives: The aim of our work was to study the kinetics of NLR and its impact on mortality.

Methods: This was a descriptive, retrospective, single-center study conducted from March 2020 to December 2021. Patients over 18 years old hospitalized with confirmed severe COVID-19 pneumonia were included. Two groups of patients were identified (dead and survivors). A study of NLR kinetics during ICU stay and a comparison between the two groups were performed.

Results: The study included 460 patients with 198 survivors. Dead patients (n = 262) were older, had more comorbidities and more severe clinical presentation of the disease. The mean time to admission to the ICU was comparable and the medical treatment was standardized.

The NLR was significantly higher in the dead group at almost every control point (Figure 1). In the survivor group, the NLR decreased since admission. In the dead group, the elevation of NLR at the beginning of the stay was significantly higher with a peak at Day10. The comparison between the two groups identified four factors associated with mortality. These were NLR D0, NLR D3-5, NLR D10 and Delta NLR D3-5. On multivariate analysis, only an NLR at D10 ≥ 8 (OR = 10.14; CI95% [5.46–18.84]; $p < 10^{-3}$) was independently associated with an increased risk of death.

Conclusions: Our study confirm that baseline NLR and its kinetics are surrogate marker of increased mortality in critically ill COVID-19 patients.

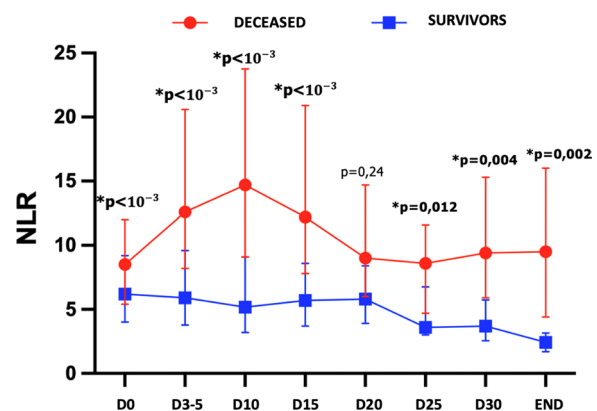

Topic: Haematologic-oncologic issues in the ICU

001087

Assessment of urinary chloride levels on renal function during sepsis

I. Cavalli¹, C. Righy Shinotsuka¹, M. Anderloni¹, S. Zorzi¹, F. S. Taccone¹
¹Soins intensifs, ULB Erasme, Anderlecht, Belgium

Correspondence: M. Anderloni

Intensive Care Medicine Experimental 2023, **11** (Suppl 1):001087

Introduction: Sepsis is the most common trigger of severe acute kidney injury (AKI) in critically ill patients. Few data are available on the changes of urinary chloride and their association with AKI in septic patients.

Objectives: To assess whether chloride serum and urinary levels as well as chloride load and balance are associated with the development of AKI in septic patients.

Methods: Retrospective analysis of an institutional database including all patients admitted to the Intensive Care Unit (ICU) for sepsis and septic shock from January 2011 to June 2015. Inclusion criteria were length of stay in the ICU > 48 h and complete data available on serum and urinary samples for at least for 2 days. Patients were excluded if

they had anuria on ICU admission, continuous bladder irrigation, if they were on haemodialysis (chronic or of recent onset) and if they were kidney transplanted. We collected chloride levels on daily serum (SCI) and urinary (UCI) analyses; chloride load (Clload) was calculated by considering the amount of chloride present in the IV fluids and nutrition administered daily to the patient, while chloride balance (Clbalance) was calculated as: Clload—Cloutput, where Cloutput is UCI × daily urine output. UCI was measured on 24-h urinary collection. AKI was defined according to the latest AKIN criteria.

Results: 339 eligible patients met the inclusion criteria. Median SOFA score on ICU admission was 7 [5–10]; ICU mortality was 29% (n = 99). 298 patients (88%) developed AKI after a median of 0 [0–0] days since admission; 81 of them (24%) also needed continuous renal replacement therapy. No significant difference in fluid balance over the first five days was observed between AKI and non-AKI groups; despite a similar Clload on admission, patients with AKI had a lower Cloutput (32 [12–75] vs. 80 [38–158] mmol; $p < 0.001$) and lower UCI (34 [20–60] vs. 54 [23–91] mEq/L; $p = 0.004$) than patients without AKI, resulting in higher serum chloride levels. These findings were observed during the first five days of ICU stay.

Conclusions: AKI occurred in almost 90% of septic patients; urinary excretion of chloride is reduced in these patients.

References

1. Ronco C, Bellomo R, Kellum JA. Acute kidney injury. *Lancet*. 2019 Nov 23;394 (10212):1949–1964. [https://doi.org/10.1016/S0140-6736\(19\)32563-2](https://doi.org/10.1016/S0140-6736(19)32563-2). PMID: 31777389.
2. Umbrello M, Formenti P, Chiumello D. Urine Electrolytes in the Intensive Care Unit: From Pathophysiology to Clinical Practice. *Anesth Analg*. 2020 Nov;131 (5):1456–1470. <https://doi.org/10.1213/ANE.0000000000004994>. PMID: 33079869.
3. Bellomo R, Kellum JA, Ronco C, Wald R, Martensson J, Maiden M, Bagshaw SM, Glassford NJ, Lankadeva Y, Vaara ST, Schneider A. Acute kidney injury in sepsis. *Intensive Care Med*. 2017 Jun;43 (6):816–828. <https://doi.org/10.1007/s00134-017-4755-7>. Epub 2017 Mar 31. PMID: 28364303.

Topic: Sepsis

001088

Early predictors of favorable neurological outcome in out-of-hospital cardiac arrest: a prospective observational study

V. Piazza¹, M. Pozzi², G. Carenini¹, P. Calzavacca², L. Galbiati², M. Scanziani², V. Meroni², L. Gandini², I. Mariani², E. Rezoagli¹, L. Avalli², G. Foti¹

¹School of Medicine and Surgery, University of Milano-Bicocca, Monza, Italy; ²Department of Emergency and Intensive Care, Ospedale San Gerardo, Monza, Italy

Correspondence: V. Piazza

Intensive Care Medicine Experimental 2023, **11** (Suppl 1):001088

Introduction: Outcome prediction after out-of-hospital cardiac arrest (OHCA) is difficult and identification of risk factors associated with poor outcome could help clinicians in making decisions about post-resuscitation management. Among these, early predictors, and in particular those eventually available before recommended neuroprognostication indexes, may help to identify patients with the highest probability of poor outcome in early course of post-resuscitation care^{1,2}.

Objectives: We aimed to examine predictive ability of demographical, clinical, and peri-arrest variables with the adjunct of data from Blood Gas Analysis (BGA) taken in the first 24 h after OHCA, to find out risk factors of poor outcome before starting of neuroprognostication.

Methods: A prospective observational study was conducted from January 2019 to December 2022 in a large academic hospital, including all consecutive adult patients (> 18 years old) admitted to our Intensive Care Unit (ICU) with diagnosis of OHCA. Demographical and clinical variables regarding pre-existing conditions and medications, and data from BGA at Emergency Department (ED) arrival, ICU admission and at 24 h were collected. Outcome was evaluated at ICU discharge by Cerebral Performance Category (CPC) scale (range 1–5). A CPC score ≥ 3

was considered as poor outcome. Univariate logistic regression was used to examine the association between ICU outcome and different demographical and early clinical variables. Clinical reasonable variables were tested into a multivariable logistic regression. Independent predictors of the multivariable models were considered in the presence of a p -value < 0.05 .

Results: 90 patients were enrolled in the study period. Survival rate was 44.44%, and 25 patients had a good neurological outcome at discharge (27.78% of OHCA). ICU outcome was associated with low flow time ($p = 0.03$), mechanical CPR ($p = 0.03$), rhythm of presentation ($p = 0.007$), ACC location ($p = 0.022$), chronic therapy with P2Y12-inhibitors ($p = 0.023$) and ACE-inhibitors ($p = 0.032$), serum lactate at the ED presentation ($p < 0.001$), at ICU admission ($p = 0.048$) and in the first ICU day ($p < 0.001$). In a multivariable analysis taking into account age, biological gender, low-flow time and lactate levels at the ED presentation, only low-flow time was independently associated to poor outcome (OR 0.96 for each minute of low flow time, IC95% 0.92–0.99). **Figure 1 shows adjusted probability of good outcome for increasing low-flow time.

Conclusions: In this prospective evaluation, low-flow time was an independent predictor of poor ICU outcome, in accordance with international literature, with no association found with age and gender. We found a univariate association between outcome and BGA variables collected in the first 24 h from cardiac arrest, as is reported in previous studies. The independent predictive value of lactate levels must be evaluated in a larger population.

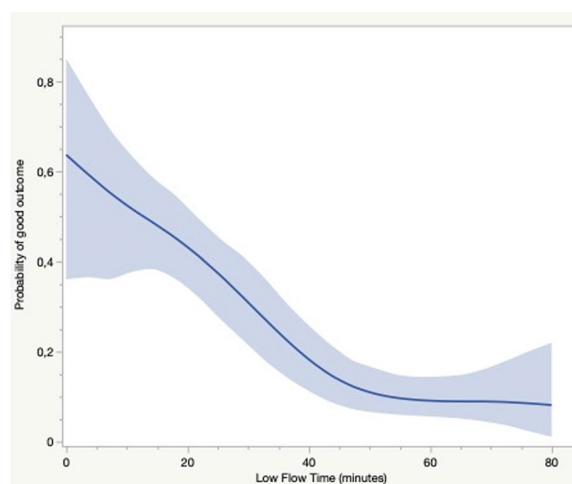

Figure 1 (abstract 001088) Adjusted probability of good outcome according to low flow time

References

1. Lotfi A, Klein LW, Hira RS, Mallidi J, Mehran R, Messenger JC, Pinto DS, Mooney MR, Rab T, Yannopoulos D, van Diepen S. SCAI expert consensus statement on out of hospital cardiac arrest. *Catheter Cardiovasc Interv*. 2020 Oct 1;96 (4):844–861. <https://doi.org/10.1002/ccd.28990>. Epub 2020 Jun 20
2. Perkins GD, Jacobs IG, Nadkarni VM, Berg RA, Bhanji F, Biarent D, Bossaert LL, Brett SJ, Chamberlain D, de Caen AR, Deakin CD, Finn JC, Gräsner JT, Hazinski MF, Iwami T, Koster RW, Lim SH, Huei-Ming Ma M, McNally BF, Morley PT, Morrison LJ, Monsieurs KG, Montgomery W, Nichol G, Okada K, Eng Hock Ong M, Travers AH, Nolan JP; Utstein Collaborators. Cardiac arrest and cardiopulmonary resuscitation outcome reports: update of the Utstein Resuscitation Registry Templates for Out-of-Hospital Cardiac Arrest: a statement for healthcare professionals from a task force of the International Liaison Committee on Resuscitation (American Heart Association, European Resuscitation Council, Australian and New Zealand Council on Resuscitation, Heart and Stroke Foundation of Canada, InterAmerican Heart Foundation, Resuscitation Council of

Southern Africa, Resuscitation Council of Asia); and the American Heart Association Emergency Cardiovascular Care Committee and the Council on Cardiopulmonary, Critical Care, Perioperative and Resuscitation. Circulation. 2015 Sep 29;132 (13):1286–300

Topic: Cardiac arrest

001089

Dynamic arterial elastance predicts volume responsiveness in patients with hemodynamic instability and irregular heart rhythm: results from a prospective study

P. Ostadal¹, A. Krüger¹, D. Vondrakova¹, M. Janotka¹, J. Naar¹, P. Neužil¹
¹Cardiovascular center, Na Homolce Hospital, Prague, Czech Republic

Correspondence: P. Ostadal

Intensive Care Medicine Experimental 2023, **11 (Suppl 1)**:001089

Introduction: Prediction of volume responsiveness in mechanically ventilated patients with hemodynamic instability remains challenging especially in conditions where usability of standard dynamic tests is significantly limited due to irregular heart rhythm.

Objectives: The aim of our study was to assess relationship between the values of dynamic arterial elastance (Eadyn) and hemodynamic response to leg raise test in patients with circulatory shock and irregular heart rhythm.

Methods: Mechanically ventilated patients with combined cardiogenic and septic shock treated with vasopressors (norepinephrine and/or vasopressin) and inotropes (dobutamine and/or milrinone) and irregular heart rhythm were eligible for the study. Pulse pressure variation (PPV), stroke volume variation (SVV), Eadyn, cardiac output (CO), stroke volume (SV) and mean arterial pressure (MAP) were continuously monitored from pulse wave analysis. The values of PPV, SVV and Eadyn were recorded before standard passive leg raise test (LRT) and analyzed for correlation with the change (after LRT—before LRT) in CO (dCO), SV (dSV) and MAP (dMAP).

Results: Eighteen hemodynamically unstable patients were enrolled (mean age 63 years, females 6/18). Irregular heart rhythm was caused by atrial fibrillation (12/18) or frequent premature complexes (6/18). Admission diagnoses were cardiac arrest (8/18), acute myocardial infarction (4/18), aortic stenosis (2/18), pulmonary embolism (2/18), COVID-19 (1/18), and cardiac tamponade (1/18). All were treated with inotropes and vasopressors. A significant correlation was observed between Eadyn and dCO (Spearman $r=0.691$, $P=0.004$) as well as between Eadyn and dSV ($r=0.734$, $P=0.002$) but not between Eadyn and dMAP ($P=0.437$). The values of PPV and SVV did not correlate with any of the changes.

Conclusions: Our results indicate that Eadyn could be used as a predictor of volume responsiveness in mechanically ventilated patients with circulatory shock and irregular heart rhythm.

References

1. This study was supported by an Institutional grant MH CZ-DRO (Nemocnice Na Homolce—NNH, 00023884) IG230501.

Topic: Cardiovascular issues in ICU

001090

Lymphocyte kinetics in critically ill covid-19 patients

E. Rachdi¹, N. Habbachi², F. Jarraya³, S. Ayed⁴, N. Ben Mrad⁵, M. Besbes³, A. Jamoussi³, J. Ben Khelil³

¹Intensive Care, Hôpital Abderrahman Mami, Tunis, France; ²Intensive Care, Hôpital Abderrahman Mami, Ariana, Tunisia; ³Intensive Care, Hôpital Abderrahman Mami de pneumo-phtisiologie, Ariana, Tunisia; ⁴Intensive Care, Abderrahman Mami Hospital, Ariana, Tunisia; ⁵Intensive Care, Hôpital Abderrahman Mami, Tunis, Tunisia

Correspondence: E. Rachdi

Intensive Care Medicine Experimental 2023, **11 (Suppl 1)**:001090

Introduction: SARS-CoV2 infection is a systemic infection in which the development of a severe form is thought to be related to an imbalance in the innate and adaptive immune response. Lymphopenia is a cardinal hematological finding and an indicator for the early detection of patients at risk of developing a severe form.

Objectives: The aim of our work was to study the kinetics of lymphocytes and its impact on mortality in critically ill patients.

Methods: This was a descriptive, retrospective, single-center, prognostic study conducted from March 2020 to December 2021. Patients over 18 years old hospitalized with confirmed severe COVID-19 pneumonia were included. Two groups of patients were identified (dead and survivors). A study of lymphocyte kinetics during the ICU stay and an analysis of both groups were performed. Lymphopenia was defined as a lymphocyte count less than 1500/mm³.

Results: The study included 460 patients with 198 survivors. Dead patients ($n=262$) were older, had more comorbidities and a more severe clinical presentation of the disease. The mean time to admission to the ICU was comparable and the medical treatment was standardized.

The lymphocyte count at admission was comparable in both groups. Lymphopenia was present in both groups. Throughout the ICU stay, dead patients had a lower lymphocyte count compared to the survivors, but the difference was significant only at D30 (2300 [1370–2830] /mm³ in the survivors' group versus 1315 [762–1722] /mm³ in the dead group with $p=0.002$).

Lymphocyte kinetics were comparable between the two groups with a progressive and less important increase in the dead group (Figure 1). A greater regeneration of lymphocytes in the survive group was observed between D25 and D30 with $p=0.037$.

Conclusions: Our study did not show any association between lymphocytes kinetics and mortality in critically ill COVID-19 patients. However, it suggests that lymphocyte regeneration may reflect a favorable disease course.

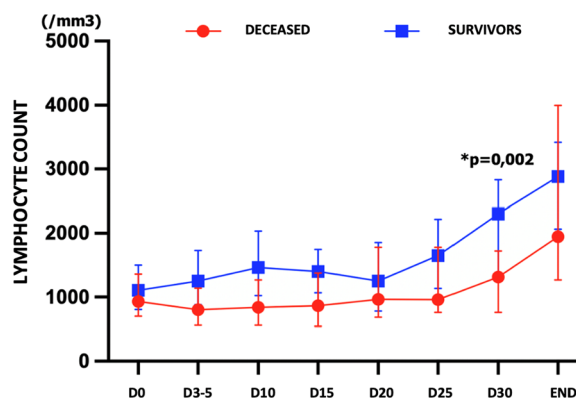

Topic: Haematologic-oncologic issues in the ICU

001091

Higher and lower demand for critical care resources: long-term impact on the quality of life of COVID-19 survivors

A. Cuadra-Calahorra¹, G. Morales Varas¹, M. Márquez Doblas², P. Rodríguez Villamizar¹, G. Alonso Gómez¹, M. Vecino Montoya¹, P. Carneiro Pereda³, J. Guerra Cuervo⁴, I. Gómez Cano⁴

¹Intensive Care Department, Hospital General Universitario de Toledo, Toledo, Spain; ²Intensive Care Department, Urgencias Hospital Universitario de Toledo, Toledo, Spain; ³Intensive Care Department, Hospital Universitario de Toledo, Toledo, Spain; ⁴Intensive Care Department, Hospital General Universitario de Toledo, Toledo, Spain

Correspondence: A. Cuadra-Calahorra

Intensive Care Medicine Experimental 2023, **11 (Suppl 1)**:001091

Introduction: The coronavirus disease (COVID-19) pandemic has been a real challenge for resource management in intensive care units (ICU). The burden of critical care experienced in several periods of the pandemic may influence the long-term outcomes of the survivors.

Objectives: To analyze whether the care overload suffered in the first waves of the COVID-19 pandemic had an impact on the quality of life of patients admitted to a critical care unit compared to those who were admitted in waves with less care overload.

Methods: This cross-sectional study among critical ill COVID-19 survivors at 1-year of intensive care unit (ICU) discharge, who were admitted during the periods of higher demand (HD) (1st, 2nd, 3rd wave of the pandemic) and lowest demand (LD) (4th, 5th and 6th wave) for critical care resources (CCR). Quality of life (QoL) was assessed by the EQ-5D-5L tool and the euroQoL visual analog scale through phone-based questionnaires. Mental health was assessed through medical records and a validated instrument was used: the Post-Traumatic Stress Disorder (PTSD) Checklist-5 (PCL-5), based on the Diagnostic and Statistical Manual of Mental Disorders (DSM-5) for screening PTSD using a cut-point score of 31–33. Categorical variables are expressed as counts and percentages and were compared using the χ^2 test and Fisher test; continuous variables are expressed as medians and interquartile range (IQR) and were compared using Mann–Whitney U test. A two-sided level of significance of 5% was used. Data analysis was performed using STATA version 13® (Stata-Corp LCC).

Results: A total of 270 patients 1-year after ICU discharge were analyzed. The majority were men (69.01%) with no differences between groups, the median age was higher in the group of HD-CCR (62 [53–68] vs 54 [44,62] years old; $p < 0.001$). Patients in the period of HD-CCR had a higher PTSD prevalence (12,56 vs 1,41%; $p = 0.036$) with a higher Score PCL-5 (8 [2–19] pts vs 6 [0–14]; $p < 0.001$). The consumption of psychopharmacological drugs during the month prior to the interview was similar in both groups. There were no differences in the perception of their health status as estimated by the EuroQoL Thermometer (70 [50–90] vs 75 [60–90]; $p = 0.249$) neither did the level sum score (LSS) (15 [5–40] vs 10 [0–30]; $p = 0.055$). The EQ-5D-5L questionnaire showed that patients from HD-CCR period had greater problems for self-care (31,7 vs 15,49%; $p = 0.048$) and for the development of usual activities (50,25 vs 32,39%; $p = 0.039$); there were no differences in mobility problems, pain/discomfort and anxiety/depression.

Conclusions: Periods of higher demand for critical care resources had significantly greater impact on the development of PTSD, self-care and the performance of usual activities problems, among critical ill COVID-19 survivors at 1-year after ICU discharge. However, the ICU burden did not impact the perception of health status or in the disease severity index estimated by LSS.

Quality of life	HD CCR n=199 (73,7%)	LD CCR n=71 (26,3%)	Total n=270	p=
Mobility, %				
Have no problems to walk	96/199 (48,24)	41/71 (57,45)	137/270 (50,74)	
Have mild problems to walk	32/199 (16,08)	11/71 (15,49)	43/270 (15,93)	
Have moderate problems to walk	43/199 (21,61)	13/71 (18,31)	56/270 (20,74)	
Have severe problems to walk	19/199 (9,55)	5/71 (7,04)	24/270 (8,89)	
Cannot walk / have to stay in bed	9/199 (4,52)	1/71 (1,41)	10/270 (3,70)	0.565
Personal care, %				
Have no problems to clean and to dress up myself	136/199 (68,34)	60/71 (84,51)	196/270 (72,59)	
Have mild problems to clean and to dress up myself	22/199 (11,06)	7/71 (9,86)	29/270 (10,74)	
Have moderate problems to clean and to dress up myself	21/199 (10,55)	3/71 (4,23)	24/270 (8,89)	
Have severe problems to clean and to dress up myself	9/199 (4,52)	1/71 (1,41)	10/270 (3,7)	
Unable to clean or dress up myself	11/199 (5,53)	0	11/270 (4,07)	0.048
Daily activities, %				
Have no problems doing daily activities	99/199 (49,75)	48/71 (67,61)	147/270 (54,44)	
Have mild problems doing daily activities	37/199 (18,59)	13/71 (18,31)	50/270 (18,52)	
Have moderate problems doing daily activities	31/199 (15,58)	7/71 (9,86)	38/270 (14,07)	
Have severe problems for doing daily activities	16/199 (8,04)	2/71 (2,82)	18/270 (6,67)	
Unable to do daily activities	16/199 (8,04)	1/71 (1,41)	17/270 (6,30)	0.039
Pain/discomfort %				
Have no problems of pain or discomfort	80/199 (40,20)	31/71 (43,66)	111/270 (41,11)	
Have mild problems of pain or discomfort	43/199 (21,61)	17/71 (23,94)	60/270 (22,22)	
Have moderate problems of pain or discomfort	40/199 (20,10)	11/71 (15,49)	51/270 (18,89)	
Have severe problems of pain or discomfort	25/199 (12,56)	9/71 (12,68)	34/270 (12,59)	
Have extreme problems of pain or discomfort	11/199 (5,53)	3/71 (4,23)	14/270 (5,19)	0.904
Anxiety/Depression %				
Have no problems of anxiety or depression	111/199 (55,78)	41/71 (57,75)	152/270 (56,3)	
Have mild problems of anxiety or depression	26/199 (13,07)	11/71 (15,49)	37/270 (13,7)	
Have moderate problems of anxiety or depression	31/199 (15,58)	8/71 (11,27)	39/270 (14,44)	
Have severe problems of anxiety or depression	22/199 (11,06)	8/71 (11,27)	30/270 (11,11)	
Have extreme problems of anxiety or depression	9/199 (4,52)	3/71 (4,23)	12/270 (4,44)	0.918
EuroQoL, thermometer, median (RIQ)	70 (50-90)	75 (60-90)	70 (50-90)	0.249
Severity index, median (RIQ)	15 (5-40)	10 (0-30)	15 (5-35)	0.055

Figure 2 (abstract 001091) Results. Quality of life measurement

Topic: Critical care organisation, quality management, information systems, outcomes

001092

Which risk factors affect hospital length of stay in COVID-19 patients after a multiple statistical inference approach?

F. A. Gonzalez¹, J. Leote², F. Sousa³, J. Bacariza¹, R. Gomes¹, R. Varudo⁴, I. Ribeiro¹, C. Martins¹, R. Meireles¹, A. Fernandes¹, L. Krippah³, R. Bispo³
¹Serviço de Medicina Intensiva, Hospital Garcia de Orta, Almada, Portugal; ²Intensive Care, Hospital Garcia de Orta, Almada, Portugal; ³Math and Statistics Department, NOVA School of Science and Technology (FCT NOVA), Caparica, Portugal; ⁴Intensive Medicine, Hospital Garcia de Orta, Almada, France

Correspondence: F.A. Gonzalez

Intensive Care Medicine Experimental 2023, 11 (Suppl 1):001092

Introduction: COVID-19 is a rapidly expanding disease caused by the virus SARS-COV-2. As a new disease, its poor understanding can result in delayed identification and treatment. Thus, during the COVID-19 pandemic, it is crucial to understand the factors that may influence the Length of Stay (LOS) for hospitalized patients. The hospital LOS refers to the number of days a patient stays there. In addition, comprehending those factors is important for planning the allocation of medical resources.

Objectives: To study the risk factors that influence the hospital LOS variation for COVID-19 patients using multiple statistical approaches.

Methods: This study has access to information on 50 COVID-19 patients after being hospitalised in the Hospital Garcia da Orta in Almada. The data set contains 45 explanatory variables, including information about patients' demographic characteristics and clinical indicators regarding inflammation and renal, liver, heart and lung

Characteristics	HD CCR n=199 (73,7%)	LD CCR n=71 (26,3%)	Total n=	p=
1-year mortality, %	20/283 (7,07)	4/105 (3,81)	24/388 (6,19)	0.237
ICU stay, median (IQR), days	14 (8-29)	12 (5-28)	14 (7-28)	0.305
Hospital stay, median (RIQ), days	30 (20-47)	31 (14-47)	30 (19-47)	0.272
Women, %	79/199 (39,7)	22/71 (30,99)	101/270 (37,41)	
Men, %	120/199 (60,3)	49/71 (69,01)	169/270 (62,59)	0.193
Age, median (IQR), years	62 (53-68)	54 (44-62)	60 (49-67)	0.000
Charlson, median (RIQ), points	2 (1-3)	1 (0-3)	2 (1-3)	0.014
PCL-5 score, median (RIQ), days	8 (2-19)	6 (0-14)	8 (2-17)	0.000
PTSD, SI, %	25/199 (12,56)	1/71 (1,41)	26/270 (9,63)	0.036
Psychoactive drugs prior to ICU admission, %	43/197 (21,83)	13/71 (18,31)	56/268 (20,9)	0.532
Psychoactive drugs the month before the interview, %	84/197 (42,64)	28/71 (39,44)	112/268 (41,79)	0.639

Figure 1 (abstract 001091) Results

functions. A survival analysis approach is used to achieve that goal since, when modelling the LOS, the observations may be censored. Two survival analysis approaches are employed, the semiparametric approach, where Cox proportional hazards model is used, and the parametric approach, by fitting an Accelerated Failure Time (AFT) model.

Results: Results show that having hypertension and higher levels of haemoglobin, neutrophils, fibrinogen, D-dimer, atrial fibrillation, HCO₃, and troponin lead to less time in the hospital. In addition, patients with DM, AKI, and having higher levels of INR, pH, pCO₂, FiO₂ and FC tend to stay longer in the hospital. The comparison between statistical approaches was done, analysing the variables that are relevant for each model and which ones are kept in all of them, and plotting the survival curves of each model for both approaches by adding the KM estimate. The variables pCO₂, FiO₂ and FC were the only ones to be kept in all models. Thus, it is possible to believe those indicators are strongly related to the LOS variation.

Conclusions: To our knowledge, the effect of the levels of pCO₂, FiO₂ and heart rate on LOS variation never appeared in the literature. Understanding the risk factors associated with the variation of the hospital LOS will provide useful information for planning the allocation of medical resources and improving hospital management and patient quality of care.

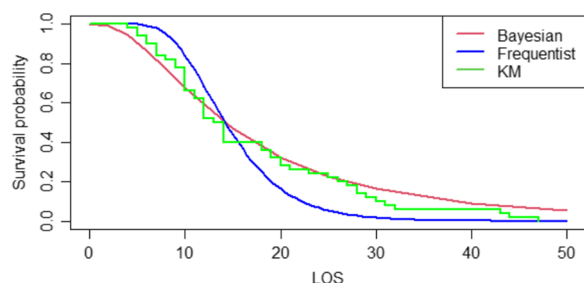

Best model for each approach.; Frequentist approach is the lognormal model; Bayesian approach is the log-logistic model.

References

1. M. Atlam et al. "Coronavirus disease 2019 (COVID-19): survival analysis using deep learning and Cox regression model". In: Pattern Analysis and Applications 24 (3 Aug. 2021), pp. 993–1005. issn: 1433755X.

Topic: Data Science

001093

Prognostic evaluation of management of cardiac arrest carried out by intensivists (Medical Intensive Care Unit) according to the first documented rhythm in a second-level University Hospital

S. Martínez Alvarez¹, J. L. Martínez Melgar², E. Moreno Lopez³, JI. Cenoz Osinaga², F. Eiras Abalde², P. Posada Gonzalez²

¹Cardiology Department, Complejo Hospitalario Universitario de Pontevedra, Pontevedra, Spain; ²Intensive Care Unit, Complejo Hospitalario Universitario De Pontevedra, Pontevedra, Spain; ³Anesthesia and Perioperative Care, Complejo Hospitalario Universitario de Ferrol, Ferrol, Spain

Correspondence: E. Moreno Lopez

Intensive Care Medicine Experimental 2023, **11** (Suppl 1):001093

Introduction: Presenting rhythm has been widely reported as a prognostic factor in cardiac arrest, having the non-shockable rhythm a worst survival prognosis.

Objectives: Primary objective: to know the prevalence of cardiac arrest in Pontevedra and O Salnés Health Area.

Secondary objective: to analyze possible differences, in terms of vital prognosis, related to the first documented rhythm.

Methods: Descriptive and retrospective study carried out between January 2017 and December 2022 in patients with cardiac arrest whose cardiopulmonary resuscitation (CPR) was performed by intensivists from Hospital Universitario in Pontevedra. All emergency calls for cardiac arrest during this period were included. Patients whose stay in ICU was considered as non-beneficial, due to their previous serious clinical condition or preexisting comorbidities, were excluded.

Results: Over the six-year period, 168 cardiac arrests were collected. The first documented rhythm was non-shockable in 112 of them (66.7%). Of those, 63% presented asystole and 42.8% pulseless electrical activity (PEA). Shockable rhythm was documented in 46 patients (27.4%), being ventricular fibrillation (84.8%) more frequently found than pulseless ventricular tachycardia. In patients with non-shockable rhythm, the most common underlying cause of cardiac arrest was respiratory, whilst cardiac was the main cause in patients presenting shockable rhythm. Survival rate was higher among patients with shockable rhythm (52.2% at hospital discharge and 47.9% at 12-month follow-up) compared to those presenting non-shockable rhythm (34.8% at hospital discharge and 33.6% at 12-month follow-up). Of all variables investigated as prognostic factors, elevated lactate level was the only one to be found as statistically significant predictor for mortality (p-value = 0.011, OR 3.75 and CI 95% (1.92–5.58) in non-shockable rhythms and p-value = 0.001, OR 3.06, CI 95% (1.71–4.42) in shockable).

Conclusions: In our area, data were similar to the previously described in literature, with mortality rate as 3.75 times higher (1.92–5.58) in non-shockable rhythms and 3.06 times (1.71–4.42) in shockable.

Topic: Cardiac arrest

001094

Concordance and correlation of a continuous non-invasive hemodynamic monitor compared to thermodilution method on monitoring of hemodynamic parameters in post coronary artery bypass surgery

M. R. A. Lacanin¹, C. J. Tortosa¹, A. D. Tan¹, M. Patricio¹, B. B. Albano¹

¹Department of Ambulatory, Emergency and Critical Care Medicine, Philippine Heart Center, Quezon City, Philippines

Correspondence: M.R.A. Lacanin

Intensive Care Medicine Experimental 2023, **11** (Suppl 1):001094

Introduction: Coronary artery bypass surgery is associated with significant hemodynamic variability. Accurate and continuous hemodynamic monitoring is recommended for early diagnosis of changes in organ function and timely intervention.

Objectives: The purpose of this study is to evaluate the correlation of the measured hemodynamic parameters obtained from estimated continuous Cardiac Output (esCCO) based on pulse wave transit time and thermodilution in post coronary artery bypass patients.

Methods: This prospective cross-sectional study included 39 patients who had coronary artery bypass surgery. Reference hemodynamic parameters were obtained from intermittent bolus thermodilution using a pulmonary artery catheter at 3 different time points post-operatively. Simultaneous hemodynamic measurement was obtained using the esCCO monitoring system. Using arterial blood gas from the arterial line and venous blood gas from the pulmonary artery, and indirect Fick method of hemodynamic monitoring was also performed. Differences with the absolute values of the hemodynamic parameters obtained from the 3 methods were compared. Bland-Altman analysis was used to determine bias and the limit of agreement.

Results: The absolute values of hemodynamic parameters from the different methods differ significantly at each time point. When compared to the gold standard thermodilution, esCCO measurements were significantly higher at all time intervals, while SVR was lower. Between between esCCO and TD CO the bias was -1.98 L/min, and the SD bias was ± 1.83 L/min; 95% CI of the limits of agreement ranges from -5.56 L/min to 1.59 L/min.

Conclusions: The absolute values of hemodynamic parameters obtained from the non-invasive esCCO did not correlate accurately to the measured parameters from the gold standard thermodilution.

Variations in SVR, which are common in patients after coronary artery bypass grafting, appear to influence the accuracy of esCCO, as seen by wide ranges of agreement between esCCO and TD. Further refinement of this technology is warranted.

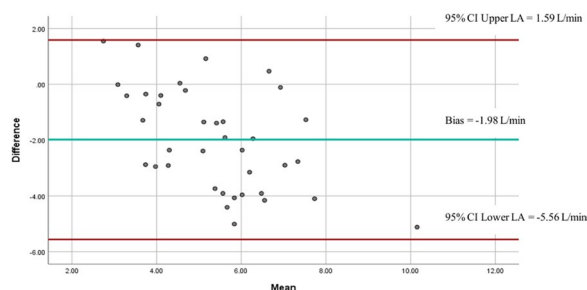

Bland-Altman plot for repeated measurements between cardiac output (CO) measurements obtained with estimated continuous cardiac output (esCCO) and thermodilution cardiac output. The green lines correspond to the mean difference (bias), the red lines correspond to 95% confidence interval of the upper and lower Limits of agreement.

References

3. Yamada T, Tsutsui M, Sugo Y, Sato T, Akazawa T, Sato N, Yamashita K, Ishihara H, and Takeda J, 2012. Multicenter study verifying a method of noninvasive continuous cardiac output measurement using pulse wave transit time: a comparison with intermittent bolus thermodilution cardiac output. *Anesthesia & Analgesia*, 115 (1), pp.82–87.
1. Fujimoto Y, Suehiro K, Mukai A, Nishikawa K. Perioperative Cardiac Output Monitoring Utilizing Non-pulse Contour Methods. *Current Anesthesiology Reports*. 2017 Dec 1;7 (4):399–409.
2. Smetkin AA, Hussain A, Fot EV, Zakharov VI, Izotova NN, Yudina AS, Dityateva ZA, Gromova YV, Kuzkov VV, Bjertnæs LJ, Kirov MY. Estimated continuous cardiac output based on pulse wave transit time in off-pump coronary artery bypass grafting: a comparison with transpulmonary thermodilution. *J Clin Monit Comput*. Epub 2016 Mar 7. PMID: 26951494.

Topic: Perioperative care

Analysis of in-hospital cardiac arrests admitted to an intensive care unit (Medical ICU) in a second-level University Hospital

S. Martínez Alvarez¹, J. L. Martínez Melgar², E. Moreno Lopez³, J. I. Cenoz Osinaga², F. Eiras Abalde², P. Posada Gonzalez²

¹Cardiology Department, Complejo Hospitalario Universitario de Pontevedra, Pontevedra, Spain; ²Intensive Care Unit, Complejo Hospitalario Universitario De Pontevedra, Pontevedra, Spain; ³Anesthesia and perioperative care, Complejo Hospitalario Universitario de Ferrol, Ferrol, Spain

Correspondence: E. Moreno Lopez

Intensive Care Medicine Experimental 2023, **11 (Suppl 1)**:001095

Introduction: According to the literature, in-hospital cardiac arrest is still associated with high mortality rates (around 75% had occurred by 12 months).

Objectives: Primary objective: to describe and compare the demographic data and survival rate of our Unit with those published.

Secondary objective: to evaluate prognostic factors described in literature as predictors of survival from in-hospital cardiac arrest (IHCA).

Methods: Descriptive and retrospective study of IHCA patients admitted to our Intensive Care Unit (ICU) from all wards of our University Hospital in Pontevedra from January 2017 to December 2022. All emergency calls for cardiac arrest and cardiopulmonary resuscitation (CPR) performed by intensivists, successful or not, were included. Patients whose stay in ICU was considered as non-beneficial, due to their previous serious clinical condition or comorbidities, were excluded and CPR was not performed.

Results: During the six-year period, 98 patients with IHCA were admitted, 52% from A&E. Mainly male (67.3%), with a mean age of 72.37 years old (59.22–85.52), and 87.7% were older than 60 years old. Focusing on main cardiovascular risk factors, prevalence of hypertension (70%), diabetes (39.8%) and smoking (47%) was found. Return of spontaneous circulation was achieved in 72.4% of the patients and the survival rate to hospital discharge was 46.9%. Mortality at 12-month follow-up period was 58.2%, being the first days after cardiac arrest the period with higher mortality rate.

The cause of the cardiac arrest was most often cardiac (38.8%) followed by respiratory (30.6%), being most often nonshockable (69.4%) versus shockable (30.6%) as the presenting rhythm. The mean time from event onset to initiation of CPR, whether it was performed by witnesses or hospital staff, was 0.83 min, and the average duration of CPR lasted 7.87 min.

In cardiac arrest, mean pH value was 7.20 and lactate level was 7.24 (statistically significant for mortality with p-value 0.001, OR 3.45 and CI 95% (1.54–5.37)). Neuron-specific enolase (NSE) levels were assessed at 24 and 72 h, being a significant predictor of mortality those levels recorded at 24 h (p-value 0.018, CI 9.04–83.72).

Conclusions: Similarly to what has been described in literature, mortality rate in our hospital was 60%. Consistent with the results of other studies, higher lactate levels and NSE levels sampled at 24 h after cardiac arrest were associated with higher mortality rates in our population.

Topic: Cardiac arrest

001098

Impact of implementation of multidisciplinary protocol for best practices for sleep in critically ill patients—multicenter clinical trial project

L. Drehmer¹, F. Dexheimer², C. Teixeira¹, A. Gomes², B. Mirley², M. Mattioni², I. Feltes³, B. Fior³, A. Ferrazza², C. Albino³, L. Madeira², G. H. Schuster², S. Silva², H. Pasqual², D. Rocha², P. Mariani², C. Bem², J. M. S. Andrade², J. Maccari², L. Nasi²

¹Graduate Program in Pulmonological Sciences, Hospital de Clinicas de Porto Alegre, Porto Alegre, Brazil; ²Intensive Care Unit, Moinhos de Vento Hospital, Porto Alegre, Brazil; ³Intensive Care Unit, Unimed Vale dos Sinos Hospital, Novo Hamburgo, Brazil

Correspondence: L. Drehmer

Intensive Care Medicine Experimental 2023, **11 (Suppl 1)**:001098

Introduction: Sleep disorders in the intensive care unit (ICU) are associated with increased incidence of delirium, changes in the immune system, neuroendocrine dysfunction, and abnormalities associated with cardiovascular diseases, neuropsychiatric diseases, and mortality. Poor sleep quality in critically ill patients may be related to factors related to critical illness or healthcare-related factors. Single-center studies have shown that it is possible to improve healthcare-related factors, resulting in subjective sleep quality improvement, with some studies showing benefits in the medium and long term. The present study aims to evaluate whether the implementation of a package of measures with multidisciplinary interventions can improve the sleep quality of critically ill patients admitted to ICUs.

Objectives: To demonstrate an improvement in sleep quality in critically ill patients by reducing the Richards-Campbell Sleep Questionnaire (RCSQ) score after the implementation of a structured package of evidence-based measures to improve sleep in critically ill patients.

Methods: Multicenter clinical trial with quasi-experimental design. The first step consists of evaluating the sleep quality in sequential patients admitted to the ICU and characterizing the disruptive elements. Twenty-five consecutive patients will be allocated, and demographic data will be collected, and RCSQ will be administered for three consecutive days in patients included in the study, starting from the first day when clinical conditions allow. On the day of ICU discharge or the subsequent day, the Sleep in the Intensive Care Unit Questionnaire (SICUQ) will be administered to assess the disruptive elements of sleep. The second step will involve sensitizing and training at least 75%

of the multidisciplinary team about the importance of sleep for critically ill patients and training them for the implementation of a Multidisciplinary Protocol for Sleep Improvement in Critically Ill Patients. Once the protocol is implemented, it will be followed for a period of 30 days to ensure adequate adherence from the team's perspective. After this period, data collection will be done again from a sample of 25 consecutive patients, and demographic data and sleep questionnaires will be administered as in the initial phase. Based on previous studies, a sample size calculation estimated 50 patients in each group (pre- and post-intervention) to detect a difference of 15 points in the mean RCSQ score with 80% power and alpha of 5%.

Results: We hope that the implementation of a package of measures with multidisciplinary interventions can improve the quality of sleep of critically ill patients admitted to ICUs.

Conclusions: The conclusions will be postponed after the elucidation of the results.

References

1. Crescezo FD et al. Comparative effects of pharmacological interventions for the acute and long-term management of insomnia disorder in adults: a systematic review and network meta-analysis. *The Lancet*. 2022, 400: 170–84.
2. Bertolazi AN et al. Validação da escala de sonolência de Epworth em português para uso no Brasil. *Jornal Brasileiro de Pneumologia*. 2009;35 (9):877–883.
3. Beltrami, FG et al. A multi-intervention protocol to improve sleep quality in a coronary care unit. *European Journal of Cardiovascular Nursing*. 2021.
4. Altman M,T, Knauer M. P, Pisani M. A. Sleep Disturbance after Hospitalization and Critical Illness: A Systematic Review. *American Thoracic Society*. 2017, 14(9):1457–1468.
5. Neurology
6. Medicine
7. Ebben MR, Spielman AJ. *Journal of Behavioral Medicine*. Med (2009) 32:244–254.
8. Hu RF, Jiang XJ, Hegadoren KM, Zhang YH. Effects of earplugs and eye masks combined with relaxing music on sleep, melatonin and cortisol levels in ICU patients: a randomized controlled trial. *Critical Care*. 2015;19 (1):115.
9. Kamdar BB, King LM, Collop NA, Sakamuri S, Colantuoni E, Neufeld JK, et al. The Effect of a Quality Improvement Intervention. *Critical Care Medicine*. 2013; 41 (3):800–9.
10. Li SY et al. Efficacy of controlling night-time noise and activities to improve patients' sleep quality in a surgical intensive care unit. *Journal of Clinical Nursing*. 2011;20 (3–4):396–407.
11. Wang S, Meeker JW, Perkins AJ, Gao S, Khan SH, Sigua NL, et al. Psychiatric symptoms and their association with sleep disturbances in intensive care unit survivors. *Int J Gen Med*. 2019;12:125–30
12. Mori S, Takeda JRT, Carrara FSA, Cohrs CR, Zanei SSV, Whitaker IY. Incidence and factors related to delirium in an intensive care unit. *Rev Esc Enferm USP*. 2016;50 (4):585–91

Topic: Sedation, analgesia and delirium

001101

Mortality in the first 24 h after ICU admission—an audit to improve care

R. Pinto Medeiros¹, R. Pereira¹, M. Bourbon Ruao¹, C. M. Teixeira¹

¹Departamento de Anestesia e Cuidados Intensivos-CHUdSA, Hospital Geral de Santo António, Porto, Portugal

Correspondence: R. Pinto Medeiros

Intensive Care Medicine Experimental 2023, **11 (Suppl 1)**:001101

Introduction: Intensive care unit (ICU) admissions have increased considerably in the last decade [1]. A group of patients that remains poorly characterized are the ones who die within the first 24 h following ICU admission. Prior studies suggested that 20% of all deaths in a mixed ICU population, may occur within the first 24 h [2]. Given the significant resources involved in the admission to an ICU, death within the first day, theoretically represents a high cost to benefit ratio [3]. Thus, a better understanding of this population may lead to insights on how to improve the process of ICU triage and admission, as well as improved outcomes.

Objectives: To describe patients who died within 24 h of admission in a Portuguese university hospital polyvalent ICU.

Methods: Monocentric descriptive observational study. Demographic and clinical data from 1st January to 31st December 2022 were registered.

Results: 105 (23.8%) patients died in the ICU out of a total of 442 patients admitted; 7.7% (n=34) of patients died within the first 24 h. 23 (67.6%) were men, average age of 70.9 years. SOFA (9.9 ± 3.8); SAPS II (69.6 ± 19.2). As demonstrated on Figure 1, the average Clinical Frailty Score of the studied population was 4. Most patients were admitted from the emergency room (n=17). Main cause of admission was cardiovascular pathology regarding shock state (n=13) and the main cause of death was refractory shock (n=23). The average time from admission until time of death was 12.6 h. Thirty-three patients had a decision of withdraw (n=17) or withhold therapeutic measures and only 1 patient died despite advanced life support.

Conclusions: Despite growing demand and utilization of ICU, our current understanding of the demographics, case-mix and circumstances surrounding early deaths is limited. Therefore, a better knowledge regarding our ICU population is crucial in order to deliver high quality care.

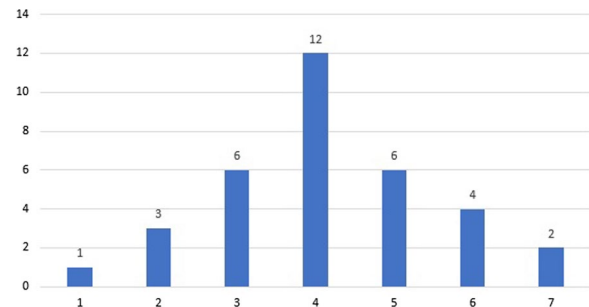

Figure 1 (abstract 001101) Clinical Frailty Score of the study population

References

1. 3. Khandelwal N, Benkeser D, Coe NB, et al. Patterns of cost for patients dying in the intensive care unit and implications for cost savings of palliative care interventions. *JPalliat Med* 2016;19:1171–8. <https://doi.org/10.1089/jpm.2016.0133>.
2. 2. Kakkera KSS, Chada A, Chatterjee K, et al. Mortality in the ICU: who dies within the first 24 h? *Chest* 2016;150:292A. <https://doi.org/10.1016/j.chest.2016.08.305>.
3. 1. Andersen SK, Montgomery CL, Bagshaw SM. Early mortality in critical illness—A descriptive analysis of patients who died within 24 h of ICU admission. *J Crit Care*. 2020 Dec;60:279–284. <https://doi.org/10.1016/j.jcrc.2020.08.024>. Epub 2020 Sep 3. PMID: 32942163.

Topic: Critical care organisation, quality management, information systems, outcomes

001102

Endotoxin neutralization with APAD (GPN00068) in an ovine sepsis and septic shock model induced by fecal peritonitis

A. Moreau¹, C. Aldebert², L. Dewachter³, W. Qu⁴, Y. Yu⁴, F. Manicone², J. L. Vincent¹, J. Creteur¹, L. Shi⁴, F. Su², F. S. Taccone¹

¹Department of Intensive Care, Erasme Hospital, Brussels, Belgium; ²Experimental Laboratory of Intensive Care, Université Libre de Bruxelles, Brussels, Belgium; ³Laboratory of Physiology and Pharmacology, Université Libre de Bruxelles, Brussels, Belgium; ⁴Department of Pharmacology and Toxicology, Grand pharma Ltd, Wuhan, China

Correspondence: A. Moreau

Intensive Care Medicine Experimental 2023, **11 (Suppl 1)**:001102

Introduction: High blood endotoxin levels in sepsis have been associated with its severity and outcome. APAD (GPN00068) (Grandpharma, Wuhan, China) is a new chemical compound invented as a multiple PAMPs (Pathogen Associated Molecular Patterns) antagonist. Our hypothesis was that APAD administration in a clinically relevant septic shock large animal model may improve outcome.

Methods: Sepsis was induced through fecal peritonitis in 24 mechanically ventilated, hemodynamically monitored female sheep. Animals were randomized to three groups of 8: control, concurrent treatment (CuT), and post treatment (4 h later, PT). APAD was given as a bolus (0.2 mg/kg) followed by a continuous infusion (0.03 mg/kg/h). During the first 4 h, fluid was maintained at 2 ml/kg/h; then, fluid resuscitation was individualized to maintain pulse pressure variation \leq 13%, antibiotics were given and peritoneal lavage was administered. Norepinephrine was added to maintain mean arterial blood pressure \geq 65 mmHg if necessary. The experiment lasted 24 h. ^{99m}Tc (Technetium) labeled albumin was utilized to measure kidney cortex, medulla and intestine perfusion at the end of experiment.

Results: CuT & PT groups had a higher cardiac index than the control group. A decreased capillary leakage was suggested in these groups by higher total protein concentrations. At autopsy, wet/dry ratio of the right lung middle lobe was lower in the CuT group than in the control group. The PT group tended to require less vasopressors ($p=0.18$) and have a higher kidney cortex perfusion ($p=0.14$) assessed by Tc99m activity at the end of experiment than the other groups. Survival tended to be longer in the two treatment groups ($p=0.08$) (Figure 1).

Conclusions: In this model of sepsis induced by fecal peritonitis, endotoxin neutralization with APAD resulted in higher cardiac index, tended to decrease vasopressor requirement and improve survival. Higher blood protein concentrations and less pulmonary edema at autopsy also suggested a protective effect of vascular permeability. These changes were still observed when the APAD administration took place 4 h after the onset of sepsis.

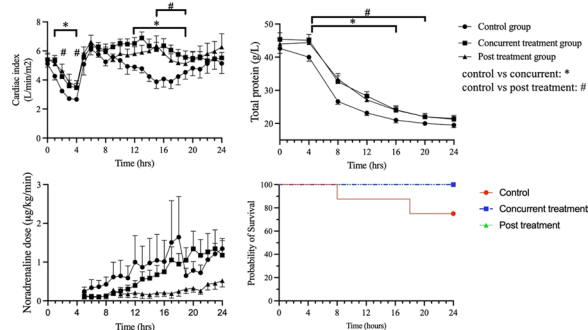

Figure 1 (abstract 001102) Evolution of cardiac index, total protein concentration, noradrenaline dose and probability of survival in the CuT/PT/control groups during the experiment

References

1. This study is partially sponsored by Grandpharma, Wuhan, China.
2. AM and FST were supported by the Fonds Erasme pour la Recherche Médicale.

Topic: Sepsis

001103

Sleep continuity correlates with patients-reported sleep quality in un-sedated critically ill patients

E. Van-Camp¹, C. Rault², Q. Heraud³, J. P. Frat⁴, D. Chatelier⁴, A. Veinstein⁵, R. Coudroy⁴, A. Thille⁴, P.O. Fernagut¹, X. Drouot⁶

¹U1084, Inserm, Poitiers, France; ²Service d'Explorations Fonctionnelles, Physiologie Respiratoire et de l'Exercice, Poitiers University Hospital, Poitiers, France; ³CIC INSERM 1402, Poitiers University Hospital, Poitiers, France; ⁴Medecine intensive reanimation, Poitiers University Hospital, Poitiers, France; ⁵Medical intensive care unit, Poitiers University Hospital, Poitiers, France; ⁶Clinical Neurophysiology, Poitiers University Hospital, Poitiers, France

Correspondence: X. Drouot

Intensive Care Medicine Experimental 2023, **11 (Suppl 1)**:001103

Introduction: It is now well established that sleep quality of critically ill patients is poor. Although sleep quantity might be normal, sleep is highly fragmented by arousals and brief awakenings. These sleep disruptions have been associated with prolonged weaning duration and mortality.

Quantifying sleep in sleep ICU patients is challenging. Polysomnography (PSG) offer the advantages to measure sleep continuity, a recent parameter which has been associated with outcome in patients treated with non-invasive ventilation (1). However, performing PSG in the critically ill is very challenging, requiring dedicated sleep technicians and sleep experts familiar with specific sleep scoring rules. Then, we elaborated an automated sleep scoring algorithm measuring sleep continuity by processing one single EEG channel.

Richards-Campbell sleep questionnaire (RCSQ) is a validated questionnaire to assess sleep quality in ICU patients. However, RCSQ is difficult to administrate in patients who are not fully awake and a more simple numeric visual analog scale have been proposed as an alternative.

Objectives: We investigated the relationship between sleep continuity measured with our automated scoring algorithm and patient-reported sleep quality.

Methods: We analyzed retrospectively 52 polysomnographies previously recorded in non-sedated and conscious ICU patients. Patients sleep was recorded the night after extubation. For each patient, one EEG channel (C3-A1) was processed, providing automated sleep hypnogram. Sleep continuity was measured using this automated scoring as previously described. Patients-reported sleep quality was assessed using Richards Campbell Sleep Questionnaire (score 0 to 100) and by using a visual analog scale (score 0 to 10), graduated from 0 "very poor sleep quality" to 100 "excellent sleep quality". We search for a correlation between patient reported sleep quality and sleep continuity.

Results: Sleep continuity could be calculated on 29 PSG (age: 68y [58–77], median [25th–75th]). Richards-Campbell sleep questionnaire (62 [48–72]) and visual analog scale (5.5 [4.0–7.0]) have been obtained in 18 patients and 29 patients, respectively. Among the 29 patients, 5 (17%) had a positive delirium scale.

Our results show a significant correlation between automated sleep continuity and visual analog scale ($p < 0.008$, $Rho = 0.46$; $n = 29$; Spearman correlation test). In contrast, no correlation existed between sleep continuity and RCSQ score ($p = 0.66$, $n = 18$; Spearman correlation test).

Conclusions: Self-reported sleep quality using a simple VAS can be easily administered in ICU patients. Sleep continuity measured by an automated algorithm may capture a large part of sleep perception and might be a mean to quantify sleep quality.

References

1. Drouot et al. Crit Care 2014 (PMID: 25420997)

Topic: Acute respiratory failure and mechanical ventilation

001104

Detecting non-convulsive seizures—delays and obstacles to EEG

J. Urquidi Ferreira¹, W. Ellis¹, H. Holmes¹, M. Spivey¹

¹Critical Care, Royal Cornwall Hospital, Truro, United Kingdom

Correspondence: J. Urquidi Ferreira, W. Ellis

Intensive Care Medicine Experimental 2023, **11** (Suppl 1):001104

Introduction: Non-convulsive seizures (NCS) occur in about 50% of patients with coma or convulsive status epilepticus (Herman et al., 2015). NCS/NCSE is well known to be underdiagnosed and in sedated patients depends on EEG. Research shows that prolonged NCS/NCSE is associated with increased mortality and worsened neurologic outcome. Access to EEG is limited by availability of technicians and clinicians, amongst other factors.

Methods: We performed an audit of patients admitted with a primary diagnosis of convulsive status epilepticus (CSE) into our 19 bed ICU/HDU. In 2017–2018, there were 29 individuals (5 neonatal, 2 paediatric, 22 adults). We collected data on initial treatment, when and if patients underwent EEG and whether treatment was escalated beyond this.

Results: Over 90% of patients required escalation to general anaesthesia and intubation for termination of seizure, airway protection and to facilitate imaging. There was an average unit stay of 2.7 days (SD 3.3) and only one death. Formal data on performance status was not available. One third of these patients (10/29) underwent EEG within the first 48 h of admission. Those admitted over weekends were the least likely to undergo EEG. No burst activity or NCSE was detected in any EEGs. In addition to this, formal EEG reports were frequently delayed by over 72 h from the time of recording. Data on performance status on discharge was not available.

Conclusions: There is a significant delay in obtaining standard EEG to confirm the absence of NCS/NCSE. This infers a high risk of underdiagnosing NCS/NCSE. Use of continuous EEG at the bedside pending formal EEG may aid in confirming burst suppression and the absence of ongoing seizure activity, bypassing service limitations and bringing practice in-line with both NICE and EMSIC guidelines (Friedman et al. 2009, Herman et al., 2015). Establishment of cEEG in our service could also optimise care for a much broader patient population. This will require further audit cycles and has its own implementation challenges which must be identified.

References

- Herman ST, Abend NS, Bleck TP, Chapman KE, Drislane FW, Emerson RG, Gerard EE, Hahn CD, Husain AM, Kaplan PW, LaRoche SM, Nuwer MR, Quigg M, Riviello JJ, Schmitt SE, Simmons LA, Tsuchida TN, Hirsch LJ; Critical Care Continuous EEG Task Force of the American Clinical Neurophysiology Society. Consensus statement on continuous EEG in critically ill adults and children, part I: indications. *J Clin Neurophysiol.* 2015 Apr;32 (2):87–95. <https://doi.org/10.1097/WNP.000000000000166>. PMID: 25626778; PMCID: PMC4435533.
- Friedman D, Claassen J, Hirsch LJ. Continuous electroencephalogram monitoring in the intensive care unit. *Anesth Analg.* 2009 Aug;109 (2):506–23. <https://doi.org/10.1213/ane.0b013e3181a9d8b5>. PMID: 19608827.

Topic: Neurointensive care

Quality of life in critical ill COVID-19 survivors with invasive mechanical ventilation

P. Rodríguez Villamizar¹, G. Morales Varas¹, M. Márquez Doblas¹, P. Carneiro Pereda¹, G. Alonso Gómez², M. Vecino Montoya¹, A. Cuadra-Calahorra¹,

V. Pais Sánchez-Malingre³, E. Alonso Ciria², I. Gómez Cano⁴, J. Guerra Cuervo¹, M. J. Sánchez Carretero¹

¹Intensive Care Department, Hospital Universitario de Toledo, Toledo, Spain;

²Intensive Care Department, Hospital General Universitario de Toledo, Toledo, Spain;

³Intensive Care Unit, Hospital General Universitario de Toledo, Toledo, Spain;

⁴Intensive Care Medicine, Hospital Universitario de Toledo, Toledo, Spain

Correspondence: P. Rodríguez Villamizar

Intensive Care Medicine Experimental 2023, **11** (Suppl 1):001105

Introduction: The coronavirus disease 2019 (COVID-19) has been related with long-term impact in physical and psychological aspects (1). The use of invasive mechanical ventilation (IMV) was needed if severe respiratory failure was not responding to non-invasive respiratory support. This study aimed to describe the long-term impact influenced by IMV in COVID-19 patients survivors.

Objectives: To analyze the long-term impact of the need of invasive mechanical ventilation in COVID-19 patients survivors.

Methods: This cross-sectional study among critical ill mechanically ventilated COVID-19 survivors at 1-year of intensive care unit (ICU) discharge. Quality of life (QoL) was assessed by the EQ-5D-5L tool and the euroQoL visual analog scale through phone-based questionnaires. Mental health was assessed through medical records and a validated instrument: the Post-Traumatic Stress Disorder (PTSD) Checklist-5 (PCL-5), based on the Diagnostic and Statistical Manual of Mental Disorders (DSM-5). The PCL-5 can determine a provisional diagnosis of PTSD using a cut-point score of 31–33. Categorical variables are expressed as counts and percentages and were compared using the χ^2 test and Fisher test; continuous variables are expressed as medians and interquartile range (IQR) and were compared using Mann–Whitney U test. A two-sided level of significance of 5% was used. Data analysis was performed using STATA version 13[®] (StataCorp LCC).

Results: A total of 549 COVID-19 patients were admitted to the ICU and received IMV. Of them, 7 patients were lost because relocation to another hospital before weaning, 208 died (global mortality of 38,38%) and 214 agreed and were available to answer the phone survey. The 27% needed IMV for less or 7 days while the 73% needed it for more than 7 days. Those who needed IMV for more than 7 days have an increased in hospital length of stay (42,5 Vs 21 days; $p=0$) and ICU length of stay (25 Vs 9 days; $p=0$). There were not significant differences in the demographics baseline. Treatment with psychotropic drugs (antidepressants, benzodiazepines, neuroleptics and opioids) was collected before ICU-admission and after 1 year from ICU discharge, there were not differences between both groups. Patients with more than 7 days of IMV went more often to the emergency department (1 Vs 0 times; $p=0.0$) and required more rehabilitation (62% Vs 45%; $p=0,02$), comparing with those who needed IMV for less or 7 days. With respect to functional limitations, mental health, reduced physical performance and impaired health-related quality of life, we were not able to find significant differences comparing both groups. All the information is summarized in Table 1 and 2.

Conclusions: COVID-19 survivors who required IMV for more than 7 days went more often to the emergency department and were more likely to require further rehabilitation than those with IMV less or 7 days. We did not find differences in functional limitations, mental health, reduced physical performance and impaired health-related quality of life.

Table 1 (abstract 001105) Summary of baseline characteristics and other outcomes. BMI (Body Mass Index). CFS (Clinical Frailty Score). EuroQoL (EuroQuality of Life). PCL-5 (Post-Traumatic Stress Disorder Checklist-5). PTSD (Post-Traumatic Stress Disorder).

	IMV ≤ 7 days n = 58 (27,1%)	IMV > 7 days n = 156 (72,9%)	p =
Women (%)	26/58 (44,8%)	58/156 (37,1%)	p = 0.35
Man (%)	32/58 (55,1%)	98/156 (62,8%)	p = 0.30
Age (years) [IQR]	57,5 (49-63)	61 (52-69)	p = 0.58
BMI [IQR]	29,1 (26-31)	29,9 (26,7-34,6)	p = 0.30
Charlson (median) [IQR]	2 (1-3)	2 (1-3)	p = 0.70
Frailty (CFS) [IQR]	3 (2-3)	2 (2-3)	p = 0.37
ICU length of stay (median) [IQR]	9 (7-11)	25 (15-33)	p = 0.00
Hospital length of stay (median) [IQR]	21 (17-29)	42,5 (31-59)	p = 0.00
Visits to emergency department (median) [IQR]	0 (0-1)	1 (0-2)	p = 0.05
Rehabilitation after discharge (median) [IQR]	26/58 (44,8%)	97/156 (62,1%)	p = 0.02
EuroQoL	70 (50-80)	70 (50-90)	p = 0.46
PCL-5 (median) [IQR]	10 (2-19)	8 (3-19)	p = 0.75
PTSD (Yes, %)	8/58 (13,7%)	17/156 (10,9%)	p = 0.055

Table 2 (abstract 001105) Summary of psychotropic treatment before and after ICU admission.

Psychotropic at one year of follow-up	IMV ≤ 7 days n = 58 (27,1%)	IMV > 7 days n = 156 (72,9%)	p =
Antidepressant			
- Initiated after ICU admission	10/58 (17,2%)	25/155 (16,1%)	p = 0.86
- Same as before ICU admission	1/58 (1,7%)	5/155 (3,2%)	
- Higher doses than before ICU admission	0 (0%)	1/155 (0,6%)	
Benzodiazepines			
- Initiated after ICU admission	13/58 (22,4%)	48/155 (30,9%)	p = 0.19
- Same as before ICU admission	1/58 (1,7%)	7/155 (4,5%)	
- Higher doses than before ICU admission	0 (0%)	4/155 (2,58%)	
Neuroleptic			
- Initiated after ICU admission	1/58 (1,72%)	17/155 (10,9%)	p = 0.06
- Same as before ICU admission	2/58 (3,4%)	2/155 (1,2%)	
- Higher doses than before ICU admission	0 (0%)	0 (0%)	
Opioid			
- Initiated after ICU admission	5/58 (8,6%)	19/155 (12,2%)	p = 0.59
- Same as before ICU admission	1/58 (1,72%)	1/155 (0,65%)	
- Higher doses than before ICU admission	0 (0%)	0 (0%)	

References

- Chippa V, Aleem A, Anjum F. Post Acute Coronavirus (COVID-19) Syndrome. 2023 Feb 3. In: StatPearls [Internet]. Treasure Island (FL): StatPearls Publishing; 2023 Jan. PMID: 34033370

Topic: Critical care organisation, quality management, information systems, outcomes

001106

The modulation of endothelial glycocalyx by sulodexide on the porcine model of endothelial glycocalyx damage

D. Astapenko¹, D. Gorskaja², M. Zrzavecky², A. Ticha³, R. Hyspler¹, J. Moseticky⁴, P. Navratil⁵, H. Kawashima², E. Ssali², V. Cerny⁶

¹Dept. of Anesthesiology, Resuscitation and Intensive Care Medicine, Fakultní nemocnice Hradec Králové, Hradec Králové, Czech Republic;

²Dept. of Anesthesiology and Intensive Care Medicine, Charles University, Faculty of Medicine in Hradec Kralove, Hradec Králové, Czech Republic;

³Dept. of Clinical Biochemistry and Diagnostics, Fakultní nemocnice Hradec Králové, Hradec Králové, Czech Republic; ⁴Dept. of Anesthesiology and Intensive Care Medicine, Hospital Pardubice Region, Inc., Pardubice, Czech Republic; ⁵Dept. of Urology, Fakultní nemocnice Hradec Králové, Hradec Králové, Czech Republic; ⁶Dept. of Anesthesiology, Perioperative and Intensive Care Medicine, Nemocnica Bory, Bratislava, Slovakia

Correspondence: D. Astapenko

Intensive Care Medicine Experimental 2023, 11 (Suppl 1):001106

Introduction: Microcirculation plays a crucial role in tissue metabolism. It is a composition of capillaries and endothelial glycocalyx (EG) which covers inner surface of endothelial cells and makes a biological interface where many important interactions happen. EG is a sugar based endothelial lining involved in the physiology of capillary wall and pathogenesis of many diseases associated with endothelial functions.

Microcirculation is available for in vivo microscopic evaluation at the sublingual mucosa. EG disintegration in disease is evaluated mostly by concentration of its shed products, especially syndecan-1. Sulodexide is a glycosaminoglycan-based drug prescribed in patients with angioopathy proved to be effective.

Objectives: We aimed to investigate whether sulodexide positively modulates EG and microcirculation on a porcine model of EG enzymatic damage.

Methods: Eight piglets were induced EG damage by hyaluronan III and heparanase I given intravenously. Four animals received sulodexide 600 IU intravenously prior to the enzymes (protection group) and four animals after the enzymes (treatment group). Sublingual microcirculation by Side-stream Dark Field imaging and plasmatic concentration of syndecan-1 by ELISA were measured at baseline, 20 min after intervention, at 40th, 60th and 90th minute onwards.

Results: All animals finished the protocol. Neither the analysis of sublingual microcirculation nor syndecan-1 showed any statistically significant results based on 2way ANOVA for inter group difference and unpaired Student's t-test for time point analysis. On the other hand, we noticed a positive trend toward lower values of syndecan-1 and better profile of sublingual microcirculation in the protection group.

Conclusions: Sulodexide might be more effective as a pre-treatment of pre-conditioning before the insult. Our results might have impact into the clinical practice in vascular surgery patients who are exposed to ischemia-reperfusion injury.

References

- Supported by MPO CZ.01.1.02/0.0/0.0/20_321/0024456.

Topic: Translational Medicine

001107

Mapping the management of post-extubation dysphagia: an overview of practice in Greek-Cypriot ICUs

M. Mpouzika¹, S. Iordanou², M. Kyranou¹, K. Iliopoulou³, S. Parissopoulos⁴, M. Kalafati⁵, M. Karanikola¹, E. Papatthanassoglou⁶

¹Department of Nursing, Cyprus University of Technology, Limassol, Cyprus; ²Intensive Care Unit, Limassol General Hospital, Kato Polemidia, Cyprus; ³Healthcare Researcher, NHS Lothian, Scotland, United Kingdom; ⁴Department of Nursing, University of West Attica, Egaleo, Greece;

⁵Department of Nursing, National and Kapodistrian University of Athens, Athens, Greece; ⁶Faculty of Nursing, University of Alberta, Edmonton, Canada

Correspondence: M. Mpouzika

Intensive Care Medicine Experimental 2023, 11 (Suppl 1):001107

Introduction: Post-extubation dysphagia (PED) can lead to serious health problems in vulnerable critically ill patients, yet routine bedside screening may be lacking in many Intensive Care Units (ICUs), possibly due to limited awareness for this condition.

Objectives: The present study aimed to establish baseline data on the current approaches, the status of perceived best practices to PED management and treatment, as well as to assess awareness of PED and its consequences. The questionnaire was completed by a designated clinician, after consultation with the ICU team.

Methods: A nationwide cross-sectional, online survey was conducted of all adult ICUs (n = 14; response rate 100%) in the Republic of Cyprus.

Results: None of the included ICUs had a dedicated speech and language pathologist/ therapist (SLP/SLT). More than 85% of ICUs reported that there was no standard protocol indicating which patients should be screened for PED. Cough reflex testing and water

swallow test were the most commonly reported assessment methods used to confirm the presence of PED. In the majority of ICUs (64.3%), nurses and intensivists were responsible to assess PED as well as SLP/SLTs. Muscle strengthening exercises without swallowing and swallowing exercises were mostly used to treat dysphagia. Of the ICUs, 71.4% reported the need for standard protocols for PED screening. Overall, 28.6% of the ICUs agreed that PED was common in their unit.

Conclusions: We identified gaps in Greek Cypriot ICUs awareness and practice regarding PED management, treatment, and consequences. Comprehensive unit-based dysphagia education programs must be urgently implemented. Interdisciplinary and collaborative work between nurses, intensivists and SLPs is needed to improve the quality of care provided.

References

1. Spronk PEJ, Spronk LEJ, Egerod I, McGaughey J, McRae J, Rose L, Brodsky MB, Brodsky MB, Rose L, Lut J, et al. Dysphagia in Intensive Care Evaluation (DICE): An International Cross-Sectional Survey. *Dysphagia* (2022) <https://doi.org/10.1007/s00455-021-10389-y>
2. Omura K, Komine A, Yanagigawa M, Chiba N, Osada M. Frequency and outcome of post-extubation dysphagia using nurse-performed swallowing screening protocol. *Nurs Crit Care* (2019) 24:70–75. <https://doi.org/10.1111/NICC.12359>
3. Denk-Linnert DM, Farneti D, Nawka T, am Zehnhoff-Dinnesen A, Moerman M, Zorowka P, Farahat M, Schindler A, Geneid A. Position Statement of the Union of European Phoniatrians (UEP): Fees and Phoniatrians' Role in Multidisciplinary and Multiprofessional Dysphagia Management Team. *Dysphagia* (2022) <https://doi.org/10.1007/S00455-022-10502-9>
4. This research was funded by the Cyprus University of Technology (internal funding/ research activity 3/319).

Topic: Acute respiratory failure and mechanical ventilation.

001108

Are livers ageless?

R. Caetano Garcês¹, J. Alves Cabrita¹, M. Gama¹, J. Lamelas², R. Perdigoto³, H. Pinto Marques², P. Fortuna¹, R. Cavaco¹, N. Germano¹, L. Bento,¹
¹Intensive Care and Emergency, Centro Hospitalar Universitário de Lisboa Central, Lisbon, Portugal; ²General Surgery Department, Centro Hospitalar Universitário De Lisboa Central, Lisbon, Portugal; ³Transplant Unit, Centro Hospitalar Universitário de Lisboa Central, Lisbon, Portugal

Correspondence: R. Caetano Garcês
Intensive Care Medicine Experimental 2023, **11 (Suppl 1)**:001108

Introduction: In Portugal, the use of non-heart beating donors has a low expression in the total number of transplants performed. Most organ donors are brain-dead patients with central nervous system injuries. (1) There is a clear limitation on obtaining organs, so the use of "old" donors could be a viable alternative. However, it is questionable whether the survival of these grafts is similar to that of newer organs.

Objectives: The authors intend to evaluate the 4-year survival of patients undergoing liver transplantation with organs from donors over 70 years old.

Methods: Retrospective study including all patients undergoing liver transplantation at a transplant center in Lisbon, over a period of two years (2017 to 2018). A review of the clinical processes of hospitalizations and transplant follow-up appointments was carried out over a 4-year period. Data collection maintained the patients anonymity. Comparison was made between the 2 groups (patients transplanted with new organs versus those with old organs) regarding patient mortality at 4 years and graft loss requiring retransplantation.

Results: In the 2-year period analyzed, 187 patients underwent surgery, with 10 patients being excluded due to abandonment of the centre. 59 liver transplants were performed with livers from donors aged over 70 years. Most donors died of cerebrovascular disease (60%) followed by traumatic brain injury (34%). The cold ischemia time of these grafts was 399 min and the warm ischemia time was 39 min. The 4-year graft survival is 83% and the 4-year mortality rate is 10%.

The transplants of new grafts corresponded to 118. Most donors died of cerebrovascular disease (67%) followed by traumatic brain injury (24%). The cold ischemia time of these grafts was 417 min and the warm ischemia time was 38 min. The 4-year graft survival is 86% and the 4-year mortality rate is 9%.

Conclusions: When we analyze graft survival and mortality rate at 4 years, there is no significant difference between old grafts and new grafts.

References

1. Ipst.pt. Doação e Transplantação de Órgãos, Tecidos e Células—Atividade Nacional Anual 2021. [Internet] 2022 [Updated 03/05/2022] Available from: <https://ipst.pt/index.php/pt/dados-estatisticos-transplantaacao>

Topic: Metabolism, endocrinology, liver failure and nutrition

001109

Emergency TAVI for acute heart failure due to severe aortic stenosis in critically patients with cardiogenic shock

I. Espinosa Rueda¹, M. Mendoza-Prieto¹, L. Martín Villen¹, N. Palomo-López², J. Navarro-Rodríguez¹
¹Critical Care Unit, Hospital Universitario Virgen del Rocío, Sevilla, Spain; ²Critical Care Unit, Virgen del Rocío University Hospital, Sevilla, Spain

Correspondence: I. Espinosa Rueda
Intensive Care Medicine Experimental 2023, **11 (Suppl 1)**:001109

Introduction: Aortic stenosis is one of the most frequent causes of heart failure and might lead to cardiogenic shock. The presence of hemodynamic instability and the comorbidities of our patients makes surgical management prohibitive. For this reason, the utilization of emergency transcatheter aortic valve implantation (eTAVI) is considered in these selected cases as a therapeutic option.

Objectives: To describe clinical characteristics of patients undergoing eTAVI, evaluation of clinical course and most frequent complications related to the procedure.

Methods: Observational, retrospective study from January 2021 to December 2022 in an Intensive Care Unit (ICU) of a tertiary care hospital. Patients undergoing eTAVI were included. Demographic variables, admission to ICU, surgical risk (Euroscore II), left ventricular ejection fraction (LVEF) before and after procedure, clinical course and complications were collected. Qualitative variables were described by frequencies; quantitative by mean and interquartile range (IR).

Results: A total of 4 patients were included, 100% male, with a mean age of 65 years (61–85). The main reason for ICU admission was acute valvular heart disease due to severe Aortic stenosis (50%). The mean ICU stay was 6.50 days (0.9–13.9) and the total hospital stay was 13.50 days (2.58–33.91). The mean Euroscore II was 14.06% (5.03–23.08), reason for which the surgical intervention was rejected in all the cases.

Only 25% of our cohort needed mechanical ventilation before the procedure with a favorable weaning in the first 8 days postprocedure. One patient (25%) developed an acute kidney failure requiring continuous renal replacement therapy (CRRT). We notice an only case of cardiac arrhythmia after TAVI were performed. In our cohort we observed a significant improvement of LVEF after procedure with statistical significance level $p < 0.27$ (IC 3.71–31.28).

Table 1 (abstract 001109) Demographic data and clinical course

Clinical features	N = 4
Male, n (%)	4 (100%)
Age, mean (IR)	65 (61.75–80.25)
ICU admission	
Decompensated heart failure, n (%)	1 (25%)
Miocardial acute infarction Killip 3, n (%)	1 (25%)
Symptomatic acute severe aortic stenosis, n (%)	2 (50%)

Clinical features	N = 4
Euroscore II % (IR)	14.06 (5.03–23.08)
Mellitus diabetes II, n (%)	3 (75%)
Arterial hypertension, n (%)	3 (75%)
Chronic kidney disease, n (%)	2 (50%)
Chronic ischemic heart disease, n (%)	1 (25%)
LVEF before TAVI, mean (RI)	15 (11.25–26.25)
LVEF after; mean (RI)	38 (36.50–47)
Arrhythmias; n (%)	1 (25%)
Mechanical ventilation, n (%)	2 (50%)
Vasoactive amines, n (%)	3 (75%)
CRRT, n (%)	1 (25%)
ICU length of stay, mean (RI)	6.50 (0.9–13.9)
Hospital length of stay, mean (RI)	13.5 (2.58–33.99)

Conclusions: In our study we observed a significant clinical and statistical improvement of LVEF after procedure which is related to a recovery of functional class of our patients. Most frequent complications described in bibliography such as acute kidney injury and cardiac arrhythmias appeared in some of our cases. Despite the limitation of the sample size, we notice favorable results, although more studies are required to endorse this procedure.

References

1. T.A. McDonagh, M. Metra, M. Adamo, et al. 2021 ESC Guidelines for the diagnosis and treatment of acute and chronic heart failure. *Eur Heart J*, 42 (2021), pp. 3599–3726. <https://doi.org/10.1002/ehfj.2333>
2. Aparisi Á, Santos-martínez S, Delgado-arana JR, Rodríguez-gabella T, Redondo A, Gutiérrez H, et al. Resultados del TAVI emergente comparado con el procedimiento electivo. *REC Interv Cardiol* 2021;3 (3):166–74. <https://doi.org/10.24875/RECIC.M21000200>
3. Enta Y, Miyasaka M, Taguri M, Tada N, Hata M, Watanabe Y, et al. Patients characteristics and mortality in urgent / emergent / salvage transcatheter aortic valve replacement: insight from the OCEAN-TAVI registry. *Open Heart* 2020;1–8. <https://doi.org/10.1136/openhrt-2020-001467>
4. V.H. Thourani, S. Kodali, R.R. Makkar, et al. Transcatheter aortic valve replacement versus surgical valve replacement in intermediate-risk patients: a propensity score analysis. *Lancet*, 387 (2016), pp. 2218–2225. [http://dx.doi.org/10.1016/S0140-6736\(16\)30073-3](http://dx.doi.org/10.1016/S0140-6736(16)30073-3).
5. Serbia C, Germany SB, Germany JB, Germany LC, Freemantle N, Kingdom U, et al. 2021 ESC / EACTS Guidelines for the management of valvular heart disease Developed by the Task Force for the management of valvular heart disease of the European Society of Cardiology (ESC) and the European Association for Cardio-Thoracic Surgery (EACTS). 2021;1–72

Topic: Cardiovascular issues in ICU

001110

Comparison of neuron-specific enolase, tau-protein, neuro-filament light chain, galectin-3 values and their combination for early outcome prediction in cardiac arrest survivors

D. Vondrakova¹, A. Krüger¹, M. Janotka¹, J. Naar¹, P. Neužil¹, E. Drncova², O. Sobek³, P. Ostadal¹

¹Cardiovascular Center, Na Homolce Hospital, Prague, Czech Republic;

²Department of Clinical Biochemistry, Na Homolce Hospital, Prague, Czech Republic;

³Laboratory for Liguorology and neuroimmunology, Topelex s.r.o., Prague, Czech Republic

Correspondence: D. Vondrakova

Intensive Care Medicine Experimental 2023, **11 (Suppl 1)**:001110

Introduction: Early and precise prognosis determination in cardiac arrest survivors remains challenging despite multimodal approach.

Currently, the only guidelines-recommended biomarker for early prognostication is neuron-specific enolase (NSE).

Objectives: The aim of our study was to compare prognostic values of NSE with novel biomarkers serum tau protein (Tau), neuro-filament light chain (Nfl) and Galectin-3 (Gal) at different timepoints after cardiac arrest and with combination of all four biomarkers.

Methods: Eligible subjects for this single-center prospective study were out-of-hospital cardiac arrest survivors. All patients were treated with targeted temperature management (33 °C for 24 h) using an endovascular device. Blood samples for the measurements of NSE, Tau, Nfl and Gal levels were drawn at 24 h (D1), 48 h (D2), 72 h (D3), and 96 h (D4) after hospital admission. Thirty-day neurological outcomes according to the Modified Rankin Scale (mRS) were evaluated as clinical endpoints, poor outcome was defined as mRS 4–6. Prognostic values of NSE, Tau, Nfl and Gal for the prediction of poor outcomes were determined using ROC analysis.

Results: A total of 43 cardiac arrest survivors (mean age 64.2 years) were enrolled in the present study. The area under the ROC curve (AUC) for NSE was 0.776, $P < 0.001$ at D1, 0.911, $P < 0.001$ at D2, 0.982, $P < 0.001$ at D3, and 1.0, $P < 0.001$ at D4. The AUC for Tau was 0.823, $P < 0.001$ at D1, 0.893, $P < 0.001$ at D2, 0.938, $P < 0.001$ at D3, and 0.980, $P < 0.001$ at D4. The AUC for Nfl was 0.614, $P = 0.232$ at D1, 0.782, $P = 0.001$ at D2, 0.969, $P < 0.001$ at D3, and 0.990, $P < 0.001$ at D4. The AUC for Gal was 0.675, $P = 0.048$ at D1 and not significant for D2–4. The comparison of ROC curves revealed significantly lower AUC for Gal in comparison to other biomarkers at D2–4; a trend to lower AUC was detected for Nfl at D1 in comparison to NSE ($P = 0.151$) and Tau ($P = 0.077$) with comparable values at D2, D3 and D4. Numerically, the highest AUC at D1 was observed for Tau and at D2, D3 and D4 for NSE. The highest sensitivity for the prediction of poor prognosis with 100% specificity was detected for Tau values at D1 (33.3%) or D2 (70.0%) and for NSE values at D3 (92.9%) or D4 (100%). Multiple logistic regression revealed that combination of all four biomarkers may predict poor prognosis already at D1 with 100% specificity and 53% sensitivity (AUC 0.888, $P < 0.001$).

Conclusions: Our results indicate that the novel biomarkers Tau and Nfl have comparable predictive value for clinical outcomes as NSE at 48 to 96 h after cardiac arrest. At the first day after admission the highest predictive value has Tau followed by NSE, whereas Nfl is not significantly associated with outcomes at this timepoint. Gal values predict outcomes only at 24 h.

Combination of all four biomarkers could improve prognosis prediction with high predictive value already the first day.

References

1. This study was supported by an Institutional grant MH CZ-DRO (Nemocnice Na Homolce—NNH, 00023884) IG230501.

Topic: Cardiac arrest

001112

Long-term survival after mechanical support with VA ECMO

M. Mendoza-Prieto¹, N. Palomo-López², L. Martín Villen¹, I. Espinosa Rueda¹, J. Navarro-Rodríguez¹

¹Critical Care Unit, Hospital Universitario Virgen del Rocío, Sevilla, Spain;

²Critical Care Unit, Virgen del Rocío University Hospital, Sevilla, Spain

Correspondence: I. Espinosa Rueda

Intensive Care Medicine Experimental 2023, **11 (Suppl 1)**:001112

Introduction: At the present time the use of VA ECMO as a treatment for refractory cardiogenic shock of any etiology has increased. Although its use is on the upswing, the mortality associated to it remains high. There are few studies that describe the progress, as well as the complications, quality of life and mortality of patients who required VA ECMO once they are discharged from the ICU (intensive Care Unit).

Objectives: To describe the characteristics and short and long term outcome of shock cardiogenic patient on VA ECMO in a tertiary hospital.

Methods: Observational and retrospective study, in which patients with cardiogenic shock requiring ECMO between January 2013 and September 2022 were collected. All those patients discharged from hospital were followed up until December 2022.

Demographic variables, outcome, complications, and ECMO-related variables were collected. Qualitative variables were described by median and interquartile range. X2 test was performed for qualitative variables and U Mann Whitney for quantitative variables. Survival was represented by Kaplan–Meier. Statistical significance was considered when $p < 0.05$.

Results: A total of 135 patients were obtained, whose 96 (71,1%) were decannulated successfully. Hospital mortality for those who were decannulated was 31,25%. 66 patients were discharged from hospital, whose 95,3% were alive at 6 months. The demographic variables, survival and those variables related to ECMO are described in the Table 1.

Variables n (%) / Median (IR)	Hospital survival N = 66
Male	39 (59.1)
Age	52.50 (39.50. 60)
Chronic Kidney Failure	3 (4.5)
BMI > 30	7 (10.61)
Cardiogenic shock aetiology n (%)	
Postcardiotomy shock	23 (34.8)
Acute myocardial infarction	21 (31.8)
Acute myocarditis	7 (10.6)
Primary graft failure	6 (9.1)
Right ventricular failure	6 (9.1)
Survival after ECMO withdrawal	
6 months	95.53%
12 months	87.5%
60 months	83.33%
Days on VA ECMO	5.0 (3.0;8.0)
Days on mechanical ventilation	11.0 (6.5;46.5)
Peripheral neuropathy	27 (40.91)
Anxiety depressive syndrome	10 (15.15)
Kidney Failure	9 (13.63)
Surgical wound infection	8 (12.12)
Causes of mortality; n (%)	
Pneumonia	1 (25)
Hemorrhagic stroke	1 (25)
NYHA classification at 12 months	
I	36 (54.54)
II	20 (30.0)
III	9 (13.64)
IV	1 (1.51)

Conclusions: VA ECMO is postulated as an useful implement in the management of patients in refractory cardiogenic shock. In our cohort, it is associated with raised early mortality, although after hospital stay the survival of these patients remains high.

Topic: Cardiovascular issues in ICU

001114

Covid-19 acute respiratory distress syndrome: clinical data, outcomes and ventilatory strategies

I. Sdiri¹, S. Ines², H. Larnaout², O. Asma², H. H. Doghri³, N. Falfoul Borsali⁴
¹ICU, Hopital Habib Thameur, Tunis, Tunisia; ²ICU, Hôpital Habib Thameur, Tunis, Tunisia; ³Intensive Care, Habib Thameur University Hospital, Tunis, Tunisia; ⁴Intensive Care, Hôpital Habib Thameur, Tunis, Tunisia

Correspondence: I. Sdiri

Intensive Care Medicine Experimental 2023, 11 (Suppl 1):001114

Introduction: Covid-19 can be complicated by pneumonia of varying severity up to acute respiratory distress syndrome (C-ARDS).

Objectives: The study aim was to describe the clinical, paraclinical and evolutionary data of C-ARDS according to the severity.

Methods: We conducted a retrospective study between March 2020 and February 2021 including all patients hospitalized for C-ARDS (according to the Berlin criteria with a positive virological test). We included patients hospitalized via the hospital emergency department for C-ARDS. Patients who died within 48 h of admission and those admitted from another hospital were not included in the study. Patients without C-ARDS and those with ARDS of other etiologies were excluded. We compared the initial clinical and paraclinical data and patients outcomes according to the severity of the ARDS.

Results: We enrolled 215 patients with a mean age of 66 ± 12 years and a sex ratio of 1.38. The main comorbidities were hypertension (55.8%) and diabetes (45.1%). The median consultation time was seven days and was shorter in mild C-ARDS (5 days). Oxygen saturation was lower in severe and moderate C-ARDS (80 and 84% respectively) than in mild C-ARDS (88%). Lung injury extension was < 10% in four cases (1.9%), 10 to 25% in 29 cases (13.5%), 25 to 50% in 67 cases (31.2%), 50 to 75% in 83 cases (38.6%) and > 75% in 32 cases (14.9%). C-ARDS was mild in 121 cases (56.3%), moderate in 84 cases (39.1%) and severe in 10 cases (4.7%). Demographic characteristics, comorbidities, initial biological and CT data were comparable between the different severity stages of C-ARDS. Non-invasive ventilation was the most commonly used oxygenation modality; indicated in 204 cases (94.9%) alternating with High- flow nasal cannula (HFNC) oxygen therapy in 30 cases. It was more indicated in mild (98.3%) and moderate (91.7%) ARDS than in severe ARDS (80%). Invasive ventilation was indicated in 28.8% of cases (n = 62) and 80% of severe ARDS; after a median delay of five days [2–10]. Ventilation was performed in the prone position in 81 patients (37.7%), 76 of whom received spontaneous ventilation. ICU length of stay was comparable between the three stages of C- ARDS. The mortality rate was 34.9% (n = 75); higher in severe C-ARDS.

Conclusions: Patients with C-ARDS have a mean age of 66 years. Oxygen saturation and lung injury extension define the C-ARDS severity. The most frequent modes needed in C-ARDS are non-invasive ventilation. The use of invasive ventilation and mortality are high in severe forms.

Topic: Acute respiratory failure and mechanical ventilation

001115

The impact of early initiation of temperature control on comatose cardiac arrest survivors

K. Alotaibi¹, A. Dyson², M. Singer³

¹Bloomsbury Institute for Intensive Care Medicine, University College London, London, United Kingdom; ²Centre for Pharmaceutical Medicine Research, King's College London, London, United Kingdom; ³Bloomsbury

institute of intensive care medicine, University College London, London, United Kingdom

Correspondence: K. Alotaibi

Intensive Care Medicine Experimental 2023, **11 (Suppl 1)**:001115

Introduction: Cardiac arrest (CA) represents the extreme of critical illness; survivors predominantly die as a result of the deconstructive processes affecting the nervous system. While temperature control (TC) is routinely practiced, recent evidence indicate that cooling to a hypothermic target fails to demonstrate either survival or neurological benefit (1,2). We hypothesized this may relate to the rapidity and degree of target achievement.

Objectives: To examine the published literature to identify the impact of early versus delayed initiation of TC on the rate of survival and neurological outcomes in CA victims. We further assessed the type of cooling method utilised.

Methods: A systematic search was conducted using the following databases: PubMed, Cochrane Library and U.S National Library of Medicine. Only prospective, randomised, controlled trials were included. A meta-analysis was performed using Review Manager software version 5.4.

Results: The search yielded 11,678 citations of which 11 (ten out-of-hospital) met the inclusion criteria. 4922 participants were included in the analysis. Three methods were utilised to initiate cooling (cold fluid, trans-nasal evaporative, and pharyngeal cooling). In six studies cooling was commenced during cardiopulmonary resuscitation (CPR), and in the remaining five after restoration of spontaneous circulation. Survival rates were similar in both groups (RR 1.01; 95%CI 0.92 to 1.11; I²=0%, p=0.79). Early cooling also failed to improve neurological function (RR 1.01; 95%CI 0.93 to 1.14 I²=0%, p=0.51). However, a sub-analysis of two studies comprising 310 patients presenting with shockable rhythms suggested early nasal evaporative cooling was beneficial (3.4). In six studies, administration of cold fluid during CPR was associated with re-arrest occurrence. All ten out-of-hospital studies failed to reach the target temperature range of 32–34 °C at hospital admission.

Conclusions: Early initiation of TC failed to show any survival or neurological benefit in cardiac arrest survivors though target temperatures were not attained. Patients presenting with shockable rhythms may benefit from nasal evaporative cooling though larger confirmatory studies are needed.

References

1. Nordberg P, Taccone FS, Truhlar A, Forsberg S, Hollenberg J, Jonsson M, et al. Effect of Trans-Nasal Evaporative Intra-arrest Cooling on Functional Neurologic Outcome in Out-of-Hospital Cardiac Arrest: The PRINCESS Randomized Clinical Trial. *Jama*. 2019;321 (17):1677–85.
2. Castrén M, Nordberg P, Svensson L, Taccone F, Vincent JL, Desruelles D, et al. Intra-arrest transnasal evaporative cooling: a randomized, prehospital, multicenter study (PRINCE: Pre-ROSC IntraNasal Cooling Effectiveness). *Circulation*. 2010;122 (7):729–36.
3. Dankiewicz J, Cronberg T, Lilja G, Jakobsen JC, Levin H, Ullén S, et al. Hypothermia versus Normothermia after Out-of-Hospital Cardiac Arrest. *N Engl J Med*. 2021;384 (24):2283–94.
4. Nielsen N, Wetterslev J, Cronberg T, Erlinge D, Gasche Y, Hassager C, et al. Targeted temperature management at 33 °C versus 36 °C after cardiac arrest. *N Engl J Med*. 2013;369 (23):2197–206.

Topic: Cardiac arrest

001116

Prognosis of acute bacterial meningitis in the intensive care setting

J. E. Mateus¹, A. R. Nogueira¹, J. Rua¹, G. C. Almeida¹, L. Linhares¹, M. Simões¹, P. Martins¹

¹Intensive Care Unit, Centro Hospitalar e Universitário de Coimbra, Coimbra, Portugal

Correspondence: J.E. Mateus

Intensive Care Medicine Experimental 2023, **11 (Suppl 1)**:001116

Introduction: Acute bacterial meningitis is a medical emergency that often requires the patient to be admitted to the ICU. The severity of the disease is frequently associated with significant morbidity and mortality. Identifying predicting factors associated with more adverse clinical outcomes is important, in order to optimize care and ultimately the prognosis of these patients.

Objectives: We aimed to study a cohort of patients admitted to our ICU in the last 10 years and do an exploratory analysis to identify factors associated with a worse diagnosis.

Methods: We performed a retrospective analysis during a 10-year period of patients older than 18 years, admitted to a polyvalent ICU due to acute bacterial meningitis. Demographic, clinical and outcome data were collected from medical records in the electronic clinical file. Categorical data is presented as frequency (percentage). We performed a descriptive analysis. In addition, we performed logistic regression models adjusted to age when considered relevant. Statistical significance was set at p < 0.05.

Results: We identified 49 patients with the diagnosis of acute bacterial meningitis. Two thirds of the patients were male and the mean age was 54.8 years (std 17.6). The mortality during the ICU stay was 10.2%, the 28-day and 3-month mortality was 16.3% and 20.4%, respectively, and the 6-month mortality was 24.5%.

On univariate analysis, age and Charlson scale were the only variables associated with mortality. On binary logistic regression adjusted to age, Charlson scale was the only tool that could predict mortality at 1 year (OR: 1.550, 95%CI=[1.025, 2.346], p=0.038), with statistical significance. Neither APACHE II (OR=0.993, 95%CI=[0.867, 1.136] p=0.913), SAPS II (OR=1.118, 95%CI=[0.967, 1.292] p=0.132), SAPS 3 (OR=1.177, 95%CI=[0.935, 1.481] p=0.164) nor SOFA score at admission (OR=1.095, 95%CI=[0.822, 1.457] p=0.536) could predict mortality. The same trend was observed to mortality at 28 days, 3 months and 6 months.

During the stay at the ICU, 42.9% of the patients had secondary seizures and 22.7% had secondary hydrocephalus prompting the need to place an external ventricular drain.

The patients registered significant morbidity levels in the following months with 38.9% having a score of 3 or less in the Glasgow Outcome Scale.

Conclusions: In our study, age and higher score at Charlson Scale were associated with higher mortality. Also, significant neurological disability was observed in the following months, as measured by the Glasgow Outcome Scale.

References

1. Stoeter DJ, Michael BD, Solomon T, Poole L. Managing acute central nervous system infections in the UK adult intensive care unit in the wake of UK encephalitis guidelines. *J Intensive Care Soc*. 2015 Nov;16 (4):330–338. <https://doi.org/10.1177/1751143715587927>.
2. Waqar U, Arshad A, Ayaz A, Tahir MS, Khan DA, Martins RS et al. Risk factors for intensive care unit admission and mortality among adult meningitis patients. *J Pak Med Assoc* 2022 Jul;72 (7):1460–1466. <https://doi.org/10.47391/JPMA.4482>

Topic: Infections and prevention

001117

Association of early antibiotic exposure with VAP in patients with acute brain injury

R. M. L. Roepke¹, L. Bianchini¹, D. M. Paulo Marcelo Gomes Pontes¹, B. Pedro Osório Fortes¹, D. Ana Clara Marcondes¹, B. A. M. P. Besen²

¹Trauma and Emergency Surgery Intensive Care Unit, Hospital das Clínicas Faculdade de Medicina USP, São Paulo, Brazil; ²UTI Clínica, Disciplina de Emergências Clínicas, Hospital das Clínicas of the University of São Paulo, São Paulo, Brazil

Correspondence: R.M.L. Roepke

Intensive Care Medicine Experimental 2023, **11 (Suppl 1)**:001117

Introduction: Patients with acute brain injury who require mechanical ventilation (MV) after an urgent intubation are at increased risk for ventilator-associated pneumonia (VAP). The benefit of a short course of antibiotics in preventing early-onset VAP has been shown in previous studies, but uncertainty remains.

Objectives: To evaluate the association of early antibiotic exposure at the time of ICU admission for other medical reasons with development of VAP within 7 days of mechanical ventilation (early-onset VAP) in patients with acute brain injury after an urgent intubation.

Methods: Prospective cohort of patients admitted to a specialized trauma and neurocritical ICU, from January, 2019 to December, 2022, in a tertiary hospital in São Paulo, Brazil. The analysis included patients with an acute brain injury due to traumatic brain injury, ischemic or hemorrhagic stroke or aneurismatic subarachnoid hemorrhage; older than 18 years old; who required urgent intubation performed in prehospital setting or emergency department; and that required MV for at least 48 h. Patients were excluded if they were using antibiotics as treatment for an infection at the time of ICU admission and if they were submitted to a considered non-urgent intubation in the operating room. We performed an inverse probability weighted analysis adjusting for baseline confounders to evaluate the association between exposure to an early antibiotic course for 48 h for other medical reasons, mostly antibiotic prophylaxis for open fractures and cerebral spinal fluid fistulas according to hospital guidelines, with development of VAP up to 28 days, early-onset (≤ 7 days) VAP and late-onset (> 7 days but < 28 days) VAP.

Results: A total of 697 patients with acute brain injury were admitted to the ICU in the period. Of those, 433 received MV for at least 48 h following an urgent intubation (Table 1). Early-onset VAP occurred in 45 patients (10.4%) and late-onset VAP in 34 (7.9%) patients (Table 2). In the weighted pseudopopulation, antibiotic exposure within 48 h of intubation was associated with decreased odds of VAP (OR = 0.48, 95% CI 0.27–0.84, $p = 0.010$). The exposure was associated with less early-onset VAP (OR = 0.41, 95% CI 0.20–0.82, $p = 0.011$), but not with late-onset VAP (OR = 0.68, 95% CI 0.30–1.53, $p = 0.35$). Antibiotics exposure was not associated with neither lower ICU ($p = 0.34$) nor hospital mortality ($p = 0.85$), but it was associated with more ventilator-free days (median difference = 7 days, 95% CI 1.05–12.95, $p = 0.021$, Figure 1).

Conclusions: Antibiotic exposure within 48 h was associated with a reduction in early VAP in patients with acute brain injuries intubated in an urgent setting.

Table 1 (abstract 001117) Baseline characteristics

Table 1: Baseline characteristics				
	Complete cohort (N=433)	Antibiotic exposure (n= 230)	No antibiotic exposure (n= 203)	p value
Age	49 (18)	46 (17) (n=227)	52 (18) (n=202)	0.001
Male sex	320 (73.9%)	181 (78.7%)	139 (68.5%)	0.016
SAPS 3	59 (13)	58 (14)	61 (12) (n=202)	0.004
SOFA	8 [6, 10]	8 [7, 11]	8 [6, 1]	0.011
SOFA neurological	3 [3, 4]	3 [3, 4]	3 [3, 4]	0.69
SOFA cardiovascular	4 [0, 4]	4 [3, 4]	3 [0, 4]	0.007
SOFA respiratory	1 [0, 2]	1 [0, 2]	1 [0, 2]	0.57
Type of ABI				<0.001
TBI	330 (76.2%)	203 (88.3%)	127 (62.6%)	
Stroke	61 (14.1%)	14 (6.1%)	47 (23.2%)	
SAH	43 (9.7%)	13 (5.7%)	29 (14.3%)	
Thoracic trauma	147 (33.9%)	93 (40.4%)	54 (26.6%)	0.003
Smoking	77 (17.8%)	38 (16.5%)	39 (19.2%)	0.53
Alcoholism	105 (24.2%)	59 (25.7%)	46 (22.7%)	0.50
ECOG	0 [0, 0]	0 [0, 0]	0 [0, 0]	0.021
Intubation setting				<0.001
Prehospital	191 (44.2%)	130 (56.5%)	61 (30%)	
Emergency department	241 (55.8%)	99 (43%)	142 (70%)	

Table 2 (abstract 001117) Patients outcomes

Table 2: Patients outcomes				
	Complete cohort (n=433)	Antibiotic exposure (n= 230)	No antibiotic exposure (n= 203)	p value
VAP	79 (18.2%)	33 (14.3%)	46 (22.7%)	0.034
Early-onset VAP	45 (10.4%)	18 (7.8%)	27 (13.3%)	0.082
Late-onset VAP	34 (7.9%)	15 (6.5%)	19 (9.4%)	0.29
MV free days	11 [0, 21]	14 [0, 22]	1 [0, 18]	0.002
ICU mortality	166 (38.3%)	76 (33.0%)	90 (44.3%)	0.018
Hospital mortality	194 (44.8%)	93 (40.4%)	101 (49.8%)	0.054

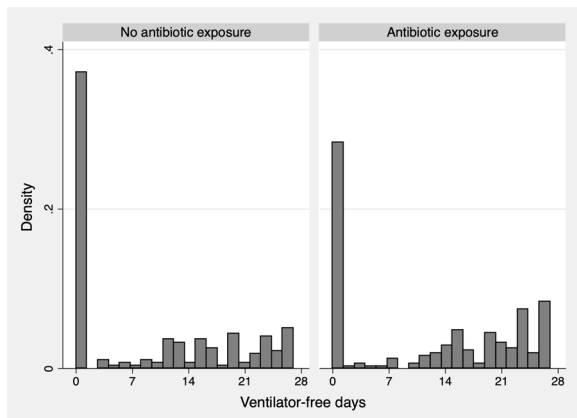

Figure 1 (abstract 001117) Histogram of ventilator-free days

References

1. Righy C, do Brasil PEA, Vallés J, Bozza FA, Martin-Loeches I. Systemic antibiotics for preventing ventilator-associated pneumonia in comatose patients: a systematic review and meta-analysis. *Ann Intensive Care*. 2017 Dec;7 (1):67. <https://doi.org/10.1186/s13613-017-0291-4>. Epub 2017 Jun 15. PMID: 28620893; PMCID: PMC5472643.
2. Sirvent JM. Antibiotic prophylaxis against ventilator-associated pneumonia in patients with coma: Where are we now? *Med Intensiva*. 2017 May;41 (4):248–251. English, Spanish. <https://doi.org/10.1016/j.medin.2016.09.005>. Epub 2016 Dec 18. PMID: 27998646.
3. No funding.

Topic: Infections and prevention

001118

CSF-LDH as a potential prognostic marker in acute bacterial meningitisA. R. Nogueira¹, J. E. Mateus¹, J. Rua¹, L. Linhares¹, M. Simões¹, P. Martins¹¹Intensive Care Unit, Centro Hospitalar e Universitário de Coimbra, Coimbra, Portugal**Correspondence:** J.E. Mateus

Intensive Care Medicine Experimental 2023, 11 (Suppl 1):001118

Introduction: Acute bacterial meningitis is a medical emergency that often requires the patient to be admitted to the ICU. Ensuring a timely diagnosis and an adequate management is important to reduce mortality and to improve the neurological outcome. Lumbar puncture is paramount in the diagnosis and treatment of acute meningitis. Increase in spinal fluid LDH level is an indication of either neuronal or glial cell injury.

Objectives: We aimed to characterize the patients with acute bacterial meningitis within an ICU setting and study the role of CSF leukocyte count, CSF glucose, CSF proteins and CSF-LDH in the prognosis of these patients.

Methods: We performed a retrospective analysis during a 10-year period of patients older than 18 years, admitted to a polyvalent ICU due to acute bacterial meningitis. Demographic, clinical and outcome data were collected from medical records in the electronic clinical file. Categorical data is presented as frequency (percentage). We performed a descriptive analysis. Continuous variables were correlated by Spearman correlations. Comparisons were made through Mann–Whitney tests. Statistical significance was set at $p < 0.05$.

Results: We identified 49 patients with the diagnosis of acute bacterial meningitis. Two thirds of the patients were male and the mean age was 54.8 years (std 17.6). The mortality during the ICU stay was 10.2%, the 28-day and 3-month mortality was 16.3% and 20.4%, respectively, and the 6-month mortality was 24.5%.

A definite microbiological diagnosis was achieved in 61.2% of the patients. *Listeria monocytogenes* and *Streptococcus pneumoniae* were the most common agents, accounting for 42.9% of the total cases.

CSF LDH was associated with increased leukocyte count ($r = 0.69$, $p < 0.001$), CSF proteins ($r = 0.44$, $p = 0.030$) and the need to perform External Ventricular Drainage (non EVD: 225.4 ± 393.6 vs. EVD: 683.5 ± 580.2 , $p = 0.009$). Although CSF-LDH is higher in patients who died in the follow-up, we found no statistically significant association with mortality.

Conclusions: CSF-LDH seems to have a role as a measure of assessment of severity of acute bacterial meningitis and the need for external ventricular drainage placement. Prospective studies could clarify its role as a potential prognostic marker.

References

1. Singh L, Javali M, Mehta A, Pradeep R, Srinivasa R, Acharya PT. Study of cerebrospinal fluid levels of lactate, lactate dehydrogenase and adenosine deaminase in the diagnosis and outcome of acute meningitis. *Neurol Res.* 2022 May;44 (5):463–467. <https://doi.org/10.1080/01616412.2021.2004366>.
2. Dash PC, Patro D. Role of CSF CK, LDH, GGTP Enzyme Levels in Diagnostic and Prognostic Evaluation of Meningitis. *J Clin Diagn Res.* 2014 Jul;8 (7):MC19-22. <https://doi.org/10.7860/JCDR/2014/9675.4615>.

Topic: Infections and prevention

001119

Status epilepticus: a life-threatening condition in the ICUP. Matía Almodévar¹, A. C. S.¹, M. S. N.¹, P. R. M.¹, B. I. E.¹, C. R. M.¹¹Intensive Care, Puerta de Hierro Majadahonda University Hospital, Majadahonda, Spain**Correspondence:** P. Matía Almodévar

Intensive Care Medicine Experimental 2023, 11 (Suppl 1):001119

Introduction: Status epilepticus (SE) is a prevalent condition which requires prompt and adequate identification and treatment to prevent excessive morbidity and mortality. This assertion become even more challenging when we refer to nonconvulsive status epilepticus (NCSE) which is a frequent form of seizures in the ICU.

Refractory status epilepticus (RSE) accounts for 12–48% of all status epilepticus in general population (1), but this number increases amongst ICU patients; furthermore, some of them will progress to super-refractory status epilepticus (SRSE).

Objectives: To describe our experience in SE management and prognosis, focusing on RSE, SRSE and NCSE.

Methods: Retrospective, observational study from January 2020 until December 2022 of all patients diagnose of SE upon ICU admission or who developed it during ICU stay in a Spanish tertiary hospital.

Results: During the period studied 18 SE were diagnosed in our ICU. Fourteen were RSE with nine progressing to SRSE (64) and nearly one third (5) were non-convulsive status epilepticus (NCSE).

In this group of patients, mean age was 52 ± 19 years old. 55% (10) were women. Mean APACHE II score was 18 ± 5 . Median ICU length of stay was 11 (2–30.5) days, median hospital length of stay was 19.5 (10.75–53.5) days.

Seventeen of them had at least one risk factor for developing SE: previous history of epilepsy (7), acute structural brain insult (6), lowering seizure threshold drugs (2), metabolic abnormalities (2), alcohol withdrawal syndrome (1) and longstanding structural brain injury (1). Regarding treatment, the antiseizure medication (ASM) of choice in the ICU was levetiracetam, used in more than 85% of the cases (16), followed by lacosamide (13), valproate (9), perampanel (8), clonazepam (7), and phenytoin (2).

Alongside with antiepileptic drugs, all of our patients but one received continuous IV sedation. Our first choice was the combination of propofol + remifentanyl (16), adding midazolam ($9 \pm$ ketamine (6). There was also one patient who received thiopental and one who received sevoflurane. Nearly two out of three (11) patients required two IV sedation drugs at the same time.

The median time among survivors to achieve adequate seizure control was 1 (0–11) days, and to fulfil IV sedation tapering, eleven patients (61%) received three or more AMS simultaneously.

Mean predicted mortality rate as given by APACHE II score was 29.1%, whereas mortality among RSE and SRSE in our cohort was 43% (6 out of 14) and 67% (6 out of 9) respectively, and it was even higher in NCSE patients, 80% (4 out of 5).

The main cause of death was withdrawal of life sustaining treatment due to grim neurological prognosis.

Conclusions: Non-convulsive status epilepticus, as well as refractory and super-refractory status epilepticus are neurological emergencies that increase mortality in ICU patients. Early identification and adequate treatment are of the utmost importance.

References

1. Alolayan YS, McKinley K, Bhatia R, Alkhachroum A. Review and Updates on the Treatment of Refractory and Super Refractory Status Epilepticus. *J Clin Med.* 2021; 10 (14):3028

Topic: Neurointensive care

001120

Comparative of cardiac output between minimally invasive hemodynamic monitoring vs cardiac output measured by Doppler ultrasoundD. Navarro Martínez¹, J. C. Gasca-Aldama¹, J. Garduño-López¹, M. A. Amezcua-Gutiérrez¹, M. Vidals-Sánchez¹, K. H. Lopez Rodriguez¹, R. D.

C. Gutiérrez Góngora¹, R. Rodríguez Villanueva¹, Sl. Alba Cuevas¹, J. E. Castrejón Sánchez¹, M. A. Juan Gomez¹, C. E. Lopez-Rodriguez¹
¹Adult intensive care unit, Hospital Juárez de México, Ciudad de México, Mexico

Correspondence: D. Navarro Martinez
 Intensive Care Medicine Experimental 2023, 11 (Suppl 1):001120

Introduction: Monitoring cardiac output (CO) and tissue oxygenation is part of the comprehensive management of critically ill patients in the Intensive Care Unit (ICU), especially those in shock. Cardiac output is the amount of blood flow ejected by the left (or right) ventricle in a unit of time, expressed in liters per minute and is the product of heart rate per stroke volume.

$CO (l/min) = \text{heart rate (beating/minute)} \times \text{stroke volume (liters)}$.

Traditionally cardiac output has been measured by thermodilution with a pulmonary artery flotation catheter (PAC) or Swan-Ganz catheter. The availability of newer, less invasive cardiac output devices has decreased the widespread use of the PAC.

The main ways of measuring cardiac output are: Fick's principle, Dilution techniques, Arterial wave analysis techniques, Ultrasound by Doppler principle.

Objectives: Research question: Is there a difference in the measurement of cardiac output reported by minimally invasive monitoring compared to cardiac output measured by ultrasonography?

General Objective: To compare the measurement of cardiac output measured through minimally invasive continuous monitoring compared with cardiac output measured by ultrasonography.

Methods: Type of study: Transversal, Observational, Prospective, Analytical—correlational.

Population: Patients admitted to the adult intensive care service of Hospital Juárez de México, from 18 to 85 years, who have minimally invasive cardiac output monitoring and cardiac window for ultrasonographic evaluation.

Resources: Minimally invasive continuous cardiac output monitor (Flotrac—Edwards Lifesciences™) & VENUE Ultrasound from General Electric™

Results: A total of 18 patients were studied, of which the mean age was 37.3 (± 8.2), the female gender was 16 patients (88.9%), 2 patients male (11.1%), the mean BMI 29.6 (± 5.9), SOFA mean 11.2 (± 3.1), APACHE II median was 17 (range 9–28), SAPS mean was 38.2 (± 13.9). The EV1000 values, the mean of SV was 73.8 (± 19), the mean of GC 7.26 (± 2.5), the mean of SVR 792 (range 629–1202). The measurements by ECOTT, the SV mean was 51.2 (± 14.8), the GC mean was 4.5 (± 1.6), the SVR mean 1291.7 (± 498), more details in Table 1.

Finally, given the only variable that showed significance, the CG was entered into a regression model resulting in an R 0.472 (47%) association, however, a squared or adjusted R² was performed, leaving R² 0.225 (22%). of association between the CG measured by EV1000 against the CG measured by ECOTT, which explains a weak association, the other variables did not show significance. Figure 1.

Conclusions: Cardiac output measurement using a minimally invasive monitor (by arterial pulse wave analysis) and the one obtained by transthoracic ultrasound do not correlate with each other in critically ill patients.

The measurement of central venous pressure by a pressure transducer and the one estimated by abdominal ultrasound in the subxiphoid window, have adequate correlation with each other, with statistical significance. However, the sample used in the study is a small population, so it deserves further study to obtain more data in this regard.

Table 1. General characteristics of the population.

Characteristics	n=18
Age, mean (±SD), years	37.3 (±8.2)
Gender, n (%), M	2 (11.1)
F	16 (88.9)
BMI, mean (±SD)	29.6 (±5.9)
SOFA, mean (±SD)	11.2 (±3.1)
APACHE II, median (IC)	17 (9-28)
SAPS II, mean (±SD)	38.2 (±13.9)
EV 1000	
SV 1000, mean (±SD)	73.8 (±19)
CO 1000, mean (±SD)	7.26 (±2.5)
SVR 1000, median (IC)	792 (629-1202)
ECOTT	
LVOT, mean (±SD)	1.99 (±.44)
VTI, mean (±SD)	19.9 (±4.9)
SV, mean (±SD)	51.2 (±14.8)
HR, mean (±SD)	97.1 (±22.3)
CO ECO, mean (±SD)	4.5 (±1.6)
SVR, mean (±SD)	1291.7 (±498)
E/e ⁺ , mean (±SD)	7.9 (±2.1)
PWP, mean (±SD)	11.6 (±2.6)
CVP, mean (±SD)	7.46 (±2.65)
LVOT VTI % Variability, median (IC)	9 (5-15)

Abbreviations: SD (Standard Deviation), IR (interquartile range), BMI (Body mass index), SOFA (Sequential Organ Failure Assessment), APACHE II (Acute Physiology and Chronic Health disease Classification System II), SAPS II (Simplified Acute Physiology Score II), SV (Stroke volume), CO (cardiac output), SVR (Systemic vascular resistance), LVOT (left ventricular outflow tract), VTI (velocity–time integral), PWP (pulmonary wedge pressure), CVP: central vein pressure, LVOT VTI (left ventricular outflow tract velocity–time integral).

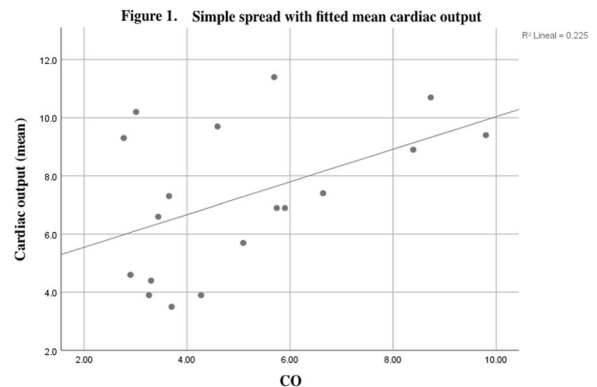

References

- Monnet X, Teboul JL. Transpulmonary thermodilution: advantages and limits. *Crit Care*. 2017 Jun 19;21 (1):147.
- Koratala A, Kazory A. Point of Care Ultrasonography for Objective Assessment of Heart Failure: Integration of Cardiac, Vascular, and Extravascular Determinants of Volume Status. *Cardiorenal Med*. 2021;11 (1):5–17.
- Kouz K, Scheeren TWL, de Backer D, Saugel B. Pulse wave analysis to estimate cardiac output. *Anesthesiology*. 2021 Jan 1;134 (1):119–26.
- Thiele RH, Bartels K, Gan TJ. Cardiac Output Monitoring: A Contemporary Assessment and Review. *Crit Care Med [Internet]*. 2015;43 (1). Available from: https://journals.lww.com/ccmjournal/Fulltext/2015/01000/Cardiac_Output_Monitoring__A_Contemporary.21.aspx
- Kobe J, Mishra N, Arya VK, Al-Moustadi W, Nates W, Kumar B. Cardiac output monitoring: Technology and choice. *Ann Card Anaesth*. 2019 Jan;22 (1):6–17.
- Alhashemi JA, Cecconi M, Hofer CK. Cardiac output monitoring: an integrative perspective. *Crit Care*. 2011 Mar 22;15 (2):214.
- Kolb B, Kapoor V. Cardiac output measurement. *Anaesth Intensive Care Med*. 2019 Mar 1;20 (3):193–201.
- Saugel B, Cecconi M, Wagner JY, Reuter DA. Noninvasive continuous cardiac output monitoring in perioperative and intensive care medicine. *Br J Anaesth*. 2015 Apr 1;114 (4):562–75.
- I would like to thank all the medical staff of the intensive care unit of Hospital Juarez de México and Dr. Gasca Aldama for their support in carrying out this work.

Topic: Cardiovascular issues in ICU

001122

Antibiotics for surgical prophylaxis are associated with immunosuppression in vitro

R. Haque¹, T. A. C. Snow¹, A. V. Waller¹, F. Ryckaert¹, A. Cesar¹, D. Brealey², J. Whittle³, M. Singer¹, N. Arulkumaran¹

¹Bloomsbury Institute of Intensive Care Medicine, University College London, London, United Kingdom; ²Critical Care, UCL Hospitals NHS Foundation Trust, London, United Kingdom; ³Perioperative Prehabilitation and Human Physiology and Performance Laboratory, University College London, London, United Kingdom

Correspondence: T.A.C. Snow

Intensive Care Medicine Experimental 2023, **11 (Suppl 1)**:001122

Introduction: Sterile inflammation induced by major surgery results in simultaneous activation of the immune system. Antibiotics are often prescribed following sterile surgery to reduce the risk of post-operative infections. Antibiotics are known to modulate the immune system. We hypothesised that antibiotics often used for prophylaxis following surgery result in impaired immune response to a bacterial stimulus, which may paradoxically increase the risk of late post-operative infections.

Objectives: Identify if amoxicillin, cefuroxime and metronidazole impair the innate immune (monocyte and granulocyte) response to a bacterial stimulus in vitro.

Methods: Healthy volunteer (n=16) whole blood was incubated in vitro with heat-killed *E. coli* (HKB) and antibiotics for 6 h. Amoxicillin, cefuroxime, metronidazole, and combined cefuroxime-metronidazole were used at concentrations of 5, 15 and 45mcg/ml to represent, sub-clinical, clinical, and supra-clinically relevant concentrations respectively.

Flow cytometry was used to assess markers of granulocyte (migration (CXCR4), activation (CD16, CD66b, CD86), cytokines (IL-1 β , IL-6, and TNF- α)) and monocyte (antigen presentation (HLA-DR, and CD86), chemotaxis (CCR2 and CXCR4), cytokines (IL-1 β , IL-6, and TNF- α), T-cell suppression (PD-L1)) function.

Results: Each antibiotic in isolation resulted in minimal or no alterations to markers of immune function. However, cefuroxime and metronidazole in combination caused an increase in granulocyte TNF- α (a), and in monocytes decreased PD-L1, HLA-DR, CXCR4, and CCR2 expression (b–e).

Conclusions: Commonly prescribed surgical antimicrobial prophylaxis induce features of impaired immune function, particularly monocyte

chemotaxis and antigen presentation (HLA-DR). It needs to be evaluated if lymphocytes are affected, if similar changes occur in patients, and the clinical consequences.

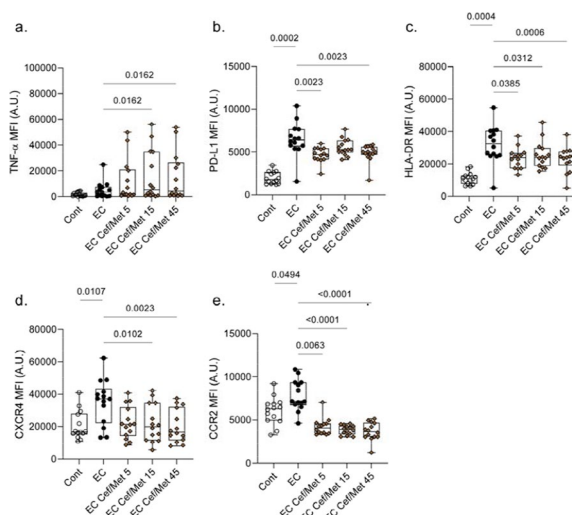

Data presented as individual data points (n=16), horizontal line (median), box (interquartile range) and whisker (range). Difference between Control (Cont) and *E. coli* (EC) compared using Wilcoxon test, and between EC and all doses of cefuroxime (Cef) with metronidazole (Met) with *E. coli* using Friedman test without post-hoc correction. Only p-values <0.05 shown.

References

6. Carlier, M., et al. Population pharmacokinetics and dosing simulations of cefuroxime in critically ill patients: non-standard dosing approaches are required to achieve therapeutic exposures. *J Antimicrob Chemother*. 2014. 69 (10): 2797–803
5. Marti, C., et al. Therapeutic drug monitoring and clinical outcomes in severely ill patients receiving amoxicillin: a single-centre prospective cohort study. *Int J Antimicrob Agents*. 2022. 59 (6): 106601
4. Fowler, A.J., et al. Liberal or restrictive antimicrobial prophylaxis for surgical site infection: systematic review and meta-analysis of randomised trials. *Br J Anaesth*. 2022. 129 (1): 104–113
3. Snow, T.A.C., et al. Commonly used antibiotics may worsen sepsis induced lymphocyte dysfunction an ex vivo model—ESICM LIVES 2022: part 2. *ICMx*, 2022. 10 (2): 001414
2. Waller, A.V., et al. Immunosuppressive phenotypes and therapeutic targets following major surgery: a prospective cohort study—ESICM LIVES 2022: part 1. *ICMx*, 2022. 10 (2): 001087
1. O'Dwyer, M.J., et al. The perioperative immune response. *Curr Opin Crit Care*, 2015. 21 (4): p. 336–42
7. Frasca, D., et al. Metronidazole and hydroxymetronidazole central nervous system distribution: 2. cerebrospinal fluid concentration measurements in patients with external ventricular drain. 2014. 58 (2): 1024–7
8. BJA/RCoA Project Grant (2022)

Topic: Perioperative care

001123

Effect of vasopressor titration in hypoperfused patients with septic shock: assessment of cardiac performance, tissue perfusion, splanchnic artery resistance, and venous return

E. D. Valenzuela Espinoza¹, V. Oviedo¹, P. Mercado², N. Severino¹, P. Born¹, R. Ulloa¹, R. Contreras¹, J. Ramirez¹, C. González¹, L. Alegria¹, D. Soto¹, E. Kattan¹, R. Castro¹, A. Bruhn¹, G. Hernandez¹, J. Bakker³

¹Departamento de medicina intensiva, Pontificia Universidad Católica de Chile, Santiago, Chile; ²Departamento de paciente crítico, Clínica

Alemana, Vitacura, Chile; ³Department of intensive Care Adults, Erasmus University Medical Center, Rotterdam, Netherlands

Correspondence: E.D. Valenzuela Espinoza

Intensive Care Medicine Experimental 2023, **11** (Suppl 1):001123

Introduction: Among resuscitative interventions for patients with septic shock and persistent hypoperfusion signals (capillary refill time > 3 s or serum lactate > 2 mmol/L) after adequate fluid administration, increasing mean arterial pressure (MAP) from 65 to 85 mmHg in previously hypertensive patients could improve end-organ perfusion. However, vasopressor titration (either increasing norepinephrine dose or adding vasopressin) could also deteriorate cardiac performance, splanchnic artery resistance or renal function, leading to worse clinical outcomes.

Objectives: We report the initial results of an ongoing physiologic randomized controlled study comparing vasopressin vs placebo to target a higher MAP in septic shock patients. However, the aim of this one is to assess the multidimensional impact of vasopressor titration to achieve a MAP of 85 mmHg on cardiovascular performance, tissue perfusion, splanchnic artery flow, venous return, and renal function in mechanically ventilated, fluid-unresponsive patients with septic shock who had a history of hypertension.

Methods: We increased the MAP from 65 to 85 mmHg in patients who continued to experience hypoperfusion despite achieving adequate fluid resuscitation and a MAP of 65 mmHg. MAP was increased either with norepinephrine alone or by adding vasopressin (0.03 UI/min) to achieve the MAP target of 85 mmHg for 24 h. We conducted a comprehensive ultrasound assessment. Echocardiography, Doppler resistance index of the liver, spleen, and kidneys, capillary refill time (CRT) and lactate levels were assessed at baseline, after 1 h of achieving the new MAP target (85 mmHg), and again at 24 h. Renal and cardiac biomarkers were assessed at baseline and at 24 h after achieving the MAP target. Statistical analysis was performed using the SPSS. A p-value < 0.05 was considered significant. This study was supported by FONDECYT 11201220.

Results: Fourteen patients (age 69 ± 11 yr, 50% female) were included in this preliminary report. At baseline the APACHE II score was 20 ± 7 and SOFA score was 9 ± 3. Norepinephrine was used as the only vasopressor in 8/14 (57%) patients, while in the remaining 6 (43%) patients, vasopressin was added to norepinephrine as indicated. The main cardiovascular performance parameters, splanchnic perfusion parameters, and biomarkers are presented in Table 1. After 1-h, systolic volume increased by more than 10% in 7/14 (50%) patients, showed no change in 5/14 (35%) patients, and decreased in 2 (14%) patients. Splanchnic artery resistance did not change significantly, whereas portal venous velocity increased significantly due to splanchnic venous return. Capillary refill time improved in 5/6 patients (83%) who previously had an abnormal value (6.5 s [IQR 4.4–10] vs 3.7 s [IQR 2.6–6], p = 0.026) and did not change in 8 patients who were within normal range. In 5/9 (55%) patients with increased lactate improved at least 10% in 1-h and increased in 2/5 (40%) patients who had a normal lactate level. Tissue perfusion improved in 7/14 (50%) patients, did not change in 2/14 (14%) patients, and deteriorated in 5/14 (36%) patients at 24 h. Acute kidney injury was present in eight patients (57%). Renal support therapy was initiated in 3 (21%) patients. The ICU mortality was 42%, 5 out of 6 non-survivors did not improve tissue perfusion at 24 h.

Conclusions: In mechanically ventilated patients with septic shock who exhibited persistent hypoperfusion despite achieving adequate fluid resuscitation and a MAP of 65 mmHg, and history of previous hypertension, increasing the MAP from 65 to 85 mmHg improved tissue perfusion in most cases. Despite this significant increase in vasoconstriction, cardiac performance and markers of regional perfusion and biomarkers of organ function did not worsen, showing the safety of this strategy. The final results of the study will further increase our understanding of improving tissue perfusion by manipulating MAP.

Table 1. Cardiovascular performance parameters, splanchnic perfusion parameters, biomarkers, and tissue perfusion.

	At baseline	1 hour	24 hours	P
	MAP 65 mmHg	MAP 85 mmHg	MAP 85 mmHg	value
NE, mcg/kg/min	0.13 (0.08-0.19)	0.18 (0.14-0.39)	0.39 (0.09-0.60)	0.017
Vasopressin (0.03 UI/min) + NE, mcg/kg/min	0.11 (0.06-0.36)	0.12 (0.11-0.30)	0.15 (0.01-0.38)	0.854
Heart rate, beats/min	94 (78-106)	94 (77-108)	91 (72-104)	0.423
Echocardiography				
Left Ventricular Ejection Fraction, %	62 (58-64)	65 (55-72)	63 (62-73)	0.292
LVOT VTI, cm	18 (17-21)	21 (18-25)	20 (15-26)	0.368
RV Fractional Area Change, %	47 (41-57)	68 (52-75)	39 (31-52)	0.017
TAPSE, mm	19 (17-20)	20 (18-23)	21 (16-24)	0.584
Mitral Doppler E wave, cm/sec	67 (55-76)	71 (63-89)*	70 (50-83)	0.063
Systolic Pulmonary Artery Pressure, mmHg	25 (23-34)	33 (27-36)	32 (21-37)	0.060
IVC diameter, mm	18.4 (16.7-21.1)	20.5 (17.5-24.5)	20.4 (15.0-25.7)	0.368
Abdominal Doppler				
Renal arterial resistance index	0.77 (0.71-0.80)	0.76 (0.72-0.79)	0.75 (0.72-0.80)	0.368
Hepatic arterial resistance index	0.70 (0.64-0.73)	0.72 (0.68-0.75)	0.67 (0.63-0.73)	0.109
Splenic arterial resistance index	0.70 (0.63-0.75)	0.73 (0.67-0.76)	0.64 (0.61-0.70)	0.223
Portal venous velocity, cm/sec	17 (14-19)	21 (17-22)*	18 (13-24)	0.205
Suprahepatic Doppler, S wave, cm/sec	40 (24-46)	38 (28-48)	37 (28-43)	0.913
Suprahepatic Doppler, D wave, cm/sec	27 (19-34)	25 (17-33)	23 (16-29)	0.148
Suprahepatic Doppler, A wave, cm/sec	19 (15-34)	20 (16-36)	23 (20-35)	0.121
Biomarker				
Troponin T, pg/ml	66 (25-138)	62 (22-138)	63 (20-119)	0.734
ProBNP, pg/ml	4686 (420-7137)	5223 (413-6683)	819 (378-9039)	0.529
Serum NGAL, pg/ml	0.09 (0.05-0.14)	0.09 (0.06-0.12)	0.09 (0.06-0.15)	0.472
Urine NGAL, pg/ml	0.17 (0.04-0.19)	-	0.17 (0.04-0.20)	0.624
Serum creatinine, mg/dL	1.39 (0.84-2.27)	-	1.16 (0.88-1.98)	0.944
Creatinine C, pg/ml	1.85 (1.55-2.26)	-	2.08 (1.29-3.16)	0.110
Tissue perfusion parameters				
Capillary Refill Time, sec	3 (2-6.5)	2 (1.7-3.7)	2 (2-3.5)	0.025
Lactate, mmol/L	2.4 (1.5-4.2)	2.4 (1.8-4.2)	2.1 (1.7-4.1)	0.487

Continuous data were expressed as median (25th–75th percentiles); * represent significant difference between baseline and 1 hour (MAP target, 85 mmHg); MAP = median arterial pressure; NE = norepinephrine; LVOT = left ventricular outflow tract; VTI = velocity time integral; TAPSE = tricuspid annular plane systolic excursion; RV = right ventricle; IVC = inferior vena cava; NGAL = Urinary neutrophil gelatinase-associated lipocalin.

References

- FONDECYT de iniciación 11201220

Topic: Sepsis

001124

Comparison between venoarterial CO₂ tension difference to arteriovenous O₂ content difference ratio and respiratory quotient by indirect calorimetry in septic shock patients: an observational cohort study

F. J. Gutierrez¹, M. Mugno², P. N. Rubatto Birri², S. P. Chapela³, N. D. Llobera³, M. J. Reberendo³, V. Eduf⁴, G. E. Murias¹, M. O. Pozo¹, A. Dubin⁴

¹Intensive Care Unit, Hospital Británico de Buenos Aires, AEB, Argentina;

²Intensive Care Unit, Sanatorio Otamendi, Buenos Aires, Argentina;

³Nutrition Support Team, Hospital Británico de Buenos Aires, AEB, Argentina; ⁴Cátedra de farmacología aplicada, Universidad Nacional de La Plata, Facultad de Ciencias Médicas, La Plata, Argentina

Correspondence: F.J. Gutierrez

Intensive Care Medicine Experimental 2023, **11** (Suppl 1):001124

Introduction: Respiratory quotient (RQ) is the ratio of carbon dioxide production (VCO₂) to oxygen consumption (VO₂). Under aerobic conditions, it is primarily determined by energy sources. In anaerobic conditions, there are sharp increases in the RQ related to anaerobic VCO₂. RQ is measured by analysis of expired gases through a metabolic chart, which is not usually available in the ICU. It has been proposed that the ratio of venoarterial PCO₂ difference to arteriovenous oxygen content difference (Pv-aCO₂/Ca-vO₂) could be used as a surrogate for RQ. In observational studies, a value higher than 1.4 has been associated with hyperlactatemia and outcome (1). Since metabolic acidosis and hemodilution are strong predictors of Pv-aCO₂/Ca-vO₂, this relationship does not reflect anaerobic metabolism (2). In experimental studies, the correlation between RQ and Pv-aCO₂/Ca-vO₂ is only poor. To the best of our knowledge, these variables have not been compared in critically ill patients.

Objectives: To compare the respiratory quotient measured by indirect calorimetry with Pv-aCO₂/Ca-vO₂. We hypothesized that the variables were not interchangeable.

Methods: Septic shock patients (n = 47) undergoing mechanical ventilation with stable hemodynamic and respiratory conditions were recruited from two surgical/medical ICU. VO₂, VCO₂ and RQ were recorded breath-by-breath using an indirect calorimeter over a 30-min period.

In arterial and central venous blood samples, drawn at the end of this period, we measured gases, O₂Hb and hemoglobin to calculate Pv-aCO₂/Ca-vO₂. Oxygen contents were calculated using standard formulae.

The relationship between RQ and Pv-aCO₂/Ca-vO₂ was assessed using Pearson's correlation and Bland-Altman analysis. Bivariate linear regression analysis with Pv-aCO₂/Ca-vO₂ as the outcome variable was conducted, and variables showing a *P* value < 0.30 were entered into a multiple linear regression model, looking for its determinants.

Results: No correlation was found between the RQ measured by indirect calorimetry and Pv-aCO₂/Ca-vO₂ (*r* = -0.10, *P* = 0.50) (Figure 1). The bias between both variables was 1.09, and the 95% limits of agreement were -1.10–3.27.

The multiple linear regression model showed that Hb, venous PCO₂, and venous O₂Hb as Pv-aCO₂/Ca-vO₂ determinants (*R*² = 0.36, *P* = 0.0007).

Conclusions: This is the first study performed in critically ill patients, comparing RQ and Pv-aCO₂/Ca-vO₂. Neither variable was correlated and showed unacceptable-wide limits of agreement. The Haldane effect and Hb levels, but not the RQ, are determinants of Pv-aCO₂/Ca-vO₂.

Our data showed that Pv-aCO₂/Ca-vO₂ is a poor surrogate for RQ and raises concerns regarding its use for the assessment of tissue oxygenation.

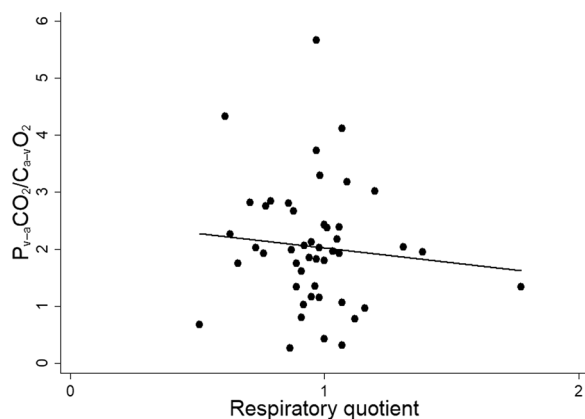

Figure 1 (abstract 001124) Scatter plot between the RQ measured by indirect calorimetry and Pv-aCO₂/Ca-vO₂

References

- 1-Mekontso-Dessap A, Castelain V, Anguel N, et al. Combination of venoarterial PCO₂ difference with arteriovenous O₂ content difference to detect anaerobic metabolism in patients. *Intensive Care Med.* 2002;28 (3):272–7.
- 2-Dubin A, Ferrara G, Kanoore Edul VS, et al. Venoarterial PCO₂-to-arteriovenous oxygen content difference ratio is a poor surrogate for anaerobic metabolism in hemodilution: an experimental study. *Ann Intensive Care.* 2017;7 (1):65.
3. This research received no external funding.

Topic: Sepsis

001126

Development of a VR-simulation, a UCD mixed method study

K. Hoek¹, N. Groeneveld²

¹Intensive Care, LUMC, Leiden, France; ²Intensive care, Leiden University Medical Center (LUMC), Leiden, Netherlands

Correspondence: K. Hoek

Intensive Care Medicine Experimental 2023, **11 (Suppl 1)**:001126

Introduction: Simulation training in medical settings is becoming a cornerstone of clinical training (Anthony, 1996; Yunoki & Sakai, 2018). Virtual reality (VR) is a new method of delivering simulation offering several potential benefits for trainer and trainees as an alternative to full-body mannequins based training. Through the Proteus effect trainees can feel present while being fully immersed in a virtual world (Bian et al., 2015; Navarro et al., 2022). VR simulation may affect attitudes, perception and behaviour enhancing active learning. VR-simulation can generate personalised scenario's effective for differentiated learning, as it enables practicing situational awareness, decision making, triages of possible actions and other multitiered response systems in a highly stressful, but safe environment.

Objectives: The main objective of this study was to develop and evaluate a VR-scenario training program for anaesthesiologist-intensivists tailored to the needs and experience of the trainees and simulation trainers with a multidisciplinary expert team involved throughout the development process to guide all design decisions. Physiological features of the patient were adaptable by the trainer via a trainer dashboard to be able to induce stress amongst trainees and train performance and crisis resource management under pressure. The VR-simulation was built for multiplayer use.

The authors explored user experiences of trainees and a trainer during a final evaluation of the VR-simulation. They identified a workflow for all basic components of the VR application for further development and extension of the VR-simulation.

Methods: This user-centered design (UCD) used an iterative design process to develop a VRsimulation for anaesthesiologist-intensivists. The protocol was approved by the Institutional Science Committee and received a certificate of no rejection from the Institutional Review Ethics Committee. The multidisciplinary expert team consisted of one anesthesiologist, one intensivist, one resident, and two VR-developers. The authors adapted the Failure Modes and Effects Analysis (FMEA) as it identifies possible system failures and vulnerabilities in complex processes (Ashley et al., 2010; Davis et al., 2008). The authors assessed content validity and face validity through a final evaluation. Quantitative outcome measures included the Virtual Embodiment Questionnaire and the Multimodal Presence Scale, expressed in frequencies and percentages. Qualitative outcome measures with focus group interviews were analysed adapting a thematic analysis framework.

Results: Three simulation prototype iterations were made, each evaluated with a simulation setting, debriefing and FMEA with the multidisciplinary expert team. After every simulation, feedback was provided to the mechanical engineering team, designs iterations were made and the modified prototype was tested and adapted until thematic saturation was achieved. Five trainees and one trainer were included in the final evaluation of the VR-simulation. Quantitative outcome measures and qualitative outcome measures reported potency of the VR-simulation with sentiment of *presence* and effective *immersion*. No serious adverse events were reported.

Conclusions: This study elaborated on the development of a VR-scenario training program with the potency of experimental learning with VR. It may contribute to further research and healthcare educational programs avid to use immersive simulation learning with VR.

References

1. Yunoki, K., & Sakai, T. (2018). The role of simulation training in anesthesiology resident education. *J Anesth*, 32 (3), 425–433.
2. Navarro, J., Peña, J., Cebolla, A., & Baños, R. (2022). Can Avatar Appearance Influence Physical Activity? User-Avatar Similarity and Proteus Effects on Cardiac Frequency and Step Counts. *Health Commun*, 37 (2), 222–229
3. Davis, S., Riley, W., Gurses, A. P., Miller, K., & Hansen, H. (2008). Failure Modes and Effects Analysis Based on In Situ Simulations: A Methodology to Improve Understanding of Risks and Failures. In K. Henriksen, J. B. Battles, M. A. Keyes, & M. L. Grady (Eds.), *Advances in Patient Safety: New Directions and Alternative Approaches* (Vol. 3: Performance and Tools).
4. Bian, Y., Zhou, C., Tian, Y., Wang, P., & Gao, F. (2015). The Proteus Effect: Influence of Avatar Appearance on Social Interaction in Virtual Environments. *HCI*,

- Ashley, L., Armitage, G., Neary, M., & Hollingsworth, G. (2010). A practical guide to failure mode and effects analysis in health care: making the most of the team and its meetings. *Jt Comm J Qual Patient Saf*, 36 (8), 351–358.
- Anthony, G. (1996). Active Learning in a Constructivist Framework. *Educational Studies in Mathematics*, 31 (4), 349–369. <http://www.jstor.org/stable/3482969>
- This work was supported by the Tech For Future, Centre of Expertise on research in High Tech Systems and Materials.

Topic: Critical care organisation, quality management, information systems, outcomes

001127

Novel staging system (AVEX stage) predicts survival in patients with severe COVID-19 who received ECMO: analysis of the Japanese national registry

S. Ohshimo¹, S. Takaki², N. Shime¹, K. Liu², T. Ogura², K. Shimizu², S. Kushimoto², S. Hashimoto², Y. Fujino², S. Takeda²

¹Department of Emergency and Critical Care Medicine, Hiroshima University, Hiroshima, Japan; ²Japan ECMO Network, Kawaguchi, Japan

Correspondence: S. Ohshimo

Intensive Care Medicine Experimental 2023, **11** (Suppl 1):001127

Introduction: A staging system to predict the survival of severe coronavirus disease 2019 (COVID-19) could be useful for the appropriate allocation of medical resources. However, appropriate systems to predict survival of severe COVID-19 patients receiving ECMO were not well established.

Objectives: To develop a novel staging system to predict survival of patients with severe COVID-19 receiving ECMO.

Methods: We developed a prospective national registry covering > 80% of intensive care units in Japan. Patients with severe COVID-19 who received ECMO were divided into two groups: a development cohort and a validation cohort. Using variables identified by a Cox proportional hazards model associated with survival in patients with severe COVID-19 who received ECMO, AVEX score (Age, Ventilator days before starting ECMO and institutional Experience of ECMO for COVID-19) was developed. Each score was defined as follows and a total score of 0 to 5 was calculated: age \geq 59 years, 2 points; age < 59 years, 0 points; ventilator days before starting ECMO \geq 2 days, 2 points; ventilator days < 2 days, 0 points; institutional ECMO experience for COVID-19 < 10 cases, 1 point; experience \geq 10 cases, 0 points. According to the AVEX score, AVEX stages were defined as follows: 0–1 points were defined as stage 1, 2–3 points as stage 2 and 4–5 points as stage 3. The association between AVEX stage and survival was analyzed using the Kaplan–Meier method.

Results: A total of 9,745 patients received mechanical ventilation, of whom 1,214 (12%) received ECMO between January 2020 and October 2021. The overall survival rate of patients who received ECMO was 64%. The number of patients in the development cohort with AVEX scores of 0, 1, 2, 3, 4 and 5 points was 95 (16%), 78 (13%), 149 (25%), 133 (22%), 72 (12%) and 80 (13%), respectively. The number of patients in the development cohort with AVEX stages 1, 2 and 3 were 173 (29%), 282 (46%) and 152 (25%), respectively. The 90-day survival rates were 84%, 64% and 41%, respectively. AVEX stage was significantly associated with survival ($p < 0.001$).

The number of patients in the validation cohort with AVEX stages 1, 2 and 3 were 185 (30%), 280 (46%) and 142 (23%), respectively. The 90-day survival rates were 82%, 67% and 51%, respectively. We confirmed that the AVEX stage was significantly associated with survival in the validation cohort ($p < 0.001$).

Conclusions: AVEX staging system significantly predicted 90-day survival in patients with severe COVID-19 who received ECMO.

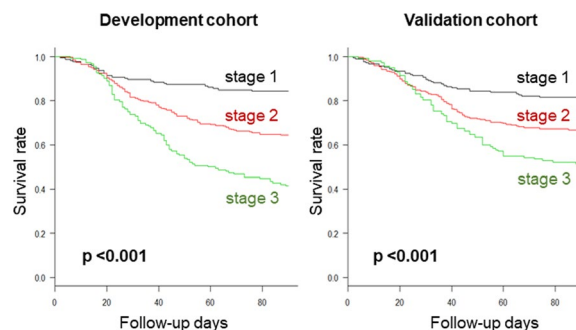

Kaplan–Meier curves showing the association between a novel staging system (AVEX stage) and survival in severe COVID-19 patients who received ECMO. Kaplan–Meier curves for (A) the development cohort and (B) the validation cohort.

References

- This work was supported by the Japan Agency for Medical Research and Development (AMED, number 22fk0108654h0001).

Topic: Acute respiratory failure and mechanical ventilation

001128

Efficacy of diaphragmatic tissue doppler imaging parameters in predicting weaning outcomes in critically ill adults

R. R. Bikash¹, G. Chandran¹, P. Khanna¹, K. A. Rahul², D. K. Baidya³

¹Anaesthesia, Pain Medicine & Critical Care, All India Institute Of Medical Sciences, New Delhi, New Delhi, India; ²Anaesthesiology, Pain Medicine & Critical Care, All India Institute Of Medical Sciences, New Delhi, India;

³Anaesthesia, pain medicine and critical care, All India Institute Of Medical Sciences, New Delhi, India

Correspondence: R.R. Bikash

Intensive Care Medicine Experimental 2023, **11** (Suppl 1):001128

Introduction: Ultrasonic parameters like the diaphragm thickness (DT) and diaphragmatic excursion (DE) are being increasingly used to measure diaphragmatic function during mechanical ventilation. Advanced doppler modes like Pulse wave Tissue Doppler imaging (PW-TDI) can be used to quantify the peak velocity of the diaphragm which reflects the diaphragmatic strength. However, TDI of the diaphragm has been scarcely used to assess the characteristics of diaphragmatic contraction and relaxation. We hypothesize that, diaphragmatic TDI can help predict weaning in critically ill mechanical ventilated patients.

Objectives: To determine the diagnostic accuracy of diaphragmatic PW-TDI parameters in predicting weaning outcomes in critically ill mechanically ventilated patients. We also compare the performance of TDI derived parameters with that of conventional ultrasound-based parameters for prediction of weaning and outcomes.

Methods: Forty mechanically ventilated patients eligible for spontaneous breathing trial (SBT) after a minimum 48 h of mechanical ventilation were included in the study. Conventional 2D parameters {DE, DT, Diaphragmatic Thickening Fraction (DTF), DE time index (DETI) & Diaphragmatic Rapid Shallow Breathing Index (RSBI)} & Tissue Doppler parameters {peak contraction velocity, peak relaxation velocity, inspiratory velocity time integral (VTI) and expiratory VTI} were measured at end of SBT. Patients were classified as weaning success (WS) or weaning failure (WF) depending on requirement of respiratory support within 48 h of extubation.

Results: Half of the patients had successful weaning and extubation. The PW-TDI parameters: contraction velocity, relaxation velocity, inspiratory VTI and expiratory VTI; were found to have low sensitivity (50%, 45%, 50% & 55% respectively) and high specificity (100%, 100%, 95% & 90% respectively) for prediction of successful weaning. Among all parameters, contraction velocity was found to be the independent predictor of successful weaning, from logistic regression analysis and the inspiratory VTI had the best discriminating ability with a AUC 0.985, 95% CI 0.884–0.993. The AUC curves of all the parameters of PW-TDI were better than that of RSBI. The AUC curves of the two models using 2D and PW-TDI parameters were found to be comparable (0.86 vs. 0.87) and both are similar in predicting outcomes.

Conclusions: PW-TDI measurement of diaphragm during weaning is a promising new tool in predicting weaning outcomes. All TDI parameters performed better than RSBI for prediction of successful weaning and are found to be comparable to the conventional 2D diaphragm measurements.

References

1. Soilemezi E, Savvidou S, Sotiriou P, Smyrniotis D, Tsagourias M, Matamis D. Tissue Doppler Imaging of the Diaphragm in Healthy Subjects and Critically Ill Patients. *American Journal of Respiratory and Critical Care Medicine*. 2020;202 (7):1005–1012.
2. Sassoon C, Zhu E, Fang L, Wang D. Ventilator-Induced Diaphragm Dysfunction: Influence of Animal Species. *Chest*. 2011;140 (4):406A

Topic: Acute respiratory failure and mechanical ventilation

001130

Measurement of muscle mass through tomography in obese patients admitted to the intensive care unit as a prognostic factor

R. D. C. Gutiérrez Góngora¹, J. Garduño-López², M. A. Molina Castañeda², L. G. Duque Florez², M. A. Amezcua-Gutiérrez¹, R. Rodríguez Villanueva¹, D. Navarro Martínez³, A. Rodríguez Blas², S. I. Alba Cuevas¹, M. Vidals-Sánchez⁴, E. Hernández-Dominguez², J. C. Gasca-Aldama¹, K. H. Lopez Rodriguez⁴, G. A. Patiño Ceron⁶

¹Adult Intensive Care Unit, Hospital Juárez de México, Ciudad de México, Mexico; ²Imagenology, Hospital Juárez de México, Ciudad de México, Mexico; ³Unidad de Cuidados Intensivos, Hospital Juárez de México, Ciudad de México, Mexico; ⁴Adults intensive care unit, Hospital Juárez de México, Ciudad de México, Mexico; ⁵Intensive Care Unit, Hospital Juárez de México, Ciudad de México, Mexico; ⁶Internal Medicine, Magdalena De Las Salinas, Ciudad de México, Mexico

Correspondence: R.D.C. Gutiérrez Góngora

Intensive Care Medicine Experimental 2023, **11** (Suppl 1):001130

Introduction: Sarcopenic obesity is defined as the presence of dysfunction and low muscle mass, its associated with higher mortality and complications in critically ill patients, Low muscle mass, a component of sarcopenia, is proposed as an independent predictor of poor outcome including fewer ventilator-free days, longer ICU stay, hospitalization, and higher mortality.

Despite de gold standard of muscle mass measurement with CT scan is at L3 level, the measurement of T12 level has proven to be equally valid.

SMI (Skeletal Muscle Index) values of <46.2 cm²/m² (men), <30.6 cm²/m² (women) established as a component of the diagnosis of sarcopenia.

In concern to measurement tools, are proposed methods such as MRI, densitometry, bioimpedance, which are complex to implement in critically ill patients and hospitals with limited resources. Most patients admitted to ICU have chest CT scan as an ordinary study. The measurement of muscle mass at the t12 level could be useful to diagnose low muscle mass and this could be a predictive factor of complications.

Objectives: Primary outcome: Determine if obese patients with low muscle mass have greater mortality during their admission to ICU.

Secondary Outcomes: Determine if obese patients with low muscle mass have more complications such as, higher days of mechanical ventilation, ICU stay length, acute kidney injury, renal replacement, vasopressor use and intrahospital infections.

Methods: Cross-sectional study, Observational, Descriptive, retrospective

The total number of patients with Obesity were diagnosed by BMI greater than 30 who were admitted to the ICU of the Hospital Juárez de México from October 2022 to February 2023, including patients who had chest CT scan in the first 4 days of hospital admission It was performed Imaging measurements of the muscle area at the T12 level, defining the paraspinial, transverse, oblique, and rectus abdominis muscles. A review of the files of these patients was carried out to determine and record their clinical evolution.

Results: The data collected statistically evaluated with the statistical program SPSS v23

Of the twenty initial patients included, seven were discarded, obtaining an N of thirteen patients, with average age of 44 years, average BMI of 34.1, 61.5% women, 38.5% men, SMI mean of 22; a 100% of the patients had low muscular mass, 38.4% result on death during ICU stay. The OR was not significant for predicting mortality risk associated with low muscle mass. OR de 0.222 IC (0.020–2.451).

Conclusions: We cannot compare the groups of obese patients with low muscular mass and mean muscular mass because all patients had low muscular mass, we had non significant -statistical data about mortality, ICU stay length, mechanical ventilation length, Acute Kidney Injury, Metabolic control, or prognosis association with SOFA, APACHE, SAPS or NUTRIC Score; a bigger sample group is a required to obtain more significant results.

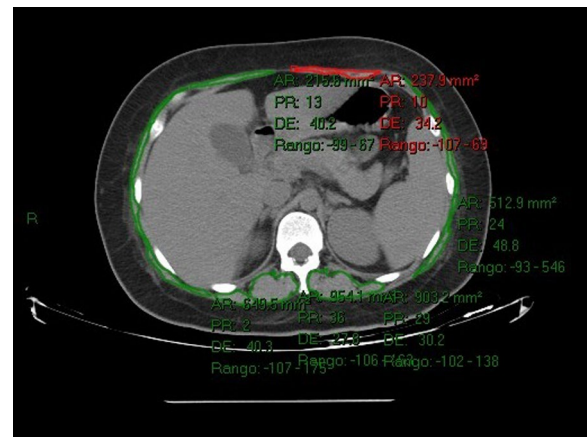

Measurement of muscle mass at the level of T12

References

1. Choi, KM (2016). Sarcopenia and sarcopenic obesity. *The Korean Journal of Internal Medicine*, 31 (6), 1054–1060.
2. Jiang T, Lin T, Shu X, Song Q, Dai M, Zhao Y, Huang L, Tu X, Yue J. Prevalence and prognostic value of pre-existing sarcopenia in patients with mechanical ventilation: a systematic review and meta-analysis. *Crit Care*. 2022 May 16;26 (1):140 3. Boutin, RD, Yao, L., Canter, RJ, & Lenchik, L. (2015). Sarcopenia: Current Concepts and Imaging Implications. *American Journal of Roentgenology*, 205 (3), W255–W266.
4. Moisey LL, Mourtzakis M, Cotton BA, Premji T, Heyland DK, Wade CE, et al. Skeletal muscle predicts ventilator-free days, ICU-free days, and mortality in elderly ICU patients. *CritCare* 2013;17 (5):R206.
5. Jaitovich A, Khan M, Itty R, Chieng H, Dumas C, Nadendla P, et al. ICU admission muscle and fat mass, survival and disability at discharge: a prospective cohort study. *Chest* 2019;155 (2):322e30
2. The lead author funded this study.

Topic: Metabolism, endocrinology, liver failure and nutrition

001136

Early mobilization of the most critically ill and mechanically ventilated patients in the intensive care unit—is it possible in clinical practice?

K. O. Poulsen¹, J. Bruun Frandsen², E. Laerkner², T. Strøm¹

¹Department of anesthesiology and intensive care, Odense University Hospital, Odense, Denmark; ²Department of anaesthesiology & intensive care, Odense University Hospital, Odense, Denmark

Correspondence: K.O. Poulsen

Intensive Care Medicine Experimental 2023, **11** (Suppl 1):001136

Introduction: During the first week of critical illness in the Intensive Care Unit (ICU), massive loss of muscle strength occur. Multiple organ failures and deep sedation relates to a lower degree of mobilization. Immobilization is a risk factor for developing Intensive Care Unit Acquired Weakness (ICU-AW) (1–6).

Early mobilization (EM) and rehabilitation may improve patient mobility during ICU and hospital admission, reduce the incidence of delirium and increase the number of days alive after hospital stay (7).

Several publications report different types of barriers to early mobilization. One type of barriers are physiological. These barriers are hemodynamic and respiratory instability and the use of continuous renal replacement therapy (CRRT).

Examples of recommendations from safety protocols regarding EM, are the level of Fraction of Inspired Oxygen (FiO₂) below 0,6, level of Positive End Expiratory Pressure (PEEP) below 10 cm H₂O during Mechanical Ventilation (MV), no vasoactive drugs or no increase in vasopressor in the past 2 h and the presence of CRRT (8–9).

The general ICU at Odense University Hospital is a 27-bed ICU with more than 20 years of practice with a no-sedation strategy. In our daily care, nurses and physiotherapists assess the patient in collaboration during daytime to explore the possibility for EM. In the evening, the nurses assess the patient. Our unit has a 1:1 patient-nurse ratio.

Objectives: To explore the practice regarding EM in our unit.

Inclusion criteria: Adults from both medical and surgical specialties with at least 24 h of admission.

Inclusion dates from 1/1 2021–31/12 2022.

Only patients undergoing MV from these groups is included:

PEEP > 10 cm H₂O or FiO₂ > 0,6

Noradrenaline infusion.

CRRT

EM is defined as mobilization during the first 7 days of admission in the ICU.

Methods: A retrospective, quantitative study.

Data is extracted from Critical Information System, CIS via the HealthQ system. Data is extracted anonymously.

Results: From 1/1 2021 to 31/12 2022, a total of 3257 adult patients was admitted to our general ICU. 1124 of these underwent mechanical ventilation. Preliminary data analysis shows, that:

- 463 patients had a PEEP of 10 cm H₂O or more. 148 (32%) patients were mobilized. A total of 474 mobilizations was registered.
- 825 patients had a FiO₂ of 60% or more. 78 (11%) patients was mobilized. 216 mobilizations was registered.
- 86 patients underwent CRRT. 14 (16%) was mobilized. A total of 21 mobilizations was registered.

Further results will be presented at the conference.

Conclusions: Data from a period of two years show, that EM of the most critically ill and mechanically ventilated patients in our ICU was possible during the first 7 days after admission. EM occurred in 32% of patients with a PEEP of 10 cm H₂O or more, 11% of patients with a FiO₂ of 60 or more and 16% of patients undergoing CRRT.

References

1. 9. Conceição TM, Gonzáles AI, Figueiredo FC, Vieira DS, Bündchen DC, Safety criteria to start early mobilization in intensive care units. Systematic review. *Rev Bras Ter Intensiva*. 2017;29 (4):509–519
2. 8. Raurell-Torredà M, Regaira-Martínez E, Planas-Pascual B, Ferrer-Roca R, Martí JD, Blazquez-Martínez E, et al. Algoritmo de movilización temprana para el paciente crítico. Recomendaciones de expertos. *Enferm Intensiva*. 2021;32:153–163.
3. 7. Tipping CJ, Harrold M, Holland A, Romero L, Nisbet T, Hodgson CL. The effects of active mobilisation and rehabilitation in ICU on mortality and function: a systematic review. *Intensive Care Med*. 2017;43 (2):171–83.
4. 6. Nydahl P, Ruhl AP, Bartoszek G, Dubb R, Filipovic S, Flohr HJ, et al. Early mobilization of mechanically ventilated patients: a 1-day point-prevalence study in Germany. *Critical care medicine*. 2014;42 (5):1178–86.
5. 5. Walsh CJ, Batt J, Herridge MS, Dos Santos CC. Muscle wasting and early mobilization in acute respiratory distress syndrome. *Clin Chest Med*. 2014;35 (4):811–26.
6. 4. Jolley SE, Bunnell AE, Hough CL. ICU-Acquired Weakness. *Chest*. 2016;150 (5):1129–40.
7. 3. Hermans G, Van den Berghe G. Clinical review: intensive care unit acquired weakness. *Crit Care*. 2015;19:274.
8. 2. Cameron S, Ball I, Cepinskas G, Choong K, Doherty TJ, Ellis CG, et al. Early mobilization in the critical care unit: A review of adult and pediatric literature. *J Crit Care*. 2015;30 (4):664–72.
9. 1. Puthuchery ZA, Rawal J, McPhail M, Connolly B, Ratnayake G, Chan P, et al. Acute skeletal muscle wasting in critical illness. *Jama*. 2013;310 (15):1591–600.

Topic: Nursing care and physiotherapy

001137

Unfavorable prognostic factors in patients with subarachnoid hemorrhage admitted to intensive care unit

A. Díaz-Tejedor Rodríguez¹, P. García Olivares¹, J. Cedeño Mora¹, G. Castañeda¹, J. Cui¹, N. Cango¹

¹Intensive Care Unit, H.G.U Gregorio Marañón, Madrid, Spain

Correspondence: A. Díaz-Tejedor Rodríguez

Intensive Care Medicine Experimental 2023, **11** (Suppl 1):001137

Introduction: Subarachnoid hemorrhage (SAH) is frequent among neurocritical patients and is related to disability and mortality. Through several specific scores and scales at the admission in Intensive Care Unit (ICU), it has been estimated morbidity and mortality in this group of patients.

Objectives: To analyze prognostic factors related to severe disability or mortality in patients with subarachnoid hemorrhage admitted to ICU.

Methods: Retrospective, observational study performed on patients with SAH admitted to ICU of HGU Gregorio Marañón between 2021 and 2022 years. Epidemiological data, cardiovascular risk factors, Charlson comorbidity index, organic support, intraventricular hemorrhage (IVH), type of aneurysm treatment, circulation affected by the aneurysm, presence of vasoospasm and patient clinical characteristics were collected during ICU stay. The prognostic scores and scales collected were: SOFA, APACHE II scores, modified Fisher, Hunt & Hess (H&H) and World Federation

of Neurosurgical Societies scale (WFNS). Severe disability or mortality was defined by the modified Rankin scale (mRS) (unfavorable mRS: 4–5–6).

Descriptive data were expressed as means with standard deviation for normally distributed continuous variables, medians with interquartile range (IQR), for non-normally distributed variables, and percentages for categorical data. Chi-square (RR) for the qualitative variables, and t student for the quantitative variables performed for the univariate analysis. The prognostic factors of severe disability or mortality in SAH were obtained by multiple logistic regression analysis.

Results: Fifty two patients were included. 78.8% were female, mean age was 57 ± 12 years and Charlson comorbidity index 0 pts (0–1). 38.5% smoking, 34.6% Hypertension, 21.2% dyslipidemia, 11.5% Mellitus Diabetes. Intracranial aneurysm location: Anterior communicating artery 30.8%, Middle cerebral artery 26.9% (80.8% anterior circulation) and 19.2% vertebrobasilar. Intracranial aneurysms were treated in 84.6% (endovascular 55.8% and surgical treatment 28.8%). 71.2% of patients had IVH and the 50% needed external ventricular drainage. Vasoospasm during ICU stay was 48.1%. Severity scores: APACHE II (11 ± 7), SOFA (5 ± 5), GCS (10 ± 5). The 59.6% of patients needed mechanical ventilation, 32.7% needed tracheostomy for weaning. SAH specific scales: Modified Fisher (3 ± 1), WFNS (3 ± 2) and H&H (3 ± 2). The mRS unfavorable was observed in 31% and the In-hospital mortality was 23%

In the univariate analysis, the variables related to unfavorable mRS were: age (66 ± 15 vs 54 ± 10 ; $p=0.003$), WFNS (OR 2.49; 95% CI 1.58–3.93), H&H (OR 2.71; 95% CI 1.66–4.44), intraventricular hemorrhage (RR 1.48; 95% CI 1.18–1.85), mechanical ventilation (RR 11; 95% CI 1.29–93.39), APACHE II (OR 1.19; 95% CI 1.08–1.31) and Glasgow scale at the admission in ICU (OR 0.75; 95% CI 0.65–0.87).

In the multivariate analysis, on a maximum model including the previously described, the age (OR 1.19; 95% CI 1.09–1.31) and H&H scale (OR 2.71; 95% CI 1.66–4.44) were the only variables independently associated with unfavorable mRS in patients with SAH.

Conclusions: In our experience, the only factors independently associated with severe disability and mortality in patients with SAH admitted to ICU were the age and the Hunt & Hess scale.

Topic: Neurointensive care

001139

Following up chest X-rays in critical care: are we meeting national standards?

E. Smith¹, K. Puxty², A. Puxty³

¹Intensive Care, Glasgow Royal Infirmary, Glasgow, United Kingdom;

²Intensive Care Unit, Glasgow Royal Infirmary, Glasgow, United Kingdom;

³Intensive Care Unit, NHS GGC, Glasgow, United Kingdom

Correspondence: E. Smith

Intensive Care Medicine Experimental 2023, **11** (Suppl 1):001139

Introduction: Chest X-rays (CXR) are a common imaging investigation in Critical Care. Guidance from the British Thoracic Society (BTS) (1) suggests that those with an abnormal CXR should have follow up imaging in 6 weeks if they have a higher risk of malignancy (age > 50 or smoker), or persisting symptoms/signs. We reviewed our compliance with this recommendation.

Objectives: To assess whether patients who met criteria for follow up CXRs after discharge from critical care were being followed up with surveillance imaging as per the BTS guidelines.

Methods: Ethical approval was considered but deemed not to be required as this project was an audit against of practice versus a gold standard. A search was made of the Scottish Intensive Care Society Audit Group (SICSAG) Database "Wardwatcher" for all admissions to our unit over a 5-year period from January 2018 until February 2023. Participants were included on the basis of either a SICSAG or APACHE II diagnosis of pneumonia of any cause. Patient notes were then reviewed to assess whether a follow up CXR was necessary and, if so, whether one was carried out. We included those who underwent cross sectional imaging as having had appropriate follow up on the basis that this is a more sensitive test than CXR.

Results: 199 patients were found to meet criteria for inclusion. Of these, 21 did not require a follow up CXR and 1 left the area before follow up. A further 43 patients died within the 6 week follow up period. Of the remaining, 134 patients met criteria for requiring a follow up CXR after 6 weeks. 63 patients (47%) within this group did not have follow up imaging.

Conclusions: We are currently not meeting the standard set out by the BTS and we aim to review our processes and assess how we can improve this. However, discharge from Critical Care, and subsequently hospital, is a complex process involving multiple specialties and disciplines from both primary and secondary care. Governance of follow up is a challenging issue and one that will require careful consideration as we consider how best to alter our processes to meet this standard.

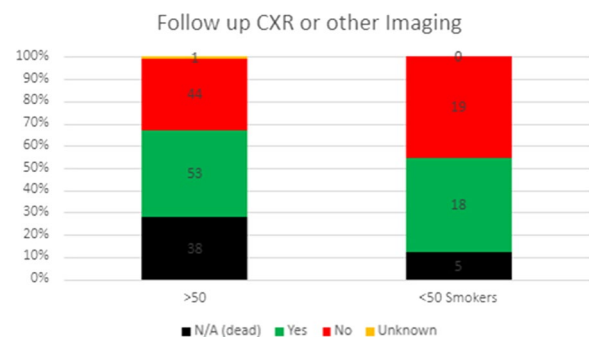

Chart 1 (abstract 001139) Follow up on basis of high-risk criteria—over 50s and under 50 but smoker

References

1. British Thoracic Society (2015) Annotated BTS CAP Guideline Summary of Recommendations. British Thoracic Society. <https://www.brit-thoracic.org.uk/quality-improvement/guidelines/pneumonia-adults/>

Topic: Acute respiratory failure and mechanical ventilation

001140

Outcomes following transfer to specialist neurosurgical centre compared to regional trauma unit management for isolated and polytrauma related traumatic brain injury- a 10 year retrospective observational analysis

M. Salih¹, A. Bell¹, J. Doran¹, D. Joyce¹, A. Kinsella², J. Laffey³, B. McNicholas⁴, C. Hanley¹

¹Anaesthesia and Intensive Care Unit, Galway University Hospital, Galway, Ireland; ²Plastic Surgery, Galway University Hospitals, Galway,

Ireland; ³Anaesthesia and Intensive care medicine, School of medicine, and Regenerative medicine institute, National University of Ireland Galway, Galway, Ireland; ⁴Intensive Care Unit, Galway University Hospital, Galway, Ireland

Correspondence: M. Salih

Intensive Care Medicine Experimental 2023, **11 (Suppl 1)**:001140

Introduction: Traumatic brain injury (TBI) is associated with death and life-changing long-term disability. TBI may occur alongside polytrauma, which can further complicate its care. Patients with TBI are often transferred to specialized neuro-surgical centres as part of their care but this does not always happen due to resource limitation and type/severity of injury.

Objectives: The objective of the study was to compare demographics, injury characteristics and outcomes of TBI patients who were transferred to a neurosurgical centre with TBI patients who remained in a regional trauma unit (RTU) without neurosurgical support, as protocol development for the management of TBI in patients in regional trauma units.

Methods: This was a retrospective observational study of patients presenting between Jan 2010 and Jan 2020 to a regional trauma unit critical care with TBI. Exclusion criteria were hanging injuries and unknown outcomes of interest. Data collected included demographics, length of stay, transfer, ASA physical classification, mechanism of injury, trauma type (isolated TBI (iTBI) or polytrauma and traumatic brain injury (pTBI)), injury severity score (ISS) and GCS. The Adapted Clavien Dindo in Trauma (ACDiT) score >2 and mortality were recorded in 30 days, 90 days and 1 year. Patients were stratified based on transfer and trauma status.

Results: A total of 202 patients were included in the study, of which 38 (18.8%) were transferred to a neurosurgical centre and 164 (81.2%) were managed in the regional trauma unit (Table 1). The overall mortality rate at 1 year was significantly higher in patients with iTBI compared to pTBI (41% vs. 23%, $p=0.009$). This was also significantly higher for patients who were not transferred compared to those who did (35% vs. 13%, $P=0.016$). However, when transferring status was subgrouped by polytrauma there was no statistical significance for iTBI or pTBI ($p=0.085$ and $p=0.09$ respectively). There was no difference between patients with an ACDiT score >2 in those who were transferred (44.7% vs. 39.6%, $p=0.694$) or who had iTBI vs. pTBI (47% vs. 35.9%, $p=0.15$). Predictors of significance of ACDiT >2 were age >65, ASA grade 4 and severe TBI (Severe TBI OR 19, p value <0.005).

Table 1 (abstract 001140) Demographics, injury characteristics and outcomes based on transfer (T), pTBI or iTBI

	iTBI-RTU (70)	iTBI-T (15)	pTBI-RTU (94)	pTBI-T (23)	P value
Age	57.4 (19.7)	51.8 (21.4)	49.3 (20.9)	43.0 (20.2)	0.014
Gender (% female)	18 (25.7%)	3 (20.0%)	21 (22.3%)	5 (21.7%)	0.958
ASA					0.004
1	15 (21.4%)	5 (33.3%)	37 (39.4%)	13 (56.5%)	
2	16 (22.9%)	3 (20.0%)	34 (36.2%)	5 (21.7%)	
3	31 (44.3%)	5 (33.3%)	20 (21.3%)	4 (17.4%)	
4	8 (11.4%)	2 (13.3%)	3 (3.19%)	1 (4.35)	
Mechanism					<0.001
Assault	6 (8.57%)	4 (26.7%)	5 (5.32%)	0 (0.00%)	
Fall < 2m	50 (71.4%)	7 (46.7%)	15 (16.0%)	5 (21.7%)	
Fall > 2m	11 (15.7%)	2 (13.3%)	19 (20.2%)	7 (30.4%)	
RTA	3 (4.29%)	2 (13.3%)	55 (58.5%)	11 (47.8%)	
ISS					0.064
ISS < 9	1 (1.43%)	0 (0.00%)	0 (0.00%)	0 (0.00%)	
ISS < 16	61 (87.1%)	13 (86.7%)	91 (96.8%)	23 (100%)	
ISS > 16	8 (11.4%)	2 (13.3%)	3 (3.19%)	0 (0.00%)	
GCS					0.342
0-8	30 (42.9%)	6 (40.0%)	38 (40.4%)	5 (21.7%)	
9-12	12 (17.1%)	2 (13.3%)	9 (9.57%)	5 (21.7%)	
13-15	28 (40.0%)	7 (46.7%)	47 (50.0%)	13 (56.5%)	
Length of stay	2.46[1.66;4.03]	1.71[0.39;10.4]	4.74[2.00;11.7]	2.44[0.54;8.96]	0.008
ACDiT > 2	33 (47.1%)	7 (46.7%)	32 (34.0%)	10 (43.5%)	0.358

	iTBI-RTU (70)	iTBI-T (15)	pTBI-RTU (94)	pTBI-T (23)	P value
Mortality					
30days	30 (42.9%)	3 (20.0%)	23 (24.5%)	1 (4.35%)	0.001
90days	32 (45.7%)	3 (20.0%)	24 (25.5%)	2 (8.70%)	0.002
1 year	32 (45.7%)	3 (20.0%)	25 (26.6%)	2 (8.70%)	0.002

Conclusions: Patients with TBI who are not transferred to a neurosurgical unit have increased mortality rates. Age >65 and severe TBI are strong predictors of mortality. These findings highlight the need for early recognition and management of TBI patients to improve their chances of survival and develop specific guidelines for the peri-transfer period.

References

- National Office of Clinical Audit, (2020) Major Trauma Audit National Report 2018. Dublin: National Office of Clinical Audit.
- Moran, Christopher G., Fiona Lecky, Omar Bouamra, Tom Lawrence, Antoinette Edwards, Maralyn Woodford, Keith Willett, and Timothy J. Coats. "Changing the System—Major Trauma Patients and Their Outcomes in the NHS (England) 2008–17." *EclinicalMedicine* 2 (August 1, 2018): 13–21.
- Nathanson, M. H., J. Andrzejowski, J. Dinsmore, C.A. Eynon, K. Ferguson, T. Hooper, A. Kashyap, et al. "Guidelines for Safe Transfer of the Brain-injured Patient: Trauma and Stroke, 2019: Guidelines from the Association of Anaesthetists and the Neuro Anaesthesia and Critical Care Society." *Anaesthesia* 75, no. 2 (February 2020): 234–46
- Giugni, A., Gamberini, L., Carrara, G. et al. Hospitals with and without neurosurgery: a comparative study evaluating the outcome of patients with traumatic brain injury. *Scand J Trauma Resusc Emerg Med* 29, 158 (2021)
- Byrne, Richard W.; Bagan, Bradley T.; Slaviv, Konstantin V.; Curry, Daniel; Koski, Tyler R.; Origitano, Thomas C. (2008). Neurosurgical Emergency Transfers to Academic Centers in Cook county. *Neurosurgery*, 62 (3), 709–716
- Holland, Christopher M.; McClure, Evan W.; Howard, Brian M.; Samuels, Owen B.; Barrow, Daniel L. (2015). Interhospital Transfer of Neurosurgical Patients to a High-Volume Tertiary Care Center. *Neurosurgery*, 77 (2), 200–207
- Naumann, David N; Vincent, Laura E; Pearson, Nicola; Beaven, Alastair; Smith, Iain M; Smith, Kieran; Toman, Emma; Dorrance, Helen R; Porter, Keith; Wade, Charles E; Cotton, Bryan A; Holcomb, John B; Midwinter, Mark J (2017). An adapted Clavien-Dindo scoring system in trauma as a clinically meaningful non-mortality endpoint. *Journal of Trauma and Acute Care Surgery*

Topic: Trauma

001142

World delirium prevalence study

H. Lindroth¹, K. Liu², G. Bellelli³, J. Benbenishty⁴, M. van den Boogaard⁵, G. Caplan⁶, CR. Chung⁷, M. Elhadi⁸, M. Gurjar⁹, G. Heras La Calle¹⁰, M. Hoffmann¹¹, MM. Jeitiner¹², K. Krewulak¹³, T. Mailhot¹⁴, A. Morandi¹⁵, RK. Nawa¹⁶, E. Oh¹⁷, M. Oxenboell-Collet¹⁸, C. Paulino¹⁹, R. Von Haken²⁰, P. Nydahl²¹, Wdad Study Group²¹

¹Division of Nursing Research, Department of Nursing, Mayo Clinic, Center for Aging Research, Regenstrief Institute, School of Medicine, Indiana University, Rochester, United States of America; ²Research, Non-Profit Organization ICU Collaboration Network (ICON), Tokyo, Japan; ³Acute geriatric unit, asst-monza, University of Milano-Bicocca, Monza, Italy; ⁴Critical care, Hadassah Ein Kerem, Jerusalem, Israel; ⁵Intensive care, Radboud University Medical Center, Nijmegen, Netherlands; ⁶Geriatric, Healthcare Australia | Melbourne, Melbourne, Australia; ⁷Critical Care, Korea University, Seoul, Republic of Korea; ⁸Hospital, University of Tripoli, Tripoli, Libya; ⁹Intensive care medicine, Sanjay Gandhi Post Graduate Institute of Medical Sciences (SGPGIMS), Lucknow, India; ¹⁰Intensive care unit, Regional Hospital Santa Ana de Motril, Motril, Spain; ¹¹Division

of endocrinology and diabetology/research unit for safety in health/qm-rm, Medical University of Graz, University Hospital Graz, Graz, Austria; ¹²Department of intensive care medicine, University Hospital Bern, Bern, Switzerland; ¹³Critical Care, University of Calgary, Calgary, Canada; ¹⁴Critical Care, UNIQLO Centre Eaton de Montréal, Montréal, Canada; ¹⁵Rehabilitation, Geriatric Research Group, Morandino, Italy; ¹⁶Critical Care, University of São Paulo, São Paulo, Brazil; ¹⁷Critical Care, Johns Hopkins University, Baltimore, United States of America; ¹⁸Critical Care, Copenhagen University, København, Denmark; ¹⁹Ucip; smi, Hospital de São Francisco Xavier; Hospital da Luz, Lisboa, Portugal; ²⁰Department of anaesthesiology, Mannheim University Hospital, Mannheim, Germany; ²¹Nursing Research, Universitätsklinikum Schleswig–Holstein, Campus Kiel, Kiel, Germany

Correspondence: P. Nydahl

Intensive Care Medicine Experimental 2023, **11 (Suppl 1)**:001142

Introduction: Delirium is an acute physiologic disruption of brain networks experienced by 10–50% of hospitalized and 30–60% of critical care patients, leading to increased mortality and morbidity. Evidence exists to detect, prevent, and treat delirium. The worldwide extent of delirium management structures and processes in clinical practice remains unknown.

Objectives: To assess the delirium practice and delirium prevalence in wards and units caring for pediatric and adult hospitalized patients.

Methods: This was a non-funded, prospective, cross-sectional, survey study across 44 countries completed on World Delirium Awareness Day, March 15th, 2023. A 39-question survey was available on 3/15/23 for participating clinicians to complete via SurveyMonkey. The primary outcome is the prevalence of delirium in present patients in the morning (8 a.m.) and in the evening (8 p.m.), each \pm 4 h. Secondary outcomes included the use of pharmacological and non-pharmacological interventions, use of protocols and education, and priorities for future care and research. Descriptive statistics was performed for demographic and clinical characteristics. The primary outcome was compared across age groups and settings.

Results: In total, data from 44 countries (all continents, $n=1,714$ wards/units, $n=37,395$ inpatients) were collected. The delirium assessment rate in the morning was 69.6% (26,033/37,395) and in the evening was 68.8% (23,305/33,891). Validated assessment tools were used in 66.2% ($n=1,134$ wards/units) of wards/units, compared to 22.8% ($n=391$) non-valid tools such as personal judgement, and other tools (11%, $n=189$); the most frequently reported validated tool was the CAM-ICU (20.2%, $n=347/1,698$). In total 15,774 patients were assessed with a validated assessment tool, of those were 18.2% (2873/12901) delirium positive in the morning and 17.9% (2503/11460) were delirium positive in the evening. In wards/units with valid delirium assessments, delirium prevalence was significant different between continents, age groups, disciplines, and ward/unit types (all $p < 0.001$). The most frequently reported prevention measures were pain management (90.4%, $n=1,462$), mobilization (86%, $n=1,390$), and adequate fluids (84.1%, $n=1,360$). The most frequently reported pharmacologic interventions were Haloperidol (51.9%, $n=787$), Quetiapine (42.8%, $n=649$), and reducing delirogenic drugs (33.7%, $n=511$). Shortage of staff (58.4%, $n=930$), lack of time to educate staff (52.4%, $n=834$), and missing knowledge about delirium (40.4%, $n=644$) were the most reported barriers.

Conclusions: Delirium is a worldwide problem. In this cross-sectional prevalence study, every fifth to sixth inpatient was assessed as being delirious. Findings from this study can inform future quality improvement projects. The developed research infrastructure can be used to evaluate efforts to improve delirium detection and prevention on World Delirium Awareness Day 2024.

Topic: Sedation, analgesia and delirium

001143

Major traumatic spinal injury: does surgical timing matters?

S. Teixeira¹, B. Costa², I. Mendonça¹, H. Macedo¹, N. Gatta¹, J. M. Pereira¹, J. A. Paiva¹

¹Emergency and intensive care department, Centro Hospitalar de São João, Porto, Portugal; ²Intensive medicine, Centro Hospitalar De Trás-Os-Montes E Alto Douro, E.P.E., Vila Real, Portugal

Correspondence: S. Teixeira

Intensive Care Medicine Experimental 2023, **11 (Suppl 1)**:001143

Introduction: Traumatic spinal injury (TSI) has important physical, social and emotional consequences for the patients. Surgical stabilization and decompression plays an important part in its management but the best timing is still not fully understood.

Methods: To evaluate the impact of two different surgical timing strategies [early (< 48 h) vs. late (> 48 h)] in major TSI, we performed a retrospective single centre study of all patients consecutively admitted to an ICU of a University Hospital from 2019 to 2021. Besides demographic data, TSI characteristics, organ support, ICU and hospital length of stay (LOS) and short- (ICU and hospital) and long-term (1 year) mortality were collected.

Results: Of the 99 patients with TSI (15.1% of all trauma admissions), 63 (63.6%) had major TSI. Most of them were male (76.2%) with a median age of 56 years and a median SAPSII score of 26. At least one comorbidity was present in 61.9% of the patients. According to the AO Spine Classification, 30 were type A (47.6%), 7 were type B (11.1%) and C were 24 (38.1%). Regarding the level of fractures, 19.0% had subaxial TSI, 44.4% had cervical TSI and 63.5% dorsolumbar injury. Isolated TSI was only documented in 8 patients (12.6%). Invasive and non-invasive mechanical ventilation were used in 27 (42.8%) and 14 (22.2%) patients, respectively. 44.4% needed vasopressor support. Tracheostomy was done in 5 patients (7.9%). ICU, hospital and 1 year mortality were 9.5%, 14.3% and 19% respectively.

No statistically significant differences were observed between patients submitted ($n=38$; 60.3%) or not ($n=25$; 39.7%) to surgical intervention, regarding baseline characteristics, organ support and both short- and long-term mortality.

Early surgical treatment (EST) was performed in 18 patients (47.4%). Compared to late intervention, no differences were observed regarding demographic data, general and specific severity/trauma scores, AO Spine classification, mono vs. polytrauma, need and duration of mechanical ventilation or tracheostomy and rate of nosocomial infections. Duration of vasopressor support was lower in EST group (3 vs. 8.5 days; $p=0.007$). Although not statistically significant, time to rehabilitation was also shorter in EST (5 vs. 13.5 days; $p=0.1$). ICU LOS was shorter in EST group (4.5 vs. 11 days; $p=0.049$) but no differences were found in terms of hospital LOS. ICU and hospital mortality were similar, but one-year mortality was significantly lower in EST group (0% vs 20%; $p=0.048$).

Conclusions: In major TSI, surgical treatment was not associated with a worse outcome. If performed in the 1st 48 h, it allowed earlier rehabilitation and was associated with a lower ICU LOS and lower 1 year mortality.

References

1. Wang TY, Park C, Zhang H, Rahimpour S, Murphy KR, Goodwin CR, et al. Management of Acute Traumatic Spinal Cord Injury: A Review of the Literature. *Front Surg.* 2021 Dec 13;8:698736.
2. Fehlings MG, Tetreault LA, Wilson JR, Kwon BK, Burns AS, Martin AR, et al. A Clinical Practice Guideline for the Management of Acute Spinal Cord Injury: Introduction, Rationale, and Scope. *Global Spine Journal.* 2017 Sep;7(3_suppl):845-945.

Topic: Trauma

001144

Validity of prognostic scoring systems and scales used in critically ill patients with subarachnoid hemorrhage

A. Díaz-Tejero Rodríguez¹, P. García Olivares¹, J. Cedeño Mora¹, G. Castañeda¹, J. Cui¹, N. Cango¹

¹Intensive Care Unit, H.G.U Gregorio Marañón, Madrid, Spain

Correspondence: A. Díaz-Tejero Rodríguez

Intensive Care Medicine Experimental 2023, 11 (Suppl 1):001144

Introduction: Risk prediction of morbimortality through the use of scoring systems and specific scales in the intensive care unit (ICU) is important in subarachnoid hemorrhage (SAH).

Objectives: The purpose of this study was to assess the predictive prognosis value of the different severity scoring systems used in the ICU and the specific scales for patients with SAH.

Methods: Retrospective study performed of patients with subarachnoid hemorrhage admitted to ICU of HGU Gregorio Marañón in 2021 and 2022 years. Epidemiological data and patient clinical characteristics were collected. Scoring systems and specific scales for SAH were SOFA, APACHE II, modified Fisher, Hunt & Hess (H&H) and World Federation of Neurosurgical Societies scale (WFNS). The prognostic of the patients was assessed by the modified Rankin scale (mRS), considering unfavorable mRS 4–5-6 (moderate-severe).

Descriptive statistics were expressed as mean ± SD or median (interquartile range) for continuous variables and percentage for categorical data. The ability of the scoring systems to discriminate prognosis was assessed using the area under the receiver operating characteristic curve (AUROC). Estimation of their calibration was established through Hosmer–Lemeshow goodness of fit test.

Results: Fifty two patients were included. 78.8% were female, mean age was 57 ± 12 years and Charlson comorbidity index 0 pts (0–1). Severity scores: APACHE II (11 ± 7), SOFA (5 ± 5). Specific scales: Modified Fisher (3 ± 1), WFNS (3 ± 2) and H&H (3 ± 2). The unfavorable mRS was 31%. Length of stay in hospital was 41 ± 29 days and mortality 23%.

It was confirmed that severity scores and specific scales were predictor of severe disability or mortality (unfavorable mRS), except Modified Fisher scale: APACHE II (OR 1.19; 95% CI 1.09–1.31), SOFA (OR 1.22; 95% CI 1.06–1.40), WFNS (OR 2.49; 95% CI 1.58–3.93) and H&H (OR 2.71; 95% CI 1.66–4.44).

Using the AUROC curves (Table 1), H&H score on admission was found to be the most reliable scoring system to discriminate unfavorable mRS (AUROC 0.86, CI 0.76–0.96) with a good calibration ability (Chi-squared 1.42, p=0.70), followed by the APACHE II score (AUROC 0.83, CI 0.72–0.94) with good calibration ability too (Chi-squared 3.99, p=0.86). However, there were no significant differences in the ability to discriminate between the scales analyzed (Figure 1) (Table 2).

Conclusions: Our data show that the specific scales for subarachnoid hemorrhage were not superior to the standard scoring systems used in critically ill patients. Of all the severity scores analysed, the greatest discriminatory power was observed in the Hunt & Hess scale.

Table 1 (abstract 001144) .

	DISCRIMINATION		CALIBRATION	
	AUROC	CI 95%	Chi-squared	Sig
APACHE II	0.83	0.72-0.94	3.99	0.86
SOFA	0.80	0.67-0.92	5.44	0.49
WFNS	0.83	0.71-0.95	0.76	0.68
H&H	0.86	0.76-0.96	1.42	0.7

Table 2 (abstract 001144) .

	Area difference of paired samples under ROC curves			
	Asintótica Sig. (bilateral)*	AUC difference	95% CI	
			Lower limit	Upper limit
APACHE II - SOFA	,602	,033	-,091	,157
APACHE II - WFNS	,973	,002	-,086	,089
APACHE II - H&H	,472	-,029	-,109	,050
SOFA - WFNS	,408	-,031	-,106	,043
SOFA - H&H	,122	-,062	-,141	,017
WFNS - H&H	,153	-,031	-,073	,011

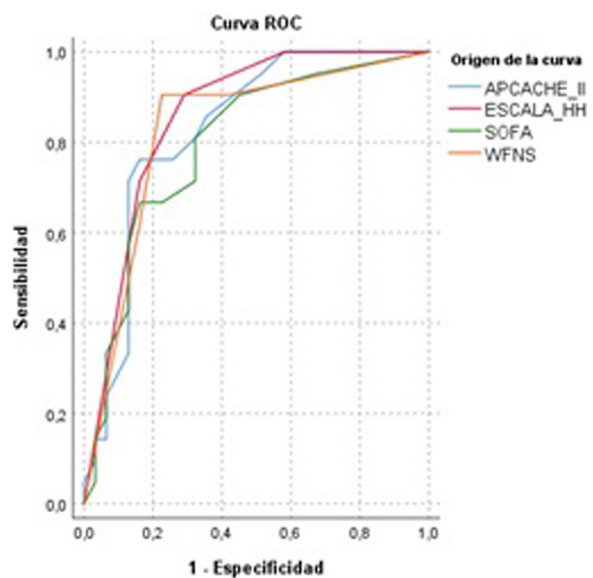

Figure 1 (abstract 001144) .

Topic: Neurointensive care

001145

Social and health support for critically ill COVID-19 survivors

M. Márquez Doblas¹, G. Morales Varas¹, P. Rodríguez Villamizar¹, G. Alonso Gómez¹, P. Carneiro Pereda¹, A. Cuadra-Calahorra¹, J. Guerra Cuervo¹, M. Vecino Montoya¹, E. Alonso Ciria¹, V. Pais Sánchez-Malingre¹

¹Critical Care Unit, Hospital General Universitario de Toledo, Toledo, Spain

Correspondence: M. Márquez Doblas

Intensive Care Medicine Experimental 2023, **11 (Suppl 1)**:001145

Introduction: Critical illness and ICU treatment, can cause physical, mental and cognitive symptoms (which we know as post-intensive care syndrome (PICS)). These symptoms are associated with increased mortality, higher health care costs, and lower quality of life. The COVID-19 pandemic has led to an increase in the number of critically ill patients who required ICU treatment, with many survivors at risk of experiencing PICS.

Objectives: To evaluate the socio-health care and support provided by the National Health System after one year of survival of critically ill patients by COVID-19.

Methods: This cross-sectional study among critical ill COVID-19 survivors aged 18 years and above one year after ICU discharge through phone-based questionnaire and the medical record was reviewed to assess the use of health resources. Categorical variables are expressed as counts and percentages and were compared using the χ^2 test and Fisher test; continuous variables are expressed as medians and interquartile range (IQR) and were compared using Mann-Whitney U test. A two-sided level of significance of 5% was used. Data analysis was performed using STATA version 13[®] (Stata-Corp LCC).

Results: A total of 388 survivors at ICU discharge were surveyed, 8 rejected the survey (2,88%) and 278 responded to the survey. The demographic characteristics and evolution in the ICU are summarized in Table 1. Return to normal activity was lower in women than in men at 6 months (42% vs 54%; $p = 0.074$) and at one year (58% vs 70%; $p = 0.045$). Self-assessment of health status with the EuroQOL Thermometer (100 being the best possible health status, and 0 the worst health status) was lower in women than in men (70 (50–85) vs 80 (55–90); $p = 0.016$). There were no differences in emergency visits (37% of patients), hospitalizations (19%), surgical interventions (16%), or rehabilitation (48%) [Table 2]. In the comparison of age groups, no statistically significant differences were observed, except that younger patients felt less accompanied by the Health System (46% [under 40 years] vs 66% [41 to 65 years] vs 74% [over 65 years]; $p = 0.030$).

Conclusions: The majority of COVID 19 critical illness survivors felt supported by the health care system at the one-year follow-up. The use of health resources was important, in contrast to social support. Women had a higher consumption of psychotropic drugs and a lower return to normal activity.

Table 1 (abstract 001145) Demographic characteristics and evolution in the ICU

DEMOGRAPHY:	Total n=270
Female, %	101 (38.38)
Male, %	169 (62.59)
Age, median (RIQ), years	59 (48,5-66)
BMI, median (RIQ), pts	29,75 (26,77-34,24)
Charlson, median (RIQ), pts	2 (1-3)
CFS, median (RIQ), pts	3 (2-3)
Psychotropic drugs prior to admission, %	56 (20.90)
SEVERITY AND EVOLUTION:	
SOFA, median (RIQ), pts	3 (3-4)
APACHE II, median (RIQ), pts	10 (7-14)
IMV,%	213 (78.89)
Mechanical ventilation days, median (IQR)	13 (7-25)
Prone, %	142 (52.59)
Tracheostomy, %	103 (38.15)
LOS UCI, median (IQR) days	13 (8-27)
LOS Hospital, median (IQR) days	29 (19-46)
COMPLICATIONS:	
PTE,%	49(18.15)
Hemorrhage, %	23 (8.61)
Sepsis, %	108 (40.15)
AKI,%	41 (15.30)
Delirium,%	125 (46.3)
Need for surgery,%	27 (10)

Table 2 (abstract 001145) Questions stratified by gender

Questions	Male	Female	Total	p
Have you returned to your usual activity? after 6 months. Yes (%)	92 (53,8)	43 (42,57)	135 (49,63)	0.074
Have you returned to your usual activity? per year. Yes (%)	121 (70,35)	59 (58,42)	180 (65,93)	0.045
Have you been to the emergency room after discharge? Yes (%)	59 (34,91)	41 (41)	100 (37,17)	0.318
Have you been hospitalized after discharge? Yes (%)	30 (17,86)	21 (20,79)	51 (18,96)	0.552
¿Have you undergone surgery after discharge? Yes (%)	26 (15,38)	17 (16,83)	43 (15,93)	0.753
Have you received rehabilitation after discharge? Yes (%)	81 (47,65)	48 (47,52)	129 (47,6)	0.984
Have you felt accompanied by the Health System? Yes (%)	113 (66,86)	66 (65,35)	179 (66,30)	0.799
Have you received social assistance after discharge? Yes (%)	16 (9,52)	7 (6,93)	23 (8,55)	0.461
Do you use psychotropic drugs that you did not previously use? Yes.	61 (31,28)	62 (56,36)	123 (40,33)	0.000
EuroQOL Thermometer	80 (55-90)	70 (50-85)	70 (50-90)	0.016

References

1. Heesakkers H, van der Hoeven JG, Corsten S, et al. Clinical outcomes among patients with 1-year survival following intensive care unit treatment for COVID-19. *JAMA*. 2022;327:559–565. <https://doi.org/10.1001/jama.2022.0040>.
2. Hopkins RO, Weaver LK, Collingridge D, et al. Two-year cognitive, emotional, and quality-of-life outcomes in acute respiratory distress syndrome. *Am J Respir Crit Care Med*. 2005;171:340–347. <https://doi.org/10.1164/rccm.200406-763OC>.
3. Heesakkers, H., Van Der Hoeven, J. G., Van Den Boogaard, M., & Zegers, M. (2023). Two-year physical, mental and cognitive outcomes among intensive care unit survivors treated for COVID-19. *Intensive Care Medicine*. <https://doi.org/10.1007/s00134-023-07038-3>
4. None.

Topic: Critical care organisation, quality management, information systems, outcomes

001146

Comparative analysis of ECMO cannula infection between in-hospital cannulated patients and out-of-hospital cannulated patins and secondary transferred by an ECMO mobile team

F. Fuentes Gorgas¹, J. Domènech¹, M. Vicente², V. Rodríguez², S. Martín-Sastre¹, A. Mera¹, C. Bonilla¹, L. Chiscano¹, M. Martínez¹, E. Argudo¹, L. Miranda¹, A. Gil¹, N. Martínez¹, L. Consegal¹, E. Gallart¹, P. Giron¹, X. Nuvials¹, R. Ferrer Roca¹, J. Riera del Brio¹

¹Intensive Care Department, Vall d'Hebron Barcelona Hospital Campus, Barcelona, Spain; ²Microbiology and Clinics Laboratory Service, Vall d'Hebron Barcelona Hospital Campus, Barcelona, Spain

Correspondence: F. Fuentes Gorgas

Intensive Care Medicine Experimental 2023, **11 (Suppl 1)**:001146

Introduction: Nosocomial infections are frequent in ECMO patients and are probably associated with increased in-hospital mortality. The most known risk factor is the length of the ECMO run. Although there are modifiable factors, it is challenging to specify which actions to underline to control infections. One of these factors might be the interhospital transfer. Despite infection control best practices, nosocomial infections with antibiotic-resistant organisms are associated with interhospital transfer. It may be due to mobile devices, such as ventilators. ECMO support in adult patients has subsequently increased interhospital transfer under this kind of support. The evidence shows that larger centers have better outcomes for patients on ECMO, so there may be an increase in the transport of patients receiving ECMO. It is

necessary to clarify the risk of nosocomial infection related to interhospital transfer. With the extra personnel and the problem of keeping infection control methods in numerous conditions, we hypothesized that interhospital transfer might be associated with more nosocomial infections. Our ECMO team is the reference center for a large population area. If necessary, we help other hospitals and activate our ECMO mobile team for cannulating patients who need extracorporeal support and whose clinical status is too severe for a conventional interhospital transfer.

Objectives: We aim to compare the frequency of positive microbiological results in the culture of ECMO cannulas from patients cannulated within our facility and those cannulated in other centers by our ECMO team. After initiating ECMO support, the patients cannulated at other centers were transported primarily or secondarily to our hospital.

Methods: We present a retrospective observational analytical study. We included two hundred ninety-two patients on VV, or VA ECMO, admitted to the Vall d'Hebron University Hospital (HUVH) in Barcelona between January 2016 and July 2022. Antibiotic prophylaxis with daptomycin or vancomycin was employed in 95% of patients. During decannulation, we sectioned the distal 5 cm of both cannulas aseptically, sending the samples to the Microbiology laboratory for processing by Maki-type culture. We conducted a descriptive study of the sample by calculating frequencies and percentages for the qualitative variables. We calculated the odds ratio (OR), the relative and absolute increase in risk (ARR and AAR, respectively), and the number needed to harm (NNH) with their corresponding confidence intervals (CI) for hypothesis testing.

Results: One hundred thirty patients (44%) of the 292 admitted were cannulated in other healthcare centers and transported to the HUVH jointly with the multidisciplinary team of the High Complexity Unit of the Emergency Medical System (SEM) of Catalonia. Of these, 36 patients (27% of transported patients) had at least one positive result for one of the cannula cultures; 17 were positive in both the drainage and return cannula. Of the 162 patients cannulated within the HUVH (56%), at least 24 (14% of the patients cannulated within the hospital) tested positive for at least one cannula. Almost 50% of these 24 patients (13) were positive for both cannula cultures (drainage and return). The calculated OR was 1.64, CI (0,9;2,9). The ARR 0,5, CI (-0,06, 1,39). AAR 0,07, CI (-0,01, 0,15). The NNH 14, CI (-6; 92).

Conclusions: The risk of suffering an infection from the ECMO cannulas does not present statistically significant differences in the group of patients cannulated within our center compared to those cannulated outside. An expert team must transport patients on ECMO and follow a structured and protocolized process. New prospective studies are needed to confirm these findings and an evidence-based definition of colonization and infection of ECMO support devices.

References

1. Hsu MS, Chiu KM, Huang YT, Kao KL, Chu SH, Liao CH. Risk factors for nosocomial infection during extracorporeal membrane oxygenation. *J Hosp Infect* 2009;73:210–216.
2. Juthani BK, Macfarlan J, Wu J, Misselbeck TS. Incidence of nosocomial infections in adult patients undergoing extracorporeal membrane oxygenation. *Heart Lung* 2018;47:626–630.
3. Marcus JE, Sams VG, Aden JK, Batchinsky A, Sobieszczyk MJ, Okulicz JF, et al. Rates of nosocomial infection associated with interhospital transfer of patients receiving extracorporeal membrane oxygenation. *Infect Control Hosp Epidemiology*. 2022;43 (7):864–9.
4. Thomas G, Hraiech S, Cassir N, Lehingue S, Rambaud R, Wiramus S, et al. Venovenous extracorporeal membrane oxygenation devices-related colonisations and infections. *Ann Intensive Care*. 2017;7 (1):111.
5. Martínez-Martínez M, Nuvials FX, Riera J. Nosocomial infections during extracorporeal membrane oxygenation. *Curr Opin Crit Care*. 2022; Publish Ahead of Print.
6. Allou N, Pinto HL, Persichini R, Bouchet B, Braunberger E, Lugagne N, et al. Cannula-Related Infection in Patients Supported by Peripheral ECMO. *Asaio J*. 2019;65 (2):180–6.

Topic: Infections and prevention

001148

The burden diseases of COVID-19 critical ill

G. Morales Varas¹, E. Alonso Ciria¹, P. Rodríguez Villamizar¹, G. Alonso Gómez¹, I. Gómez Cano¹, M. Márquez Doblas¹, P. Carneiro Pereda¹, J. Guerra Cuervo¹, C. Corral Lardies¹, M. Vecino Montoya¹, A. Cuadra-Calahorra¹

¹Critical Care, Hospital General Universitario de Toledo, Toledo, Spain

Correspondence: G. Morales Varas

Intensive Care Medicine Experimental 2023, 11 (Suppl 1):001148

Introduction: Coronavirus disease (COVID-19) presents different levels of severity that may require admission to an intensive care unit (ICU) and different organ support. The care of critically ill patients with COVID-19 has been a real challenge for ICU staff. Long-term outcomes help to define the burden of disease in critically ill patients with COVID-19.

Objectives: To analyze the impact on long-term outcomes of critical illness due to COVID-19 through mortality estimation, years of life lost (YLLs), quality-adjusted life years (QALYs).

Methods: Patients were evaluated at 1-year of those who required ICU admission during the first two years of the pandemic. Medical records were reviewed and Quality of life (QoL) was assessed by the EQ-5D-5L tool and the euroQoL visual analog scale through phone-based questionnaires. 1-year mortality, YLLs, QALYs and aspects of QoL and health status perception as defined by the EuroQoL thermometer and Severity index were evaluated. Categorical variables are expressed as counts and percentages and were compared using the χ^2 test and Fisher test; continuous variables are expressed as medians and interquartile range (IQR) and were compared using Mann-Whitney U and Kruskal-Wallis test. A two-sided level of significance of 5% was used. Data analysis was performed using STATA version 13[®] (StataCorp LCC).

Results: A total of 652 ICU admissions were analyzed, of which 60 were not reviewed or interviewed. The median age was 62 (53–69) years and 66.22% (392/592) were male. 1-year mortality was 38.51% (228/593), of which 34.45% (204/592) died in hospital and of the 388 survivors, 24 (6.18%) died during the year of follow-up. Mortality was higher in older patients ($p < 0.001$); in the first 3 waves of the pandemic ($p < 0.001$); in the most fragile patients ($p < 0.001$); with greater severity of Acute respiratory distress syndrome (ARDS) ($p < 0.001$); in who required invasive mechanical ventilation (IMV) ($p < 0.001$) and who had who had more IMV days ($p = 0.012$). Women had higher YLLs (18.8 [13.8–26.8] vs 13.2 [7.2–19.2] years; $p < 0.000$), no difference in QALYs ($p = 0.939$), but with a worse perception of health status (EuroQoL thermometer: 70 [50–85] vs 80 [55–90]; $p = 0.016$) and a higher Severity index (30 [10–50] vs 10 [0–30]; $p < 0.001$). Higher pre-ICU frailty also influenced further YLLs ($p < 0.001$) and fewer QALYs ($p = 0.013$). Patients who required IMV had significantly more YLLs (14.8 [9.8–20.2] vs 8.2 [4.2–13.2]; $p = 0.004$) and fewer QALYs (17.8 [10.2–23.2] vs 28.2 [16.2–42.2]; $p < 0.001$); however time of IMV did not influence YLLs ($p = 0.893$) and QALYs ($p = 0.494$). ICU stay also did not impact YLLs ($p = 0.514$) neither in the QALYs ($p = 0.078$) (Table 1).

Conclusions: At one year follow-up, the burden of COVID-19 critical illness is important, with a high mortality that increases according to the life support received, age and frailty. Most of the mortality is attributed to the hospitalization period. Critical illness due to COVID-19 has had a high impact on years of life lost and quality of life, especially in women, frail and elderly patients, and in those in need of invasive ventilatory support.

	1-year mortality, %	p ^a	YLLs (median (IQR), years)	p ^a	QALYs (median (IQR), years)	p ^a	EuroQoL thermometer, median (IQR)	p ^a	Severity index, median (IQR)	p ^a
All	228/592 (38.51)		14.2 (9-20)		18.2 (11.8-29.2)		70 (50-90)		15 (5-35)	
Age	228/592 (38.51)									
≤ 35 years	6/29 (20.69)		51.2 (47.2-58.8)		54.2 (53.2-56.2)		80 (50-100)		15 (0-25)	
36 - 45 years	8/52 (15.38)		40.2 (38.2-44.2)		39.5 (36.5-41.2)		72.5 (50-90)		10 (5-30)	
46 - 55 years	16/89 (17.98)		31 (27.2-34.8)		26.7 (25.2-30.2)		70 (50-85)		15 (5-40)	
56 - 65 years	60/184 (32.61)		19.2 (17.2-22.5)		18.2 (15.2-19.2)		70 (50-90)		15 (5-40)	
66 - 75 years	103/183 (56.08)		12.2 (9.2-14.2)		9.7 (7.2-12.8)		75 (60-90)		10 (0-35)	
> 75 years	35/51 (68.63)	0.000	3.2 (2.8-4.8)	0.000	1.5 (1.2-1.8)	0.000	50 (20-80)	0.388	35 (20-55)	0.268
Sex	228/592 (38.51)									
Female	68/200 (34)		18.8 (13.8-26.8)		17.8 (13.8-24.8)		70 (50-85)		30 (10-50)	
Male	160/392 (40.82)	0.107	13.2 (7.2-19.2)	0.000	18.2 (10.2-29.2)	0.939	80 (50-90)	0.016	10 (0-30)	0.000
Wave	228/592 (38.51)									
First	58/122 (47.54)		14.5 (11.2-19.2)		18.2 (13.8-25.2)		80 (50-90)		35 (10-50)	
Second	60/154 (38.96)		12.2 (9.7-18.8)		10.7 (7.2-18.2)		70 (50-92.5)		20 (5-45)	
Third	63/168 (37.5)		13.2 (8.8-19.8)		17.2 (11.8-24.2)		80 (50-92)		10 (0-30)	
Fourth	29/83 (34.94)		16.2 (12.2-20.2)		32.2 (18.2-52.2)		70 (55-85)		15 (5-30)	
Fifth	7/52 (13.46)		24.2 (7.8-47.2)		38.3 (17.8-42.2)		85 (60-95)		5 (0-20)	
Sixth	4/13 (30)	0.000	19.2 (15.8-44.2)	0.029	25.2 (18.2-27.3)	0.006	75 (50-100)	0.110	2.5 (0.5)	0.000
Frailty	228/589 (38.37)									
CFS ≤ 3	184/595 (30.92)		15 (10.7-21)		18.8 (12.8-30.2)		70 (50-90)		15 (5-35)	
CFS > 3	42/84 (48.63)	0.000	10 (3.2-16.8)	0.000	9.2 (2.2-12.2)	0.013	70 (50-85)	0.757	20 (0-30)	0.605
Tracheostomy	228/592 (38.51)									
Yes	92/222 (41.44)		13.2 (8.2 - 19.2)		14 (7.2-26.2)		70(50-90)		15 (5-40)	
No	136/370 (36.76)	0.257	14.5 (10-20.8)	0.168	19.7 (14.3-32.7)	0.059	70 (50-90)	0.795	15 (0-35)	0.159
ARDS Severity	228/592 (38.66)									
Mild	19/59 (32.20)		15.8 (8.8-23.8)		14.8 (8.2-26.2)		70 (50-90)		15 (0-40)	
Moderate	84/283 (29.68)		14 (8.5-19.2)		20.7 (13.8-32.7)		70 (50-85)		15 (5-35)	
Severe	122/240 (50.83)	0.000	15.3 (10.2-20.2)	0.522	18.2 (10.7-27.3)	0.453	70 (50-90)	0.905	15 (0-40)	0.993
IMV	228/592 (38.51)									
Yes	215/504 (42.66)		14.8 (9.8-20.2)		17.8 (10.2-23.2)		70 (50-85)		20 (5-40)	
No	13/88 (14.77)	0.000	8.2 (4.2-13.2)	0.004	28.2 (16.2-42.2)	0.001	80 (50-100)	0.031	5 (0-25)	0.000
IMV days	208/497 (41.85)									
≤ 7 days	40/124 (32.26)		13.8 (8.5-23.5)		18.7 (11.2-23.7)		70 (50-80)		20 (5-40)	
> 7 days	169/373 (45.04)	0.012	14.8 (10.2-19.8)	0.893	15.2 (10.2 - 23.2)	0.494	70 (50-90)	0.489	17.5 (5-40)	0.835
ICU Length of Stay	228/592 (38.51)									
≤ 7 days	51/141 (36.17)		13.8 (6.2-20.8)		24.8 (13.8-30.8)		80 (50-95)		10 (0-30)	
8 - 14 days	49/163 (30.06)		14.8 (10.2-19.2)		17.8 (15.2-21.8)		75 (55-90)		15 (0-35)	
15 - 21 days	55/96 (57.29)		13.8 (9.8-18.8)		8.2 (7.2-10.2)		60 (50-90)		15 (5-40)	
> 21 days	73/192 (38.02)	0.000	15.8 (10.2-22.8)	0.514	17.2 (11.8-27.2)	0.078	70 (50-85)	0.302	20 (5-45)	0.019

Topic: Critical care organisation, quality management, information systems, outcomes

001149

Incidence of fever in the first 72 h and neurological outcome in a population of Out of Hospital Cardiac Arrest (OHCA) patients

R. Fracchia¹, C. Ripa¹, M. Pozzi², E. Rezoagli¹, F. Gaiani², V. Bellin², M. Calabria², D. Aliverti Piuri², S. Beretta³, L. Avalli², G. Foti¹

¹School of Medicine and Surgery, University of Milan Bicocca, Monza, Italy; ²Department of Emergency and Intensive Care, Fondazione IRCCS San Gerardo dei Tintori, Monza, Italy; ³Department of Neurology, Fondazione IRCCS San Gerardo dei Tintori, Monza, Italy

Correspondence: R. Fracchia

Intensive Care Medicine Experimental 2023, 11 (Suppl 1):001149

Introduction: Targeted temperature management (TTM) in comatose patients after cardiac arrest has been used for decades [1,2]. In 2013 the TTM trial [3] proved that there is no significant difference

between targeting 33 °C or 36 °C. In the last years more studies have been published, some suggesting a positive effect of hypothermia on neurological outcome [4], others (as the TTM2 trial [5]) reiterating the equality between hypothermia and normothermia. The latest ERC-ESICM guidelines [6] recommend monitoring the temperature of comatose patients and preventing fever in the first 72 h.

Objectives: To determine the incidence of fever (temperature > 37.7 °C) on a population of patients admitted to a cardiac ICU (Intensive Care Unit) after OHCA and to analyze its possible correlation to mortality and neurological outcome.

Methods: We performed a retrospective analysis on adult patients admitted to our cardiac ICU after a witnessed OHCA from Aug 2019 to Dec 2022, limiting the data set to those with known low flow and no flow times and measured Neuron Specific Enolase (NSE) value at 48 h.

Results: We found no significant difference between the two groups in age ($p=0.484$), sex ($p=0.095$), ICU ($p=0.828$) and hospital ($p=0.879$) length of stay, death in the ICU ($p=0.087$), shockable rhythm presentation ($p=0.593$), no flow ($p=0.808$) and low flow ($p=0.246$) times, Cerebral Performance Category (CPC) > 3 at ICU discharge ($p=0.864$) and NSE value at 48 h ($p=0.693$). We found that the patients in the fever group had a statistically significant higher probability of having a GCS (Glasgow Coma Scale) > 8 both at 24 ($p=0.021$) and 48 ($p=0.019$) hours (Table 1). We found a descending trend in the number of patients who developed fever over the years.

Table 1 (abstract 001149) OHCA times, NSE value and GCS according to the development of fever. Where not otherwise specified, all values are expressed as median and interquartile range

	Overall (38)	No fever (31)	Fever (9)	p-value
No flow (min)	0 (0–7)	0 (0–7)	0 (0–7)	.808
Low flow (min)	29 (17–59)	41 (20–59)	22 (17–40)	.246
NSE 48h (ng/ml)	49.6 (26–156.8)	59 (24.2–158.1)	34 (27.2–104.9)	.693
GCS > 8 24h	13.2%	4%	30.8%	.021
GCS > 8 48h	23.7%	12%	46.2%	.019

Conclusions: Of the 38 analyzed patients, 9 developed fever during the first 72 h of ICU stay. No statistically significant correlation was found between fever during the first 72 h after OHCA and most of the mortality and neurological outcome variables we analyzed. The correlation between better GCS during the first two days in the ICU and the development of fever is probably due to the reduction in the pressure to achieve a strict temperature control in patients who are not comatose when sedation is stopped or reduced.

References

- [1] Hypothermia after Cardiac Arrest Study Group. "Mild therapeutic hypothermia to improve the neurologic outcome after cardiac arrest." *The New England journal of medicine* vol. 346,8 (2002): 549–56. <https://doi.org/10.1056/NEJMoa012689>
- [2] Bernard, Stephen A et al. "Treatment of comatose survivors of out-of-hospital cardiac arrest with induced hypothermia." *The New England journal of medicine* vol. 346,8 (2002): 557–63. <https://doi.org/10.1056/NEJMoa003289>
- [3] Nielsen, Niklas et al. "Targeted temperature management at 33 °C versus 36 °C after cardiac arrest." *The New England journal of medicine* vol. 369,23 (2013): 2197–206. <https://doi.org/10.1056/NEJMoa1310519>
- [4] Lascarrou, Jean-Baptiste et al. "Targeted Temperature Management for Cardiac Arrest with Nonshockable Rhythm." *The New England journal of medicine* vol. 381,24 (2019): 2327–2337. <https://doi.org/10.1056/NEJMoa1906661>
- [5] Dankiewicz, Josef et al. "Hypothermia versus Normothermia after Out-of-Hospital Cardiac Arrest." *The New England journal of medicine* vol. 384,24 (2021): 2283–2294. <https://doi.org/10.1056/NEJMoa2100591>

- [6] Sandroni, Claudio et al. "ERC-ESICM guidelines on temperature control after cardiac arrest in adults." *Intensive care medicine* vol. 48,3 (2022): 261–269. <https://doi.org/10.1007/s00134-022-06620-5>

Topic: Cardiac arrest

001150

A review of the efficacy of current Speech and Language Therapy practice for non-verbal communication support for those who are intubated and awake within the critical care setting: a service improvement study from a large London Teaching Hospital

K. Hook¹, Z. Garstang¹, J. Young¹, R. Sawyer¹

¹Speech & Language Therapy, King's College Hospital NHS Foundation Trust, London, United Kingdom

Correspondence: K. Hook

Intensive Care Medicine Experimental 2023, **11 (Suppl 1):**001150

Introduction: The Faculty of Intensive Care Medicine (2022), stipulates patients with communication difficulties need prompt Speech & Language Therapy (SLT) intervention.

Wojnicki-Johansson (2001), identified a disparity between nursing and patient perception of communicative success, raising the question as to whether critical care patients receive effective communication support and whether referrals to SLT for this purpose are made.

There is currently no clear guidance or criteria for referring intubated patients for non-verbal communication assessment.

Objectives: Establish whether intubated patients with a GCS 10+ receive appropriate communication support via the current method of SLT referral/prioritisation.

Explore whether GCS impacts the ability to provide bespoke communication guidelines for intubated patients.

Explore whether the presence of a neurological diagnosis impacts the ability to provide bespoke communication guidelines for patients who are intubated.

Methods: A service improvement study was conducted by a SLT team within a Tertiary Hospital over one month. All patients within the six adult ICUs were screened and referral to SLT triggered for those who were intubated and ventilated with a minimum GCS of 10 sustained over a four-hour period.

An assessment of non-verbal communication was completed by a qualified SLT working in ICU and provision of communication guidelines were directed by clinical reasoning.

The following data was collected:

GCS score, intubation status, presence of a neurological diagnosis, provision of bespoke communication guidelines post SLT assessment, consistency of non-verbal yes/no response.

Results: A total of 31 patients were prioritised for communication assessment. Of these, seven were extubated prior to SLT assessment.

Of those patients who were assessed, 81% had a GCS of 11 and 19% had a GCS of 10.

83% of all patients assessed were provided with bespoke communication guidelines post assessment (Table 1).

71% of all patients assessed were found to have a reliable non-verbal yes/no response which had not been established prior to SLT assessment (Table 2).

Conclusions: A tenfold increase in intubated patients prioritised for non-verbal communication assessment occurred during this improvement study. The majority of the patients who underwent assessment were provided with bespoke communication guidelines indicating impact of SLT intervention.

A higher GCS score was observed to correlate with the provision of communication guidelines. A more detailed review of GCS & its impact on provision of communication guidelines is therefore necessary.

The presence of a confirmed neurological diagnosis correlated with a lower success rate in establishing a consistent, non-verbal yes/no &/or provision of communication guidelines, however the small sample size is acknowledged.

These results support the need for improved SLT referrals for this patient group to ensure optimal care is provided, with further exploration into this indicated.

Table 1 (abstract 0001150)

	GCS 10	GCS 11	Confirmed neurological diagnosis	No confirmed neurological diagnosis
Communication guidelines provided	40%	94%	67%	93%
Communication guidelines not provided	60%	6%	33%	7%

Table 2 (abstract 0001150)

	GCS 10	GCS 11	Confirmed neurological diagnosis	No confirmed neurological diagnosis
Reliable & consistent non-verbal yes/no	60%	74%	60%	79%
Unreliable & consistent non-verbal yes/no	40%	26%	40%	21%

References

1. Wojnicki-Johansson, G. (2001). Communication between nurse and patient during ventilator treatment: patient reports and RN evaluations. *Intensive and Critical Care Nursing*, 17 (1), 29–39.
2. The Faculty of Intensive Care Medicine. (2022). Guidelines for the Provision of Intensive Care Services [Version 2.1.1]. <https://ficm.ac.uk/sites/ficm/files/documents/2022-07/GPICS%20V2.1%20%282%29.pdf>.

Topic: Critical care organisation, quality management, information systems, outcomes

001151

Acute hydrocephalus following aneurysmal subarachnoid hemorrhage: impact in the outcome

L. Antunes¹, R. Pereira², R. Guedes³, J. Fernandes⁴, C. Dias⁵, E. Pereira⁶, J. A. Paiva⁵, E. Monteiro⁵

¹Intensive Care Medicine Department, Hospital Fernando da Fonseca, EPE, Lisbon, Portugal; ²Intensive Care Medicine Department, Centro Hospitalar Universitário de Santo António, EPE, Porto, Portugal; ³Intensive Care Medicine Department, Centro Hospitalar Universitário São João, EPE, Porto, Portugal; ⁴Intensive Care Medicine Department, Centro Hospitalar Trás-os-Montes e Alto Douro, EPE, Vila Real, Portugal; ⁵Intensive Care Medicine Department, Centro Hospitalar Universitário São João, EPE, Faculty of Medicine–University of Porto, Porto, Portugal; ⁶Intensive Care Medicine Department, Centro Hospitalar Universitário São João, EPE, Porto, Portugal

Correspondence: L. Antunes

Intensive Care Medicine Experimental 2023, **11 (Suppl 1)**:001151

Introduction: Hydrocephalus is one of the most common complications of aneurysmal subarachnoid hemorrhage (aSAH), contributes to poor neurological outcomes and seriously affects and shortens survival time^{1,2}. People who survive aSAH carry an increased risk for various complications including epilepsy, depression, cognitive impairment, shunt requirement for hydrocephalus, and shunt complications³.

Methods: We retrospectively analyzed data from patients with aSAH admitted at a Neurocritical Care Unit (NCCU) from January-2018 until June-2022. Clinical files were reviewed for age, gender, location of aneurysms, Glasgow coma scale (GCS) score, severity of hemorrhage according to Fisher and Hunt and Hess grading scales, therapeutic options (neurosurgical clipping/endovascular coiling), placement of external ventricular drain (EVD) and its duration, clinical outcome and ICU and in-hospital lengths of stay. EVD-associated meningitis and requirement of life long ventriculoperitoneal shunt (VPS) in patients after using EVD were also assessed. Clinical outcome was evaluated according to Glasgow Outcome Scale (GOS).

Results: The study group consisted of 199 cases (**Table 1), 67 of which (33.7%) with hydrocephalus and EVD requirement.

Comparing patients with hydrocephalus with those without hydrocephalus, the mean age was similar as well as the ratio male/female (Table 1).

Regarding GCS at hospital admission, it was less than 6 in 18 patients (26.9%) in the hydrocephalus group (HG) and in 10 patients (9.1%) in the group without hydrocephalus (NHG).

Concerning Hunt and Hess severity scale, 52.3% of patients (n = 35) with hydrocephalus had grades IV or V. HG had higher Fisher and Hunt and Hess grades at admission.

There was no difference between the two groups regarding therapeutic strategy and location of the aneurysm.

Twelve patients (17.9%) had infection of the central nervous system (CNS) during ICU stay.

More than 1/3 of patients (n = 25) needed a VPS after EVD.

At NCCU discharge, only 16.5% (n = 11) of patients with hydrocephalus had a good outcome (GOS 4–5), compared with 54.5% (n = 72) of the patients without hydrocephalus. Vegetative outcome in HG was 9% (n = 6) and mortality occurred in 17.9% (n = 12) of patients.

ICU and hospital lengths-of-stay were longer in hydrocephalus group (**Table 1).

Hydrocephalus was an independent predictor to worse functional outcome (GOS ≤ 3) at 28 days, three and six months (*p* < 0.001).

Mortality at 6 months in HG was 27%, compared to 9.8% in NHG. However, it should be noted that nearly half of the patients in the HG improved clinically (n = 44 with GOS ≤ 3 at the time of discharge vs n = 21 at 6 months) (Table 2).

Conclusions: We conclude that the outcome is worst in patients who developed hydrocephalus, with higher rates of mortality and higher degree of functional dependence at NCCU discharge and throughout the follow-up up to 6 months.

Further research is needed to better understand the impact of other variables in outcomes in patients with aSAH who develop hydrocephalus, like the presence of vasospasm and infectious complications.

Table 1 (abstract 001151) Patient characteristics

Variables	Without EVD	With EVD	<i>p</i> value
Number of patients (n)	132	67	
Age (years, mean)	57	59	
Sex, n (%)	Male: 51 (38,6%); female: 81 (61,4%)	Male: 24 (35,8%); female: 43 (64,2%)	
GCS at admission			<i>p</i> < .001
15, n (%)	71 (53,8%)	12 (17,9%)	
13-14, n (%)	33 (25%)	24 (35,8%)	
7-12, n (%)	18 (13,6%)	13 (19,4%)	
3-6, n (%)	10 (7,6%)	18 (26,9%)	
Localization of the aneurysm			<i>p</i> = 0.98
Anterior circulation, n (%)	75 (56,8%)	35 (52,2%)	
Posterior circulation, n (%)	30 (22,7%)	21 (31,3%)	
aSAH angio-negative, n (%)	27 (20,5%)	11 (16,4%)	
Hunt-Hess severity scale			<i>p</i> < .001
I, n (%)	25 (18,9%)	1 (1,5%)	
II, n (%)	59 (44,7%)	8 (11,9%)	
III, n (%)	21 (15,9%)	23 (34,3%)	
IV, n (%)	15 (11,4%)	17 (25,4%)	
V, n (%)	12 (9,1%)	18 (26,9%)	
Fisher scale			<i>p</i> < .001
Grade 1, n (%)	8 (6,1%)	0	
Grade 2, n (%)	19 (14,4%)	1 (1,5%)	
Grade 3, n (%)	33 (25%)	1 (1,5%)	
Grade 4, n (%)	72 (54,5%)	65 (97%)	
Treatment			<i>p</i> = 0,288
Clipping, n (%)	57 (43,2%)	27 (40,3%)	
Coiling, n (%)	49 (37,1%)	30 (44,8%)	
No treatment, n (%)	26 (19,7%)	10 (14,9%)	
Vasospasm			<i>p</i> = 0,253
Yes, n (%)	57 (43,2%)	34 (50,7%)	
No, n (%)	75 (56,8%)	33 (49,3%)	
Days of EVD (mean ± SD)		18 ± 11,5	
Ventricular peritoneal shunt, n (%)		25 (37,3%)	
Meningitis, n (%)		12 (17,9%)	
GOS at ICU discharge			
1 (death), n (%)	10 (7,6%)	12 (17,9%)	
2 (vegetative state), n (%)	4 (3,0%)	6 (9%)	
3 (severe disability), n (%)	46 (34,8%)	38 (56,7%)	
4 (moderate disability), n (%)	32 (24,2%)	5 (7,5%)	
5 (good recovery), n (%)	40 (30,3%)	6 (9%)	
ICU length of stay (days), mean ± SD	17 ± 12	29 ± 15	
Hospital length of stay (days), mean ± SD	32 ± 22	52 ± 31	

EVD: external ventricular drain; GCS: Glasgow Coma Scale; SAH: subarachnoid hemorrhage; GOS: Glasgow Outcome Scale; SD: Standard Deviation.

Table 2 (abstract 001151) Clinical outcome

		At discharge	28 days	3 Months	6 Months
Patients without EVD (n=132)	Death, n	10	10	12	13
	GOS ≤ 3, n	50	38	22	14
	GOS > 3, n	72	81	88	91
	Not available, n	0	3	10	14
Patients with EVD (n=67)	Death, n	12	12	15	18
	GOS ≤ 3, n	44	43	31	21
	GOS > 3, n	11	12	20	24
	Not available, n	0	0	1	4

EVD: external ventricular drain, GOS: Glasgow Outcome Scale.

References

- 3) Hadie Adams. Risk of Shunting After Aneurysmal Subarachnoid Hemorrhage—A Collaborative Study and Initiation of a Consortium. *Stroke*. 2016;47:2488–2496
- 1) Yu-Chang Wang et al. Hydrocephalus after aneurysmal subarachnoid hemorrhage: Epidemiology, Pathogenesis, Diagnosis, and Management. *Signa Vitae* 2021 vol.17 (4), 4–17
- 2) Lu-Ting Kuo and Abel Po-Hao Huang et al. The Pathogenesis of Hydrocephalus Following Aneurysmal Subarachnoid Hemorrhage. *International Journal of Molecular Sciences* 2021, 22,5050

Topic: Neurointensive care

001153

The use of the ROX index to predict failure of high-flow nasal cannula in patients with Coronavirus disease 2019-associated acute respiratory distress syndrome

S. Poopipatpab¹, P. Nuchpramool¹, P. Phairatwet², T. Lertwattanachai³, K. Trongtrakul⁴

¹Anesthesiology, Faculty of Medicine Vajira Hospital, Navamindradhiraj University, Bangkok, Thailand; ²Internal Medicine, Faculty of Medicine Vajira Hospital, Navamindradhiraj University, Bangkok, Thailand; ³Pharmacology, Faculty of Medicine Vajira Hospital, Navamindradhiraj University, Bangkok, Thailand; ⁴Internal Medicine, Faculty of Medicine, Chiang Mai University, Chiang Mai, Thailand

Correspondence: S. Poopipatpab

Intensive Care Medicine Experimental 2023, **11 (Suppl 1)**:001153

Introduction: The usage of a high-flow nasal cannula (HFNC) has been widely applied to patients with mild-to-moderate Coronavirus disease 2019-associated acute respiratory distress syndrome (CARDS). The use of the ROX index, as calculated by the ratio of oxygen saturation (SpO₂)/fraction inspired oxygen (FiO₂)-to-respiratory rate, in the first few hours after the initiation of HFNC can assist identify the patients who will fail HFNC therapy. However, few studies documented the use of the ROX index during the period of HFNC therapy in patients with CARDS.

Objectives: We aimed to illustrate the diagnostic performance of the ROX index in predicting the failure of HFNC treatment when applied throughout the period of HFNC therapy. Additionally, we would like to determine the best cut-off point of the ROX index in determining the occurrence of HFNC failure and to compare it with the established ROX index cut-off point at ≤4.88 [1].

Methods: We retrospectively conducted the study from the patients with CARDS who received HFNC at the Faculty of Medicine Vajira Hospital, Navamindradhiraj University, Thailand, between April 1 and August 30, 2021. We calculated the ROX index every 4 h throughout HFNC treatment and defined HFNC failure as a subsequent need for mechanical ventilation. We analyzed the diagnostic performance of the ROX index using the area under the receiver operating characteristic (AUC) curve for the ROX index ≤4.88 in predicting HFNC failure and acquired a new ROX cut-off point using Youden's index.

Results: This study enrolled 212 patients with CARDS who commenced HFNC therapy. Of these, 81 patients (38.2%) suffered HFNC failure. An

acceptable diagnostic performance was determined when using the ROX index ≤4.88 in predicting HFNC failure, with the AUC of 0.77; 95%CI, 0.72–0.83; p<0.001. However, a new cut-off point of the ROX index of ≤5.84 delivered more optimal performance, with the AUC of 0.84; 95% CI, 0.79–0.88; p<0.001). A significant enhancement in the discriminative ability in the ROX index of ≤5.84 was found when compared with the ROX index cut-off point ≤4.88, with a p-value of 0.007 (Figure 1).

Conclusions: A ROX index ≤5.84 provided optimal performance in predicting HFNC failure in patients with CARDS.

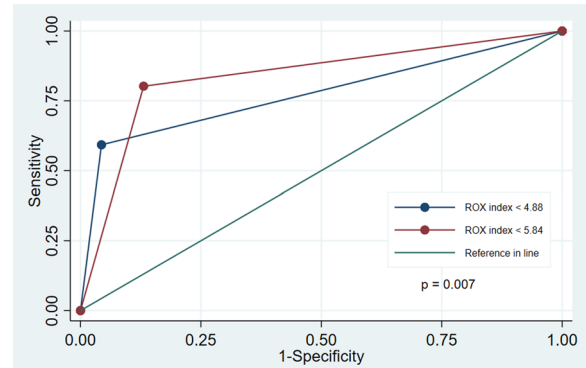

References

- Roca O, Messika J, Caralt B, García-de-Acilu M, Sztrymf B, Ricard JD, et al. Predicting success of high-flow nasal cannula in pneumonia patients with hypoxemic respiratory failure: The utility of the ROX index. *J Crit Care*. 2016;35:200–5.
- This study was supported by the Navamindradhiraj University Research Fund.

Topic: Acute respiratory failure and mechanical ventilation

001154

Effect of isotonic sodium bicarbonate infusion on perioperative acid–base status among patients undergoing emergency laparotomy surgery for acute abdomen: a randomised controlled trial

A. Singh¹, R. Chaudhary¹, N. Naik¹, Y. Sakaray²

¹Anaesthesia and Intensive Care, Post Graduate Institute of Medical Education & Research, Chandigarh, Chandigarh, India; ²General Surgery, Post Graduate Institute of Medical Education & Research, Chandigarh, Chandigarh, India

Correspondence: A. Singh

Intensive Care Medicine Experimental 2023, **11 (Suppl 1)**:001154

Introduction: Acid–Base disorders are common among surgical patients undergoing emergency laparotomy. Normal anion gap metabolic acidosis develops due to direct loss of sodium bicarbonate from GIT or administration of chloride rich solutions during resuscitation in these patients. In order to treat this, administering sodium bicarbonate makes physiological sense.

Methods: After ethical approval and written informed consent, 90 patients (ages 18 to 60 year) diagnosed with perforated peritonitis and required emergency laparotomy surgery were randomly allocated in two groups 45 each. Group - ISB (Isotonic Sodium Bicarbonate Group) received 2 ml/kg/hr 1.3% Isotonic bicarbonate and group -BSS (Balanced Salt Solution Group) received 2 ml/kg/hr Ringer Lactate (RL) as maintenance fluid during the intraoperative period. Primary outcome was to compare the difference in base excess (BE) between the two groups at the end of surgery. Secondary outcomes (pH, pCO₂, HCO₃, lactate levels, post-operative duration of mechanical ventilation, ionotrope requirement, ICU/HDU stay and incidence of Acute Kidney Injury) were observed and compared at different time intervals between the groups.

Results: The BE, median (Q1, Q3) was -7.30 ($-8.50, -6.30$) in the ISS and -4.80 ($-6.80, -4.10$) in the BSS group ($p=0.017$). The median (Q1, Q3) pH, HCO_3 and lactate values [7.3 ($7.27, 7.32$) vs 7.33 ($7.31, 7.35$); 18.1 ($17.3, 19.3$) vs 19.0 ($18.1, 20.2$); 1.6 ($1.3, 2.1$) vs 1.3 ($1.1, 1.89$)] were found significantly different at the end of surgery between group ISS and BSS respectively. The difference in duration of mechanical ventilation, ionotrope requirement and ICU/HDU stay were also found significant between the groups.

Conclusions: Intraoperative administration of isotonic sodium bicarbonate infusion improves perioperative acid-base status among patients undergoing emergency laparotomy.

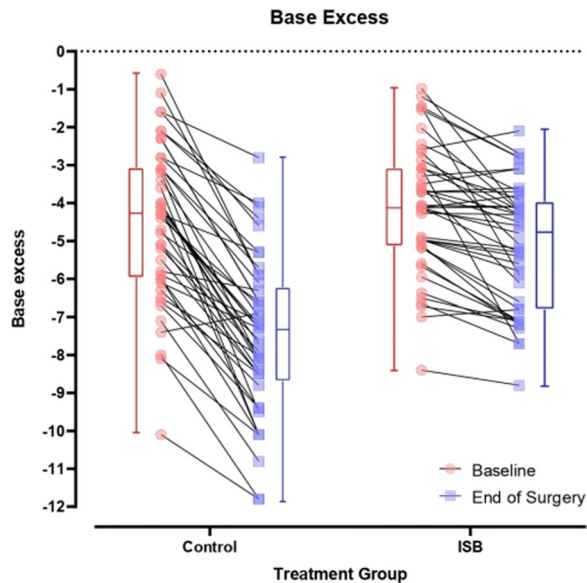

The BE values at the end of the surgery among the Study and the Control group.

References

3. Lawton T, Quinn A, Fletcher S. Perioperative metabolic acidosis: The Bradford Anaesthetic Department Acidosis ISB. *J Intensive Care Soc.* 2019; 20:11–7.
2. Reddi AS. Acid-Base Disorders: Clinical Evaluation and Management: Acid-Base Disorders in Surgical Patients. 1st edition. Switzerland; Cham: Springer International Publishing; 2020. p. 305–8.
1. Anaya DA, Nathens AB. Risk Factors for Severe Sepsis in Secondary Peritonitis. *Surgical Infections.* 2003; 4:355–62.
- there are no financial disclosures associated with this project.
5. Taghavi Gilani M, Razavi M, Peivandi Yazdi A. Incidence of Postoperative Acid-Base Disturbances in Abdominal Surgery. *Patient Saf Qual Improv.* 2014; 2 (2):82–85.
4. T.S, Sathu & G, Jeji & E.U, Sansho. Study of metabolic acidosis in patients undergoing surgeries of operative time greater than 2 h duration. *Journal of Evidence Based Medicine and Healthcare.* 2018; 5 (9): 840–846.

Topic: Perioperative care

001155

Oxidative stress in critically ill patients with acute renal failure undergoing treatment with continuous renal replacement techniques

F. Sánchez Morán¹, A. R. Villanova Landete¹, L. Mateu Campos¹, L. Tormo Rodríguez¹, J. Camaño Fortanet¹, S. Pérez Garrido²

¹Hospital General Universitario de Castellón, Intensive Care Unit, Castellón de la Plana, Spain; ²Facultad de Farmacia, University of Valencia, València, Spain

Correspondence: F. Sánchez Morán

Intensive Care Medicine Experimental 2023, **11** (Suppl 1):001155

Introduction: It has been documented that citrate anticoagulation during continuous renal replacement therapies (CRRT), mediated through reducing ionic calcium, attenuates inflammation and limits oxidative stress. Whether this is biologically relevant or not in terms of survival or recuperation of renal function, it seems that citrate anticoagulation would be more biocompatible by decreasing complement activation and neutrophil degranulation in the filter.

Objectives: To analyze oxidative stress in patients with acute renal failure treated with two anticoagulation modalities of the extracorporeal clearance system (heparin and citrate) and determine if there are differences between them.

Methods: Multicentric, prospective study, with random assignment of patients to system anticoagulation groups (heparin or citrate) during treatment with CRRT in the ICU. Twenty patients with acute renal failure were included. In each patient the plasma concentrations of oxidized (GSSG), reduced (GSH) glutathione and myeloperoxidase (MPO) were determined before the start of therapy, at 60 min and at 24 h in samples taken prefilter and postfilter.

The determination of GSSG and GSH in whole blood is performed by high performance liquid chromatography coupled with a mass spectrometry tandem. Quantification of peroxidase activity is based on the ability of these enzymes to oxidize tetramethylbenzidine (TMB) in the presence of hydrogen peroxide, and quantification of the reaction by spectrophotometry.

Quantitative variables are expressed as mean \pm standard deviation or as median and interquartile range (25% and 75%), as appropriate. To quantify the relationship between variables, the Student's T test or the Mann-Whitney U test was used. Categorical variables are expressed as counts and percentages and were compared using the Fischer test and odds ratio calculation to quantify the relationship between variables. A significance level of 5% bilateral was considered.

Results: There were no significant differences between the two groups regarding gender (85% male) and age (global mean age of 64.6 ± 9.2). Significant differences were detected for GSH concentrations at the beginning of the treatment and at 60 min pre-filter (111.2 ± 40.53 vs 130.13 ± 27.73 $\mu\text{mol/ml}$; $p 0.004$) for the overall sample and for the post-filter concentrations at 60 min according to the anticoagulation modality (102.6 ± 42.83 $\mu\text{mol/ml}$ for the heparin group vs 148.6 ± 50.52 $\mu\text{mol/ml}$ for the citrate group; $p 0.04$). No significant differences were detected for GSSG concentrations. GSSG/GSH ratios were significantly higher for patients in the heparin group at 24 h: prefilter 3.40 (IQR 2.34 – 6.21) pmol/ml for heparin vs 1.36 (IQR 1.17 – 1.98) pmol/ml for citrate ($p 0.006$) and postfilter 3.92 (IQR 2.17 – 6.41) pmol/ml for heparin vs 1.67 ± 8.39 pmol/ml for citrate ($p 0.015$).

Significant differences were found for the pre-filter and post-filter MPO values 60 min after the start of the technique. In the heparin group, significant differences were detected between the pre-treatment MPO concentration and the pre-filter concentration at 60 min (pre-filter MPO < pre-treatment MPO) and between the pre-filter and post-filter MPO values 60 min after the start of the technique (MPO postfilter > MPO prefilter), so that the differences found between MPO prefilter and postfilter at 60 min are attributable to the increase in MPO for the heparin group.

Mortality was 35% (4 patients in the heparin group and 3 in the citrate group, with no significant differences). No differences were found in oxidative stress values between survivors and deceased.

Conclusions: CRRT treatment of patients with ARF results in increased oxidative stress. Patients in the citrate anticoagulation group had higher GSH values, lower GSSG values, a more favorable GSSG/GSH ratio, and lower MPO values. These differences are detectable early, and suggest that support with CRRT and anticoagulation with citrate would be a less inflammatory stimulus.

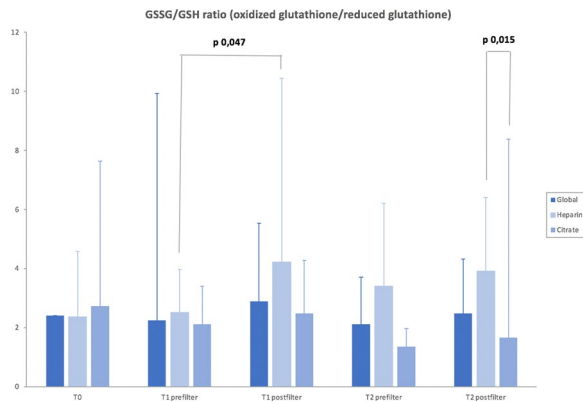

Figure 3 (abstract 001155) Oxidized glutathione/reduced glutathione ratio (GSSG/GSH)

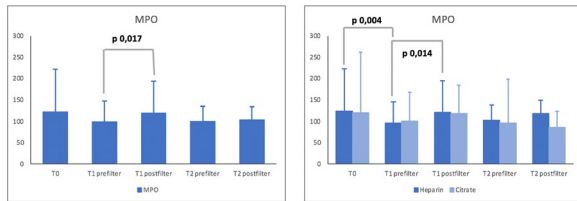

Figure 4 (abstract 001155) Mieloperoxidase

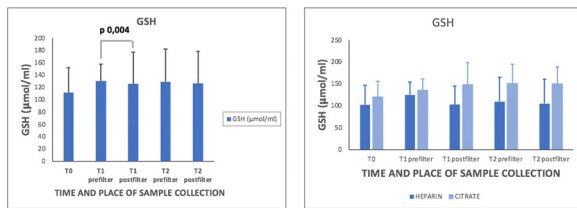

Figure 1 (abstract 001155) Reduced glutathione (GSH)

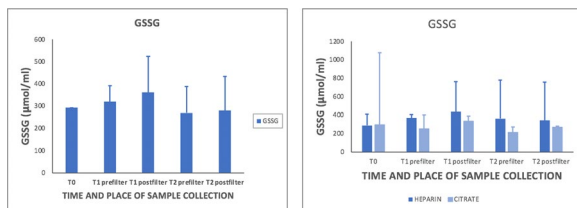

Figure 2 (abstract 001155) Oxidized glutathione (GSSG)

References

- Boer W, Verbrugghe W, Hoste E, Jacobs R, Jorens PG. Unapparent systemic effects of regional anticoagulation with citrate in continuous renal replacement therapy: a narrative review. *Ann Intensive Care*. 2023 Mar 11;13 (1):16. <https://doi.org/10.1186/s13613-023-01113-0>. PMID: 36899104; PMCID: PMC10006386.

Topic: Acute Kidney Injury and haemofiltration

001156

CMV Co-infection in critically ill patients with SARS-CoV-2 pneumonia

M. López Olivencia¹, C. Soriano Cuesta¹, N. Paredes De Dios², J. Higuera³, S. García Plaza², S. Saez Noguero⁴, A. Blandino Ortiz⁵, R. De Pablo⁶
¹Intensive care medicine, Hospital Ramón y Cajal, Madrid, Spain; ²Intensive care medicine, Hospital Ramón y Cajal, Madrid, Spain; ³Intensive medicine, Hospital Ramón y Cajal, Madrid, Spain; ⁴Intensive Care Medicine, Ramón y Cajal Hospital, Madrid, Spain; ⁵Intensive care, Hospital Universitario Ramón y Cajal, Madrid, Spain; ⁶Unidad de cuidados intensivos, Hospital Ramón y Cajal, Madrid, Spain

Correspondence: M. López Olivencia

Intensive Care Medicine Experimental 2023, **11 (Suppl 1)**:001156

Introduction: CMV infection is common in immunocompetent critical patients. Among other risk factors, dysfunction of the immune response seems to be important. Therefore, in patients with SARS CoV-2 pneumonia, immunosuppressed by therapies and with immunoparalysis due to the infection itself, could be at risk of CMV viral co-infection.

Objectives: To describe characteristics of critically ill patients with SARS CoV-2 pneumonia and CMV co-infection (CMV-COVID), its incidence, clinical features, and outcomes.

Methods: A retrospective single Center observational cohort study was performed. All consecutive patients admitted in our Department with SARS-CoV-2 pneumonia from 17/3/2020 to 28/12/2021 were included. SARS CoV-2 infection was confirmed by PCR of in nasopharyngeal swab. We define CMV infection/disease as detection of the CMV by PCR in plasma, and clinical manifestations, according to the definitions of the CMV Drug Development Forum. Weekly CMV DNA quantification (IU/ml) was performed.

Epidemiological data were collected (mechanical ventilation, severity scores, mortality, average length of stay, intra-ICU infections). Data are expressed as means ± standard deviation and results are compared using χ^2 tests.

Results: A total of 437 patients were screened, and among them, 30 patients (6.9%) were diagnosed with CMV infection/disease.

26 of the CMV-COVID patients developed at least one associated intra-ICU bacterial or fungal infection and 14 (46%) of the patients had *Aspergillus* confection.

In our cohort, ICU mortality in CMV-COVID patients was 45% (n = 13/30) versus 16.2% (71/437) in COVID patients (p = 0.00). In-hospital mortality was 48.4% (15/30) in CMV-COVID vs 17.1% (75/437) in COVID patients (p = 0.00).

Mean ICU LOS among CMV-COVID was 59 days and 22 days in COVID patients.

Conclusions: In our cohort, CMV-COVID co-infection was associated with more severe clinical feature, which was reflected with longer ICU length-of-stay and higher mortality. We should further study this association to get in deep about the pathophysiology, natural evolution, and related factors, to develop diagnostic and therapeutic bundles to improve the outcome of these patients.

	Pacientes CMV (n=30)	Total pacientes (n=437)
Sexo (hombre)	27 pacientes (90%)	306 pacientes (70%)
Edad media	64.7 +/- 8 años	58.7 +/- 13 años
Ventilación mecánica en 1 ^{er} 24 horas de ingreso en UCI	29 pacientes (96.6%)	306 pacientes (70%)
APACHE II	18.2 +/- 8.5	16 +/- 8.2
SOFA	7 +/- 3.3	6 +/- 3.3
SAPS II	45.6 +/- 15.5	38 +/- 16.1

Topic: Infections and prevention

001158

Hemolysis in short-term mechanical cardiac support and extracorporeal membrane oxygenation

A. Krüger¹, P. Ostadal¹, M. Janotka¹, J. Naar¹, D. Vondrakova¹, P. Neužil¹
¹Cardiovascular Center, Na Homolce Hospital, Prague, Czech Republic

Correspondence: A. Krüger

Intensive Care Medicine Experimental 2023, **11 (Suppl 1)**:001158

Introduction: Developments in the treatment with using of extracorporeal membrane oxygenation (ECMO) and percutaneous short-term ventricular assist devices (pVAD) have substantially improved the chances of survival of critically ill patients. However, alongside with the benefit of increase of the number of these procedures, also an increase of the occurrence of complications can be seen. One of the most frequent complication of using these devices in treatment is a hemolysis.

Objectives: The main aim of our study was to evaluate the relation between free hemoglobin levels and mortality or acute renal failure in patients supported with a pVAD or ECMO.

Methods: We analyzed data from 34 patients who received percutaneous short-term mechanical cardiac support of left ventricle—Impella (Abiomed Inc., Massachusetts, USA) or ECMO—CardioHelp (Maquet, Wayne, NJ) in a peripheral V-A or V-V configuration or a combination of supports (Impella+V-A ECMO). The free hemoglobin levels from patients were collected and assessed the severity of hemolysis depending on the type of support or combination of supports. At the same time, we assessed the risk of developing acute renal failure and the mortality of these critically ill patients.

Results: The average age in our group was 58 years (35–82). V-V ECMO has been used in 16 patients (47%) due to respiratory failure (COVID infection), in 18 patients (53%) we used peripheral V-A ECMO, Impella or their combination due to cardiogenic shock.

The value of free hemoglobin levels in the Impella group was comparable to the ECMO group (468 ± 73 vs 470 ± 61 mg/L), the free hemoglobin levels was significantly higher in the case of the combination of supports (V-A ECMO+Impella) (2213 ± 1163 mg/L, $P < 0.05$) than the both previous groups. Overall mortality in our group was 24% and correlated with higher values of free hemoglobin levels (1367 ± 383 vs 492 ± 66 mg/L; $P < 0.05$). Patients with a higher degree of hemolysis had significantly higher risk of acute renal failure and use the hemodialysis (3428 ± 1892 vs 503 ± 54 mg/L; $P < 0.05$).

Conclusions: The presence and degree of hemolysis represents one of the serious complications use extracorporeal circulation and mechanical cardiac supports. Our results indicate that free hemoglobin levels are a strong predictor of acute renal failure and higher levels are associated with mortality.

References

1. This study was supported by an Institutional grant MH-CZ-DRO (Nemocnice Na Homolce—NNH, 00023884), IG230501

Topic: Cardiac arrest

001164

Assessment of albumin binding capacity in patients with acute renal failure

G. Klinkmann¹, M. Misselwitz², S. Klammt², J. Henschel³, M. Gloger³, D. A. Reuter¹, S. Mitzner²

¹Department of Anaesthesiology, Intensive Care Medicine and Pain Therapy, University Medical Center Rostock, Rostock, Germany;

²Department of Internal Medicine, Division of Nephrology, University Medical Center Rostock, Rostock, Germany; ³Department of Internal Medicine, University Medical Center Rostock, Rostock, Germany

Correspondence: G. Klinkmann

Intensive Care Medicine Experimental 2023, **11 (Suppl 1)**:001164

Introduction: Albumin is the central transport protein for endogenous and exogenous toxins in the kidney, and its function determines the excretion of various substances. Recent studies on chronic liver and kidney insufficiency have shown that the binding capacity of albumin depends on the excretion capacity of the target organ and can be partially correlated with it. Acute kidney injury (AKI) is a complex syndrome that affects a significant proportion of critically ill patients. The impact of AKI on each patient's clinical condition has come to the fore in recent years, and growing awareness has driven research. Nevertheless, there is an urgent need to improve diagnostics.

Objectives: The aim of this study was to investigate a possible correlation between albumin binding capacity (ABiC), as a measure of albumin function, and severity, as measured by the stage of the disease, in acute renal failure.

Methods: In a prospective, uncontrolled and non-interventional clinical observational study, blood samples from 104 patients were collected sequentially over one week and evaluated. Albumin binding capacity was measured to investigate albumin function. By determining the unbound portion of the fluorescent marker dansylsarcosine, statements about the binding site-specific loading state of the albumin molecule could be made.

Results: The mean ABiC of the patients was significantly negatively correlated ($p = 0.001$) with the KDIGO stages of AKI. Patients with sepsis had a significantly lower ABiC than non-septic patients ($p < 0.001$), and even patients who developed sepsis during the course had a significantly lower ABiC on the day inclusion ($p = 0.042$). Patients who died during hospitalization had a significantly lower ABiC ($p = 0.038$) than survivors. Follow-up measurements over one week showed that ABiC also correlated with changes in ANV stage over time. ABiC change was significant from day one to day four ($p = 0.001$) and from day one to day seven ($p = 0.002$).

Conclusions: In AKI patients, the impairment of albumin function can be quantified, is related to the severity and to the course of the disease. In the future, ABiC could complement the portfolio of clinically practical biomarkers and may improve the prediction of the progression of acute kidney injury.

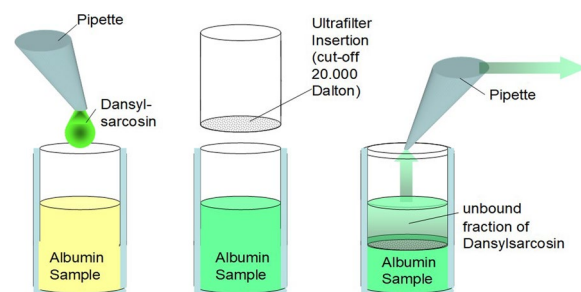

Albumin Binding Capacity (ABiC): a binding site II-specific test.

References

1. Klammt S, Mitzner SR, Stange J, Loock J, Heemann U, Emmrich J, Reisinger EC, Schmidt R. Improvement of impaired albumin binding capacity in acute-on-chronic liver failure by albumin dialysis. *Liver Transpl*. 2008 Sep;14 (9):1333–9. <https://doi.org/10.1002/lt.21504>. PMID: 18756471.
2. Klammt S, Wojak HJ, Mitzner A, Koball S, Rychly J, Reisinger EC, Mitzner S. Albumin-binding capacity (ABiC) is reduced in patients with chronic kidney disease along with an accumulation of protein-bound uraemic toxins. *Nephrol Dial Transplant*. 2012 Jun;27 (6):2377–83. <https://doi.org/10.1093/ndt/gfr616>. Epub 2011 Nov 15. PMID: 22086973.
3. Zarbock A, Nadim MK, Pickkers P, Gomez H, Bell S, Joannidis M, Kashani K, Koynert JL, Pannu N, Meersch M, Reis T, Rimmelé T, Bagshaw SM, Bellomo R, Cantaluppi V, Deep A, De Rosa S, Perez-Fernandez X, Husain-Syed F, Kane-Gill SL, Kelly Y, Mehta RL, Murray PT, Ostermann M, Prowle J, Ricci Z, See EJ, Schneider A, Soranno DE, Tolwani A, Villa G, Ronco C, Forni LG. Sepsis-associated acute kidney injury: consensus report of the 28th Acute Disease Quality Initiative workgroup. *Nat Rev Nephrol*. 2023 Feb 23.

<https://doi.org/10.1038/s41581-023-00683-3>. Epub ahead of print. PMID: 36823168.

Topic: Acute Kidney Injury and haemofiltration

001165

"We are here to learn"—an interpretative phenomenology research (IPA) study to explore the lived experiences of clinical nurse educators facilitating interprofessional simulation-based education

K. Hill¹

¹Critical Care, Queen Elizabeth University Hospital, Glasgow, United Kingdom

Correspondence: K. Hill

Intensive Care Medicine Experimental 2023, **11 (Suppl 1)**:001165

Introduction: There is a plethora of research on the benefit of a collaborative learning amongst participants in interprofessional education and simulation-based education. It would be insightful to explore how this concept of shared learning extends to the faculty members facilitating these educational sessions. From the perspective of the clinical nurse educator, this research study offers a unique insight into the nature of the collaborative teaching experience, processes of knowledge acquisition and transferability of learning and their influence on both clinical and teaching practice. This is of relevant to clinical nurse educators working in professional practice in critical care.

Objectives: To illuminate the lived experiences of clinical nurse educators facilitating interprofessional simulation-based education (IPSBE) to gain deeper insight on how this approach can influence their future practice.

Methods: An Interpretative phenomenology analysis (IPA) was chosen as the qualitative research approach for this study as it sought to illuminate the experiences of clinical nurse educators through the interpretation and validation of their unique 'first hand' experiences. A small purposive sample of clinical nurse educators that facilitated IPSBE was recruited to take part in semi-structured interviews. Data was inductively analysed using a systematic, step-by-step approach, generating meaningful themes and concepts that can be applied to the context of practice. Ethics approval sought from Glasgow Caledonian University.

Results: Four master concepts were derived from the interpretative analysis of the interviews: 'looking at things through a different lens'; the centrality of the debrief; 'we are actually learning all the time' and personal and professional growth. It was evident from the interviews that the clinical nurse educators learned from the participants and fellow faculty members when facilitating interprofessional simulation-based education. There was a recognition of the significance and importance of working, learning and teaching together. Interprofessional simulation-based education creates a safe space for learning that promotes an opportunity for shared learning to occur which can positively influence interprofessional relationships and practices, which can influence patient care and safety.

Conclusions: IPSBE creates a safe space for learning that promotes an opportunity for shared learning amongst faculty to occur which can positively influence interprofessional relationships and practices. These positive team based behaviours are transferable to which can impact patient care and safety. The detailed analysis and interpretation of the research findings led to recommendations for practice, education, policy and research.

References

1. INACSL Standards Committee (2021) Onward and Upward: Introducing the Healthcare Simulation Standards of Best Practice. *Clinical Simulation in Nursing*. Vol 58, pp. 1–4. <https://doi.org/10.1016/j.jecns.2021.08.006>.
2. Greenwood, K.C. and Ewell, S.B. Faculty development through simulation-based education in physical therapist education (2018). *Advances in Simulation*. Vol 3 (1). <https://doi.org/10.1186/s41077-017-0060-3>

3. Robertson, K., Ju, M., O'Brien, B.C., Van Schaik, S.M. and Bochatay, N. (2022) Exploring the role of power during debriefing of interprofessional simulations. *Journal of Interprofessional Care*. <https://doi.org/10.1080/13561820.2022.2029371>.

Topic: Nursing care and physiotherapy

001168

Early lung CT endotyping in spontaneously breathing patients with COVID-19 respiratory failure

D. Signori¹, Y. Xin², W. Sun², S. E. Gerard³, G. Vitale⁴, M. Giacomini⁴, G.

Foti¹, L. Mussoni⁵, J. Montomoli⁶, M. Subert⁷, M. Tavola⁸, F. L. Lorini⁹, S.

Spadaro¹⁰, J. Laffey¹¹, G. Citerio¹, G. Bellani¹², MF. Cereda², E. Rezoagli¹

¹School of Medicine and Surgery, University of Milano-Bicocca, Monza, Italy; ²Anesthesia, Harvard Medical School, Boston, United States

of America; ³Department of Biomedical Engineering, The University

of Iowa, Iowa City, United States of America; ⁴Anesthesia and Intensive

Care Medicine, Policlinico San Marco, Zingonia, Italy; ⁵Emergency

Department, Istituto Per La Sicurezza Sociale, Città di San Marino, San

Marino; ⁶Anesthesia and intensive care medicine, Ospedale "Infermi" di

Rimini, Rimini, Italy; ⁷Anesthesia and Intensive Care Medicine, Agenzia

di Tutela della Salute della città Metropolitana di Milano, Melegnano,

Italy; ⁸Anesthesia and Intensive Care Medicine, Alessandro Manzoni

Hospital, Lecco, Italy; ⁹Dipartimento di emergenza urgenza e area critica,

ASST Papa Giovanni XXIII, Bergamo, Italy; ¹⁰Department of Morphology,

Surgery and Experimental Medicine, University of Ferrara, Ferrara,

Italy; ¹¹Anaesthesia and Intensive Care Medicine, School of Medicine,

and Regenerative Medicine Instit, National University of Ireland Galway,

Galway, Ireland; ¹²Anesthesia and Intensive Care, Centre for Medical

Sciences-CISMed, University of Trento, Trento, Italy

Correspondence: D. Signori

Intensive Care Medicine Experimental 2023, **11 (Suppl 1)**:001168

Introduction: Acute respiratory distress syndrome (ARDS) complex biological behavior and clinical heterogeneity require identifying distinct subgroups of patients to target specific therapy, improving the efficacy of interventions. ARDS sub-phenotypes with distinct clinical and biological features and differential treatment responses have been identified using latent class analysis (LCA). (1) Computerized tomography (CT) is a powerful lung imaging method that may contribute to better disease stratification. (2,3).

Objectives: We hypothesized that a deep-learning analysis of lung CT in patients with SARS-CoV-2-induced respiratory failure could describe specific morphological and quantitative alterations of the lung parenchyma, reflecting the severity of gas exchange impairments. We hypothesize that these findings will correlate with patient outcomes.

Methods: This is a clinical study of lung CT images in patients confirmed SARS-CoV-2 positive by PCR analysis. Lung-CT data from 853 patients were collected during the first wave of the COVID-19 pandemic in Italy within a multicenter observational study titled (NCT04395482). CT images were segmented using an established convolutional neural network previously validated in COVID-19 patients. (4) After segmentation lung masks were inspected by a trained investigator and manually adjusted using ITK-snap software. (5) For each CT, six parameters were analyzed: average CT intensity in Hounsfield Units (HU), lung gas volume and tissue mass by density analysis, percentage of consolidated tissue (CT intensity > -200 HU), percentage of ground glass opacity (CT intensity -750 to -200 HU), and percentage of total injury (CT intensity > -750 HU). (6) We applied a latent class model by using 18 relevant CT variables to the lung CT data (7) to stratify patients into three cohorts of 183, 421, and 249 for class I,II, and III, respectively.

Results: Among the 3 CT phenotypes, the 6 CT explored parameters significantly differed between classes. Lung injury severity was the lowest in class 3, intermediate in class 2, and highest in class 1 (Table1).

Survival at 90 days significantly differed across the three different CT clusters, as highlighted in Figure 1.

Conclusions: LCA on CT data in COVID-19 patients allowed us to identify three different CT clusters associated with survival at 90-day follow-up.

Table 1 (abstract 001168) Lung CT parameters are divided by CT classes. Values are expressed as mean (Standard Deviation)

	1 (A)	2 (B)	3 (C)	p-value
n	183 (21.4)	421 (49.4)	249 (29.2)	/
Lung density (HU)	-539 (107)	-699 (61)	-813 (34)	<0.001
Lung gas volume (L)	1.84 (0.81)	2.68 (0.92)	4.15 (1.10)	<0.001
Lung weight (kg)	1.51 (0.52)	1.12 (0.32)	0.92 (0.18)	<0.001
Total injury, fraction	0.66 (0.14)	0.45 (0.13)	0.21 (0.07)	<0.001
GGO, fraction	0.48 (0.12)	0.4 (0.12)	0.18 (0.06)	<0.001
Consolidation, fraction	0.18 (0.11)	0.06 (0.03)	0.03 (0.01)	<0.001

Differences between the 3 clusters of lung CT images were assessed by one-way ANOVA (p-value column). HU = Hounsfield Units; GGO: Ground Glass Opacities.

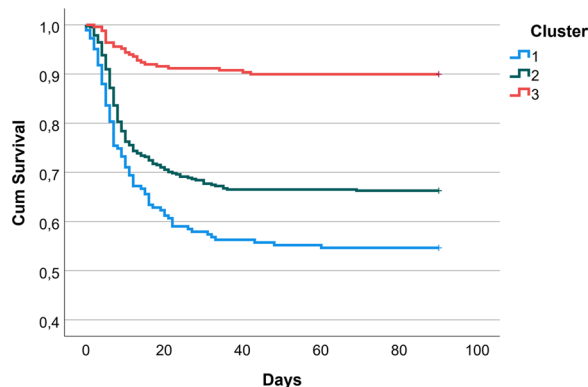

Figure 1 (abstract 001168) Survival analysis stratified across 3 clusters of lung CT injury at 90-day follow-up

References

- Sinha P, Calfee CS. Phenotypes in acute respiratory distress syndrome: moving towards precision medicine. *Curr Opin Crit Care.* 2019;25 (1):12. <https://doi.org/10.1097/MCC.0000000000000571>
- Ball L, Scaramuzza G, Herrmann J, Cereda M. Lung aeration, ventilation, and perfusion imaging. *Curr Opin Crit Care.* 2022;28 (3):302. <https://doi.org/10.1097/MCC.0000000000000942>
- Perchiazzi G, Larina A, Hansen T, et al. Chest dual-energy CT to assess the effects of steroids on lung function in severe COVID-19 patients. *Crit Care Lond Engl.* 2022;26 (1):328. <https://doi.org/10.1186/s13054-022-04200-z>
- Gerard SE, Herrmann J, Xin Y, et al. CT image segmentation for inflamed and fibrotic lungs using a multi-resolution convolutional neural network. *Sci Rep.* 2021;11 (1):1455. <https://doi.org/10.1038/s41598-020-80936-4>
- Yushkevich PA, Piven J, Hazlett HC, et al. User-guided 3D active contour segmentation of anatomical structures: significantly improved efficiency and reliability. *NeuroImage.* 2006;31 (3):1116–1128. <https://doi.org/10.1016/j.neuroimage.2006.01.015>
- Kauczor HU, Heitmann K, Heussel CP, Marwede D, Uthmann T, Thelen M. Automatic detection and quantification of ground-glass opacities on

high-resolution CT using multiple neural networks: comparison with a density mask. *AJR Am J Roentgenol.* 2000;175 (5):1329–1334. <https://doi.org/10.2214/ajr.175.5.1751329>

- Maddali MV, Churpek M, Pham T, et al. Validation and utility of ARDS subphenotypes identified by machine-learning models using clinical data: an observational, multicohort, retrospective analysis. *Lancet Respir Med.* 2022;10 (4):367–377. [https://doi.org/10.1016/S2213-2600\(21\)00461-6](https://doi.org/10.1016/S2213-2600(21)00461-6)

Topic: Acute respiratory failure and mechanical ventilation

001169

Comparison of various lactate levels for predicting ICU-mortality in cardiogenic shock: a retrospective study

G. Klemm¹, S. Markart¹, A. Stoiber², S. Wanka², T. Staudinger², G. Heinzl¹, A. Hermann², R. Zilberszac¹

¹Department of Internal Medicine II-Intensive Care Unit 13h3, Medical University of Vienna, Vienna, Austria; ²Department of Internal Medicine I-Intensive Care Unit 13i2, Medical University of Vienna, Vienna, Austria

Correspondence: G. Klemm

Intensive Care Medicine Experimental 2023, **11 (Suppl 1)**:001169

Introduction: Despite the clear progress, prognosis in cardiogenic shock (CS) remains poor. Even though the metabolism of lactate is a complex and elevated levels may have numerous causes, lactate is a frequently used prognostic marker. However, it is not well known, which measurement of lactate is the most meaningful in terms of predicting ICU-mortality (intensive care unit).

Objectives: This study sought to compare various values of lactate of the first 24 h after ICU-admission (intensive care unit) for mortality prediction in patients with cardiogenic shock: concentration at admission (FL) and after 24 h (LL), peak concentration (PL) as well as the 24 h lactate clearance (LC) were analyzed. The SAPS3-score (simplified acute physiology score) was also described. The findings of this study might support the early decision-making regarding treatment of CS.

Methods: For this retrospective analysis 600 consecutive patients were screened for cardiogenic shock. Exclusion criteria were intoxication, pregnancy, missing measurements of lactate and age < 18 years. 64 patients were analyzed. Baseline characteristics as well as FL, PL, LL and LC were analyzed in univariate and multivariate logistic regression to determine prognostic performance. The AUROCs (area under receiver operating characteristics curve) of FL, PL, LL and LC were calculated and tested for significant differences. Cut-off-values were described. The primary outcome was ICU-mortality.

Results: The ICU-mortality of the study population was 34,4%. The mean age was 62 years, 72% were male and the average SAPS3-score was 72 points. The age was a univariate predictor of ICU-mortality, the SAPS3-score also a multivariate predictor. FL did not show significant results. PL was not a significant predictor in the multivariate analysis, but showed a significant AUC in the ROC-Analysis ($p = 0,028$). The results of LL and LC were significant in the multivariate analysis (both $p < 0,01$) as well as in the ROC-analysis (both $p \leq 0,001$). LL had the greatest AUROC (0,809), but did not show significant difference to the AUROC of SAPS3 (0,799; $p = 0,5304$) and LC (0,762; $p = 0,5047$) in the De-Long-Test. However, the AUROC of LL did differ significantly from AUROC of PL (0,659; $p = 0,0142$) and FL (0,573; $p = 0,0029$).

Conclusions: In terms of predicting ICU-mortality in cardiogenic shock the lactate concentration after 24 h (LL) was superior to the concentration on admission (FL), the peak concentration (PL) and the 24 h clearance (LC).

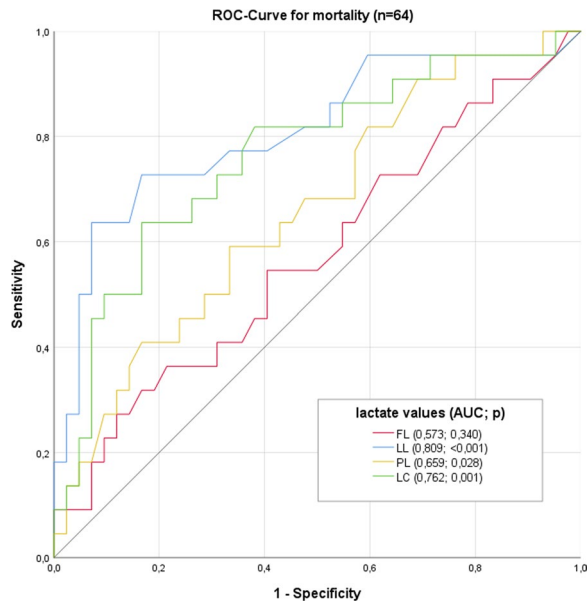

De-Long-Test						
Comparison	p	ΔAUC in ROC	SE	95%-CI		z-statistics
LC vs. LL	0,5047	0,0465	0,0698	-0,0902	0,1830	0,667
LC vs. PL	0,3228	0,1040	0,1050	-0,1020	0,3100	0,989
LL vs. PL	0,0142*	0,150	0,0614	0,0302	0,2710	2,452

*... statistically significant result (p < 0,0167);

Topic: Cardiovascular issues in ICU

001170

The prognostic value of antithrombin levels in COVID-19 patients on intensive care unit admission

I. Anakli¹, M. Canbaz¹, Ö. Polat¹, YH. Özdemir², P. Ergin Ozcan¹, G. Orhun¹, M. Sezgin³, F. Esen¹

¹Anesthesiology and intensive care, Istanbul University, Faculty of Medicine, Istanbul, Turkey; ²Medical faculty, University of Massachusetts Medical School, Worcester, United States of America; ³Neurology, Istanbul University Faculty of Medicine, Istanbul, Turkey

Correspondence: I. Anakli

Intensive Care Medicine Experimental 2023, 11 (Suppl 1):001170

Introduction: Hypercoagulopathy caused by COVID-19 may be responsible for mortality, so it is important to identify markers for an effective anticoagulant strategy for physicians (1). D-dimer and fibrinogen levels have been found to have prognostic values in COVID-19 patients but, data on the impact of antithrombin (AT) levels associated with the outcome are scarce (2).

Objectives: We primarily aimed to analyze the relationship between AT levels on intensive care unit (ICU) admission and mortality in critically ill COVID-19 patients. The secondary aim was to reveal the impact of other markers on the prognosis of COVID-19.

Methods: We retrospectively enrolled consecutive critically ill patients (≥ 18 years old) with COVID-19, who were admitted to the ICU of Istanbul University from March 2020 to June 2021. The Ethics committee of the University Hospital approved the study (2020/64179). We collected demographic, clinical, and laboratory data of the patients on the ICU admission. Descriptive analyses were applied and normality has been checked with the Kolmogorov–Smirnov test. Mean standard deviation

values of continuous data were reported accordingly. Categorical data were given with counts and percentages. Group comparisons were calculated with Student’s T-test due to the large sample size (sample size > 200) for continuous variables. A receiver operating characteristic (ROC) curve analysis was used to determine the cutoff values. Statistical analysis was performed with the SPSS 25.0 statistical package and p < 0.05 was set as statistically significant.

Results: Four hundred ten critically ill patients with COVID-19 were included in the study. The demographic, clinical characteristics of the patients are summarized in Table 1. The laboratory parameters are depicted in Table 2. Significantly lower AT levels were recorded in non-survivors than survivors (77,9% vs. 82,5). ROC curves were designed according to AT and D-dimer levels (Figure 1). The cutoff levels for AT and D-dimer were 70,5% and 1585 µg/L, respectively. Cumulative survival was lower in patients with AT ≤ 70,5% and D-dimer ≥ 1585 µg/L than AT > 70,5% and D-dimer < 1585 µg/L (p = 0,001) (Fig. 2).

Conclusions: The main finding of this study is low AT levels on the ICU admission in COVID-19 patients are associated with mortality. Previous studies showed that there was no significant difference between non-survivors and survivors in terms of AT, although AT levels were lower in non-survivors than survivors (84% vs. 91%) (3). In our study, significantly lower AT levels were found in non-survivors than survivors. Our statistical difference most probably is because of the large sample size. Recent studies reported that elevated D-dimer levels may identify patients at higher risk for mortality (2, 3, 4). In our study, non-survivors had significantly higher D-dimer levels. When AT and D-dimer were analyzed together, the mortality prediction was better than D-dimer or AT.

Table 2 (abstract 001170) Laboratory parameters of patients on the ICU admission

Variables	Survivors	Non-Survivors	P value
Antithrombin activity (%)	82,5±19	77,9±21,1	0,027
CRP (mg/L)	122±100	147±186	0,116
Leucocytes (10 ⁸ µL)	10,62±6,05	11,52±7,07	0,18
Ferritin (ng/mL)	1246±1554	2452±6115	0,012
D-dimer (µg/L)	2774±3298	4177±5025	0,002
Lymphocytes (10 ⁸ µL)	0,89±0,89	1,03±1,93	0,382
Platelets (10 ⁸ µL)	263±142	246±126	0,188
Fibrinogen (mg/dL)	577±163	561±233	0,44
PT (sec)	16,5±12	16,1±7,3	0,638
aPTT (sec)	43,8±161	34±18	0,352

CRP: C-reactive protein; PT: Prothrombin time; aPTT: activated partial thromboplastin time.

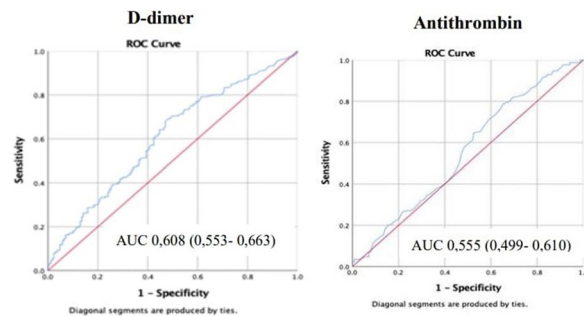

Figure 1 (abstract 001170) ROC curve for mortality predicted by D-dimer and antithrombin levels

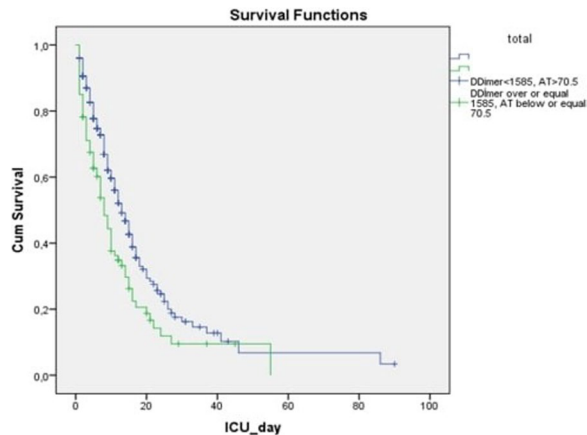

Figure 2 (abstract 001170) Kaplan Meier survival curve for overall survival of patients with COVID-19. Patients whose admission antithrombin (AT) activity levels were $\leq 70,5\%$ - D-dimer levels $\geq 1585 \mu\text{g/L}$ ($n=85$) and those who are not ($n=323$) are presented by green and blue curves, respectively with shorter survival for patients with AT activity $\leq 70,5\%$ and D-dimer levels $\geq 1585 \mu\text{g/L}$ ($p=0,001$). Kaplan Meier survival curve for overall survival of patients with COVID-19. Patients whose admission antithrombin (AT) activity levels were $\leq 70,5\%$ - D-dimer levels $\geq 1585 \mu\text{g/L}$ ($n=85$) and those who are not ($n=323$) are presented by green and blue curves, respectively with shorter survival for patients with AT activity $\leq 70,5\%$ and D-dimer levels $\geq 1585 \mu\text{g/L}$ ($p=0,001$).

Table 1 (abstract 001170) Demographic and clinical characteristics of the patients

Parameters	Survivors (n=170)	Non-survivors (n=240)	p Value
Sex (male) (n, %)	113 (66%)	149 (62%)	0,36
Age (years)	63±14	67±14	0,025
Body mass index (kg/m ²)	25,9±2,7	26,7±3,3	0,022
APACHE II	16±7	20±9	0,018
SOFA at admission	4± 2	6± 3	<0,001
Comorbidities			
Hypertension (n, %)	89 (52%)	122 (50%)	0,76
Diabetes mellitus (n, %)	58 (34%)	84 (35%)	0,85
Chronic cardiac disease (n, %)	56 (32%)	95 (39%)	0,17
Chronic pulmonary disease (n, %)	33 (19%)	42 (17%)	0,62
Chronic cerebrovascular disease (n, %)	14 (8%)	36 (15%)	0,04
Chronic renal disease (n, %)	20 (11%)	37 (15%)	0,30
Malignancy (n, %)	26 (14%)	59 (24%)	0,02
Mechanical ventilation (n, %)	78 (45%)	220 (91%)	<0,001
Vasopressor therapy (n, %)	80 (47%)	213 (89%)	<0,001
Renal replacement therapy (n, %)	24 (14%)	76 (31%)	<0,001
Intensive care unit days	11±104	10±10	0,154

APACHE II: Acute physiology and chronic health evaluation II; SOFA: Sequential organ failure assessment.

References

- None
4. Yao Y, Cao J, Wang Q, et al.: D-dimer as a biomarker for disease severity and mortality in COVID-19 patients: a case control study. *J Intensive Care.* 2020 Jul 10; 8: 49.
3. Tang N, Li D, Wang X, Sun Z. Abnormal coagulation parameters are associated with poor prognosis in patients with novel coronavirus pneumonia. *JThromb Haemost.* 2020; 18: 844–7.
2. Zhou F, Yu T, Du R, Fan G, Liu Y, Liu Z et al. Clinical course and risk factors for mortality of adult inpatients with COVID-19 in Wuhan, China: a retrospective cohort study. *Lancet.* 2020;395 (10229):1054–1062.
1. Ackermann M, Verleden SE, Kuehnel M, et al. Pulmonary vascular endothelialitis, thrombosis, and angiogenesis in Covid-19. *N Engl J Med* 2020; 383: 120–128. 2. Zhou F, Yu T, Du R, Fan G, Liu Y, Liu Z et al. Clinical course and risk factors for mortality of adult inpatients with COVID-19 in Wuhan, China: a retrospective cohort study. *Lancet.* 2020;395 (10229):1054–1062. 3. Tang N, Li D, Wang X, Sun Z. Abnormal coagulation parameters are associated with poor prognosis in patients with novel coronavirus pneumonia. *J Thromb Haemost.* 2020; 18: 844–7. 4. Yao Y, Cao J, Wang Q, et al.: D-dimer as a biomarker for disease severity and mortality in COVID-19 patients: a case control study. *J Intensive Care.* 2020 Jul 10; 8: 49.

Topic: Haematologic-oncologic issues in the ICU

001171

Changes in respiratory support therapies after oxygen saturation alarms: a retrospective study

S. A. I. Klopfenstein¹, A. R. Flint¹, E. Salgado¹, M. Prendke¹, J. Chromik², F. Balzer¹, A. S. Poncette¹

¹Institute of Medical Informatics, Charité-Universitätsmedizin Berlin, Berlin, Germany; ²Digital Health-Connected Healthcare, Hasso Plattner Institute, Potsdam, Germany

Correspondence: S.A.I. Klopfenstein

Intensive Care Medicine Experimental 2023, **11 (Suppl 1)**:001171

Introduction: Working on safer clinical alarm systems based on data-driven decisions is one of the National Patient Safety Goals[®] defined in 2023 by the Joint Commission [1]. Oxygen saturation (SpO2) alarms are critical as they might indicate deterioration in ventilation.

Objectives: We aimed to retrospectively analyze respiratory support therapies (RST) interventions performed timely after SpO2 alarms in two intensive care units (ICUs) of an university hospital and determine the associated actionable to non-actionable alarms ratio.

Methods: Following IRB approval (EA1/127/18), we transposed previously developed annotation guidelines and ventilation-related mappings into Python scripts: The mappings link ventilation devices, modes and airway devices to seven gradually escalating RST [2] based on medical knowledge and ISO 19223:2019 norm [3]. We queried 656 days of data from two ICUs between 2019 and 2021. SpO2 alarms were actionable when a RST escalation presumably followed within 30 min of their start.

Results: We identified 1.963 unique patients with 251.314 SpO2 alarms. 12.729 SpO2 alarms (5%) from 821 unique patients were actionable. Most escalations were performed in patients with low dose oxygen therapy (OT, 52%) or high flow oxygen therapy (HFOT, 38%) pre-alarm. The RST pre-alarm was most often escalated to the next superior RST, except for patients with OT pre-alarm: Out of 6.604 escalations, 75% were associated with the RST “ventilation-mode group 4a” (assisted ventilation) post-alarm (Table 1 and Figure 1).

Table 1 (abstract 001171) Actionable alarms based on escalations with the associated RST pre- and post-alarm; OT: Low Dose Oxygen Therapy, HFOT: High Flow Oxygen Therapy, VMG: Ventilation-mode Group, HFJV: High Frequency Jet Ventilation

RST Pre-Alarm	RST Post-Alarm					
	OT	VMG 4b	HFOT	VMG 4a	VMG 1b,2b,3	VMG 1a,2a,HFJV
Spontaneous breathing (no oxygen supply)	306	-	10	37	19	9
OT	-	47	445	4952	917	243
VMG 4b	-	-	8	2	1	2
HFOT	-	-	-	3626	734	496
VMG 4a	-	-	-	-	692	101
VMG 1b,2b,3	-	-	-	-	-	82

Conclusions: Our study is the first to granularly examine changes in RST after an alarm. Results suggest that personnel should pay attention to patients on OT or HFOT and focus on alarm management strategies, e.g., by setting individual, meaningful alarm thresholds in these patients. However, the current classification is rule-based and documentation-dependent. To get a more comprehensive picture of SpO2 alarms' actionability and derive policies, we will include more interventions such as changes of airway devices or modifications of ventilation parameters, and contextual information about the cohort, as well as validate the alarm classification in follow-up studies. Findings of our studies could be incorporated in the development of future clinical decision support systems.

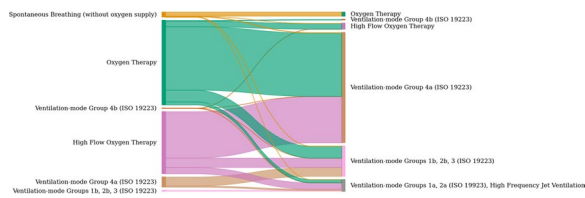

Figure 1 (abstract 001171) Respiratory support therapies pre- and post-alarm of actionable oxygen saturation alarms

References

- [1]: The Joint Commission. National Patient Safety Goals® Effective July 2023 for the Hospital Program. 2023. [Internet]. Available from: https://www.jointcommission.org/-/media/tjc/documents/standards/national-patient-safety-goals/2023/npsg_chapter_hap_jul2023.pdf
- [2] Klopfenstein SAI, Flint AR, Heeren P, et al. How to Annotate Patient Monitoring Alarms in Intensive Care Medicine for Machine Learning. Research Square; 2023. <https://doi.org/10.21203/rs.3.rs-2514969/v1>.
- [3] ISO International Standardization Organization. Lung ventilators and related equipment—Vocabulary and semantics. (ISO International Standardization Organization, 2019)
- INALO project (grant 16SV8559, German Federal Ministry of Education and Research)

Topic: Acute respiratory failure and mechanical ventilation

001172

New Onset Refractory Status Epilepticus (NORSE): possibility of a good outcome despite prolonged and complicated ICU stay

F. Stretti¹, F. Casagrande¹, A. Eisele², SY. Bögli², E. Keller¹, G. Brandi¹
¹Intensive Care Medicine, University Hospital of Zürich, Zürich, Switzerland; ²Neurology, University Hospital of Zürich, Zürich, Switzerland

Correspondence: F. Stretti

Intensive Care Medicine Experimental 2023, 11 (Suppl 1):001172

Introduction: NORSE is a neurologic emergency without an immediately identifiable cause [1, 2]. The complicated and long ICU stay of the patients [3–5] can lead to perceive a prolongation of therapies as futile. However, a recovery is possible even in severe cases [6]. This retrospective study investigates NORSE patients, with focus on ICU treatment, outcome and ethical decisions.

Methods: 283 adults were admitted with status epilepticus (SE) to the Neurocritical Care Unit of the University Hospital Zurich, Switzerland, between 01.2010 and 12.2022. We identified 25 NORSE cases [2]. We collected demographic, clinical, therapeutic and outcome data.

Results: Most patients were female (68%), previously healthy (Charlson comorbidity index 1 [0–4]), and relatively young (53 [17–67] years). 96% presented with super refractory SE. Despite extensive workup, the majority (64%) of cases remains cryptogenic. Most patients had a long and complicated ICU-stay (Table 1). The in-hospital mortality was 40%. The cause of death for 75% of the patients was the withholding/withdrawing of therapies. The decision was triggered by medical staff except for one patient. The End-of-life (EOL) decision was taken 22 days after diagnosis. Death occurred 4 days after the decision. Most surviving patients (67%) were seizure-free after 1 year. The functional outcome improved with time (Figure 1).

Number of AEDs (median[IQR])	5 [4–7]
Duration of treatment with anaesthetic agents (days, median[IQR])	8 [6–18]
Duration of invasive mechanical ventilation (days, median[IQR])	17 [9–25]
ICU complications (n of patients)	22 (88%)
infections	18 (72%)
respiratory	16 (64%)
metabolic	14 (56%)
gastrointestinal	10 (40%)
cardiac	9 (36%)
Length of stay on ICU (days, median[IQR])	21 [18–31]
Length of stay in hospital (days, median[IQR])	39 [26–55]
Death	12 (46%)
Limitation of treatment (n = 12)	9 (75%)
mRS at discharge* (n = 16, median and range)	4 [4–5]
mRS at last available follow-up* (n = 13, median and range)	2 [1–3]

Conclusions: In this case series, a mortality comparable to that previously reported was observed in young and previously healthy patients with NORSE. A higher proportion of conscious EOL decisions was taken compared to available data [6, 7], where this issue was not specifically addressed and may have been underreported.

In comparison to other diseases, the EOL decision was taken relatively late. For NORSE patients, a longer period of observation and treatment is necessary: the turnover time of many investigations usually takes many days (e.g. autoimmune testing). Furthermore, no validated prognostic tools exist due to the rarity and the geographical spread of the cases, which makes the prognostication harder.

Medical staff mostly triggered the EOL decision, but the next of kin was always involved in the discussion, so it is assumable that the decisions were informed and based on presumed patient's wishes. Futility is highly dependent on an individual's values. Based on the few Advance Directives (3/12 patients), most individuals perceived disability as an undesirable outcome and life-sustaining therapies therefore as futile. In these cases, the therapy was redirected.

Until reliable prognostic scores are available, EOL decisions can only be made to the best of medical knowledge and considering the patients' presumed wishes. Because the long-term outcome can be favorable in NORSE survivors, clinicians should be careful in taking EOL decisions to avoid the risk of a self-fulfilling prophecy. Our results encourage clinicians to continue treatment even in initially refractory cases.

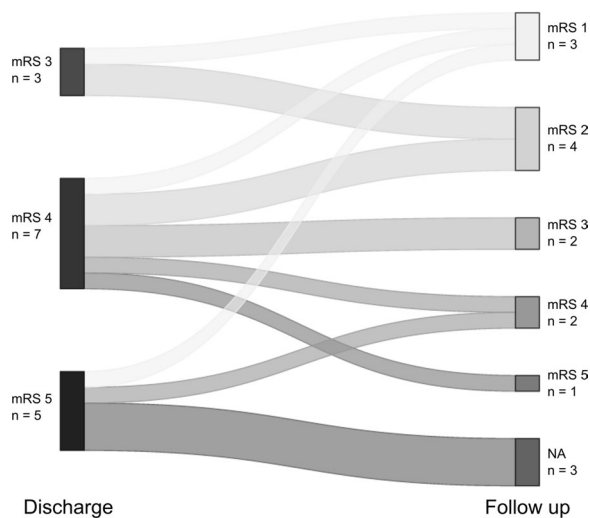

Figure 1 (abstract 001172 Modified Rankin Score at discharge and at last available follow-up

References

3. Aarangzeb, S., et al., New-onset super refractory status epilepticus: A case-series. *Seizure*, 2020. 75: p. 174–184.
4. Mantoan Ritter, L. and L. Nashef, New-onset refractory status epilepticus (NORSE). *Pract Neurol*, 2021.
5. Guggler, J.J., et al., New-onset refractory status epilepticus: A retrospective cohort study. *Seizure*, 2020. 74: p. 41–48.
6. Gaspard, N., et al., New-onset refractory status epilepticus: Etiology, clinical features, and outcome. *Neurology*, 2015. 85 (18): p. 1604–13.
7. Matthews, E., et al., New-onset super-refractory status epilepticus: A case series of 26 patients. *Neurology*, 2020. 95 (16): p. e2280–e2285.
1. Wickstrom, R., et al., International consensus recommendations for management of New Onset Refractory Status Epilepticus (NORSE) including Febrile Infection-Related Epilepsy Syndrome (FIREs): Summary and Clinical Tools. *Epilepsia*, 2022.
2. Hirsch, L.J., et al., Proposed consensus definitions for new-onset refractory status epilepticus (NORSE), febrile infection-related epilepsy syndrome (FIREs), and related conditions. *Epilepsia*, 2018. 59 (4): p. 739–744.

Topic: Neurointensive care

001174

Effect of intravenous dexmedetomidine on intracranial pressure using optic nerve sheath diameter in laparoscopic surgery with steep trendelenburg position: a prospective randomized placebo controlled trial

O. P. Singh¹, S. L. Soni², V. Ganesh¹, N. B. Panda¹, K. Kajal², S. Gainer³, A. P. Sharma⁴

¹Anaesthesia and Intensive Care, Post Graduate Institute of Medical Education & Research, Chandigarh, Chandigarh, India; ²Anaesthesia and Intensive Care, Post Graduate Institute of Medical Education & Research, Chandigarh, Chandigarh, India; ³Obstetrics and Gynaecology, Post Graduate Institute of Medical Education & Research, Chandigarh, Chandigarh, India; ⁴Urology, Post Graduate Institute of Medical Education & Research, Chandigarh, Chandigarh, India

Correspondence: V. Ganesh

Intensive Care Medicine Experimental 2023, **11 (Suppl 1)**:001174

Introduction: Optic nerve sheath diameter (ONSD) has been extensively studied as a non-invasive substitute for ICP monitoring. The potential for increased intracranial pressure (ICP) in patients with increased intra-abdominal pressure (IAP), although poorly documented, has been demonstrated through higher ONSD values in laparoscopic procedures with steep Trendelenburg position^{1,2}. This often leads to transient acute confusional states in the postoperative period³. The effect of dexmedetomidine on ICP or ONSD has remained controversial over the years.

Methods: We conducted a randomized controlled trial on 50 adult patients of ASA I and II presenting for laparoscopic procedures with Trendelenburg position > 25 degrees, to assess the effect of intraoperative dexmedetomidine 1 µg/kg followed by 0.4 µg/kg/hr against a placebo-controlled group that received 0.9% saline (NS) infusion at the same rate. Both groups received general anaesthesia as per standard protocol. The ONSD and intra-ocular pressures were measured at T1—baseline (10 min after endotracheal intubation), T2—Five minutes after Trendelenburg position, T3—one hour after T2 and T4—five minutes after releasing pneumoperitoneum.

Results: Both groups were well balanced in terms of demographics and baseline parameters. In our study, patients who received dexmedetomidine had statistically significant lower mean ONSD in group D at 1-h after Trendelenburg position in comparison to group NS (5.7 ± 0.8 mm vs. 6.3 ± 0.8 mm; P = 0.002). Also, the patients who received dexmedetomidine had statistically significant lower mean ONSD in group D in comparison to group NS at 5-min after gas deflation (5.5 ± 0.7 mm vs. 5.9 ± 0.9 mm; P = 0.041). There was no clinically or statistically significant difference in perioperative hemodynamics or sedations scores.

Conclusions: From our study we may conclude that Dexmedetomidine may potentially lower ICP as per changes in ONSD compared with placebo group in laparoscopic surgeries in steep Trendelenburg position. Further studies with larger sample size are needed to validate the effect of Dexmedetomidine on ICP.

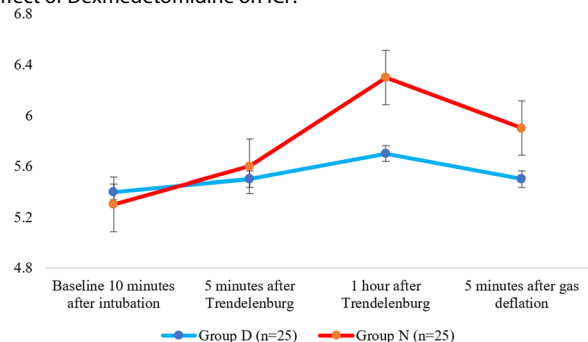

Trends of ONSD between groups.

References

1. There are no financial disclosures associated with this research work
2. Shah SB, Bhargava AK, Choudhury I. Noninvasive intracranial pressure monitoring via optic nerve sheath diameter for robotic surgery in steep Trendelenburg position. *Saudi J Anaesth*. 2015;9:239.
3. Blecha S, Harth M, Schlachetzki F, Zeman F, Blecha C, Flora P, et al. Changes in intraocular pressure and optic nerve sheath diameter in patients undergoing robotic-assisted laparoscopic prostatectomy in steep 45° Trendelenburg position. *BMC Anesthesiol*. 2017;17:40.
4. Chen K, Wang L, Wang Q, Liu X, Lu Y, Li Y, et al. Effects of pneumoperitoneum and steep Trendelenburg position on cerebral hemodynamics during robotic-assisted laparoscopic radical prostatectomy. *Medicine (Baltimore)*. 2019;98:e15794

Topic: Perioperative care

001175

Validation of the accuracy of the ICH Score in Japanese patients with cerebral hemorrhage and identification of predictive factors

Y. Fujimoto¹, S. Egawa²

¹Department of Emergency and Critical Care Medicine, St. Marianna University School of Medicine, Kawasaki, Japan; ²Department of Neurointensive Care, TMG Asaka Medical Center, Asaka, Japan

Correspondence: Y. Fujimoto

Intensive Care Medicine Experimental 2023, **11 (Suppl 1)**:001175

Introduction: An accurate neurological prognosis in the acute phase of a cerebral hemorrhage would be very effective in clinical practice to ensure a shared understanding of severity among medical staff, provide explanations to the patient's family, and predict the result of the acute phase of the hemorrhage. The intracerebral hemorrhage score (ICH score) is suggested in guidelines as a prognostic score and is utilized in clinical practice. However, the ICH score is based on data from > 20 years ago and includes cases of withdrawal from life-sustaining therapies. In Japan, we frequently experience that the ICH score does not predict the prognosis following a clinical practice.

Objectives: The study aimed to clarify the accuracy of the ICH score at our hospital and to assess prognostic factors appropriate for cerebral hemorrhage cases.

Methods: The study design was a single-center retrospective medical record survey. We retrospectively analyzed the medical records of all patients admitted with intracerebral hemorrhage between January 2018 and December 2021 at the Toda Medical Group Asaka Medical Center in Saitama, a 446-bed hospital in Saitama, Japan. Patient age, gender, history, medical history, GCS at presentation, the site of hemorrhage, hematoma volume, ventricular perforation, midline shift, acute symptomatic seizures, 30-day mortality, neurologic outcome at discharge, and transfer destination were examined. At the Japanese Society of Intensive Care Medicine's annual meeting, this study was presented halfway through the 2018–2020 data; however, as there were so few instances, multivariate analysis was not feasible. As a result, one more year of data was added, and the study was reevaluated. Statistical processing was conducted using SPSS (ver. 25), and the accuracy of the ICH score was first examined using the receiver operator characteristic curve. Univariate analysis was employed to narrow down the items with a relatively high association with 30-day mortality, and multivariate analysis was used to find predictive factors.

Results: The precision of the ICH score in predicting 30-day mortality at our institution remained low (AUC of 0.66 [95%CI: 0.49–0.84]). In univariate analysis, GCS ≤ 10 (OR11.0 95%CI: 1.2–100.6, p=0.02), blood loss ≥ 100 ml (OR15.3 95%CI: 2.2–104.5, p=0.02), midline shift (OR5.8 95%CI: 0.9–36.0, p=0.07), and maintenance dialysis (OR24.8 95%CI: 3.37–182.8, p=0.01). Multivariate analysis found GCS at presentation and maintenance dialysis to be significant.

Conclusions: The accuracy of the ICH score at our institution remained low compared to previous reports. Although some items were proposed as predictors of 30-day mortality, we believe it is suitable to take into account GCS and maintenance dialysis as the basis for a comprehensive study. We hope that more accurate prognostic factors will be identified for cerebral hemorrhage patients in Japan in the future.

Topic: Neurointensive care

001176

Real-time remote audio-visual system versus standard buddy system to monitor the doffing of personal protective equipment during Covid 19 pandemic: An observational study

N. Naik B¹, M. S. Lazar¹, V. Ganesh², A. Singh¹, P. G D¹

¹Anaesthesia and Intensive care, Post Graduate Institute of Medical Education & Research, Chandigarh, Chandigarh, India; ²Anesthesiology, All India Institute Of Medical Sciences New Delhi, New Delhi, India

Correspondence: N. Naik B

Intensive Care Medicine Experimental 2023, **11 (Suppl 1)**:001176

Introduction: Literature states a higher self-contamination rate among healthcare workers (HCWs) while doffing personal protective equipment (PPE). During the Covid-19 pandemic, onsite trained observers were not always available to monitor PPE compliance. The remote audio-visual doffing surveillance (RADS) system has the potential to overcome this limitation (Figure 1). [1,2] We aimed to compare the efficacy of this real-time RADS system against the onsite buddy system for monitoring the doffing of PPE.

Objectives: To compare the efficiency and safety of the RADS system versus the standard onsite buddy system. The incidence of breach/error in biosafety and the satisfaction levels among HCWs doffing PPE with both systems were determined.

Methods: This prospective, observational study was carried out at our tertiary care centre in northern India. Study was registered in the clinical trial registry India (CTRI/2020/11/038172). 200 HCWs who cared for Covid-19 patients in the intensive care units/operation theatres were included. Group A included HCWs who performed doffing with the help of an onsite trained observer and group B included HCWs who performed doffing with the RADS system. An independent observer noted the error at any step using the CDC doffing checklist, in both groups. An online questionnaire to analyze the level of satisfaction post-doffing was also surveyed.

Results: The proportion of errors committed during doffing was significantly lower in group B compared to group A with a low relative risk of 0.34 (95% CI 0.22 to 0.51) (p<0.001) (Fig. 2 A & B). In both groups, there was no difference in HCWs feedback regarding the ease of the system and fear of committing an error. Though the perceived quality of monitoring was felt better with onsite buddy, the overall confidence rating of being safe after doffing was better with the RADS system.

Conclusions: Real-time RADS system may be more effective than the onsite buddy system for ensuring the safety of HCWs during doffing PPE. HCWs level of satisfaction related to the ease and anxiety with the monitoring systems were comparable. RADS system can reduce reliance on HCW resources and can integrate well into existing healthcare systems.



Figure 1 (abstract 001176) A trained observer assisting doffing from remote location using real time RADS system

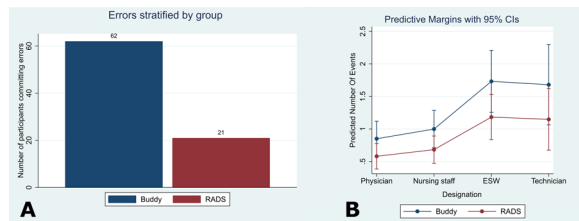

Figure 2 (abstract 001176) (A) Barplot showing the number of participants committing errors in each group; (B) Point plot showing the predicted margins (incidence rate ratios, with 95% CIs) of committing a greater number of errors/events across occupational designation classes during doffing stratified by experimental groups. (ESW = Environmental Sanitation Workers, RADS = Remote Audio-visual Doffing Surveillance System)

References

- Naik B N, Singh A, Lazar MS, Ganesh V, Soni SL, Biswal M, Das K, Kaur S, Puri G. Performance of Health Care Workers in Doffing of Personal Protective Equipment Using Real-Time Remote Audio-Visual Doffing Surveillance System: Its Implications for Bio-Safety Amid COVID-19 Pandemic. *Cureus*. 2021 Sep 18;13 (9):e18071
- Singh A, Naik BN, Soni SL, Puri GD. Real-Time Remote Surveillance of Doffing During COVID-19 Pandemic: Enhancing Safety of Health Care Workers. *Anesth Analg*. 2020 Aug;131 (2):e112-e113
- None

Topic: Critical care organisation, quality management, information systems, outcomes

001177

Exploring service equity in the Speech and Language Therapy management of patients with delirium in a Critical Care setting

J. Young¹, R. Sawyer¹, K. Potter¹, Z. Garstang¹

¹Speech & Language Therapy, King's College Hospital NHS Foundation Trust, London, United Kingdom

Correspondence: J. Young

Intensive Care Medicine Experimental 2023, **11 (Suppl 1)**:001177

Introduction: Guidelines exist which provide overarching recommendations for the prevention, assessment and management of delirium in acute hospital settings. NICE CG103 (2010) reference the need to adequately address dehydration by ensuring sufficient fluid intake for patients and highlight the importance of observing for non-verbal signs of pain, particularly for those patients who are unable to communicate using their voice, for example those with a tracheostomy in situ. The NICE guidance also recommends orientation and communication is optimised for patients with delirium, with involvement from family and friends. Speech and Language Therapists (SLTs) play a pivotal role in facilitating return to oral intake (aiding management of dehydration and normalising mealtime routines) and managing barriers to effective communication.

Whilst the RCSLT position statement (2019) highlights the role of SLT in the management of delirium within critical care, there remains a scarcity of clinical guidelines in this area. As a result it was hypothesised that there was likely to be variation in how patients with delirium were being managed across SLT, leading to inequity within the service.

Objectives: To explore current Speech and Language Therapy clinical practice for patients with delirium who present with communication and swallowing disorders within Critical Care in order to establish equity of service.

Methods: Two questionnaires were created and distributed to the Critical Care SLT team in a tertiary London hospital (completed by 5 SLTs).

- Clinical scenarios (questionnaire 1):** 6 × referral-based clinical scenarios provided with multiple choice answers pertaining to management options
- Confidence rating and knowledge-based (questionnaire 2):** 6 × open-ended questions to establish current practice and 1 × Likert scale for confidence rating

Results: Questionnaire 1:

- There was no consensus regarding SLT management of patients with delirium
- Referrals more likely to be accepted: (a) for patients with a confirmed neurological diagnosis and delirium, (b) when there is an identified negative impact on patient wellbeing

Questionnaire 2:

- Variable perception of SLT impact
- Lack of consistency in management approaches utilised
- Good knowledge of Multidisciplinary Team (MDT) roles in delirium management
- 20% of the team felt 'very confident' in managing patients with delirium

Conclusions: Currently there is a lack of consistency in how patients with delirium are managed by SLTs within Critical Care. Whilst knowledge of MDT roles in the management of delirium was identified as a relative strength, there is room for improved SLT confidence in the management of this patient cohort. Due to these factors, there is scope for ongoing service improvement initiatives to optimise equity of service for patients with delirium.

References

- Royal College of Speech and Language Therapists. (2019). Position statement: Speech and language therapists working in adult and paediatric critical care units. Available at: [rcslt-position-statement-critical-care.pdf](https://www.rcslt.org/position-statement-critical-care.pdf)
- National Institute for Clinical Excellence. (2010). Delirium: prevention, diagnosis and management in hospital and long-term care Clinical guideline [NICE guideline CG103]. Available at: <https://www.nice.org.uk/guidance/cg103/resources/delirium-prevention-diagnosis-and-management-pdf-35109327290821>

Topic: Sedation, analgesia and delirium

001179

"Evaluation of the splenic resistive index, as a marker of hypoperfusion; Compared with Lactate, Delta CO₂, Capillary refill and Renal resistive index in patients with shock"

K. H. Lopez Rodriguez¹, G. A. José Carlos², M. A. Carrasco Flores³, M. A. Amezcua-Gutiérrez³, J. Garduño-López³, M. Vidals-Sánchez¹, R. D. C. Gutiérrez Góngora³, R. Rodríguez Villanueva³, D. Navarro Martínez⁴, E. Hernandez-Dominguez⁵, M. A. Juan Gomez³, N. M. Sánchez Parada³
¹Adults intensive care unit, Hospital Juárez de México, Ciudad de México, Mexico; ²Adults intensive care unit, Hospital Juárez de México, Ciudad de México, Mexico; ³Adult intensive care unit, Hospital Juárez de México, Ciudad de México, Mexico; ⁴Intensive care, Hospital Juárez de México, Ciudad de México, Mexico; ⁵Intensive Care Unit, Hospital Juárez de México, Ciudad de México, Mexico

Correspondence: K.H. Lopez Rodriguez

Intensive Care Medicine Experimental 2023, **11 (Suppl 1)**:001179

Introduction: The spleen in its anatomy is an intra-abdominal organ, due to embryological origin, is located in the left lateral flank, posterior to the stomach, and close to the kidneys; habitually should be in that anatomical position and normally there should be only one spleen, although in occasions there are accessory spleens.

Analysis of the splenic vasculature, it is assessed by the splenic resistance index (SRI), is closely related to cardiovascular function and can be used to evaluate preload reserve; a reduction > 9% is a parameter of volume response with specificity of 100%, and a reduction > 4% is associated with an improvement in splanchnic circulation and a decrease in systemic vascular resistance. This has been confirmed by its correlation with changes in serum lactate and central venous saturation. Therefore, the splenic resistive index in context of shock state can be modified in a similar way to other markers of hypoperfusion.

Objectives: To compare the splenic resistive index with clinical signs, biochemical and ultrasonographic hypoperfusion markers in a patient in state of shock at admission to Intensive Care Unit.

Methods: This analysis was designed as a descriptive, prospective and transversal study. In the intensive care unit of the Juárez Hospital in Mexico from March 1, 2022 to March 1, 2023. Evaluating the patient upon admission to the intensive care unit, in a state of shock regardless the cause, The SRI was evaluated and measured by two ultrasonographers with experience in this technique, through the speed of diastolic and systolic blood flow. Taking as reference an elevation of the splenic resistive index more than 0.6. Using difference CO₂ and serum lactate as a hypoperfusion systemic state.

Results: When comparing the splenic resistive index in shock patients with respect to other markers of systemic hypoperfusion. We found The splenic resistive index and serum lactate have a similar elevation directly proportional in a shock patients (Confluence value 0.025). We found a close relationship between the elevation of the renal resistance index and the length of stay in the intensive care unit, of 29 patients, the 16% (4.6 p) has a length of stay of more than 5 days in the ICU. In this case 3 patients were death.

The prevalence of death was the 2% of all population.

Conclusions: The splenic resistive index is an ultrasonographic marker, it is directly related to the elevation of clinical and biochemical markers of systemic hypoperfusion. Therefore, it can be used as an initial evaluation at bedside of patient admission to the intensive care unit As well as predictor of length of stay in the intensive care unit.

References

1. 7.- Lerolle N, Guerot E, Faisy C, Bornstein C, Diehl JL, Fagon JY (2006) Renal failure in septic shock: predictive value of Doppler-based renal arterial resistive index. *Intensive Care Med* 32:1553–1559
2. 6.- Derudder S, Cheisson G, Mazoit JX, Vicaut E, Benhamou D, Duranteau J (2007) Renal arterial resistance in septic shock: effects of increasing mean arterial pressure with norepinephrine on the renal resistive index assessed with Doppler ultrasonography. *Intensive Care Med* 33:1557–1562
3. 5.- Brusasco C, Tavazzi G, Robba C, Santori G, Vezzani A, Manca T, Corradi F (2018) Splenic Doppler resistive index variation mirrors cardiac responsiveness and systemic hemodynamics upon fluid challenge resuscitation in postoperative mechanically ventilated patients. *Biomed Res Int* 2018:1978968
4. 4.- Gelman S, Mushlin PS (2004) Catecholamine-induced changes in the splanchnic circulation affecting systemic hemodynamics. *Anesthesiology* 100:434–439.
5. 3.- Corradi F, Brusasco C, Garlaschi A, Santori G, Vezzani A, Moscatelli P, Pelosi P (2012) Splenic Doppler resistive index for early detection of occult hemorrhagic shock after polytrauma in adult patients. *Shock* 38:466–473
6. 2.- Zwuebel WJ, Pellerito JS. Introduction to Vascular Ultrasonography, 5th edition. New York: Mosby/Elsevier; 2009:1–14.
7. 1.- Corradi F, Via G, Tavazzi G. What's new in ultrasound-based assessment of organ perfusion in the critically ill: expanding the bedside clinical monitoring window for hypoperfusion in shock. *Intensive Care Med*. 2020 Apr;46 (4):775–779.

Topic: Systemic diseases

001180

Improving patient safety with unfamiliar medications on ITU

L. Moore¹, D. Lloyd¹, S. Dibble¹

¹Critical care unit, Royal Cornwall Hospital, Truro, United Kingdom

Correspondence: L. Moore

Intensive Care Medicine Experimental 2023, **11 (Suppl 1)**:001180

Introduction: Hospital electronic prescribing (EP) is an important item on the UK government health policy agenda: Hospitals in England were expected to be paperless by 2020 but are behind schedule. It is argued the greatest benefits are associated with integrated EP systems because they offer improved communication between prescribers, pharmacists and other stakeholders; by aiding decision or administration support; and providing a robust audit trail for the entire medicines use process. Medication incidents are often multifaceted. Human and electronic factors must be considered when investigating medication incidents.

Methods: Following a patient safety incident on critical care, where a patient received three times the required dose of rituximab on critical care, an appreciative inquiry approach was used to identify root causes for potential errors when administering rarely used medicines. Medical, nursing & pharmacy professions consulted. Electronic and human factors were investigated with the aim for preventing future occurrences.

Results: Twenty-four contributory factors were identified during the investigation. The main themes were (1) lack of knowledge by doctors, nurses and pharmacists on where to look for information (2) Lack of Trust protocol relating to medication administration. (3) Incorrect prescribing on the EP record and (4) Inappropriate pharmacy supply.

Multi-pluralistic approaches to the investigation were used to avoid conflict. It was further minimised by ensuring positive and negative processes were identified in all groups rather than one member within the multi-professional team being singled out to avoid blame culture. A Trust protocol for safe and standardised rituximab use in vasculitis has been written and published on the Trust e-library.

A new pharmacy specific single point of entry for notes was created in electronic record which has subjected to two to plan-do-study-act cycles to maximise effectiveness. This is accessible to all members of the multi-professional team.

The pharmacy on-call training for critical care needed revision.

The results of the investigation were shared with all critical care and pharmacy staff via email and presented within the forum of departmental governance meetings to ensure shared understanding and learning.

The number of medication incident reports for critical care has reduced since the above interventions have been introduced.

Conclusions: Good communication is essential to multi-professional working.

Ensuring a consistent, easy access, single point of access for all pharmacy information was important to the multi-professional team.

An improved critical care induction for on-call pharmacists, with familiarisation with the specific critical care integrated EP system has been necessary.

Integrated EP systems have the potential to minimise medication errors but the importance of good clinical understanding of medication must not be underestimated.

References

1. Rycroft-Malone, J., Fontenla, M., Seers, K. & Bick, D. 2009. Protocol-based care: the standardisation of decision-making? *Journal of Clinical Nursing*, 18, 1490–1500.

- Zamzam, A et al. 2016. Impact of electronic prescribing on patient safety: implications for the UK. *Clinical Pharmacist*, 8 (5) <https://doi.org/10.1211/PJ.2016.20201013>
- NES, NHS EDUCATION FOR SCOTLAND. Quality Improvement Zone -QI tools [Online]. Available: <https://learn.nes.nhs.scot/1262> [Accessed 06/04/2023].
- Mukhopadhyay, A et al. 2015. Differences in the handover process and perception between nurses and residents in a critical care setting. *J Clin Nurs*, 24, 778–85.
- BOS, J. et al. 2017. A multifaceted intervention to reduce guideline non-adherence among prescribing physicians in Dutch hospitals. *International Journal of Clinical Pharmacy*, 39, 1211–1219.
- nil

Topic: Critical care organisation, quality management, information systems, outcomes

001181

Immunoparalysis in septic shock patients

G. Klinkmann¹, DA. Reuter², M. Sauer³, J. Altrichter⁴, S. Mitzner⁵

¹Department of Anaesthesiology and Intensive Care Medicine, University Medical Center Rostock, Rostock, Germany; ²Department of Anaesthesiology, Intensive Care Medicine and Pain Therapy, University Medical Center Rostock, Rostock, Germany; ³Center for anesthesiology and intensive care medicine, Klinikum Magdeburg, Magdeburg, Germany; ⁴Artcline gmbh, Artcline GmbH, Rostock, Germany; ⁵Department of Internal Medicine, Division of Nephrology, University Medical Center Rostock, Rostock, Germany

Correspondence: G. Klinkmann

Intensive Care Medicine Experimental 2023, **11 (Suppl 1)**:001181

Introduction: Sepsis and septic shock induce immune dysfunction characterized by immune cell depletion, T cell exhaustion, reduced production of pro-inflammatory cytokines, and reduced expression of cell-surface molecules such as human leukocyte antigen DR (HLA-DR). This so-called sepsis-associated immunoparalysis may impair the elimination of pathogens, increase susceptibility to secondary infections and reactivate dormant viruses. Granulocyte concentrate (GC) transfusions, as the only available immune cell concentrates, potentially induce tissue damage via local effects of neutrophils. Therefore, using donor immune cells purely extracorporeally is an attractive option. A clinical trial is ongoing to investigate the effects of purified GC with extended shelf-life in a simplified extracorporeal plasma treatment, following prior successful trials utilizing standard GC in the treatment of 20 patients.

Methods: We describe data from a prospective, phase II, multicenter, randomized controlled parallel-group clinical trial in patients with septic shock. Subjects suffering from septic shock according to Sepsis-3-Definition who additionally require norepinephrine at a dose of ≥ 0.15 mcg/kg/min (and/or vasopressin at any dose) are randomized to receive either standard of care therapy or extracorporeal immune cell therapy on top of standard of care, in a 1:1 ratio. A total of 120 evaluable patients will be enrolled at multiple sites within Germany. Primary endpoint is safety and tolerability consisting of new onset of serious adverse events. A key secondary endpoint is the evaluation of the course of recovery from immune dysfunction in both groups. The comparison between the two groups will be evaluated at the interim analysis after 50 patients and at the final analysis. Additionally, the study also includes an evaluation of the normal course of immune paralysis in the control group, which will measure various cytokine levels and functional immune cell parameters of specific lymphocyte subsets, monocytes, and granulocytes on selected days.

Results: This study has been started in 2022. First results of the ongoing study will be presented focusing on the course of immune paralysis based on multiple cellular and humoral immune parameters.

Conclusions: The extracorporeal immune cell plasma perfusion therapy may on one hand provide immune support and may avoid unwanted local side effects on the other hand. Recovery from immune dysfunction is a prerequisite for avoiding secondary infections and ultimately also for recovery from sepsis.

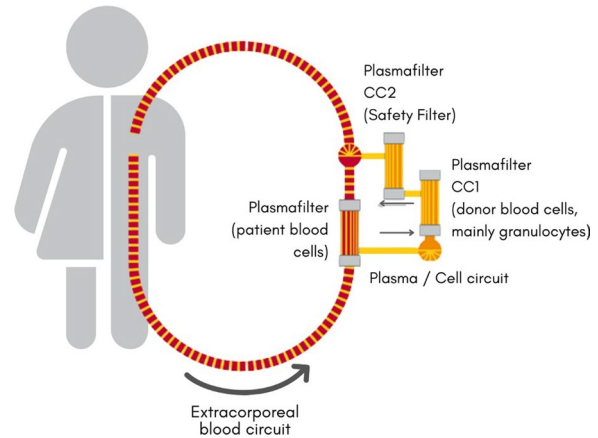

Scheme of the extracorporeal immune cell plasma perfusion therapy. Plasma is continuously filtered from the patient's extracorporeal blood circuit and transferred into a closed-loop 'cell circuit', where the patient's plasma is brought into direct contact with therapeutically effective, human-donor immune cells (i.e. granulocyte concentrate).

References

- Leentjens J, Kox M, van der Hoeven JG, Netea MG, Pickkers P. Immunotherapy for the adjunctive treatment of sepsis: from immunosuppression to immunostimulation. time for a paradigm change? *Am J Respir Crit Care Med*. (2013) 187:1287–93. <https://doi.org/10.1164/rccm.201301-0036CP>
- Peters van Ton AM, Kox M, Abdo WF, Pickkers P. Precision Immunotherapy for Sepsis. *Front Immunol*. 2018;9:1926. Published 2018 Sep 5. <https://doi.org/10.3389/fimmu.2018.01926>
- Leijte GP, Rimmelé T, Kox M, et al. Monocytic HLA-DR expression kinetics in septic shock patients with different pathogens, sites of infection and adverse outcomes. *Crit Care*. 2020;24 (1):110. Published 2020 Mar 20. <https://doi.org/10.1186/s13054-020-2830-x>

Topic: Sepsis

001182

Care Bundle Linked Best Practice Alert Improves Community Acquired Acute Kidney Injury Recognition in the Pediatric Emergency Department

E. O'neil¹, B. Patel², B. Choi², A. Cruz², K. Dolan¹, K. Vuong³, E. Ozcan¹, S. Thadani⁴, P. Lyons⁵, A. Akcan-Arikan⁴

¹Pediatric Critical Care, Baylor College of Medicine, Houston, United States of America; ²Pediatric Emergency Medicine, Baylor College of Medicine, Houston, United States of America; ³Pediatric Nephrology, Baylor College of Medicine, Houston, United States of America; ⁴Pediatric Critical Care and Nephrology, Baylor College of Medicine, Houston, United States of America; ⁵Critical Care Medicine, Oregon Health & Science University, Portland, United States of America

Correspondence: A. Akcan-Arikan

Intensive Care Medicine Experimental 2023, **11 (Suppl 1)**:001182

Introduction: Acute kidney injury (AKI) is associated with increased morbidity and mortality in pediatric patients and can be hard to detect in healthy children who do not have pre-illness serum creatinine measurements. Community-acquired AKI (CA-AKI) is not infrequent, less well-known, and poorly recognized. Best practice alerts (BPA) in electronic medical records (EMRs) can improve detection and management of AKI when linked to actionable care pathways.

Objectives: We created and implemented a BPA to improve our detection and management of CA-AKI to: increase CA-AKI diagnosis

to > 75% with a false positive rate of < 10%, to trigger nephrology consult for stage 3 AKI all patients, to reduce the length of stay (LOS) by 10%.

Methods: We created an active electronic BPA using age- and gender-based creatinine reference ranges that would fire and alert our emergency department nurses and physicians using the KDIGO creatinine definition. The alert notified the clinician of the stage of AKI and was coupled with a care bundle in the form of an order set stratified to the stage of AKI. This order set allowed the emergency department team to manage the AKI and investigate the etiology. Through a series of Plan-Do-Study-Act cycles, we evaluated and modified the BPA to maximize detection while minimizing alert fatigue.

Results: In the first year our EMR alert went live, we had over 12,000 alerts fired (firing multiple times until a clinician acts on the alert). There were 377 unique encounters with CA-AKI (55% stage 1, 19% stage 2, 26% stage 3) with multiple patients who sustained multiple kidney injuries with a 5.6% false positive rate. Our recognition and diagnosis of CA-AKI improved from 19% (pre-alert) to 76% (with BPA). Our LOS decreased by 22%. Nephrology consultation frequency did not change; however, this data is based on a consult order being placed in EMR and we cannot tell if emergency physicians simply called nephrology for advice but did not place an order.

Conclusions: An actionable EMR embedded BPA improved CA-AKI detection in the pediatric ED and decreased resource use. Future steps will include analysis of BPA associated reduction in nephrotoxic medication exposure and impact on mid and long-term follow-up of CA-AKI.

Topic: Acute Kidney Injury and haemofiltration

001184

Psychological responses of ICU experience: a meta-ethnography

E. Kusi-Appiah¹, M. Karanikola², U. Pant¹, M. Kennedy¹, E. Papathanassoglou¹

¹Faculty of nursing, University of Alberta, Edmonton, France; ²Nursing Department, Cyprus University of Technology, Limassol, Cyprus

Correspondence: E. Kusi-Appiah

Intensive Care Medicine Experimental 2023, **11 (Suppl 1)**:001184

Introduction: The literature identifies that critical illness and associated care in the intensive care unit (ICU) presents several psychological challenges for patients and families. However, this evidence has generated little discussion for practice and policy implications.

Objectives: We used a meta-ethnography synthesis to examine the psychological responses of patients receiving ICU care and draw their implications for practice.

Methods: Literature searches in CINAHL, MEDLINE, EMBASE, PsycINFO, Scopus, Dissertations and Theses Global databases was conducted using predefined eligibility criteria. We employed the CASP tool to assess the quality of included articles. Data synthesis was based on Noblit and Hare's approach, and reporting on the eMERGe framework.

Results: A corpus of twenty-one studies from thirteen countries were synthesized. Three main themes, *tormenting emotional experiences, disruptions in identity and social connections, and the disempowered warrior*, formed the fundamental experience of ICU patients. About 80% of patients in this review responded to ICU hospitalization with negative emotions, including depressive feelings, fear, anxiety, panic, agony, pessimism, emotional pain, perceived torment, acute existential distress, powerlessness, and dehumanization. Professional support, continued tailored education on what to expect, development of hope and optimism are perceived to reduce the emotional toll of ICU experience.

Conclusions: Negative emotions in care may cause poor psychological adjustment and delayed recovery. Patients are likely to acquiesce in care situations when control is vested in powerful others. Our study revealed the need for patient-centric insights into the ethical relationships between patient autonomy and medical paternalism in modern critical care medicine. Our research refocuses attention on the practicalities of empowering patients. It highlights challenges in negotiating

care elements and pathways in ways that foster patients' autonomy in care.

References

- McKinley, S., Nagy, S., Stein-Parbury, J., Bramwell, M., & Hudson, J. (2002). Vulnerability and security in seriously ill patients in intensive care. *Intensive and critical care nursing*, 18 (1), 27–36. Noblit, G. W., Hare, R. D., & Hare, R. D. (1988). *Meta-ethnography: Synthesizing qualitative studies* (Vol. 11). sage. France, E. F., Cunningham, M., Ring, N., Uny, I., Duncan, E. A., Jepson, R. G., Maxwell, M., Roberts, R. J., Turley, R. L., & Booth, A. (2019). Improving reporting of meta-ethnography: the eMERGe reporting guidance. *BMC medical research methodology*, 19 (1), 1–13

Topic: Nursing care and physiotherapy

001185

Safety of restrictive resuscitation after major burn trauma

R. Gigengack¹, A. Dijkstra², B. Cleffken³, S. Koopman⁴, C. Van Der Vlies⁵

¹Intensive Care and Anesthesiology, Amsterdam UMC, locatie VUmc, Amsterdam, Netherlands; ²Burn Center, Maastricht Hospital, Rotterdam, Netherlands; ³Department of intensive care, burn and trauma surgery, Maastricht Hospital, Rotterdam, Netherlands; ⁴Department of Anesthesiology, Maastricht Hospital, Rotterdam, Netherlands;

⁵Department of Burn and Trauma surgery, Maastricht Hospital, Rotterdam, Netherlands

Correspondence: R. Gigengack

Intensive Care Medicine Experimental 2023, **11 (Suppl 1)**:001185

Introduction: Burn trauma is accompanied by an immune response resulting in pathophysiological processes and induces a reduction in cardiac function, vasoplegia and endovascular leakage. This reaction has been known for several decades. Through the years the Parkland formula has been the mainstay in guiding fluid resuscitation. More recent literature shows possible fluid overload and the fluid creep. These findings resulted in more awareness for the risks of high-volume fluid resuscitation in patients after burn trauma. Because of these findings, the fluid resuscitation protocol in the Netherlands changed from the liberal 4 ml/kg/%TBSA to a restrictive 3 ml/kg/%TBSA. The aim of this study was to investigate whether restrictive resuscitation is non-inferior to liberal resuscitation.

Methods: This retrospective, before-and-after study, was performed in the Maastricht Hospital in the Netherlands and included adult patients admitted to the burn intensive care for resuscitation therapy according to the parkland formula ($\geq 15\%$ total body surface area (TBSA)). The study was reviewed by the institutional review board. The resuscitation protocol changed mid-2018, and all patients 2.5 years before and after this change were included. A database was constructed containing all baseline burn and patient characteristic, and included all parameters recorded during intensive care treatment. Primary outcome parameter was renal function measured in maximum change of creatinine in the first 7 days and was analyzed using a non-inferiority analysis based on the development of stage 1 KDIGO AKI. Other outcome parameters were tested using a logistic model and corrected for differences in gender, full-thickness burns, and SOFA-score.

Results: In total 44 patients were resuscitated according to restrictive protocol and 56 according to the liberal protocol. The patients were indeed resuscitated in accordance with the restrictive or liberal protocol at 24 h: 2.96 ± 1.63 ml/kg/%TBSA vs. 3.95 ± 1.91 ml/kg/%TBSA. No significant differences were present in the hemodynamic or respiratory parameters, or mortality (8.9% vs. 9.6%, respectively). Hospital length of stay was significantly shorter in the restrictive group: 24 (19–35) vs 38 (24–62) days. No inferiority was proven in the restrictive group comparing to the liberal group in maximum change in creatinine (8 ± 26 vs. 8 ± 31 , CI [-11, 8]).

Conclusions: This study shows that a more restrictive resuscitation strategy (3 ml/kg/%TBSA) in patients with large burn trauma is non-inferior compared to a liberal strategy (4 ml/kg/%TBSA) in the development of acute kidney injury after resuscitation. Furthermore, a restrictive strategy could decrease the hospital length of stay significantly and showed no differences in hemodynamic or respiratory

parameters. These findings indicate that a restrictive strategy is promising for future burn patients.

Topic: Trauma

001186

Effects of positive end-expiratory pressure delivered by helmet on ventilatory parameters: a crossover physiological study

L. Moretto¹, D. Raimondi Cominesi¹, B. Fumagalli¹, K. Ferrari², L. Fumagalli², F. Cipulli², M. Pozzi¹, G. Foti¹, E. Rezoagli¹, M. Giani¹

¹Scuola di Medicina e Chirurgia, Università degli Studi di Milano-Bicocca, Monza, Italy; ²Dipartimento di Emergenza e Urgenza, Fondazione IRCCS San Gerardo dei Tintori, Monza, Italy

Correspondence: L. Moretto

Intensive Care Medicine Experimental 2023, 11 (Suppl 1):001186

Introduction: Non-intubated patients with acute respiratory failure may have an excessive respiratory drive and breathe with large tidal volumes (Vt). This may lead to self-inflicted lung injury (P-SILI) [1,2]. Positive end-expiratory pressure (PEEP) is a key strategy to improve alveolar recruitment in invasive, non-invasive (NIV) and continuous positive airway pressure (C-PAP) ventilation [3,4]. Currently, ventilation monitoring during NIV is not usually available. ExSpirom[®]Xi (TVExSpirom) is a non-invasive monitoring device for continuous tidal ventilation in spontaneously breathing patients, based on bioelectrical impedance technology [5].

Objectives: To describe how ventilatory parameters (Vt, minute ventilation [VE], and respiratory rate [RR]) vary during spontaneous breathing, before and after administering PEEP with helmet C-PAP.

Methods: This is a single-centre cross-over physiological study performed in intensive care unit in patients with clinical indication to helmet CPAP. Exclusion criteria were age < 18 y/o, pregnancy, and contraindications to PEEP. We performed a zero end-expiratory pressure (ZEEP)-PEEP trial with a helmet C-PAP, consisting of three steps: 1) before helmet implementation (PRE-H) with an inspiratory oxygen fraction (FiO2) that was kept constant across all steps; 2) ten minutes after helmet implementation without PEEP (ZEEP), and 3) one hour after PEEP application. Ten minutes of tracings were analysed for each step. Ventilation monitoring was performed through the bioelectrical impedance-based monitor ExSpirom[®]Xi (TVExSpirom). At the end of each step, arterial blood gas analysis was recorded. Mean Vt, VE, RR and P/F ratio among all steps were compared through repeated-measures one-way ANOVA.

Results: We enrolled eight consecutive critically-ill patients, including one woman and seven men. Demographic and baseline characteristics are shown in Table 1. Seven out of ten patients started the trial with a Venturi mask, two with high-flow nasal cannula and one with nasal prongs. Table 2 shows the means and standard deviations of each ventilatory parameter during the trial; no statistical difference was observed in Vt (p = 0.24), VE (p = 0.16), and RR (p = 0.9) among the three steps. Figure 1a, b, and c show how Vt, VE, and RR vary during the ZEEP-PEEP trial, respectively. Although not significantly, VE rises at ZEEP step and decreases to baseline after PEEP setting. Vt trended to decrease with PEEP setting. PaO2/FiO2 increased significantly after each step (p < 0.01), while PaCO2 remained stable.

Age, years	60.5 (58–71)
BMI, Kg/cm2	26.7 (23–27.8)
Comorbidities	
Hypertension, n° (%)	6 (60)
Diabetes, n° (%)	3 (30)
Cardiopathy, n° (%)	3 (30)
Chronic kidney disease, n° (%)	3 (30)
Smoke, n° (%)	2 (20)

Age, years	60.5 (58–71)
COPD, n° (%)	1 (10)
Other, n° (%)	6 (60)
ICU admission diagnosis	
ARDS/AHRF, n° (%)	5 (50)
Septic shock, n° (%)	2 (20)
Trauma, n° (%)	1 (10)
Baseline	
SOFA score on study day	3 (2–6)
FiO2	0.5 (0.4–0.5)
PEEP (PEEP step)	8 (8–8)

Conclusions: Helmet C-PAP with PEEP maintained a similar VE and RR as compared to no helmet or helmet at ZEEP. However, despite the lack of statistical significance and the limited sample size due to the preliminary data analysis, PEEP trended to a lower Vt as compared to pre-H and ZEEP.

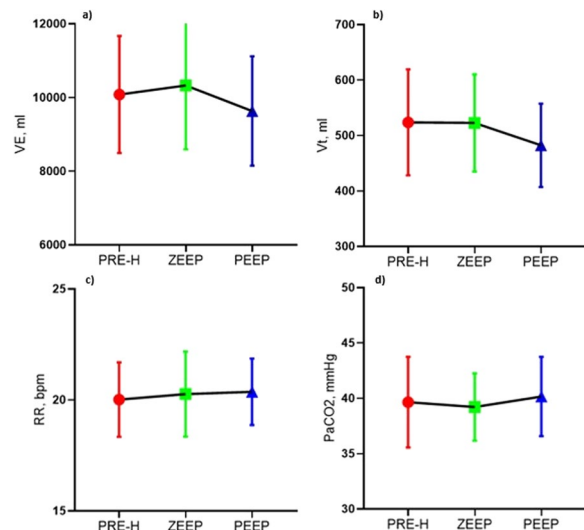

Figure 1. a), b), c) and d) respectively show VE, Vt, RR and PaCO₂ trends across the ZEEP-PEEP three-step trial; standard errors are presented. VE: minute ventilation; Vt: tidal volume; RR: respiratory rate; PRE-H: trial first step; ZEEP: zero end-expiratory pressure; PEEP: positive end-expiratory pressure.

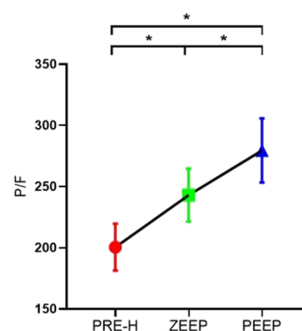

Figure 2. PaO₂/FiO₂ trends across the ZEEP-PEEP three-step trial; standard errors are presented, asterisks indicate significance. P/F: PaO₂/FiO₂; PRE-H: trial first step; ZEEP: zero end-expiratory pressure; PEEP: positive end-expiratory pressure.

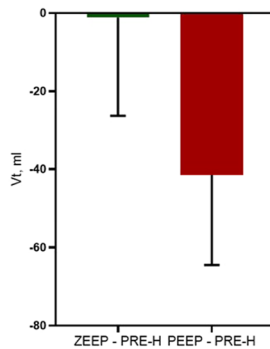

Figure 3. Mean difference in Vt between ZEEP and PRE-H steps, compared to mean difference in Vt between PEEP and PRE-H. Standard errors are presented. Vt: tidal volume; PRE-H: trial first step; ZEEP: zero end-expiratory pressure; PEEP: positive end-expiratory pressure.

References

- Bellani, G. et al. Driving Pressure Is Associated with Outcome during Assisted Ventilation in Acute Respiratory Distress Syndrome. *Anesthesiology* 131, 594–604 (2019).
- Brochard, L., Slutsky, A. & Pesenti, A. Mechanical Ventilation to Minimize Progression of Lung Injury in Acute Respiratory Failure. *Am J Respir Crit Care Med* 195, 438–442 (2017).
- Yoshida, T., Fujino, Y., Amato, M. B. P. & Kavanagh, B. P. FIFTY YEARS OF RESEARCH IN ARDS. Spontaneous Breathing during Mechanical Ventilation. Risks, Mechanisms, and Management. *Am J Respir Crit Care Med* 195, 985–992 (2017).
- Yoshida, T., Grieco, D. L., Brochard, L. & Fujino, Y. Patient self-inflicted lung injury and positive end-expiratory pressure for safe spontaneous breathing: Current Opinion in Critical Care 26, 59–65 (2020).
- Sosio, S. et al. A Calibration Technique for the Estimation of Lung Volumes in Nonintubated Subjects by Electrical Impedance Tomography. *Respiration* 98, 189–197 (2019).

Topic: Acute respiratory failure and mechanical ventilation

001187

Predictors of adverse outcome in COVID-19 patients with acute kidney injury (AKI)

A. Soyibo¹, K. Hoe¹, K. Ekhikmetalor², A. Fevrier³
¹Medicine, University of the West Indies, Kingston, Jamaica; ²Surgery, University of the West Indies, Kingston, Jamaica; ³Research, SY-ARK Research Institute, Kingston, Jamaica

Correspondence: A. Soyibo

Intensive Care Medicine Experimental 2023, **11** (Suppl 1):001187

Introduction: The predictors negative outcome of AKI among Afro-Caribbean patients with COVID-19 disease is unknown. Majority of COVID-19 patients in Jamaica were admitted to University Hospital of the West Indies (UHWI).

Objectives: to evaluate negative predictors of outcome in Afro-Caribbean patients with COVID-19 infection and Acute Kidney Injury.

Methods: A retrospectively conducted study reviewing 138 AKI patients with confirmed COVID-19 infection in at a single institution between March 10, 2020–March 10, 2021. Parameters including, presenting symptoms, laboratory values, requirement for aggressive management associated and need for renal replacement therapy were

evaluated. The likelihood of a fatal event was evaluated by univariate and multivariate analysis among the study participants.

Results: Forty-nine percent of patients attained a peak AKI Stage 1, 17% with AKI Stage 2 and 34% AKI Stage 3. The mean age was (62 ± 14) years with 59% being male. The presenting symptoms of dyspnoea and fever were the most likely to be associated with adverse outcomes. Mean serum creatinine difference between baseline and peak creatinine levels achieved were a greater indicator of AKI severity than the baseline serum creatinine levels. Patients who peaked at AKI stage 3 were more likely ($p < 0.05$) to be oliguric/anuric ($r^2 = 0.264$), receive remdesivir ($r^2 = 0.303$) and require dialysis ($r^2 = 0.201$). Increased mortality was associated with increased number of symptoms at presentation ($r^2 = 0.338$) and oliguria/anuria ($r^2 = 0.580$). Low serum albumin levels (aOR: 0.734; 95%CI: 0.654–0.825) and oliguria (aOR: 8.631; 95% CI: 2.835–26.278) were the most significant predictors of mortality.

Conclusions: Low serum albumin levels and increased number of symptoms at presentation are key predictors of adverse outcomes in AKI patients with COVID-19 infection.

References

1. Chawla LS, Bellomo R, Bihorac A, Goldstein SL, Siew ED, Bagshaw SM, et al. Acute kidney disease and renal recovery: consensus report of the Acute Disease Quality Initiative (ADQI) 16 Workgroup. *Nature Reviews Nephrology*. 2017;13 (4):241–57 2. Huang C, Wang Y, Li X, et al. Clinical features of patients infected with 2019 novel coronavirus in Wuhan, China. *Lancet* 2020;395:497–506 3. Goyal P, Choi JJ, Pinheiro LC, et al. Clinical characteristics of Covid-19 in New York City. *N Engl J Med*. <https://doi.org/10.1056/NEJMc2010419> 4. Wang F, Ran L, Qian C, et al. Epidemiology and Outcomes of Acute Kidney Injury in COVID-19 Patients with Acute Respiratory Distress Syndrome: A Multicenter Retrospective Study [published online ahead of print, 2020 Dec 8]. *Blood Purif*. 2020;1–7. <https://doi.org/10.1159/000512371>
2. No grant application was done for this project

Topic: Acute Kidney Injury and haemofiltration

001188

Feasibility and safety of percutaneous closure system (MANTA TM) for the arterial access in V-A ECMO: retrospective case series and comparison with traditional technique

M. Laiolo¹, M. Pozzi², G. Redaelli³, G. Deleo³, E. Maggioni¹, C. Benatti³, M. Normanno¹, V. Segramora³, L. Avalli², G. Foti²

¹Department of Emergency and Intensive Care, Fondazione IRCCS San Gerardo dei Tintori, Monza, Italy; ²Department of Emergency and Intensive Care, Fondazione IRCCS San Gerardo dei Tintori, University of Milano Bicocca, Monza, Italy; ³Department of Vascular Surgery, Fondazione IRCCS San Gerardo dei Tintori, Monza, Italy

Correspondence: M. Laiolo

Intensive Care Medicine Experimental 2023, **11** (Suppl 1):001188

Introduction: Compression method has traditionally been applied for the removal of the arterial cannula required for VA ECMO support. Numerous vascular and hemorrhagic complications associated with this procedure have been reported over the years.

Recently, endovascular devices for the closure of large-caliber arterial vascular accesses became available. MANTA is a femoral artery closure device for large-caliber accesses, structured with a resorbable collagen pad, a radio-opaque stainless steel locking component. Initially used for smaller calibers than ECMO cannulas with satisfactory results in terms of reduction in complications and rapid learning curve, it has been recently applied in management of ECMO arterial access.

Objectives: To investigate feasibility and safety of MANTA for managing arterial access site in VA ECMO, in terms of bleeding and vascular

complication compared with an historical cohort of patients managed with traditional methods.

Methods: In this observational study we collected data of all consecutive patients who underwent deconnection from VA ECMO, between 01/2018 and 09/2022. Starting from 04/2021 MANTA was implemented in collaboration with Vascular Surgery Department.

Inclusion Criteria were age > 18 years and femoro-femoral VA ECMO support. Collected data included demographic and clinical characteristic, vascular complications, bleeding complications, coagulation status in 4 different time-points.

Results: 52 patients met the inclusion criteria (9 management with MANTA e 42 with compressive technique). One patient underwent surgical removal. Patients managed with MANTA were more frequently anticoagulated ($p=0.01$) and had higher Charlson Comorbidity Index ($p=0.029$). In both groups, the main indication for ECMO was represented by Cardiac Arrest (MANTA 44.4% vs compressive 56.1%).

In both groups it was possible to resume anticoagulation a few hours after the procedure, without significant differences between the two groups ($p=0.113$) and dosages ($p=0.070$). There was no difference for transfusion requirements ($p=0.854$).

Among the patients treated with compression we observed early (1 thrombosis, 2 hematomas) and late (1 aneurysm, 2 dissections) vascular complications. In patients with MANTA, we observed early vascular complication (one arteriovenous fistula and one acute limb ischemia which required urgent surgery). Acute complications observed in MANTA group were associated with inadvertent cannulation of superficial femoral artery.

Conclusions: Comparing the two techniques, there were no significant differences in terms of bleeding complications or transfusion; the frequency relative of early vascular complications was higher in the MANTA group. In emergency setting, inadvertent cannulation of superficial femoral artery could worsen clinical outcome.

References

- Jia D, Yang IX, Ling RR, et al. Vascular complications of extracorporeal membrane oxygenation: a systematic re- view and meta-regression analysis. *Crit Care Med* 2020; 48: e1269–e1277
- Wood DA, Krajcer Z, Sathananthan J, Strickman N, Metzger C, Fearon W, et al. Pivotal clinical study to evaluate the safety and effectiveness of the MANTA percutaneous vascular closure device. *Circ Cardiovasc Interv* 2019;12:e007258
- MANTA™ Vascular Closure Device INSTRUCTIONS FOR USE, PSD-124 REV. H 2019/01, TELEFLEX
- ECMO-Extracorporeal Life Support in Adults, Fabio Sangalli, Nicolò Patroniti, Antonio Pesenti Editors, Springer

Topic: Cardiovascular issues in ICU

001189

Revolutionizing ICU Prognosis: Developing a Site-Specific Predictive Score for Enhanced Prediction of Outcomes in all Age Ranges Including the Very Elderly Patient

R. Fumis¹, B. Tomazini², N. Matos¹, E. Colonnezi¹, L. C. P. D. Azevedo³, L. Pastore Junior⁴, E. L. V. Costa⁵

¹Intensive Care Unit, Hospital Sirio Libanes, São Paulo, Brazil; ²Critical Care, Hospital Sirio Libanes, São Paulo, Brazil; ³Academic Research Organization, Albert Einstein Israelite Hospital, São Paulo, Brazil; ⁴Icu, Hospital Sirio Libanes, São Paulo, Brazil; ⁵Research and education institute, Hospital Sirio Libanes, São Paulo, Brazil

Correspondence: R. Fumis

Intensive Care Medicine Experimental 2023, **11** (Suppl 1):001189

Introduction: Octogenarians are often perceived as unsuitable candidates for ICU admission based on the expectation of reduced survival rates. On average, these patients indeed experience higher ICU mortality rates and longer post-ICU hospital stays compared to younger patients. However, many can resume daily activities at similar levels as younger patients one year after ICU discharge. Factors such as prior functional status, admission diagnosis, and comorbidities likely impact

mortality and post-discharge functional status more than age. Traditional scores, like SAPS3 (1), can overestimate hospital mortality rates for this age group. Institutional factors and regional differences in local practices also affect the accuracy of current prognostic models.

Objectives: Our study aimed to develop and validate an institution-specific score incorporating baseline functional status, and site-specific data to improve prognostic accuracy for all age ranges, including very elderly patients.

Methods: This was a retrospective cohort study from a 30-bed ICU in Hospital Sirio-Libanês, São Paulo, Brazil. Data were retrieved from patients consecutively admitted to the ICU from January 2014 to April 2019. Patients were categorized as: less than 60 years old, 60–79 years old, and ≥ 80 years old (very elderly). The sample was divided in two halves, the first to develop and the other to validate a prognostic score (Fumis score). Mortality predictors included all SAPS3 variables, SOFA, baseline functional status, and Charlson Comorbidity Index. All variables were assessed using a multivariable logistic regression model, which was used to develop and validate the prognostic score of in-hospital mortality.

Results: A total of 9,631 patients were admitted to the ICU during the study period with 28.3% belonging to the very elderly group. Very elderly patients had higher ICU (7.0%) and in-hospital mortality (12.9%) than the other age groups ($p<0.001$). The SAPS3 underestimated mortality in all age groups, but specially in the very elderly (Figure 1), in whom the standardized mortality ratio was 0.56 (95% CI 0.47, 0.67). Conversely, the Fumis score had good discrimination in the derivation and validation sets and was well calibrated for all age categories (Figure 1) with an SMR of 0.90 (95% CI 0.79, 1.04) in the very elderly.

Conclusions: This study successfully developed and validated the Fumis score, an institution-specific prognostic tool that used site-specific data for improved accuracy in predicting in-hospital mortality among all age groups, including very elderly patients. By utilizing site-specific data, this innovative approach overcomes the limitations of traditional scoring systems, such as SAPS3, which rely on multicenter data and often fail to account for the unique characteristics of individual hospitals. This idea of a site-specific prognostic tool paves the way for more accurate ICU admission decision-making.

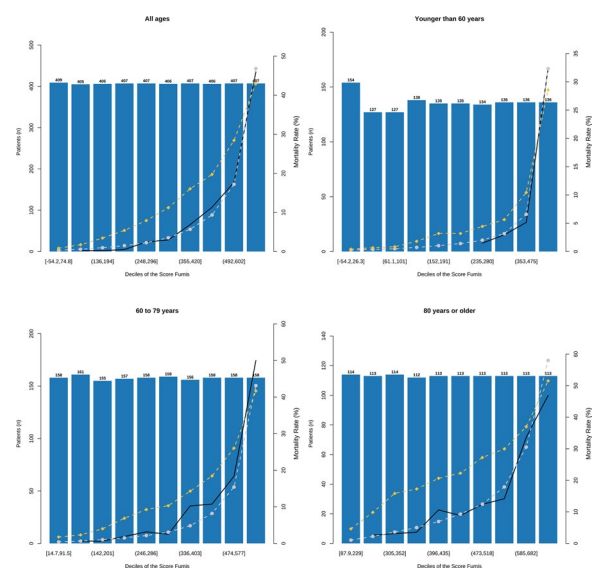

Figure 1 (abstract 001189) Predicted risk of hospital death, observed hospital mortality rate, and the number of patients per decile in the Validation Cohort. Columns: Number of patients; Yellow diamonds: mean SAPS 3-predicted mortality per decile; Gray circles: mean Fumis score-predicted mortality per decile; and solid black line: mean observed mortality per decile

References

- 1—Moreno RP, Metnitz PG, Almeida E, Jordan B, Bauer P, Campos RA, et al. SAPS 3—From evaluation of the patient to evaluation of the intensive care unit. Part 2: Development of a prognostic model for hospital mortality at ICU admission. *Intensive Care Med.* 2005;31 (10):1345–55.

Topic: Critical care organisation, quality management, information systems, outcomes

001190

Effect of PTX3 on thromboelastometric analysis in sepsis-induced coagulopathy

M. Tagliaferro¹, F. Scavellò², R. Parente², M. Cecconi³, A. Protti¹, A. Mantovani², C. Garlanda², G. Iapichino¹, A. Doni²

¹Department of Anesthesia and Intensive Care Unit, IRCCS Humanitas Research Hospital, Rozzano, Italy; ²Department of Biomedical Sciences, Humanitas University, Pieve Emanuele, Italy; ³Department of Anesthesia and Intensive Care Unit, IRCCS Humanitas Research Hospital, Milan, Italy

Correspondence: G. Iapichino

Intensive Care Medicine Experimental 2023, **11** (Suppl 1):001190

Introduction: Innate immunity is evolutionarily and functionally connected to haemostasis [1, 2]. PTX3 is a fluid-phase molecule of the innate immunity essential in resistance against bacterial and viral infections [3]. By interacting with defense fibrinogens, PTX3 amplifies effector functions of the innate immune system [4]. At wound sites and thrombus, PTX3 regulates the injury-induced thrombotic response. It promotes wound healing by favouring timely fibrinolysis by interacting with fibrin and plasminogen (Plg) through its N-terminal domain. PTX3-mediated enhancement of fibrinolysis involves interaction with Plg in acidic microenvironments and independence of increased plasmin formation. [5]. Human septic coagulopathy is characterized by an increase in naturally occurring anti-fibrinolytics, favouring the apposition of thrombi in the microvasculature and ultimately resulting in multiorgan failure [6].

Objectives: We aimed to study the potential effect of PTX3 and its N-domain in the blood of healthy donors and critically ill patients affected with *Staphylococcus aureus* (SA) bacteremia.

Methods: Citrated whole blood collected from healthy donors and critically ill patients (within 48 h of confirmed SA infection) was incubated (15 min) with purified recombinant PTX3 (222 nM), N-terminal domain (222 nM) or phosphate-buffered saline (PBS) and underwent viscoelastic analysis with the ROTEM using EXTEM assay. Six healthy donors and four patients (mean SOFA score 4 ± 2) were enrolled.

Results: Main ROTEM parameters are shown in Table 1. Viscoelastic tests of SA patients showed longer initiation of clotting compared to healthy donors, but clot firmness was significantly increased (73 ± 5 vs 57 ± 3 mm, $P < 0.01$) and lysis at 45 min reduced (3 ± 1 vs $5 \pm 4\%$, $p = 0.35$) suggesting a hypercoagulable state with fibrinolytic shutdown. The addition of PTX3 or N-domain to normal blood did not exert any viscoelastic effect compared to blood treated with PBS. In SA patients, the addition of the N-domain decreased clot firmness compared to the control group (62 ± 9 vs 73 ± 5 mm, $P < 0.05$) and increased lysis at 45 min (19 ± 19 vs $3 \pm 1\%$; $P = 0.15$) whereas a tendency towards increased fibrinolysis is observed using PTX3 (5 ± 5 vs $3 \pm 1\%$, $p = 0.26$) (Figure 1).

Conclusions: Initial results indicate a potential pro-fibrinolytic effect of PTX3 and its N-terminal domain in the blood of patients with SA infection. The main causes associated with coagulopathy include inhibition of fibrinolysis due to the production of classical Plg activator inhibitors and acidosis.

Table 1 (abstract 001190) Mean \pm standard deviation of the main ROTEM parameters of the study groups

	Healthy Donors (n=6)			SA Patients (n=4)		
	Control	PTX3	N	Control	PTX3	N
Clotting Time (CT) [sec]	86 \pm 6	82 \pm 9	81 \pm 9	106 \pm 29	107 \pm 24	108 \pm 34
Amplitude at 5 minutes (A5) [mm]	39 \pm 3	39 \pm 2	38 \pm 4	58 \pm 8	60 \pm 6	53 \pm 9
Maximum Clot Firmness (MCF) [mm]	57 \pm 3	56 \pm 2	57 \pm 3	73 \pm 5	72 \pm 4	62 \pm 9
% reduction of clot firmness at 45 min (ML45)	5 \pm 4	6 \pm 1	5 \pm 3	3 \pm 1	5 \pm 5	19 \pm 19

% reduction of clot firmness at 45 minutes (ML45)

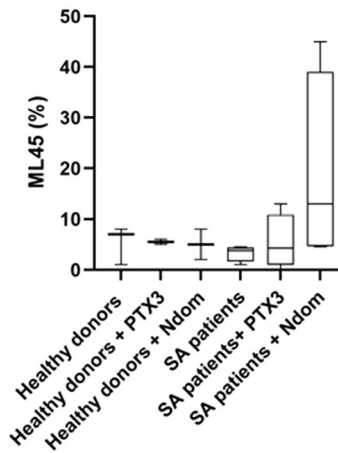

Figure 1 (abstract 001190) Percent reduction of clot firmness at 45 min (ML45) of the study groups

References

- [1] Engelmann B, Massberg S. Thrombosis as an intravascular effector of innate immunity. *Nat Rev Immunol.* 2013;13:34–45. [2] Levi M, et al. Bidirectional relation between inflammation and coagulation. *Circulation.* 2004;109:2698–2704. [3] Bottazzi B, et al. An integrated view of humoral innate immunity: pentraxins as a paradigm. *Annu Rev Immunol.* 2010;28:157–183. [4] Doni A, et al. Innate immunity, hemostasis and matrix remodeling: PTX3 as a link. *Semin Immunol.* 2016;28 (6):570–577. [5] Doni A, et al. An acidic microenvironment sets the humoral pattern recognition molecule PTX3 in a tissue repair mode. *J. Exp. Med.* 212 (6):905–925. [6] Semeraro F, et al. Platelet Drop and Fibrinolytic Shutdown in Patients With Sepsis. *Crit. Care Med.* 46 (3):e221–e228.
- This research was supported by EU funding within the NextGenerationEU-MUR PNRR Extended Partnership initiative on Emerging Infectious Diseases (Project no. PE00000007, INF-ACT)

Topic: Sepsis

001191

A prospective pharmacokinetic study of olanzapine and quetiapine dosing in critically ill patients with delirium

M. Ankravs¹, P. Mitre², H. Won², J. Roberts³, S. Wallis², L. Sharrock¹, N. Walpolo¹, K. Byrne¹, B. Miles¹, A. Udy⁴, R. Bellomo⁵, A. Deane

¹Intensive Care Unit, Royal Melbourne Hospital, Melbourne, Australia; ²UQ Centre for Clinical Research, The University of Queensland, Brisbane, Australia; ³The university of queensland centre for clinical research, department of intensive care medicine, The University of Queensland, Brisbane, Australia; ⁴Intensive Care Unit, The Alfred, Melbourne, Australia; ⁵Intensive care unit, Austin Hospital, Heidelberg, Australia

Correspondence: M. Ankravs*Intensive Care Medicine Experimental* 2023, **11** (Suppl 1):001191

Introduction: There is a lack of consensus as to drug and dose that should be administered to critically ill patients for the pharmacological treatment of acute delirium. Critically ill patients frequently have altered volume of distribution and impaired metabolism and clearance of many drugs. Unlike other drug classes, such as antimicrobials (1), there are no data for antipsychotic drugs in this patient population. Pharmacokinetic data will inform therapeutic strategies and the pharmacokinetic models generated will allow the investigators to propose optimized dosing regimens.

Objectives: To measure plasma concentration of olanzapine and quetiapine and their metabolites, and to describe population pharmacokinetic parameters of these drugs in critically ill patients.

Methods: This was a single centre prospective observational study. Patients who were ≥ 18 years of age and receiving immediate release enteral olanzapine or quetiapine for acute delirium were eligible. Blood samples were taken at regular time points for peak and trough concentrations for up to 4 days. The assay was designed, and batch analysis were conducted, to measure total and unbound olanzapine and quetiapine, as well as concentrations of the major metabolites, desmethylolanzapine and norquetiapine. Dose, frequency of administration, anthropometric measures, organ dysfunction, smoking history and concurrent medications were accounted for in the analysis.

Results: Thirty patients (sex: 25 [83%] male; age: mean (SD) 51 (15) years; and weight: 93 (19) kg) provided 109 samples. Nineteen patients were receiving quetiapine and 11 patients were receiving olanzapine. Based on the first sample obtained for each patient, there was wide variability for: total olanzapine (min. 2.68 ng/mL; max. 32.16 ng/mL) and associated unbound olanzapine (below limit of quantitation; 1.29 ng/mL respectively); and for total desmethylolanzapine (min. 0.00 ng/mL; max. 0.69 ng/mL). This variability was also observed for: total quetiapine (min. 72.87 ng/mL; max. 693.24 ng/mL) and associated unbound quetiapine (3.96 ng/mL; 34.58 ng/mL respectively); and for total norquetiapine (min. 0.98 ng/mL; max. 54.21 ng/mL). Detailed population pharmacokinetic modelling will be presented.

Conclusions: There is marked variability in plasma concentrations of olanzapine and quetiapine, both total and unbound, and their metabolite, when administered for acute delirium. Given the lack of existing data, population pharmacokinetic modelling will inform suitable dosing regimens.

References

1. Society of Hospital Pharmacists of Australia National Translational Research Collaborative (Juno Pharmaceuticals Emerging Researcher Grant).
2. 1. Roberts J, Lipman J. Pharmacokinetic issues for antibiotics in the critically ill patient. *Crit Care Med* 2009; 37 (3): 840–851

Topic: Sedation, analgesia and delirium

001193

High protein provision of more than 1.2 g/kg improves muscle mass preservation and mortality in ICU patients: A systematic review and meta-analyses

I. van Ruijven¹, J. Abma², A. Brunsveld-Reinders², S. Stapel¹, F. Van Etten-Jamaludin³, Y. Boirie⁴, R. Barazzoni⁵, P. Weijs¹

¹Adult Intensive Care Medicine, Amsterdam UMC, locatie VUmc, Amsterdam, Netherlands; ²Epidemiology and Data Science, Amsterdam UMC, locatie AMC, Amsterdam, Netherlands; ³Medical Library AMC, Amsterdam UMC, locatie AMC, Amsterdam, Netherlands; ⁴Clinical Nutrition Department, University of Clermont Auvergne, Clermont-Ferrand, France; ⁵Department of Medical, Surgical and Health Sciences, University of Trieste, Trieste, Italy

Correspondence: I. van Ruijven*Intensive Care Medicine Experimental* 2023, **11** (Suppl 1):001193

Introduction: ICU patients lose muscle mass rapidly and maintenance of muscle mass may contribute to improved survival rates and quality of life. Protein provision may be beneficial for preservation of muscle mass and other clinical outcomes, including survival. Current protein recommendations are expert-based and range from 1.2 to 2.0 g/kg. Thus, we performed a systematic review and meta-analysis on protein provision and all clinically relevant outcomes recorded in the available literature.

Methods: We conducted a systematic review and meta-analyses, including studies of all designs except case control and case studies, with patients aged ≥ 18 years with an ICU stay of ≥ 2 days and a mean protein provision group of ≥ 1.2 g/kg as compared to < 1.2 g/kg with a difference of ≥ 0.2 g/kg between protein provision groups. All clinically relevant outcomes were studied. Meta-analyses were performed for all clinically relevant outcomes that were recorded in ≥ 3 included studies.

Results: A total of 30 studies published between 1983–2022 were included. Outcomes reported in the included studies were ICU, hospital, 28-day, 30-day, 42-day, 60-day, 90-day and 6-month mortality, ICU and hospital length of stay, duration of mechanical ventilation, vomiting, diarrhea, gastric residual volume, pneumonia, overall infections, nitrogen balance, changes in muscle mass, destination at hospital discharge, physical performance and psychological status. Meta-analyses showed differences between groups in favour of high protein provision for 60-day mortality (Figure 1), nitrogen balance (Fig. 2) and changes in muscle mass (Fig. 3).

Conclusions: High protein provision of more than 1.2 g/kg in critically ill patients seemed to improve nitrogen balance and changes in muscle mass on the short-term and 60-day mortality. Data on long-term effects on quality of life are urgently needed.

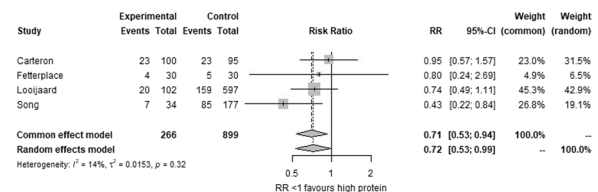
**Figure 1 (abstract 001193)** Forest plot for 60-day mortality

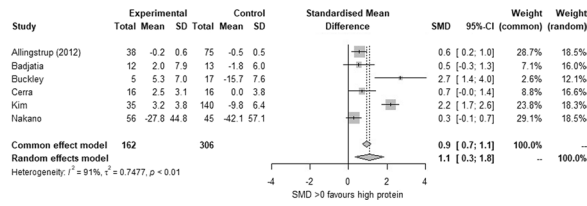

Figure 2 (abstract 001193) Forest plot for nitrogen balance

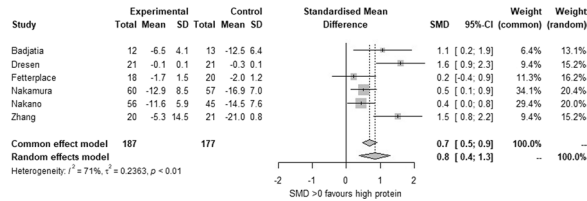

Figure 3 (abstract 001193) Forest plot for changes in muscle mass

References

1. This work was supported by Baxter Healthcare, Fresenius Kabi, Nestle, Nutricia Nederland. Funding source provided educational grant and had no role in design, conduct, report and presentation of the results of the study.

Topic: Metabolism, endocrinology, liver failure and nutrition

001194

Health related quality of life determinants in critical COVID-19 patients 6 months after ICU stay

V. Vicka¹, J. Krauklyte², E. Januskeviciute², A. Aleknaviciene¹, U. Fesenko¹, D. Ringaitiene¹, J. Sipylaitė¹, L. Jancoriene³

¹Clinic of Anaesthesiology and Intensive Care, Institute of Clinical Medicine, Faculty of Medicine, Vilnius University, Vilnius, Lithuania; ²Faculty of medicine, Vilnius University, Vilnius, Lithuania; ³Institute of clinical medicine, Faculty of Medicine of Vilnius University, Vilnius, Lithuania

Correspondence: V. Vicka

Intensive Care Medicine Experimental 2023, 11 (Suppl 1):001194

Introduction: COVID-19 pandemic overwhelmed critical care health services across the world, making an effect on selection of the patients, limitations of treatment and controversial choices of therapy. Now, in the aftermath of the pandemic the effect on health related quality of life (HR-QoL) can be evaluated.

Objectives: The aim of this study is to evaluate the HR-QoL in critical care survivors of severe COVID-19 pneumonia and to determine the risk factors that may be associated with it.

Methods: This was a retrospective analysis of patients treated for COVID-19 in ICU in the period from 2021 June to 2022 January in Vilnius, Lithuania. The study was conducted in a tertiary reference hospital. The patients who survived the stay in the ICU and agreed to participate in the follow up program were included in the study. Demographic, co-morbidity and general ICU course indicators were collected. The HR-QoL was measurement with 36-Item Short-Form Health Survey (SF-36). Mental and physical components were evaluated separately, regression analysis was conducted to determine the risk factors of worse HR-QoL.

Results: The data of 53 patients was collected. These patients were typical ICU patients for the 3rd wave of the COVID-19 pandemic in Lithuania. The cohort favors the moderate risk definition according to APACHE II (median=7 [5–10]) and ISARIC 4C scores (median=7 [5–10.5]), a shift expected as only ICU survivors were included in the

study. Mean follow up time of the patients was 7.64 ± 1.61 months. The mean physical health composite was 60.89 ± 25.33, and the mean mental health composite was 64.97 ± 22.78. For the physical health composite in the univariate regression model higher age (B = (-)0.575 CI95%: (-)1.14– (-)0.01 p=0.048), presence of diabetes (B = (-)18.78 CI95%: (-)36.80– (-)0.74 p=0.042) and higher ISARIC 4C mortality risk (B = (-)2.665 CI95%: (-)4.18– (-)0.59 p=0.006) were shown to have an effect on worse scores. In the final regression model only ISARIC 4C mortality risk remained as sole independent predictor (B = (-)2.655 CI95%: (-)4.72– (-)0.59 p=0.013). The univariate regression of SF-36 mental health composite determinants did not reveal any statistically significant predictors.

Conclusions: The patients after severe COVID-19 pneumonia and stay in critical care are affected and present with lowered HR-QoL after 6 months, mostly in the physical composite score. The main risk factors for worse physical condition are co-morbidities and age, a similar pattern observed in other respiratory infections.

Topic: Critical care organisation, quality management, information systems, outcomes

001196

Validation of 2021 ERC/ESICM guidelines in TTM2-trial data: a retrospective analysis of the prognostic accuracy in neurological prognostication after cardiac arrest

A. Lagebrant¹, Ttm2 Trial Investigators²

¹Department of Clinical Sciences, Lund, Lund University, Lund, Sweden;

²Department of Clinical Sciences, Lund University, Lund, Sweden

Correspondence: A. Lagebrant

Intensive Care Medicine Experimental 2023, 11 (Suppl 1):001196

Introduction: About two thirds of in-hospital deaths following successful resuscitation after cardiac arrest are due to hypoxic-ischaemic brain injury. (1,2) Most occur after a decision to withdraw from life sustaining therapy (WLST) in patients where meaningful neurological recovery is unlikely. (2) In 2021 the European Resuscitation Council (ERC) and the European Society of Intensive Care Medicine (ESICM) published a simplified guideline algorithm for prediction of neurological outcome after cardiac arrest, broadening the screening criteria to also include flexion posture. (3) External validations on its prognostic accuracy have previously reported 53–60% sensitivity with 100% specificity. (4,5).

Objectives: This study aims to validate the ERC/ESICM 2021 guidelines on neurological prognostication after cardiac arrest in a large international multicenter population. (3).

Methods: Retrospective descriptive analysis of the Targeted Hypothermia versus Targeted Normothermia after Out-of-Hospital Cardiac Arrest (TTM2) trial data. Patients with available motor score on day 4 and neurological outcome at 6 months were included. (6) The prognostic accuracy of ERC/ESICM 2021 algorithm, including clinical examinations (pupillary and corneal reflexes ≥ 72 h (h), early status myoclonus ≤ 72 h), neurophysiological tests (EEG > 24 h, SSEP ≥ 24 h), neuroimaging (CT ≤ 72 h, MRI 2–7 days) and biomarkers (serum neuron-specific enolase (NSE) at 48 and/or 72 h), was assessed.

Results: A total of 1324 patients met the inclusion criteria, of which 753 (57%) were eligible for neurological prognostication according to the screening criteria (Tab.1, Figure 1). Preliminary results indicate that the ERC/ESICM algorithm correctly identified 258 patients with poor neurological outcome and 213 of the total 491 patients not fulfilling the guideline criteria had a good outcome. The overall sensitivity for the algorithm was 48% (95% CI: 44–52%). Four cases of false positive predictions were identified, yielding a specificity of 98% (95% CI: 95–99%). Further results will be presented at the conference.

Conclusions: This validation study is the first to report a non-perfect specificity for the ERC/ESICM 2021 guidelines on neurological prognostication after cardiac arrest. The individual reports of false positive predictions and the potential interference with sedation must be further evaluated to assure validity in prognostication and avoid patients unrightfully being put at risk of WLST in clinical practice. Increasing the number of patients correctly identified with poor

neurological outcome while assuring a 100% specificity remains the goal for further development of guidelines. Limitations in this study include bias due to allowance of WLST during trial, possible residual effects of sedation and that the analysis was performed on reported examination results.

Table 1 (abstract 001196) Descriptive Table on included and excluded patients. Patients with missing neurological outcome, missing FOUR motor score at 72–96 h and who were deceased prior to 72 h were all excluded. Continuous variables are presented as median (inter quartile range) and categorical variables are described as count of numbers (percentages of all available data)

Table 1. Demographics of study population		
Baseline data	Included, N=1324	Excluded, N=537
Age (years)	65 (54-73)	67 (59-76)
Male	1070 (80.8)	407 (75.8)
Witnessed	1216 (91.8)	486 (90.5)
Bystander CPR	1089 (82.3)	398 (74.1)
Minutes to ROSC	25 (16-36)	30 (19-49)
Initial shockable rhythm on ECG	1036 (78.2)	335 (62.4)
TTM 33°C	664 (50.2)	266 (49.5)
Neurological outcome at six months		
Poor outcome (mRS 0-3)	607 (45.8)	381 (75.4)
Missing data		32

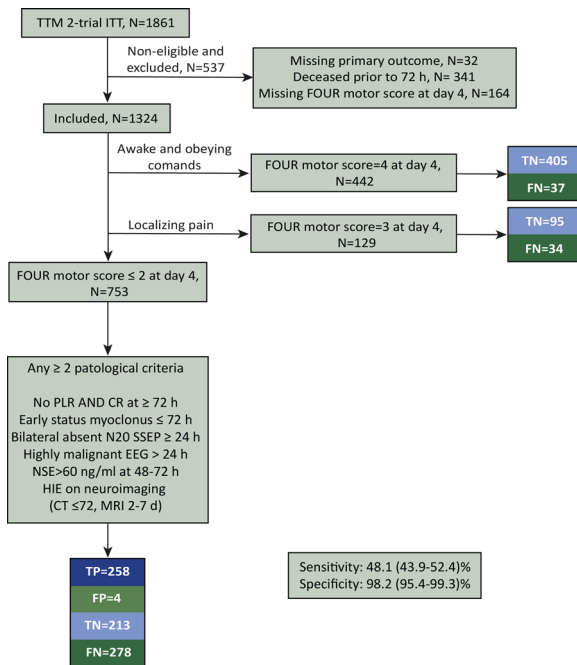

Figure 1 (abstract 001196) Flowchart of inclusion for validation of ERC/ESICM 2021 guideline algorithm on neurological prognostication after cardiac arrest. CR=corneal reflexes. FN=false negative, normal examination and poor outcome. FOUR=Full Outline Unresponsiveness (0=no motor response, 1=extension posture, 2=flexion posture, 3=locating pain, 4=making signs). (7) FP=false positive, pathological examination and good outcome. HIE=hypoxic-ischaemic encephalopathy. PLR=pupillary light reflexes. TN=true negative, normal examination and good neurological outcome. TP=true positive, pathological examination and poor neurological outcome

References

1. The TTM2 trial is supported by independent research grants from nonprofit or governmental agencies (the Swedish Research Council [Vetenskapsrådet], Swedish Heart–Lung Foundation, Stig and Ragna Gorthon Foundation, Knutsson Foundation, Laerdal Foundation, Hans-Gabriel and Alice Trolle-Wachtmeister Foundation for Medical Research, and Regional Research Support in Region Skåne) and by governmental funding of clinical research within the Swedish National Health Service.
2. 1. Lemiale V, Dumas F, Mongardon N, et al. Intensive care unit mortality after cardiac arrest: the relative contribution of shock and brain injury in a large cohort. *Intensive Care Med.* 2013;39 (11):1972–1980.
3. 2. Dragancea I, Rundgren M, Englund E, Friberg H, Cronberg T. The influence of induced hypothermia and delayed prognostication on the mode of death after cardiac arrest. *Resuscitation.* 2013;84 (3):337–342.
4. 3. Nolan JP, Sandroni C, Böttiger BW, et al. European Resuscitation Council and European Society of Intensive Care Medicine guidelines 2021: post-resuscitation care. *Intensive Care Med.* 2021;47 (4):369–421.
5. 4. Youn CS, Park KN, Kim SH, et al. External validation of the 2020 ERC/ESICM prognostication strategy algorithm after cardiac arrest. *Crit Care.* 2022;26 (1):95.
6. 5. Pouplet C, Colin G, Guichard E, et al. The accuracy of various neuro-prognostication algorithms and the added value of neurofilament light chain dosage for patients resuscitated from shockable cardiac arrest: An ancillary analysis of the ISOCRATE study. *Resuscitation.* 2022;171:1–7.
7. 6. Dankiewicz J, Cronberg T, Lilja G, et al. Targeted hypothermia versus targeted normothermia after out-of-hospital cardiac arrest (TTM2): A randomized clinical trial-Rationale and design. *Am Heart J.* 2019;217:23–31.
8. 7. Iyer VN, Mandrekar JN, Danielson RD, Zubkov AY, Elmer JL, Wijdicks EF. Validity of the FOUR score coma scale in the medical intensive care unit. *Mayo Clin Proc.* 2009;84 (8):694–701.

Topic: Cardiac arrest

001197

Incidence and risk factors of pneumothorax in patients with severe Covid-19 pneumonia: Nationwide cohort study

Y. Jang¹, K. Minsun², J. Jaehun², Y. L. Sung³, K. Hong Bin³, K. Eu Suk³, M.J. Song³

¹Department of Digital Healthcare, Seoul National University Bundang Hospital, Seongnam-si, Republic of Korea; ²Department of Preventive Medicine, Gachon University College of Medicine, Incheon, Republic of Korea; ³Internal medicine, Seoul National University Bundang Hospital, Seongnam-si, Republic of Korea

Correspondence: M.J. Song

Intensive Care Medicine Experimental 2023, **11 (Suppl 1)**:001197

Introduction: Infection with severe acute respiratory syndrome coronavirus 2 (SARS-CoV-2) and the subsequent disease Covid-19 is mainly characterized by respiratory symptoms, with lung infiltrates being present in more than 50% of hospitalized cases. Pneumothorax is potential complication in pulmonary infections. Several studies have reported that pneumothorax occur frequently in patients with Covid-19 pneumonia ranging from 15 to 20% of those receiving invasive ventilation.

Objectives: This study aimed to (1) investigate the incidence of pneumothorax in adult patients with severe Covid-19 pneumonia, (2) compare the incidence of pneumothorax with patients with influenza pneumonia, and (3) identify the risk factors for pneumothorax in patients with severe Covid-19 pneumonia.

Methods: Nationwide population-based study conducted using the Korean National Health Insurance Service data-base. Adult (aged ≥ 19 years) patients with severe Covid-19 pneumonia hospitalized from December 2019 to December 2020 and patients with severe influenza pneumonia hospitalized from 2020 January 2018 to December 2021 were evaluated. Severe pneumonia was defined as patients receiving ICU-level respiratory organ support (high-flow nasal cannula, noninvasive or invasive mechanical ventilation, extracorporeal life support). Development of pneumothorax was defined as having a diagnosis of pneumothorax or having received a closed thoracotomy.

Inverse probability of treatment weighting (IPTW) was used to adjust for differences in patients between Covid-19 and influenza pneumonia.

Results: A total of 46,508 patients with severe Covid-19 pneumonia were identified (median age 62 years; 52.9% male). Among them, 344 (0.74%) were diagnosed with pneumothorax. In the IPTW matched cohort, development of pneumothorax was significantly more frequent in Covid-19 compared to influenza pneumonia (0.74% vs 0.49%, $P < 0.001$; OR 1.52; 95% CI, 1.05–2.21).

In the multivariable logistic regression, old age (OR, 1.03; 95% CI, 1.02–1.04; $P < 0.001$), male sex (OR, 1.34; 95% CI, 1.06–1.70; $P < 0.001$), and patients treated with ventilator (OR, 36.70; 95% CI, 29.80–52.90; $P < 0.001$) or extracorporeal life support (OR, 2.97; 95% CI, 2.16–4.09; $P < 0.001$) were associated with development of pneumothorax in severe Covid-19 pneumonia.

Conclusions: This nationwide cohort study found that the incidence of pneumothorax in severe Covid-19 pneumonia was 0.74% and more frequent compared to influenza pneumonia. Old age, male sex, and patients treated with ventilator or extracorporeal life support were risk factors for pneumothorax in severe Covid-19 pneumonia.

References

- Shrestha DB, Sedhai YR, Budhathoki P et al. (2022) Pulmonary barotrauma in COVID-19: a systematic review and meta-analysis. *Ann Med Surg* 73:103221.
- Belletti A, Todaro G, Valsecchi G et al. (2021) Barotrauma in Coronavirus Disease 2019 patients undergoing invasive mechanical ventilation: a systematic literature review. *Crit Care Med*

Topic: Acute respiratory failure and mechanical ventilation

001198

Hemodynamic determinants of urine output during continuous renal replacement therapy

L. Bitker¹, C. Biscarrat¹, M. Chivot¹, G. Chazot¹, G. Deniel¹, J.C. Richard¹
¹Medical Intensive Care Unit, Hôpital de la Croix-Rousse-HCL, Lyon, France

Correspondence: L. Bitker

Intensive Care Medicine Experimental 2023, **11** (Suppl 1):001198

Introduction: Low cardiac output and hypovolemia are candidate macrocirculatory mechanisms of de novo oliguria and anuria in ICU patients undergoing continuous renal replacement therapy (CRRT), but therapeutic hits such as norepinephrine or excessive ultrafiltration may also be implicated [1, 2]. To date, the impact of systemic hemodynamics on urine output (UO) remains unknown in the context of CRRT.

Objectives: We aimed to determine the hemodynamic parameters associated with the longitudinal course of UO in ICU patients treated with CRRT.

Methods: This is an ancillary analysis of the PRELOAD CRRT observational, single-center study (NCT03139123), which evaluated the prevalence of preload-dependent hypotensions in patients undergoing CRRT [3]. Enrolled patients (≥ 18 years) had severe acute kidney injury treated with CRRT for less than 24 h, and were monitored with a calibrated continuous cardiac output monitoring device. Hemodynamics, norepinephrine dose, and preload-dependence (identified by continuous cardiac index variation during passive leg raising) were reported 4-hourly, over a maximum duration of 7 days [4]. Cardiac output was calibrated every 4 h by transpulmonary thermodilution to compute the systolic volume index (SVI). Net ultrafiltration (UFNET) and 4-hourly UO were collected from ICU charts and expressed in ml.h⁻¹.kg⁻¹. Two study groups were defined at inclusion: non-anuric participants if the cumulative 24 h UO at inclusion was ≥ 0.05 ml.h⁻¹.kg⁻¹, and anuric otherwise. Quantitative data was reported by its median [interquartile range]. Mixed-effects regression models evaluated longitudinally the association of UO with hemodynamics and CRRT settings, with a random intercept (patient study identification number) and a random slope (time since inclusion) to account for the repetition of measurements in a given patient.

Results: Between May 2017 and September 2020, 42 patients (age 68 [58–76] years) were enrolled 6 [1–15] hours after CRRT start and were followed for 119 [57–143] hours. At inclusion, 40 patients (95%) received norepinephrine, 39 (93%) were treated with CVVH, and 32 (76%) were not anuric. Hemodynamics did not differ significantly between study groups at inclusion. During follow-up, UO decreased significantly in non-anuric patients, with 23/32 (72%) progressing to anuria within 19 [10–50] hours. Mean arterial pressure, norepinephrine dose and UFNET did not significantly differ between study groups during follow-up, while SVI and preload-dependence showed a significant association with the interaction of study group and time since inclusion. In multivariate analysis, UO was significantly associated with SVI, mean arterial pressure, preload-dependence and time since inclusion (**Figure 1 for the description of model results and interpretation), but not with UFNET or norepinephrine dose. Fluid balance between inclusion and H72 of inclusion was significantly higher in the anuric group, compared to non-anuric participants (-3 [-10–1] vs. +6 [1–11]%, $P = 0.02$). CRRT free-days at day 90 were similar between study groups (0 [0–52] vs. 0 [0–76], $P = 0.56$).

Conclusions: In ICU patients treated with CRRT, those without anuria at treatment start showed a rapid loss of diuresis after CRRT initiation and a positive fluid balance. Hemodynamic indicators of renal perfusion and volemia were the principal determinants of UO during follow-up, while other suspected confounders (such as norepinephrine or UFNET) were not. Finally, presence of anuria at CRRT commencement was not associated with worse clinical outcome.

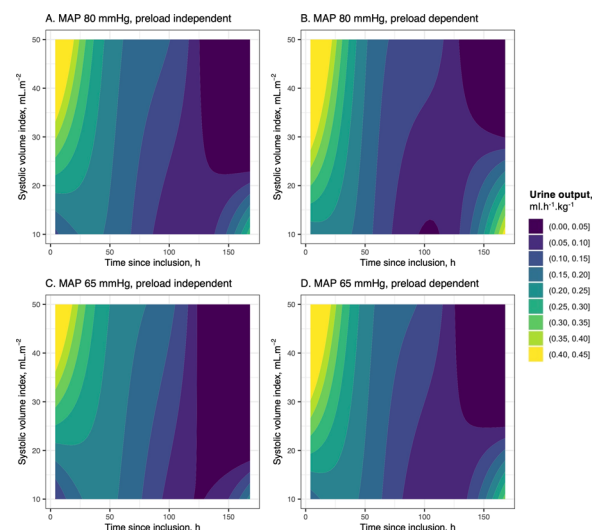

References

- Bellomo R, Sansom B, Tonkin-Hill G, Kalfas S, Park S, Presneill J, (2022) The relationship between commencement of continuous renal replacement therapy and urine output, fluid balance, mean arterial pressure and vasopressor dose. *Crit Care Resusc* 24: 259–267
- Mc Causland FR, Asafu-Adjiei J, Betensky RA, Palevsky PM, Waikar SS, (2016) Comparison of Urine Output among Patients Treated with More Intensive Versus Less Intensive RRT: Results from the Acute Renal Failure Trial Network Study. *Clin J Am Soc Nephrol* 11: 1335–1342
- Chazot G, Bitker L, Mezidi M, Chebib N, Chabert P, Chauvelot L, Folliet L, David G, Provoost J, Yonis H, Richard JC, (2021) Prevalence and risk factors of hemodynamic instability associated with preload-dependence during continuous renal replacement therapy in a prospective observational cohort of critically ill patients. *Ann Intensive Care* 11: 95
- Monnet X, Rienzo M, Osman D, Anguel N, Richard C, Pinsky MR, Teboul JL, (2006) Passive leg raising predicts fluid responsiveness in the critically ill. *Critical care medicine* 34: 1402–1407
- None

Topic: Acute Kidney Injury and haemofiltration

001199

Characteristics of plant poisoning admitted to intensive care unit: a series of cases in TunisiaH. Maamouri¹, S. Donia², N. Brahmi²¹Medical ICU, Intensive care unit Rambouillet, Paris, France; ²Tunis, Centre d'assistance médicale urgente-CAMU, Tunis, Tunisia**Correspondence:** H. Maamouri*Intensive Care Medicine Experimental* 2023, **11** (Suppl 1):001199**Introduction:** Plant poisoning are rarely described in the literature and their effects can be fatal.**Objectives:** The aim of the study was to describe the circumstances, routes of exposure, type of plant, associated toxidrome, treatment and outcome of patients admitted for plant poisoning in intensive care unit.**Methods:** It was a retrospective descriptive monocentric study of clinical cases with plant poisoning admitted to intensive care unit of CMYAMU from January 2006 to June 2021.**Results:** We included 55 patients with a female predominance and a mean age of 45 ± 20.8 years [9–93]. The most frequent comorbidities were diabetes and hypertension (18%, n = 10). Circumstances of poisoning were accidental (58%), therapeutic (20%), addictive (16%) and for suicidal purpose (6%). Datura (31%) and Ricin (26%) were the most poisonous plants, followed by Black Henbane (11%), common oleander (11%), Belladonna (9%), Harmal (4%), Mandrake (4%) and isolated intoxications with Camphor, Lupin and Cherry seeds. Anticholinergic toxidrome was observed during Datura, black henbane, belladonna, mandrake and lupine seeds poisoning. Digestive signs were predominant during ricin and Harmal poisoning but they were more pronounced during ricin intoxication with a longer duration of hospitalization [1–8]. The cardiac signs were predominant during common oleander poisoning. Cherry seeds mimicked cyanide poisoning with digestive signs associated with hyperlactatemia. Treatment was symptomatic, and four patients required mechanical ventilation: Datura intoxication (n = 2), black henbane (n = 1), camphor intoxication (n = 1). The evolution was favorable for the majority of cases with an average hospitalization time of 2.3 ± 1.7 days [1–12], except for fatal camphor poisoning.**Conclusions:** The present study identified Tunisian plants with toxicological risks and provides a data base for a more rational approach to prevention, diagnosis, and treatment of plant poisoning cases.**Topic:** Poisoning/Toxicology/Pharmacology

001201

Can we reduce the number of MSCT pulmonary angiography tests in suspected pulmonary embolismS. Krizanac¹, M. Krilicic², M. Rora³, C. K. Ela³, J. Babel³, L. Bielen⁴, R. Radonicic³¹Department of internal medicine, Franziskus Spital, Wien, Austria;²Pulmology, General Hospital "Dr. J. Benčević", Slavonski Brod, Croatia;³Department of internal medicine, University Hospital Centre Zagreb, Zagreb, Croatia;⁴Department of internal medicine, University Hospital Centre Zagreb, Ulica Mije Kišpatića, Zagreb, Croatia, Zagreb, Croatia**Correspondence:** S. Krizanac*Intensive Care Medicine Experimental* 2023, **11** (Suppl 1):001201**Introduction:** MSCT pulmonary angiography (MSCT PA) is a golden standard diagnostic test for pulmonary embolism (PE). Significant irradiation, contrast induced nephropathy and costs are the main drawbacks of this imaging modality. The majority of PEs have a source in the lower extremity proximal deep veins. Ultrasound examination of proximal leg veins is a simple, highly specific, bedside available test for diagnosing deep venous thrombosis (DVT). Better sensitivity can be reached if the calf veins are also examined, as is required by the BLUE protocol (1), but such an approach is more time consuming. DVT is an indication for anticoagulation treatment, so the finding of concomitant PE will not influence the treatment in hemodynamically stable

patients. Criteria for fibrinolytic treatment are clinical and supported by ultrasound studies, while MSCT PA usually does not influence the decision.

Objectives: To determine the proportion of patients with positive femoral and/or popliteal ultrasound for DVT among those with MSCT PA proven PE. Also, to assess if the avoidance of MSCT PA in patients with ultrasound proven DVT would be safe.**Methods:** In this retrospective study, medical records of patients admitted to the medical intensive care unit due to MSCT PA proven PE were reviewed. Patients who required fibrinolytic treatment were excluded.**Results:** During a five-year period (2014–2019) 117 patients were admitted due to MSCT PA proven PE. Three of them required fibrinolytic treatment and were excluded from the study. Of 114 included patients with median age of 67.5 years (22–92 years), 58 were females (50.9%). One patient died during the hospitalization, due to reasons unrelated to the PE (hospital mortality 0.87%). MSCT PA study categorized 78 (68.4%) patients as those with massive and 36 (31.6%) with sub massive PE, while signs of right ventricle overload were seen on 60 (52.6%) MSCT PAs.

All patients were examined for femoral and popliteal DVT by ultrasound within the first 72 h from admission. DVT in the femoral and/or popliteal region was found in 66 patients (57.9%); femoral in 19, popliteal in 28, and both femoral and popliteal in 19 patients. No additional important information was observed by MSCT PA. The calculated average dosage of irradiation was 241 mGycm with an approximate risk of one malignancy for 5000 MSCT PA studies.

Conclusions: In patients with the clinical suspicion of PE, an ultrasound finding of femoral and/or popliteal DVT could be enough for the initiation of the anticoagulation treatment with no need for MSCT PA (2, 3). In the observed population no additional important information was provided by MSCT PA.**References**

1. Lichtenstein DA, Mezière GA. Relevance of lung ultrasound in the diagnosis of acute respiratory failure: the BLUE protocol. *Chest*. 2008 Jul;134(1):117–25
2. Le Gal G et al. A positive compression ultrasonography of the lower limb veins is highly predictive of pulmonary embolism on computed tomography in suspected patients. *Thromb Haemost* 2006;95:963–966
3. Konstantinides et al. 2019 ESC guidelines for the diagnosis and management of acute pulmonary embolism developed in collaboration with European Respiratory Society (ERS). *Eur Heart J*. 2020 Jan 21;41(4):543–603
4. No funding was available for this study.

Topic: Acute respiratory failure and mechanical ventilation

001202

Early mobilization practice at the ICU: A 1-day point-prevalence study in Catalonia (Spain)N. Murillo Moreno¹, P. Perelló², J. Marin³, S. Manrique¹, M. Bodí¹, M. Magrè¹, G. Socmic⁴¹ICU, Hospital Universitari de Tarragona Joan XXIII, Tarragona, Spain;²Intensive care unit, Hospital Sant Joan de Déu de Manresa, Manresa, Spain;³Critical care department, Hospital del Mar, Barcelona, Spain;⁴ICU, Socmic, Barcelona, Spain**Correspondence:** N. Murillo Moreno*Intensive Care Medicine Experimental* 2023, **11** (Suppl 1):001202**Introduction:** There is growing evidence to support early mobilization of mechanically ventilated adult patients. However there is no consensus about what type of practices are most beneficial for patients and how, when and where to start it.**Objectives:** To describe current early mobilization practices in critical patients who received invasive mechanical ventilation (IMV) for longer than 48 h in Catalan ICUs.**Methods:** 1-day, multicentric, observational, prevalence study in 17 Catalan ICUs in February 2022. Included patients were over 18 years

old and received IMV for longer than 48 h. The data retrieved was: ICU characteristics (resources and organizational) demographics, mobilization technique based on airway, reason for no mobilization, adverse events and ICU acquired muscle weakness (ICUAMW) diagnosis.

Results: 188 patients were included. The average age was 63 (standard deviation 12.13), average SOFA of 6 (0–17) on the day of the study. Patient source of admission was the emergency room (29%), followed by the general ward (27%). The most frequent reason for admission was respiratory failure (42%) and the main reason for intubation was SARS CoV-2 pneumonia (42.6%).

The great majority of ICUs (88.2%) had a physiotherapist available, and in the 70.6% the physiotherapist was available 5 days per week. The time the physiotherapist was available for is 0–4 h in 41.2% of the ICUs, followed by 4–8h in 35.3%. 70.6% of the ICUs count with an early mobilization protocol.

Regarding the decision to mobilize the patients: the ICU specialist participated in 73% of the cases, followed by the physiotherapist (61%) and nurses (59%). The professionals who most frequently mobilized patients were physiotherapists (82%) and nurses (79%).

ICUAMW was evaluated in 93 (49.5%) patients; 85% of which were diagnosed with ICUAMW because of MRC < 48. In relation to the 50.2% non-evaluated patients, 61% had RASS < -2.

In regard to mobilization; 87.2% of the patients were mobilized, resulting in 301 mobilizations; 249 of which were in bed and 52 out-of-bed (83% vs 17%, p = 0.03).

Concerning mobilizations based on the airway, active mobilization (20% vs 12%, p = 0.002), spine control (7% vs 1%, p = 0.001) and sitting on chair (10% vs 3%, p = 0.001) were the most frequent in patients with tracheostomy, as opposed to intubated patients. In the remainder of the mobilizations there were no significant differences between both groups. No patient with an endotracheal tube walked.

From the 12.8% non-mobilized patients, the main reason was respiratory followed by hemodynamic instability.

There were no significant side effects of mobilization and the incidence was low < 1%.

Conclusions: Out-of-bed mobilization of patients with invasive ventilation is low, the group with endotracheal tube being the least mobilized. Patients with no mobilization whatsoever have a contraindication in a majority of the cases. The adverse effect incidence was low, < 1%.

Level of mobilization	Airway type			p
	TOTAL N= 301 n(%)	TRACHEOSTOMY N= 221 n(%)	ENDOTRACHEAL TUBE N= 80 n(%)	
In bed	249 (83)	173 (78)	76 (95)	
Turning in bed	77 (25)	43 (19)	34 (42)	p = 0,50
Passive mobilization	69 (23)	43 (19)	26 (33)	p = 0,37
Active mobilization	54 (18)	44 (20)	10 (12)	p = 0,002
Sitting in bed	29 (10)	25 (11)	4 (5)	p = 0,05
Spine control	15 (5)	14 (7)	1 (1)	p= 0,001
Sitting on edge of bed	5 (2)	4 (2)	1 (1)	p = 0,76
Mobilized out of bed	52 (17)	48 (22)	4 (5)	
Sitting out of bed	26 (9)	24 (10)	2 (3)	p= 0,001
Standing out of bed	9 (3)	8 (4)	1 (1)	p = 0,25
Walking	4 (1)	4 (2)	0 (0)	p = 0,36
Cicloergometry	13 (4)	12 (6)	1 (1)	p = 0,062

Appendix A: Highest Level of Mobilization Achieved on Study Day

	No airway N=23 n(%)	Tracheostomy N=107 n(%)	Endotracheal tube N=57 n (%)	NIV N=1 n(%)
Pain	1 (4,3%)	0 (0%)	0 (0%)	
Out of care unit	1 (4,3%)	2 (1,9%)	0 (0%)	
Respiratory origin		3 (2,8%)	3 (5,3%)	1 (100%)
COMA		1 (0,9%)	3 (5,3%)	
Hemodynamic instability		2 (1,9%)	5 (8,8%)	
No mobilization		2 (1,9%)	2 (3,5%)	
Femoral traction		1 (0,9%)	0 (0%)	
Unknown		1 (0,9%)	1 (1,8%)	
Contraindicated			2 (3,5%)	
Intracranial hypertension			5 (8,8%)	
Respiratory failure			1 (1,8%)	
Therapeutic load correction			2 (3,5%)	
Prono position			1 (1,8%)	
Sedation			3 (5,3%)	

Appendix B: Perceived Barriers to Achieve a Higher Level of Mobilization

References

- Nydahl P, Ruhl AP, Bartoszek G, Dubb R, Filipovic S, Flohr HJ, Kaltwasser A, Mende H, Rothaug O, Schuchhardt D, Schwabbauer N, Needham DM. Early mobilization of mechanically ventilated patients: a 1-day point-prevalence study in Germany. Crit Care Med. 2014 May;42 (5):1178–86. <https://doi.org/10.1097/CCM.0000000000000149>. PMID: 24351373.
- Berney SC, Harrold M, Webb SA, Seppelt I, Patman S, Thomas PJ, Denehy L. Intensive care unit mobility practices in Australia and New Zealand: a point prevalence study. Crit Care Resusc. 2013 Dec;15 (4):260–5. PMID: 24289506.

Topic: Critical care organisation, quality management, information systems, outcomes

001204

Clinical evaluation of a new mode of assisted mechanical ventilation: Neural Pressure Support

M. Sánchez Galindo¹, JA. Sanchez Giralte², MA. Pérez Lucendo², I. Temprano García², I. Magaña Bru², L. Rojo Montes², C. Alvargonzález Riera², E. Rosas Carvajal², B. Abad Santamaría², F. Jalde³, S. Andersson⁴, F. Suarez Sipmann²
¹ITU, Hospital de La Princesa, Madrid, Spain; ²ICU, Hospital de La Princesa, Madrid, Spain; ³Research & Development, Getinge Acute Care Therapies, Solna, Sweden; ⁴Children's hospital, pediatric research center, Helsinki University & Helsinki University Hospital, Helsinki, Finland

Correspondence: M. Sánchez Galindo

Intensive Care Medicine Experimental 2023, 11 (Suppl 1):001204

Introduction: During assisted mechanical ventilation a good matching between patient assigned ins and expiratory times, so called neural times, with the actual resulting mechanical times delivered by the ventilator is of the essence. Pressure support ventilation (PSV) relies exclusively on a pneumatic signal (the flow signal) for triggering and cycling-off. In some circumstances this limitation can cause a mismatch between the neural and mechanical times resulting in patient-ventilator asynchrony. Neural Pressure support (N-PSV) is a new hybrid mode combining assistance in PSV but substituting the pneumatic trigger by a neural trigger based on the electrical activity of the diaphragm (EAdi).

Objectives: To investigate whether a neural triggered PSV, N-PSV results in better time synchrony and better inspiratory times (neural and mechanical) matching in patients under assisted ventilatory support.

Methods: Prospective, physiological, comparative study in an unselected population of patients on assisted ventilation. PSV and N-PSV were compared during 2 consecutive periods of 30 min. Ventilator settings and level of support during PSV were those programmed by the attending clinician. During N-PSV these settings were maintained but trigger and cycle-off was based on the EAdi signal (obtained by a conventional NAVA catheter) instead of the flow signal. The following variables were compared: trigger time mismatch (TTm) the anticipation or delay between the start of patient's neural inspiratory cycle and the start of the assisted inspiratory cycle, expiratory cycling time mismatch (ECTm) anticipation or delay between the end of patient's neural inspiratory cycle and the end of the assisted inspiratory cycle, mechanical inspiratory time (TIm), neural inspiratory time (TIn) and the difference between them (TIdif). Comparisons were made with the t-student test for related samples or the Wilcoxon test for variables following a normal or non-normal distribution respectively.

Results: Preliminary analysis the first 13 included patients of an ongoing clinical study. Results are presented in Table 1 and Figure 1. N-PSV resulted in a reduced TTm (35 ms) and ECTm (105 ms) $p < 0.001$. The time mismatch was due to both anticipation and delay in triggering and cycling-off. There were no differences in absolute TIm and TIn values but a trend toward a better correspondence between both (less TIdif) during N-PSV.

Conclusions: In this unselected population N-PSV resulted in better time synchrony than PSV supporting the superiority of a neural signal over the pneumatic signal for triggering and especially for expiratory cycling. This could be an advantage in restrictive and obstructive patients with common early and late triggering and cycle-off problems in which patient-ventilator synchrony could be improved in N-PSV.

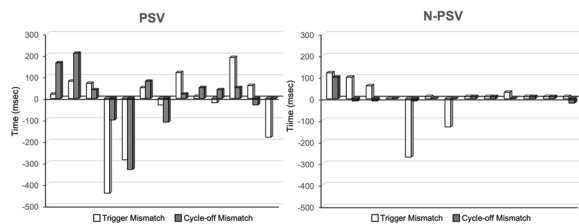

	PSV	N-PSV	p
TTm (msec)	94±92	59±78	<0.01
ECTm (msec)	119±126	14±26	<0.01
T _{Imec} (sec)	1.08±0.39	1.08±0.27	0.637
T _{Ineu} (sec)	1.1±0.40	1.1±0.33	0.387
TIdif (sec)	0.11±0.09	0.08±0.1	0.649

References

1. Yonis H. Patient-ventilator synchrony in Neurally Adjusted Ventilatory Assist (NAVA) and Pressure Support Ventilation (PSV): a prospective observational study. *BMC anesthesiology*. 2015;1–9.
2. Piquilloud L, Vignaux L, Bialais E, Roeseler J, Sottiaux T, Laterre P-F, et al. Neurally adjusted ventilatory assist improves patient-ventilator interaction. *Intensive Care Medicine*. 2010;37:263–71.
3. Barwing J, Ambold M, Linden N, Quintel M, Moerer O. Evaluation of the catheter positioning for neurally adjusted ventilatory assist. *Intensive Care Medicine*. 2009;35:1809–14.
4. Milic-Emili J, Mead J, TURNER JM, GLAUSER EM. IMPROVED TECHNIQUE FOR ESTIMATING PLEURAL PRESSURE FROM ESOPHAGEAL BALLOONS. *Journal of Applied Physiology*. 1964;19:207–11.
5. Mauri T, Yoshida T, Bellani G, Goligher EC, Carreaux G, Rittayamai N, et al. Esophageal and transpulmonary pressure in the clinical setting: meaning, usefulness and perspectives. *Intensive Care Medicine*. 2016;1–14.
6. Yoshida T, Fujino Y, Amato MBP, Kavanagh BP. Fifty Years of Research in ARDS. Spontaneous Breathing during Mechanical Ventilation. Risks, Mechanisms, and Management. *American Journal of Respiratory and Critical Care Medicine*. 2017;195:985–92.
7. Brochard L, Slutsky A, Pesenti A. Mechanical Ventilation to Minimize Progression of Lung Injury in Acute Respiratory Failure. *Am J Resp Crit Care*. 2017;195:438–42.
8. Blanch L, Villagra A, Sales B, Montanya J, Lucangelo U, Luján M, et al. Asynchronies during mechanical ventilation are associated with mortality. *Intens Care Med*. 2015;41:633–41.
9. Tobin MJ, Laghi F, Jubran A. Ventilatory Failure, Ventilator Support, and Ventilator Weaning. *Comprehensive Physiology*. 2012
10. Suarez-Sipmann F, SEMICYUC por el G de T de IRA de la. New modes of assisted mechanical ventilation. *Medicina intensiva / Sociedad Española de Medicina Intensiva y Unidades Coronarias*. 2014;38:249–60.

Topic: Acute respiratory failure and mechanical ventilation

001205

The Hypotension Prediction Index (HPI) is reliably available for finger cuff-derived arterial waveforms; a comparison of its clinical performance between invasively and non-invasively obtained measurements

SR. Rellum¹, E. Kho², J. Schenk², BJP. Van Der Ster², APJ. Vlaar¹, DP. Veelo²
¹Department of intensive care medicine, Amsterdam UMC, locatie AMC, Amsterdam, Netherlands; ²Department of Anesthesiology, Amsterdam UMC, locatie AMC, Amsterdam, Netherlands

Correspondence: S.R. Rellum

Intensive Care Medicine Experimental 2023, **11 (Suppl 1)**:001205

Introduction: Continuous blood pressure monitoring can be essential for identifying hypotensive events (1). This detection can be improved using the Hypotension Prediction Index (HPI), as shown in recent clinical trials (2–6). Using invasive blood pressure, these trials accomplished significant hypotension reduction through timely alerting. Recently, HPI has been made available on continuous non-invasive blood pressure data. Four studies have evaluated the performance of non-invasive HPI, with promising results (7–10). However, a comparison of simultaneously obtained invasive and non-invasive data has not yet been published.

Objectives: The primary objective was to determine whether the clinical performance of HPI based on non-invasive data is significantly different from its invasive counterpart. The statistical difference between the area under their receiver operating characteristics curves (AUC) was assessed for this. Secondary outcomes assessed additional characteristics obtained from performance classification. Finally, the time to event for each dataset was evaluated.

Methods: This retrospective observational study performed at the Amsterdam UMC, location AMC, the Netherlands, included adult patients scheduled for elective non-cardiac surgery. Invasive data were collected on an EV1000TM system, and non-invasive data were simultaneously collected on a ClearSight™ system (Edwards Lifesciences, Irvine, CA, USA). HPI performance classification involved assigning predictive binary classifiers over the full range of HPI thresholds. Classes were assigned using 20-min timeframes. Herein, hypotension was defined as a mean arterial pressure (MAP) < 65 mm Hg lasting at least a full minute. Consequently, an HPI alarm with subsequent hypotension within that timeframe was classified as true-positive. Then, all four false and positive classes were assigned using the same logic. As an exception, false-negative classes were discarded if, within that timeframe, an HPI alarm emerged before hypotension.

Results: The study included 91 patients containing 21,109 and 20,565 min of data in the invasive and non-invasive datasets, respectively. The number of hypotensive events was similar. Performance classification of invasive HPI attributed to an AUC of 91.6%, while the non-invasive dataset yielded an AUC of 94.4%. A two-tailed t-test showcased a non-significant difference with a p-value of 0.36. All other classifiers, including the sensitivity, specificity, and positive and negative predictive values, were also not significantly different. Finally, the median time-to-event values ranged from 5.00 to 7.33 min in both datasets.

Conclusions: The results show that HPI performs well regardless of how blood pressure is obtained. This means that non-invasively obtained HPI is reliably available to clinicians during non-cardiac surgery when there is no sign of impaired pressure transfer through the finger or additional need for an arterial line.

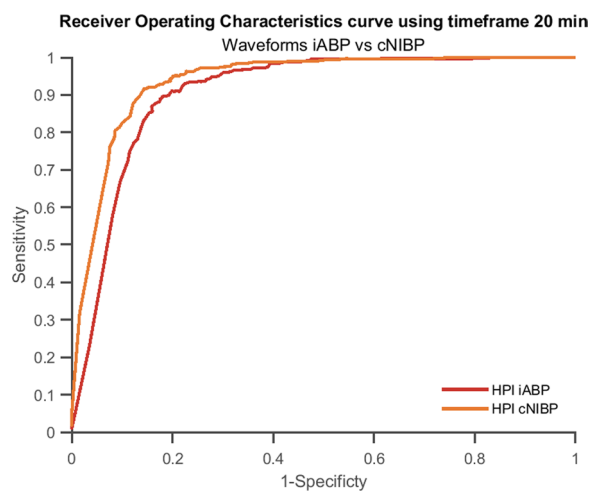

Figure 1 (abstract 001205) Receiver Operating Characteristics curve comparing the invasive and non-invasive datasets using a 20 min timeframe

HPI: Hypotension Prediction Index; iABP: invasive (radial) arterial blood pressure; cNIBP: continuous non-invasive (radial arterial reconstructed) blood pressure; min: minute (s).

References

1. Ciccone A, Celani MG, Chiamonte R, Rossi C, Righetti E. Continuous versus intermittent physiological monitoring for acute stroke. *Cochrane Database Syst Rev.* 2013 (5):CD008444.
2. Schneck E, Schulte D, Habig L, Ruhrmann S, Edinger F, Markmann M, et al. Hypotension Prediction Index based protocolized haemodynamic management reduces the incidence and duration of intraoperative hypotension in primary total hip arthroplasty: a single centre feasibility randomised blinded prospective interventional trial. *J Clin Monit Comput.* 2020;34 (6):1149–58.
3. Wijnberge M, Geerts BF, Hol L, Lemmers N, Mulder MP, Berge P, et al. Effect of a Machine Learning-Derived Early Warning System for Intraoperative

- Hypotension vs Standard Care on Depth and Duration of Intraoperative Hypotension During Elective Noncardiac Surgery: The HYPE Randomized Clinical Trial. *JAMA.* 2020;323 (11):1052–60.
4. Tsoumpa M, Kyttari A, Matiatou S, Tzoufi M, Griva P, Pikoulis E, et al. The Use of the Hypotension Prediction Index Integrated in an Algorithm of Goal Directed Hemodynamic Treatment during Moderate and High-Risk Surgery. *Journal of Clinical Medicine.* 2021;10 (24):5884.
 5. Murabito P, Astuto M, Sanfilippo F, La Via L, Vasile F, Basile F, et al. Proactive Management of Intraoperative Hypotension Reduces Biomarkers of Organ Injury and Oxidative Stress during Elective Non-Cardiac Surgery: A Pilot Randomized Controlled Trial. *Journal of Clinical Medicine.* 2022;11 (2):392.
 6. Sribar A, Jurinjak IS, Almahariq H, Bandic I, Matosevic J, Pejic J, et al. Hypotension prediction index guided versus conventional goal directed therapy to reduce intraoperative hypotension during thoracic surgery: a randomized trial. *BMC Anesthesiol.* 2023;23 (1):101.
 7. Frassanito L, Giuri PP, Vassalli F, Piersanti A, Zanfini BA, Catarci S, et al. Non-invasive hypotension Prediction Index versus continuous blood pressure monitoring and intraoperative hypotension. *Minerva Anesthesiol.* 2022.
 8. Wijnberge M, van der Ster BJP, Geerts BF, de Beer F, Beurskens C, Emal D, et al. Clinical performance of a machine-learning algorithm to predict intra-operative hypotension with noninvasive arterial pressure waveforms: A cohort study. *Eur J Anaesthesiol.* 2021;38 (6):609–15.
 9. Frassanito L, Sonnino C, Piersanti A, Zanfini BA, Catarci S, Giuri PP, et al. Performance of the Hypotension Prediction Index With Noninvasive Arterial Pressure Waveforms in Awake Cesarean Delivery Patients Under Spinal Anesthesia. *Anesth Analg.* 2022;134 (3):633–43.
 10. Maheshwari K, Buddi S, Jian Z, Settels J, Shimada T, Cohen B, et al. Performance of the Hypotension Prediction Index with non-invasive arterial pressure waveforms in non-cardiac surgical patients. *J Clin Monit Comput.* 2021;35 (1):71–8.

Topic: Perioperative care

001206

Automated infrared pupillometry as a tool for prognostication in patients with intracerebral haemorrhage

F. Magarotto¹, A. Marudi¹, E. Marinangeli¹, G. Bettelli¹, G. Melegari¹, S. Giordana¹, E. Bertellini¹, I. Corrado²

¹Anestesia e rianimazione, Ospedale Civile di Baggiovara, Baggiovara, Italy; ²Neurochirurgia, Ospedale Civile di Baggiovara, Baggiovara, Italy

Correspondence: F. Magarotto

Intensive Care Medicine Experimental 2023, **11 (Suppl 1)**:0001206

Introduction: The assessment of pupillary light reflex (PLR) is essential in critical care. The interest in automated infrared pupillometry in the intensive care unit practice for the evaluation of neurocritical patients has been growing recently, due to the reliability of this method and its non-invasiveness. Nevertheless, a clear indication for the applications of this instrument has not been firmly established yet.

Objectives: The objective of this study was to determine whether automated infrared pupillometry can provide useful information on the prognosis of neurocritical patients affected by intracerebral haemorrhage (ICH).

Methods: We conducted a single-center observational retrospective study. We included patients with intracerebral haemorrhage admitted to Neurointensive Care Unit in Modena Hospital from 2019 to 2022. We collected serial automated infrared pupillometry measurements using the NeuroOptics® NPi®-200 pupillometer, which provides a scalar value called Neurological Pupil index® (NPI®), that is calculated with pupillary parameters such as maximum and minimum pupillary size, constriction and dilation velocity and others. We calculated the average NPI® value (avgNPI®) for each patient to assign a single value to their clinical course. We considered an avgNPI® value < 3 as an indicator of poor outcome (ICU mortality). Two-tailed Fischer's test was used to study the correlation between ICU mortality and avgNPI® values.

Results: Of 81 patients (average age 68.8 years [21–92]) admitted to the ICU for ICH, 49 were discharged from the ICU (average avgNPI®: 4.24; SD ± 0.41) while 32 died in the ICU (average avgNPI®: 1.43; SD ± 0.81). We observed a significant correlation between avgNPI® and

mortality (sensitivity=81.3%; specificity=95.9%; positive predictive value=92.9%; negative predictive value=88.7%; p-value<0.0001). ROC curve analysis provided an AUC of 0.893 (Figure 1).

Conclusions: Our data suggest that automated infrared pupillometry could be a useful tool in the evaluation of neurocritical patients affected by intracerebral haemorrhage. Further studies could take into consideration the role of intracranial pressure alongside the NPi® to provide more accurate evaluation of the patient.

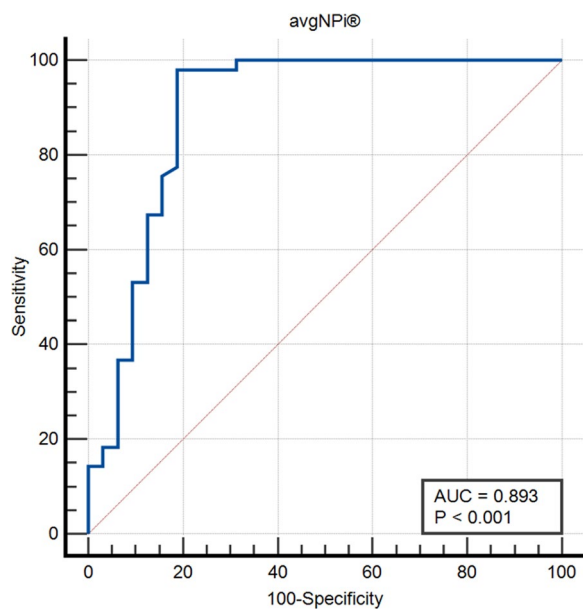

Figure 1 (abstract 001206) ROC curve analysis

Topic: Neurointensive care

001207

Barriers and facilitators to the use of Mechanical Insufflation-Exsufflation (MI-E) in intubated patients across adult UK Intensive Care Units: exploration of clinicians views

E. Swingwood¹, L. Tume², J. Bewley³, G. Ntoumenopoulos⁴, L. Rose⁵, S. Voss⁶, F. Cramp⁶

¹Adult Therapy Services, Department of Intensive Care, University Hospitals Bristol and Weston NHS FT, Bristol, United Kingdom; ²School of Health and Society, University of Salford, Salford, United Kingdom; ³Department of Intensive Care, University Hospitals Bristol and Weston NHS FT, Bristol, United Kingdom; ⁴Department of Intensive Care, St Vincent's Hospital Sydney, Darlinghurst, Australia; ⁵King's college, Florence Nightingale Faculty of Nursing, Midwifery and Palliative Care, London, United Kingdom; ⁶College of Health, Science and Society, University of the West of England-UWE Bristol, Stoke Gifford, United Kingdom

Correspondence: E. Swingwood

Intensive Care Medicine Experimental 2023, **11 (Suppl 1)**:001207

Introduction: Implementation of Mechanical Insufflation-Exsufflation (MI-E) in UK intensive care units (ICU) is limited, despite emerging evidence of efficacy (1,2,3) and safety (3,4) with intubated patients. A UK survey of respiratory physiotherapists working in ICU highlighted barriers to device use including the need for training and experience; resource availability and culture of the physiotherapy and wider ICU team (5).

Objectives: To further explore barriers and enablers for MI-E use in the acutely intubated, critically ill patient group, as perceived by ICU clinicians.

Methods: Semi structured online interviews were conducted with doctors, nurses and physiotherapists working in ICU, recruited using purposive sampling.

An interview guide was developed based on the Theoretical Domains Framework (TDF) (6,7) and piloted by clinicians with MI-E expertise. Interviews were recorded and transcribed verbatim.

Descriptive statistics described demographic data. Interview transcripts were analysed using content analysis, assigning quotes to TDF domains. Links across domains were considered.

Results: There were 29 interviews completed (18 physiotherapists, six doctors, five nurses). Clinicians had been qualified for 12 (2–32) years (median (range)) with 7 (1–21) years in a static ICU position. Thirteen clinicians held post-graduate qualifications (MSc or equivalent). Interviews were 31 (16–52) minutes duration. In total, 1137 codes were generated covering all TDF domains.

Knowledge and skills were important determinants of MI-E initiation. Differences across professions regarding current and perceived knowledge and skills were present, impacting profession specific roles for MI-E use. Profession specific roles were important in the decision-making process and the practical application of MI-E.

Culture of single professions and the wider multidisciplinary team was influential in the initiation and ongoing use of MI-E, having positive and negative outcomes. The impact of hierarchy within professions had negative consequences on device implementation, device exposure and subsequent development of skills and knowledge of others.

A positive opinion of MI-E was demonstrated regarding current and future use of MI-E in the acutely intubated population. A collaborative approach was seen as important to enable clinical progression and change regarding the use of MI-E in ICU.

Conclusions: This study highlights barriers to device use consistent with previous literature. Knowledge and skills are important determinants of MI-E use in the intubated population. Education strategies should consider learning needs and profession specific roles prior to initiation. Despite a positive opinion of MI-E, multidisciplinary team culture and hierarchy have negative consequences. A collaborative multidisciplinary team approach was viewed as important to optimise future MI-E implementation outcomes.

References

1. Goncalves MR, Honrado T, Winck JC, Paiva JA. Effects of mechanical insufflation-exsufflation in preventing respiratory failure after extubation: a randomized controlled trial. *Crit Care* 2012;16 (2):R48.
2. Ferreira de Camillis ML, Savi A, Goulart Rosa R, Figueiredo M, Wickert R, Borges LGA, et al. Effects of Mechanical Insufflation-Exsufflation on Airway Mucus Clearance Among Mechanically Ventilated ICU Subjects. *Respir Care* 2018;63 (12):1471–1477.
3. Martínez-Alejos R, Martí J-D, Li Bassi G, Gonzalez-Anton D, Pilar-Diaz X, Reginalt T, et al. Effects of Mechanical Insufflation-Exsufflation on Sputum Volume in Mechanically Ventilated Critically Ill Subjects. *Respir Care* 2021;66 (9):1371–1379.
4. Sanchez Garcia M, Alvarez M, Domingo S, Del Pino A, Martinez F, Gonzalez P, et al. Safety and tolerability of mechanical insufflation-exsufflation (MI-E) and hypertonic saline with hyaluronic acid (HS-HA) for respiratory secretion suctioning (RSS) in intubated patients (abstract). *Intensive Care Med* 2019;7.
5. Swingwood E, Tume L, Cramp F. A survey examining the use of mechanical insufflation-exsufflation on adult intensive care units across the UK. *J Intensive Care Soc* 2019.
6. Atkins L, Francis J, Islam R, O'Connor D, Patey A, Ivers N, et al. A guide to using the Theoretical Domains Framework of behaviour change to investigate implementation problems. *Implement Sci* 2017;12 (1):77.
7. Cane J, O'Connor D, Michie S. Validation of the theoretical domains framework for use in behaviour change and implementation research. *Implement Sci* 2012;7:37.
8. National Institute for Health and Care Research, Clinical Doctoral Research Fellowship (NIHR300504)

Topic: Nursing care and physiotherapy

001208

The diastolic blood pressure is related to peripheral tissue microcirculatory dysfunction in COVID-ARDS patients

B. Ergin¹, C. Ince¹, HE. Endeman¹

¹The Department of intensive Care, Erasmus University Medical Center, Rotterdam, Netherlands

Correspondence: B. Ergin

Intensive Care Medicine Experimental 2023, 11 (Suppl 1):001208

Introduction: Covid-19-related acute respiratory distress syndrome (C-ARDS) causes severe hypoxia, hyperinflammation, and microcirculatory dysfunction that is associated with multiple organ failure and mortality (1). Despite many studies being conducted for investigating the effects of mean arterial pressure (MAP) or systolic blood pressure (SBP) on microcirculation, the relationship between diastolic blood pressure (DBP) and peripheral microcirculation is completely unclear. Herein, we hypothesized that the alteration of DBP may contribute to peripheral tissue hypoxia and microcirculatory dysfunction.

Objectives: The relation between DBP and systemic-peripheral microcirculation in C-ARDS patients admitted to Intensive Care Unit, Erasmus MC, Rotterdam in 2021 was investigated.

Methods: 17 patients with COVID-19 (13:4 m/f) were divided into two groups with low DBP (lower than 65 mmHg, n=8) and high DBP (n=9). For this purpose, systemic hemodynamics, arterial blood gas, and electrolytes were assessed. While peripheral microcirculation was measured by thenar tissue spectrophotometry, a Hand-Held Vital Microscopy (HVM) was used for determining systemic (sublingual) microcirculatory alteration.

Results: The patients with L-DBP had significantly lower p-stO₂ (p<0.05) and p-Flow (p=0.055) than the patients with H-DBP despite having a similar P/F ratio and lactate (Figure 1 and Table 1). The arterial oxygen content (art-O₂ content) of patients with L-DBP was also lower than that of patients with H-DBP (p<0.05) (Table 1). Logistic regression analysis showed a significant correlation between the DBP and p-stO₂ (p<0.05) (Fig. 2). There were no differences in sublingual microcirculatory parameters (Fig. 3).

Table 1 (abstract 001208) Systemic (sublingual) microcirculatory and oxygenation parameters

	H-DBP	L-DBP
TVD (mm/mm ²)	22 ± 1,8	22,4 ± 3,8
FCD (mm/mm ²)	20,9 ± 2,2	21,3 ± 3,9
RBCv (mm.sec-1)	324,6 ± 79	317,5 ± 33,7
tRBCp (AU)	47,1 ± 14	45,9 ± 10
Arterial O ₂ content (ml.O ₂ .min-1)	9,97 ± 1,29	8,6 ± 1,1*
Lactate (mmol/L)	1,3 ± 0,4	1,5 ± 0,5
stO ₂ (pulse oximetry)	95,5 ± 1,7	95,2 ± 2,9
P/F ratio	158 ± 67	166 ± 48

The sublingual microcirculatory parameters, arterial oxygen content, lactate and oxygen saturation values. TDV; Total vessel density, FCD;

Functional capillary density, RBCv; Red blood cell velocity and tRBCp; Tissue red blood cell perfusion. p<0.05 vs H-DBP group. Values are represented as mean ± SD.

Conclusions: DBP can be used for estimating the alteration of peripheral tissue perfusion and oxygenation, therefore, guiding future therapies in C-ARDS patients. Further research is needed to determine the underlying mechanism of relation DBP to peripheral microcirculation in hyperinflammatory states of C-ARDS.

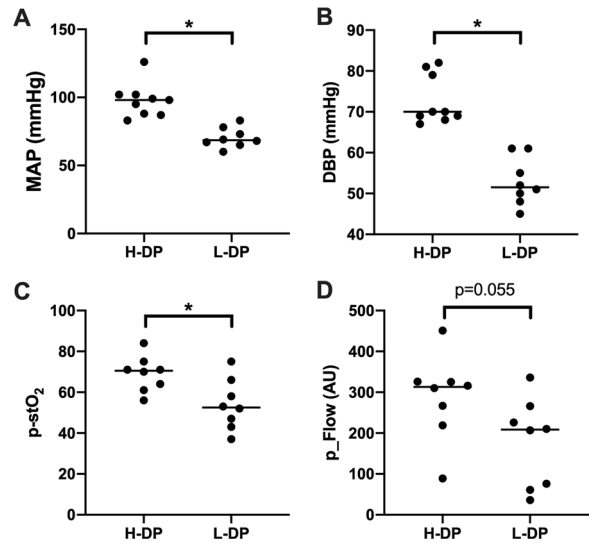

Figure 1 (abstract 001208) Mean arterial pressure (MAP), diastolic pressure (DBP), p-stO₂, and p-Flow in H-DBP and L-DBP groups. Values are represented as Mean ± SD

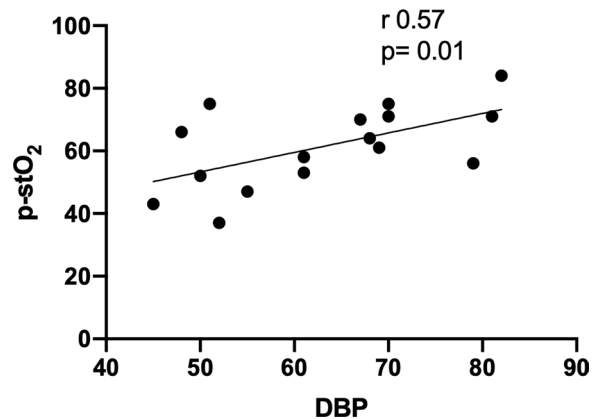

Figure 2 (abstract 001208) Correlation analysis between the DBP and p-stO₂

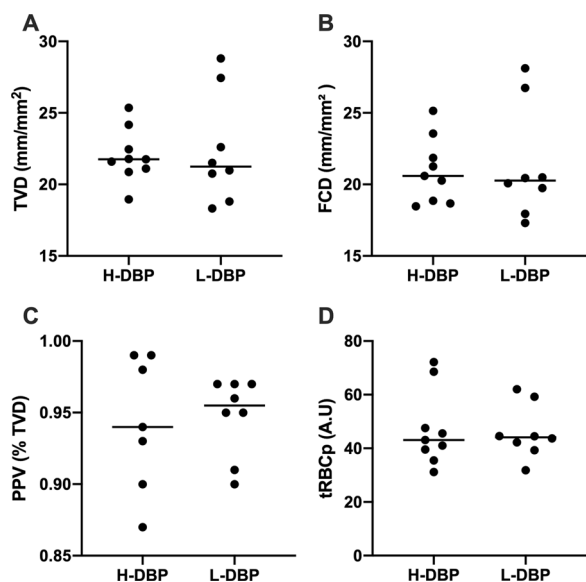

Figure 3 (abstract 001208) Sublingual microcirculatory alterations. TVD; Total vessel density, FCD; Functional capillary density, PPV; Proportion of perfused vessel and tRBCp; Tissue red blood cell perfusion. Values are represented as Mean ± SD

References

1. Favaron E, et al., Capillary Leukocytes, Microaggregates, and the Response to Hypoxemia in the Microcirculation of Coronavirus Disease 2019 Patients. *Crit Care Med.* 2021 Apr 1;49 (4):661–670.

Topic: Acute respiratory failure and mechanical ventilation

0012010

Severity and outcome stratification in patients with spontaneous subarachnoid hemorrhage: a comparison study

A. Degrassi¹, G. Coppalini², F. Oliveira¹, N. Ndieugnou Djangang¹, D. Diaferia¹, M. Menozzi¹, F. S. Taccone¹, E. Bogossian¹

¹Department of Intensive Care, Hospital Erasme, Bruxelles, Belgium;

²Anaesthesia and Intensive Care, Humanitas Research Hospital, Milan, Italy

Correspondence: A. Degrassi

Intensive Care Medicine Experimental 2023, **11 (Suppl 1)**:001210

Introduction: Numerous grading scales have been suggested for subarachnoid hemorrhage (SAH) in order to categorize the likelihood of unfavourable neurological outcomes and the risk of delayed cerebral ischemia (DCI), but their performance is variable.

Objectives: To evaluate and compare the performance of SAH grading scores, including the WFNS, Modified Fisher (mFS), VASOGRADE, HATCH, Sequential Organ Failure Assessment (SOFA) and Acute Physiology and Chronic Health Evaluation (APACHE II) scores in predicting DCI, mortality and functional outcome in non-traumatic SAH patients.

Methods: Retrospective analysis of adults patients with non-traumatic SAH admitted to the intensive care unit (ICU) between January 2016 and December 2021. Demographic, radiological and clinical data were collected, and the performance of the grading scores in predicting DCI, mortality and unfavourable neurological outcome (UO, GOS 1–3)

at 3 months was assessed using the area under the receiver operating characteristic (AUROC) curves and logistic regression analysis.

Results: A total of 262 patients were included in the final analysis; DCI was observed in 82 (31.3%) patients, while 75 (28.6%) died and 133 (50.8%) had UO. APACHE II showed the highest performance in predicting UO, with an AUROC of 0.84 (95% CI 0.79–0.89), followed by the HATCH (AUROC 0.83, 0.77–0.87) and the SOFA score (AUROC 0.82, 0.77–0.87), Figure 1. They all performed significantly better than the other scores, but none of them was statistically superior. APACHE II, HATCH and SOFA also had the highest performance to predict in-hospital mortality, with AUROC of 0.82 (0.77–0.87), 0.79 (0.73–0.84), and 0.78 (0.72–0.84), respectively, Fig. 2. Again, the difference between them was not statistically significant. None of the scores performed significantly better than the others in predicting DCI, all showing low performance (AUROC < 0.65), Fig. 3.

Conclusions: In this study, APACHE II, HATCH and SOFA score, with comparable performance, were the best predictors of UO and in-hospital mortality among the different SAH scores. The performance of such scores to predict DCI remained limited.

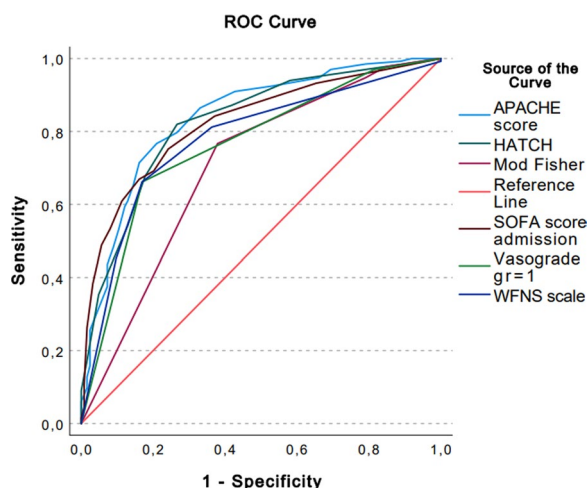

Figure 1 (abstract 001210) .

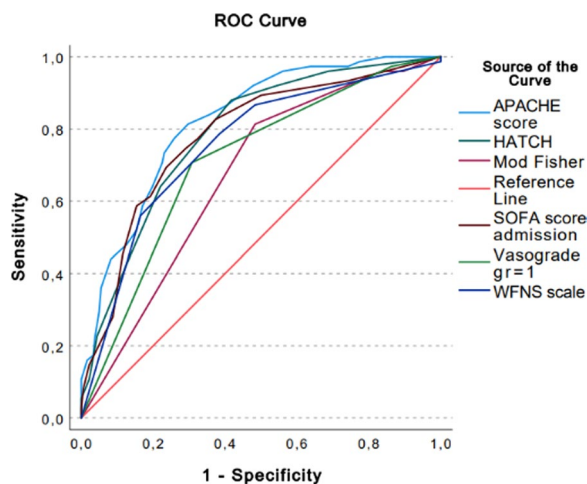

Figure 2 (abstract 001210) .

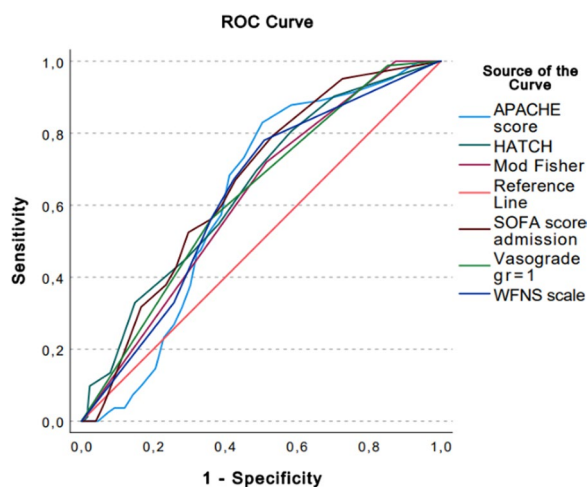

Figure 3 (abstract 001210)

Topic: Neurointensive care

001211

Nutrition therapy in obese: how do we do? Preliminary results of the ENPIC study

J.C. Lopez-Delgado¹, L. Bordejé², E. Mor-Marco³, E. Portugal Rodríguez⁴, I. Martínez De Lagrán Zurbano⁵, C. Lorencio Cárdenas⁶, P. Vera-Artazcoz⁷, C. Gonzalez-Iglesias⁸, L. Mateu Campos⁹, T. Grau-Carmona¹⁰, J. Trujillano-Cabello¹¹, J. F. Martínez Carmona¹², J. L. Flordelis Lasiera¹³, L. Servia-Goixart¹⁴

¹Intensive care, Hospital Universitari de Bellvitge, L'Hospitalet de Llobregat, Spain; ²Intensive care unit, Hospital Germans Trias i Pujol, Badalona, Spain; ³Intensive care, Hospital Germans Trias i Pujol, Badalona, Spain; ⁴Intensive care, Hospital Clínico, Valladolid, Spain; ⁵Intensive care unit, Hospital de Mataró, Mataró, Spain; ⁶Intensive care medicine, Hospital Universitari de Girona Dr Josep Trueta, Girona, Spain; ⁷Intensive care, Hospital Sant Pau, Barcelona, Spain; ⁸Intensive care, Hospital de Barbastro, Barbastro, Huesca, Spain; ⁹Intensive care unit, Hospital General Universitario de Castellón, Castellón de la Plana, Spain; ¹⁰Intensive care, Hospital 12 de Octubre, Madrid, Spain; ¹¹Intensive Care Unit, Hospital Universitari Arnau de Vilanova, Lleida, Spain; ¹²Intensive care unit, Hospital Carlos Haya, Málaga, Spain; ¹³Intensive care, University Hospital October 12, Madrid, Spain; ¹⁴Intensive care, Hospital Arnau de Vilanova, Lleida, Spain

Correspondence: J.C. Lopez-Delgado

Intensive Care Medicine Experimental 2023, **11 (Suppl 1)**:001211

Introduction: The requirements of nutrition therapy in the obese are different due to their anthropometric and metabolic characteristics from other ICU patients.

Objectives: The aim of this pilot study is to evaluate the adequacy of the caloric and protein intake in obese, as well as the number of associated complications with nutrition therapy in these patients.

Methods: Multicenter prospective observational study (n=38) (NCT: 03634943) that included patients who needed nutrition therapy. Patients were classified according to body mass index (BMI) as: normal (18.5–24.9 kg·m⁻²), overweight (25–29.9 kg·m⁻²) and obese (≥ 30 kg·m⁻²). Demographic data, comorbidities, nutritional status, nutrition therapy first 14 days and its complications, together with supportive therapy, were recorded in a database (RedCAP®). Univariate and multivariate analysis were performed by SPSS 25.0.

Results: A total of 525 patients were included, of whom 165 (31.4%) had a normal BMI, 210 (40%) were overweight, and 150 (28.6%) were obese. The majority were medical patients (63.8%), received early nutrition therapy (74.9%) and a large proportion were at nutritional risk (mNUTRIC > 4 = 44.4%). The obese had a higher incidence

of hypertension (normal:33.9%, overweight:41.9%, obese:56.7%; p<0.001) and diabetes (normal:21.2%, overweight:20%, obese:36%; p=0.001).

The mean caloric and protein intake was 19±5.6 kcal/Kg/d and 1±0.4 g/Kg/d respectively in the entire sample. A lower caloric (normal:20.7±4.8, overweight:18.1±3.6, obese:14.2±4.3 kcal/Kg/d;p<0.001) and protein intake (normal:1.1±0.3, overweight:1±0.3, obese) was observed (normal:1.1±0.3, overweight:1±0.3, obese:0.7±0.2 g/Kg/d;p<0.001) with the increase in BMI. However, obese patients were those who received a better adequacy (>70% administered requirements) of caloric intake (normal:80%, overweight:61.4%, obese:86%) in relation to the overweight patient (p=0.001), while protein intake was clearly lower (normal:81.8%, overweight:60%, obese:43.3%;p<0.001). There were no differences regarding complications related to nutritional therapy, although the incidence of complications was low (11.6%), as well as the needs for life support and ICU mortality. The multivariate analysis found that obese patients showed worse protein intake compared to patients with normal (HR:0.72; 95% CI:0.65–0.85;p=0.007) and overweight (HR:0.86; 95% CI:0.72–0.96;p=0.01).

Conclusions: In our study, an insufficient protein intake was observed in the critically ill obese patient. Strategies should be developed to optimize protein intake in these patients.

References

- Dickerson RN, et al. Obesity and critical care nutrition: current practice gaps and directions for future research. *Crit Care*. 2022;26:283. <https://doi.org/10.1186/s13054-022-04148-0>.

Topic: Metabolism, endocrinology, liver failure and nutrition

001212

How are our VIPs doing in the ICU?

M.N. Simoes¹, S. Ferreira¹, M. Pereira¹, LM. Afonso¹, E. Gomes¹, R. Araújo¹
¹Department of Emergency Medicine and Intensive Care, Hospital Pedro Hispano, Matosinhos, Portugal

Correspondence: M.N. Simoes

Intensive Care Medicine Experimental 2023, **11 (Suppl 1)**:001212

Introduction: As life expectancy increases, the geriatric population is also rising, accounting for the fastest growing subset of the total population. In the US, segments older than 85 years are growing by almost 232%. Therefore, the number of elderly patients older than 80 years admitted to an ICU is also increasing—VIPs, estimated to be up to 25% of the total ICU admissions.

Objectives: Due to their age and the presence of common geriatric syndromes such as frailty, cognitive decline, reduced activity of daily life, and several comorbid conditions, this group is particularly challenging. Hence, the aim of this study is to identify the benefit of ICU admission, in terms of survival rate, for the very old (≥ 80 years).

Methods: A retrospective study was conducted, including patients admitted to the ICU between January of 2017 and June 2022. In addition to mortality (divided into within ICU stay, within hospitalization after ICU discharge, up to 1 year after hospital discharge, after 1 year after hospital discharge); age, sex, Clinical Frailty Score (CFS), age-adjusted Charlson Comorbidity Index (CCI), SAPS II, length of stay, if organ support was given (ventilation, vasoactive drugs or renal replacement therapy) and whether limitations of treatment were established during the ICU stay were also registered.

Results: A total of 245 patients with a median age of 83 years (P25-P75 81–85 years) were included in the final analysis, 141 (57.6%) were male and an average length of ICU stay of 4.45 days (SD 4.3 days). On admission, 196 patients (80%) had a CFS 4, 108 patients (44%) had an age-adjusted CCI 6 and SAPS II average of 45.7. During ICU stay 43.4% of the patients did not receive organ support. Overall, we observed a 49.4% survival rate; ICU mortality of 26.1%, hospitalization mortality after ICU discharge of 6.5%, mortality up to 1 year after discharge of 9% and mortality after 1 year of discharge accounting for 7.8%. A multiple linear regression was conducted between mortality up to 1 year after hospital discharge and other variables registered: ventilation

support and SAPS II demonstrating predictive value of mortality up to 1 year (adjusted R square 0.129, ANOVA significance < 0.001 with ventilation support significance < 0.001 and SAPS II significance 0.033).

Conclusions: Among the very old admitted to the ICU, half survived the ICU stay and almost two-thirds had a survival rate of up to 1 year after hospital discharge. We found that ventilation support, likely due to being a marker of disease severity but also related to complications, correlated with higher mortality up to 1 year after discharge. In addition, the data suggests a relationship between SAPS II and mortality up to 1 year after hospital discharge, as seen in other studies. However, this severity score, based on physiological data and age, may be limited in this portion of the population and the decision should always be individualized, weighing the risks and benefits associated with admission to the ICU for each patient.

References

1. "Elderly Patients in the Intensive Care Unit", Hans Flaatten, Michael Beil, Bertrand Guidet (2020)
2. "Critically ill patient mortality by age: long-term follow-up (CIMbA-LT)", João Gonçalves-Pereira, André Oliveira, Tatiana Vieira, Ana Rita Rodrigues, Maria João Pinto, Sara Pipa, Ana Martinho, Sofia Ribeiro and José-Artur Paiva (2023)
3. "The Mobility and Impact of Frailty in the Intensive Care Unit", Bellal Joseph, MD, Faisal S. Jehan, MD (2017)

Topic: Critical care organisation, quality management, information systems, outcomes

001214

Using simplified criteria for ventilator-associated events outperforms performance: a secondary analysis from a multicentric, prospective adults' cohort

S. Ramirez-Estrada¹, Y. Peña-López², M. Serrano-Megías², D. Koulenti³, J. Rello²

¹Intensive Care Department, Hospital Sanitas CIMA, Barcelona, Spain;

²Clinical Research/Epidemiology in Pneumonia and sepsis -CRIPS, Vall d'Hebron Research Institute, Barcelona, Spain; ³The university of queensland centre for clinical research, The University of Queensland, Brisbane, Australia

Correspondence: J. Rello

Intensive Care Medicine Experimental 2023, **11** (Suppl 1):001214

Introduction: The Ventilator-Associated Events (VAE) paradigm broadens the surveillance of preventable complications associated with mechanical ventilation (MV) beyond infections, with greater prediction accuracy for outcomes than ventilator-associated pneumonia. However, many ventilator-associated respiratory infections are dismissed as well as other common complications in ventilated patients such as atelectasis and pulmonary fluid overload. A recent study by our group using slighter thresholds to detect VAE in pediatric patients detected more than the double of events while maintaining its impact in outcomes.

Objectives: To assess whether using less restrictive criteria to detect VAE could improve the algorithm's sensitivity keeping its capability to predict outcomes.

Methods: Secondary analysis of a prospective, international, multi-centre cohort study in 11 Intensive Care Units (ICU) from 4 European countries. Adult patients ventilated ≥ 48 h were eligible. **VAE** was defined as a sustained increase by ≥ 0.2 in the fraction of inspired oxygen (FiO₂) or ≥ 3 cmH₂O in the positive end-expiratory pressure (PEEP) for ≥ 2 days, with a previous baseline period of ≥ 2 days of stability or improvement. Three less restrictive definitions for VAE were proposed: 1) **Light-VAE:** sustained increase for ≥ 1 days in FiO₂ ≥ 2 or PEEP ≥ 2 cmH₂O or FiO₂ ≥ 0.15 plus PEEP ≥ 1 cmH₂O; 2) **VAE24:** VAE respiratory settings criteria sustained for ≥ 1 day; 3) **Light-VAE48:** Light-VAE respiratory settings criteria sustained for ≥ 2 days. Patients not following those criteria served as each type of VAE comparison group. Mortality, duration of MV and ICU length of stay (LOS) were the main outcomes end-points.

Results: A total of 2,706 ventilator-days among 261 adults ventilated > 48 h were analysed. Overall mortality was 35%. The duration of MV and ICU and LOS in the entire cohort (median, IQR) were 10 (5–21) and 14 (8–26) days, respectively. Incidence (per 1,000 ventilator-days) increased from 24 episodes for standard VAE, to 35 (145%), 41 (170%) and 55 (229%) for Light-VAE48, VAE24 and LightVAE, respectively. No significant mortality differences were identified. In contrast with standard VAE, extra (median) MV days increased from 10 to 25, 23, 22 days and extra ICU LOS from 14 to 25, 26, 28 days, respectively.

Conclusions: The use of less restrictive criteria to detect VAE among ventilated adults improved the sensibility of the algorithm while maintaining a significant impact on outcomes. Our findings support to update the tier using less restrictive VAE criteria over 48 h.

References

1. Centers for Disease Control and Prevention: National healthcare Safety Network. Ventilator-Associated Event (VAE), https://www.cdc.gov/nhsn/pdfs/pscmanual/10-vae_final.pdf; 2022 [accessed 04 April 2023].
2. Ramirez-Estrada S, Lagunes L, Peña-López Y, et al. Assessing predictive accuracy for outcomes of ventilator-associated events in an international cohort: the EUVAE study. *Intensive Care Med.* 2018;44 (8):1212–1220. <https://doi.org/10.1007/s00134-018-5269-7>
3. Ventilator-associated events in children: A multicentre prospective cohort study. Peña-López Y, Campins-Martí M, Slöcker-Barrio M, Bustinza A, Alejandre C, Jordán-García I, Ortiz-Álvarez A, et al. *Anaesth Crit Care Pain Med.* 2022;41 (3):101,072.
4. Supported in part by European society of clinical microbiology and infectious diseases, Study Group for Infections in Critically Ill Patients—ESCMID- ESGCIP
5. On behalf of EUVAE Study Investigators.

Topic: Acute respiratory failure and mechanical ventilation

001216

Microwave technology to detect traumatic chest injuries in a porcine model

P. Seidel¹, NP. Oveland¹, M. Oropeza-Moe², L. Nguyen³, A. Fhager³, M. Persson³, M. Elam⁴, S. Candefjord³

¹Department of Quality and Health Technology, Faculty of Health Sciences, University of Stavanger, Stavanger, Norway; ²Department of Production Animal Clinical Sciences, Faculty of Veterinary Medicine, Norwegian University of Life Sciences NMBU, Sandnes, Norway; ³Department of Electrical Engineering, Chalmers University of Technology, Gothenburg, Sweden; ⁴Institute of neuroscience and physiology, Gothenburg University, Gothenburg, Sweden

Correspondence: P. Seidel

Intensive Care Medicine Experimental 2023, **11** (Suppl 1):001216

Introduction: Major chest trauma is a leading cause of trauma-related death. (O'Connor and Adamski, 2010) A particularly life-threatening injury is traumatic hemopneumothorax (HPTX), but its diagnosis in the prehospital settings is challenging. (DeMasi et al., Netherton et al., 2019, Wilkerson and Stone, 2010) Microwave technology (MWT) has demonstrated the potential to detect free blood and air in the body by detecting changes in the microwave electromagnetic field caused by distinct dielectric properties of biological tissues. (Ahdi Rezaeieh et al., 2017, Christopoulou and Koulouridis, 2015, Candefjord et al., 2021, Fhager et al., 2018) MWT shows promise as a complementary diagnostic approach to existing methods.

Objectives: This study evaluated the effectiveness of MWT in assessing traumatic chest injuries in a porcine model of HPTX.

Methods: As part of a larger experiment evaluating MWT for assessing thoracic and abdominal injuries, this study was conducted in accordance with national legislation and with ethical approval from the Norwegian Food Safety Authority (Approval no. 11933). Ten female, prepubertal hybrid Duroc x Landrace/ Yorkshire (DDYL) pigs (63.7 \pm 5.0 kg) were sedated and mechanically ventilated. To induce increasing levels of HPTX, blood (750 mL) was drawn from an arterial line placed in the femoral artery and consecutive volumes of air (50–1500 mL) were injected into the left thorax via a three-way stopcock

placed through a mini-thoracotomy. A wearable MWT device with eight antennas (A–H) was placed around the thorax (Figure 1), and all combinations of antenna pairs were measured in an automated fashion in a frequency range of 0.1–2 GHz. The resulting 36 coefficients were analysed for variation in magnitude (MAGN). A support vector machine (SVM) was used as a machine learning method to discriminate HPTX from baseline. Finally, the animals were euthanised under deep anaesthesia.

Results: The observed reduction in MAGN in the 0.6–2 GHz frequency range was significant for all stages of HPTX, with a correlation between HPTX volume and damping of the microwave signal. The most severe HPTX showed the greatest reduction in MAGN, up to 5 dB. The variance of the measurements depended on the MAGN of the signal, with higher variance in signals with lower MAGN and more severe HPTX. While the average variance for signals with high MAGN was 1%, some signals showed variations up to 10%. Classification analysis showed the highest accuracy when using all coefficients as input data, resulting in a sensitivity and specificity of 90% to correctly detect HPTX.

Conclusions: This is the first study evaluating a wearable MWT device for detecting traumatic chest injuries in a porcine model. Our results show that HPTX significantly alters microwave signals. The degree of alteration depends on the severity of the HPTX. Using an SVM, we achieved a high degree of accuracy in discriminating between healthy and HPTX conditions. However, our results are limited by high signal variance, which tends to increase in severe cases of HPTX, probably due to extensive physiological and anatomical changes and crosstalk phenomena between nearby antennas. (Candefjord, 2017, Candefjord et al., 2021) To improve and validate the classifier algorithm, further hardware improvements and larger subject numbers are needed before clinical trials can begin.

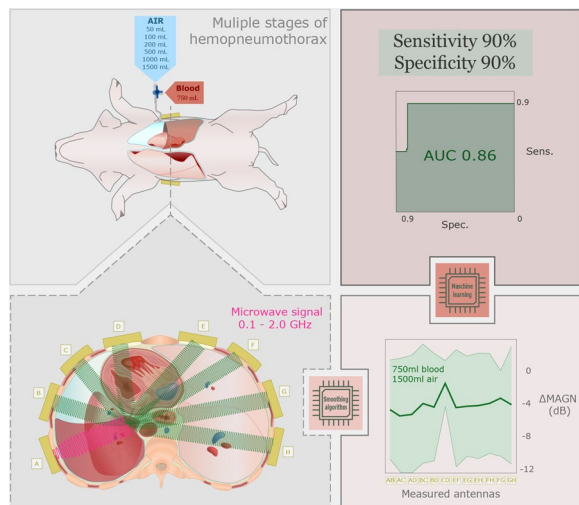

Figure 1 (abstract 001216) Schematic representation of the experimental setup and results

References

1. Medfield Diagnostics AB contributed with equipment and technical support.
2. AF and MP are shareholders in Medfield Diagnostics AB.
3. AHDI REZAEIEH, S., ZAMANI, A., BIALKOWSKI, K. S. & ABBOSH, A. M. 2017. Novel Microwave Torso Scanner for Thoracic Fluid Accumulation Diagnosis and Monitoring. *Scientific Reports*, 7, 304.
4. CANDEFJORD, S., NGUYEN, L., BUENDIA, R., OROPEZA-MOE, M., ANDERSEN, N. G., FHAGER, A., PERSSON, M., ELAM, M. & OVELAND, N. P. 2021. A wearable microwave instrument can detect and monitor traumatic abdominal injuries in a porcine model. *Scientific Reports*, 11, 23,220.
5. CANDEFJORD, S., WINGES, J., MALIK, A.A., YU, Y., RYLANDER, T., MCKELVEY, T., FHAGER, A., ELAM, M., PERSSON, M. 55 (8) 2017. Microwave technology

- for detecting traumatic intracranial bleedings: Tests on phantom of subdural hematoma and numerical simulations. *Med Biol Eng Comput*, 55, 1177–1188. CHRISTOPOULOU, M. & KOULOURIDIS, S. 2015. Inter-subject variability evaluation towards a robust microwave sensor for pneumothorax diagnosis. *Progress In Electromagnetics Research*, 42, 61–70.
6. CHRISTOPOULOU, M. & KOULOURIDIS, S. 2015. Inter-subject variability evaluation towards a robust microwave sensor for pneumothorax diagnosis. *Progress In Electromagnetics Research*, 42, 61–70.
7. DEMASI, S., PARKER, M. S., JOYCE, M., MULLIGAN, K., FEESER, S. & BALDERSTON, J. R. Thoracic point-of-care ultrasound is an accurate diagnostic modality for clinically significant traumatic pneumothorax. *Academic Emergency Medicine*.
8. FHAGER, A., CANDEFJORD, S., ELAM, M. & PERSSON, M. 2018. Microwave Diagnostics Ahead: Saving Time and the Lives of Trauma and Stroke Patients. *IEEE Microwave Magazine*, 19, 78–90.
9. NETHERTON, S., MILENKOVIC, V., TAYLOR, M. & DAVIS, P. J. 2019. Diagnostic accuracy of eFAST in the trauma patient: a systematic review and meta-analysis. *CJEM*, 21, 727–738.
10. O'CONNOR, J. & ADAMSKI, J. 2010. The Diagnosis and Treatment of Non-Cardiac Thoracic Trauma. *Journal of the Royal Army Medical Corps*, 156, 5–14.
11. WILKERSON, R. G. & STONE, M. B. 2010. Sensitivity of bedside ultrasound and supine anteroposterior chest radiographs for the identification of pneumothorax after blunt trauma. *Acad Emerg Med*, 17, 11–7.
12. The authors received no financial support for the research, authorship, and/or publication of this abstract

Topic: Trauma

001217

Acute stroke in aged brain: should we reperfuse?

J. Martins¹, A. Silva¹, T. Guimarães¹, M. Monteiro¹, A. Pereira¹, P. Matos¹, MG. Campello¹

¹Intensive Care Medicine, Centro Hospitalar Tâmega e Sousa, Penafiel, Portugal

Correspondence: J. Martins

Intensive Care Medicine Experimental 2023, **11 (Suppl 1)**:001217

Introduction: International guidelines specify no upper age limit for reperfusion therapies in acute ischemic stroke. Albeit, there are uncertainties about the clinical benefit of these therapies in very old population, as older age is a strong independent predictor of poor outcome.

Objectives: This study aims to identify the impact of reperfusion therapies (RT) on the functional outcome and mortality of very old patients.

Methods: Observational retrospective study analysing the group of very old patients (aged 80 years or older) with acute ischemic stroke admitted in the emergency room of a tertiary hospital, between January 1st and December 31st 2022. We collected demographic data, degree of disability/dependence pre-stroke (modified Rankin Scale—mRS), admission stroke severity (National Institutes of Health Stroke Score—NIHSS), RT (intravenous thrombolysis and/or mechanical thrombectomy), mortality and functional outcome (worsening ≥ 2 of mRS) at hospital discharge and at 3th month. Statistical analysis was performed with SPSS, version 27. We performed Chi-square and Fisher's exact tests; Mann–Whitney and Kruskal–Wallis tests. We also performed multivariate logistic regressions. Significance was set at $p < 0.05$.

Results: During the referral period, 251 patients were admitted in the emergency room with acute ischemic stroke and 91 (36.3%) of them were very old patients, of which 36 (39.6%) were males with a median age of 86.0 years (IQR: 84.0–89.0). The median mRS was 1.0 (IQR: 0.0–2.0) and the median NIHSS was 13.0 (IQR: 5.0–20.0). Reperfusion therapy was performed on 34.1% ($n = 31$).

We did not find significant association between RT and death ($p = 0.944$) or worse functional outcome ($p = 0.777$) at hospital discharge. After 3 months we also did not find statistical relation between RT and death ($p = 0.978$) or worse functional outcome ($p = 0.966$). Considering each type of RT, it maintains the lack of statistical relation with poststroke outcome (death at discharge $p = 0.898$ and at 3 months $p = 0.373$).

In multivariate logistic regressions, even when adjusted for age, mRS and NIHSS, RT was not statistically significant for mortality increase or worse functional outcome. When considering mortality at hospital discharge, only NIHSS was statistically significant ($p=0.002$, OR 1.12, IC [1.04; 1.21]). Analysing the decline in functional outcome at hospital discharge and at 3th month, only the mRS ($p=0.003$, OR 0.51, IC [0.33; 0.80]; $p=0.011$, OR 0.52, IC [0.31; 0.86], respectively) and NIHSS ($p=0.001$, OR 1.14, IC [1.05; 1.23]; $p=0.020$, OR 1.12, IC [1.02; 1.24], respectively) were statistical significant.

Conclusions: In our hospital there is no upper age limit for RT in acute ischemic stroke, according to international guidelines^{1,2}. In the cohort of our study, RT was not associated with higher mortality or worse functional outcome. Stroke severity (NIHSS) was an essential predictor of poststroke outcomes, in agreement with the literature³. Hence, our study indicates there may be no reason to withhold RT based merely on age.

References

3. Rost NS, Bottle A, Lee JM, Randall M, Middleton S, et al. (2016). Stroke Severity Is a Crucial Predictor of Outcome: An International Prospective Validation Study. *Journal of the American Heart Association*, 5:e002433. <https://doi.org/10.1161/JAHA.115.002433>
2. Berge E, Whiteley W, Audebert H, Marchis GM, Fonseca AC, et al. (2021). European Stroke Organisation (ESO) guidelines on intravenous thrombolysis for acute ischaemic stroke. *European Stroke Journal*. <https://journals.sagepub.com/doi/10.1177/2396987321989865>
1. Powers WJ, Rabinstein AA, Ackerson T, Adeoye OM, Bambakidis NC, et al. (2019). Guidelines for the Early Management of Patients With Acute Ischemic Stroke: 2019 Update to the 2018 Guidelines for the Early Management of Acute Ischemic Stroke: A Guideline for Healthcare Professionals From the American Heart Association/American Stroke Association. *Stroke*, 50:e344–e418. <https://www.ahajournals.org/doi/10.1161/STR.0000000000000211>
- Acknowledgement to: Isabel J. Pereira, M.D. Intensive care medicine service, Centro Hospitalar de Vila Nova de Gaia-Espinho, CRITIC ALMED—CINTESIS—Center for Health Technology and Services Research, Porto, Portugal.

Topic: Neurointensive care

001222

Thoracic ultrasound evaluation for assisting extubation in COVID-19 patients—preliminary study

L. C. Madeira¹, G. H. Schuster¹, B. Conte¹, L. A. Nasi¹, J. Maccari¹, F. Dexheimer¹, P. D. T. R. Dalcin²

¹Unidade de Terapia Intensiva, Moinhos de Vento Hospital, Porto Alegre, Brazil; ²Serviço de Pneumologia do Hospital de Clínicas de Porto Alegre, Hospital de Clínicas de Porto Alegre, Porto Alegre, Brazil

Correspondence: G.H. Schuster

Intensive Care Medicine Experimental 2023, **11** (Suppl 1):001222

Introduction: The decision to extubate patients on mechanical ventilation is associated with a risk of failure, with up to 20–30% of patients requiring re-intubation (1–4). During the COVID-19 pandemic, this decision became even more challenging due to concerns about contamination risks and limitations in non-invasive ventilation. Thoracic ultrasound (TU), including lung ultrasound score (LUS) and diaphragm quantitative evaluation, is a safe and non-invasive technique (5) that has shown promise in previous studies for aiding decision-making in weaning. The hypothesis of this study was that thoracic ultrasound would have good diagnostic accuracy in predicting extubation failure within 72 h, and would evaluate the relationship between LUS and diaphragm function, both of which are associated with weaning.

Methods: A preliminary analysis was conducted in a prospective study that included ventilated patients admitted to a medical ICU at Hospital Moinhos de Vento in Porto Alegre, Brazil. Inclusion criteria were acute respiratory failure due to COVID-19 infection with mechanical

ventilation for over 48 h. After a successful spontaneous breathing test (SBT), LUS, diaphragm excursion (DE), and diaphragm thickening fraction (DTF) were measured. The primary outcome was to determine whether TU could predict extubation failure.

Results: Twenty-seven patients were included in the study from March 2020 to March 2022. Eight (29.6%) patients experienced extubation failure, 18 (66.7%) were male, median age was 53 (IQR 25%–75%: 46–74), and median ICU length of stay was 36 (IQR 25%–75%: 23–60) days. Seven (87.5%) patients who failed extubation had LUS scores of 24 or higher, with a p -value of 0.03. There were no statistically significant differences observed in the comparison of mean values for DE (failure 2.28 cm and success 2.09 cm— p 0.54; CI – 0.4677 to 0.8704), DTF (failure 0.29 cm and success 0.27 cm— p 0.75; CI – 0.0960 to 0.1305), and mechanical ventilation time (p 0.42; CI –3.083 to 7.162). LUS and DE did not show a linear association ($R^2=0.04$), nor did LUS with DTF ($R^2=0.07$) or DE with DTF ($R^2=0.01$). In the multivariate analysis with covariate correction, age and length of hospital stay were the variables that contributed the most to extubation failure, and LUS was not significant. However, with a larger sample size, this scenario may change. The data are a partial analysis of an ongoing study.

Conclusions: A Lung Ultrasound Score (LUS) of 24 or higher was found to be a good cutoff point for predicting extubation failure in COVID-19 patients, based on preliminary data analysis.

References

- González-Aguirre JE, et al. Pulmonary Ultrasound and Diaphragmatic Shortening Fraction Combined Analysis for Extubation-Failure-Prediction in Critical Care Patients. *Arch Bronconeumol*. 2018. <https://doi.org/10.1016/j.arbres.2018.09.015>
- Sellares J, Ferrer M, Cano E, Loureiro H, Valencia M, Torres A. Predictors of prolonged weaning and survival during ventilator weaning in a respiratory ICU. *Intensive Care Med* 2011;37:775–784
- Thille AW, Harrois A, Schortgen F, Brun-Buisson C, Brochard L. Outcomes of extubation failure in medical intensive care unit patients. *Crit Care Med* 2011;39:2612–2618
- Epstein SK, Ciubotaru RL, Wong JB. Effect of failed extubation on the outcome of mechanical ventilation. *Chest* 1997;112:186–192
- Esteban A, Alía I, Gordo F, Fernández R, Solsona JF, Vallverdú I, Macías S, Allegue JM, Blanco J, Carriedo D, et al.; The Spanish Lung Failure Collaborative Group. Extubation outcome after spontaneous breathing trials with T-tube or pressure support ventilation. *Am J Respir Crit Care Med* 1997;156:459–465.

Topic: Acute respiratory failure and mechanical ventilation

001223

Themodilution-guided therapy in simultaneous pancreas-kidney transplant

M. Batista¹, M. Barbosa², C. Pires³, SC. Espírito⁴, BS. Pilar⁵, J. Henriques⁶, C. José², S. Cardoso², T. Isidoro Duarte⁷, F. Caeiro⁵, N. Germano⁸

¹Unidade de Cuidados Intensivos Polivalente 7, Centro Hospitalar Universitário de Lisboa Central, Lisbon, Portugal; ²Unidade de Cuidados Intensivos Polivalente 7, Hospital Curry Cabral, Lisboa, Portugal; ³Ucip 7, Hospital Curry Cabral, CHULC, Lisboa, Portugal; ⁴Intensive care unit, Hospital Curry Cabral; Centro Hospitalar Universitário de Lisboa Central, Lisboa, Portugal; ⁵Nefrologia, Hospital Curry Cabral, Lisboa, Portugal; ⁶Unidade de Cuidados Intensivos (UCIP7), Centro Hospitalar Universitário Lisboa Central, Lisboa, Portugal; ⁷Intensive Care Medicine Department, Hospital Curry Cabral, Lisboa, Portugal; ⁸Intensive care medicine department, Curry Cabral Hospital, Central Lisbon Hospital Center, Lisbon, Portugal

Correspondence: M. Batista

Intensive Care Medicine Experimental 2023, **11** (Suppl 1):001223

Introduction: Optimal fluid balance is an essential part of organ perfusion management, namely in pancreas-kidney graft transplantation. Traditionally, a high positive fluid balance is implemented in order

to ameliorate renal graft function. PiCCO® (Pulse index Continuous Cardiac Output) is an advanced haemodynamic monitoring device capable of evaluating cardiac output and preload. We established a protocol based on global end-diastolic index (GEDI), extravascular lung water index (ELWI) and diuresis in order to guide the immediate post-operative period in this type of patients.

Objectives: Evaluate the effect of PiCCO®-guided fluid balance in reno-pancreatic graft survival and delayed graft function.

Methods: A total of 64 simultaneous pancreas-kidney transplants were performed in our transplant center between 2017 and 2022. The patients were divided in two retrospective cohorts regarding fluid balance protocol. Group 1 received liberal continuous fluid infusion based on urine output >200 mL/h (n=28) whereas in Group 2 fluid balance was guided by PiCCO® monitoring (n=36) targeting normovolemia. All patients received induction with methylprednisolone and thymoglobulin and maintenance of immunosuppression with glucocorticoid, mycophenolic acid and tacrolimus.

Results: Mean fluid balance in the first 24 and 48 h was higher in Group 1 (4172 mL vs 3441 mL, p=0,169; 2945 mL vs 2839 mL, p=0,853). At day 3, there was a different trend, fluid balance was greater in Group 2 (691 mL vs 1295 mL, p=0,236). Mean cumulative fluid balance in the first 72 h was significantly higher in Group 2 (7436 mL vs 9704 mL, p=0,027). Mean P/F ratio was similar between the two groups in the first 24 and 48 h (447 vs 376, p=0,766; 336 vs 343, p=0,810), whereas on day 3 it was significantly higher in Group 2 (296 vs 304, p=0,033). We documented a similar renal graft survival (88,2% vs 91,7%, p=0,369) but a relevant increase in pancreas graft survival in Group 2 (73,9% vs 87,5%, p=0,641). Renal delayed graft function had a meaningful decrease in Group 2 (22,7% vs 9%, p=0,253); multivariate analysis revealed that renal cold ischemia time did not predict delayed graft function. No significant differences were found in biochemical values such as glomerular filtration rate and C-peptide. Hospital mortality was similar between the two groups.

Conclusions: Fluid management is an important factor known to affect delayed graft function and long-term transplant outcomes. The difficulty lies in achieving the best preload and graft perfusion without the deleterious effect of hypervolemia. Our six year cohort reports an increase in graft survival and decrease in delayed renal graft function, with higher P/F ratios, suggesting that PiCCO® monitoring might be beneficial to attain the optimal fluid balance tailored for each patient.

References

- Alkouny A, Alharbi M, Altheaby A, Aboalsamh A, Fayed A. Crystalloid fluids and delayed graft function in kidney transplant: A cohort study. *Saudi Journal of Anesthesia*. 2022 Jun; 16 (1):38–44.
- Litton E, Morgan M. The PiCCO monitor: a review. *Anaesth Intensive Care*. 2012 May;40 (3):393–409. <https://doi.org/10.1177/0310057X1204000304>. PMID: 22,577,904.
- The authors received no financial support for the research, authorship, and/or publication of this article.

Topic: Brain death, organ donation and transplantation

001224

Unfractionated Heparin infusion in simultaneous pancreas-kidney transplantation

M. Barbosa¹, M. Batista², S. C. Espirito³, C. Pires⁴, B. S. Pilar⁵, J. Henriques², C. José¹, S. Cardoso⁴, T. Isidoro Duarte⁶, F. Caeiro⁵, N. Germano⁷

¹Unidade de Cuidados Intensivos Polivalente 7, Hospital Curry Cabral, Lisboa, Portugal; ²Unidade de Cuidados Intensivos Polivalente 7, Centro Hospitalar Universitário de Lisboa Central, Lisbon, Portugal; ³Intensive care unit, Hospital Curry Cabral; Centro Hospitalar Universitário de Lisboa Central, Lisboa, Portugal; ⁴Ucip 7, Hospital Curry Cabral, CHULC, Lisboa, Portugal; ⁵Nefrologia, Hospital Curry Cabral, Lisboa, Portugal; ⁶Intensive Care Medicine Department, Hospital Curry Cabral, Lisboa, Portugal; ⁷Intensive care medicine department, Curry Cabral Hospital, Central Lisbon Hospital Center, Lisbon, Portugal

Correspondence: M. Barbosa

Intensive Care Medicine Experimental 2023, **11 (Suppl 1)**:001224

Introduction: Simultaneous pancreas-kidney transplantation is an accepted procedure for the treatment of Type I diabetic patients with end-stage renal disease. Pancreatic graft thrombosis remains one of the most frequent causes for transplant loss. In order to prevent this complication, we implemented an anticoagulation protocol using unfractionated heparin (UFH) infusion guided by the activated partial thromboplastin time (aPTT) ratio.

Objectives: Evaluate the effect of UFH infusion on thrombotic and hemorrhagic complications, one year graft survival and overall survival in simultaneous pancreas-kidney transplantation.

Methods: A total of 64 simultaneous pancreas-kidney transplants were performed in our center between 2017 and 2022. The patients were divided in two retrospective cohorts regarding heparin infusion protocol. Group 1 was submitted to aspirin from day one and prophylactic low molecular weight heparin (LMWH) while Group 2 was under aspirin and UFH infusion targeting an aPTT ratio of 1.5. All patients received induction with methylprednisolone and thymoglobulin and maintenance of immunosuppression with glucocorticoid, mycophenolic acid and tacrolimus. Hemorrhagic complications were defined as having at least three blood transfusions in one day, the need for emergent surgical intervention and hemorrhagic shock, which led to temporary suspension of anticoagulation therapy.

Results: An important decrease in pancreas graft thrombosis was found in Group 2 (17,9% vs 5,6%, p=0,167); as well as a reduction in renal thrombosis (7,1% vs 5,6%, p=0,817). We report higher hemorrhagic complications in Group 2 (28,5% vs 38,9%, p=0,262): one gastrointestinal hemorrhage, one hemorrhage from the surgical incision and twelve hemoperitoneum; of these 64.3% (n=9) required exploratory laparotomy. The median day of hemorrhage was similar in both groups (2 vs 4, p=0,111). Median number of overall packed red blood cells transfusion was comparable (3,5 vs 2,0, p=0,334), however, blood transfusions were significantly higher in the first 24 h in Group 1 (1,63 vs 0,57, p=0,044) and in day four in Group 2 (0,00 vs 0,41, p=0,001). We documented a relevant increase in pancreas graft survival (73,9% vs 87,5%, p=0,641), and similar renal graft survival (88,2% vs 91,7%, p=0,369). Hospital mortality was similar between the two groups.

Conclusions: Given the intrinsically low parenchymal microvasculature flow of the pancreas and the hypercoagulable state of the diabetic recipient, these patients are at a higher risk of graft thrombosis than other abdominal organ transplants. Currently there is no standardized protocol for the prevention of graft thrombosis, but it is believed most transplant centers use some form of anticoagulation. In spite of the increased number of hemorrhagic complications, our results demonstrate the effect of UFH on improving graft survival which is in line with published literature.

References

- Kukla A, Ventura-Aguiar P, Cooper M, de Koning EJP, Goodman DJ, Johnson PR, Han DJ, Mandelbrot DA, Pavlakis M, Saudek F, Vantuyghem MC, Augustine T, Rickels MR. Transplant Options for Patients With Diabetes and Advanced Kidney Disease: A Review. *Am J Kidney Dis*. 2021 Sep;78 (3):418–428. <https://doi.org/10.1053/j.ajkd.2021.02.339>. Epub 2021 May 14. PMID: 33,992,729; PMCID: PMC8606031.
- Li E, Farrokhi K, Offerri J, Luke J, Luke P, Sener A. Heparin Thromboprophylaxis in Simultaneous Pancreas-Kidney Transplantation: A Systematic Review and Meta-Analysis of Observational Studies. 2023. *Transpl Int* 36: 10,442.
- The authors received no financial support for the research, authorship, and/or publication of this article.

Topic: Transfusion and haemostasis disorders

001228

Hepatorenal syndrome in patients with acute-on-chronic liver failure: are we identifying it correctly?

J. Henriques¹, M. Batista¹, M. Barbosa¹, T. Isidoro Duarte¹, T. Sequeira¹, N. Germano¹

¹Intensive Care Medicine Department, Hospital Curry Cabral, Lisboa, Portugal

Correspondence: J. Henriques

Intensive Care Medicine Experimental 2023, 11 (Suppl 1):0001228

Introduction: Acute-on-chronic liver failure (ACLF) is a serious condition defined as acute hepatic decompensation, which develops in patients with cirrhosis, leading to multiorgan failure, and high risk of short-term mortality. (1) Among these patients, there is a high prevalence of acute kidney injury (AKI), and it is important to classify it by cause, as it has prognostic implications. (2) Hepatorenal syndrome (HRS) is one of the phenotypes of AKI in these patients and its prognosis remains poor without liver transplantation. (3) In recent years, classification, nomenclature, diagnostic criteria and pathogenic theories regarding HRS have evolved. (4) However, establishing the diagnosis of HRS in clinical practice is not always easy and it seems to be hard to distinguish it from other forms of AKI.

Objectives: To determine the prevalence of HRS in patients with ACLF by reevaluating the diagnostic criteria.

Methods: We retrospectively studied patients with ACLF admitted in intensive care unit (ICU) at a reference centre on liver transplantation. Clinical files from the past four years were reviewed, and patients who had had the diagnosis of HRS as main cause for ACLF were characterized according to its severity, necessity of renal replacement therapy and survival, and distinguished from other causes of AKI by applying the new International Ascites Club criteria for HRS. (4) Demographic, confounding and outcome variables were collected.

Results: A total of 63 patients with ACLF were enrolled, 72,5% males, with a mean age of 55,3 years old. Eleven patients (17,6%) were initially reported to present with HRS as decompensation for ACLF; however, after revising the data, only 5 (7,8%) patients fit the criteria for diagnosis of HRS. Among these, 4 patients were classified as HRS-AKI (KDIGO criteria AKI-1 25%; AKI-2 50%; AKI-3 25%), and 1 as HRS-CKD. Two patients received albumin and terlipressin; 3 had renal replacement therapy; and 3 underwent liver transplant. Although there were no differences in terms of severity of ACLF between patients with HRS and patients with other phenotypes of AKI (mean CLIF-SOFA 56,7 VS 56,8), the mortality was inferior in patients with HRS (20% VS 40%).

Conclusions: In this series of patients with ACLF, HRS was overdiagnosed. The severity of ACLF did not differ between other phenotypes of AKI and HRS, and the mortality rate was higher in patients who could not fit the criteria for HRS. These data differ from the literature, which could be explained by the low number of patients with HRS and the high proportion receiving liver transplant.

References

1. 4. Angeli P, Garcia-Tsao G, Nadim MK, Parikh CR. News in pathophysiology, definition and classification of hepatorenal syndrome: A step beyond the International Club of Ascites (ICA) consensus document. *J Hepatol.* 2019 Oct;71 (4):811–822.
2. 3. Francoz C, Durand F, Kahn JA, Genyk YS, Nadim MK. Hepatorenal Syndrome. *Clin J Am Soc Nephrol.* 2019 May 7;14 (5):774–781.
3. 2. Martín-Llahí M, Guevara M, Torre A, Fagundes C, Restuccia T, Gilabert R, Solá E, Pereira G, Marinelli M, Pavesi M, Fernández J, Rodés J, Arroyo V, Ginès P. Prognostic importance of the cause of renal failure in patients with cirrhosis. *Gastroenterology.* 2011 Feb;140 (2):488–496.e4.
4. 1. Khanam A, Kottlil S. Acute-on-Chronic Liver Failure: Pathophysiological Mechanisms and Management. *Front Med (Lausanne).* 2021 Nov 8;8:752875.

Topic: Metabolism, endocrinology, liver failure and nutrition

001229

Exploring the experiential perspectives of nurses to understand the complexity of early recognition of sepsis

M. Nemeckova¹, T. Conner², A. Steven³

¹Department of Nursing, Midwifery and Health Faculty of Health and Life Sciences, Northumbria University, Newcastle upon Tyne, United Kingdom;

²Department of Nursing, Midwifery and Health Faculty of Health and Life Sciences, Northumbria University Newcastle, Newcastle upon Tyne, United Kingdom; ³Department of Nursing, Midwifery and Health Faculty

of Health and Life Sciences, Northumbria University, Coach Lane Campus (East), Newcastle upon Tyne, United Kingdom

Correspondence: M. Nemeckova

Intensive Care Medicine Experimental 2023, 11 (Suppl 1):001229

Introduction: Sepsis is a common but often unrecognised life-threatening condition associated with high mortality (Rudd et al., 2020). Early detection is associated with improved outcomes, but this is hindered by a lack of universally accepted diagnostic criteria and heterogeneous and difficult-to-recognise presentations of sepsis (Gauer, 2013, Vincent, 2016). The approach to early recognition of sepsis, while shaped in some part by protocols, is often in the hands of nurses caring for ill patients (Harley et al., 2019, Kleinpell et al., 2019).

Objectives: This study examined the experiential perspectives of nurses to understand the complexity of early recognition of sepsis.

Methods: Semi-structured interviews were performed with 26 nurses from various hospital settings, including intensive care, medical, surgical, research, oncology, neurosurgery, sepsis and practice development departments. The phenomenographic method was utilised to analyse the interviews (Åkerlind, 2005). Findings were arranged into categories based on the Cynefin Framework (Snowden and Boone, 2007).

Results: The findings revealed that recognising sepsis happened in various clinical contexts. The variability provided a direction for clinical decision-making, enabling the nurses to adapt the approach according to the specific context. When dealing with a clear disease pattern, nurses followed rules from a protocol to draw conclusions and determine actions. However, protocol-based care assumes single pathways, and in more complicated contexts, there was much more diversity than implied by protocols. Therefore, here nurses adopted an analytical approach. However, the approach implies knowable cause-and-effect relationships and the possibility of assigning probabilities to outcomes, but in complex contexts, there was much more unpredictability than the approach allowed for. Here, nurses adopted a more individualised approach, allowing nurses to adapt recommended care according to the individualised patient needs. This approach appeared more complex and labour-intensive, requiring an understanding of the clinical implications of the disease and contextual aspects, yet it provided a basic foundation for clinical reasoning in the most severely ill patients in intensive care.

Conclusions: Our findings suggest that sepsis recognition, as we know it, in which one set of criteria is applied to a huge spectrum of clinical situations without consideration for heterogeneous populations of patients with sepsis, may be of limited value. We recommend that sepsis criteria remain an important point of departure but are no longer the only one. Rather, progressing toward a context-specific approach to sepsis recognition that takes advantage of a series of strategies may be more relevant. This approach demands flexibility, adaptability and educational support; however, unless we support nurses in learning to adapt strategies in a more context-specific manner, a significant development in sepsis recognition might not be seen.

References

1. ÅKERLIND, G. S. 2005. Phenomenographic methods: a case illustration. In: Bowden, J. & Green, P. Doing Developmental phenomenography. Melbourne: RMIT University Press, p.103–127. GAUER, R. L. 2013. Early recognition and management of sepsis in adults: the first six hours. *American Family Physician*, 88, 44–53. HARLEY, A., JOHNSTON, A. N. B., DENNY, K. J., KEIJZERS, G., CRILLY, J. & MASSEY, D. 2019. Emergency nurses' knowledge and understanding of their role in recognising and responding to patients with sepsis: A qualitative study. *Int Emerg Nurs*, 43, 106–112. KLEINPELL, R., BLOT, S., BOULANGER, C., FULBROOK, P. & BLACKWOOD, B. 2019. International critical care nursing considerations and quality indicators for the 2017 surviving sepsis campaign guidelines. *Intensive Care Med*, 45, 1663–1666. RUDD, K. E., JOHNSON, S. C., AGESA, K. M., SHACKELFORD, K. A., TSOI, D., KIEVLAN, D. R., COLOMBARA, D. V., IKUTA, K. S., KISSOON, N., FINFER, S., FLEISCHMANN-STRUZEK, C., MACHADO, F. R., REINHART, K. K., ROWAN, K., SEYMOUR, C. W., WATSON,

R. S., WEST, T. E., MARINHO, F., HAY, S. I., LOZANO, R., LOPEZ, A. D., ANGUS, D. C., MURRAY, C. J. L. & NAGHAVI, M. 2020. Global, regional, and national sepsis incidence and mortality, 1990–2017: analysis for the Global Burden of Disease Study. *The Lancet*, 395, 200–211. SNOWDEN, D. J. & BOONE, M. E. 2007. A leader's framework for decision making. *A leader's framework for decision making*. *Harv Bus Rev*, 85, 68–76, 149. VINCENT, J. L. 2016. The Clinical Challenge of Sepsis Identification and Monitoring. *PLoS Med*, 13, e1002022.

2. The author has nothing to declare.

Topic: Nursing care and physiotherapy

001230

Angiotensin 1–7 and ACE2-overexpression results in decreased IL-1 β levels following NLRP3 inflammasome stimulation

B. Seeliger¹, A. Nataliia², B. Jäger², P. Konrad³, P. Vollmer-Barbosa⁴, S. David⁵, C. Bode⁶, A. Prasse¹

¹Department of Respiratory Medicine, Hannover Medical School, Hannover, Germany; ²Institute for Toxicology and Experimental Medicine, Fraunhofer Institute, Hannover, Germany; ³Department of anaesthesiology and intensive care medicine, University of Bonn, Bonn, Germany; ⁴Department of Experimental Haematology, Hannover Medical School, Hannover, Germany; ⁵Institute of Intensive Care Medicine, University Hospital Zurich, Zurich, Switzerland; ⁶Department of anaesthesiology and critical care medicine, University of Bonn, Bonn, Germany

Correspondence: B. Seeliger

Intensive Care Medicine Experimental 2023, **11** (Suppl 1):001230

Introduction: COVID-19 is a highly inflammatory disease which can lead to acute respiratory distress syndrome (ARDS). Angiotensin converting enzyme 2 (ACE-2) enables cellular entry of SARS-CoV2 and converts angiotensin (Ang) II into Ang (1–7). Ang (1–7) antagonizes the inflammatory effects of the ANG-II-AT1R axis with protective downstream effects via the Mas-receptor (MasR).

Objectives: To analyse the Ang (1–7) levels in BAL fluid of ARDS patients and to analyse the potential of ACE2 overexpression and Ang (1–7) in HEK293T cells and air-liquid-interface (ALI) cultures to inhibit inflammasome activation.

Methods: HEK-293 T-Cells and air-liquid-interface (ALI) cultures together with U937 monocytes were cultured and stimulated with 10^{-5} M Ang-II, 10^{-5} M Ang (1–7) and 10^{-5} M A 779 (a MasR inhibitor) over night. Inflammasome activation was done via 10^{-6} M LPS and 10^{-5} M nigericin. ACE2 overexpression in HEK293T cells and ALI-cultures was achieved via lentiviral vector transduction. IL-1 β and Ang (1–7) concentrations were measured via ELISA in the supernatants and bronchoalveolar lavage-fluid from ARDS patients with different underlying diseases.

Results: Ang (1–7) was markedly reduced in BAL fluid in ARDS patients due to COVID-19 and other viral and bacterial pathogens and indirect ARDS compared to healthy volunteers. Lower Ang (1–7) BAL fluid levels were also associated with 28-day mortality ($p=0.018$). In cell-cultures, HEK293T and ALI co-cultures (with U937-cells) inflammasome induction could be induced. ACE2 overexpression lead to a reduction in IL-1 β levels in both HEK293T ($p<0.001$) and ALI co-cultures ($p=0.0165$). Treatment with Ang (1–7) lead to a marked reduction of IL-1 β levels in HEK293T ($p<0.001$) and ALI co-cultures ($p=0.01$) regardless of ACE-2 overexpression. ACE2 overexpression however increased the endogenous production of Ang (1–7) following inflammasome activation. These effects were reversed by inhibition of the MasR (Ang-1–7-receptor) with increased levels of IL-1 β in both HEK293T and ALI co-cultures.

Conclusions: We show that IL-1 β due to inflammasome activation can be down-regulated via Ang (1–7). Endogenous production of Ang (1–7) was increased with ACE-2 overexpression. Blockage of the MasR (Ang[1–7]-receptor) completely reversed the protective effect of Ang (1–7). Lower Ang (1–7) levels in ARDS patients were associated with mortality in COVID-19 patients. Thus, MasR agonists might be a potential treatment in a subgroup of ARDS patients.

Topic: Acute respiratory failure and mechanical ventilation

001231

Are we putting our obese patients on a diet? Indirect calorimetry as an approach tool to obesity in intensive care medicine

I. Santos¹, G.C. Almeida¹, A. Marques¹, S. Beirão¹, A. Catarino¹, A. Salgueiro¹, R. Alves¹, C. Monteiro¹, P. Martins¹

¹Intensive Care Unit, Centro Hospitalar e Universitário de Coimbra, Coimbra, Portugal

Correspondence: I. Santos

Intensive Care Medicine Experimental 2023, **11** (Suppl 1):001231

Introduction: Obesity has become an epidemic issue with associated healthcare burden and this particular form of malnutrition is now frequently observed in the intensive care setting. Adequate nutritional support is challenging in critically ill patients, especially those with obesity, since energy needs have normally been calculated through predictive formulas based on body weight underestimating patient's needs.

Indirect calorimetry (IC) is regarded as the preferable means to determine resting energy expenditure (REE) by the European Society for Parenteral and Enteral Nutrition but it's still not universally available, predisposing to inadequate nutritional support (underfeeding <70% of REE and overfeeding >110% of REE). In obese patients REE measurements have the best potential to accurately characterize the metabolic situation.

Objectives: The aim of our study was to assess how IC could improve nutritional evaluation and support in obese critical care patients, with a body mass index (BMI) >30 kg/m², from a mixed intensive care unit.

Methods: Comparative analysis of 41 critically ill obese patients REE, calculated through the simplified formula of 25 kcal/kg/day with the measured by IC, from a total sample of 127 intensive care patients. Adequate energetic support was considered when <70% of REE measured by calorimetry in the acute phase—first three days of intensive care unit (ICU) and 70–110% from fourth day on.

Results: Obese patients presented a mean BMI of $35,8 \pm 5,7$ kg/m², with mean APACHE score $23,32 \pm 7,7$ and SAPS score $52,98 \pm 16,6$. The majority, 22 patients (53,7%), had a medical cause for admission, 13 surgical and 6 had trauma. There were 21 male patients (51,2%) and a mean age of $67,5 \pm 13,1$ years old.

The mean REE calculated by the formula was $1493,29 \pm 318,76$ kcal/day and the one measured by IC was $1609,37 \pm 388,62$ kcal/day, with poor statistical correlation between both. Previously to IC introduction the administered caloric intake was $1098,24 \pm 439,51$ kcal/day. Of the 7 patients evaluated by IC in the acute phase, 2 (28,5%) were in underfeeding. After the fourth day in ICU: 16 patients (47%) were in underfeeding and 5 (14,7%) in overfeeding. From the total 127 patients, in the acute phase 38,9% were overfeeding and after day 4 of ICU stay 36,3% were underfeeding and 12,1% overfeeding.

Conclusions: Energy expenditure measured by gold standard—IC was different from the predictive formula of 25 kcal/kg/day in the obese patients, where the adjusted body weight tends to either over or underestimate energetic needs. The low accuracy of predictive equations led to overfeeding in almost a third (28,5%) of obese patients in the acute phase, comparing with the greater proportion in the total sample and underfeeding of almost half (47%) in the subsequent phase, comparing with the smaller proportion of underfed patients in the total sample. Predictive formula of 25 kcal/kg/day should not be used to estimate REE of obese critically ill patients for its hazard of over or underfeeding.

References

1. Singer P, Reintam Blaser A, Berger MM, Alhazzani W, Calder PC, Casaer M, Hiesmayr M, Mayer K, Montejo JC, Pichard C, Preiser J-C, van Zanten ARH, Oczkowski S, Szczeklik W, Bischoff SC, ESPEN guideline on clinical nutrition in the intensive care unit, *Clinical Nutrition* (2018)
2. S.C. Bischoff, R. Barazzoni, L. Busetto et al., European guideline on obesity care in patients with gastrointestinal and liver diseases e Joint ESPEN/UEG guideline, *Clinical Nutrition*

Topic: Metabolism, endocrinology, liver failure and nutrition

001234

Diagnosis and risk factors of nosocomial Fungal infections in COVID 19 critically ill patients

H. Yahyaoui¹, H. D. Hamdi¹, B. F. Nebiha¹

¹Intensive care departement, Hôpital Habib Thameur, Tunis, Tunisia

Correspondence: H. Yahyaoui

Intensive Care Medicine Experimental 2023, **11 (Suppl 1)**:001234

Introduction: The new coronavirus, SARS COV 2, is causing, in the most severe cases, an acute respiratory distress syndrome which requires prolonged hospitalization in intensive care units. In these critical patients, the incidence of nosocomial infections and particularly fungal infections (FNI) has been reported as important factor of morbidity and mortality.

Objectives: To describe the epidemiological, biological and microbiological features of FNI and to search for risk factors to their occurrence.

Methods: The study was descriptive, retrospective and monocentric, including patients admitted for at least 48 h to the medical intensive care unit for SARS COV 2 infection during the period from 01/09/2020 to 30/06/2022. Demographic, clinical, microbiological, therapeutic data and outcomes were collected.

Results: We enrolled 450 patients. The mean age was 64.2 years \pm 15 and the sex ratio was 1.14. One hundred and ninety-two (42.7%) patients were diabetic and 211 (46.9%) had hypertension. Weight was measured in 139 cases and the mean body mass index was 28.8 \pm 5.7 kg/m². The median IGSII, APACHE II and SOFA scores at admission were respectively 28 [22–33], 7 [6–10] and 3 [2–4]. NFI occurred in 71 patients with a total number of 75 episodes and a median time to occur of 10 days [7–13].

The NFI was diagnosed with a positive colonization index (CI) and a high candida score in 49 cases (with a median of candida score of 3 [3–4]), a positive urinary culture in 13 cases,, a positive mannan antigenemia in 10 cases,, a positive blood cultures in 2 cases and a positive protected tracheal sample in one case. The most frequently isolated candida was *C.albicans* (79%), *C.krusei* (16%) and *C.glabrata* (5%).

According to the antifungigram, sixty-nine patients were treated with voriconazole and two with fluconazol. Length of stay had a median of 10 days [6–14]. Mortality in INF group was 94.4% ($p < 10^{-3}$).

In multivariate analysis, the occurrence of NFI was significantly associated with previous antibiotic therapy (< 6 mois) (OR:2.8; 95% CI: 1.1–6.8; $p < 10^{-3}$), severe ARDS (OR:7; 95% CI: 1.9–25.8; $p < 10^{-3}$), venous central catheterization (OR:9.7; 95% CI: 3.2–29.5; $p < 10^{-3}$), urinary catheterization (OR:41; 95% CI: 5.2–324.1; $p < 10^{-3}$) and parenteral nutrition (OR:7.7; 95% CI: 1.6–35.9; $p = 0.009$).

Conclusions: Fungal infection in patients admitted for ARDS at Covid-19 is frequent. It affects the most critical patients and should be investigated early. However, larger studies are needed to confirm this finding.

Topic: Infections and prevention

001235

Status epilepticus: etiology, outcomes and mortality risk factors

I. Sdiri, S. Ines¹, H. H. Doghri², H. Wafa³, H. Touj¹, A. Bentaher¹, I.

Zaghoudi², N. Falfoul Borsal³

¹ICU, Hôpital Habib Thameur, Tunis, Tunisia; ²Intensive care, Habib

Thameur University Hospital, Tunis, Tunisia; ³Intensive care, Hôpital Habib Thameur, Tunis, Tunisia

Correspondence: I. Sdiri

Intensive Care Medicine Experimental 2023, **11 (Suppl 1)**:0001235

Introduction: Status epilepticus (SE) has a higher rate of morbidity and mortality. Factors influencing patients' outcomes are weakly understood.

Objectives: Our study aimed to describe initial patterns and to identify morbidity and mortality risk factors in patients with SE.

Methods: We conducted a monocentric retrospective study including patients admitted with SE from January 2018 to December 2022 in

ICU. We made the diagnosis according to the formalised expert recommendations of 2018. We evaluated initial data and analysed morbidity and mortality predictors.

Results: Eighty patients with SE were enrolled with a median age = 53 years. 82.5% of patients were male. 37.5% of cases had a past history of epilepsy. The mean APACHE II and SAPS II scores were respectively 18 \pm 2 and 37 \pm 4. Seizures were generalized tonic-clonic in 87.2%. Main etiologies were: cerebrovascular accidents (hemorrhagic stroke in 21.7% and ischemic stroke in 10.9%); switching off the epileptic drug (19.6%), encephalitis (10.9%); cerebral venous thrombosis (6.5%); acute poisoning (6.8%) and metabolic abnormalities (2.2%). Invasive mechanical ventilation and neurosedation were needed in 76.2% of patients. ICU length of stay was 13 \pm 22 days [1–132]. ICU mortality was 23.7%. In univariate analysis, mortality risk factors were age (50.6 vs 64 years, $p = 0.039$), intubation (0% vs 30%; $p = 0.03$), hemodynamic instability (6.8% vs 50%; $p = 0.001$) and nosocomial infection (12.9% vs 43.7%; $p = 0.024$). Independent mortality risk factors were age > 50 years (OR = 10.2 IC 95% [3.5–66.3], $p = 0.03$) and invasive mechanical ventilation (OR = 4.54 IC 95% [3.24–10], $p = 0.03$).

Conclusions: Patients with status epilepticus have a median age of 53 years and a male sex. Cerebrovascular disease was the most etiology of status epilepticus. ICU length of stay and mortality are high. Age and mechanical ventilation requirement are the mortality risk factors.

Topic: Neurointensive care

001236

Quality of life in very old intensive care patients: are we helping them?

S. Ferreira¹, MN. Simoes², M. Pereira², L. M. Afonso², E. Gomes², R. Araújo²

¹Serviço de Medicina Intensiva, Hospital Pedro Hispano, Senhora da Hora, Portugal; ²Intensive care medicine, ULSM-Hospital Pedro Hispano, Matosinhos, Portugal

Correspondence: S. Ferreira

Intensive Care Medicine Experimental 2023, **11 (Suppl 1)**:001236

Introduction: In the last decades, there has been a progressive increase in average life expectancy. Indeed, recent studies estimate an increase of habitants in Europe older than 80 years from 6% in 2018 to 12% in 2050, expecting an increase in older patients needing intensive care unit (ICU)2. These patients present decreased physiologic reserves and more frailty, a challenge in recovering from critical illness 2,3, altering the Quality of Life (QoL) of those discharged from the ICU3. Therefore, progressive concern has been raised on management of very old intensive care patients (VIPs), regarding not only their mortality but their level of fitness or frailty and QoL after discharge from the ICU.

Objectives: To evaluate if ICU admission of VIPs had a significant impact on their level of fitness or frailty and QoL.

Methods: A retrospective study was conducted, collecting data from very old (≥ 80 years) patients admitted between January 2017 and June 2022. Data was collected between October and November 2022. Gender, length of stay, CFS before ICU admission, age-adjusted Charlson Comorbidity Index (CCI), SAPS II, need for ventilation, vasoactive drugs or renal replacement therapy and whether limitations of treatment were established during ICU stay were also collected. In addition, Clinical Frailty Score (CFS) after ICU discharge and EQ-5D-3L questionnaires after discharge were obtained for patients who had been admitted to the ICU between January and June of 2022.

Results: We included 245 VIPs, with a median age of 83 years old (P25-P75 81–85) and predominance of the male gender (57.6%). The mean length of stay was 4.4 \pm 4.3 days. The mean SAPS II was 44.8 \pm 13.7. ICU mortality was 26.1% and 49.4% of VIPs remained alive at the time of data collecting. In regards to CFS and EQ-5D-3L questionnaires after ICU discharge, we included 19 VIPs from the established time period. We observed that VIPs had higher CFS after ICU admission (mean CFS 3 vs 5, before vs after), however CFS remained unaltered in 42.1% of VIPs. Most VIPs reported at least a moderate impact on mobility and self-care (68.4% and 47.4% respectively). Anxiety & depression, usual activities and pain & discomfort were less affected (42.1%, 36.8% and

36.8% respectively). More than 90% of the patients reported a perceived health status higher than 50% of what they considered to be the best imaginable. When questioned about their QoL after admission in ICU, 21% of VIPs reported an improvement, 36.8% had the same health status and 42.1% reported a deterioration.

Conclusions: More than 40% of VIPs remain functionally unaltered after discharge from ICU, revealing a potential benefit from ICU admission. Mobility and self-care were the most affected domains on EQ-5D questionnaire. Although most VIPs had a functional decline after discharge, some patients reported an improvement in their QoL. Since quality of life is a subjective issue, admission to the ICU possibly changed their expectations and, as such, their perspective on quality of life, at least not worsening their health status in more than half of the patients.

References

- 3—Joseph B, Jehan FS. The Mobility and Impact of Frailty in the Intensive Care Unit. *Surg Clin North Am.* 2017 Dec;97 (6):1199–1213. <https://doi.org/10.1016/j.suc.2017.07.007>. PMID: 29132505.
- 2—Flaatten H, Beil M, Guidet B. Elderly Patients in the Intensive Care Unit. *Semin Respir Crit Care Med.* 2021 Feb;42 (1):10–19. <https://doi.org/10.1055/s-0040-1710571>. Epub 2020 Aug 9. PMID: 32772353.
- 1—AGE Platform Europe. Ageing Europe—looking at the lives of older people in the EU—Eurostat 2019 report. Available at: <https://www.age-platform.eu/publications/ageing-europe-looking-lives-older-people-eu-eurostat-2019-report>. Accessed April 11, 2023

Topic: Critical care organisation, quality management, information systems, outcomes

001237

Assessment equivalence between pupillometry indices NPi and QPi in acute brain injury patients

A. Blandino Ortiz¹, M. López Olivencia¹, J. Higuera¹, C. Soriano Cuesta¹, S. Saez Noguero¹, J. A. Montufar Ramirez¹, C. Vaquero¹, R. De Pablo¹

¹Intensive Care Medicine, Ramón y Cajal Hospital, Madrid, Spain

Correspondence: A. Blandino Ortiz

Intensive Care Medicine Experimental 2023, **11 (Suppl 1)**:001237

Introduction: Pupillary examination, in particular pupillary reactivity to light, is fundamental for the monitoring and daily follow-up in acute brain injury patients in intensive care units (ICU). As a matter of fact, intracranial pressure monitoring and pupillometry measurement are part of daily care of brain-injured patients in some ICUs.

Pupillometric indices combining different parameters of the pupillary light reflex has been described that has predictive value for intracranial hypertension and neurologic outcome, depending on the device, these two indices are known as NPi, proposed by Neuroptics, and QPi, proposed by IdMed, based on a statistical classification of the amplitude of the photomotor reflex.

Objectives: The objective of this pilot study is to explore whether the QPi is equivalent to the NPi in patients with acute brain injury (TBI, SAH and ICH and post-cardiac arrest hypoxic-ischaemic encephalopathy). To assess whether the parameters exploring the pupillary reactivity to light of both devices are equivalent.

Methods: A prospective, observational, pilot study was conducted in patients with acute brain injury (TBI, SAH and ICH and post-cardiac arrest hypoxic-ischaemic encephalopathy), consecutively admitted to our Intensive Care Department. All patients were in coma, with deep sedation. Isolated pupillometry measurements were performed sequentially by two investigators, blinded to the comparative examination, with two different pupillometers (NPi-200 and Neurolight). Demographic, clinical, and therapeutic variables were collected for all patients during ICU admission. A third researcher analyzed the results, using IBM SPSS Statistics, version 27.0. The percentage of observed agreement was calculated for all the categorical and dichotomous variables. The reproducibility of all measurements was evaluated by calculating the unweighted Cohen's kappa coefficient (κ) for measurements with dichotomous results and the weighted Cohen's kappa coefficient for measurements with multiple, ordinal answer options.

All κ coefficients and ICC values were interpreted according to Landis and Koch; values between 0.01 and 0.20 were considered to indicate slight agreement, values between 0.21 and 0.40 to indicate fair agreement, values between 0.41 and 0.60 to indicate moderate agreement, values between 0.61 and 0.80 to indicate substantial agreement, and values between 0.81 and 1.00 to indicate almost perfect agreement.

Results: From December 2022 to March 2023, in our study, we included 53 patients (ICH 43%; SAH 32%; Post-cardiac arrest 15%; TBI 10%) and performed 86 measurements. Among them, 60% were male, with mean age 61 (\pm 13), the mean GCS at admission was 7. We recorded 21 ICP measurements, with mean ICP of 10 mmHg.

Among pupillometry indices, we found a strong correlation between QPi and NPi (κ 0.83; p = < 0.001), as well with pupillary light reflex variables (Var Neurolight and CH NPi-200, respectively) with substantial agreement (κ 0.81; p = < 0.001).

Conclusions: In our pilot study, we found a strong (substantial) correlation between NPi and QPi, as well with pupillary light reflex variables (Var and CH), which nowadays are considered the most robust variables to assess neurologic outcome, based on NPi-200 studies.

Forward studies are needed to determine the equivalence among the two pupillometers to assess the neurologic outcome among acute brain injury patients with different etiologies.

Topic: Neurointensive care

001238

Infective endocarditis: diagnosis and management in the emergency department

I. Sdiri¹, H. H. Doghri², H. Wafa¹, A. Bentaher¹, S. Ines¹, I. Zaghdoudi², N. Falfoul Borsali³

¹ICU, Hôpital Habib Thameur, Tunis, Tunisia; ²Intensive Care, Habib

Thameur University Hospital, Tunis, Tunisia; ³Intensive Care, Hôpital Habib Thameur, Tunis, Tunisia

Correspondence: I. Sdiri

Intensive Care Medicine Experimental 2023, **11 (Suppl 1)**:001238

Introduction: Infective endocarditis is a rare condition. Its incidence has increased due to the number of elderly patients with chronic diseases and intra-cardiac devices and the increase in intravenous drug abuse. Its diagnosis in the emergency department remains a challenge and its delayed diagnosis can lead to many serious complications.

Objectives: The aim of our study was to describe the clinical, microbiological, echographic, and evolutionary features of patients admitted to the emergency department for infective endocarditis.

Methods: This was a retrospective descriptive study including patients admitted to the emergency and medical intensive care unit between January 1, 2019 and December 1, 2022. We collected clinical, paraclinical, therapeutic and evolutionary data.

Results: We collected 10 patients admitted for infective endocarditis. The median age was 51 years [30–74]. The sex ratio was 9. Four patients had a history of intravenous drug use, one of whom had viral hepatitis C and three patients had renal failure at the hemodialysis stage. Blood cultures were positive in 8 patients. Four were staphylococcus, three were enterococcus and one was bacillus cereus. All patients had infective endocarditis on a native valve. Echocardiography was contributory in all cases and showed vegetation. Four patients had tricuspid valve involvement (three of whom were intravenous drug users), three had mitral valve involvement and three had aortic valve involvement. Six patients had at least one secondary infectious location. Only one patient had an indication for an urgent surgical treatment, it was a doubt about a perforation of the mitral valve pillar at the control echography performed at the 38th day of hospitalization and indicated by the non improvement under antibiotic therapy. The median length of stay in the emergency department was 5 days [3–19]. Three patients died, two of them during their hospitalization and one patient who consulted after a relapse. All three patients had endocarditis on the mitral valve.

Conclusions: Infective endocarditis on the native valve is a rare disease but it has a high mortality rate of 30%. Contributory investigations such as blood cultures and echocardiography remain the key

steps of the diagnosis and must be performed early. Management is multidisciplinary and surgical indications are still rare.

Topic: Infections and prevention

001239

Early-onset versus late-onset ventilator associated pneumonia among severe COVID-19 related ARDS patients

M. Zghidi¹, R. Toumi¹, K. Meddeb¹, E. Ennouri¹, I. Ben Saida¹, M. Boussarsar¹
¹Farhat Hached Hospital, Medical Intensive Care Unit, Université de Sousse, Faculté de Médecine de Sousse, UR N° LR12SP09.Heart Failure, Sousse, Tunisia

Correspondence: M. Zghidi

Intensive Care Medicine Experimental 2023, **11 (Suppl 1)**:001239

Introduction: The pandemic of coronavirus disease 2019 (COVID-19) has resulted in high rates of hospitalization in intensive care units (ICU) with widespread use of invasive mechanical ventilation (IMV) which exposes patients to the risk of ventilator-associated pneumonia (VAP). VAP is classified as early-onset (EVAP) or late-onset VAP (LVAP) (1).

Objectives: To compare patients with EVAP to those with LVAP and to identify its potential risk factors.

Methods: This was a retrospective study of patients hospitalized with severe COVID-19 from March 2020 to December 2021, in a medical intensive care unit who required mechanical ventilation for more than 48 h. VAP was identified by using a combination of imaging, clinical and laboratory criteria. The cut off point definition was ≤ 6 days for E-VAP and > 6 days for L-VAP (2). Univariate analysis and multivariable logistic regression were used to analyze the associated factors with EVAP and LVAP.

Results: 732 patients were admitted to the ICU, 465 (63.5%) had a confirmed COVID-19 infection, 247 (53.1%) required IMV and met the inclusion criteria. Patients' characteristics were: mean age, 65 ± 12 years; Median pre-ICU management delay, 4[3–7] days; Median SAPSII on admission, 31[26–38]; Median IMV duration, 10[7–16]; Median length-of-stay was at 12[7–17] days. The overall mortality rate was 84.6%.

Overall, 45 (18.2%) patients developed VAP with density incidence rate estimated at 18 VAP/1000 ventilator days. EVAP was observed in 15 patients (33.3%), whereas 30 patients (66.7%) developed LVAP. Patients with EVAP had longer pre-ICU management delay (5[2–6] vs 4[2–5], $p = 0.030$) and lower SAPSII on admission (26[22–31] vs 31[27–35], $p = 0.020$). The most frequently isolated organism in EVAP was *Pseudomonas aeruginosa*, 6 (40%) followed by *Acinetobacter baumannii* 5 (30%) and *Klebsiella pneumoniae*, 3 (20%).

Acinetobacter baumannii 19 (63.3%), *Pseudomonas aeruginosa*, 10 (30.3%), *Klebsiella pneumoniae*, 6 (20%) and *Staphylococcus aureus*, 3 (7.5%) were the most common pathogens associated with LVAP.

There were no significant differences between the two groups in the ICU length of stay (EVAP, 13[9–22] vs LVAP, 13.5[10–18.5], $p = 0.381$), IMV duration (EVAP, 10[7–13] vs LVAP, 10.5[6.75–16.25], $p = 0.073$) and mortality rate (EVAP, 12 (80%) vs LVAP, 27 (90%), $p = 0.364$).

The only risk factor independently associated with EVAP was pre-ICU management delay (RR, 1.15; 95%CI, [1.04–2.27]; $p = 0.026$). Diabetes (RR, 1.7; 95%CI, [1.5–5.6]; $p = 0.03$) and high SAPSII on admission (RR, 1.09; 95%CI, [1.02–2.9]; $p = 0.020$) were risk factors independently associated with LVAP.

Conclusions: Both early-onset and late-onset VAP were associated with increased hospital mortality rate and prolonged length of stay. Pre-ICU management delay was risk factor independently associated with EVAP. Diabetes and high SAPSII on admission were risk factors independently associated with LVAP.

References

- i. (1) M. Garnier, J.M. et al. Epidemiology, risk factors and prognosis of ventilator-associated pneumonia during severe COVID-19: multicenter observational study across 149 European Intensive Care Units, *Anaesthesia, critical care & pain medicine* 42 (1) (2023), (2) Arayasukawat,

P, et al. Microorganisms and clinical outcomes of early- and late-onset ventilator-associated pneumonia at Srinagarind Hospital, a tertiary center in Northeastern Thailand. *BMC Pulm Med* 21, 47 (2021).

Topic: Infections and prevention

001241

Pulse respiratory quotient: a clinical parameter to predict pulse oximetry fiability in critically ill patients

I. Sdiri¹, H. H. Doghri², I. Klai¹, S. Ines¹, I. Zaghdoudi², N. Falfoul Borsali³
¹ICU, Hôpital Habib Thameur, Tunis, Tunisia; ²Intensive care, Habib Thameur University Hospital, Tunis, Tunisia; ³Intensive Care, Hôpital Habib Thameur, Tunis, Tunisia

Correspondence: I. Sdiri

Intensive Care Medicine Experimental 2023, **11 (Suppl 1)**:001241

Introduction: Pulse oximetry (PO) is a non invasive method measuring peripheral oxygen saturation in critically ill patients. Its outcomes depend on cardio-respiratory activity which can be evaluated using the pulse respiratory quotient (PRQ). The aim of our study was to evaluate the use of PRQ to predict PO fiability.

Methods: We conducted a prospective study of adults admitted to the intensive care unit from October 2022 to March 2023. Epidemiological, clinical, biological and therapeutic features were collected. PRQ was calculated by dividing the heart rate (HR) by the respiratory rate (RR). The measurement of pulse oxygen saturation (SpO2) will be made by a pulse oximeter and will be followed immediately by the realization of an arterial blood gas sample (by an arterial puncture or by a blood sample by the arterial catheter). DeltaSpO2 (SpO2-SaO2) will be calculated and analyzed according to PRQ.

Results: Two hundred and six measurements for 57 patients were enrolled. The sex-ratio was 1.19. At admission, 51 patients (89.4%) had acute respiratory failure, 24 (42.1%) had neurological distress and 10 (17.5%) had hemodynamic instability. The median IGSII, APACHEII and Sofa scores were respectively 29 [23–38], 13 [9–17] and 3 [2–5]. Median PRQ was 4.2 [3.4–5.3]. Our analysis concluded that delta SpO2 was negatively correlated with PRQ (spearman's rho = -0.141 and $p = 0.044$) (Figure 1).

Thirty six essays had delta SpO2 > -2 which was associated with a $PRQ \geq 5$ ($p = 0.003$).

Conclusions: Delta SpO2 was correlated with PRQ and the fiability of SpO2 may be estimated by its analysis. For critical patient with a $PRQ \geq 5$, an evaluation of oxygen saturation with SaO2 is more accurate.

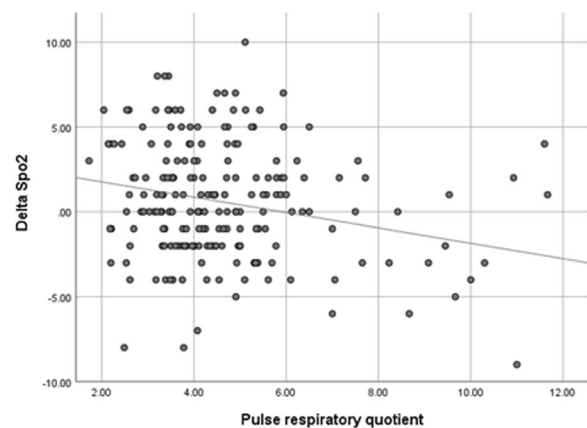

Topic: Acute respiratory failure and mechanical ventilation

001242

Oxygen saturation by arterial puncture or arterial catheterization: effect on the accuracy of pulse oximetry

I. Sdiri¹, H. H. Doghri², I. Klai¹, S. Ines¹, N. Falfoul Borsali³, I. Zaghdoudi²
¹ICU, Hôpital Habib Thameur, Tunis, Tunisia; ²Intensive Care, Habib Thameur University Hospital, Tunis, Tunisia; ³Intensive care, Hôpital Habib Thameur, Tunis, Tunisia

Correspondence: I. Sdiri

Intensive Care Medicine Experimental 2023, **11 (Suppl 1)**:001242

Introduction: Peripheral oxygen saturation (SpO2) is thought to be easier and less painful than direct measurement of arterial oxygen saturation. This arterial measurement can be realized by arterial catheterization or direct arterial puncture. However, SpO2 often underestimates arterial oxygen saturation (SaO2).

Objectives: We aimed to compare the difference between SpO2 and SaO2 (Delta SpO2) according to method of blood sampling (radial puncture and arterial catheterization).

Methods: We conducted a prospective study of adults admitted to the intensive care unit from October 2022 to March 2023. Epidemiological, clinical, biological and therapeutic features were collected. Patients were divided into two groups; group 1 (G1): arterial oxygen saturation measurement by arterial puncture and group 2 (G2): arterial oxygen saturation measurement by arterial catheterization. In all patients, the measurement of pulse oxygen saturation (SpO2) will be made by a pulse oximeter followed immediately by the realization of an arterial blood gas sample (by an arterial puncture (G1) or by a blood sample by the arterial catheter (G2)). DeltaSpO2 (SpO2-SaO2) was calculated and analyzed according to groups.

Results: Two hundred and six measurements for 57 patients were enrolled. The sex-ratio was 1.19. At admission, 51 patients (89.4%) had acute respiratory failure, 24 (42.1%) had neurological distress and 10 (17.5%) had hemodynamic instability. The mean IGSII, APACHEII and Sofa scores were respectively 29 [23–38], 13 [9–17] and 3 [2–5]. The comparison between the 2 groups objective that G2 was more critical (Table 1).

Forty (19.4%) assays were realised on patients under vaso-active drugs including 32 (80%) in G2. The total of 206 assays were divided into 172 (83.5%) measurements for G1 and 34 (16.5%) for G2. The gazometric features are detailed in Table 2.

Mean delta SpO2 was 1 [(-1.5)-1] for G1 and -2 [(-4)-(-2)] for G2. Sixty three assays had delta SpO2 > 4 or < -4. This assays were significantly more frequent in G2 (p = 0,043).

Conclusions: Mean delta SpO2 was 1 [(-1.5)-1] for G1 and -2 [(-4)-(-2)] for G2. Sixty three assays had delta SpO2 > 4 or < -4. This assays were significantly more frequent in G2 (p = 0,043).

Table 1. Comparaision of severity scores between the 2 groups.

	G1	G2	P
SOFA	2 [2-2]	8 [4-8]	0,025
APACHE II	12 [8-12]	25 [22-25]	0,013
IGS II	28 [23-28]	73 [53-73]	10 ⁻³

Table 2. Comparaision of gazometric features between the 2 groups.

	G1	G2	P
PH	7,42 [7,33-7,42]	7,24 [7,16-7,24]	10 ⁻³
PaCO2	41 [35-41]	47 [38-47]	10 ⁻³
PaO2	79 [65-79]	117 [82-117]	10 ⁻³
HCO 3-	28[23-28]	20,3[19-20]	10 ⁻³
SaO2	95 [92-95]	98[94-98]	0,09
PaO2/Fio2	193[140-193]	233 [130-233]	0,44
Lactate	1,3[1-1,3]	2,4 [2-2,4]	0,44

Topic: Acute respiratory failure and mechanical ventilation

001246

Accuracy of Spo2 in critically ill patients

I. Klai¹, H. H. Doghri², I. Sdiri¹, S. Ines¹, I. Zaghdoudi², N. Falfoul Borsali³
¹ICU, Hôpital Habib Thameur, Tunis, Tunisia; ²Intensive Care, Habib Thameur University Hospital, Tunis, Tunisia; ³Intensive Care, Hôpital Habib Thameur, Tunis, Tunisia

Correspondence: I. Sdiri

Intensive Care Medicine Experimental 2023, **11 (Suppl 1)**:001246

Introduction: Critically ill patients require close monitoring of blood oxygen saturation. Although the measurement of oxygen saturation in the arterial blood (SaO2) is the gold standard, pulse oximetry is a monitoring noninvasive tool used to clinically assess peripheral oxygen saturation (SpO2) and to guide therapeutic interventions. This technique is widely used, particularly in intensive care units.

Objectives: To evaluate the accuracy of pulse oximetry (SpO2) in critically ill patients.

Methods: This is a monocentric, evaluative, prospective and comparative study including patients admitted in an ICU department from December 12, 2022 to February 09, 2023. Demographic, clinical, biological and therapeutic data were collected. Pulse oxygen saturation measurement was performed in all patients at the level of the middle finger of the right hand. The measurement of pulse oxygen saturation was made by a pulse oximeter of the monitor. The measurement was followed immediately by the realization of an arterial blood gas sample (by an arterial puncture or by a blood sample by the arterial catheter). DeltaSpO2 (SpO2-SaO2) was calculated and analyzed to identify associated factor's variations.

Results: Two hundred and six measurements for 57 patients were enrolled. The sex-ratio was 1.19. Among this population, 30 (52.6%) had chronic respiratory failure which 16 (28%) were COPD, 23 (40.3%) had HTA, 22 (38.6%) had diabetes and 21 (36.8%) cardiac failure. At admission, 51 patients (89.4%) had acute respiratory failure, 24 (42.1%) had neurological distress and 10 (17.5%) had hemodynamic instability. The mean IGSII, APACHEII and Sofa scores were respectively 29 [23–38], 13 [9–17] and 3 [2–5].

Thirty-four ABG's (16,5%) were collected by arterial catheter and 172 (83,5%) by arterial puncture.

An arrhythmia was present during 66 measurements (32%) and forty (19.4%) assays were realised on patients under vaso-active drugs.

The median of temperature, respiratory rate and heart rate were respectively 37.2 [36.8–37.9], 24 [20–28] and 104 [90–116].

The median of vaso-active drug dose and oxygen inspiratory fraction were respectively 3mg/h [1–4] and 0,4 [0,35–0,6].

The analysis of ABG's showed that the median PH, PaO2, PACO2, bicarbonate, SaO2, SPO2 and PaO2/Fio2 ratio were respectively 7.39 [7.29–7.47], 83.5 [66–111], 41 [35–56], 26,4 [21.8–32], 96% [93–98], 96% [94–98] and 196 [140–280]Delta SPO2 (SpO2-SaO2) had a median of zero % [(-2)-3]. Thus, delta SpO2 > ±4% was found in 40 assays.

PaO2 < 68 mmHg was an independent risk factor for overestimating SpO2 (delta SpO2 > 4) with p = 10–3 (OR = 26 CI 95% [8.8–81.6]).

Shock was an independent risk factor for underestimating SPO2 (deltaSPO2 > -4%) P < 10–3,

(OR = 9.5, IC = 95%, [2.2–40]).

Conclusions: When estimated by pulse oximetry, oxygen saturation is overestimated in patients with hypoxemia and underestimated in patients with shock. SpO2 assessment must be realized according to other clinical and biological parameters.

Topic: Acute respiratory failure and mechanical ventilation

001248

Pulmonary embolism in COVID 19 in ICU: clinical characteristics and outcomes

H. D. Hamdi¹, Y. Hajer², I. Zaghdoudi¹, S. Ines³, H. Touj³, A. Alouini⁴, B. F. Nebiha¹

¹Intensive Care Departement, Hôpital Habib Thameur, Tunis, Tunisia;

²Intensive Care Departement, Hôpital Habib Thameur, Rue Ali Ben Ayed,

Tunis, Tunisia, Tunis, Tunisia; ³ICU, Hôpital Habib Thameur, Tunis, Tunisia; ⁴Intensive Care, Habib Thameur University Hospital, Tunis, Tunisia

Correspondence: H. yahyaoui

Intensive Care Medicine Experimental 2023, **11 (Suppl 1):001248**

Introduction: SARS COV 2 infection is essentially manifested by a respiratory form that can, in severe forms, evolve to an Adult respiratory distress syndrome (ARDS). In parallel, there are other manifestations, such as pulmonary embolism, reported especially in critically ill patients.

Objectives: To describe clinical characteristics and outcomes of pulmonary embolism in COVID 19 critically ill patients.

Methods: Descriptive, retrospective and monocentric study including all patients admitted in ICU department for at least 48 h between 01/09/2020 and 30/06/2022. All patient's data including demographics, clinical, biological, radiological and outcomes were taken from patient's medical files.

Results: 450 patients infected by the SARS COV 2 were included. Sex ratio was 1.14 and mean age was 63 ± 15.

46.8% and 42.6% of patients had respectively arterial hypertension and diabetes mellitus and 51% had obesity. Mean SAPSII, APACHEII and SOFA score were respectively 30 ± 39, 30 ± 39 and 8,6 ± 5.

Mean DDimer at admission was: 3049 ± 10,090 ng/ul.

At admission or during their stay, 47 patients (10.4%) presented a pulmonary embolism (44 at admission).

All patients were initially taking venous thromboembolism (VTE) prophylaxis by low-molecular-weight heparin (LMWH) as recommended. All patients were treated by curative doses of LMWH and three patients, who presented a proximal bilateral PE, were treated by a successful thrombolysis with streptokinase.

D-dimers rate above 1200 µg/l and delay of admission > 12 days were reported as factors associated to thromboembolism events (respectively $P < 10^{-3}$ and $p = 0.045$).

Pulmonary embolism was associated to sever ARDS (at admission) ($p = 0.046$) and to mortality ($p = 0.035$).

Conclusions: Pulmonary embolism is a frequent complication in COVID 19 critically ill patients who associate numerous risk factors. This complication worsens the prognosis. A clinical follow up and biological monitoring specifically of the D-dimers is primordial to an early diagnosis.

Topic: Acute respiratory failure and mechanical ventilation

001249

Role of serum ferritin level in predicting short term outcome after moderate to severe traumatic brain injury in correlation to glasgow coma scale

W. Kamshishy¹

¹Critical Care Department, Faculty of Medicine Kasr Al-Ainy, Cairo University, Cairo, Egypt

Correspondence: W. Kamshishy

Intensive Care Medicine Experimental 2023, **11 (Suppl 1):001249**

Introduction: Traumatic brain injury is the most common cause of death and disability among young people. Severe TBI is associated with 30%–70% mortality rate. nevertheless, in clinical practice there are no effective biomarkers for the prediction of fatal outcome following TBI. Therefore, the aim was to determine whether serum ferritin level can be used as a prognostic marker and a predictor for management strategies in patients with traumatic brain injury.

Methods: This prospective cohort study enrolled 60 patients who suffered moderate (GCS 9–12) and severe (GCS 3–8) traumatic brain injury. The serum ferritin level was determined at ICU ad.

Results: High serum ferritin concentrations were significantly associated with low GCS scores, also there was a significant association between high serum ferritin levels and fatal outcome with values (393 ± 7 ng/ml for non-survivors and 314 ± 35 ng/ml for survivors, respectively. furthermore, ferritin level had significant relation with specific interventions in management as mechanical ventilation, hemodynamic support and neurosurgical.

Conclusions: High serum ferritin level is associated with low GCS scores and fatal outcome in patients with TBI, ferritin level could predict management strategies such as mechanical ventilation, hemodynamic support and neurosurgical intervention in patients with.

References

- Ghajar J. Traumatic brain injury. *Lancet* 2000; 356: 923–929. 2. Bruns J and Hauser WA. The epidemiology of traumatic brain injury: A review. *Epilepsia* 2003; 44: 2–10. 3. Arabi YM, Haddad S, Tamin HM, et al. Mortality reduction after implementing a clinical practice guidelines-based management protocol for severe traumatic brain injury. *Journal of Critical Care* 2010; 25: 190–195. 11 4. Coronado VG, Xu L, Basavaraju SV, et al. Centers for Disease Control and Prevention (CDC). Surveillance for traumatic brain injury-related deaths—United States, 1997–2007. *Morbidity and Mortality Weekly Report Surveillance Summaries* 2011; 60: 1–32. 5. Faul M, Xu L, Wald MM and Coronado GV. Traumatic brain injury in the United States: Emergency department visits, hospitalizations, and deaths, 2002–2006. Atlanta, GA: Centers for Disease Control and Prevention, National Center for Injury Prevention and Control; 2010. 6. Woertgen C, Rothoerl RD, Metz C and Brawanski A. Comparison of clinical, radiologic, and serum marker as prognostic factors after severe head injury. *The Journal of Trauma* 1999; 47: 1126–1130. 7. Regner A, Kaufman M, Friedman G and Chemale I. Increased serum S100beta protein concentrations following severe head injury in humans: A biochemical marker of brain death? *Neuroreport* 2011; 12: 691–694. 8. Raabe A, Kopetsch O, Wozszczyk A, et al. Serum S-100B protein as a molecular marker in severe traumatic brain injury. *Restorative Neurology and Neuroscience* 2003; 21: 3–4. 9. De Oliveira CO, Reimer AG, Da Rocha AB, et al. Plasma von Willebrand factor levels correlate with clinical outcome of severe traumatic brain injury. *Journal of Neurotrauma* 2007; 24: 1331–1338. 10. Campello VY, Ikuta N, Brondani da Rocha A, et al. Role of plasma DNA as a predictive marker of fatal outcome following severe head injury in males. *Journal of Neurotrauma* 2007; 24: 1172–1181. 11. Faden AI. Neuroprotection and traumatic brain injury: Theoretical option or realistic proposition. *Current Opinion in Neurology* 2002; 15: 707–712. 12. Morganti-Kossmann MC, Satgunaseelan L and Bye N, Kossmann T. Modulation of immune response by head injury. *Injury* 2007; 38: 139–1400. 13. Chen Y and Swanson RA. Astrocytes and brain injury. *Journal of Cerebral Blood Flow & Metabolism*. 2003; 23 (2): 137–49. 14. Liu HD, Li W, Chen ZR, et al. Increased expression of ferritin in cerebral cortex after human traumatic brain injury. *Neurological Science* 2013; 34: 1173–1180. 15. Lou M, Lieb K and Selim M. The relationship between hematoma iron content and perihematoma edema: An MRI study. *Cerebrovascular Diseases* 2009; 27: 266–271. 16. Beard JL. Iron biology in immune function, muscle metabolism and neuronal functioning. *Journal of Nutrition* 2001; 131: 568S–580S. 17. Hintze KJ and Theil EC. Cellular regulation and molecular interactions of the ferritins. *Cellular and Molecular Life Sciences* 2006; 63: 591–600. 18. Torti FM and Torti SV. Regulation of ferritin genes and protein. *Blood* 2002; 99: 3505–3516. 19. Sharkey RA, Donnelly SC, Connelly KG, et al. Initial serum ferritin levels in patients with multiple trauma and the subsequent development of acute respiratory distress syndrome. *American Journal of Respiratory and Critical Care Medicine* 1999; 159: 1506–1509. 20. Wang W, Knovich MA, Coffman LG, et al. Serum ferritin: Past, present and future. 2. Acknowledgment First and foremost, I feel always indebted to ALLAH, the Most Kind and Most Merciful. I'd like to express my respectful thanks and profound gratitude to Prof. Dr. Khaled Farouk Ibrahim, Assistant Professor of Critical Care Medicine, Critical Care Medicine Department, Cairo University for his keen guidance, kind supervision, valuable advice and continuous encouragement, which made possible the completion of this

work. I am also delighted to express my deepest gratitude and thanks to Dr. Ahmed Kamal Abbas, Lecturer of Critical Care Medicine, Critical Care Department, Cairo University, for his kind care, continuous supervision, valuable instructions, constant help and great assistance throughout this work. I am deeply thankful to Dr. Waleed Farouk Mahmoud, Lecturer of Critical Care Medicine, Critical Care Department, Cairo University, for his great help, active participation and guidance. I would like to express my hearty thanks to all my family for their support till this work was completed. Last but not least my sincere thanks and appreciation to all patients participated in this study. Waleed ElKamshishy

Topic: Trauma

001250

Coagulopathy in onco-hematology patients presenting with septic shock and initial thrombocytopenia: a retrospective observational study

A. Hugerot¹, R. Clere-Jehl², V. Castelain¹

¹Service de Médecine Intensive Réanimation, Hôpital de Hautepierre-Hôpitaux Universitaires de Strasbourg, Strasbourg, France;

²Service de réanimation, Nouvel Hôpital Civil-Hôpitaux Universitaires de Strasbourg, Strasbourg, France

Correspondence: A. Hugerot

Intensive Care Medicine Experimental 2023, **11 (Suppl 1)**:001250

Introduction: We studied the coagulation profile, based on routine hemostasis parameters, as well as clinical and biological outcomes of patients with hematologic malignancies hospitalized in the intensive care unit for septic shock with thrombocytopenia.

Methods: All patients admitted to the medical intensive care unit of Hautepierre hospital, Strasbourg, between 2015 and 2020 for septic shock, with thrombocytopenia < 100G/L and an evolving hematological disease were included in this retrospective cohort. For each patient, we collected hemostasis markers (platelets, INR, factor V, fibrinogen, D-dimer, antithrombin) within 24 h following admission, as well as mortality and occurrence of thrombotic or hemorrhagic events during the stay. Univariate and multivariate statistical analysis was performed.

Results: We included 149 patients, aged 58 ± 15 years, with mean SOFA score of 12.8 ± 2.9, respectively. Acute leukemia (45%; n = 67) and non-Hodgkin's lymphoma (38%; n = 57) were the most represented malignancies. Fifty-eight percent of patients required invasive mechanical ventilation (n = 86), and 28% required renal replacement therapy (n = 41). Neutropenia < 0.5 G/L was present in 59% of patients (n = 88). Eighty-six percent of patients (n = 116/135) had DIC according to the ISTH diagnostic score. Severe bleeding was encountered during the stay in 24% of patients (n = 35), and 7% of patients (n = 10) had venous or arterial thrombosis. Intensive care and in-hospital mortality were 46% (n = 68) and 52% (n = 77) respectively. Higher D-dimer, INR, ISTH and JAAM-DIC scores were associated with excess mortality in univariate analysis. High antithrombin activity was associated with the occurrence of severe bleeding events in multivariate analysis.

Conclusions: While confirming some previous data on sepsis-induced coagulopathy, established in patients without onco-hematological pathology, our study enlightens a very high bleeding risk in this onco-hematological population, in particular when antithrombin activity is high. Nevertheless, we currently lack relevant diagnostic tools to reliably establish the diagnosis of DIC and to study it in this population, which justifies a prospective study to establish a dedicated diagnostic score, in view of specific therapeutic trials.

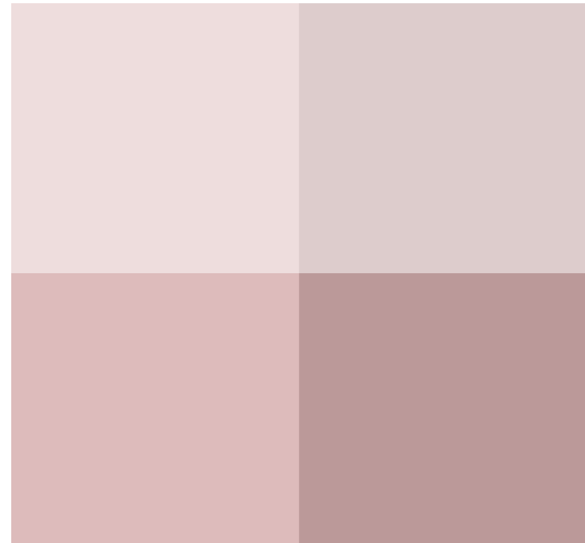

Topic: Haematologic-oncologic issues in the ICU

001251

Aerosol drug therapy practices in ARDS patients: a multicenter prospective observational cohort study

S. Singhal¹, M. Gurjar², N. J. Sahoo³, K. A. Sahoo⁴, S. Agarwal⁵, PS. Ghosh⁶, R. Dua⁷, A. Sharma⁸, S. Saran⁹, S. Arun¹⁰, K. Joshi¹¹, K. Deokar¹, N. Kothari⁶, PB. Rao⁴, P. Sivaramakrishnan⁷, U. Singh¹², P. Sridevi⁹, S. Mukherjee⁶, S. Dhivya⁸, C. Katoch¹

¹Pulmonary Medicine, AIIMS hospital, Rajkot, India; ²Intensive Care Medicine, Anjay Gandhi Post Graduate Institute of Medical Sciences, Lucknow, India; ³Critical Care Medicine, Apollo Hospitals, Bhubaneswar, India; ⁴Critical Care Medicine, AIIMS Bhubaneswar Trauma and Emergency Block, Bhubaneswar, India; ⁵Critical Care Medicine, Himalayan Institute of Medical Sciences, Bhanja Wala, India; ⁶Critical care Medicine, Tata Medical Center, Kolkata, India; ⁷Pulmonary Medicine, AIIMS Rishikesh Helipad, Rishikesh, India; ⁸Anaesthesia & critical care, All India Institute of Medical Sciences (AIIMS), Jodhpur, Jodhpur, India; ⁹Department of Critical Care Medicine, King George's Medical University, Lucknow, India; ¹⁰Critical Care Medicine, Rukmani Birla Hospital CK Birla, Jaipur, India; ¹¹Community and Family Medicine, AIIMS hospital, Rajkot, India; ¹²Critical Care Medicine, Sanjay Gandhi Postgraduate Institute of Medical Sciences, Lucknow, India

Correspondence: S. Singhal

Intensive Care Medicine Experimental 2023, **11 (Suppl 1)**:001251

Introduction: Despite the lack of high-level evidence, aerosol drug therapy is being used in clinical practices while managing acute respiratory distress syndrome (ARDS) patients.

Objectives: The study aimed to find out the practice pattern of aerosol drug therapy in ARDS patients.

Methods: This study is a secondary analysis of a multicenter, prospective observational cohort study in critically ill patients to know the practice pattern of aerosol drug delivery (AERO-IN-ICU/ED Study), which was conducted after ethics committee approval and registration

with the Clinical Trial Registry of India (CTRI/2022/09/045679). For the primary study, nine participating ICUs screened all adult patients who had received aerosol drug therapy having artificial airways with or without requiring invasive mechanical ventilation (IMV) or non-invasive ventilation (NIV) admitted during the four-week study period. Patients with ARDS were followed-up for 14 days or till ICU discharge (whichever comes first) for details of aerosol therapy, drug type, aerosol-generating device, and its placement in the ventilatory circuit.

Results: During the study period, 1474 patient days were followed in 218 studied patients. Of 218 patients, 53 (24.3%) had ARDS (67.9% due to pulmonary causes) and were followed up for 330 patient days with 193 IMV days and 115 NIV days. Most of these ARDS patients (96.2%) were admitted for medical reasons, 64.1% of the male gender, older age group (60.2 ± 14.76 years) with comorbidities (DM, hypertension, COPD, CAD) in 83.0%, APACHE II, and SOFA score of 17.4 ± 7.08 and 7.7 ± 4.03 respectively. 26 (49.0%) of these ARDS patients had a chronic respiratory disease before ICU admission, and only 21 (39.6%) were on aerosol therapy.

Of 53 patients with ARDS (190 ARDS days), 51 (96.2%; 183 ARDS days) received 1285 aerosols over 6.30 ± 3.96 days of ICU stay. Most aerosols (86.2%) were administered in three centers (out of nine).

Out of 1285 aerosol sessions, 71.4% were given while patients were on IMV (5 aerosols per IMV days; 185 IMV days) and 25.7% on NIV (3 aerosols per NIV day; 115 NIV days). Bronchodilators (70.4%; 60.1% were shorter acting), corticosteroids (21.9%), mucolytics (10.9%), and antibiotics (3.3%) were the most frequently used drugs as aerosol therapy. Jet nebulizers (45.1%) were the most commonly used aerosol generators, followed by ultrasonic (23.1%), venturi-mask nebulizers (18.5%), and oxygen (13.2%). Only 29% (88 out of 304) of aerosol therapy during IMV with jet nebulizers had placed aerosol generators at the optimum position (15 cm from Y-piece).

Conclusions: Aerosol therapy is being used frequently in ARDS patients. Bronchodilators are the most common drug. The jet nebulizer is the most familiar aerosol-generating device, with only one-fourth at the optimum position.

References

1. Fujishima S. Guideline-based management of acute respiratory failure and acute respiratory distress syndrome. J Intensive Care. 2023 Mar 10;11(1):10. <https://doi.org/10.1186/s40560-023-00658-3>.
2. 1. Tasaka S, et al.: ARDS Clinical Practice Guideline 2021 committee from the Japanese Society of Intensive Care Medicine, the Japanese Respiratory Society, and the Japanese Society of Respiratory Care Medicine. ARDS Clinical Practice Guideline 2021. J Intensive Care. 2022 Jul 8;10(1):32. <https://doi.org/10.1186/s40560-022-00615-6>.
3. None

Topic: Acute respiratory failure and mechanical ventilation

001252

The effect of preperitoneal pelvic packing in patients with hemodynamic instability due to severe pelvic fracture: 8 years-experience in a Korea trauma center

H. Shim¹, G. S. Ha¹, J. S. Jung²

¹Trauma and Surgical Critical Care, Armed Forces Capital Hospital, Seongnam-si, Republic of Korea; ²Trauma and Surgical Critical Care, Severance Hospital, Yonsei University Wonju Christian Hospital, Wonju, Republic of Korea

Correspondence: H. Shim

Intensive Care Medicine Experimental 2023, 11 (Suppl 1):001252

Introduction: The mortality rate of the patients suffered from severe pelvic bone fracture is reported to be 40~60%. Recently, PPP become The mortality rate of the patients suffered from severe pelvic bone fracture is reported to be 40~60%. Recently, Preperitoneal pelvic packing (PPP) has shown positive results as a new strategy to decrease exsanguinous mortality for the severely injured pelvic bone fracture. As the mortality of pelvic injury combines many factors, evaluation for the effect of PPP is difficult.

Objectives: This study was designed to evaluate PPP effect based on the 8 year-experience in a level-1 trauma center.

Methods: Between march. 2014 and December. 2021, 151 patients with hemodynamic instability caused by pelvic fracture were enrolled in this study. Using the electrical chart review, the data were collected retrospectively, and the effects of PPP were analyzed through propensity score matching.

Results: Mean age and mean ISS were 61 (49–73) years and 34 (25–38). Mean lactate and initial Hb level were 4,5 (2,8–8,4) and 10.8 (9.1–12.6) g/dL. 51 patients were managed by PPP and the other were not managed by PPP. (Only-resuscitation, angioembolization).

After matching by Propensity score, PPP-group (49 patients) and non-PPP group (49 patients) were compared each other. Other demographics were not significantly different each other. Overall mortality (PPP vs. non-PPP 24 (49%) vs. 19 (38.8%), $p=0.25$), bleeding-mortality (13 (26.5%) vs. 15 (30.6%), $p=0.64$), and 28 day-mortality (22 (44.9%) vs. 17 (34.7%), $p=0.28$) were not different between two groups. PPP group showed a tendency of lower mortality due to bleeding and lower Odd-ratio (OR 0.82, $p=0.65$) than non-PPP group, however these did not have statistically significance.

Conclusions: In unstable patients with pelvic fracture, PPP does not show the effect definitively to the mortalities yet. Prospective randomized control study is needed to evaluate the effect of PPP.

Variables	Total (n=151)	iPPP 여부		P-value
		No (n=98)	Yes (n=53)	
Age	61 (49 – 73)	61 (49 – 74)	59 (48 – 73)	0.431
Sex				0.501
Male	77 (51)	48 (49)	29 (54.7)	
Female	74 (49)	50 (51)	24 (45.3)	
SBP	79 (64 – 93)	81 (67 – 98)	77 (60 – 85)	0.023
DBP	47 (35 – 60)	48 (35 – 63)	45 (35 – 55)	0.228
MBP	56.7 (45 – 70)	58.7 (46.7 – 74)	55 (45 – 67)	0.112
PR	105 (88 – 120)	100.5 (84 – 114)	111 (93 – 125)	0.022
ISS	34 (25 – 38)	29 (25 – 38)	36 (29 – 43)	0.004
Hb	10.8 (9.1 – 12.6)	11 (9.5 – 12.6)	10.2 (8.2 – 12.9)	0.121
Lactate	4.5 (2.8 – 8.4)	3.9 (2.4 – 6.6)	6.1 (4.2 – 10.4)	<0.001
LOS	24 (4 – 50)	24 (10 – 43)	20 (2 – 58)	0.578
ICU LOS	7 (2 – 15)	6.5 (3 – 13)	7 (2 – 19)	0.739
Mortality-total				0.005
No	102 (67.5)	74 (75.5)	28 (52.8)	
Yes	49 (32.5)	24 (24.5)	25 (47.2)	0.319
Bleeding death				0.319
No	118 (78.1)	79 (80.6)	39 (73.6)	
Yes	33 (21.9)	19 (19.4)	14 (26.4)	
Mortality-28days				0.009
No	108 (71.5)	77 (78.6)	31 (58.5)	
Yes	43 (28.5)	21 (21.4)	22 (41.5)	
Injury type				0.002
APC	25 (16.6)	16 (16.3)	9 (17)	
LC	104 (68.9)	75 (76.5)	29 (54.7)	
VS	22 (14.6)	7 (7.1)	15 (28.3)	
Transfusion	6 (2 – 12)	4 (2 – 11)	10 (8 – 16)	<0.001

Variables	Before PPP				After PPP				P-value	Standardized mean difference
	Total (n=98)	No (n=53)	Yes (n=45)	P-value	Total (n=98)	No (n=53)	Yes (n=45)	P-value		
Age	61 (49-73)	61 (49-74)	59 (48-73)	0.431	60.5 (48-74)	61 (49-77)	59 (48-73)	0.869	0.121	
Sex				0.501				0.670	0.001	
Male	77 (51)	48 (49)	29 (54.7)		50 (51)	24 (46)	26 (53.1)			
Female	74 (49)	50 (51)	24 (45.3)		48 (49)	25 (47)	23 (46.9)		0.173	
SBP	79 (64-93)	81 (67-98)	77 (60-85)	0.023	75.5 (60-85)	73 (61-87)	74 (59-90)	0.209	0.173	
DBP	47 (35-60)	48 (35-63)	45 (35-55)	0.228	43 (33-53)	42 (32-55)	43 (35-50)	0.475	0.117	
MBP	56.7 (45-70)	58.7 (46.7-74)	55 (45-67)	0.112	54 (45-65)	53 (44-65)	52 (44-64)	0.900	0.000	
PR	105 (88-120)	100.5 (84-114)	111 (93-125)	0.022	107.8 (84-122)	101 (80-117)	111 (91-125)	0.369	0.275	
ISS	34 (25-38)	29 (25-38)	36 (29-43)	0.004	29 (26-35)	32 (26-38)	32 (26-38)	0.317	0.044	
Hb	10.8 (9.1-12.6)	11 (9.5-12.6)	10.2 (8.2-12.9)	0.121	11 (9.5-12.6)	10.2 (8.2-12.9)	10.2 (8.2-12.9)	0.866	0.000	
Lactate	4.5 (2.8-8.4)	3.9 (2.4-6.6)	6.1 (4.2-10.4)	<0.001	3.9 (2.4-6.6)	3.9 (2.4-6.6)	3.9 (2.4-6.6)	0.866	0.000	
LOS	24 (4-50)	24 (10-43)	20 (2-58)	0.578	23 (12-40)	23 (12-40)	23 (12-40)	0.963	0.102	
ICU LOS	7 (2-15)	6.5 (3-13)	7 (2-19)	0.739	6 (3-13)	6 (3-13)	7 (2-17)	0.984	0.228	
Mortality-total				0.005				0.901	0.002	
No	102 (67.5)	74 (75.5)	28 (52.8)		74 (75.5)	30 (56.6)	25 (51)			
Yes	49 (32.5)	24 (24.5)	25 (47.2)		24 (24.5)	18 (33.4)	20 (41)		0.637	
Bleeding death				0.319				0.319	0.002	
No	118 (78.1)	79 (80.6)	39 (73.6)		79 (80.6)	30 (56.6)	30 (75)			
Yes	33 (21.9)	19 (19.4)	14 (26.4)		19 (19.4)	15 (28.3)	15 (31)		0.041	
Mortality-28days				0.009				0.275	0.205	
No	108 (71.5)	77 (78.6)	31 (58.5)		77 (78.6)	27 (51)	27 (55.1)			
Yes	43 (28.5)	21 (21.4)	22 (41.5)		21 (21.4)	17 (32.5)	22 (44.9)		0.063	
Injury type				0.002				0.002	0.183	
APC	25 (16.6)	16 (16.3)	9 (17)		16 (16.3)	6 (11.2)	6 (12.2)			
LC	104 (68.9)	75 (76.5)	29 (54.7)		75 (76.5)	30 (56.6)	27 (55.1)			
VS	22 (14.6)	7 (7.1)	15 (28.3)		15 (15.1)	11 (20.2)	14 (28.3)			
Transfusion	6 (2-12)	4 (2-11)	10 (8-16)	<0.001	4 (2-11)	4 (7.6)	6 (12.2)		0.064	

1. iPPP Mortality_total

Variables	OR (95% CI)	p-value
iPPP		
No	Ref.	
Yes	1.516 (0.679 – 3.382)	0.310

OR, odds ratio; CI, confidence interval; Ref., reference

2. iPPP Bleeding_death

Variables	OR (95% CI)	p-value
iPPP		
No	Ref.	
Yes	0.819 (0.340 – 1.970)	0.655

OR, odds ratio; CI, confidence interval; Ref., reference

3. iPPP Mortality_28days

Variables	OR (95% CI)	p-value
iPPP		
No	Ref.	
Yes	1.534 (0.679 – 3.462)	0.303

OR, odds ratio; CI, confidence interval; Ref., reference

Variables	Total (n=65)	iPPP (n=53)	dPPP (n=12)	P-value
Age	59 (47 – 73)	59 (48 – 73)	65.5 (46 – 77.5)	0.738
Sex				0.767
Male	35 (53.8)	29 (54.7)	6 (50)	
Female	30 (46.2)	24 (45.3)	6 (50)	
SBP	75 (69 – 84)	77 (60 – 85)	70.5 (53 – 77)	0.306
DBP	45 (35 – 56)	45 (35 – 55)	40 (31.5 – 57.5)	0.637
MBP	55 (43.7 – 66)	55 (45 – 67)	51.2 (39.5 – 62.7)	0.523
PR	113 (91 – 123)	111 (93 – 125)	113.5 (78 – 122)	0.470
ISS	36 (29 – 45)	36 (29 – 43)	39 (34.5 – 55.5)	0.142
Hb	10.2 (8.2 – 12.5)	10.2 (8.2 – 12.9)	10.1 (8.2 – 12.2)	0.517
Lactate	5.7 (3.9 – 9.9)	6.1 (4.2 – 10.4)	3.8 (3 – 7.9)	0.117
LOS	17 (2 – 53)	20 (2 – 58)	2 (1 – 28.5)	0.094
ICU LOS	6 (1 – 17)	7 (2 – 19)	2 (1 – 12.5)	0.150
Mortality-total				0.223
No	32 (49.2)	28 (52.8)	4 (33.3)	
Yes	33 (50.8)	25 (47.2)	8 (66.7)	
Bleeding death				0.165
No	45 (69.2)	39 (73.6)	6 (50)	
Yes	20 (30.8)	14 (26.4)	6 (50)	
Mortality-28days				0.114
No	35 (53.8)	31 (58.5)	4 (33.3)	
Yes	30 (46.2)	22 (41.5)	8 (66.7)	
Injury type				1.000
APC	11 (16.9)	9 (17)	2 (16.7)	
LC	36 (55.4)	29 (54.7)	7 (58.3)	
VS	18 (27.7)	15 (28.3)	3 (25)	
Transfusion	10 (6 – 16)	10 (6 – 16)	11 (6 – 17.5)	0.550

References

- Shim, Hongjin, et al. "Effectiveness and postoperative wound infection of preperitoneal pelvic packing in patients with hemodynamic instability caused by pelvic fracture." *PloS one* 13.11 (2018): e0206991.
- Jang JY, Shim HJ, Jung PY, Kim SY, Bae KS. Preperitoneal pelvic packing in patients with hemodynamic instability due to severe pelvic fracture: early

experience in a Korean trauma center. *Scandinavian J Trauma, Resusc and Emerg med* 2016;24:3

- Giannoudis PV, Pape HC. Damage control orthopaedics in unstable pelvic ring injuries. *Injury*. 2004;35:671–7
- Sathy AK, Starr AJ, Smith WR, Elliott A, Agudelo J, Reinert CM, et al. The effect of pelvic fracture on mortality after trauma: an analysis of 63,000 trauma patients. *J Bone Joint Surgery Am Vol*. 2009;91:2803–10

Topic: Trauma

001255

Anticoagulation and bleeding during VV ECMO: differences among COVID-19 and non covid patients in the PROTECMO cohort

G. Martucci¹, M. Giani², J. Riera del Brio³, P. Schellongowski⁴, G. Grasselli⁵, C. Agerstrand⁶, R. Ramanan⁷, A. A. Hssain⁸, S. Buabbas⁹, W. Gannon¹⁰, G. Vojka¹¹, F. Tuzzolino¹², G. De Pascale¹³, V. Fanelli¹⁴, R. Lorusso¹⁵, M. Schmidt¹⁶, D. Brodie¹⁷, A. Arcadipane¹⁸
¹Anesthesia and Intensive Care Unit, ISMETT, Palermo, Italy; ²Dipartimento di emergenza e urgenza, ASST Monza, University Of Milano-Bicocca, Monza, Italy; ³Critical Care Department, Vall d'Hebron University Hospital, Barcelona, Spain; ⁴Department of Medicine i, Medical University of Vienna, Wien, Austria; ⁵Intensive Care Unit, Policlinico of Milan, Milan, Italy; ⁶Medical ECMO Program, Columbia University, New York, United States of America; ⁷Critical Care, UPMC Presbyterian, Pittsburgh, United States of America; ⁸ICU, Hamad Medical Corporation, Doha, Qatar; ⁹ICU, Ministry of Health, Kuwait; ¹⁰Department of Allergy, Pulmonary, and Critical Care Medicine, Vanderbilt University Medical Center, Nashville, United States of America; ¹¹Micu, University Medical Center, Ljubljana, Zaloška cesta, Ljubljana, Slovenia, Ljubljana, Slovenia; ¹²Research Office, IRCCS-ISMETT, Palermo, Italy; ¹³Dipartimento di scienze dell'emergenza, anesthesiologiche e della rianimazione, Fondazione Policlinico Universitario A. Gemelli IRCCS, Rome, Italy; ¹⁴Surgical Sciences Department, Città della Salute e della Scienza, University of Torino, Turin, Italy; ¹⁵Cardiothoracic Surgery, Heart and Vascular Center, Munc+ , Maastricht, Netherlands; ¹⁶Service de Reanimation Medicale, Paris University, Paris, France; ¹⁷Intensive Care, Columbia University College of Physicians and Surgeons/New York-Presbyterian Hospital, New York, United States of America; ¹⁸Anesthesia and Intensive Care Unit, IRCCS-ISMETT, Palermo, Italy

Correspondence: G. Martucci

Intensive Care Medicine Experimental 2023, 11 (Suppl 1):001255

Introduction: Anticoagulation therapy is necessary during VV ECMO to prevent thrombus formation in the circuit and oxygenator because the contact of blood with an extracorporeal surface and shear stress can trigger activation of the coagulation system. The modality of anticoagulation is still under debate and guidelines do not give clear cut suggestions. However hemorrhagic complications continue to pose serious challenges and the COVID-19 pandemic has further complicated the picture with its pathophysiological increase in the risk of thrombosis.

Objectives: To describe the type of anticoagulation and bleeding events in a cohort of patients undergoing VV ECMO for several causes of acute respiratory failure (ARF) and define the differences on this topic among patients affected with COVID-19 and other causes of ARF.

Methods: Multicenter prospective observational international cohort study of consecutive V-V ECMO patients enrolled by 41 centers in 19 countries from December, 2018, to December, 2020. Patients were divided in two groups according to the presence of COVID-19 infection as a cause of ARF or other causes of ARF. Bleeding episodes were described according to severity with adjusted categories of the Bleeding Academic Research Consortium score. Type 1: requiring heparin infusion rate reduction or packed red blood cells transfusion (PRBC) transfusion; 2: bleeding requiring heparin infusion rate reduction and PRBC transfusion or non-surgical procedure to stop bleeding; 3: life-threatening bleeding that required PRBC transfusion and surgical intervention for control of bleeding or ECMO discontinuation; Type 4: fatal bleeding.

Results: 652 adults under VV ECMO were enrolled, and data of 8471 days on ECMO were analyzed. Among them 218 were affected

with COVID-19 and 434 had other causes of ARF. COVID patients were older [53 (43–60) vs 51 (38–60)], were more frequently males [n 181 (83%) vs 282 (65%)], had higher BMI [29.4 kg/m² (26.2–35.5) vs 27.8 (24.3–33)] and were on mechanical ventilation for longer prior ECMO [4 days (1.7–6.7) vs 1.5 (0.4–4.2)]; all p values < 0.01.

During the ECMO stay in both groups the most used anticoagulant drug was unfractionated heparin (UFH) [195 patients (89.5%) in the COVID group and 311 (71.7%) in the others] but in the COVID group an initial strategy without anticoagulation was less frequent [14 patients (11.5%) vs 108 (24.9%); p < 0.01. This was confirmed during the ECMO stay since COVID patients were less frequently without any anticoagulant: 560/3619 days (15.5%) vs 1032/4852 days (21.3%), p < 0.01. This was accompanied by higher anticoagulant dose and higher activated partial thromboplastin time (aPTT): 54.9 s (53.1–56.6) vs 49.6 (47.8–51.3); p < 0.01.

Generally, a higher number of COVID patients had at least one episodes of bleeding: 127 (58%) vs 215 (50), p = 0.04; also considering the days on ECMO, COVID group had a significant higher rate of bleeding: 548/3619 days (15%) vs 654/5852 (13.5%), p = 0.03. However, the average of days with bleeding during the ECMO stay was similar between the two groups either including (14% of days with bleeding in COVID group versus 13% in the Others group, p = 0.58) or excluding patients without any bleeding.

The severity of bleeding episodes was also similar between the groups. COVID group (548 bleeding episodes): Type 1 n 330 (60%), Type 2 n 172 (32), Type 3 n 36 (7); Type 4 n 9 (2); OTHER CAUSES group: Type 1 n 399 (61%), Type 2 n 191 (29), Type 3 n 57 (9); Type 4 n 7 (1); p value = 0.38.

As expected comparing to other series, COVID patients had a longer duration of ECMO support: 20.7 days (18.3–23.1) vs 13.1 (11.7–14.6); p < 0.01.

Finally, patients on VV ECMO for COVID-19 had a worst outcome: lower rate of successful weaning [120 patients (55%) vs 325 patients (75%) in the OTHERS group; p < 0.01.

Conclusions: In two synchronous population of VV ECMO patients for ARF due to COVID-19 or other causes, we confirm that COVID-19 is associated with more bleeding. This tendency is also sustained by the occurrence of prolonged ECMO support.

References

1. PROTECMO study was endorsed by ESICM and the International ECMO Network (ECMONet); and funded by a 2019 ELSO grant. We acknowledge the hard work of all the participants of the PROTECMO study group.

Topic: Transfusion and haemostasis disorders

001256

Physical function measures in ICU survivors, where to now?

A scoping review

I. Du Plessis¹, S. Hanekom¹, A. Lupton-Smith¹

¹Physiotherapy, Stellenbosch University, Stellenbosch, South Africa

Correspondence: A. Lupton-Smith

Intensive Care Medicine Experimental 2023, **11** (Suppl 1):001256

Introduction: There is growing evidence describing the long-term morbidity experienced by critical illness survivors. A major contributing factor to this morbidity is impaired physical function. (Needham et al., 2012; Yuan, Timmins and Thompson, 2021) Consensus is yet to be reached on which physical function measures should be used in this population. (Needham et al. 2017) The heterogeneity and inconsistencies in measurement of physical function in this population makes it difficult for researchers to fully understand and quantify problems in physical function.

Objectives: This review aimed to describe which physically tested measurement instruments have been used in longitudinal studies of critical illness survivors to determine impairments, activity limitations and participation restrictions related to physical functioning.

Methods: A scoping review was conducted using the methodology as per the Joanna Briggs Institute (2015). An electronic database search of EbscoHost, Web of Science and Scopus was conducted from inception to August 2022. Two reviewers independently applied the inclusion and exclusion criteria to all titles, abstracts and articles. Extracted data included year of publication; country; age of participants; follow up timeframes and physical measurement instruments used. Instruments were further classified and coded according to the International Classification of Functioning (ICF).

Results: Sixty four articles published between 1995 and August 2022 were included. Majority of studies arose from high income countries. Thirty-nine different outcome measures were identified and used at variable follow-up intervals (1–60 months). Most studies (52, 81.3%) included multiple follow-up points and were completed within a year, few studies (12, 18.7%) extended beyond a year. Based on the ICF framework, 11 (28.2%) instruments measured impairments and 28 (71.8%) activity limitations. The most frequently measured physical impairment was muscle strength (61, 95.3%), frequently measured with manual muscle testing (30, 46.9%) and/or dynamometry (30, 46.9%). The six minute walk test was the most frequently used instrument in the activity and participation domain, used in 30 (46.9%) studies. Only one (2.5%) instrument addressed all components of the activity/participation domains, majority focused on one aspect, namely mobility. Instruments (3, 7.6%) that addressed several subdomains of activity/participation were seldom used in studies.

Conclusions: Multiple tools are used to report on functional deficits experienced by survivors. The tools measure either impairments or activity/participation limitations. All domains of physical functioning are seldom measured concurrently. Most studies only report on physical function within the first year of survival. Moving forward, consensus is needed on which tools to use to allow for comprehensive understanding of physical functioning in survivors and inform the development of intervention studies.

References

1. Needham, D.M. et al. (2012) 'Improving long-term outcomes after discharge from intensive care unit: Report from a stakeholders' conference', *Critical Care Medicine*, 40 (2), pp. 502–509. Available at: <https://doi.org/10.1097/CCM.0b013e318232da75>.
2. None
3. Needham, D.M. et al. (2017) 'Core outcome measures for clinical research in acute respiratory failure survivors an international modified delphi consensus study', *American Journal of Respiratory and Critical Care Medicine*, 196 (9), pp. 1122–1130. Available at: <https://doi.org/10.1164/rccm.201702-0372OC>.
4. Yuan, C., Timmins, F. and Thompson, D.R. (2021) 'Post-intensive care syndrome: A concept analysis', *International Journal of Nursing Studies*. Elsevier Ltd. Available at: <https://doi.org/10.1016/j.ijnurstu.2020.103814>.

Topic: Nursing care and physiotherapy

001257

Mental illness and fatigue at 3 and 12 months post intensive care among critically ill COVID-19 survivors

H. Malin¹, D. Ingrid², A. C. Håkansson³, S. Andertun⁴, M. Erik⁵, M. Nelderup⁴, A. Nilsson⁶, A. Reepalu⁶, M. Spångfors⁷, H. Friberg², G. Lilja¹

¹Neurology, Department of Clinical Sciences Lund, Skåne University Hospital, Lund University, Lund, Sweden; ²Department of Intensive and Perioperative Care, Skåne University Hospital, Lund University, Lund, Sweden; ³Malmö Addiction Center, Clinical Research Unit, Skåne University Hospital, Lund University, Lund, Sweden; ⁴Department of anesthesia and intensive care medicine, Helsingborgs hospital, Helsingborg, Sweden; ⁵Department of Infectious Diseases, Skåne University Hospital, Lund, Sweden; ⁶Department of Infectious Diseases, Skåne University Hospital, Malmö, Sweden; ⁷Department of anaesthesia and intensive care, Kristianstad Hospital, Kristianstad, Sweden

Correspondence: H. Malin

Introduction: Individuals with severe COVID-19 are at risk of developing prolonged symptoms. Well-performed studies presenting long-term data on mental health and fatigue among patients with critically ill COVID-19 are scarce.

Objectives: To investigate patient-reported symptoms of mental illness and fatigue at 3 and 12 months after critical COVID-19 with respiratory failure, and to describe the dynamics of symptoms during this time. A secondary aim was to investigate risk-factors for post-COVID mental illness and fatigue at 12 months.

Methods: Data from the prospective, multicenter SWECRIT COVID-19 study in southern Sweden was used. For this study patients ≥ 18 years with PCR-confirmed COVID-19 requiring critical care and a P/F-ratio ≤ 40 kPa were included at six intensive care units between May 2020 and May 2021. At 3 and 12 months after acute COVID-19, survivors were invited to a clinical follow-up. Patient-reported symptoms were assessed with the Hospital Anxiety and Depression Scale, the Post-traumatic Stress Disorder Checklist version 5 and the Modified Fatigue Impact Scale. Significant symptoms were identified using established cut-offs and changes were identified by use of reference values for a minimally important difference (MID). Potential risk factors were analyzed by using multivariable logistic regression and included acute disease severity, comorbidities and functional outcome as assessed by the Glasgow Outcome Scale Extended.

Results: 262/301 (87%) survivors participated in the 3-month follow-up and 215/300 (72%) at 12 months. Symptoms of mental illness were common at both 3 and 12 months; anxiety in 33% vs. 28%, depression in 30% vs. 22%, and post-traumatic stress disorder in 17% vs. 13%, with no statistically significant difference between 3 and 12 months (Table 1). Fatigue was the most common symptom on both occasions, 50% vs. 40%, with a statistically significant difference between 3 and 12 months ($p < 0.001$). The improvement in fatigue reached the threshold for a MID (median 38 vs. 33, MID ≥ 4). The dynamics of symptoms are seen in Figure 1. Poorer functional outcome and sleeping difficulties were risk factors for symptoms of mental illness and fatigue at 12 months.

Conclusions: Survivors of critical COVID-19 with respiratory failure commonly experience symptoms of mental illness and fatigue up to 12 months, with a significant improvement in fatigue between 3- and 12-months. Participants reporting poorer functional outcome and less sleep are at particular risk.

Table 1 (abstract 001257) Median score from the questionnaires included in the study and the number of patients who scored at the cut-off or higher in individual questionnaires at 3 and 12 months. Bold text signifies significant value. A p-value < 0.05 was considered significant. IQR, interquartile range. 3M, 3 months. 12M, 12 months. PTSD, post-traumatic stress disorder

Outcome	Total score 3M		Total score 12M		Related samples Wilcoxon Signed rank test, p-value
	median [IQR]	Above cut-off 3M n (%)	median [IQR]	Above cut-off 12M n (%)	
Anxiety	5 [2-9]	75/229 (33)	4 [2-8]	54/193 (28)	.19
Depression	4 [1-9]	68/229 (30)	4 [1-7]	43/193 (22)	.17
PTSD	11 [5-26]	38/220 (17)	10 [4-22]	25/189 (13)	.09
Fatigue	38 [22-53]	115/229 (50)	33 [16-46]	76/190 (40)	<.001

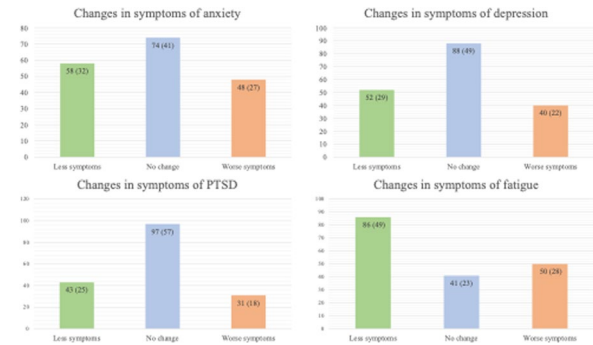

Figure 1 (abstract 001257) Histograms depicting the dynamic of symptoms of mental illness and fatigue between the clinical follow-up at 3 months and 12 months shown as n (%) and categorized by the minimally important difference (MID) in the respective questionnaire. MID for the Hospital Anxiety and Depression Scale: ≥ 2, n = 180. MID for the Post-Traumatic Stress Disorders Checklist: ≥ 6 MID, n = 171. MID for the Modified Fatigue Impact Scale: ≥ 4, n = 177. Abbreviations PTSD, post-traumatic stress disorder

References

- Neufeld KJ, Leoutsakos JS, Yan H, Lin S, Zabinski JS, Dinglas VD, et al. Fatigue Symptoms During the First Year Following ARDS. *Chest*. 2020;158 (3):999–1007.
- O’Mahoney LL, Routen A, Gillies C, Ekezie W, Welford A, Zhang A, et al. The prevalence and long-term health effects of Long Covid among hospitalised and non-hospitalised populations: a systematic review and meta-analysis. *eClinicalMedicine*. 2023;55.
- Weathers FW, Litz, B.T., Keane, T.M., Palmieri, P.A., Marx, B.P., & Schnurr, P.P. The PTSD Checklist for DSM-5 (PCL-5). National Center for PTSD 2013 [2022–02-22]. Available from: <https://www.ptsd.va.gov/professional/assessment/adult-sr/ptsd-checklist.asp>.
- Huang M, Parker AM, Bienvenu OJ, Dinglas VD, Colantuoni E, Hopkins RO, et al. Psychiatric Symptoms in Acute Respiratory Distress Syndrome Survivors: A 1-Year National Multicenter Study. *Crit Care Med*. 2016;44 (5):954–65.
- Fisk JD, Ritvo PG, Ross L, Haase DA, Marrie TJ, Schlech WF. Measuring the functional impact of fatigue: initial validation of the fatigue impact scale. *Clin Infect Dis*. 1994;18 Suppl 1:S79-83.
- Structured Interviews for the Glasgow Outcome Scale and the Extended Glasgow Outcome Scale: Guidelines for Their Use. *Journal of Neurotrauma*. 1998;15 (8):573–85.
- Heesakkers H, van der Hoeven JG, Corsten S, Janssen I, Ewalds E, Simons KS, et al. Clinical Outcomes Among Patients With 1-Year Survival Following Intensive Care Unit Treatment for COVID-19. *JAMA*. 2022.
- Zigmond AS, Snaith RP. The Hospital Anxiety and Depression Scale. *Acta Psychiatrica Scandinavica*. 1983;67 (6):361–70.
- Needham DM, Sepulveda KA, Dinglas VD, Chessare CM, Friedman LA, Bingham CO, 3rd, et al. Core Outcome Measures for Clinical Research in Acute Respiratory Failure Survivors. An International Modified Delphi Consensus Study. *Am J Respir Crit Care Med*. 2017;196 (9):1122–30.
- Weathers F, Litz B, Herman D, Huska JA, Keane T. The PTSD Checklist (PCL): Reliability, validity, and diagnostic utility. Paper Presented at the Annual Convention of the International Society for Traumatic Stress Studies. 1993.

11. The study has been funded by the Swedish national health service (ALF), regional funding from the healthcare region Region Skåne, and the Swedish Heart–lung Foundation.

Topic: Acute respiratory failure and mechanical ventilation

001259

Incidence of thrombotic complications and mortality in patients with severe SARS-CoV2 pneumonia: differences between vaccinated and not vaccinated patients

C. M. Bledig¹, M. A. Alonso Fernandez², I. Bartolomé Martín³, M. Manso-áLvarez⁴, R. Gómez Guardiola¹, NP. Marcos⁵, M. Quintana Diaz⁶, S. Campillo Morales⁷, A. Serrano Lazaro⁸, M. Gero-Escapa⁹, JA. Silva Obregón¹⁰, E. Portugal Rodríguez¹¹, Ó. Martínez González², M. Chana-García², B. López-Matamala², S. Sánchez López², C. Martín-Parra², R. Blancas²

¹Medicine, Alfonso X El Sabio University Campus of Villanueva de la Cañada, Villanueva de la Cañada, Spain; ²Critical Care Department, Hospital del Tajo, Aranjuez, Spain; ³Geriatric Unit, University Hospital of Guadalajara, Guadalajara, Spain; ⁴Critical Care Department, Hospital Universitario del Tajo, Aranjuez, Spain; ⁵Intensive Care Unit, Hospital Germans Trias i Pujol, Badalona, Spain; ⁶Critical Care Department, Hospital Universitario La Paz, Madrid, Spain; ⁷Patient Blood Management Investigation Group, Hospital Universitario La Paz, Madrid, Spain; ⁸Intensive care unit, Hospital Clínic Universitari de València, València, Spain; ⁹Intensive care, Hospital Universitario de Burgos, Burgos, Spain; ¹⁰Intensive care, Hospital Universitario de Guadalajara, Calle Donante de Sangre, Guadalajara, Spain, Guadalajara, Spain; ¹¹Intensive care, Hospital Clínic, Valladolid, Spain

Correspondence: M.A. Alonso Fernandez

Intensive Care Medicine Experimental 2023, **11 (Suppl 1):**001259

Introduction: The most effective measure for COVID-19 pandemic containment has been vaccination. All vaccines currently developed have demonstrated their safety and efficacy in preventing new infections, admission to the ICU, and mortality, although their effect on thrombotic events in critically ill patients has not been described.

Objectives: Describe and analyze the incidence of thrombotic complications in vaccinated and not vaccinated patients against COVID-19 admitted to the ICU. Describe and analyze length of ICU and hospital stay and mortality in vaccinated and not vaccinated patients against COVID-19, admitted to the ICU due to severe SARS-CoV-2 pneumonia.

Methods: Multicentre, prospective, descriptive, observational study. All vaccinated and not vaccinated patients against COVID-19 admitted to the ICU due to severe SARS-CoV-2 pneumonia after the start of vaccination in Spain were included. Patients whose vaccination status was unknown were excluded. Full vaccination definition: onset of covid 19 symptoms 14 days after the second vaccine dose.

Results:

Thrombosis, length of stay and mortality outcomes

	Not Vaccinated	Incompletely Vaccinated	Fully Vaccinated
Thrombosis % (n)	23.5 (20)	8.5 (4)	5 (1)
Arterial % (n)	7.1 (6)	0	0
Venous % (n)	16.5 (14)	8.5 (4)	5 (1)
Hospital stay	23 (16–39)	20.5 (15.2–27.5)	26 (13–40.5)
ICU stay	14 (7–24)	9 (5–15)	11 (3–31.5)
Mortality% (n)	29.3 (36)	4.3 (2)	36 (9)

Patients general Characteristics

	Not Vaccinated	Incompletely Vaccinated	Fully Vaccinated
Men %	61.1	57.7	50
Age (IQ range)	62.7 (46.9–67.2)	63 (57.4–72.1)	63 (57.4–72.1)
BMI (IQ range)	29.2 (25–34)	29.4 (25.2–33.8)	28.1 (25–28.9)
HBP %	46.5	27.5	61.5
DM %	30.6	18	30.8
Heart Disease %	14.3	9.8	34.6
Respiratory Disease %	16.9	15.4	19.2
Anticoagulation %	2.2	3.8	0
Antiaggregation %	10.2	3.8	16
APACHE II	10 (7–15)	8 (6–10)	10 (7–13.5)

603 patients admitted to ICU. 399 patients excluded. 204 patients included in the analysis: 78 (38.2%) vaccinated and 26 (12.6%) fully vaccinated. Patient’s general characteristics are described in Table 1. Quantitative variables are expressed as median (interquartile range) and categorical variables are expressed as percentage. Outcomes are described in Table 2. Increase of one unit on the APACHE II score increases the risk of developing thrombosis by 13.2% (OR 1,132; IC 95%: 1,050–1,222; *p* = 0,001). The incidence of thrombosis is lower in vaccinated patient but there are not association of thrombosis with vaccination. Not statistically significant relationship between thrombotic events or vaccination with ICU and hospital stay. Not statistically significant association between thrombotic events and mortality. Mortality association with age and vaccination status. For each year that age increases, probability of dying increases by 9.2% (OR 1,092; IC 95%: 1,049–1,136; *p* < 0,001). Being fully vaccinated, probability of dying decreases 10.2 times (OR 0,098; IC 95%: 0,018–0,524; *p* = 0,007).

Conclusions: In our cohort: The increase in the APACHE II score on admission increases the probability of developing thrombosis. Mortality has no association with thrombotic events. Complete vaccination schedule decreases the probability of dying.

References

- Tavares EP, Rebolo JR, Pimentel R, Roncon-Albuquerque RL Jr. Bleeding and Thrombotic Complications in COVID-19-Associated ARDS Requiring ECMO. *Respir Care*. 2023 May;68 (5):575–581.
- Fanning JP, Weaver N, Fanning RB, Griffee MJ, Cho SM, Panigada M, Obonyo NG, Zaaqq AM, Rando H, Chia YW, Fan BE, Sela D, Chiumello D, Coppola S, Labib A, Whitman GJR, Arora RC, Kim BS, Motos A, Torres A, Barbé F, Grasselli G, Zanella A, Etchill E, Usman AA, Feth M, White NM, Suen JY, Li Bassi G, Peek GJ, Fraser JF, Dalton H; COVID-19 Critical Care Consortium. Hemorrhage, Disseminated Intravascular Coagulopathy, and Thrombosis Complications Among Critically Ill Patients with COVID-19: An International COVID-19 Critical Care Consortium Study. *Crit Care Med*. 2023 May 1;51 (5):619–631.
- Cines DB, Bussel JB. SARS-CoV-2 Vaccine-Induced Immune Thrombotic Thrombocytopenia. *N Engl J Med*. 2021 Jun 10;384 (23):2254–2256.
- Al-Samkari H, Karp Leaf RS, Dziki WH, Carlson JCT, Fogerty AE, Waheed A, Goodarzi K, Bendapudi PK, Bornikova L, Gupta S, Leaf DE, Kuter DJ, Rosovsky RP. COVID-19 and coagulation: bleeding and thrombotic manifestations of SARS-CoV-2 infection. *Blood*. 2020 Jul 23;136 (4):489–500.
- Piazza G, Campia U, Hurwitz S, Snyder JE, Rizzo SM, Pfeferman MB, Morrison RB, Leiva O, Fanikos J, Nauffal V, Almarzooq Z, Goldhaber SZ. Registry of Arterial and Venous Thromboembolic Complications in Patients With COVID-19. *J Am Coll Cardiol*. 2020 Nov 3;76 (18):2060–2072.

- Klok FA, Kruij MJHA, van der Meer NJM, Arbous MS, Gommers DAMPJ, Kant KM, Kaptein FHJ, van Paassen J, Stals MAM, Huisman MV, Endeman H. Incidence of thrombotic complications in critically ill ICU patients with COVID-19. *Thromb Res.* 2020 Jul;191:145–147.
- Semeraro N, Colucci M. The Prothrombotic State Associated with SARS-CoV-2 Infection: Pathophysiological Aspects. *Mediterr J Hematol Infect Dis.* 2021 Jul 1;13 (1):e2021045.
- Xu K, Wang Z, Qin M, Gao Y, Luo N, Xie W, et al. A systematic review and meta-analysis of the effectiveness and safety of COVID-19 vaccination in older adults. Vol. 14, *Frontiers in Immunology.* Frontiers Media S.A.; 2023.
- Boyd S, Martin-Loeches I. The incidence of venous thromboembolism in critically ill patients with COVID-19 compared with critically ill non-COVID patients. *Ir J Med Sci.* 2021 Nov;190 (4):1317–1320
- Graña C, Ghosn L, Evrenoglou T, Jarde A, Minozzi S, Bergman H, et al. Efficacy and safety of COVID-19 vaccines. Vol. 2022, *Cochrane Database of Systematic Reviews.* John Wiley and Sons Ltd; 2022.

Topic: Infections and prevention

001262

Risk factor for development of acute kidney injury and mortality in COVID-19 patient admitted at a single center intensive care Unit in Kingston Jamaica

G. Scarlett¹, P. Toppin¹, I. Tennant¹, J. Minott¹, K. Ekhikhametator¹, M. Scarlett¹, M. Isaacs¹, A. Soyibo²

¹Surgery, Radiology, Anaesthesia and Intensive Care, University of the West Indies, Kingston, Jamaica; ²Medicine, University of the West Indies, Kingston, Jamaica

Correspondence: A. Soyibo

Intensive Care Medicine Experimental 2023, **11 (Suppl 1)**:001262

Introduction: Jamaica's first case of COVID-19 was in March 10, 2020 and the Intensive care unit (ICU) one of the major areas affected. A single-center was the primary ICU for COVID-19 patients.

Objectives: To determine the prevalence of, risk factors for AKI and outcome in patients with COVID-19 admitted to the Intensive Care Unit.

Methods: Data from patients admitted to the UHWI ICU with a diagnosis of Coronavirus disease (COVID-19) between March 2020 and November 2021. Data was analyzed using R version 4.1.3 (One Push-Up). The prevalence of AKI was determined, univariate analysis was done to determine factors associated with AKI. Categorical data were compared using the Chi-squared test and continuous data using the t test. Multivariate logistic regression was used to identify factors independently associated with AKI.

Results: One hundred and forty-three patients were included. AKI occurred in 64% of patients, with a prevalence of 12% stage I, 10% stage II and 42% stage III. 31% of AKI patients received dialysis. Independent risk factors for the development of AKI included diabetes mellitus (OR 2.8, $p=0.029$), obesity (OR 2.5, $p=0.05$), mechanical ventilation (OR 8.85, $p=0.002$), hypotension requiring vasoactive agents (OR 4.31, $p=0.006$). The development of AKI was also associated with an increased length of stay in ICU (8.5 d vs 16 d, $p=0.00206$) and longer duration on ventilation (4.8d vs 10.2 d, $p=0.003$).

AKI was associated with higher 30-day mortality, 27% no-AKI vs AKI 85% (OR 14.9, $p<0.001$).

Conclusions: Critically ill patients with COVID-19 are at very high risk of developing AKI. Developing AKI was associated with poorer outcomes and increased mortality.

References

- Cheng Y, Luo R, Wang K, Zhang M, Wang Z, Dong L, et al. Kidney disease is associated with in-hospital death of patients with COVID-19. *Kidney Int.* 2020 May 1;97 (5):829–38.
- Huang C, Wang Y, Li X, Ren L, Zhao J, Hu Y, et al. Clinical features of patients infected with 2019 novel coronavirus in Wuhan, China. *The Lancet.* 2020 Feb;395 (10,223):497–506.
- Ng JH, Hirsch JS, Hazzan A, Wanchoo R, Shah HH, Malieckal DA, et al. Outcomes Among Patients Hospitalized With COVID-19 and Acute Kidney Injury. *Am J Kidney Dis.* 2021 Feb;77 (2):204–215.e1.
- None

Topic: Acute Kidney Injury and haemofiltration

001266

Institutional risk factors associated with bloodstream infection in intensive care units: IMPACTO-MR platform prospective cohort study

B. Besen¹, B. Tomazini², L. C. P. D. Azevedo¹, RR. De Mattos¹, C. Dietrich¹, C. Impacto-M.³

¹Diretoria de compromisso social, Hospital Sirio-Libanês, São Paulo, Brazil; ²Critical Care, Hospital Sirio Libanes, São Paulo, Brazil; ³PROADI-SUS, IMPACTO-MR, São Paulo, Brazil

Correspondence: B. Besen

Intensive Care Medicine Experimental 2023, **11 (Suppl 1)**:001266

Introduction: There have been many studies evaluating different strategies for bloodstream infection (BSI) prevention in intensive care units (ICUs), including single interventions and devices, bundles and protocols. However, other institutional risk factors that could be associated with the risk of BSI have not been deeply explored, especially in low and middle-income countries.

Objectives: To evaluate institutional risk factors (from the perspective of ICU staffing and protocols and infection control services) for BSI incidence in a middle-income country.

Methods: This observational prospective cohort study was nested on the IMPACTO-MR platform, which comprised 51 centers in Brazil, from September 2019 to December 2021. Individual patients' data was prospectively collected and institutional data was collected with surveys. BSI diagnosis was prospectively reported by each center. We fit Cox models with institutional risk factors modelled as fixed effects accounting for patients' confounding variables at baseline. We explored two sets of institutional risk factors: ICU staffing patterns and protocols and infection control services protocols. For ICU staffing, we included an interaction term to allow for their possible dependencies. Results are presented as hazard ratios (HR) with respective 95% confidence intervals (95%CI).

Results: Of 23,026 patients at risk, 828 patients (with 237,764 catheter-days) were diagnosed with BSI. 44 (86.3%) hospitals had a CR-BSI prevention protocol and 38 (76%) had alcohol hand cleansing devices available at all beds. Staff and infection control services factors associated with a lower risk of BSI were semiannual hand hygiene training (HR 0.57, 95% CI 0.43–0.76, $p<0.001$ compared to single, annual and no training), single use protective gowns (HR 0.69, 95%CI 0.58–0.82, $p<0.001$), personal protective equipment use training (HR 0.59, 95%CI 0.47–0.73, $p<0.001$), alcohol hand cleansing devices availability in every bed (HR 0.85, 95%CI 0.73–0.99, $p=0.03$) and family visit duration (hours) (HR 0.94, 95%CI 0.93–0.96, $p<0.001$). Risk factors for BSI were a higher number of patients per physician (HR 1.13, 95%CI 1.03–1.23, $p<0.001$), a higher number of patients per bedside-nurses (HR 1.26, 95% 1.15–1.38, $p<0.001$), which negatively interacted (HR 0.97, 95%CI 0.96–0.98, $p<0.001$), and a higher proportion of single-bed rooms in ICU (HR 2.13, 95%CI 1.64–2.76, $p<0.001$). A BSI prevention protocol was not associated with lower risk of BSI (HR 0.85, 95%CI 0.60–1.22, $p=0.38$), neither was family need to use isolation gowns during visiting hours (HR 1.13, 95%CI 0.93–1.37, $p=0.22$) or training for preparation of IV medications outside the hospital pharmacy (HR 1.16, 95%CI 0.88–1.55, $p=0.30$).

Conclusions: Catheter-related BSI prevention can be better accomplished if institutional processes and structure are considered. Avoiding a high number of patients per physician and bedside-nurses may reduce the risk of BSI. Infection control services could further reduce the risk of VAP by routine institutional training and ensuring alcohol availability in every bed. Family presence could also be a protective factor to reduce the risk of BSI.

References

- Bardossy AC, Zervos J, Zervos M. Preventing Hospital-acquired Infections in Low-income and Middle-income Countries: Impact, Gaps, and Opportunities. *Infect Dis Clin North Am.* 2016;30 (3):805–18.
- Oliveira RD, Bustamante PFO, Besen BAMP. Tackling healthcare-associated infections in Brazilian intensive care units: we need more than

collaboration. *Rev Bras Ter Intensiva*. 2022;34 (3):313–315. Published 2022 Nov 4.

- Zampieri FG, Soares M, Borges LP, Salluh JIF, Ranzani OT. The Epimed Monitor ICU Database[®]: a cloud-based national registry for adult intensive care unit patients in Brazil. *Rev Bras Ter Intensiva*. 2017;29 (4):418–426.
- Tomazini BM, Nassar AP Jr, Lisboa TC, et al. IMPACTO-MR: a Brazilian nationwide platform study to assess infections and multidrug resistance in intensive care units. *Rev Bras Ter Intensiva*. 2022;34 (4):418–425.
- This study was funded by the Program to Support Institutional Development of Universal Health System (Programa de Apoio ao Desenvolvimento Institucional do Sistema Único de Saúde—PROADI-SUS) a nationwide program aimed at strengthening and qualifying the Brazilian Universal Health System (SUS) throughout the country. It has been sponsored by the Sociedade Beneficente de Senhoras—Hospital Sírio-Libanês.

Topic: Infections and prevention

001267

The use of standard list terms entered into a ‘Best of Breed’ Informatics System to describe the population phenotype of critically ill patients admitted to a large central London ICU before, during and after the COVID 19 pandemic

P. Schalke¹, K. Fearnon¹, T. Lalmahomed¹, I. Salako¹, J. Fideles¹, M. Derupe¹, N. Gurung¹, A. Broderick¹, K. O’Reilly¹, S. Akhtar², F. Bowtell³, A. Khatri¹, T. Best¹, D. Hadfield⁴, P. A. Hopkins⁵

¹King’s Critical Care, King’s College Hospital, London, United Kingdom;

²King’s Critical care, Kings College Hospital London-London, London,

United Kingdom; ³Critical Care Medicine, King’s College Hospital, London,

United Kingdom; ⁴Critical care, King’s College London, London, United

Kingdom; ⁵King’s Critical Care, King’s College London, London, United Kingdom

Correspondence: P.A. Hopkins

Intensive Care Medicine Experimental 2023, **11 (Suppl 1)**:001267

Introduction: There are a number of ways of extracting information from electronic health records to describe populations of patients with critical illness. These include structured data from national registries such as ICNARC in the UK and big data analytics using datasets such as MIMIC III (1, 2). However, these data reports are usually generic and limited in scope with limited access to health care professionals who cannot influence the dictionary term or phrase configuration. Here, we describe a novel intermediate approach, with more granular data for a local intensive care service using terms reflecting local healthcare professional preferences and patient populations. An extensive but structured list terms within the electronic healthcare record, transformed to an excel heat map representing a longitudinal population phenotype for critically ill patients admitted to a central London ICU.

Methods: Approvals were gained to extract anonymous data from the Intellivue, Critical Care & Anaesthetic (ICCA) database (Philips Healthcare) as part of a service evaluation project. 1000 standard list terms were created in the dictionary of the configuration editor, describing admission organ support; admission diagnosis and past medical history and then all patients screened on admission against the list terms between January 2019 and current date (increasing over time). Terms were structured into categories and found using the search option of the informatics system. Terms were refined overtime. The data extracted from ICCA were pivoted against the admission month of each patient. These totals were then represented by an excel colour code as a percentage of total admissions. A further SQL report ran to ensure no patients or fields were missed by the screening team.

Results: 100% of ICU admissions are represented with no missing data between Jan 2019 and present. Figure 1 shows an example of the phenotype as presented through admission list terms. The association between Covid 19 and hypertension, diabetes, and obesity is demonstrated. The drift in disease characteristics can be seen over time. The consequences of the pandemic are also visible in both presenting disease and comorbidities (Fig. 2) with clear sustained spikes in patients presenting with drug overdose/acute psychosis, parasuicide as well

as history of prior mental health; significant psychosocial background, frailty following the pandemic.

Conclusions: Here we have demonstrated a novel use of a SQL extraction of list terms to reveal a simple granular longitudinal phenotype, structured in months, before during and after the COVID 19 pandemic. The phenotype of the population of patients admitted to critical care, provided a unique representation of the pandemic and its aftermath. Standard list term extraction could be translated to reflect any facets of critical illness and supportive care workflow, specific to the local context. Natural Language processing could also be used to try and replicate the phenotypic profile and reduce the burden of data entry. The phenotype of the ICI could also be used in targeting resources and research.

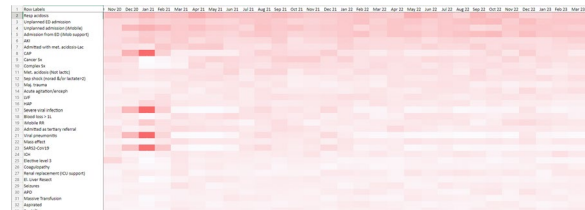

Figure 1 (abstract 001267) Admission list term heat map

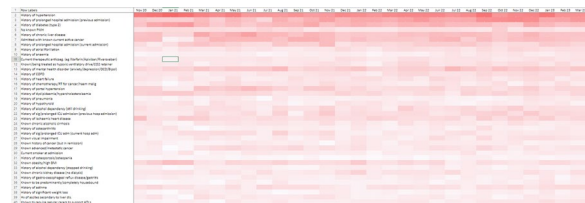

Figure 2 (abstract 001267) Past Medical History term heat map

References

- (2) Alistair EW Johnson. 2016. MIMIC-III, a freely accessible critical care database. *Sci Data* 3:160,035 <https://doi.org/10.1038/sdata.2016.35>.
- (1) Donglemans D et al. 2022. Worldwide clinical intensive care registries response to the pandemic: An international survey. *J Crit Care*; <https://doi.org/10.1016/j.jcrc.2022.154111>
- Travel costs for nurse presenter supported by Philips Healthcare

Topic: Critical care organisation, quality management, information systems, outcomes

001268

Comparison of SAPS 3, APACHE II, SOFA, and EPM Scoring Systems in Predicting Hospital Mortality in Patients of a Quaternary University Hospital ICU: a retrospective cohort analysis

J. E. Guerra Souza¹, A. G. Almeida Barros¹, C. Gomez Ravetti¹, T. Bragança Ataíde², R. Detoffol Bragança¹, J. L. Lima Silva¹, P. Santos Oliveira³, L. Leite Viana¹, P. Frizzera Vassallo¹, A. P. Figueiredo Neves¹

¹Intensive Care Medicine / Internal Medicine, Hospital das Clínicas da

UFMG, Belo Horizonte, Brazil; ²Intensive Care Medicine / Infectious

Diseases, Hospital das Clínicas da UFMG, Belo Horizonte, Brazil; ³Intensive

Care Medicine / Endocrinology and Metabolic Medicine, Hospital das

Clínicas da UFMG, Belo Horizonte, Brazil

Correspondence: J.E. Guerra Souza

Intensive Care Medicine Experimental 2023, **11 (Suppl 1)**:001268

Introduction: Scoring systems such as the Simplified Acute Physiology Score (SAPS) 3, Acute Physiology and Chronic Health Evaluation (APACHE) II, Sequential Organ Failure Assessment (SOFA), and the Epimed Mortality Prediction (EPM) model, which is based on machine learning, are widely used to predict mortality in critically ill patients.

However, the ability of these scoring systems to accurately predict hospital mortality for patients originating from diverse populations has yet to be established. Consequently, assessing their performance in a general (clinical and surgical) ICU cohort of a quaternary university hospital is essential. Moreover, comparing traditional scoring systems with machine learning-derived models is crucial to understand their potential advantages and limitations.

Methods: A retrospective analysis was conducted on a cohort of 864 patients admitted to the general ICU of a quaternary university hospital in 2022. Data on patient demographics, comorbidities, and interventions were collected. SAPS 3, APACHE II, SOFA, and EPM scores were calculated within the appropriate timeline from ICU admission. The primary outcome was hospital mortality. Discrimination and calibration of the scoring systems were assessed using C-statistics. COVID-19 patients were excluded.

Results: The study population comprised 864 patients, with a mean age of 56.55 (SD 16.9579). The observed in-hospital mortality rate in the dataset was 21.78%. The area under the curve (AUC) values for APACHE II, SOFA, EPM, and SAPS 3 were 0.708 (95% CI 0.676 to 0.739), 0.758 (95% CI 0.728 to 0.787), 0.847 (95% CI 0.821 to 0.870), and 0.835 (95% CI 0.808 to 0.859), respectively. Pairwise comparisons of ROC curves were conducted to evaluate the differences in discriminative ability between the scoring systems. The comparison between EPM and SAPS 3 showed no significant difference ($p=0.2507$). However, comparisons between other pairs of scoring systems, such as APACHE II and SOFA or SOFA and SAPS 3, demonstrated statistically significant differences in their AUC values, indicating varying degrees of discriminative ability.

Conclusions: This study provides valuable insights into the performance of SAPS 3, APACHE II, SOFA, and the machine learning-based EPM scoring systems in predicting hospital mortality among patients in a general ICU cohort of a quaternary university hospital. EPM and SAPS 3 demonstrated similar discriminative ability in this cohort, with no significant differences in their pairwise comparison. The results highlight the importance of considering patient-specific factors when applying these scoring systems for risk stratification and clinical decision-making.

References

1. Minne L, Abu-Hanna A, de Jonge E. Evaluation of SOFA-based models for predicting mortality in the ICU: A systematic review. *Crit Care*. 2008;12(6):R161.
2. Raith EP, Udy AA, Bailey M, et al. Prognostic accuracy of the SOFA score, SIRS criteria, and qSOFA score for in-hospital mortality among adults with suspected infection admitted to the intensive care unit. *JAMA*. 2017;317(3):290–300.
3. Vincent JL, Moreno R, Takala J, et al. The SOFA (Sepsis-related Organ Failure Assessment) score to describe organ dysfunction/failure. *Intensive Care Med*. 1996;22(7):707–710.
4. Knaus WA, Draper EA, Wagner DP, Zimmerman JE. APACHE II: a severity of disease classification system. *Crit Care Med*. 1985;13(10):818–829.
5. Moreno RP, Metnitz PGH, Almeida E, et al. SAPS 3—From evaluation of the patient to evaluation of the intensive care unit. Part 2: Development of a prognostic model for hospital mortality at ICU admission. *Intensive Care Med*. 2005;31(10):1345–1355.

Topic: Data Science

001269

Presepsin—a potential biomarker for early detection of bloodstream infection in septic patients

P. Mester¹, S. Schmid¹, C. Kunst¹, K. Gülow¹, M. Müller-Schilling¹, V. Pavel¹
¹Department of Internal Medicine I, University Hospital Regensburg, Regensburg, Germany

Correspondence: V. Pavel

Intensive Care Medicine Experimental 2023, **11** (Suppl 1):001269

Introduction: Bloodstream infection (BSI) is one of the most severe systemic infections and a leading cause of morbidity and mortality worldwide. Microbiological cultures are used standardly to identify

blood pathogens. However, microbiological investigations are time-consuming and have many drawbacks such large sample volume, frequent need for repeated testing and risk of false negative test results after initiation of antibiotic therapy. Procalcitonin (PCT) has been studied as a biomarker for BSI and showed promising results. However, PCT values can be influenced by many pathological conditions like trauma, burns or recent surgery. Therefore PCT is not always reliable as a biomarker for BSI. For an early and targeted therapy new biomarkers are needed to specifically diagnose BSI.

Objectives: Aim of this study was to test the potential of presepsin as a biomarker for BSI in septic patients.

Methods: Levels of presepsin were measured in plasma of patients with different causes of systemic inflammatory response syndrome (SIRS) or sepsis (Sepsis-3, M Singer et al.). The study started in August 2018 and is ongoing. Blood samples were collected within 24 h after admission to the intensive care unit. Until now 79 blood samples from patients with different causes of SIRS or sepsis were included. Blood samples were analyzed by Enzyme-linked Immunosorbent Assay 's (ELISA).

Results: Presepsin was elevated in the plasma of 99% of the patients with SIRS or sepsis. 42 patients (53.20%) were diagnosed with a bloodstream infection using standard microbiological cultures and in 37 cases (46.80%) no pathogen could be isolated in blood. There was a significant difference between plasma of patients with bloodstream infection and without BSI. Presepsin was elevated in patients with BSI. In addition, it was analyzed whether the presepsin concentration is associated with the number of bacterial species in blood. With an increasing number of blood germs, the presepsin levels in SIRS/sepsis patients also increased. Statistical significance was observed between the values from patients with multiple blood pathogens and those with negative blood cultures. Patients with blood pathogens had higher presepsin plasma levels.

Conclusions: Although many stand-alone biochemical markers have been studied for early detection of BSI in critically ill septic patients, C-reactive protein (CRP) and PCT remains the most frequently used markers. Though C-reactive protein (CRP) is an acute phase reactant it is not specific for BSI. Furthermore, although some studies showed the abilities of PCT in detecting bacterial infections in septic patients, a normal or lower PCT values can't always rule out BSI, since PCT levels can be elevated also in other pathological conditions like metastatic cancers or neuroendocrine tumors.

Our study shows that presepsin could be a new useful biomarker for the early detection of BSI in septic patients, regardless of the cause of sepsis.

Topic: Sepsis

001270

Major surgery induced impairments in monocyte and lymphocyte crosstalk predispose to post-operative infections in vitro

R. Loye¹, T. A. C. Snow¹, A. V. Waller¹, F. Ryckaert¹, A. Cesar¹, D. Brealey², J. Whittle³, M. Singer¹, N. Arulkumaran¹

¹Bloomsbury Institute of Intensive Care Medicine, University College London, London, United Kingdom; ²Critical care, UCL Hospitals NHS Foundation Trust, London, United Kingdom; ³Perioperative Prehabilitation and Human Physiology and Performance Laboratory, University College London, London, United Kingdom

Correspondence: T.A.C. Snow

Intensive Care Medicine Experimental 2023, **11** (Suppl 1):001270

Introduction: Sterile inflammation induced by major surgery results in activation of the immune system. Several studies have explored the immunophenotype of patients who subsequently develop post-operative infections. However, few, if any, have assessed the in vitro dynamic immune response to an infectious stimulus pre- and post-operatively. We hypothesised that changes to the immune system following surgery impairs the immune response to a subsequent infectious challenge, predisposing patients to secondary infections.

Objectives: To identify differences in the in vitro immune response to an infectious challenge in high-risk surgical patients before and 24 h following surgery.

Methods: We conducted a prospective study in which peripheral blood mononuclear cells (PBMCs) from 32 patients undergoing major abdominal surgery were isolated. PBMCs were collected before and 24 h following surgery. PBMCs were stimulated with heat-killed bacteria (HKB) for 24 h to assess monocyte phenotype, or with CD3-CD28 beads for 48 h to assess lymphocyte phenotype. Immune cell phenotype was assessed using flow cytometry.

We assessed classical monocyte antigen presentation (HLA-DR, CD86, CD80), chemotaxis (CCR2 and CXCR4), intracellular cytokines (IL-1 β , IL-6, IL-10, and TNF- α), and T-cell suppression (PD-L1). In lymphocytes, we assessed cell death, checkpoint inhibitor (PD-1), differentiation and proliferation (IL-2R, IL-7R), intracellular cytokines (IL-2, IL-10, and IFN- γ), and activation (CTLA-4 and CD28).

Results: Following HKB stimulation, monocytes isolated prior to surgery demonstrated an increase in intracellular TNF- α ($p=0.0157$), which was not evident in monocytes following surgery. On day one post-surgery, monocytes demonstrated a reduction in CCR2 ($p=0.0142$) and an increase in PD-L1 ($p=0.007$), which were not evident in samples isolated prior to surgery.

An increase in CD4 and CD8 lymphocyte PD-1, IL-2R, CD28, and IFN- γ were evident following stimulation in samples taken both before and following surgery. CD4 lymphocytes isolated prior to surgery demonstrated an increase in cell viability following stimulation which was not evident following surgery. Following surgery, CD4 lymphocytes demonstrated an increase in IL-10 which were not evident prior to surgery. CD8 lymphocytes demonstrated similar changes on stimulation before and after surgery.

CD19 cells demonstrated an increase in cell viability, CD28, and decrease in PD-L1 following stimulation before and after surgery. Following surgery, IFN- γ was increased in CD19 cells, which was not evident prior to surgery.

Conclusions: Differences in immune response to infectious stimuli were seen in vitro before and after surgery. The implication of these changes on post-operative infectious complications needs to be determined. Mechanisms underpinning these changes may facilitate the identification of therapeutic interventions.

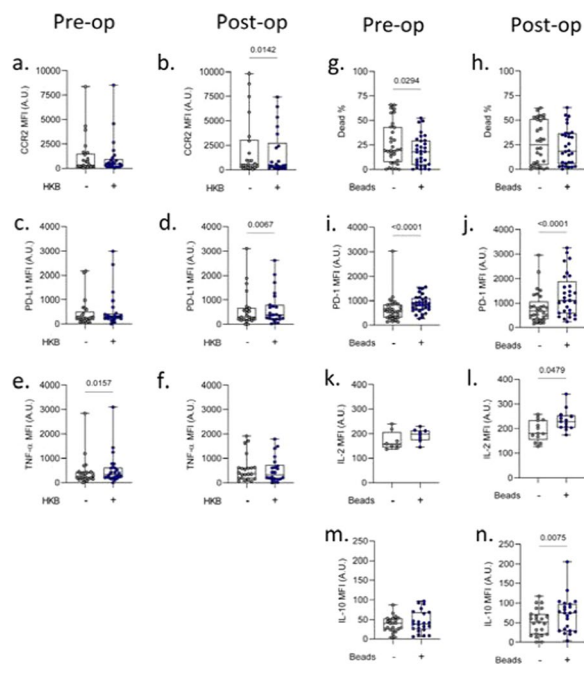

Changes in monocyte (a-f) and CD4 lymphocyte (g-n.) immune function following heat killed bacteria (HKB) or CD3-28 bead stimulation. Data expressed as individual dots ($n=32$), horizontal line represents median, box inter-quartile range, whisker range, and compared using Wilcoxon test with p -values <0.05 shown.

References

3. Waller, AV., et al. Immunosuppressive phenotypes and therapeutic targets following major surgery: a prospective cohort study—ESICM LIVES 2022: part 1. *ICMx*, 2022. 10 (2): 001087
2. Ibertsmeier, M., et al. Monocyte-Dependent Suppression of T-Cell Function in Postoperative Patients and Abdominal Sepsis. *Shock*, 2017. 48 (6): p. 651–656.
1. O'Dwyer, M.J., et al. The perioperative immune response. *Curr Opin Crit Care*, 2015. 21 (4): p. 336–42
4. BJA/RCoA Project Grant (2022)

Topic: Perioperative care

001271

Neurological outcome following intravenous milrinone infusion in severe cerebral vasospasm

J. Fernandes¹, R. Guedes², R. Pereira³, L. Antunes⁴, E. Pereira², C. Dias², J. A. Paiva², E. Monteiro²

¹Intensive Care Medicine Department, Centro Hospitalar De Trás-Os-Montes E Alto Douro, E.P.E., Vila Real, Portugal; ²Intensive Care Medicine Department, Centro Hospitalar Universitário São João, EPE, Porto, Portugal; ³Intensive Care Medicine Department, Hospital Geral de Santo António, Porto, Portugal; ⁴Intensive Care Medicine Department, Hospital Fernando Fonseca, Lisbon, Portugal

Correspondence: J. Fernandes

Intensive Care Medicine Experimental 2023, **11** (Suppl 1):001271

Introduction: Cerebral vasospasm (CVS) is an important cause of mortality and long-term disability after aneurysmal subarachnoid hemorrhage (aSAH). A myriad of drugs has been studied and milrinone has been suggested as an effective and safe treatment for severe CVS in combination with calcium channel blockers.

Objectives: Comparison between intra-arterial verapamil (IA-V) and IA-V combined with intravenous perfusion of milrinone (IV-M) to treat CVS on long-term neurological outcome.

Methods: Retrospective analysis of all adult patients with CVS as a complication after aSAH admitted from 1st January 2018 to 30th June 2022 at a Neurocritical Care Unit of a University Hospital. CVS was defined by elevated cerebral blood flow velocities using transcranial Doppler. Patients treated with selective IA-V boluses were compared with those submitted to IA-V combined with continuous IV-M infusion. Therapeutic approach was based on individualized clinical evaluation, multimodal neuromonitoring and angiographic findings. Favorable functional outcome, defined by Glasgow Outcome Scale (GOS) of 4 or 5, was evaluated at 28 days, 3 and 6 months.

Results: CVS was diagnosed in 91 (45.7%) of 199 patients with aSAH, 61 females (67%), mean age of 53 years (SD \pm 12.5). Hunt and Hess score 4 or 5 was observed in 32 (35.2%) and Fisher score 3 or 4 in 82 (90.1%). Delayed cerebral ischemia (DCI) was observed in 45%. Oral nimodipine was administered over 21 days to all patients. Regarding CVS rescue therapies, 28 patients (30.8%) were treated with IA-V and 30 patients (33.0%) with IA-V combined with IV-M. No pharmacological treatment was performed in 33 patients (36.3%) since vasospasm evaluated by transcranial Doppler wasn't clinically significant or wasn't angiographically confirmed. There were no differences regarding age ($p=0.70$), Fisher grade ($p=0.55$), Hunt and Hess grade ($p=0.47$), and DCI development between the two therapeutic groups. Comparing patients treated with IA-V to those submitted to IA-V plus IV-M, a favorable GOS was observed, respectively at 28 days, 3 and 6 months, in 32.1% vs. 13.3%, 48.1% vs. 33.3% and in 61.5% vs. 47.8%. However GOS wasn't significantly different at 28 days ($p=0.08$), 3 months ($p=0.26$) and 6 months ($p=0.33$) after the ictus regarding the therapeutic approach.

Conclusions: In the studied population the addition of IV-M to IA-V didn't significantly influence short- and long-term functional outcome in CVS after aSAH.

References

1. Crespy T, Heintzelmann M, Chiron C, Vinclair M, Tahon F, et al. Which Protocol for Milrinone to Treat Cerebral Vasospasm Associated With Subarachnoid Hemorrhage? *Journal of Neurosurgical Anesthesiology* 31:323–329, July 2019.
2. Lakhali K, Hivert A, Alexandre PL, Fresco M, Robert-Edan V, et al. Intravenous Milrinone for Cerebral Vasospasm in Subarachnoid Hemorrhage: The MILRISPASM Controlled Before-After Study. *Neurocrit Care*. 2021 Dec; 35:669–679.
3. Harrod CG, Bendok BR, Batjer HH. Prediction of cerebral vasospasm in patients presenting with aneurysmal subarachnoid hemorrhage: A review. *Neurosurgery*. 2005; 56: 633–654.
4. Lakhali K, Hivert A, Alexandre PL, Fresco M, Robert-Edan V, et al. Intravenous Milrinone for Cerebral Vasospasm in Subarachnoid Hemorrhage: The MILRISPASM Controlled Before-After Study. *Neurocrit Care*. 2021 Dec; 35:669–679.

Topic: Neurointensive care

001272

Comparison of clinical characteristics and outcomes

between COVID-19 and other community-acquired viral pneumonia

S. Ben othmane¹, N. Ben Slimene¹, B. Ben Dhia¹, F. Essafi², IK. Ben¹, M. Kaddour¹, I. Talik¹, T. Merhabene¹

¹Intensive Care Unit, Regional Hospital of Zaghouan, Faculty of Medicine of Tunis, University Tunis El Manar, Tunisia; ²Intensive Care Unit, Regional Hospital of Zaghouan, Tunis, Tunisia

Correspondence: N. Ben Slimene

Intensive Care Medicine Experimental 2023, **11** (Suppl 1):001272

Introduction: During the COVID-19 pandemic, many similarities in clinical presentation were noted between SARS-CoV-2 and other viruses causing seasonal influenza. Nevertheless, some studies showed that ICU length of stay and mortality were higher in COVID-19 patients.

Objectives: Aim: to compare clinical characteristics and outcomes of critically ill hospitalized patients with COVID-19 in comparison with other viruses.

Methods: We conducted a retrospective monocentric study in the ICU of Zaghouan's regional hospital in Tunisia, including critically ill patients hospitalized for severe viral pneumonia from October 1st 2022 to February 28th 2023. Patients were selected and matched according to similar demographic characteristics. Two groups were secondary individualized G1 = COVID-19 and G2 = patients with other viruses. Were collected epidemiological, clinical, therapeutic and evolving data.

Results: We included 60 patients (30 patients in each group). Viruses identified in G2 were respectively H1N1/pdm 2009 (n = 16), H3N2 (n = 4), influenza B (n = 4), rhinovirus (n = 5), parainfluenza virus (n = 1). Mean age were respectively 51 ± 13.9 years in G1 and 50.9 ± 15.4 years in G2. Gender ratio was respectively 2 in G1 and 1.5 in G2. Group 1 had a higher median APACHE II score (10 [2–28] in G1 vs 6 [0–23] in G2, $p < 0.05$). Comorbidities were lesser observed among the other viruses than COVID-19 patients (21.7% vs 25.83%; $p = 0.18$). Hypertension was statistically higher noted in G2 ($p = 0.02$). However, chronic respiratory diseases were higher in G1 ($p = 0.03$). At admission, PaO₂/FiO₂ ratio was lower in patients with COVID-19 (152 [82–202] in G1 vs 189 [67–330]; $p = 0.018$). Noninvasive ventilation was initially used in both groups (86% in G1 vs 80% in G2; $p = 0.3$) for a similar duration 3 [1–8] vs 1 [1–6]; $p = 0.48$). Orotracheal intubation was needed in 30% in G1 vs 33% in G2 ($p = 0.5$). Vasoactive agents were more needed in G1 ($p = 0.38$). No differences in healthcare associated infections occurrence ($p = 0.55$) and in median length of ICU stay between both groups were found (5 [2–33] vs 3 [1–32]; $p = 0.52$). Mortality rate was similar between both groups 21% in G1 vs 23% in G2 ($p = 0.38$).

Conclusions: Pneumonia related to COVID-19 and other viruses seems to be similar in terms of need for mechanical ventilation, length of stay and mortality. Larger studies are needed to further examine the differences between COVID-19 and other viruses.

Topic: Acute respiratory failure and mechanical ventilation

001273

Epidemiologic profile and outcomes of hospitalized community-acquired pneumonia: a 10-year analysis of the Brazilian public hospitals database

R. Espinoza¹, S. Hamacher², M. Meirim², J. Salluh³, F. Bozza⁴
¹Surgical ICU, Hospital Copa Star, Rio de Janeiro, Brazil; ²Department of Industrial Engineering, Pontifical Catholic University of Rio de Janeiro, Rio de Janeiro, Brazil; ³Intensive Care Medicine, D'OR Institute for Research and Education, Rio de Janeiro, Brazil; ⁴Instituto Nacional de Infectologia, Fundação Oswaldo Cruz, Rio de Janeiro, Brazil

Correspondence: R. Espinoza

Intensive Care Medicine Experimental 2023, **11** (Suppl 1):001273

Introduction: Community-acquired pneumonia (CAP) is a major cause of hospital admission and mortality in adults both in high-income (HIC) and low-and-middle-income countries (LMICs). In LMICs, the accelerated demographic transition has produced an aging population associated with a high rate of co-morbidities and non-communicable diseases. In addition, immunization rates are sub-optimal and the inequities in the healthcare system make timely access to a hospital bed and intensive care a challenge. Therefore, it is not surprising that international cohort studies that evaluate the outcomes of hospitalized patients with CAP demonstrate that hospital outcomes (namely mortality rates) are worse in LMICs as compared to HICs.

Finally, although the hospitalization of adults due to community-acquired pneumonia represents a major challenge for policymakers, clinicians, and public health experts in LMICs, few large cohort studies or population-based studies from these regions are available.

Objectives: The primary objective was the age-adjusted hospitalization rate per 100,000 population. Secondary objectives comprised the crude number of hospital admissions and in-hospital deaths, the age-adjusted in-hospital mortality rate per 100,000 population, age-adjusted in-hospital and ICU lethality rates, ICU admissions by age group, percentage of pneumonia age-adjusted hospital and ICU admissions by age-group.

Methods: A retrospective analysis of hospital admissions from the Brazilian Universal Healthcare System was performed. The data is available on the Information Technology Department of the Brazilian Universal Health System website. We assessed the Authorization for Hospitalization database, where each register includes details about an inpatient, including age, demographic information, admission cause (code from the 10th revision of the International Statistical Classification of Diseases and Related Health Problems: ICD-10) and patient outcome. For count data (crude number of hospital admissions and in-hospital deaths), the AAPC was calculated using log-linear Poisson regression, considering the year as the single predictor (the reference year was 2011). To the previous Poisson model for age-standardized rates, we added the age-adjusted denominator as an offset variable. We calculated the AAPC from 2011 to 2019 and 2019 to 2021, as well as the percentage change (%Δ) over these periods. Comparing both intervals, it is possible to determine whether the COVID-19 pandemic had an impact on the outcomes. We defined 2 age groups (WHO definition): Elderly (> 60 years old) and non-elderly.

Results: From 141,923,885 hospital admissions included in the study, 79,149,709 were adults > 20 years old and after the filter with CAP codes from ICD-10, 3,626,315 admissions were analyzed (Figure 1). A decrease in the absolute number of CAP admissions was observed from 2011 (362,159) to 2019 (353,591) about 2.37% (Fig. 2) with the exception of the elderly group (older than 60 years old). A decrease in the age-adjusted rate of CAP admissions was also observed in the same period, from 286/100,000 in 2011 to 218/100,000 in 2019 (Fig. 2). The absolute number of in-hospital deaths increased by 36.05%, from 46,615 (2011) to 59,337 (2019). The in-hospital lethality increased from

2011 (6.59%) to 2019 (8.66%) by 31.54%. Lethality in ICU admissions decreased over the time by 12.1% in contrast to a 27.74% increase in non-ICU (Fig. 3). In the period 2020–2021 compared to 2019, during the COVID-19 pandemia, it could be observed: a decline in CAP hospital admissions, higher ICU occupation and non-ICU lethality (Fig. 2 and 3).

Conclusions: CAP causes high burden among hospitalized adults in Brazil. Hospitalar CAP admissions in non elderly patients decreased over the years, ICU admitted patients have high mortality rates mainly the elderly group. 2020 and 2021 CAP admissions had an important decrease, probably because of the Health System overload due to COVID-19 pandemia.

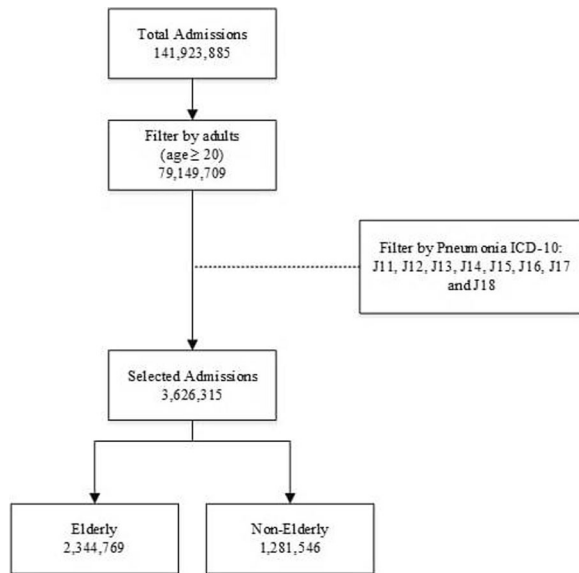

Figure 1 (abstract 001273) Flowchart of study population

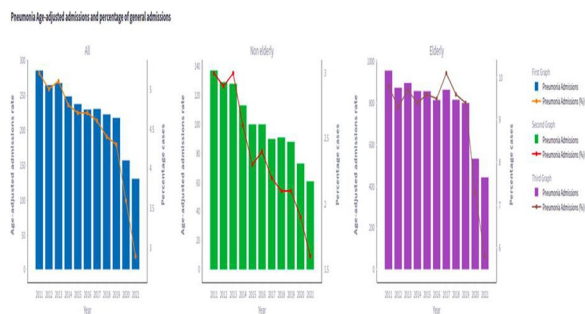

Figure 2 (abstract 001273) CAP age-adjusted admissions and percentage of general admissions

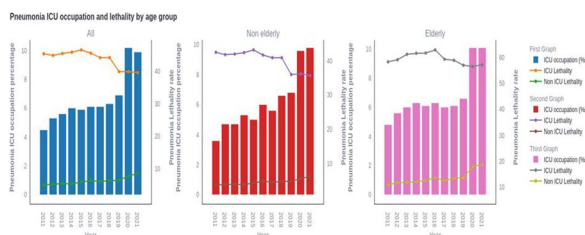

Figure 3 (abstract 001273) CAP ICU admission and lethality by age group

References

1. Espinoza R, Silva JRLE, Bergmann A, et al. Factors associated with mortality in severe community-acquired pneumonia: a multicenter cohort study. *J Crit Care* 2019; 50: 82–86
2. Lindenauer PK, Lagu T, Shieh MS, Pekow PS, Rothberg MB. Association of diagnostic coding with trends in hospitalizations and mortality of patients with pneumonia, 2003–2009. *JAMA*. 2012;307 (13):1405–1413. [PubMed: 22474204]
3. Hussey P, Anderson G, Berthelot JM, et al. Trends in socioeconomic disparities in health care quality in four countries. *Int J Qual Health Care*. 2008;20 (1):53–61. [PubMed: 18024997]
4. Jain S, Self WH, Wunderink RG, et al. Community-acquired pneumonia requiring hospitalization among U.S. adults. *N Engl J Med*. 2015;373 (5): 415–427. [PubMed: 26172429].
5. no conflict of interests

Topic: Infections and prevention

001274

Hospital-acquired bloodstream infections in critically ill patients with cirrhosis from 101 centers: a post-hoc analysis of the EUROBACT-2 database

H. Wozniak¹, A. Tabah², F. Barbier³, S. Ruckly⁴, A. Liodice⁵, M. Akova⁶, M. Leone⁷, A. Conway Morris⁸, M. Bassetti⁹, K. Arvaniti¹⁰, R. Ferrer Roca¹¹, L. De Bus¹², JA. Paiva¹³, H. Bracht¹⁴, A. Mikstacki¹⁵, A. Alsisi¹⁶, L. Valeanu¹⁷, Y. C. Yeh¹⁸, J. Prazak¹⁹, J. F. Timsit²⁰, N. Buetti²¹

¹Intensive Care Unit, Hôpitaux Universitaires de Genève (HUG), Genève, Switzerland; ²Intensive Care Unit, Redcliffe and Caboolture Hospitals, Brisbane, Australia; ³Intensive Care, Hopital de la Source, Orléans, France; ⁴Université de Paris, INSERM, Paris, France; ⁵ICUREsearch, Biometry, Fontaine, France; ⁶Department of Infectious Disease, Hacettepe University Hospitals, Ankara, Turkey; ⁷Department of Anaesthesiology and Intensive Care Medicine, Hospital Nord, Marseille, France; ⁸Division of Anaesthesia, Department of Medicine, University of Cambridge, Cambridge, UK, Cambridge, United Kingdom; ⁹Infectious Disease Unit, San Martino Policlinico Hospital, IRCCS for Oncology and Neuroscience, Department of Health Sciences, University of Genoa, Genoa, Italy; ¹⁰ICU, Papageorgiou General Hospital, Thessaloniki, Greece; ¹¹Intensive Care Department, Vall d’Hebron University Hospital, Barcelona, Spain; ¹²Intensive Care, Ghent University Hospital, Ghent, Belgium; ¹³Emergency and Intensive Care Department, Centro Hospitalar de São João, Porto, Portugal; ¹⁴Klinik für Anästhesiologie, University Hospital Of Ulm, Ulm, Germany; ¹⁵Department of Anaesthesiology and Intensive Therapy, Regional Hospital, Poznań, Poland; ¹⁶Critical Care Department, Faculty of Medicine, Cairo, Egypt; ¹⁷Cardiac Anesthesiology and Intensive Care Department, Emergency Institute for Cardiovascular Diseases, Bucharest, Romania; ¹⁸Department of Anesthesiology, NTUH (National Taiwan University Hospital), Taipei, Taiwan; ¹⁹Department of Intensive Care, Inselspital, Bern University Hospital and University of Bern, Bern, Switzerland; ²⁰Intensive Care Medicine Department, Assistance Hôpitaux Publique de Paris, Paris, France; ²¹Infection Control Program and World Health Organization Collaborating Centre on Patient Safety, Hôpitaux Universitaires de Genève (HUG), Genève, Switzerland

Correspondence: H. Wozniak

Intensive Care Medicine Experimental 2023, **11** (Suppl 1):001274

Introduction: Hospital-acquired bloodstream infections (HABSI) are frequent in the intensive care unit (ICU) and are associated with a high mortality. Patients with cirrhosis are highly vulnerable and prone to infections. Data on HABSI in critically ill cirrhotic patients are lacking.

Objectives: We aimed to describe the differences in the epidemiology of HABSI between cirrhotic and non-cirrhotic patients in terms of patients’ characteristics, source of infection, microorganism distribution and mortality using a large multicontinental database.

Methods: We used high quality data from the prospective observational Eurobact-2 study. We compared the distribution of HABSI sources and microorganisms for cirrhotic and non-cirrhotic patients. The association between *Enterococcus faecium* and cirrhosis was studied using a multivariable mixed logistic regression model. The

association between cirrhosis and mortality was assessed by a multi-variable frailty Cox model.

Results: A total of 1059 HABSIs from 101 centers from all continents were included, of which 160 had cirrhosis. The source of HABSIs in cirrhotic patients was predominantly abdominal (35.6%) whereas it was pulmonary (18.9%) for non-cirrhotic patients ($p < 0.01$). Of the 1196 microorganisms identified, 42.3% of the HABSIs in cirrhotic patients were caused by Gram-positive species compared to 33.2% in non-cirrhotic patients ($p = 0.02$). HABSIs in cirrhotic patients were most frequently caused by *Klebsiella* spp (16.5%), coagulase-negative Staphylococci (13.7%) and *E. faecium* (11.5%). *E. faecium* HABSIs were significantly more observed in cirrhotic patients (11.5% versus 4.5%, $p < 0.01$). After adjustment to possible confounding factors, cirrhosis was associated with a higher risk of *E. faecium* HABSIs (Odds ratio 2.5, 95% CI 1.3–4.5, $p < 0.01$). Cirrhotic patients with HABSIs had an increased mortality hazard ratio (HR) compared to non-cirrhotic patients with HABSIs (HR 1.3, 95% CI 1.01–1.7, $p = 0.045$).

Conclusions: Critically ill cirrhotic patients with HABSIs have a different epidemiology compared to non-cirrhotic patients with more Gram-positive and especially more *Enterococcus faecium*.

Topic: Infections and prevention

001275

Prognostic value of two inflammation mediators in polytrauma patients

R. Gaddour¹, N. Ben Slimene¹, H. Chaâboune¹, F. Essaf², I. K. Ben¹, M. Kaddour¹, I. Talik¹, T. Merhabene¹

¹Intensive Care Unit, Regional Hospital of Zaghouan, Faculty of Medicine of Tunis, University Tunis El Manar, Tunisia; ²Intensive Care Unit, Regional Hospital of Zaghouan, Tunis, Tunisia

Correspondence: N. Ben Slimene

Intensive Care Medicine Experimental 2023, 11 (Suppl 1):001275

Introduction: Polytrauma is a leading cause of death around the world. Septic complications are predominant in this group of patients and inflammation biomarkers were proposed as predictors of mortality.

Objectives: to assess prognostic value of two biomarkers: C reactive protein (CRP) and white blood cells count (WBC) in critically ill polytrauma patients.

Methods: We conducted a retrospective monocentric study including polytrauma patients admitted to the ICU in Zaghouan's regional hospital during the year of 2022. The CRP and WBC counts were monitored daily by a blood test during the ICU stay. We collected epidemiological, clinical, therapeutic and evolving data. Patients were divided in two groups: G1: survivors and G2: deceased.

Results: We included 50 polytrauma patients among them 21 (42%) were deceased. Mean age was 41 ± 17 years with a male predominance (96%). Median APACHE II and SAPS II were respectively 8 [4–18] and 19 [7–47]. All patients had head trauma, 60% had associated thoracic trauma and 14% an abdominal trauma. A surgical treatment was indicated in 14% of patients. Median WBC and CRP levels at admission were respectively 13,703 [8750–16350]/mm³ and 26 [5–80] mg/l. Monitoring of WBC and CRP levels until discharge showed an initial increase (Day 2/3) of the two biological parameters followed by a secondary decrease (Figure 1). In G2, we observed a second rise in WBC and CRP levels respectively at day 5 and day 7 simultaneously with the occurrence of a health acquired infection ($p < 0.05$).

Orotracheal intubation was more needed in G2 (31% vs 100%; $p < 0.05$) with a median duration of mechanical ventilation of 3 days [1–6] vs 6 days [1–9] ($p < 0.05$). Patients in G2 had a longer ICU length of stay (2 days [2–4] vs 5 days [1–9]; $p < 0.05$).

Conclusions: Kinetics of inflammatory biomarkers in polytrauma patients seems to be associated with worse prognosis.

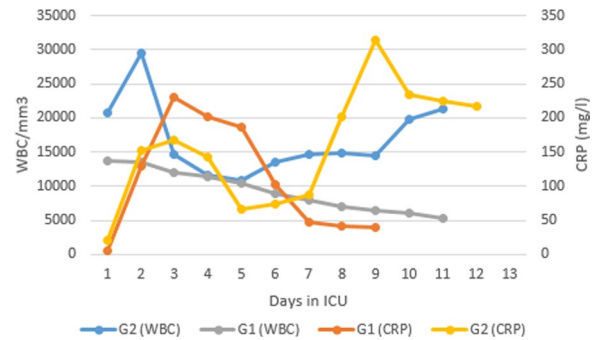

Topic: Trauma

001276

A review of antibiotic selection in ventilator associated pneumonia

R. Araujo Silva¹, R. F. Gomes¹, S. Salema Travassos¹, G. Jesus¹, S. Cameiro Croca¹, J. M. Ribeiro¹

¹Intensive Medicine Department, Centro Hospitalar Universitário Lisboa Norte, Lisboa, Portugal

Correspondence: R. Araujo Silva

Intensive Care Medicine Experimental 2023, 11 (Suppl 1):001276

Introduction: Ventilator associated pneumonia (VAP) is a common hospital acquired infection in critically ill patients, associated with significant morbidity and mortality. Some current guidelines recommend combining two broad spectrum antibiotics as the first line therapy for the management of early onset VAP (EOV). However, there is growing concern that the widespread use of broad-spectrum antibiotics may contribute to the development of antimicrobial resistance. In this study, we aim to assess the suitability of such antibiotic strategy for the treatment of early (EOV) and late onset VAP (LOV).

Methods: A cohort of patients admitted to a single center, intensive care unit (UCI) between May 2020 and November 2021, diagnosed with VAP was retrospectively selected. EOVS was considered when the diagnosis was established 2–5 days after invasive mechanical ventilation (IMV) and LOV if the diagnosis was considered more than 5 days after IMV. Thorough clinical characterization, first line antibiotic choice and later treatment adjustments were recorded and descriptive statistical analysis was performed.

Results: 183 patients were diagnosed with VAP, 30 were diagnosed with EOVS and 153 with LOV, 74.3% of whom were male, and median age was 61 years (IQR 21). A SAPS II score of 34 was recorded for EOVS vs 37 for LOV. Patients with EOVS had a SOFA score at admission of 4 for EOVS vs 6 for LOV. The median time from IMV to diagnosis was 5 days for EOVS and 11 days for LOV. Among patients diagnosed with EOVS, 50% were also infected with SARS-CoV-2. In patients with EOVS, initial antibiotic therapy choice was adequate in 19 patients (63%). 3 patients (10%) required antibiotic spectrum broadening and downgrading was possible in 8 patients (27%). Amoxicillin-clavulanate (AAC) resistant microorganisms was found in a minority of patients (n=3). One fifth (n=7) of patients with EOVS met diagnostic criteria for septic shock, but a AAC-resistant agent was isolated in only 1 patient.

Conclusions: Our analysis revealed that prevalence of AAC-resistant microorganisms in EOVS is low, even in patients with septic shock. This finding strongly suggests that, in our specific patient population, the initial choice of two long-spectrum antibiotics to treat EOVS as recommended by some guidelines may not be necessary.

References

- Spalding, M. C., Cripps, M. W., & Minshall, C. T. (2017). Ventilator-Associated Pneumonia: New Definitions. In *Critical Care Clinics* (Vol. 33, Issue 2, pp. 277–292). W.B. Saunders. <https://doi.org/10.1016/j.ccc.2016.12.009>
- Bassetti, M., Taramasso, L., Giacobbe, D. R., & Pelosi, P. (2012). Management of ventilator-associated pneumonia: Epidemiology, diagnosis and antimicrobial therapy. In *Expert Review of Anti-Infective Therapy* (Vol. 10, Issue 5, pp. 585–596). <https://doi.org/10.1586/eri.12.36>
- Fernando, S. M., Tran, A., Cheng, W., Klompas, M., Kyeremanteng, K., Mehta, S., English, S. W., Muscedere, J., Cook, D. J., Torres, A., Ranzani, O. T., Fox-Robichaud, A. E., Alhazzani, W., Munshi, L., Guyatt, G. H., & Rochwerf, B. (2020). Diagnosis of ventilator-associated pneumonia in critically ill adult patients—a systematic review and meta-analysis. In *Intensive Care Medicine* (Vol. 46, Issue 6, pp. 1170–1179). Springer. <https://doi.org/10.1007/s00134-020-06036-z>
- Ferrer, M., & Torres, A. (2018). Epidemiology of ICU-acquired pneumonia. In *Current Opinion in Critical Care* (Vol. 24, Issue 5, pp. 325–331). Lippincott Williams and Wilkins. <https://doi.org/10.1097/MCC.0000000000000536>
- Metersky, M. L., & Kalil, A. C. (2018). Management of Ventilator-Associated Pneumonia: Guidelines. In *Clinics in Chest Medicine* (Vol. 39, Issue 4, pp. 797–808). W.B. Saunders. <https://doi.org/10.1016/j.ccm.2018.08.002>

Topic: Infections and prevention

001277

Frailty in long-stay ICU patients: association with mortality and long-term physical, cognitive, and psychological outcomes

H. Wozniak¹, T. S. Beckmann², A. Dos Santos Rocha², J. Pugin¹, C. P. Heidegger¹, S. Cereghetti¹¹Intensive Care Unit, Hôpitaux Universitaires de Genève (HUG), Genève, Switzerland; ²Anesthesiology Division, Hôpitaux Universitaires de Genève (HUG), Genève, Switzerland

Correspondence: H. Wozniak

Intensive Care Medicine Experimental 2023, **11** (Suppl 1):001277

Introduction: Prolonged intensive care unit (ICU) stay is known to be associated to physical, cognitive, and psychological disabilities in surviving patients. Frailty on ICU admission has been previously associated with mortality and to a lower health-related quality of life after an ICU stay, but its impact on long-stay ICU patients remains unclear.

Objectives: We conducted a study to investigate the association between frailty and poor outcomes in long-stay ICU patients, defined as patients hospitalized for more than 7 days in the ICU. The primary objective was to identify an association between frailty and mortality. The secondary objective was to determine the physical, psychological and cognitive outcomes at 6 months in frail patients compared to non-frail patients.

Methods: We screened all patients identified as long-stay ICU patients from the 1st May 2018 to the 1st May 2021. Frailty was assessed using the clinical frailty scale (CFS), with a score of ≥ 5 indicating frailty. Patients were separated into two groups according to their CFS on ICU admission. A descriptive analysis of patients' characteristics on ICU admission according to their frailty status was performed. We then investigated the association between frailty and mortality using a graphical representation with Kaplan–Meier curves. Finally, a Cox model adjusted to known mortality risk factors in that setting was performed. In surviving patients at 6 months, psychological, physical, and cognitive sequelae and health-related quality of life were assessed using descriptive statistics and multiple linear regressions.

Results: During the study period, we enrolled and followed up 531 long-stay ICU patients, including 353 non-frail and 178 frail patients, for up to 6 months or until death. Frail patients were older, had more comorbidities, and presented with more severe disease on ICU admission. They had a higher mortality rate compared to non-frail patients (61/178 vs. 62/353, $p < 0.01$). In the multivariate Cox model, frailty

was independently associated with death (HR 2.1 (1.5–3.1), $p < 0.01$). At 6 months, frail patients had more dependency for daily activities (73% versus 56%, $p = 0.02$) and required more nursing help at home (54% versus 31.7%, $p < 0.01$). In the multivariate linear regressions, frailty was associated with poorer physical health-related quality of life ($p = 0.03$). However, there was no association between frailty and mental health-related quality of life, depressive symptoms, post-traumatic stress disorder and cognitive outcomes.

Conclusions: Our study found an association between pre-admission frailty and mortality in long-stay ICU patients. Compared to non-frail patients, surviving frail patients are more dependent and have poorer physical health-related quality of life 6 months after their ICU stay, but not necessarily poorer mental health-related quality of life. The CFS, an easy and reliable tool, can be used to assess outcomes in long-stay ICU patients and assist in determining their treatment plan and goal of care.

Topic: Critical care organisation, quality management, information systems, outcomes

001278

Performance of RTS, MGAP, and ISS scoring in prediction mortality among critically ill trauma patients

R. Gaddour¹, N. Ben Slimene¹, H. Chaâbouni¹, I. K. Ben¹, I. Talik¹, B. Ben Dhia², S. Ben othmane², F. Essafi², T. Merhabene¹¹Intensive Care Unit, Regional Hospital of Zaghouan, Faculty of medicine of Tunis, University Tunis El Manar, Tunisia; ²Emergency Department, Regional Hospital of Zaghouan, Faculty of medicine of Tunis, University Tunis El Manar, Tunisia

Correspondence: N. Ben Slimene

Intensive Care Medicine Experimental 2023, **11** (Suppl 1):001278

Introduction: Predicting the outcome of trauma helps clinician to prioritize patients and provide timely and effective treatment. Various scoring systems have been proposed to predict mortality of trauma patients.

Objectives: to identify among three scoring systems: MGAP (mechanism, Glasgow coma scale, age, and arterial pressure), ISS (injury severity score) and RTS (revised trauma score) the best predictive score of mortality in critically ill trauma patients.

Methods: We conducted a retrospective monocentric study including polytrauma patients admitted to the ICU in Zaghouan's regional hospital during the year of 2022. MGAP, ISS and RTS scores were calculated upon presentation in the emergency room. A cut-off for the best score predicting mortality was determined using ROC curve. Epidemiological, clinical, therapeutic and evolving data were collected.

Results: During the study period, 50 patients were included. Mean age was 41 ± 17 years with a male predominance (96%). Median APACHE II and SAPS II were respectively 8 [4–18] and 19 [7–47]. Smoking (63%) and alcoholism (34%) were the most common underlying habits. Seventy-eight percent of patients had no comorbidities. Orotracheal intubation was indicated in 56% of patients with a median length of mechanical ventilation of 5 days [1–8]. Vasoactive agents were used in 42% of cases. Mean ICU length of stay was 19 ± 12 days. Means MGAP, ISS and RTS were respectively 21 ± 5 , 36 ± 24 and 6 ± 1 . A cut-off value of 33 in ISS was found to be predictive of need for vasoactive agents ($Se = 71.4\%$ and $Sp = 69.2\%$) and mortality ($Se = 66.7\%$ and $Sp = 65.4\%$). A cut-off value of 19.5 of ISS was found to be predictive of mechanical ventilation ($Se = 92.9\%$ and $Sp = 68.4\%$). ROC curves demonstrated that ISS has the best predictive value of need to mechanical ventilation, vasoactives agents and mortality with areas under curve respectively of 0.929, 0.777 and 0.677 (Figure 1).

Conclusions: In critically ill polytrauma patient, the present study demonstrated that ISS score was the best predictive score of mechanical ventilation, need for vasoactive agents and mortality.

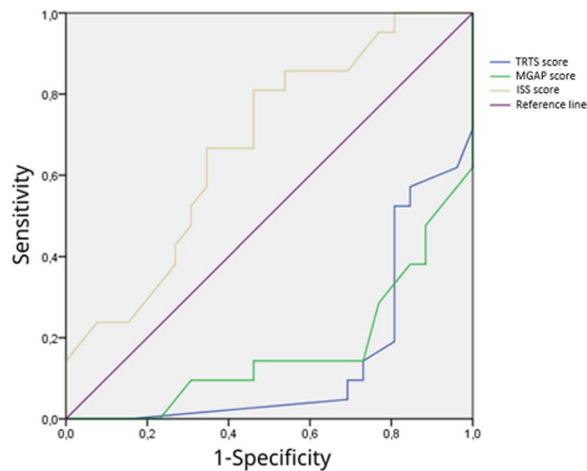

Topic: Trauma

001280

Lipoxins receptor is associated with prognosis and endothelitis in icu patients with acute heart failure but not in those with cardiogenic shock

M. Reina-Couto¹, P. Pereira-Terra², C. Silva-Pereira³, J. Quelhas-Santos⁴, S. Martins⁵, L. Teixeira-Santos², D. Pinho⁴, M. Luz Soares⁶, P. Serrão³, J. Afonso³, JT. Guimarães⁷, R. Roncon-Albuquerque⁸, J. A. Paiva⁹, A. Albino-Teixeira³, T. Sousa³

¹Intensive Care Department & dep. Biomedicina-unid. farmacologia e terapêutica, Centro Hospitalar São João & Faculdade de Medicina da Universidade do Porto, Porto, Portugal; ²Department of Biomedicine-Unit of Pharmacology and Therapeutics, Faculdade de Medicina da Universidade do Porto, Porto, Portugal; ³Dep. Biomedicina-unid. Farmacologia e Terapêutica, Faculdade de Medicina da Universidade do Porto, Porto, Portugal, Portugal; ⁴Department of Biomedicine-Unit of Pharmacology and Therapeutics, Faculdade de Medicina da Universidade do Porto-FMUP, Porto, Portugal; ⁵Dep. Patol. Clínica, Centro Hospitalar São João, Porto, Portugal; ⁶Dep. Biomedicina-Lab. Apoio à Investigação em Med. Molecular (LAIMM), Faculdade de Medicina da Universidade do Porto, Porto, Portugal; ⁷Dep. Biomedicina-Unidade de Bioquímica, Faculdade de Medicina da Universidade do Porto, Porto, Portugal; ⁸Intensive Care Department & Cirurgia e Fisiologia Department, Centro Hospitalar São João & Faculdade de Medicina da Universidade do Porto, Porto, Portugal; ⁹Intensive Care, São João University Hospital Center, Porto, Portugal

Correspondence: M. Reina-Couto

Intensive Care Medicine Experimental 2023, **11** (Suppl 1):001280

Introduction: Dysregulated inflammation and inflammation-driven endothelitis appear to be major pathophysiological contributors to acute heart failure (AHF) and cardiogenic shock (CS) (1, 2). The identification of key players in the resolution of inflammation response, such as lipoxins (LXs) and their FPR2/ALX receptor (3, 4), has led to new potential treatment targets.

Objectives: Since no data on human AHF is yet available, we aimed at characterizing LXs and their FPR2/ALX receptor both in human AHF and CS patients, as well as evaluating their correlation or association with endocan (a biomarker of endothelitis in AHF and CS with prognostic value (2)), cardiac biomarkers and prognosis.

Methods: This study was approved by the Health Ethics Committee of our hospital. Blood and urine samples of AHF (n=23) and CS (n=25) patients were collected at days 1–2 (admission), 3–4 and 5–8.

Blood donors (BD) were used as controls (n=22). We quantified serum and urinary lipoxin A4 (LXA4), 15-epi-LXA4 and endocan by ELISA and peripheral blood mononuclear cell FPR2/ALX receptor expression by qRT-PCR. Plasma B-type natriuretic peptide (BNP) and high-sensitivity troponin I (hs-trop I), prognostic scores (APACHE II, SAPS II) and mortality were also analysed. Correlation and multivariate analysis were performed.

Results: At admission there were no differences in serum LXA4 or 15-epi-LXA4 between groups. However, both urinary LXA4 and 15-epi-LXA4 were higher in AHF (U-LXA4, ng/mg creatinine, BD: 0.28 ± 0.08 ; AHF: 1.19 ± 0.24 ; CS: 0.45 ± 0.11 ; $p < 0.001$, AHF vs BD; U-15-epi-LXA4, ng/mg creatinine, BD: 1.89 ± 0.41 ; AHF: 6.19 ± 1.17 ; CS: 3.34 ± 0.94 ; $p < 0.001$, AHF vs BD and $p < 0.05$, AHF vs CS). At admission, S-Endocan was significantly higher in AHF (S-Endocan, ng/ml, BD: 1.45 ± 0.17 ; AHF: 6.12 ± 1.85 ; $p < 0.001$ vs. BD) and even higher in CS (CS: 12.94 ± 1.88 ; $p < 0.001$ vs. BD; $p < 0.010$ vs. AHF), whereas U-Endocan was only significantly higher in CS patients (U-Endocan, pg/mg creatinine, CS: 62.48 ± 36.97 ; $p < 0.01$ vs. BD).

During hospitalization, a decreasing profile in LXs was observed only in AHF (days 3–4 vs days 1–2: S-LXA4, ng/ml: 0.11 ± 0.02 vs 0.15 ± 0.01 , $p < 0.05$; S-15-epi-LXA4, ng/ml: 0.63 ± 0.22 vs 1.97 ± 0.68 , $p < 0.05$; U-LXA4, ng/mg creatinine: 0.47 ± 0.21 vs 1.19 ± 0.24 , $p < 0.01$; U-15-epi-LXA4, ng/mg creatinine: 2.74 ± 0.84 vs 6.19 ± 1.17 , $p < 0.01$), but no significant reductions were observed for S-Endocan and U-Endocan values in both patient groups.

FPR2/ALX expression was significantly raised at admission (BD: 0.87 ± 0.10 ; AHF: 1.90 ± 0.39 ; CS: 3.81 ± 1.21 ; $p < 0.01$, CS vs BD) and decreased along hospitalization only in CS (days 3–4 vs days 1–2: 1.41 ± 0.29 vs 3.81 ± 1.21 , $p < 0.05$). Noteworthy, FPR2/ALX expression was inversely correlated with APACHE II ($r = -0.69$; $p < 0.001$), SAPS II ($r = -0.79$; $p < 0.001$) and BNP ($r = -0.43$, $p < 0.05$) only in AHF patients. Multivariate analysis confirmed the negative association of FPR2/ALX expression with the cardiac biomarkers BNP ($\beta = -0.00003$, 95% CI: -0.001 to -0.000007 ; $p < 0.05$) and hs-trop I ($\beta = -0.00003$, 95% CI: -0.00005 to -0.000007 ; $p < 0.01$) and the prognostic scores APACHE II ($\beta = -0.093$, 95% CI: -0.153 to -0.034 ; $p < 0.01$) and SAPS II ($\beta = -0.053$, 95% CI: -0.089 to -0.016 ; $p < 0.01$) only in AHF patients. Also, in the same group of patients, FPR2/ALX expression was negatively associated with S-Endocan ($\beta = -0.041$, 95% CI: -0.073 to -0.008 ; $p < 0.05$) and U-Endocan ($\beta = -0.002$, 95% CI: -0.004 to -0.00028 ; $p < 0.05$), while hospital survival was associated with significantly higher expression of FPR2/ALX ($\beta = 1.298$, 95% CI: 0.255 to 2.342 ; $p < 0.05$).

Conclusions: CS patients appear to have defective resolutive response as suggested by unchanged LXs profile and higher FPR2/ALX expression. The inverse correlations/associations of FPR2/ALX receptor with endocan, cardiac biomarkers and prognostic parameters only in AHF patients suggest that it exerts a protective role in these patients.

References

- [3] Serhan CN, Chiang N. Endogenous pro-resolving and anti-inflammatory lipid mediators: a new pharmacologic genus. *British Journal of Pharmacology*. 2009;153 (S1):S200-S215. <https://doi.org/10.1038/sj.bjp.0707489>.
- [4] Maciuszek M, Cacace A, Brennan E, Godson C, Chapman TM. Recent advances in the design and development of formyl peptide receptor 2 (FPR2/ALX) agonists as pro-resolving agents with diverse therapeutic potential. *Eur J Med Chem*. 2021;213:113167. <https://doi.org/10.1016/j.ejmech.2021.113167>.
- [1] Reina-Couto M, Pereira-Terra P, Quelhas-Santos J, Silva-Pereira C, Albino-Teixeira A, Sousa T. Inflammation in Human Heart Failure: Major Mediators and Therapeutic Targets. *Frontiers in Physiology*. 2021;12. <https://doi.org/10.3389/fphys.2021.746494>.
- [2] Reina-Couto M, Silva-Pereira C, Pereira-Terra P, Quelhas-Santos J, Bessa J, Serrão P, Afonso J, Martins S, Dias CC, Morato M, Guimarães JT, Roncon-Albuquerque R, Paiva JA, Albino-Teixeira A, Sousa T. Endothelitis profile in acute heart failure and cardiogenic shock patients: Endocan as a potential novel biomarker and putative therapeutic target. *Front Physiol*. 2022;13:965611. <https://doi.org/10.3389/fphys.2022.965611>.

Topic: Translational Medicine

001282

Shorter-frames sublingual microcirculation study with micro-tools analysis yielding clinical information non-inferior to standard-frames versions

K. Shu-Hung¹, E. Bülent², C. Ince², W. C. Huang³

¹Critical Care Medicine, Kaohsiung Veterans General Hospital, Kaohsiung, Taiwan; ²Intensive Care Adults, Erasmus MC University Medical Center, Rotterdam, Netherlands; ³Critical care medicine and cardiovascular center, Kaohsiung Veterans General Hospital, Taipei, Taiwan

Correspondence: W.C. Huang

Intensive Care Medicine Experimental 2023, **11 (Suppl 1)**:001282

Introduction: Sepsis has long been an ambiguous medical dilemma, leading to innumerable casualty despite of energy and resources human dedicate to fight it. By introducing sublingual microcirculation for evaluating sublingual microcirculatory system, we established a reliable noninvasive strategy for better approaching sepsis patients, but with application limited by time consuming measurement required for qualified image to study. Here we try to facilitating its clinical application with shorter frames needed study yielding same clinical information by introducing better image analysis tools.

Methods: Sublingual microcirculation evaluation was applied over adult medical intensive care unit in tertiary hospital as routine daily standard of care. Each adult patient was measured with sublingual microcirculation evaluation by 60 frames matching with 100 frames individually. All the 100-frames sublingual microcirculation video clips were found qualified with *Massey's scoring* system, and all the 60-frames were found qualified with *Massey's scoring* system except the length of videos. This was a nationwide, propensity score-matched case-control study of patients admitted to hospitals between January 2000 and December 2012 with primary diagnosis of first AMI. Among the 186,112 first AMI patients, 72,924 patients with diabetes were identified. The clinical information for the same patient yielding from both version of video clips were interpreted by Micro-Tools, and all the data were compared.

Results: Totally 18 patient was measured, with totally 112 video clips from 60-frames study and 104 video clips from 100 frames study were collected. By further interpretation with Micro-Tools, the image quality for duration, illumination, stability, focus, pressure, and contents were all found no statistical difference (p value = 1). Further clinical information including small vessel FOV (p value = 0.079), TVD (p value = 0.95), CBV (p value = 0.813), FCD (p value = 0.659), PPV (p value = 0.197), RBCv (p value = 0.948), cHct (p value = 0.554), tRBCp (p value = 0.977) were all found no statistical difference in between 60-frames study and 100 frames study, as well as RBCv SD (p value = 0.581) and cHct SD (p value = 0.552). Shorter-frames study had non-inferior clinical information in compared to standard-frames versions.

Conclusions: This study demonstrated shorter-frames study had non-inferior clinical results in compared to standard-frames versions by Image analysis tools with Micro-Tools.

Topic: Cardiovascular issues in ICU

001283

Deceased donor transplantation during COVID times—success story from state in India

R. Muralidharan¹

¹critical Care, KIMS Health Hospital Trivandrum, Thiruvananthapuram, India

Correspondence: R. Muralidharan

Intensive Care Medicine Experimental 2023, **11 (Suppl 1)**:001283

Introduction: In India, live donor transplantation is more common than deceased donor transplantations. The enactment of The Transplantation of Human Organ and tissue Act in India in the year 1994 legalized organ donation after brainstem death. The Government of Kerala in association with Donation and Transplantation Institute (DTI Foundation) of Spain implemented transplant

procurement management model (TPM model) in the state in the year 2019. KNOS (Keralanetwork for organ Sharing), a local networking organization under Government acts as a public, private provider interface, ensuring a transparent and equitable organ allocation.

Methods: Government medical colleges and private transplant centers appointed an in-hospital transplant procurement manager (TPM) to coordinate potential donors at intensive care units. The TPM became actively involved in the deceased organ donation (DDP) process. The cornerstone of the success was early and proactive identification of potential donors. An educational and international cooperation approach based on the implementation of a specialized program for healthcare professionals according to the DTI Foundation training model started in 2019. It includes on-site training, international internship, hospital visits and DTI's experts visiting Kerala hospitals to exchange best practices.

Results: Following the initiation of TPM in various hospitals across Kerala, when compared 2020 Vs 2019, a 60% increase was observed from 30 to 50 organ transplanted in the same period of time even against Covid pandemic effects worldwide.

Conclusions: The collaboration between local and international organization, the hospital-based organ procurement units headed by Transplant procurement managers (TPM) and the role of government-run networking organizations in improving

the deceased donor transplantation played a key role for good outcomes of donation and transplant programs. When the COVID 19 pandemic resulted in the suspension of the transplant programs across the country, the deceased donation and transplantation activity in Kerala were going unabated.

Topic: Brain death, organ donation and transplantation

001285

Fluid stewardship in ICU—'ROSE' yet to blossom in India?

R. Muralidharan¹

¹Critical Care, KIMS Health Hospital Trivandrum, Thiruvananthapuram, India

Correspondence: R. Muralidharan

Intensive Care Medicine Experimental 2023, **11 (Suppl 1)**:001285

Introduction: To find out the need of fluid stewardship in post surgical critically ill patients who requires ICU admission post operatively of the age more than 18 years admitted in multidisciplinary ICU in a tertiary care centre in South India.

Objectives: Intravenous fluids are not benign. They are the most commonly used drugs used in Intensive Care unit. Fluid stewardship is the concept of covering all the aspects of fluid therapy from procurement ordering, safe storage, prescription administration and monitoring of fluids through education and audit of the different fluid requirement scenarios. Errors in prescribing are very common. Various surveys and audit have shown that many staffs prescribing intravenous fluids don't have the know.

how to calculate the requirements of electrolytes and water requirements as well as the composition of various fluid choices as per the individual needs. Management of fluid therapy rarely reported to have produced harm for patients. But evidences suggest as many as one in five patients receiving fluid therapy found to have complications or mobility due to inappropriate administration of fluids might be too little or too many of fluids. In this era of less is more policy and applying 5RS (resuscitation reduced maintenance replacement, redistribution and reassessment) of resuscitation. We need to have stewardship to count ongoing prescription strategy like two bags of normal saline, one bag of dextrose so on to prescription strategy to 70kg man requiring 0.9% sodium chloride 0.45% of sodium chloride and 5% dextrose solution like. So we need to demystify the fluid management similar to that of antibiotics to counter the ill effects of fluid therapy keeping in mind *primum non nocere* means (first, do no harm).

Methods: To find out the pattern of prescription of fluid therapy in post operative patients requiring ICU admission and prescribing doctors knowledge about the electrolyte components of various available fluid choices. Post surgical patients admitted in the MDICU who needs the inclusion criteria included in the study with matching baseline characteristics were included

and their fluid prescriptions were analysed on type of fluids, flow rate, duration of flow, electrolyte status, urine output and volume status using a checklist which includes lung ultrasound findings like B-lines. Along with that, the knowledge of the prescribing doctor were taken using a five-minute personal interview checklist which gives an idea about the know-how of composition of fluids and patients' electrolyte and fluid status awareness and how they educated the nurse in charge to alter the fluid administration.

Results: The percentage of patients getting pre-fixed fluid therapy calculated after the 100% educational intervention given by the intensive care physician for the target group of health care workers included in the post-surgical ward using PDSA strategy.

Conclusions: After completion of intervention and completion of 25 samples, it seems that there is a statistically significant difference between the previous and current prescription strategy and incidence of B-lines and amount of fluid ordered from the ICU in the post-surgical patients requiring ICU admission.

Topic: Transfusion and haemostasis disorders

001288

The Impact of pediatric intensivists on the management of severe pediatric diabetic ketoacidosis

E. Park¹

¹Jeonbuk National University Children's Hospital, Jeollabuk-do, Jeonju-si, Republic of Korea

Correspondence: E. Park

Intensive Care Medicine Experimental 2023, **11** (Suppl 1):001288

Introduction: The impact of pediatric intensivists on the management of pediatric patients with diabetic ketoacidosis (DKA) is yet to be studied.

Objectives: We aim to evaluate the effect of pediatric intensivist staffing on DKA outcomes in pediatric intensive care units (PICU).

Methods: This study was a two-institution retrospective review of DKA patients admitted to ICU between 2013 and 2023. Pediatric patients (< 18 years of age) were included in the study if they met the severe DKA criteria on PICU admission. The patients were subsequently divided into two groups based on the presence of the pediatric intensivist. The primary outcome was ICU length of stay (LOS). The secondary outcome was the complication of DKA management, the complication of DKA, hospital LOS, duration of insulin infusion, time to DKA resolution, and mortality.

Results: 32 patients admitted to the PICU with a mean age of 11.50 years (range 0–18 years) were included; 18 (56.3%) were male. Both groups had no significant difference in BMI, HbA1c, initial bicarbonate, pH, and blood glucose level. Patients managed by pediatric intensivists had significantly shorter ICU LOS (116.83 vs. 57.67 h, $p=0.012$). Otherwise, there was no significant difference in the median (IQR) time to DKA resolution and hospital LOS between both groups. But complication during DKA treatment was significantly decreased in the intensivist group than in the control group (52.6% vs. 7.7%, $p=0.011$).

Conclusions: Management of DKA patients by pediatric intensivists reduces the ICU LOS with significant improvement in treatment complications.

Topic: Metabolism, endocrinology, liver failure and nutrition

001290

The effects of early mobilization in mechanically ventilated adult ICU patients: systematic review and meta-analysis

L. Wang¹, X. Ou¹

¹Department of Critical Care Medicine, West China Hospital of Sichuan University, Chengdu, China

Correspondence: L. Wang

Intensive Care Medicine Experimental 2023, **11** (Suppl 1):001290

Introduction: Mechanically ventilated patients in intensive care units (ICUs) usually suffer from short- or long-term complications, which are

associated with increased mortality and mechanically ventilated duration, longer length of stay in ICU and hospital, reduced quality of life and increased utilization of medical care[1]. The systematic early mobilization has been commonly advocated as a promising intervention to improve ICU patient outcomes[2]. There is evidence from several studies could demonstrate its feasibility that early mobilization increases muscle strength, reduces the incidence of ICU-acquired weakness and delirium rate, shortens the length of ICU stay and hospitalization[3–5]. However, numerous studies found early mobilization with no or inconclusive evidence for a benefit. Therefore, there is considerable controversy regarding the benefits and adverse effects of mechanical ventilation on early activity in adult ICU patients.

Objectives: We conducted a meta-analysis of RCTs to comprehensively assess the benefits and adverse effects of early mobilization in critically ill mechanically ventilated patients.

Methods: We searched RCTs published in Medline, Embase, CENTRAL (from inception to November 2022). According to difference of timing and type, we divided intervention groups into systematic early mobilization group, late mobilization group and standard early mobilization group. The primary outcome was mortality. The secondary outcomes were ICU length of stay, duration of mechanical ventilation and adverse events.

Results: Nine RCTs combined total of 1756 patients were included. We found early mobilization had no impact on 180-day mortality (RR 1.09, 95% CI 0.89–1.33, $p=0.39$) (Figure 1 (a)). Systemic early mobilization reduced the length of stay in ICU (MD -2.18, 95% CI -4.22 – -0.13, $p=0.04$) and the duration of mechanical ventilation (MD -2.27, 95% CI -3.99 – -0.56, $p=0.009$) (Figure 1 (b-c)), but it may increase the incidence of adverse events in patients compared with standard early mobilization (RR 1.99, 95% CI 1.25–3.16, $p=0.004$) (Figure 1 (d)).

Conclusions: Early mobilization has no significant effects on short- or long-term mortality in mechanically ventilated adult ICU patients, but systematic early mobilization could reduce the ICU length of stay and duration of mechanical ventilation.

Figure 1. (a). Forest plot for early mobilization on effect mortality in the included studies. (b). Forest plot for early mobilization effect on ICU length of stay in the included studies. (c). Forest plot for early mobilization effect on duration of mechanical ventilation in the included studies. (d). Forest plot for early mobilization effect on adverse events in the included studies.

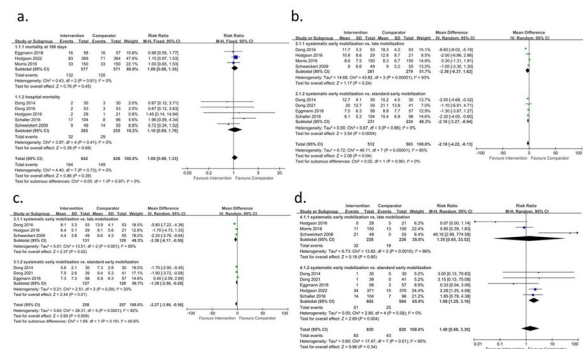

References

- Desai SV, Law TJ, Needham DM. Long-term complications of critical care. *Critical care medicine* 2011;39 (2):371–9.
- Inoue S, Hatakeyama J, Kondo Y, Hifumi T, Sakuramoto H, Kawasaki T, et al. Post-intensive care syndrome: its pathophysiology, prevention, and future directions. *Acute medicine & surgery* 2019;6 (3):233–46.
- Hodgson CL, Bailey M, Bellomo R, Berney S, Buhr H, Denehy L, et al. A Binational Multicenter Pilot Feasibility Randomized Controlled Trial of Early Goal-Directed Mobilization in the ICU. *Critical care medicine* 2016;44 (6):1145–52.

4. Schaller SJ, Anstey M, Blobner M, Edrich T, Grabitz SD, Gradwohl-Matis I, et al. Early, goal-directed mobilisation in the surgical intensive care unit: a randomised controlled trial. *Lancet* (London, England) 2016;388 (10,052):1377–88.
5. Dong Z, Yu B, Zhang Q, Pei H, Xing J, Fang W, et al. Early Rehabilitation Therapy Is Beneficial for Patients With Prolonged Mechanical Ventilation After Coronary Artery Bypass Surgery. *International heart journal* 2016;57 (2):241–6.
6. NA.

Topic: Nursing care and physiotherapy

001291

The association between electroencephalographic abnormalities and poor prognosis in patients with sepsis

J. H. Lee¹, G.S. Choi²

¹Critical Care Medicine & Neurology, Ewha Womans University Mokdong Hospital, Seoul, Republic of Korea; ²Critical Care Medicine & Neurology, Ewha Womans University, Seoul, Republic of Korea

Correspondence: J.H. Lee

Intensive Care Medicine Experimental 2023, **11** (Suppl 1):001291

Introduction: Intensive care unit (ICU) patients often experience decreased consciousness or cognitive impairment. Sepsis is one of the major causes of these conditions in the ICU. Electroencephalography (EEG) is a valuable tool for detecting sepsis-associated encephalopathy in ICU patients. It is critical to predict the neurological outcomes of these patients.

Objectives: This study was performed to investigate the EEG findings and search for correlations between EEG abnormalities and prognostic scores of patients with sepsis.

Methods: We conducted this study by reviewing the medical records of a total of 145 sepsis patients who undergo EEG monitoring in the ICU through Neurology consultation. We reviewed neurologic examination, including the Glasgow Coma Scale motor scoring and EEG data. They were treated according to the international guidelines for sepsis. The medical history, seizure, inflammatory biomarkers (CRP and WBC), and prognostic scores for sepsis (sequential organ failure assessment [SOFA]), Acute Physiology and Chronic Health Evaluation (APACHE)II scores, Simplified Acute Physiology Score (SAPS)II scores were analyzed. The neurologic outcomes were grouped based on the modified Rankin scale (mRS) on discharge and 6 months after discharge, and categories 4, 5, and 6 were considered poor outcomes.

Results: The source of infection was the chest for 100, the urinary tract for 19, the abdominal cavity for 13, and soft tissue for 13 patients. Of the patients, 43% (63/145) had poor outcomes (mRS: 4–6) including a vegetative state or death. We did not find any significant associations between EEG abnormalities and inflammatory biomarkers (CRP and WBC). EEG patterns, including background suppression, burst suppression, and generalized periodic epileptiform discharges ($p < 0.001$), were significantly associated with prognostic sepsis scores or poor neurologic outcomes.

Conclusions: We found that EEG findings were very closely related to the overall prognosis and long-term neurologic outcomes of sepsis patients.

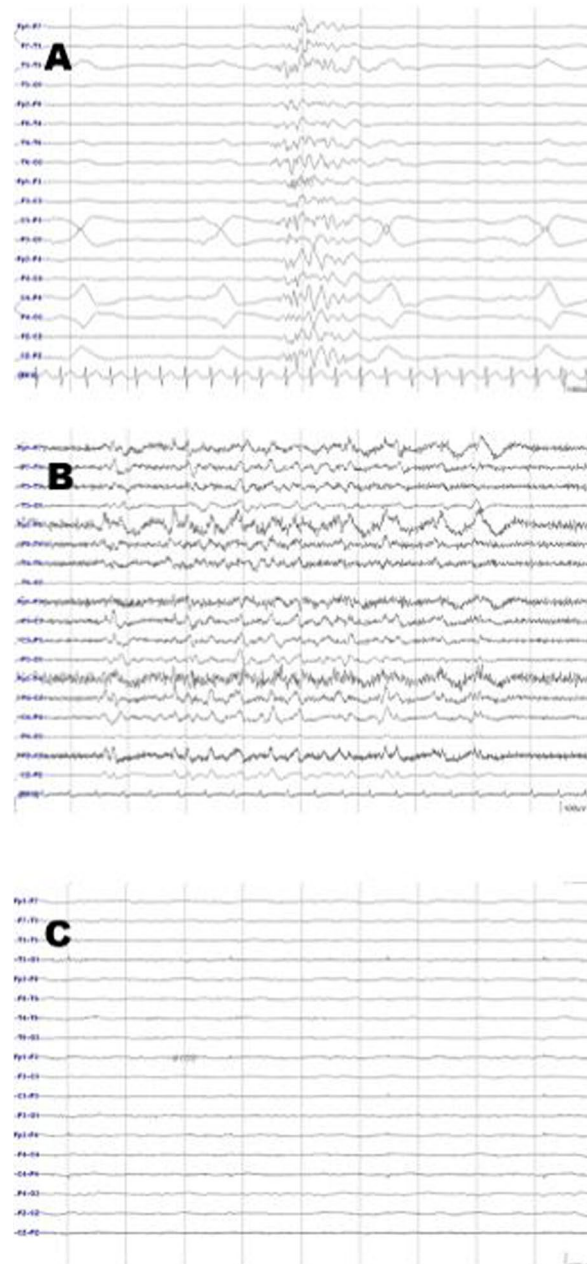

Figure 1 (abstract 001291) Currently known specific electroencephalogram findings with sepsis associated encephalopathy patients. a) Burst-suppression pattern, b) Periodic EEG patterns, c) Generalized background suppression

Table 2 (abstract 001291) Bivariate correlation between EEG and other variables of interest Spearman's rho coefficient analysis

	Spearman's Rho	P value
Age	-0.194	0.237
Serum CRP	0.204	0.212
WBC	0.007	0.968
SOFA	0.499	0.001
MRS	0.534	0.000

References

- Gofton TE, Young GB. Sepsis-associated encephalopathy. *Nature reviews Neurology* 2012;8:557–566. 2. Feng Q, Ai YH, Gong H, et al. Characterization of Sepsis and Sepsis-Associated Encephalopathy. *Journal of intensive care medicine* 2019;34:938–945. 3. Faix JD. Biomarkers of sepsis. *Critical reviews in clinical laboratory sciences* 2013;50:23–36. 4. Stanko C, Freeman WD. Early EEG correlates of neuronal injury after brain anoxia. *Neurology* 2012;79:2010. 5. San-Juan OD, Chiappa KH, Costello DJ, Cole AJ. Periodic epileptiform discharges in hypoxic encephalopathy: BiPLEDs and GPEDs as a poor prognosis for survival. *Seizure* 2009;18:365–368. 6. Westhall E, Rossetti AO, van Roozelaar AF, et al. Standardized EEG interpretation accurately predicts prognosis after cardiac arrest. *Neurology* 2016;86:1482–1490. 7. Cloostermans MC, van Meulen FB, Eertman CJ, Hom HW, van Putten MJ. Continuous electroencephalography monitoring for early prediction of neurological outcome in postanoxic patients after cardiac arrest: a prospective cohort study. *Critical care medicine* 2012;40:2867–2875. 8. Azabou E, Magalhaes E, Braconnier A, et al. Early Standard Electroencephalogram Abnormalities Predict Mortality in Septic Intensive Care Unit Patients. *PLoS one* 2015;10:e0139969. 9. Oddo M, Carrera E, Claassen J, Mayer SA, Hirsch LJ. Continuous electroencephalography in the medical intensive care unit. *Critical care medicine* 2009;37:2051–2056. 10. Watson PL, Shintani AK, Tyson R, Pandharipande PP, Pun BT, Ely EW. Presence of electroencephalogram burst suppression in sedated, critically ill patients is associated with increased mortality. *Critical care medicine* 2008;36:3171–3177. 11. Young GB. Encephalopathy of infection and systemic inflammation. *Journal of clinical neurophysiology: official publication of the American Electroencephalographic Society* 2013;30:454–461. 12. Bartynski WS, Boardman JF, Zeigler ZR, Shaddock RK, Lister J. Posterior reversible encephalopathy syndrome in infection, sepsis, and shock. *AJNR American journal of neuroradiology* 2006;27:2179–2190. 13. Siami S, Annane D, Sharshar T. The encephalopathy in sepsis. *Critical care clinics* 2008;24:67–82, viii. 14. Zauner C, Gendo A, Kramer L, et al. Impaired subcortical and cortical sensory evoked potential pathways in septic patients. *Critical care medicine* 2002;30:1136–1139. 15. Zhang LN, Wang XT, Ai YH, et al. Epidemiological features and risk factors of sepsis-associated encephalopathy in intensive care unit patients: 2008–2011. *Chinese medical journal* 2012;125:828–831. 16. Young GB, Bolton CF, Archibald YM, Austin TW, Wells GA. The electroencephalogram in sepsis-associated encephalopathy. *Journal of clinical neurophysiology: official publication of the American Electroencephalographic Society* 1992;9:145–152.
- This study was supported by the grant of Basic Science Research Program through the National Research Foundation of Korea (NRF) funded by the Ministry of Education (No.2020R111A1A01073396) to J.H. Lee

Topic: Sepsis

001295

Mortality in obese patients with ventilator-associated pneumonia in COVID-19. Cross-sectional cohort

R. Rodríguez Villanueva¹, J. C. Gasca-Aldama², N. Alva Arroyo², S. Sosa-Santos³, D. Navarro Martínez², RDC. Gutiérrez Góngora², M. Vidals-Sánchez², K. H. Lopez Rodríguez², J. Garduño-López², M. A. Carrasco Flores², M. A. Amezcua-Gutiérrez², J. A. Castañon-Gonzalez²
¹UCIA-Unidad de Cuidados Intensivos Adultos, Hospital Juárez de México, Ciudad de México, Mexico; ²Adult intensive care unit, Hospital Juárez de

México, Ciudad de México, Mexico; ³Intensive Care Unit, Hospital Juárez de Mexico, Mexico, France

Correspondence: R. Rodríguez Villanueva

Intensive Care Medicine Experimental 2023, **11 (Suppl 1)**:001295

Introduction: During the COVID-19 pandemic, numerous studies found an association of disease severity with obesity and other metabolic risk factors, including diabetes, hypertension, and smoking. Within the respiratory management of the patient with obesity, there are various challenges associated with the greater amount of adipose tissue and its direct repercussion on the diaphragm and rib cage, together with a state of low-intensity chronic inflammation; which favors a deleterious prognosis in these patients. The prolonged requirement of ICU stay increases the risk of nosocomial infections, such as ventilator-associated pneumonia (VAP).

Objectives: In this study we can examine the relationship between obesity and the severity of COVID-19 pneumonia, as well as the impact of VAP.

Methods: Observational, descriptive and cross-sectional study of patients admitted to the ICU from January 2020 to December 2020 with COVID-19 and requiring invasive mechanical ventilation. 221 patients with positive cultures, clinical picture or radiological changes suggestive of VAP were included. For quantitative variables, they were expressed as mean and standard deviation, as well as free distribution median and interquartile range, using the Kolmogorov Smirnov normality tests; for the qualitative ones, it was expressed in frequency and percentage, using the X2 or Fisher's exact test. Kaplan Meier survival curves were performed. Assigning a value of $p < 0.05$ as statistically significant.

Results: A total of 208 patients were analyzed. 77 women (34.8%), 144 men (65.2%). The median age of the total was 56 (47–64.5). BMI of 31 with SD 6.3, $p = 0.020$. LOS of 23 (18–30) $p = 0.034$, ventilation days 18 (14–25) $p = 0.001$; the days ICU stay, 19 (15–24) $p = 0.276$. The most frequent pathogen was *Acinetobacter baumannii* MDR, followed by *Pseudomonas aeruginosa*. The median survival was reached on day 23 with an omnibus of $p = 0.003$ 95% CI 20.4–29.5, a strong correlation R^2 0.73 (73%), on day 23 of hospitalization, the days of mechanical ventilation explain an R^2 89% associated with dying after day 23 (95% CI 18.7–25.2 $p = 0.005$), with a Hazard Ratio of 1.64, that is, the higher the BMI > 31, the greater the risk of dying after 23 days of mechanical ventilation assistance and days hospitalization. Mean survival was reached after 23 days of hospital stay in the ICU with a $p = 0.003$. R^2 0.73.

Conclusions: In our study, obese patients with a BMI > 31 who required ventilatory management due to COVID-19 and who had nosocomial pneumonia had higher mortality at 23 days of hospital stay.

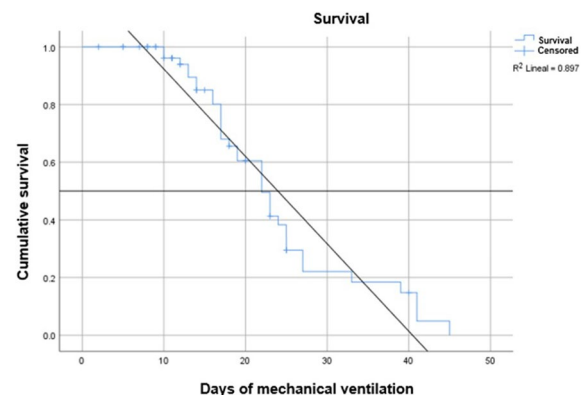

FIGURE 2. Kaplan Meier Survival curve for ventilation days in patients with BMI > 31

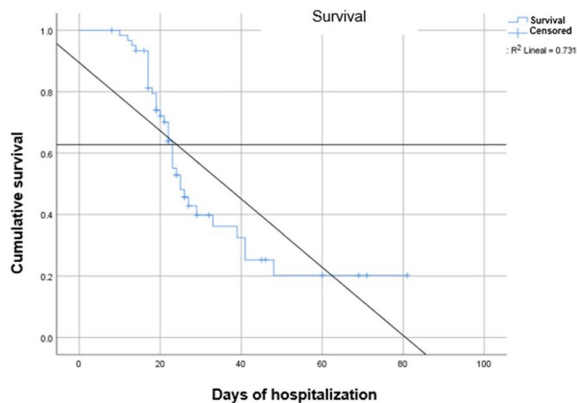

FIGURE 1. Kaplan Meier Survival Curve for Hospitalization days in patients with BMI>31

References

- De Jong, A., Wrigge, H., Hedenstierna, G., Gattinoni, L., Chiumello, D., Frat, J. P., Ball, L., Schetz, M., Pickkers, P., & Jaber, S. (2020). How to ventilate obese patients in the ICU. *Intensive care medicine*, 46 (12), 2423–2435. <https://doi.org/10.1007/s00134-020-06286-x>
- Instituto Nacional de Estadística y Geografía e Instituto Nacional de Salud Pública (2019). Encuesta Nacional de Salud y Nutrición (ENSANUT) 2018. Diseño conceptual. https://www.inegi.org.mx/contenidos/programas/ensanut/2018/doc/ensanut_2018_diseno_conceptual.pdf
- Erstad, B. L., & Barletta, J. F. (2021). Drug dosing in the critically ill obese patient: a focus on medications for hemodynamic support and prophylaxis. *Critical care (London, England)*, 25 (1), 77. <https://doi.org/10.1186/s13054-021-03495-8>
- Bajwa, S. J., Sehgal, V., & Bajwa, S. K. (2012). Clinical and critical care concerns in severely ill obese patient. *Indian journal of endocrinology and metabolism*, 16 (5), 740–748. <https://doi.org/10.4103/2230-8210.100667>
- Grasselli G, Zangrillo A, Zanella A, et al. Baseline characteristics and outcomes of 1591 patients infected with SARS-CoV-2 admitted to ICUs of the Lombardy region, Italy. *JAMA*. 2020;323:1574–1581.
- Simonnet A, Chetboun M, Poissy J, et al. High prevalence of obesity in severe acute respiratory syndrome coronavirus-2 (SARS-CoV-2) requiring invasive mechanical ventilation. *Obesity (Silver Spring)*. 2020;28:1195–1199.
- Magder, S., Slobod, D., & Assanangkornchai, N. (2021). Mechanical Ventilation in the Obese Patient: Compliance, Pleural Pressure, and Driving Pressure. *American journal of respiratory and critical care medicine*, 203 (5), 534–536. <https://doi.org/10.1164/rccm.202009-3607ED>
- Tang, M., Henderson, R. J., Holbrook, J. T., Que, L. G., Mathews, A. M., Wise, R. A., Dixon, A. E., Peters, S. P., Rogers, L., Smith, L. J., Teague, W. G., & Lang, J. E. (2019). Does Obesity Increase Respiratory Tract Infections in Patients with Asthma?. *The journal of allergy and clinical immunology. In practice*, 7 (3), 954–961.e6. <https://doi.org/10.1016/j.jaip.2018.09.033>
- Zhou F, Yu T, Du R, et al. Clinical course and risk factors for mortality of adult inpatients with COVID-19 in Wuhan, China: a retrospective cohort study. *Lancet*. 2020;395:1054–1062.
- Chetboun, M., Raverdy, V., Labreuche, J., Simonnet, A., Wallet, F., Caussy, C., Antonelli, M., Artigas, A., Goma, G., Meziani, F., Helms, J., Mylonakis, E., Levy, M. M., Kalligeros, M., Latronico, N., Piva, S., Cerf, C., Neuville, M., Klouche, K., Larcher, R., ... Pattou, F. (2021). BMI and pneumonia outcomes in critically ill covid-19 patients: An international multicenter study. *Obesity (Silver Spring, Md)*, 29 (9), 1477–1486. <https://doi.org/10.1002/oby.23223>

Topic: Acute respiratory failure and mechanical ventilation

001296

Relationship between brain tissue oxygen tension, arterial oxygenation and non-hypoxic brain metabolism in patients with head trauma

ED. Sterchele¹, M. Salvagno¹, M. Anderloni¹, E. Bogossian¹, FS. Taccone¹
¹Soins intensif, Hospital Erasme, Bruxelles, Belgium

Correspondence: E.D. Sterchele

Intensive Care Medicine Experimental 2023, **11** (Suppl 1):001296

Introduction: The linear relationship between brain tissue oxygen tension (PbtO₂) and cerebral blood flow (CBF) and the difference between arterio-venous oxygen content (i.e., cerebral oxygen utilization) has been well described. However, how arterial oxygen pressure (PaO₂) can modulate PbtO₂ and brain metabolism in the absence of tissue hypoxia remains poorly reported.

Objectives: To investigate the relationship between PbtO₂, PaO₂ and lactate to pyruvate ratio (LPR), assessed by cerebral microdialysis (CMD) in patients with traumatic brain injury (TBI).

Methods: For this study, patients with severe adult (> 18 years) TBI, undergoing multimodal neuromonitoring according to local practices, were eligible if: a) PbtO₂ always > 20 mmHg; b) available LPR from CMD; available PaO₂. For each PaO₂ value, the corresponding LPR and the mean PbtO₂ value over the preceding 20 min were used. Also, the BOx Ratio (PbtO₂/PaO₂) and the oxygen metabolism ratio (OxMR = PaO₂/LPR) were computed. Correlation among variables was assessed using Pearson's r coefficient.

Results: Among 26 patients with available data, 7 patients met the inclusion criteria for final analysis. Median age was 40 [IQR 37–45] years; mean cerebral perfusion pressure over time was 91.7 ± 14.5 mmHg, while median PbtO₂ values was 25 [21–29] mmHg and BOx ratio 0.23 [0.19–0.29]. The number of combined measurements were 93 (11 [9–17] per patient). LPR had a stronger correlation with PaO₂ levels (r = -0.351 [95% confidence interval, 95%CI - 0.484 to - 0.149]) and a weaker correlation with PbtO₂ values (r = -0.266 [95%CI - 0.434 to - 0.034]). There was no correlation between the BOx Ratio and LPR, while the OxMR was significantly correlated with PbtO₂ (r = -0.266 [95%CI - 0.434 to - 0.034]).

Conclusions: In patients without tissue hypoxia, the OxMR significantly correlated with PbtO₂ values, suggesting this ratio could help to better understand the relationship between tissue oxygenation and metabolism.

References

- Wettervik TS, Engquist H, Howells T, Lenell S, Rostami E, Hillered L, Enblad P, Lewén A. Arterial Oxygenation in Traumatic Brain Injury-Relation to Cerebral Energy Metabolism, Autoregulation, and Clinical Outcome. *J Intensive Care Med*. 2021 Sep;36 (9):1075–1083. <https://doi.org/10.1177/0885066620944097>. Epub 2020 Jul 27. PMID: 32715850; PMCID: PMC8343201.
- Dellazizzo L, Demers SP, Charbonney E, Williams V, Serri K, Albert M, Giguère JF, Laroche M, Williamson D, Bernard F. Minimal PaO₂ threshold after traumatic brain injury and clinical utility of a novel brain oxygenation ratio. *J Neurosurg*. 2018 Nov 2:1–9. <https://doi.org/10.3171/2018.5.JNS18651>. Epub ahead of print. PMID: 30485198.
- Rosenthal G, Hemphill JC 3rd, Sorani M, Martin C, Morabito D, Obrist WD, Manley GT. Brain tissue oxygen tension is more indicative of oxygen diffusion than oxygen delivery and metabolism in patients with traumatic brain injury. *Crit Care Med*. 2008 Jun;36 (6):1917–24. <https://doi.org/10.1097/CCM.0b013e3181743d77>. PMID: 18496376.
- Oddo M, Levine JM, Frangos S, Maloney-Wilensky E, Carrera E, Daniel RT, Levivier M, Magistretti PJ, LeRoux PD. Brain lactate metabolism in humans with subarachnoid hemorrhage. *Stroke*. 2012 May;43 (5):1418–21. <https://doi.org/10.1161/STROKEAHA.111.648568>. Epub 2012 Feb 16. PMID: 22343642.

Topic: Neurointensive care

001298

Exposure to hyperoxemia worsens survival and neurological outcome in patients supported by veno-arterial extracorporeal membrane oxygenation: a systematic review and meta-analysis

S. Tigano¹, A. Caruso¹, C. Liotta², L. La Via³, F. Merola¹, F. Sanfilippo⁴
¹School of anaesthesia and intensive care, University Hospital "G. Rodolico", Catania, Italy; ²School of anaesthesia and intensive care, Magna Graecia University, Catanzaro, Italy; ³Anesthesiology and Intensive Care, University of Catania, Catania, Italy; ⁴Department of anesthesiology and intensive care, University Hospital "G. Rodolico", Catania, Italy
Correspondence: S. Tigano
Intensive Care Medicine Experimental 2023, 11 (Suppl 1):001298

Introduction: Veno-arterial Extracorporeal Membrane Oxygenation (VA-ECMO) has been implemented as rescue in case of refractory cardiogenic shock (CS) or during resuscitation (extracorporeal cardiopulmonary resuscitation, e-CPR). Exposure to hyperoxemia is common during VA-ECMO, but its impact on mortality and neurological outcome remains unclear.

Methods: We conducted a systematic review and metanalysis (PubMed and Scopus) investigating the effects of exposure to hyperoxemia on mortality and neurological outcome in patients supported by VA-ECMO. Whenever provided, we used the Odds Ratio (OR) adjusted for confounders. Results are reported as OR and 95% confidence interval (CI). Subgroup analyses were conducted according to indication for VA-ECMO and cut-off of hyperoxemia.

Results: Data from 11 observational studies were included. Ten studies reported data on mortality (6 on e-CPR, 4 on CS), only 4 on neurological outcome (eCPR only). As shown in Tables below, exposure to hyperoxemia was associated with higher mortality (OR:1.81, 95%CI 1.22–2.71; p=0.003;I²=81%) and worse neurological outcome (OR:1.97, 95%CI 1.30–2.96; p=0.001;I²=0%). This association remained valid the subgroup analyses conducted according to the cut-off of hyperoxemia (>200 or >300 mmHg, Tables 1.1 and 1.2) or to the indication for VA-ECMO (Tables 2.1 e 2.2), although the association with mortality remained uncertain in the eCPR population (p=0.07). The analysis using adjusted OR only confirmed the increased mortality (OR 1.72 [1.00–2.97], p=0.05) and poorer neurological outcome (OR 1.99 [1.18–3.37], p=0.01) in patients exposed to hyperoxemia.

Conclusions: Exposure to hyperoxemia after initiation of VA-ECMO is associated with increased probability of poor neurological outcome and mortality. Clinical efforts should be made to avoid severe hyperoxemia during VA-ECMO support.

Subgroup analysis according to PaO2

Table 1.1 Mortality according to PaO2 cut-offs

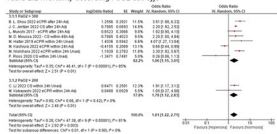
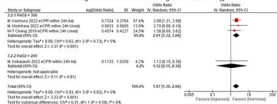

Table 1.2 Poor neurological outcome according to PaO2 cut-offs



Subgroup analysis according to indications

Table 2.1 Mortality according to indications

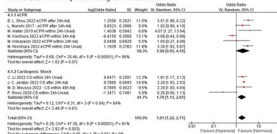
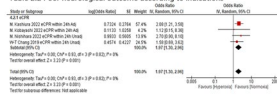

Table 2.2 Poor neurological outcome according to indications



References

1. Moussa MD et al. (2022) Early hyperoxia and 28-day mortality in patients on venoarterial ECMO support for refractory cardiogenic shock: a bicenter retrospective propensity score-weighted analysis. *Crit Care*
2. Ross P et al. (2021) Hyperoxia in patients with cardiogenic shock after myocardial infarction supported with venoarterial extracorporeal membrane oxygenation. *Aust Crit Care*

3. Cavarocchi NC et al. (2017) Introduction to Extracorporeal Membrane Oxygenation. *Crit Care Clin*
4. Stretch R et al. (2014) National trends in the utilization of short-term mechanical circulatory support: incidence, outcomes, and cost analysis. *J Am Coll Cardiol*
5. None

Topic: Cardiovascular issues in ICU

001299

Significance of guideline adherence in fungal infections

E. Holndonner-Kirst¹, K. Kárpáthi¹, H. Gál¹, D. Konczig¹, B. Bódi¹, E. Biro¹, V. Kesztyűs¹, L. K. Kópházi¹, J. Gál¹, C. Hermann¹
¹Department of Anesthesiology and Intensive Care, Semmelweis University, Budapest, Hungary
Correspondence: E. Holndonner-Kirst
Intensive Care Medicine Experimental 2023, 11 (Suppl 1):001299

Introduction: Despite international guidelines recommend prophylactic and therapeutic measures for presumed or proven infections, invasive fungal infections still mean diagnostic and therapeutic challenge in critically ill patients.

Objectives: Evaluation of the connection between guideline adherence and outcome in critically ill patients receiving antifungal therapy.

Methods: We retrospectively collected the clinical data of patients receiving antifungal therapy for at least two days in 2013–2014 and 2017–2018 in a tertiary intensive care unit. Guideline conformity was assessed retrospectively by two independent experts. In case of disagreement, a third independent expert's opinion decided.

Results: 107 patients were enrolled, 52 and 55 from the two study periods, respectively. The median age was 68 years (IQR: 61–78), the median SAPS II score was 59.5 (IQR: 42.75–74.25). Pulmonary or abdominal source was present in 35.5% and 55.1%, respectively. In 41.1% of the cases the fungal infection was proven by culture or serology.

Guideline adherence was higher in 2018, guideline-based therapy was prescribed in 52.7% vs. 26.9%, respectively, p=0.007. The rate of proven infections was also higher in the latter period (50.9% vs. 30.8%, respectively, p=0.034), but less pulmonary infections were seen (23.6% vs. 48.1% in 2018 and 2014, respectively, p=0,008). Although the median SAPS II score was higher in 2014 (62.00 (IQR: 49.00–78.00) for 2014 and 45.00 (IQR: 35.00–75.00) for 2018, respectively, p=0.002), we haven't found significant difference between the two periods in 28 days mortality.

Comparing the prophylactic and targeted therapy groups, patients with proven fungal infection were more likely to have bloodstream infections, the escalation rate, and 28 days mortality (24.2% vs. 54.8%, p=0.001) was higher in that group. Clinicians were more likely to follow the guidelines in case of antifungal prophylaxis: adequate dosage, proper duration of therapy and fully guideline-based therapy (55.6% vs. 18.2%; p<0.001) was significantly more frequent in the prophylactic group.

Risk factors for 28-days mortality were assessed in separate logistic regression models in the prophylactic and targeted therapy group. Inappropriate fungal prophylaxis was independently associated higher 28-days mortality (OR=7.62; 95% CI= 1.77–32.81; p=0.006). However, guideline adherence showed no beneficial impact on 28 days mortality in patients with proven fungal infection.

Conclusions: Our retrospective analysis shows that guideline adherence is beneficial in the prophylaxis of invasive fungal infections, but individual therapy, based on expert clinician's opinion is reasonable, and non-inferior in targeted therapy compared to strict guideline-adherence.

References

1. Ullmann AJ, Aguado JM, Arian-Akdagli S, Denning DW, Groll AH, Lagrou K, et al. Diagnosis and management of Aspergillus diseases: executive summary of the 2017 ESCMID-ECMM-ERS guideline. *Clin Microbiol Infect.* 2018;24 Suppl 1:e1–e38. 2. Cornely OA, Bassetti M, Calandra T, Garbino J,

Kullberg BJ, Lortholary O, et al. ESCMID* guideline for the diagnosis and management of Candida diseases 2012: non-neutropenic adult patients. *Clin Microbiol Infect.* 2012;18 Suppl 7:19–37. 3. Pappas PG, Kauffman CA, Andes DR, Clancy CJ, Marr KA, Ostrosky-Zeichner L, et al. Clinical Practice Guideline for the Management of Candidiasis: 2016 Update by the Infectious Diseases Society of America. *Clin Infect Dis.* 2016;62 (4):e1–50. 4. Walsh TJ, Anaissie EJ, Denning DW, Herbrecht R, Kontoyiannis DP, Marr KA, et al. Treatment of aspergillosis: clinical practice guidelines of the Infectious Diseases Society of America. *Clin Infect Dis.* 2008;46 (3):327–60.

- Investigator initiated study, funding from MSD Pharma

Topic: Infections and prevention

001301

Body composition and muscle strength at the end of ICU stay are associated with one-year mortality, a prospective multicenter observational study

A. Ait Hssain¹, N. Farigon², H. Merdji³, D. Guelon⁴, J. Bohé⁵, S. Cayot⁶, R. Chabanne⁴, J. M. Constantin⁶, B. Pereira⁷, D. Bouvier⁸, N. Andant⁷, H. Roth⁹, R. Thibault¹⁰, V. Sapin⁸, M. Hasselmann³, B. Souweine¹¹, N. Cano², Y. Boirie², C. Dupuis¹

¹Médecine intensive-réanimation, CHU Gabriel-Montpied, Clermont-Ferrand, France; ²Nutrition, CHU Gabriel-Montpied, Clermont-Ferrand, France; ³Médecine intensive et réanimation, CHU Strasbourg, Strasbourg, France; ⁴Département anesthésie réanimation, CHU Gabriel-Montpied, Clermont-Ferrand, France; ⁵Service d'anesthésie-réanimation médecine intensive, Lyon Sud Hospital Center, Pierre-Bénite, France; ⁶Department of anesthesiology and intensive care medicine, University Hospital of Clermont-Ferrand, Clermont-Ferrand, France; ⁷Biostatistic, CHU Gabriel-Montpied, Clermont-Ferrand, France; ⁸Biologie, CHU Gabriel-Montpied, Clermont-Ferrand, France; ⁹Biostatistic, CHU Grenoble Alpes, La Tronche, France; ¹⁰Nutrition, NuMeCan institute, INSERM, INRAE, CHU Rennes, Université de Rennes 1-Campus Santé de Villejean, Rennes, France; ¹¹Service de réanimation médicale, CHU Gabriel-Montpied, Clermont-Ferrand, France

Correspondence: C. Dupuis

Intensive Care Medicine Experimental 2023, **11** (Suppl 1):001301

Introduction: After a prolonged intensive care unit (ICU) stay, patients are characterized by an increased mortality and morbidity.

Objectives: The primary aim of this study was to assess the prognostic value of nutritional status, body mass composition and muscle strength, as assessed by body mass index (BMI), bioelectrical impedance analysis (BIA), handgrip (HG) test, and biological features allowing estimation of the prognostic inflammatory and nutritional index (PINI), on one-year survival at the end of a prolonged ICU stay.

Methods: This was a multicenter prospective observational study. Survivor patients, older than 18-year-old, with ICU length of stay > 72 h, were eligible for inclusion. BIA and HG were performed at the end of the ICU stay. Malnutrition was defined by BMI and fat-free mass index. The primary endpoint was one-year mortality. Multivariable logistic regression was performed to determine parameters associated with mortality.

Results: 572 patients were included with a median age of 63 years [53.5;71.1], BMI of 26.6 kg/m² [22.8;31.3], SAPS II of 43[31;58] and ICU length of stay of 9 days [6;15]. Malnutrition was observed in 142 (24.9%) of the patients. During the one-year follow-up after discharge, 96 (18.5%) patients died. After adjustment, a low HG test score (aOR = 1.44 [1.11;1.89], *p* = 0.01) was associated with one-year mortality. Patients with low HG score, malnutrition and PINI > 20 had a one-year death rate of 42%. Conversely, patients with none of those parameters had a one-year death rate of 6.93%.

Conclusions: BIA, HG and PINI score at the end of ICU stay could be used to predict one-year mortality. Their performances to identify patients eligible for a structured recovery program could be studied.

Topic: Metabolism, endocrinology, liver failure and nutrition

001302

Making normothermic regional perfusion in controlled donation after circulatory death a reality for potential donors across the region of Madrid. Results of a Mobile ECMO team

N. Martínez Sanz¹, S. Alcántara Carmona¹, P. Matía Almudévar¹, M. Pérez Redondo¹, I. Fernández Simón¹

¹Intensive care, Puerta de Hierro Majadahonda University Hospital, Majadahonda, Spain

Correspondence: N. Martínez Sanz

Intensive Care Medicine Experimental 2023, **11** (Suppl 1):001302

Introduction: Abdominal normothermic regional perfusion (A-NRP) in controlled donation after circulatory death (cDCD) is recommended in preference to in situ cooling and rapid procurement (1B). This procedure requires experience and the availability of extracorporeal membrane oxygenation (ECMO), that sometimes is limited to tertiary hospitals. In order to provide support with A-NRP in centers with cDCD programs but without ECMO access, the region of Madrid created a A-NRP team. Our center, with VV and VA ECMO experience, is a part of a one week-on/one week-off roster.

Objectives: Describe the experience of our center as part of the Mobile ECMO team since the program begun.

Methods: Descriptive and retrospective study (April 2017-December 2022). We included all Mobile ECMO team outings. We studied demographic data, ICU length of stay and the reasons for withdrawal of life-sustaining treatments (WLST) of the donors. Number of organs evaluated and the reasons for discard, ECMO run and complications related with ECMO cannulation were also reported.

Results: Our ECMO Mobile team was mobilized 41 times to ten different hospitals during the period studied. A-NRP was successfully performed in 37 cases.

Of the 37 utilized donors 21 (59%) were male with mean age of 58 ± 14 years. The reasons for WLST were anoxic encephalopathy following cardiac arrest (*n* = 17, 46%), catastrophic brain injury after ischemic/hemorrhagic cerebrovascular event or traumatic brain injury (*n* = 16, 43%), terminal respiratory illness (*n* = 3, 8%) and one case (3%) after euthanasia. Mean ICU length of stay was 9 ± 8 days.

Cannulation problems were reported in 15 cases (40%) with 4 hemorrhagic complications during vessels cannulation and 11 events of non-progression of the aortic balloon that needed surgical cross clamp of the aorta before A-NRP commencement.

Mean warm ischemia times were 15 ± 6 min. Mean duration of the A-NRP was 82 ± 27 min.

Of the 64 kidneys, 32 livers and 11 bilateral lungs evaluated 58 kidneys, 18 livers and 7 bilateral lungs were finally implanted. The main reason for discard was unfavorable visual assessment and surgical complications and only in one case because of prolonged warm ischemia time.

Conclusions: The establishment of a Mobile ECMO team is feasible across the region of Madrid. This program allows to potential cDCD donors from hospitals without ECMO technology be evaluated for A-NRP, increasing the pool of organs suitable for transplantation.

Cannulation problems are common but in most of the cases the A-NRP is possible, that emphasized the fact that experience and dedicated team is the cornerstone to achieve good results.

References

1. Jochmans I, Hessheimer AJ, Neyrinck AP, et al. Consensus statement on normothermic regional perfusion in donation after circulatory death: Report from the European Society for Organ Transplantation's Transplant Learning Journey. *Transpl Int.* 2021 Nov;34 (11):2019–2030. <https://doi.org/10.1111/tri.13951>.

Topic: Brain death, organ donation and transplantation

001303

Frailty impact on outcome in geriatric patients admitted to the Intensive Care Units

M. Bourbon Ruao¹, R. Pinto Medeiros¹, R. Pereira¹, J. R. Monte¹, A. Silva¹
¹Serviço de Cuidados Intensivos, Hospital Geral de Santo António, Porto, Portugal

Correspondence: M. Bourbon Ruao
Intensive Care Medicine Experimental 2023, 11 (Suppl 1):001303

Introduction: European population is aging and the burden on the intensive care unit (ICU) admissions of very old patients (age ≥ 80 years) is also rising, representing approximately one fourth of all ICU admissions. [1] Despite the advances in the support for older critically ill patients, the long-term morbidity and mortality rates remain substantial. [2] Chronological age alone is an insufficient predictor of outcome from critical illness, as there is often significant variation in physiological changes in older people.[3] Frailty has become recognized as an important prognostic indicator in critically ill patients in contrast with age. [4].

Objectives: The aim of this study is to identify the impact of frailty on the length of mechanical ventilation, length of stay (LOS) in the ICU and in the hospital and on ICU and hospital mortality in very old patients.

Methods: In a single center, this observational study included all very old (≥ 80 years) patients admitted to a general ICU between the 1st of January and the 31st of December of 2022. Demographics, SAPSII, SOFA, duration of mechanical ventilation, use of vasopressors and measurement of frailty using the Clinical Frailty Scale (CFS) were collected. The analyses were performed with the SPSS (R) statistics (vs 25) using t-test, correlation coefficients (Pearson) and survival analysis (log-rank test). Significant was defined if $p < 0.05$.

Results: A total of 59 patients (47.5% male) with a mean age of 85.7 ± 4.3 years were included in this study. The mean CFS of 4.68 ± 1.55 points and more than half of the patients (50.8%) were classified as frail (CFS ≥ 5). Admission was unplanned in 89.8% ($n = 53$) of the patients. Either SAPSII and SOFA total had a non-significant correlation coefficient with CFS ($p = 0.35$ and $p = 0.448$, respectively). ICU-mortality was 35.6% and the hospital mortality was 47.5%. A total of 26 (44.1%) patients were mechanical ventilated and mean duration of ventilation was 8.8 ± 7.0 days. The ICU LOS in frail (CFS ≥ 5) patients 7.13 ± 5.89 days and 11.86 ± 9.96 in non-frail (CFS < 5) which was found to be significant ($p = 0.005$) and ICU mortality was higher in the frail patients ($p = 0.013$). There was no significant difference between frailty and the duration of mechanical ventilation or hospital LOS or hospital mortality. In the ICU the non-frailty population has significantly survival likelihood (log-rank test, $p = 0.008$).

Conclusions: Among very old patients (≥ 80 years) admitted to the ICU, frailty (CFS ≥ 5) was associated with a shorter LOS in the ICU but increased ICU-mortality. Frailty did not correlate with the severity illness score (SAPSII) and organ dysfunction (total SOFA). These findings may indicate that the use and the impact of CFS in the ICU setting as a predictor of mortality is not fully studied. In conclusion, the admission of geriatric patients to the ICU is increasing and frailty is an emerging prognostic factor for the outcome in the ICU which may play an important role in the clinical evaluation of very old patients but with a high dependency of the local policy of admission and discharge.

References

- [4] Muscedere J, Waters B, Varambally A, Bagshaw SM, Boyd JG, Maslove D, Sibley S, Rockwood K. The impact of frailty on intensive care unit outcomes: a systematic review and meta-analysis. *Intensive Care Med.* 2017 Aug;43 (8):1105–1122.

- [3] Lonsdale DO, Tong L, Farrah H, et al. The clinical frailty scale—does it predict outcome of the very-old in UK ICUs? *Journal of the Intensive Care Society.* 2022;0 (0).
- [2] McDermid, R.C., Bagshaw, S.M. Octogenarians in the ICU: are you ever too old?. *Crit Care* 15, 125 (2011).
- [1] Muessig, J.M., Nia, A.M., Masyuk, M. et al. Clinical Frailty Scale (CFS) reliably stratifies octogenarians in German ICUs: a multicentre prospective cohort study. *BMC Geriatr* 18, 162 (2018).

Topic: Critical care organisation, quality management, information systems, outcomes

001304

Echocardiography reporting in liver transplant candidates

Z. Elliott¹, R. Baral², T. Pirani³, R. Loveridge³, A. Varuna⁴, A. Papachristidis⁵, S. Patel³

¹Department of Hepatology, Institute of Liver Studies, King's College Hospital, London, United Kingdom; ²Department of Critical Care, King's College Hospital, London, United Kingdom; ³Consultant in Critical care, Liver Intensive Therapy Unit, King's College Hospital, London, United Kingdom; ⁴Consultant Transplant Hepatologist, Institute of Liver Studies, King's College Hospital, London, United Kingdom; ⁵Consultant in Cardiology and Heart Failure, King's College Hospital, London, United Kingdom

Correspondence: Z. Elliott
Intensive Care Medicine Experimental 2023, 11 (Suppl 1):001304

Introduction: Cardiac disease is the most common cause of death in the peri liver transplantation (LT) period. Patients with end-stage liver disease are at increased risk of liver specific cardiovascular complications such as portopulmonary hypertension and cirrhotic cardiomyopathy (CCM), in addition to the risk of common cardiac comorbidities prevalent in the general population. Echocardiography is an integral part of the cardiovascular assessment for LT work up. We conducted a service evaluation and improvement project to standardise echocardiographic assessment for LT in our institution.

Methods: A single centre, retrospective evaluation of echocardiograms in adults who underwent liver transplant assessment in a large tertiary LT centre in the UK between the 09/07/2021 and 28/10/2022. Following initial evaluation, a standardised set of parameters were implemented in order to optimise quality of assessment. Echo reports pre and post intervention were compared to assess whether the parameters for a complete assessment were reported.

Results: A total of 93 and 133 patients were identified in the pre and post intervention group respectively. Complete cardiac evaluation including comments on LV, RV systolic and diastolic function, presence of pulmonary hypertension (PH) and regional wall motion abnormality (RWMA) occurred in 5/93 (5.4%) of the pre-intervention compared to 28/133 (21.1%) in the post intervention group. LV ejection fraction was consistently reported across both time periods; 89/93 (95.7%) and 130/133 (97.7%) respectively. Improvements in reporting were seen relating to PH and RWMA occurring in 26 (28%) vs 79 (59%); and 38 (41%) vs 100 (75%) respectively. However, there was no change in diastolic function reporting, 36 (39%) vs 54 (41%). CCM was diagnosed in 0 patients pre-intervention, and 3/54 (5.6%) patients post intervention in those with complete systolic and diastolic assessments. PH was ascertained pre and post intervention in 1/26 (3.8%) and 5/79 (6.3%) respectively, necessitating subsequent diagnostic right heart catheterisation.

Conclusions: Overall, echocardiography reporting for LT assessment improved following implementation of standardised reporting criteria. However, determination of diastolic function and cirrhotic cardiomyopathy remain areas requiring further improvement. Given the increased risk of cardiac dysfunction in these cohort of patients, complete reporting in pre-assessment investigations is essential and needs to be emphasised.

Topic: Brain death, organ donation and transplantation

001306

Feasibility of suprasternal aortic velocity time integral variability and of internal jugular vein collapsibility to predict fluid-responsiveness in healthy volunteers

A. Caruso¹, G. Bonelli¹, L. La Via², M. Zawadka³, S. Tigano¹, F. Sanfilippo⁴
¹School of anaesthesia and intensive care, University Hospital "G. Rodolico", Catania, Italy; ²Anesthesiology and Intensive Care, University of Catania, Catania, Italy; ³2nd Department of Anaesthesiology and Intensive Care, Medical University of Warsaw, Warszawa, Poland; ⁴Department of anesthesiology and intensive care, University Hospital "G. Rodolico", Catania, Italy

Correspondence: A. Caruso

Intensive Care Medicine Experimental 2023, **11 (Suppl 1)**:001306

Introduction: Assessment of fluid-responsiveness (FR) is crucial in critically ill patients. Ultrasonographic assessment of inferior vena cava collapsibility (IVC) and left ventricular outflow tract velocity time integral (LVOT-VTI) variability are commonly utilized non-invasive tests (1). However, several obstacles may preclude their use due to suboptimal ultrasound window. Appealing alternatives for the FR assessment might be the variability of aortic velocity time integral (Aorta-VTI) in the suprasternal window, or the internal jugular vein collapsibility (IJVc) (2).

Objectives: To determine feasibility of alternative ultrasound methods for FR assessment.

Methods: We performed a prospective observational single-centre study on 40 healthy volunteers. We first evaluated the feasibility of suprasternal Aorta-VTI variability [(Velocitymax—Velocitymin) / Velocitymean] and of IJVC [(Diametermax—Diametermin) / Diametermax], and then their ability in predicting FR. As comparators, other parameters investigated were the LVOT-VTI variability and the IVCc (from both subcostal and transhepatic window, both in M-mode and with the aid of automated border detection). FR was determined according to changes in cardiac output (CO) between its baseline (time of recording of parameters), and the highest value of CO registered within two minutes after the passive leg raising (PLR) manoeuvre.

A cut-off of a 10% increase in CO was used to define FR. Values of CO were obtained with the non-invasive continuous CO monitoring (Clearsight, Edwards Lifescience, US). Analysis was conducted with the evaluation of the Area Under the Receiver Operating Characteristic Curve (AUC-ROC); correlation between variables was conducted with Pearson r coefficient.

Results: The feasibility to obtain measurements of suprasternal Aorta-VTI variability and of the IJVC were 95% and 97.5%, respectively. The highest value of AUC among the ROC curves was seen for the LVOT-VTI variability (0.85; cut-off 10.1%, sensibility 90%, specificity 75%), whilst the performance of all other methods was poor (Table 1). Suprasternal aortic-VTI was the only method showing a significant correlation with the LVOT-VTI ($p=0.005$; moderate degree $r=0.47$). Conversely, IJVC had no correlation with the all the IVCc measurements (subcostal or transhepatic, M-mode or automated border detection).

Conclusions: In a population of healthy volunteers, we found excellent feasibility for the calculation of suprasternal Aorta-VTI variability and of the IJVC. However, their predictive value for estimating FR seems to be of limited value. Such indexes should be evaluated in critically ill patients. In particular, the correlation of suprasternal Aorta-VTI variability with the LVOT-VTI variability seems promising.

Table 1 (abstract 001306) .

Method	AUC value
LVOT-VTI	0.85
Suprasternal Aortic-VTI	0.50
IJVC M-Mode	0.52
IVCc subcostal in M-mode	0.52
IVCc subcostal in automated border detection	0.61
IVCc transhepatic in M-Mode	0.56
IVCc in automated border detection	0.66

References

2. Kent A, Patil P, Davila V, Bailey JK, Jones C, Evans DC, Boulger CT, Adkins E, Balakrishnan JM, Valiyaveedan S, Galwankar SC, Bahner DP, Stawicki SP. Sonographic evaluation of intravascular volume status: Can internal jugular or femoral vein collapsibility be used in the absence of IVC visualization? *Ann Thorac Med.* 2015 Jan-Mar;10 (1):44–9. <https://doi.org/10.4103/1817-1737.146872>. PMID: 25593607; PMCID: PMC4286845.
1. Xie J, Wan J, Xu L, Zhang Y, Chen J. The Accuracy of Velocity–Time Integral Variation and Peak Velocity Variation of the Left Ventricular Outflow Tract in Predicting Fluid Responsiveness in Postoperative Patients Mechanically Ventilated at Low Tidal Volumes. *J Cardiothorac Vasc Anesth.* 9:S1053-0770 (23)00096–4. <https://doi.org/10.1053/j.jvca.2023.02.009>. Epub ahead of print. PMID: 36931906. 2023 Feb.
- "Starting Grant—PIACERI Plan", University of Catania

Topic: Cardiovascular issues in ICU

001307

Monitoring and safe use of regional citrate anticoagulation for renal replacement therapy in patients with metformin intoxication: a case series and mathematical model

F. Zadek¹, B. Beatrice¹, F. Mulazzani¹, G. Verza², L. Faraldi³, A. Protti⁴, R. Fumagalli¹, T. Langer¹

¹Department of Medicine and Surgery, Building U8-University of Milan Bicocca, Monza, Italy; ²Dipartimento di Fisica e Astronomia "G. Galilei", Università degli Studi di Padova, Padova, Ital, Istituto Nazionale di Fisica Nucleare Sezione di Padova INFN, Padova, Italy; ³Department of Anesthesia and Intensive Care Medicine, ASST Great Metropolitan Niguarda, Milano, Italy; ⁴Department of Anesthesia and Intensive Care Unit, IRCCS Humanitas Research Hospital, Rozzano, Italy

Correspondence: F. Zadek

Intensive Care Medicine Experimental 2023, **11 (Suppl 1)**:001307

Introduction: Metformin intoxication causes lactic acidosis inhibiting Krebs' cycle and oxidative phosphorylation. The Extracorporeal Treatment In Poisoning group recommends Continuous Renal Replacement Therapy (CRRT) to remove metformin in critically ill patients (1). From 2012, KDIGO guidelines recommend using Regional Citrate Anticoagulation (RCA) due to its lower risk of bleeding than systemic heparin (2). Metformin inhibits citrate metabolism in the Krebs' cycle³; therefore, the risk of citrate accumulation can be supposed with scarce evidence from the literature (4). The direct measurement of citrate is rarely available, and its accumulation is usually estimated by T/I calcium ratio.

Objectives: The aim of the present case series is to describe how the physiochemical approach to acid–base could safely exclude significant citrate accumulation.

Methods: Three patients admitted to the Intensive Care Unit (ICU) with a diagnosis of Metformin-associated Lactic Acidosis (MALA) and treated with CRRT (Baxter International SA, Zurich Switzerland) were studied (Table 1). A mathematical model was developed to simulate the expected citrate accumulation occurring during Continuous veno-venous hemofiltration (CVVH) set as follows: blood flow 150 ml/min, RCA with citrate of 18 mmol/L at 1500 ml/h, post-dilution replacement flow 1500 ml/h, no weight loss. The potential citrate blood accumulation was indirectly monitored as a Total-to-Ionized calcium ratio (*T/I ratio*) above 2.5 and by calculating the Strong Ion Gap (SIG) to identify an increased concentration of Unmeasured Anions (UA).

Results: All three patients showed a resolution of MALA. The SIG calculated after 48 h of treatment was always below 6 mEq/L (Figure 1). In the absence of any metabolism, the estimated citrate accumulation should have been 7 mmol/L after 48 h of CVVH, corresponding to 21 mEq/L of SIG. The *T/I ratio* was consistently lower than 2.5, and the systemic ionized calcium concentration was above 0.90 mmol/L.

Conclusions: Our data support the safety of the use of diluted citrate during CRRT treatment in patients with metformin intoxication. Monitoring the SIG could be an additional valuable tool to detect and monitor citrate accumulation in this context.

Table 1 (abstract 001307) Patient characteristics at ICU admission.

Variables	Patient 1	Patient 2	Patient 3
Age (year)	66	66	71
Sex	Female	Male	Female
Weight (Kg)	70	75	75
Charlson Comorbidity Index	7	6	6
Metformin concentration (mcg/mL)	28.0	10.5	82.5
Chronic Kidney Disease	No	Yes	No
Creatinine (mg/dL)	8.1	4.1	9.0
Urea (mg/dL)	140	114	190

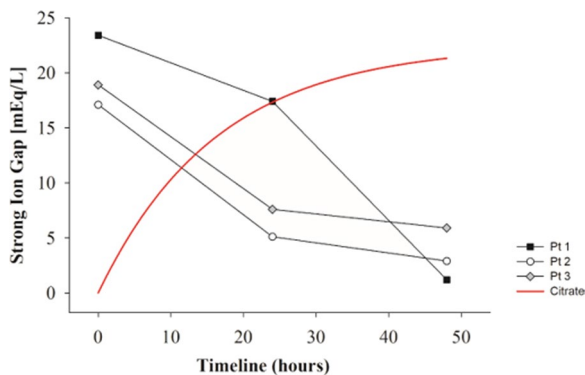

Figure 1 (abstract 001307) SIG in the three patients and calculated citrate accumulation with no metabolism (red line)

References

1. 4. Khadzhynov D. et al, Journal of Critical Care (2014).
2. 3. Protti A. et al, Critical Care (2010)

3. 2. Gattas D.J. et al, Critical Care Medicine (2015).
4. 1. Calello D. P et al, Critical Care Medicine (2015).
5. The author (s) received no financial support for the research, authorship, and/or publication of this article

Topic: Acute Kidney Injury and haemofiltration

001308

Sodium alterations during continuous veno-venous renal replacement therapy

F. Zadek¹, B. Beatrice¹, F. Mulazzani¹, C. Bonenti², F. Tardini², T. Langer¹, R. Fumagalli¹

¹Department of Medicine and Surgery, Building U8-University of Milan Bicocca, Monza, Italy; ²Department of Anesthesia and Intensive Care Medicine, ASST Great Metropolitan Niguarda, Milano, Italy

Correspondence: F. Zadek

Intensive Care Medicine Experimental 2023, 11 (Suppl 1):001308

Introduction: The prevalence of ICU-acquired hyponatremia is about 15%, and it is associated with poor outcomes and increased mortality (1). About 10% of patients admitted to the intensive care unit (ICU) receive continuous renal replacement therapy (CRRT) (2,3), exposing them to large exchanges of volume and rapid electrolyte shifts.

Objectives: The aim of the present study was to describe variation in sodium concentration ([Na⁺]) during continuous veno-venous hemofiltration (CVVH) and assess the incidence of hyponatremia after 48 h of CVVH treatment.

Methods: Oligo-anuric ICU patients with clinical indications for CRRT (PrimsmaMax, Baxter) were enrolled. The CRRT was performed in CVVH modality, with 150 ml/min of blood flow. Regional anticoagulation was achieved with diluted citrate (Prismocitrate 18/0; Gambro) at 1500 ml/h. Phoxilium (Baxter Healthcare Spa) or Multibic 2 K (Fresenius Medical Care, Germany) was employed as replacement solutions and administered post-dilution at 1500 ml/h. Of note, all three solutions have a declared [Na⁺] of 140 mmol/L. [Na⁺] was measured by direct ion-selective methods (RAPIDPoint 500 Blood Gas System, Siemens Healthcare Diagnostics) at the beginning of CVVH treatment (T0) and after 3, 6, 12, 24, 48, and 72 h. Osmolality was measured by the freezing point at T0 and after 24, 48, and 72 h.

Sodium variations were analyzed via one-way ANOVA for repeated measures or one-way ANOVA for repeated measures on Ranks, using Bonferroni's or Dunn's correction for post hoc analysis, respectively. A binomial test was performed to compare the incidence of hyponatremia with the expected incidence reported in the literature (*i.e.*, 15%). Data are reported as mean \pm standard deviation.

Results: Twenty-six patients aged 62 ± 14 years were enrolled. Three patients were hyponatremic (130 ± 2 mmol/L), seven patients were hypernatremic (151 ± 4 mmol/L), and sixteen normonatremic (141 ± 3 mmol/L). Overall, [Na⁺] decreased from 142 ± 7 to 135 ± 3 mmol/L ($p < 0.001$) in 48 h (Figure 1). After 48 h of CVVH, a higher than expected prevalence of hypoosmolar hyponatremia (133 ± 1 mmol/L, 295 ± 9.6 mOsm/L) was recorded (69% vs. 15%, $p = 0.02$) (Fig. 2).

Conclusions: During CVVH, we observed after 48 h a significant decrease in [Na⁺] and a high incidence of hyponatremia, confirmed by osmolality.

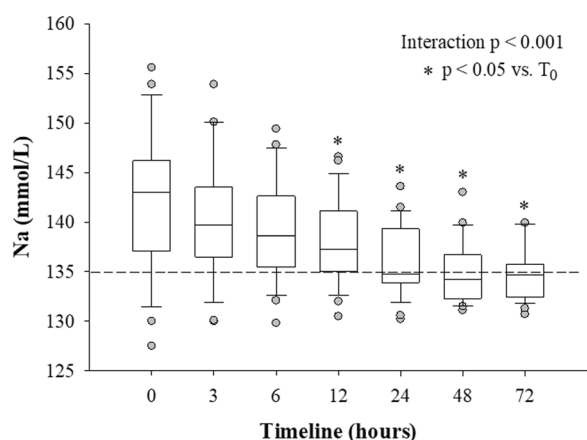

Figure 1 (abstract 001308) Change in sodium concentration during CVVH treatment

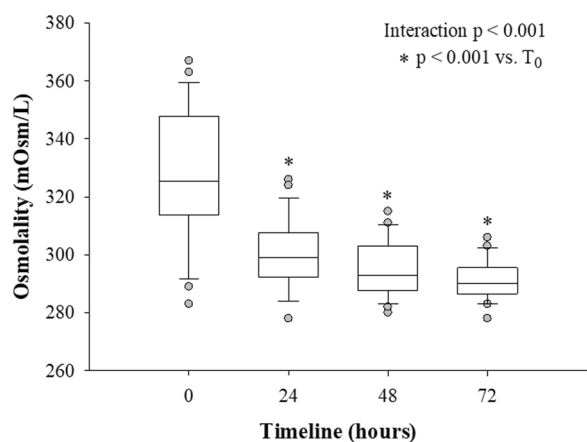

Figure 2 (abstract 001308) Change in osmolality concentration during CVVH treatment

References

1. Stelfox H.T. et al, Critical Care, 2008
2. Ronco C. et al, Contrib Nephrol Basel, 2010
3. EAJ Hoste E.A.J. et al, Intensive Care Med, 2015
4. The author (s) received no financial support for this article's research, authorship, and/or publication.

Topic: Acute Kidney Injury and haemofiltration

001311

Mortality risk in covid-19 veno-venous extracorporeal membrane oxygenation—experience of a Portuguese tertiary hospital

F. Sequeira¹, A. Marques¹, L. Linhares¹, R. Freitas¹, E. Sousa¹, P. Martins¹
¹Intensive Care Unit, Centro Hospitalar e Universitário de Coimbra, Coimbra, Portugal

Correspondence: F. Sequeira

Intensive Care Medicine Experimental 2023, **11 (Suppl 1)**:001311

Introduction: Veno-venous extracorporeal membrane oxygenation (VV-ECMO) has become an established therapy to support ARDS in COVID-19 patients failing conventional management. However, this therapy has several potential serious complications, with an estimated incidence of in-hospital mortality after ECMO initiation of 48% (Data from the Extracorporeal Life Support Organization) and is also a limited resource. More accurate predictors of prognosis of COVID-19

patients on ECMO are needed to understand which patients can benefit from this support.

Objectives: The aim of the study was to determine predictors of mortality in patients with COVID-19 supported with ECMO.

Methods: A retrospective observational cohort study of COVID-19 VV-ECMO patients, cannulated between April 1, 2020, and December 31, 2022, at a tertiary center. The primary outcome is in-hospital mortality.

Results: Forty-seven patients (mean age 51.68 ± 11.41 , male 68.09%) received VV-ECMO for severe COVID-19 related ARDS.

Before ECMO initiation, median body-mass index was 35.8 ± 7.94 kg/m², mean Simplified Acute Physiology Score (SAPS) II was 37.70 ± 14.94 , mean Sequential Organ Failure Assessment (SOFA) score was 7.64 ± 2.54 , mean PaO₂/fraction of inspired oxygen ratio was 80.85 ± 21.90 , most patients received prone positioning (89.36%) and non-invasive ventilatory support before endotracheal intubation (61.70%). The median duration until ECMO initiation was 3.7 days ± 4.3 . The median duration of ECMO support was 21.13 days ± 14.41 .

The most frequent post-cannulation complications were ventilator associated pneumonia (n=32; 68.09%), bleeding complications (n=20; 42.55%), bloodstream infections (n=11; 23.40%) and thrombotic complications (n=8; 17.02%).

Mortality was 38.30% (n=18). In patients who died, the median age was 59.28 ± 7.54 , 15 male, duration until ECMO was 3.3 days and the median duration of ECMO support was 23 days.

Predictors of mortality were advanced age (OR 1.187, 95% CI 1.066–1.323, p=0.002), SAPS II (OR 1.056, 95% CI 1.006–1.108, p=0.026) and SOFA (OR 1.659, 95% CI 1.150–2.395, p=0.007) were associated with increased risk of mortality. High BMI was not a predictor of mortality (OR 0.87, 95% CI 0.73–1.028, p=0.1).

Youden's test showed that the best cutoff value of age to predict mortality was 54.5 (sensitivity 83.3%, specificity 72.4%) and AUC 0.83, best cutoff value of SOFA was 8 (sensitivity 83.3%, specificity 55.2%) and AUC 0.75, best cutoff value of SAPS II was 33 (sensitivity 66.7%, specificity 69%) and AUC 0.70.

Conclusions: As expected, age, SOFA and SAPS II were identified as individual predictors of mortality of COVID-19 patients submitted to VV-ECMO treatment.

Other parameters that we anticipated in the clinical setting as important predictors of mortality (namely PaO₂/FiO₂), did not prove relevance.

Adding to the discussion and in line with literature elevated BMI was a protective factor.

References

1. Ramanathan K, et al. Extracorporeal membrane oxygenation for COVID-19: a systematic review and meta-analysis. *Crit Care*. 2021 Jun 14;25 (1):211
2. Fan E, Gattinoni L, et al. Venovenous extracorporeal membrane oxygenation for acute respiratory failure: A clinical review from an international group of experts. *Intensive Care Med*. 2016 May;42 (5):712–724
3. Whebell S, et al. Survival benefit of extracorporeal membrane oxygenation in severe COVID-19: a multi-centre-matched cohort study. *Intensive Care Med*. 2022 Apr;48 (4):467–478

Topic: Acute respiratory failure and mechanical ventilation.

001312

Evaluation of hemostasis using viscoelastic tests in patients with SARS-COV-2 infection on ECMO support

T. Sevilas¹, I. Santos², J. Alves², J. L. Luzio², E. Sousa², J. M. Pego³, F. Caramelo⁴, A. Paiva⁵, P. Martins²

¹Department of Blood Transfusion, Centro Hospitalar e Universitário de Coimbra, Coimbra, Portugal; ²Intensive Care Unit, Centro Hospitalar e Universitário de Coimbra, Coimbra, Portugal; ³Department of Laboratory Medicine, Centro Hospitalar e Universitário de Coimbra, Coimbra, Portugal; ⁴Department of Statistics, Faculty of Medicine, University of Coimbra, Coimbra, Portugal; ⁵Flow Cytometry Unit, Centro Hospitalar e Universitário de Coimbra, Coimbra, Portugal

Correspondence: I. Santos

Intensive Care Medicine Experimental 2023, **11 (Suppl 1)**:001312

Introduction: COVID-19 coagulopathy is associated with poor prognosis, characterized by a significant increase in fibrinogen (Fib), D-Dimers and a normal or slightly altered platelet count, prothrombin time and activated partial thromboplastin time. A state of "hypercoagulopathy" (HyperC) and "hypofibrinolysis" (HypoF) coexists, only detected by viscoelastic tests (VET). Extracorporeal membrane oxygenation (ECMO), often used as a rescue therapy in SARS-CoV-2 infection, is associated with coagulation abnormalities including life-threatening hemorrhage, thrombosis, and thromboembolic events, triggered by contact of blood with a foreign surface and the resulting activation of both coagulation and inflammatory pathways.

Objectives: We aim to evaluate and characterize the longitudinal hemostatic profile during ECMO in COVID-19 using VET- ROTEM®.

Methods: Prospective, nonblinded, non-randomized study. Consecutive recruitment of adult COVID-19 patients admitted to our hospital's ICU, during a 6-month period. Patients with thrombosis in the previous 3 months, pregnancy, hormone therapy, and congenital coagulopathies were excluded. Patients were tested every 5 days, at discharge and in complications.

Results: We observed a progressive decrease in plasma levels of Fib throughout hospitalization, as the patient progressed to discharge. The CFT-ExTem is <45 in 4 patients until the 3rd sample (15th day of ECMO, on average). The MCF-FibTem is >22 and the MCF-EXTEM is >68, especially in the first 3 samples in all patients. CT-ExTem is never <45 and LI60-EXTEM is never <=3.

Evaluation of hemostasis using viscoelastic tests in patients with SARS-COV-2 infection on ECMO

	Hemostasis lab tests	
	1st sample	last sample
FvW:RC	244.0 (68.4) 250.0; (221.0/250.0)	265.0 (110.9) 274.5; (226.0/ 313.5)
CT-ExTem	77.1 (17.0) 83.0; (63.0/84.0)	105.0 (24.8) 114.0; (95.5/ 119.0)
CFT-ExTem	48.7 (11.1) 46.0; (41.0/ 55.0)	89.7 (15.6) 92.0; (82.5/ 98.0)
MCF-ExTem	71.9 (3.6) 72.0; (70.0/74.0)	63.3 (3.1) 64.0; (62.0/ 65.0)
MCF-FibTem	33.2 (6.9) 33.0; (29.0/ 34.0)	15.7 (6.7) 14.0; (12.0/ 18.5)
LI60-ExTem	88.3 (33.1) 99.0; (99.0/100.0)	98.0 (1.7) 97.0; (97.0/ 98.5)

Conclusions: Data analysis of patients under ECMO support (see Table): n=9, there were no deaths, bleeding complications in 4 (44.4%) patients and thrombotic complications in 2 (22.2%) patients. Patients have the usual HyperC status described in COVID during the first 15 days of ECMO, especially due to MCF-Extem and MCF-Fibtem parameters. After this initial phase, patients present no longer a HyperC profile in Rotem®, which may have 2 causes: 1) decrease in Fib plasma levels throughout the course of the disease, probably related to control of inflammation pathways; 2) consumption/activation of platelets and other clotting factors by contact of blood with a foreign surface of extracorporeal circuit. There are HyperC parameters that are never altered: CT-Extem and CFT-Extem, which are highly dependent on the presence of heparin, never <45. Additionally, LI60-EXTEM is never compatible with HypoF.

These findings may lead one to think that in patients on ECMO, the baseline state of COVID is "compensated" by the hyperfibrinolysis associated with this technique, due to lysis/consumption of platelets and clotting factors by the filter, and/or by regional anticoagulation of the circuit.

References

1. Korean J Anesthesiol. 2019;72 (4):297–322

Topic: Transfusion and haemostasis disorders

001313

Alveolar-arterial oxygen gradient is a better marker of respiratory insufficiency and hypoxemia in comparison with PaO2/Fio2

A. Montoro¹, J. P. Vázquez², A. Sierra², J. I. Amigo²

¹ICU, Angeles Hospital Lomas, Mexico, Mexico; ²ICU, Angeles Hospital Lomas, HUIXQUILUCAN, Mexico

Correspondence: A. Montoro

Intensive Care Medicine Experimental 2023, **11** (Suppl 1):001313

Introduction: Alveolar-arterial gradient can be useful as a predictor of hypoxemia, as well as an index of the ventilatory function. It can also define the mechanism of hypoxemia as shunts or V/Q, leading to be of immense help for the physician in decision making, also in diagnosis. Because of it describes the ventilatory function, it can predict severe cases of respiratory insufficiency despite some signs and symptoms are normal, or even if the PaO2/Fio2 index is normal.

Objectives: The aim of this study is to evaluate the D (A-a)O2 to determine respiratory insufficiency in comparison to the PaO2/Fio2.

Methods: Retrospective, in patients admitted at Hospital Angeles Lomas in México between March 2022 to March 2023. We retrospectively recollected clinical and arterial blood gas analyses at the admission. Respiratory insufficiency was defined by clinical and symptoms correlated and with the PaO2/Fio2. All the patients were divided in two groups, with respiratory insufficiency and no respiratory insufficiency.

Results: Overall, 60 patients were included in this study. Of these patients 41 (64%) were male and 19 (29.7) were female. 41 patients (68.33%) had respiratory insufficiency and hypoxemia, of this 90% reported dyspnea and only 6 (9.4%) were reported of COPD as respiratory comorbidity. Lineal regression showed that patients with respiratory insufficiency and hypoxemia were significantly more likely to be diagnosed or detected with D (A-a)O2 than PaO2/Fio2 (Pvalue 0.001 and 0.663 respectively).

Conclusions: Hypoxemia and respiratory insufficiency are one of the main pathologies in ICU admissions. To be accurate we can measure with several devices, but not all of this are very accurate. Alveolar-arterial oxygen gradient D (A-a)O2 is more useful than PaO2/Fio2 to identify a patient with respiratory insufficiency and hypoxemia and even can be useful to predict need of icu admission and predict the outcomes and mortality.

References

1. Mellemegaard K. The alveolar-arterial oxygen difference: its size and components in normal man. *Acta Physiol Scand* 1966; 67: 10–20. <https://doi.org/10.1111/j.1748-1716.1966.tb03281>
2. Moammar MQ, Azam HM, Blamoun AI, et al. Alveolar-arterial oxygen gradient, pneumonia severity index and outcomes in patients hospitalised with community acquired pneumonia. *Clin Exp Pharmacol Physiol* 2008; 35: 1032–1037
3. Helmholtz HF, Jr. The abbreviated alveolar air equation. *Chest* 1979; 75: 748. <https://doi.org/10.1378/chest.75.6.748>
4. Shin JB, Lee WJ, Park JH, Choi SP, Jung SK, Woo SH. The Prognostic Value of Alveolar-arterial Oxygen Gradient for Community-Acquired Pneumonia in the ED. *J Korean Soc Emerg Med*. 2013;24 (5):571–8
5. Tobin M. J. (2020). Basing Respiratory Management of Coronavirus on Physiological Principles. *American Journal of Respiratory and Critical Care Medicine*. <https://doi.org/10.1164/rccm.202004-1076ed>
6. Damiani, E; Adrario, E; Girardis, M; Romano, R; Peliaia, P; Singer, M; Donati, A. Arterial hyperoxia and mortality in critically ill patients: A systematic review and meta-analysis. *Crit. Care* 2014, 18, 711.
7. Harris DE, Massie M. Role of alveolar-arterial gradient in partial pressure of oxygen and PaO2/fraction of inspired oxygen ratio measurements in assessment of pulmonary dysfunction. *AANA J*. 2019;87 (3):214–21.
8. Prediletto, I; D'Antoni, L; Carbonara, P; Daniele, F; Dongilli, R; Flore, R; Pacilli, A.M.G.; Pisani, L; Tomsa, C.; Vega, M.L.; et al. Standardizing PaO2 for PaCO2 in P/F ratio predicts in-hospital mortality in acute respiratory failure due to COVID-19: A pilot prospective study. *Eur. J. Intern. Med*. 2021, 92, 48–54
9. Lopez Saubidet Et al. Mortalidad En el SDRA. Elsevier. España, S.L.U. y SEMICYUC Med Intensiva. 2016; 40 (6):356–363.

10. 1 ARDS Definition of Task Force; Ranieri, V.M.; Rubenfeld, G.D.; Thompson, B.T.; Ferguson, N.D.; Caldwell, E.; Fan, E.; Camporota, L.; Slutsky, A.S. Acute Respiratory Distress Syndrome: The Berlin Definition. *JAMA* 2012, 307, 2526–2533.

Topic: Acute respiratory failure and mechanical ventilation

001315

PKpopLCR study: Pharmacokinetic and pharmacodynamic of Linezolid in neurointensive care patients with external ventricular drainage

A. Chauzy¹, F. Bernard², N. Grégoire¹, H. Mirfendereski¹, N. Imzi², S. Marchand¹, C. Dahyot-Fizelier¹

¹U1070 Pharmacologie Des Agents Anti Infectieux et antibiorésistance, Inserm, Poitiers, France; ²Service d'anesthésie médecine périopératoire, Poitiers University Hospital, Poitiers, France

Correspondence: F. Bernard

Intensive Care Medicine Experimental 2023, **11 (Suppl 1):**001315

Introduction: Nosocomial central nervous system (CNS) infections require rapid effective antimicrobial therapy. Reaching appropriate concentrations in CNS remains challenging because of blood-brain barrier and cerebrospinal fluid (CSF) turnover. The main goal of this multicenter prospective study was to explore PK/PD of Linezolid (LNZ) in CSF and efficacy of current dosing regimens in CNS infections.

Methods: Twenty five patients with external ventricular drainage (EVD) treated with LNZ by 600 mg every 12 h (two doses (2D), n = 17) or 8 h (three doses (3D), n = 8), for a CNS or other site infection. Blood and CSF samples were collected after steady-state (3–5 days), at predetermined sampling times. LNZ plasma data were first modelled by a population pharmacokinetic analysis. Thereafter, plasma parameters estimated and corrected for protein binding of 31% were fixed to fit unbound CSF concentrations. In the final model, parameters for both plasma and CSF data were simultaneously estimated. Then, Monte Carlo simulations were conducted to determine the probability of target attainment (PTA) and the cumulative fraction of response (CFR) in CSF of current dosing regimens against methicillin-resistant *Staphylococcus aureus* (MRSA) and methicillin-resistant *Staphylococcus epidermidis* (MRSE)[1].

Results: A two-compartment (one for plasma and one for CSF) linear model was found to be the most appropriate. LNZ was widely distributed into the CSF with a mean ratio of AUC_{CSF}/AUC_{plasma} of 90% for unbound concentrations. No difference in the penetration of LNZ into the CSF was observed between patients with and without meningitis. PTAs (AUC/MIC > 100) were greater than 90% only for MICs ≤ 0.5 mg/L after administration of

the standard dosing regimens, suggesting no efficacy against MRSA and MRSE infections (CFR ≤ 13% and 70%, respectively).

Conclusions: Our results confirmed that 100% of unbound form of LNZ diffuse in CSF at steady-state [2–4], which could allow a plasma therapeutic drug monitoring to estimate the free concentration of LNZ in CSF to adapt treatments. However, according to our results, none of the studied dosing regimens reached widely the PKPD target. For the usual dosing regimen, linezolid CSF concentrations seem insufficient to treat MRSA and MRSE with MICs upper than 0,25 mg/L in ICU patients with CNS infections.

PTA (AUC/MIC > 100) and CFR of linezolid in CSF fo

Daily dose	1 200 mg	1 800 mg
MIC (mg/L)	PTA (%)	
0,125	100	100
0,25	99.6	100
0,5	88.6	98.0
1	41.1	73.0
2	4.8	20.4
4	0.1	1.2
8	0	0.01
16	0	0
Species	CFR (%)	
MRSA	3.2	12.6
MRSE	40.6	70.4

PTA, probability of target attainment; CFR, cumulative fraction of response; MIC, minimum inhibitory concentration

PTA (AUC/MIC > 100) and CFR of Linezolid in CSF.

References

- [4] Luque S. *Int J Antimicrob Agents* 2104;44:409–15.
- [2] Myrianthefs P. *Antimicrob Agents Chemother* 2006;50:3971–6.
- [1] EUCAST breakpoint Tables for interpretation of MICs and zone diameters. <http://www.eucast.org>.
- [3] Beer R. *Antimicrob Agents Chemother* 2007;51:379–82.
- Grants from the SFAR, national PHRC. Thanks to research and clinical teams of collaborating centers and to members of INSERM U1070.

Topic: Neurointensive care

001316

Bedside Ultrasonography prior to percutaneous dilatational tracheostomy in ICU adult patients

P. Fernandez¹, N. Pavez¹, J. Lastra¹, J. Hermosilla², P. Sánchez², J. Faúndez¹, J. Casanova¹, D. Clemo³, L. Ferreira²

¹Departamento de medicina interna, Universidad de Concepcion, Concepcion, Chile; ²Servicio Unidad Paciente Crítico, Regional Clinical Hospital of Concepción, Concepción, Chile; ³Servicio Radiología, Regional Clinical Hospital of Concepción, Concepción, Chile

Correspondence: P. Fernandez

Intensive Care Medicine Experimental 2023, **11 (Suppl 1):**001316

Introduction: Percutaneous tracheostomy (PT) is a widely performed procedure in intensive care units (ICUs). The use of ultrasound (US) prior to tracheostomy is described as a tool that can minimize some of the potential complications of this procedure. There are scant reports in the literature regarding the description of the technique. We present the ultrasound protocol of our unit, performed by intensivists as well as the findings of anatomical alterations encountered.

Methods: Retrospective descriptive study. Neck ultrasounds performed prior to PT were evaluated between July 2010 and March 2023 in the ICU of Hospital Regional Concepción, Chile. The USs were performed bedside by an intensivist in all patients in which the requirement for PT was defined. The indication for PT was made according to local protocols and adjusted to clinical guidelines. The technique includes a review of airway characteristics, venous and arterial vessels, and masses. Specific search for vascular alterations or masses on the path of puncture, presence of goiter and presence of masses or nodes and deviations of the trachea (Figure 1). According to the findings, ultrasounds were classified into three groups: (1) Neck US suitable for standard PT technique (2) Neck US suitable for PT with precautions (3) Neck US contraindicates PT (Fig. 2). Findings that contraindicated PT were arterial structure, large caliber venous structure or mass on the puncture path and major tracheal deviation.

Results: During the study period, 820 ultrasound evaluations for PT were performed. They were distributed as follows: 782 patients (95.37%) group 1, 26 (3.17%) group 2, 12 (1.46%) group 3. The main findings were vascular (19), followed by masses (13) and deviations of the trachea (6). In group 2, alterations were 10 veins and 2 arteries between the trachea and the skin but lateral to the puncture path; 5 peritracheal adenopathies; 5 minor tracheal deviations (3 due to adenopathy, 1 post-surgical retraction, 1 unknown cause) and 4 goiters. In group 3, the alterations were 3 elongations of the brachiocephalic trunk, 3 large caliber arteries and 1 vein in the puncture path; 3 masses on the puncture path; 1 major tracheal deviation; 1 multinodular goiter. The PTs performed in group 2 had no immediate or ICU-stay complications. Of the PTs group 3, 10 were successfully performed surgically. The remaining 2 cases corresponded to brachycephalic trunk elongation and aberrant artery with a larger caliber in the tracheostomy region. After evaluation by otorhinolaryngology with secondary image, it was decided to maintain the orotracheal tube until extubation. The group of all altered USs (2 and 3) had no special characterization in age, sex, or external anatomical features of the neck.

Conclusions: The presented method for screening altered structures using ultrasound prior to percutaneous tracheostomy, is simple to perform, reproducible, and identifies important alterations that can condition severe complications of this procedure.

Ultrasound protocol prior to percutaneous tracheostomy
1. Hyperextension neck position
2. Linear transducer 7-12 Hz
3. Trachea review: location relative to the midline, transverse diameter measurement, distance from the skin, visualization of tracheal rings.
4. Blood vessels review: visualization of anatomical vessel trajectory, Doppler for the puncture trajectory, ruling out brachiocephalic trunk elongation.
5. Masses review: thyroid (goiter, masses), masses in the puncture trajectory, or lateral masses that alter the trachea trajectory.

Figure 1 (abstract 001316) Neck ultrasound protocol performed on patients with percutaneous tracheostomy indication prior to the procedure

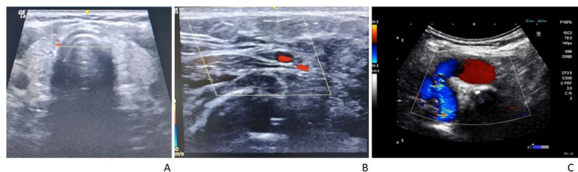

Figure 2 (abstract 001316) Examples of ultrasound (US) prior to percutaneous tracheostomy (PT). A: Neck US suitable for standard PT technique. B: Neck US suitable for PT with precaution. C: Neck US contraindicates PT.

References

1. Flint, A.C., Midde, R., Rao, V.A. et al. Bedside Ultrasound Screening for Pretracheal Vascular Structures May Minimize the Risks of Percutaneous Dilatational Tracheostomy. *Neurocrit Care* 11, 372–376 (2009)
2. FA Mir, P Hopkins, C Holland, R Ramnarine, MYS Wan. The use of ultrasound imaging prior to percutaneous tracheostomy. Volume 13, Number 1, January 2012 JICS
3. aumber R, Cohen A, Neck ultrasound prior to percutaneous tracheostomy: should this now be a standard of practice?. Volume 12, Number 4, October 2011 JICS
4. Rees J, Haroon Y, Hogan C, Saha S, Derekshani S. The ultrasound neck imaging for tracheostomy study: A study prompting ultrasound screening prior to percutaneous tracheostomy procedures to improve patient outcomes. *J Intensive Care Soc.* 2018 May;19 (2):107–113.
5. Royal College of Anaesthetists. 4th National Audit Project: Major Complications of Airway Management in the UK. London: RCoA, 2011.
6. Muhammad JK, Major E, Wood A, et al. Percutaneous dilatational tracheostomy: haemorrhagic complications and the vascular anatomy of the anterior neck. A review based on 497 cases. *Int J Oral Maxillofac Surg* 2000; 29: 217–222

Topic: Acute respiratory failure and mechanical ventilation

001317

Safety of a novel homogenous recombinant haemoglobin

M. J. Melis¹, B. J. Reeder², M. Simons², K. Alotaibi¹, M. T. Wilson², C. Cooper², A. Dyson³, M. Singer¹

¹Bloomsbury Institute of Intensive Care Medicine, University College London, London, United Kingdom; ²School of Life Sciences, University of Essex, Essex, United Kingdom; ³Centre for Pharmaceutical Medicine Research, King's College London, London, United Kingdom

Correspondence: M.J. Melis

Intensive Care Medicine Experimental 2023, **11 (Suppl 1)**:001317

Introduction: Apart from their oxygen-carrying capacity, synthetic haemoglobin-based oxygen carriers (HBOCs) can also scavenge reactive oxygen species (ROS). They may therefore play a useful role in mitigating reperfusion injury following resuscitation from hypoxic insults

in addition to providing an alternative to blood transfusions. HBOCs typically scavenge nitric oxide (NO), elevating blood pressure. While higher doses result in adverse outcomes related to excessive vasoconstriction (1), low doses that only marginally raise Hb levels and novel recombination techniques may be both safe and efficacious.

Objectives: To examine the safety profile of a novel, genetically engineered, recombinant and homogenously PEGylated HBOC given at low dose to instrumented healthy rats.

Methods: Under brief anaesthesia, healthy male Wistar rats ($n=12$, approx. weight 300 g) underwent tunnelled central venous and carotid artery access. The lines were connected to a tether system that enabled free movement and access to food and water in their cages upon recovery. The animals were then randomised to receive either an intravenous bolus of HBOC (8.33 mL/kg) or Ringer's Lactate (RL). At pre-specified timepoints, blood pressure and temperature were recorded, and blood samples taken for blood gas analysis, organ function (troponin, creatinine, urea, bilirubin, albumin, ALT, CK and triglycerides), and inflammatory markers (IL-6, IL-10, C3a and C5a). Echocardiography was performed at baseline and at study end (24 h) under anaesthesia.

Results: The novel recombinant HBOC was well tolerated by the rats with no change in behaviour or appearance. No significant differences were found in lactate, acid–base balance, oxygenation variables and electrolytes. Cardiorespiratory function, temperature, weight, and markers of inflammation and organ function markers were similar at study end for both groups. The only exceptions were an increase in aortic blood flow peak velocity ($P=0.047$) and a clinically insignificant rise in creatinine ($P=0.04$) in HBOC treated rats (Figure 1). The engineered mutations of the current HBOC, targeting promotion of oxidative reactions and NO scavenging, did result in no impact on the blood pressure.

Conclusions: An intravenous bolus of our novel recombinant homogenously PEGylated HBOC did not result in any of the toxicity effects previously reported with higher doses of other HBOCs. We are now progressing to studies assessing its impact on ischaemia–reperfusion injury.

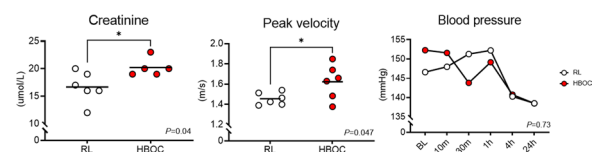

Figure 1 (abstract 001317) Creatinine, peak velocity, and blood pressure. RL: Ringer's Lactate; HBOC: Haemoglobin-Based Oxygen Carrier; BL: Baseline; h: hour; m: minute. All times stated for blood pressure are from the onset of i.v. drug infusion. Peak velocity and creatinine were performed at 24 h. * $P < 0.05$

References

1. Natanson C et al. Cell-free hemoglobin-based blood substitutes and risk of myocardial infarction and death: a meta-analysis. *JAMA* 2008; 299:2304–12.
2. UK Medical Research Council Biomedical Catalyst grant: MR/T025411/1

Topic: Translational Medicine

001321

Risk factors for reduced protein intake in severe ARDS

E. Gerovasileiou¹, L. Giannakou¹, S. Giannopoulos¹, V. Tsolaki¹, K. Deskata¹, M. E. Papadonta¹, D. Makris¹

¹Intensive care unit, University Hospital of Larissa, Larissa, Greece

Correspondence: E. Gerovasileiou

Intensive Care Medicine Experimental 2023, **11 (Suppl 1)**:001321

Introduction: Medical nutrition in the Intensive Care Unit (ICU) needs to be tailored to meet patients' needs. It is not well established whether patients with SARS-Cov2 Acute Respiratory Distress Syndrome (ARDS) present differences compared to other ARDS patients in terms of calories – protein intake.

Objectives: We aimed to assess current clinical practices in terms of delivering protein support in critically ill patients with respiratory failure due to SARS-Cov2 or other severe ARDS etiologies.

Methods: We prospectively included mechanically ventilated patients due to SARS-Cov2 ARDS (ARDS_{Scov}) or ARDS of other etiologies (ARDS_{Sot}) who were hospitalized in the ICU of a tertiary hospital during the SARS-Cov2 pandemic period (2020–2021). The primary outcome of the study was the protein-intake/protein calculated demand ratio (pi/pc); this ratio was defined as the daily protein intake to daily caloric demands calculated by the European Society for Clinical Nutrition and Metabolism (ESPEN) formula.

Results: A total of 150 patients were included; 75 patients with severe ARDS_{Scov} and 75 with severe ARDS_{Sot}. The median (IQR) pi/pc was significantly lower ($p=0.04$) in the ARDS_{Scov} group 0.423 (0.33;0.52), compared to ARDS_{Sot} (0.597, 0.40;0.79). Serum albumin values (mg/dl) measured on the first ICU day of were similar between the two groups (3.03, 2.9;3.1 vs 3.0, 2.8;3.2). Serum albumin (mg/dl) was significantly lower in ARDS_{Scov} patient group on the seventh ICU day (2.54, 2.4;2.6 vs 2.79, 2.6;2.9 respectively, $p=0.01$). ARDS_{Scov} patients reached 42.43% (35.5;49.37) of the ESPEN recommended target compared to ARDS_{Sot} patients who reached on average 64.92% (51.9;77.94) ($p=0.001$). In ARDS_{Scov} group, the pi/pc correlated significantly with the number of regurgitation episodes during ICU hospitalization ($r=0.30$, $p=0.02$).

Conclusions: This study shows that accomplishing recommended by ESPEN targets among patients with COVID-19 may be challenging. A specific strategy of nutritional intervention in SARS-Cov2 ARDS patients may be helpful to improve outcomes.

Topic: Metabolism, endocrinology, liver failure and nutrition

001322

Status of medical institutions treating severe COVID-19 patients in Japan

K. Sakaguchi¹, R. Yokoyama¹, S. Saito¹, M. Takada¹, K. Takahashi¹, M. Watanabe¹, T. Kobayashi¹, M. Nakane¹

¹Department of Emergency and Critical Care Medicine, Yamagata University Faculty of Medicine, Yamagata, Japan

Correspondence: K. Sakaguchi

Intensive Care Medicine Experimental 2023, **11** (Suppl 1):001322

Introduction: In infectious disease pandemics such as coronavirus disease 2019 (COVID-19), the number of severely ill patients requiring intensive care increases rapidly, and there is concern that the standard health care delivery system cannot provide the necessary medical care. Therefore, a flexible system must be established to prepare for a pandemic even in non-pandemic times. With centralization of the health care delivery system, which has been an issue in Japan, hospitals may be able to provide more advanced medical care; on the other hand, with the increased number of patients due to a pandemic, it may not be possible to treat all patients. Not only intensive care physicians but also various specialists in intensive care units need to conduct medical procedures such as mechanical ventilation and extracorporeal membrane oxygenation (ECMO) for severely ill patients. Thus, during the COVID-19 pandemic, severe cases had to be treated at nearby or family medical institutions that do not ordinarily handle severely ill patients.

Objectives: To examine the severe infectious disease medical system during a future pandemic, an analysis of the trends in the health care delivery system for severe COVID-19 patients in Japan was conducted.

Methods: We analyzed data published by the Japanese government from January 2021 to February 2023. The number of hospitalized COVID-19 patients in all hospitals in Japan was collected using mainly the Gathering Medical Information System (G-MIS), and the number of positive COVID-19 cases in all medical facilities in Japan was collected by a law using mainly the Health Center Real-time Information-sharing System on COVID-19 (HER-SYS). We used the values obtained on the last Wednesday of each month.

We analyzed the relationship between the number of hospitalized COVID-19 patients and the number of hospitals that handle hospitalization of COVID-19 patients.

Results: The median total number of positive COVID-19 cases per day was 24,125 (interquartile range: 3,116–73,258), total number of hospitalized COVID-19 patients on ECMO or ventilators (HE) was 259 (93–387), and number of hospitals with HE was 129 (64–173). The total number of HEs showed a strong positive correlation with the number of hospitals with HE (correlation coefficient: 0.958 (95% confidence interval: 0.905–0.981), $p<0.001$). Regarding the total number of HEs in each hospital, the proportion of hospitals with 1–4 HEs was negatively correlated (-0.935 (-0.971 to -0.857), $p<0.001$), and the proportion with ≥ 5 HEs positively correlated, with the total number of HEs (0.935 (0.857–0.971), $p<0.001$).

Conclusions: As the number of patients with severe COVID-19 increases, the number of hospitals providing care for such patients is also increasing. Our results suggest that the number of severe cases during a pandemic did not exceed the number of patients that can be handled at hospitals in Japan, which may be because a sufficient health care delivery system was in place.

References

1. None

Topic: Critical care organisation, quality management, information systems, outcomes

001324

Alterations in regional brain microcirculation in patients with sepsis: a prospective study using contrast-enhanced brain ultrasound

D. N. Nguyen¹, L. Huyghens², T. M. Nguyen³, M. Diltor⁴, J. Jonckheer⁵, J.L. Vincent⁶

¹ICU, UZ Brussel, Jette, Belgium; ²Cerebral Resuscitation Group, VUB Jette, Jette, Belgium; ³Cardiology, UCLouvain Brussels Woluwe, Woluwe-Saint-Lambert, Belgium; ⁴Intensive care unit, UZ Brussel, Jette, Belgium; ⁵Intensive care, UZ Brussel, Jette, Belgium; ⁶Soins intensif, ULB Erasme, Brussels, Belgium

Correspondence: D.N. Nguyen

Intensive Care Medicine Experimental 2023, **11** (Suppl 1):001324

Introduction: Alterations in brain microcirculatory (BMC) in patients with sepsis and septic shock have not been well studied. The phenomenon could be studied by Using enhanced-contrast brain ultrasound (CEUS) with microbubble contrast administration., we prospectively investigated the clinical impact of brain microcirculation (BMC) alterations in patients with sepsis and septic shock.

Objectives: We studied (a) If CEUS could detect BMC alterations in sepsis (b) If these alterations are associated with alterations in global brain perfusion and cerebral autoregulation disturbance? (c) If these alterations are associated with cerebral complications and worse outcome?

Methods: For three days, mean arterial pressure, cardiac index (by transthoracic echocardiography), cerebral blood flow (by echo-color duplex of the carotid and vertebral arteries), brain autoregulation and the mean flow velocities of the middle cerebral arteries (by transcranial echo-color doppler) were simultaneously evaluated in 58 patients with sepsis. CEUS assessed BMC alterations with the changes of the time-intensity perfusion curves variables (including time-to-peak and

peak-intensity) in different regions of interest of brain parenchyma. Brain injury was confirmed on computed tomography or magnetic resonance imaging. Coma and delirium were evaluated using the Glasgow Coma Scale or the Confusion Assessment method in the ICU, respectively.

Results: There was no difference between survivors and non-survivors in cardiac index, mean arterial pressure, cerebral blood flow and the mean flow velocities of the middle cerebral arteries over three days. The non-survivors developed more BMC alterations with prolonged time-to-peak ($p < 0.01$) and decreased peak-intensity ($p < 0.01$) in the left lentiform nucleus and left white matter of the temporo-parietal region of the middle cerebral artery. Non-survivors also developed more frequently coma, delirium in the ICU and had more frequently impaired brain autoregulation and signs of brain injury on imaging than survivors (all $p < 0.01$).

Conclusions: In patients with sepsis, non-survivors developed more brain complications than survivors, and this was associated with more severe microvascular alterations in the brain.

Figure 1: Ultrasound techniques to evaluate brain perfusion in patients with sepsis

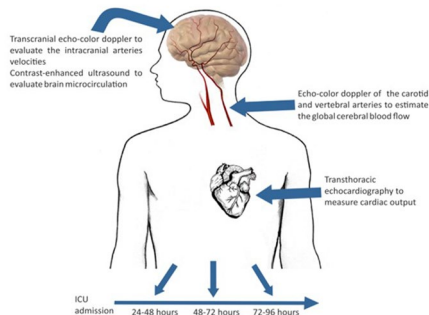
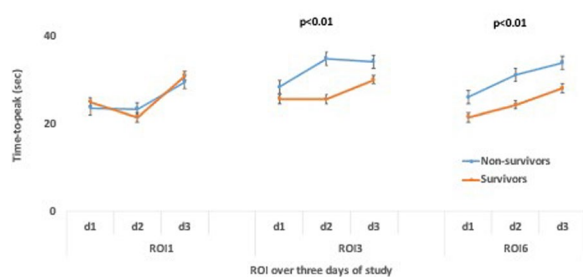

Figure 2: Time-to-peak (seconds) evolution of three regions of interest of brain parenchyma of the left side between nonsurvivors and survivors.



References

- Taccone FS, Su F, Pierracos C, Jarnes S, Dewitte O, Vincetn JL, De Backer D. Cerebral microcirculation is impaired during sepsis: an experimental study. *Crit Care* 2010; 14: R140
- Tokuda R, Nakamura K, Takatani Y, Tanaka C, Kondo Y. Sepsis-associated delirium; a narrative review. *J Clin Med* 2023; 12: 1273.
- Sharshar T, Polito A, Checinski A, Stevens RD. Septic-associated encephalopathy—everything starts at a microlevel. *Crit Care* 2010; 14:99
- Taccone F, Scolletta S, Franchi F, Donadello K, Oddo M. Brain perfusion in sepsis. *Curr vascul Pharmacol* 2013; 11: 170–186.
- Thanks to miss Marie-Claire Van Malderen for her assistance
- Vincke EJ, Kortenbout AJ, Eyding J, Slump CH, Van Der Hoeven JG. Potential of contrast-enhanced ultrasound as a bedside monitoring technique in

cerebral perfusion: a systematic review. *Ultrasound Med Biol* 2017; 12: 2751–57.

Topic: Neurointensive care

001325

Browning-induced thermogenesis in white adipose tissue does not occur or cause hypermetabolism and muscle wasting in survivors of experimental sepsis

J. Harris¹, R. Tidswell¹, A. Alqallaf², J. Falconer¹, P. Golfaroush³, A. Palo², K. Patel², M. Duchon⁴, M. Singer⁵

¹Experimental and Translational Medicine, University College London, London, United Kingdom; ²School of Biological Sciences, University of Reading, Reading, UK, Reading, United Kingdom; ³Institute of Cardiovascular Science, University College London, London, United Kingdom; ⁴Cell & Developmental Biology, University College London, London, United Kingdom; ⁵Bloomsbury Institute of Intensive Care Medicine, University College London, London, United Kingdom

Correspondence: R. Tidswell

Intensive Care Medicine Experimental 2023, **11** (Suppl 1):001325

Introduction: Introduction—Sepsis is defined as the dysregulated host response to infection resulting in organ dysfunction and, in some cases, death. Survivors frequently develop cachexia and myopathy which impairs recovery and increases long term mortality. In conditions akin to sepsis, including burn injury and cancer-associated cachexia, this has been attributed to catabolism driven by hypermetabolism due to a process called ‘browning’. Browning describes the switch of energy-storing white adipose tissue to a thermogenic energy-burning brown adipose tissue-like phenotype. Browning is characterised by increased mitochondrial density, multiloculation of lipid droplets and expression of thermogenic mechanisms including the canonical marker of browning—uncoupling protein 1, aka ‘thermogenin’. Identification and prevention of browning may reduce muscle wasting in survivors of sepsis.

Objectives: Establish whether browning of white adipose tissue occurs and drives hypermetabolism and muscle wasting in survivors of an animal model of sepsis.

Methods: Experimental sepsis was induced in rats using intraperitoneal zymosan which causes a prolonged inflammatory insult. Immunofluorescence and body and muscle mass were used to identify cachexia and myopathy. Expression of thermogenic browning mechanisms were studied in epididymal (eWAT) and retroperitoneal adipose tissue and (rpWAT) using thermal imaging, high resolution respirometry, RNA-sequencing and Western blot. Mitochondrial function and adipose tissue architecture was interrogated by multiphoton imaging of live adipose tissue explants.

Results: Rats with zymosan peritonitis developed a sepsis-like illness with a mortality of 17% at 14 days. Compared to sham animals, sepsis survivors developed hypermetabolism, cachexia and myopathy with reduced muscle mass and myofibre thickness. Oxygen consumption of eWAT and rpWAT per milligram of tissue was elevated at days 3, 7 and 14 of sepsis recovery, however, when controlled for lipid droplet size or mitochondrial or cell number, the increase was abolished. Compared to sham, RNA sequencing of rpWAT showed inflammation and down regulation of genes related to oxidative phosphorylation and thermogenesis at 14 days after septic insult. UCP1 protein was not expressed. Notably, SERCA2 mRNA and SERCA2 protein were increased, suggesting increased calcium cycling. Multiphoton microscopy showed neither increased mitochondrial density nor lipid multiloculation consistent with browning. The NAD (P)H pool was, however, more oxidised in tissue from animals recovering from sepsis, potentially indicating increased or altered metabolism.

Conclusions: Hypermetabolism, cachexia and myopathy in the recovery phase of experimental sepsis are not caused by classical browning. Calcium cycling mechanisms in adipose tissue may be implicated. The findings are counter to many established studies and merit further investigation.

References

1. Funded by Medical Research Council

Topic: Sepsis

001326

A new endotracheal tube cuff controller promoting tracheal secretion clearance

L. Vivona¹, A. Zanella², F. Madotto¹, E. Carlesso², G. Florio¹, S. E. Rees³, D.S. Karbing³, F. Sodi¹, G. Caddeo⁴, S. Tammaro⁴, M. Panigada¹, A. Pesenti¹, G. Grasselli²

¹Department of Anesthesia, Critical Care and Emergency, Fondazione IRCCS Ca' Granda Ospedale Maggiore Policlinico, Milan, Italy;

²Department of Pathophysiology and Transplantation, Università degli Studi di Milano, Milan, Italy; ³Department of Health Science and Technology, Aalborg University, Aalborg, Denmark; ⁴Direzione Aziendale Professioni Sanitarie, Fondazione IRCCS Ca' Granda Ospedale Maggiore Policlinico, Milan, Italy

Correspondence: L. Vivona

Intensive Care Medicine Experimental 2023, **11 (Suppl 1)**:001326

Introduction: Patients undergoing invasive mechanical ventilation (MV) accumulate tracheal secretions below and above the endotracheal tube (ETT) cuff. Tracheal suctioning is required to prevent complications due to secretion retention, but such a procedure is not free from risks. To promote secretion clearance, a new cuff controller device has been recently developed [1]. The cuff controller, synchronized with the mechanical ventilator, performs an artificial cough maneuver with a fast cuff deflation/inflation cycle within the inspiratory time, thus generating a gas flow around the ETT cuff towards the mouth (artificial cough flow).

Objectives: To assess safety and efficacy of the device in promoting secretion clearance.

Methods: The study was approved by the local Ethical Committee. Adult subjects, admitted to general intensive care unit and undergoing invasive MV, were enrolled. At enrollment, a first deep mouth aspiration was performed and the device was connected to the ETT cuff, target pressure 25 cmH₂O. A sigh (total inspiratory pressure 35 cmH₂O, inspiratory time 2 s, once per minute) was introduced in the ventilatory settings for device activation. The ETT cuff deflation/inflation cycle lasted around 1.2 s. The artificial cough maneuver was consecutively performed 3 times and then a second mouth aspiration was performed in order to assess the primary outcome, represented by the presence or absence of oral secretions (Responders and Non-Responders, respectively). Safety was evaluated as the presence of adverse events during each maneuver. Study population was described according to clinical and demographic characteristics assessed at enrollment. For each maneuver, artificial cough flow was estimated as the leaked volume (residual volume at end-expiration measured by the ventilator) divided by 1.2 s.

Results: We enrolled 30 patients (66.7% males, mean age 60.1 ± 18.5 years, mean body mass index 26.0 ± 7.2) and half of them undergoing controlled ventilation. Device activation was feasible for all patients and two adverse events were recorded (reactive cough and transient hypotension resolved with volume infusion). For two patients, the primary outcome was not evaluated due to logistical issues. The second mouth aspiration detected secretions in 22 patients (Responders 78.6% of 28). Demographical and clinical characteristics did not statistically differ between Responders and Non-Responders. Prevalence of Responders did not differ according to the ventilation mode ($p=0.6483$). Artificial cough maneuvers produced a mean cough flow of 17.9 ± 10.4 L/min and no statistical difference between mean cough flow was detected between Responders and Non-Responders ($p=0.8011$) (Figure 1).

Conclusions: Our study showed that the tested ETT cuff controller was safe and feasible and it was able to promote tracheal secretion transfer to the mouth.

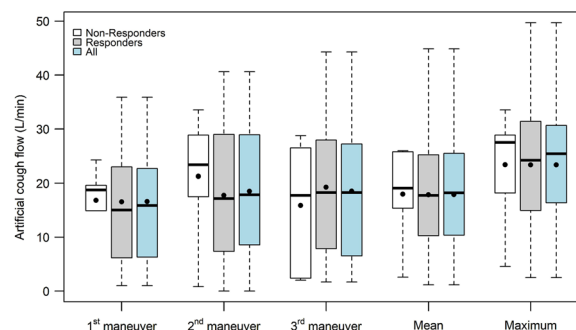

Figure 1 (abstract 001326) Boxplot of artificial cough flows during device activation

Figure shows the distribution of artificial cough flow observed during each maneuver (1st, 2nd and 3rd maneuver) and the distribution of mean and maximum value observed among the three maneuvers.

References

1. Zanella A, Florio G, Rezoagli E, Pastore M, Cadringer P, Biancolilli O, Carlesso E, Scaravilli V, Ristagno G, Pesenti AM. An artificial cough maneuver to remove secretions from below the endotracheal tube cuff. *Respir Care*. 2019;64 (4):372–383
2. Device and consumer products were provided free of charge by AW Technologies ApS, Denmark.

Topic: Acute respiratory failure and mechanical ventilation

001328

Effect of Non-invasive Respiratory Strategies on Intubation Rate in Patients with Hypoxemic Respiratory Failure with COVID-19: A Target Trial Emulation

C. Reep¹, L. Fleuren², E. J. Wils³, L. Heunks¹

¹Intensive Care, Erasmus University Medical Center, Rotterdam, Netherlands; ²Intensive care adults, Amsterdam UMC, locatie VUmc, Amsterdam, Netherlands; ³Intensive care, Franciscus Gasthuis, Rotterdam, Netherlands

Correspondence: C. Reep

Intensive Care Medicine Experimental 2023, **11 (Suppl 1)**:001328

Introduction: Non-invasive respiratory support, such as high flow nasal oxygen (HFNO) or non-invasive ventilation (NIV), have the potential to reduce the risk of invasive mechanical ventilation in hypoxemic patients with COVID-19. However, randomized clinical trials demonstrate conflicting results, the number of included patients is limited, and real-world practice data remain scarce.

Objectives: To determine whether an approach that includes HFNO or NIV is superior to conventional oxygen therapy (COT) in reducing the risk of invasive mechanical ventilation in hospitalized hypoxemic patients with COVID-19.

Methods: We emulated a target trial using the National COVID Cohort Collaborative data on COVID-19 patients [1]. We included adult hypoxemic patients (P/F ratio ≤ 200 mmHg) within their first 24 h of hospital admission with a SARS-CoV-2 infection. Pregnant patients, patients with hypercapnia (PaCO₂ > 45 mmHg), or a do not resuscitate order were excluded. We compared three treatment arms: HFNO, NIV, and a control group with only COT, started within a grace period of six hours after meeting the eligibility criteria. The primary outcome was intubation within 28 days. We censored patients if they had a hospital transfer or an unknown hospital discharge destination. Subgroups were based on BMI, respiratory rate, P/F ratio, and PaCO₂. We used the

inverse probability censored weighted (IPCW) Aalen-Johansen estimator to estimate the 28-day cumulative incidence of intubation for the three arms.

Results: Of the almost 5 million patients admitted to the hospital with COVID-19, 10,894 met the eligibility criteria, of which 1,274 initiated HFNO, 641 initiated NIV, and 8,655 did not start HFNO/NIV within the grace period. The unadjusted cumulative 28-day risk of intubation was 48% in the HFNO arm, 57% in the NIV arm, and 24% in the COT arm. With an initial, albeit still incomplete, adjustment, the 28-day risk of intubation was 38% for the HFNO arm, 51% for the NIV arm, and 20% for the COT arm. These correspond to risk differences of 18% (HFNO vs COT), -13% (HFNO vs NIV), 31% (NIV vs COT). The restricted (at day 28) mean time to intubation was 7 days for HFNO, 12 days for NIV, and 3 days for COT. Results will be bootstrapped for reliable confidence intervals and analysed for the subgroups.

Conclusions: We observe a trend among hypoxemic patients with COVID-19 that NIV as initial treatment increases 28-day cumulative incidence of intubation compared to HFNO or COT.

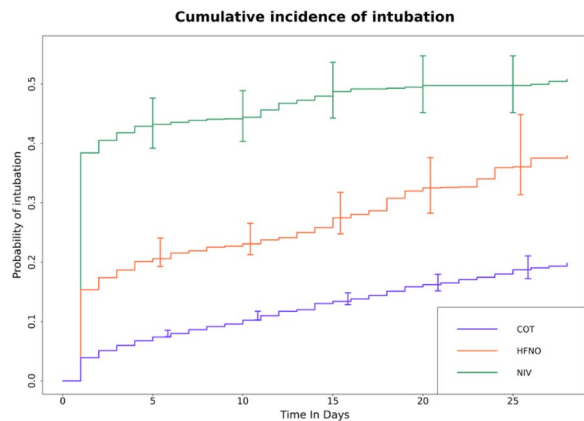
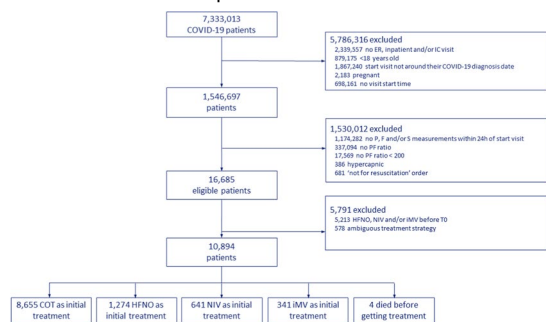

References

- [1] Haendel, Melissa A et al. "The National COVID Cohort Collaborative (N3C): Rationale, design, infrastructure, and deployment." *Journal of the American Medical Informatics Association: JAMIA* vol. 28,3 (2021): 427–443. <https://doi.org/10.1093/jamia/ocaa196>

Topic: Acute respiratory failure and mechanical ventilation

001330

A predictive score of mortality for critically ill trauma patients

O. Akaraborworn¹, B. Sangthong¹, K. Thongkhao¹, O. Wongweerakit¹

¹Division of trauma and critical care, department of surgery, Prince of Songkla University, Hat Yai, Songkhla, Thailand

Correspondence: O. Akaraborworn

Intensive Care Medicine Experimental 2023, **11 (Suppl 1)**:001330

Introduction: Trauma is one of the major causes of death worldwide. Severed injured patients will be triaged by the trauma team activation criteria (TTAC) to receive immediate care from a trauma team.

Objectives: This research aimed to identify the mortality rate and predictors for the mortality of patients who met the TTAC.

Methods: This is a retrospective cohort study that collected data from a trauma registry. All patients who arrived at the emergency department and met the TTAC within 1 h after arrival were eligible. The initial vital signs, initial clinical examination, and laboratory results were collected. The univariable analysis was performed and the parameters were selected for multivariable analysis and the predicting score was derived from the coefficients.

Results: A total of 878 patients were eligible for the cohort. The 28-day mortality rate was 15.7%. The multivariable analysis showed that age ≥ 60 years (OR 8.6, 95%CI 4.2–17.5, $p < 0.001$), GCS ≤ 8 (OR 6.0, 95%CI 3.3–11.1, $p < 0.001$), Base excess (BE) ≤ -10 mEq/L (OR 9.6, 95%CI 5.2–17.9, $p < 0.001$). The SAB score comprised of age ≥ 60 years = 1, GCS $\leq 8 = 1$, and BE ≤ -10 mEq/L = 1. At the cut point of 2, the score had a sensitivity, specificity, positive predictive value, and negative predictive value of 52%, 94%, 60%, and 92%, respectively.

Conclusions: The SAB score can be a tool to classify trauma patients who met TTAC into a higher tier for more intensive management.

References

- Lowe CT, Kelly M, Seubsman S, Sleight A. Predictors and burden of injury mortality in the Thai cohort study 2005–2015. *BMC Public Health*. 2020 Nov 16;20 (1):1714. Jongaramrueng N, Tangsiricharoen S. Factors that associated with mortality in trauma patients. *The Journal of Prapokkiao Hospital Clinical Medical Education Center*. 2022 Mar
- This research received funding from Faculty of Medicine, Prince of Songkla University, Thailand.

Topic: Trauma

001331

Utility of outpatient clinic for the diagnosis and treatment of post-intensive care syndrome (PICS)

S. Manrique¹, N. Murillo Moreno², M. Sanchez¹, P. Perelló³, M. C. Gilavert¹,

D. Gil Castillejos¹, V. Blazquez¹, M. Bodi⁴, M. Magret³

¹Medicina Intensiva, Hospital Universitari de Tarragona Joan XXIII, Tarragona, Spain;

²ICU, Hospital Universitari de Tarragona Joan XXIII, Tarragona, Spain;

³Intensive care unit, Hospital Universitari de Tarragona Joan XXIII, Tarragona, Spain;

⁴Uci, Hospital Universitari de Tarragona Joan XXIII, Tarragona, Spain

Correspondence: S. Manrique

Intensive Care Medicine Experimental 2023, **11 (Suppl 1)**:001331

Introduction: PICS is a syndrome that involves the alteration of different spheres such as emotional, physical and neurocognitive. It has been demonstrated that critically ill patients who have been admitted to the ICU have increasingly more risk factors to develop PICS such as delirium, invasive (IMV) and non-invasive mechanical ventilation (NIMV), ARDS, multi organ failure, sepsis, cardiac arrest etc.. Most of these patient are not fully recover a year after they ICU discharge, even after 5 years after ICU discharge. It is important to detect and treat PICS.

Objectives: To analyze the prevalence of PICS and the need for outpatient clinic in its diagnosis and treatment.

Methods: Descriptive observational study conducted in the post-ICU outpatient clinic of a 28-bed polyvalent ICU. Between 04/2021 and 12/2022. Patients who met at least one of the risk factors for developing PICS (IMV or NIMV > 2 days, ARDS, delirium, cardiac arrest with recovery, sepsis, multiorgan failure) were included. Follow-up was conducted at 1,3,6 and 12 months after ICU discharge. The spheres that comprise PICS (physical, psychological and cognitive) were assessed using validated scales (MRC, MOCA, HADS, Barthel, clinical frailty score, SARC-F score SF-12).

Results: 93 patients at risk of developing PICS were followed in the ICU outpatient clinic. Median age was 62 years old (52–70), 74% (69) male, median APACHE of 17 (13–24), median SAPS III of 52 (45–55) and median Barthel of 100. 73% (68) were admitted due to respiratory failure, 63% (59) due to SARS COV 2.

84% (78) developed PICS. The neurocognitive sphere was the most frequently altered (73%), followed by physical sphere (60%) and psychological sphere (18% anxiety and 18% depression) (Figure 1). 40% (37) were affected in two spheres, 28% (26) only one and 17% (16) in all three (Fig. 2). The most frequent combination was neurocognitive and physical impairment (30%), followed by only neurocognitive impairment (21%) and impairment in all three spheres (17%) (Fig. 3). A poor perception of quality of life was found. 84% (78) had global SF12 < 75%, 71% (66) physical SF12 < 75% and 83% (77) mental SF12 < 75%.

60% (56) of the patients were referred to other specialists. The most frequent were 48% (45) to neuropsychology, 20% (19) to mental health, 10% (9) to otorhinolaryngology, 9% (8) to rehabilitation.

Conclusions: There is a high incidence of PICS in patients with risk factors after ICU discharge.

Post-ICU outpatient follow-up is necessary to detect and treat patients with PICS.

Figure 1: Percentage of altered spheres by months.

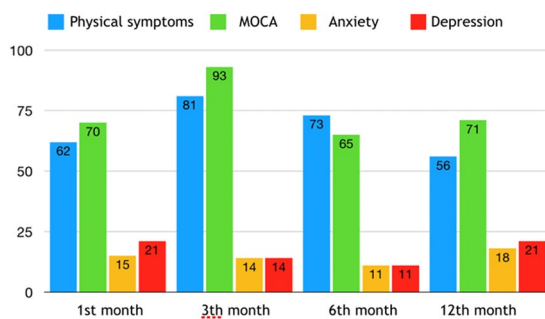
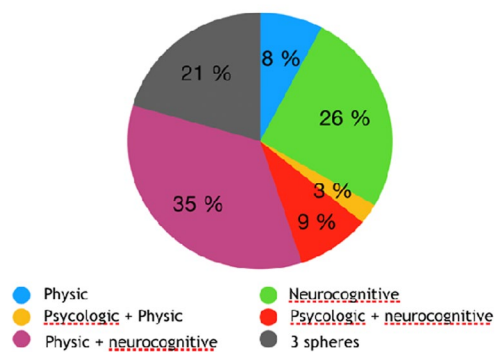

Figure 3: Altered spheres combined.



References

- Extremera P, Añón JM, García de Lorenzo A. Are outpatient clinics justified in intensive care medicine? *Med Intensiva (Engl Ed)*. 2018 Mar;42(2):110–113. English, Spanish.

- Rousseau AF, Prescott HC, Brett SJ et al. Long-term outcomes after critical illness: recent insights. *Crit Care*. 2021 Mar 17;25(1):108.
- Herridge MS, Tansey CM, Matté A et al. Functional disability 5 years after acute respiratory distress syndrome. *N Engl J Med*. 2011 Apr 7;364(14):1293–304.
- Herridge MS, Cheung AM, Tansey CM et al. One-year outcomes in survivors of the acute respiratory distress syndrome. *N Engl J Med*. 2003 Feb 20;348(8):683–93.
- Mikkelsen ME, Still M, Anderson BJ et al. Society of Critical Care Medicine's International Consensus Conference on Prediction and Identification of Long-Term Impairments After Critical Illness. *Crit Care Med*. 2020 Nov;48(11):1670–1679.

Topic: Critical care organisation, quality management, information systems, outcomes

001333

PKPOP-LCR study: pharmacokinetics and pharmacodynamics of Meropenem in neurointensive care patients with external ventricular drainage

M. C. Dominique¹, F. Bernard², J. Pottecher³, C. Gregoire⁴, P. E. Leblanc⁵, R. Chabanne⁶, R. Cinotti⁷, H. De Courson⁸, P. F. Perrigault⁹, G. Francony¹⁰, B. Bouhemad¹¹, A. Chauzy¹², S. Marchand¹², C. Dahyot-Fizelier¹²

¹Anesthésie réanimation, Poitiers University Hospital, Poitiers, France; ²Neuro-réanimation, Poitiers University Hospital, Poitiers, France;

³Anesthésie-réanimation chirurgicale, Hospital Hautepierre Hospitals Academics De Strasbourg, Strasbourg, France; ⁴Anesthesiology and critical care, Rothschild fondation hospital, Paris, France;

⁵Anesthesiology and intensive care, Bicetre Hospital AP-HP, Le Kremlin-Bicêtre, France; ⁶Département anesthésie réanimation, CHU Gabriel-Montpied, Clermont-Ferrand, France; ⁷Anesthésie-réanimation, C.H.U. de Nantes, Nantes, France; ⁸Anesthésie réanimation, Chu Haut Leveque, Pessac, France; ⁹Anesthésie réanimation, Hospital Center University De Montpellier, Montpellier, France; ¹⁰Anesthésie réanimation, Chu Grenoble Alpes, La Tronche, France; ¹¹Department of anaesthesiology and intensive care, Chu Dijon, Dijon, France; ¹²U1070 Pharmacologie Des Agents Anti Infectieux et antibiorésistance, Inserm, Poitiers, France

Correspondence: M.C. Dominique

Intensive Care Medicine Experimental 2023, **11 (Suppl 1)**:001333

Introduction: Nosocomial central nervous system (CNS) infection is rare but of bad prognosis, leading to devastating neurological complications and increased rate of mortality. The difficulty in treating nosocomial CNS infection is due to the blood brain barrier (BBB) making it a challenge to attain effective concentration at target site and being effective against multi-drug resistant (MDR) bacteria common in nosocomial CNS infection (1). Meropenem is a broad-spectrum antibiotic recommended in the treatment of nosocomial CNS infection (2).

Objectives: The main objective of our study was to describe distribution of meropenem at target site in patient with acute brain injury.

Methods: We included in a national prospective multicenter study (CPP17-016a/2017- 002993–37), 25 brain injured patients with an EVD and treated with meropenem for CNS or other infections. Blood and CSF were collected at different time depending on the dosing regimen: intermittent infusion (2 g/8 h or 2 g/6 h), continuous infusion (6–8 g/Day) with or without loading dose of 2 g. Total plasma and CSF concentrations (C^o) were obtained by a Liquid Chromatography coupled with Tandem Mass Spectrometer. Unbound plasma (Plu) C^o was calculated from meropenem protein binding of 2%. From a non-compartmental analysis, C^o time profiles of meropenem were obtained. CSF to plasma ratio, of area under the curve (AUC) of C^o over time for intermittent dosing (AUC_{CSF}/AUC_{Plu}), of C^o at steady state for continuous infusion (CCSF/CPlu), were calculated, representing the rate of meropenem penetration into CSF. We then performed a PK population modelling with a Monte Carlo Simulation (MCS) to obtain probability of target attainment (PTA) and Cumulative fraction response (CFR). PTA

and CFR were performed for patients without CNS infection (type 0) and with CNS infection (type 1).

Results: We included 25 patients after informed consent, (mean age: 54 ± 16,20 years old), and analyzed 114 blood and 135 CSF samples. For all patients (with and without CNS infection) mean AUCCSF/AUC-Plu was 0.15 ± 0.12 and CCSF/CPlu was 0.07 ± 0.06. PTA:100%T > MIC was reached in plasma for continuous infusion. For a MIC = 2 µg/ml in patients with CNS infection, PTA in CSF was 40% for 2 g every 8 h, 60% for 2 g every 6 h, 50% for 6 g/Day of continuous infusion after loading dose of 2 g and 65% for 8 g/Day of continuous infusion after loading dose of 2 g. CFR were higher than 90% for all species studied except *Pseudomonas aeruginosa* in patients with and without CNS infection.

Conclusions: As described in literature, Meropenem poorly penetrates the CSF with a large interindividual variability (3, 4). The appropriate strategy to achieve optimal therapeutic concentrations for an optimal pharmacodynamic efficacy in most of CNS infections with GNB except for *Pseudomonas aeruginosa* or GNB with high MIC 36 36 seems to be 6 g/day continuous infusion. For intermittent dosing regimen longer duration of infusion should be preferred. For *Pseudomonas aeruginosa*, higher daily dose of meropenem should be considered and further studies are needed. For a probabilistic treatment 8 g/day should probably be preferred first and in case of identification of a difficult to treat bacteria, a therapeutic drug monitoring of meropenem in CSF could be proposed to avoid treatment failure. The practice of therapeutic drug monitoring should be further studied to be proposed in routine.

References

1. Zheng Zhang, BMC Infect Dis (2021) 2. Tunkel et al. IDSA Guidelines 2017 3. Blassmann Critical care (2016) 4. R.Tsumura Journal of chemo (2008)

Topic: Neurointensive care

001335

COVID-19 ARDS treated with ECMO in peripartum patients: a systematic review

L. Muscarà¹, S. Palella¹, L. La Via², S. Tigano², A. Caruso³, F. Sanfilippo⁴
¹Anesthesiology and intensive care, Magna Græcia University, Catanzaro, Italy; ²Anesthesiology and Intensive Care, University of Catania, Catania, Italy; ³School of anaesthesia and intensive care, University Hospital "G. Rodolico", Catania, Italy; ⁴Department of anesthesiology and intensive care, University Hospital "G. Rodolico", Catania, Italy

Correspondence: S. Palella

Intensive Care Medicine Experimental 2023, 11 (Suppl 1):001335

Introduction: BACKGROUND: Coronavirus disease 19 (Covid-19) has been one of the most common causes of acute respiratory distress syndrome (ARDS), being responsible for a pandemic with almost 7 million deaths certified. Severe forms of ARDS can be supported with veno-venous extracorporeal membrane oxygenation (VV-ECMO). A specific population where the use of VV-ECMO for Covid-19 ARDS has been repeatedly reported is in young women in the peripartum period.

Objectives: OBJECTIVES: We aimed at performing a systematic review to summarize the results of the current literature on VV-ECMO in peripartum women with Covid-19 ARDS.

Methods: METHODS: We performed web-based search on Pubmed (last update 31.03.2023) to identify relevant articles; the protocol was regularly registered on PROSPERO. We included only articles published in English. Data were inserted independently by two authors (LM, SP) in an Excel database, and cross-checked by two authors (LLV, FS). We primarily focused on maternal and fetal mortality, recording also maternal and gestational age, as well as values of PaO2/FiO2 (P/F) ratio at cannulation, VV-ECMO duration and intensive care unit (ICU) and hospital length of stay (LOS).

Results: RESULTS: Our systematic search retrieved 131 items on Pub-Med. As reported in Table 1, we finally included 11 studies, including 8 retrospective studies (5 of them being single-center studies, 2 multi-center studies and 1 cohort study), 2 prospective studies (1 of them being single center study and 1 multicenter study), 1 prospective and retrospective cohort study, with a total of 191 patients. Among them, 151 were prepartum and 40 postpartum women (mean age 31 years). Average P/F ratio at cannulation was 72 with a mean duration of VV-ECMO of 22 days. Only 4 studies reported data on ICU and 3 on hospital LOS, with a mean of 43 and 63 days, respectively. The average maternal and fetal mortality were 17.8% (30/168, n = 10 studies) and 20.7% (12/58, n = 8 studies), respectively. Notably, the largest study did not report data on fetal mortality.

Conclusions: CONCLUSIONS: In our systematic review of case series and studies reporting data from pregnant women supported by VV-ECMO for severe ARDS due to COVID-19, we found that maternal and fetal survival stands around 80%. Such results seem rather good considering these were obtained during previously unexperienced pandemic conditions.

Tabella 1

Case series	Type of study	Cases	Maternal Age (years)	Prepartum	Postpartum	Pa/FiO2 ratio (mmHg)	ECMO days	Type of ECMO	Length of stay (days)	Hospital Length of stay (days)	Maternal mortality	Fetal Mortality
Kovacevic et al.	Retrospective single center	4	-	4	0	-	-	VV	-	-	3/4	0/4
Kakar et al.	Retrospective single center	5	33	1	4	66.2	59	VV	83	128	0/5 (1 transplant)	2/5
Peju et al.	Retrospective multicenter	15	-	4	11	-	-	VV	-	-	-	-
Bamasood et al.	Prospective single center	8	28.3	4	4	79.3	22	VV	-	-	0/8	0/8
Sitter et al.	Prospective multicenter	15	34	11	4	60	25	VV*	38	-	3/9 (6 unknown)	3/14 (1 unknown)
Yin et al.	Retrospective single center	5	33	5	-	94	11	VV	26	30	1/4 (1 unknown)	1/4 (1 unknown)
Shih et al.	Retrospective multicenter	10	30	5	5	60.5	22	VV	28	31.5	1/5201	1/5203
O'Neil et al.	Retrospective cohort study	100	32.4	100	-	68	16.5	VV	-	-	16/100	-
Barrantes et al.	Retrospective single center	9	30	4	5	62	10	VV	-	-	0/8 (1 unknown)	1/8 (1 unknown)
Piwowarczyk et al.	Retrospective single center	5	33.2	1	4	93	11	VV	-	-	3/5	1/5
Fatic et al.	Prospective and Retrospective cohort study	15	-	12	3	-	-	-	-	-	2/15	-
Results		191	31.7	151	40	72.8	22	VV	43.7	63	30/168	12/58

*One case of VA-ECMO

References

1. O'Neil ER, Lin H, Shamshirsaz AA, et al. Pregnant and Peripartum Women with COVID-19 Have High Survival with Extracorporeal Membrane Oxygenation: An Extracorporeal Life Support Organization Registry Analysis. Journal of clinical medicine 2022; 205: 248–50
2. Lankford AS, Chow JH, Jackson AM, et al. Clinical Outcomes of Pregnant and Postpartum Extracorporeal Membrane Oxygenation Patients. Anesthesia and analgesia 2021; 132: 777–87
3. Radsel P, Gorjup V, Jazbec A, et al. Pregnancy complicated by influenza A ARDS requiring consecutive VV-ECMO treatment with successful vaginal delivery. American journal of transplantation: official journal of the American Society of Transplantation and the American Society of Transplant Surgeons 2018; 21: 471–4
4. Foessleitner P, Hoetzenecker K, Benazzo A, et al. Bilateral lung transplantation during pregnancy after ECMO for influenza-A caused ARDS. 2021; 21: 3456–60
5. Wu H, Tang Y, Xiong X, Zhu M, Yu H, Cheng D. Successful Application of Argatroban During VV-ECMO in a Pregnant Patient Complicated With ARDS due to Severe Tuberculosis: A Case Report and Literature Review. Frontiers in pharmacology 2022; 13: 866,027
6. Olson TL, O'Neil ER, Ramanathan K, Lorusso R, MacLaren G, Anders MM. Extracorporeal membrane oxygenation in peripartum cardiomyopathy: A review of the ELSO Registry. International journal of cardiology 2020; 311: 71–6

- 1 Woodruff RC, Campbell AP, Taylor CA, et al. Risk Factors for Severe COVID-19 in Children. *Pediatrics* 2022; 149
- 9 <https://www.else.org/registry/fullcovid-19registrydashboard.aspx>
- 8 Sitter M, Pecks U, Rüdiger M, Friedrich S, Fill Malferttheiner S, Hein A. Pregnant and Postpartum Women Requiring Intensive Care Treatment for COVID-19-First Data from the CRONOS-Registry. *Journal of clinical medicine* 2022; 11

Topic: Acute respiratory failure and mechanical ventilation

001336

Cationic liposomes to enhance meropenem efficacy and bactericidal activity

N. Saleem¹, J. Dudziak¹, W. Catherine², R. B. Jonathan², H. Stefan², M. Singer³, N. Arulkumar³

¹Division of medicine, University College London, London, United Kingdom; ²Department of Chemistry, University College London, London, United Kingdom; ³Bloomsbury institute of intensive care medicine, University College London, London, United Kingdom

Correspondence: N. Saleem

Intensive Care Medicine Experimental 2023, **11 (Suppl 1)**:001336

Introduction: The rising incidence of Gram-negative bacteria is a global threat (1, 2). Positively charged liposomes are preferentially attracted to the negatively-charged Gram negative bacterial membrane (Figure 1) and can be used to potentially overcome multidrug-resistant bacterial infections by achieving higher target concentrations.

Methods: Meropenem was encapsulated within cationic liposomes. The in vitro antimicrobial efficacy of free (non-liposomal) and cationic liposome-encapsulated meropenem was compared by determination of minimum inhibitory concentration (MIC) against different bacterial strains.

To assess liposomal safety in vitro, healthy volunteer whole blood was incubated with standard or liposomal meropenem for 6 h at therapeutic (10mcg/ml and 30mcg/ml) and supra-therapeutic (100mcg/ml) concentrations. Leucocyte toxicity was evaluated by measurement of reactive oxygen species (ROS) production and cell viability using flow cytometry.

Results: Depending on the specific charge, phospholipid composition, and sizes of liposomes, the efficacy of liposomal meropenem was as high as 125-fold compared to free meropenem (Fig. 2). Even at supratherapeutic concentrations, liposomal meropenem formulations were associated with minimal, if any, increase in leucocyte ROS or cell death.

Conclusions: Cationic liposomal meropenem enhanced bactericidal activity in-vitro compared to free meropenem, and were non-toxic in vitro. Assessment of efficacy, safety, and pharmacokinetics of liposomal antibiotics needs to be assessed in an in vivo model of sepsis.

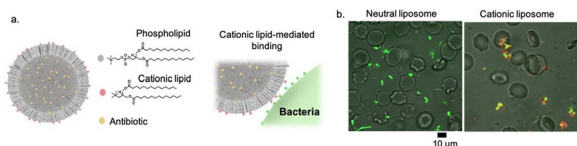
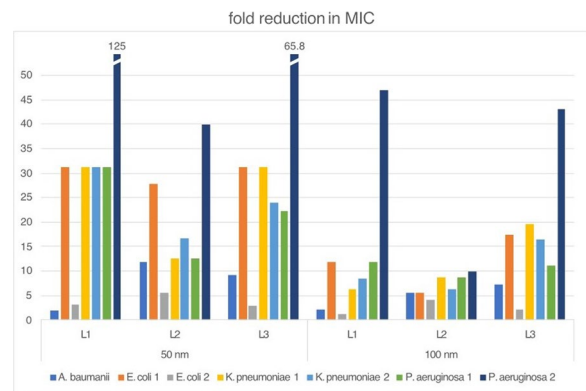

Figure 1 (abstract 001336) (a) Bacterial targeting is mediated by cationic lipids (red), which directs liposome binding to negatively charged lipids in bacterial cells (green). (b) Confocal laser scanning microscopic (CLSM) showing antibiotic liposomes (red) co-localise selectively with *E.coli* (green) cells and not erythrocytes (bright field)



Bars indicating reduction in minimum inhibitory concentrations (MIC, in microg/mL) of three formulations of cationic liposomal meropenem (each at 2 sizes) against free meropenem against laboratory strains of common pathogens.

References

1. Organization WH. Global antimicrobial resistance and use surveillance system (GLASS) report: 2021. 2021. 2. Murray CJ, Ikuta KS, Sharara F, Swetschinski L, Aguilar GR, Gray A, et al. Global burden of bacterial antimicrobial resistance in 2019: a systematic analysis. *The Lancet*. 2022;399 (10,325):629–55.
2. None

Topic: Infections and prevention

001340

Efficacy and safety of Clevidipine for blood pressure control after carotid endarterectomy: a prospective cohort study

M. Vives¹, K. Regi², R. Riera³, B. Lloret², A. Castanera⁴, C. Sos⁵

¹Anesthesia & Critical Care, Clinica Universidad de Navarra, Pamplona, Spain; ²Anesthesia & Intensive Care, Hospital Universitari de Girona Doctor Josep Trueta, Girona, Spain; ³Anesthesia & Intensive Care, Hospital Clínic de Barcelona, Barcelona, Spain; ⁴Intensive Care Nursing, Hospital Universitari de Girona Doctor Josep Trueta, Girona, Spain; ⁵Vascular Surgery, Hospital Universitari de Girona Doctor Josep Trueta, Girona, Spain

Correspondence: M. Vives

Intensive Care Medicine Experimental 2023, **11 (Suppl 1)**:001340

Introduction: Carotid Endarterectomy (CEA) surgery has an increased risk of postoperative stroke, as well as hyperperfusion syndrome. Thus, postoperative strict control of Blood Pressure is crucial. Our institutional target range is a postoperative systolic BP (sBP) within 130-145 mmHg. The goal of our study was to observe the efficacy of the use of clevidipine to control sBP within the established target range. Our hypothesis was that clevidipine is more effective than standard management in controlling BP.

Methods: This is an observational prospective cohort study. Data from consecutive patients older than 18 years old undergoing carotid endarterectomy were prospectively collected from April 2018 to October 2021. This study was approved by the Institutional Review Board (IRB). The primary outcome was the Area Under the Curve for systolic Blood Pressure (AUC-sBP) normalized per hour

(mmHg x min/h) during the first 6 h postoperatively. It measures the amount and time of sBP being below or above the pre-established target range (130-145 mmHg). Non-parametric test (Wilcoxon rank-sum and Fischer's exact test) were used to compare the continuous and dichotomic variables between groups. Stata 13.1 was used for data analysis.

Results: Data from 97 consecutive patients were prospectively collected. Clevidipine was used in 44 of them, while for the other 53 patients in the non-clevidipine group, labetalol was used in 38 patients, while 15 patients needed a combination of labetalol plus urapidil to maintain sBP within the pre-established target range. The clevidipine group showed higher baseline sBP (mean \pm SD 144 \pm 15 vs 140 \pm 7 mmHg, SMD = 0.34).

The use of clevidipine was associated with a significantly lower AUC-sBP (mmHg x min /h) compared to the non-clevidipine group (median [IQR], 120 [92–150] vs 240 [240–300] mmHg x min/h, $p < 0.00001$). Results were confirmed after adjusted linear regression analysis (coef. -220 mmHg x min/h (95% CI -293 -146), $p = 0.0001$). The mean total cumulative dose of clevidipine was 58 \pm 86 mg, mean \pm SD. The mean time of clevidipine use was 14 \pm 10 h, mean \pm SD. No adverse effects were observed associated with the use of clevidipine.

Conclusions: In our cohort, the use of clevidipine was associated with higher efficacy for Blood Pressure control after Carotid Endarterectomy compared to the use of labetalol or urapidil, without adverse effects observed.

References

1. Kawamata T, et al. Postcarotid endarterectomy cerebral hyperperfusion can be prevented by minimizing intraoperative cerebral ischemia and strict postoperative blood pressure control under continuous sedation. *Neurosurgery* 2009; 64:447–453

Topic: Perioperative care

001342

Diagnostic accuracy of some alternative methods for nasogastric tube replacement: a review on observational and randomized clinical trials.

O. Moradi Moghaddam¹, M. Niakan Lahiji¹, A. Ebnerasouli², P. Irandoost³
¹Trauma and injury research center, Critical care department, Iran University of Medical Sciences, Tehran, Islamic Republic of Iran; ²Critical care department, Iran University of Medical Sciences, Tehran, Islamic Republic of Iran; ³Clinical nutrition, Iran university of medical sciences, Tehran, Islamic Republic of Iran

Correspondence: P. Irandoost

Intensive Care Medicine Experimental 2023, **11** (Suppl 1):001342

Introduction: Despite utilization of enteral feeding has a highly prominent impact upon critical care in intensive care units (ICU), serious and maybe even lethal related complications can occur because of the poor nasogastric tube (NGT) replacement. NGT is a procedure routinely performed in patients with enteral feeding and assessing correct nasogastric tube placement is vital. Today, chest X-ray is universally accepted as a gold standard to confirm correct positioning of NGT. However, alternative methods are introduced because of some chest radiography related demerits like high financial cost, further time required for X-ray confirmation, as well as multiple radiation exposure in some cases.

Objectives: OBJECTIVES: In the current study, we aimed to evaluate diagnostic accuracy of some of the alternative methods including end-tidal CO₂ (ETCO₂), pH analysis and point-of-care ultrasonography (POCUS) in comparison to chest X-ray.

Methods: We reviewed main alternative methods including end-tidal CO₂ (ETCO₂), pH analysis and point-of-care ultrasonography (POCUS) and compared them accuracy with chest X-ray. An electronic literature search was conducted until 2023, using PubMed, Web of Sciences and Scopus. Studies with all epidemiological designs like observational and randomized control trials were considered.

Results: Our review indicated that sensitivity of POCUS in observational studies was between 0.91% (95% CI, 83–96%) and 100% (95% CI, 97–100%) with specificity ranged from 67% (95% CI, 9–99%) to 100% (95% CI, 74–100%). In an RCT in 118 patients, sensitivity of POCUS was reported 96.5% (95% CI, 88–99.6%) with PPV 98.2% (95% CI, 98.1–98.3%). In a study the pH measurement was not confirmed as a reliable technique for confirming NGT placement. Another investigation suggested mild diagnostic accuracy in pH with cutoff equal to 4.25 (AUC 0.79, $p < 0.001$). The ROC analysis for ETCO₂ with a cut point of 25.5 mmHg reached 1.0 (AUC 1.0, $p < 0.001$).

Conclusions: It seems that ETCO₂, POCUS, and pH could be good alternatives for chest X-ray respectively. But strong RCTs with large sample size should be performed for comparing diagnostic accuracy of these methods with each other at the same time.

References

1. Ceruti S, Dell'Era S, Ruggiero F, Bona G, Glotta A, Biggiogero M, et al. Nasogastric tube in mechanically ventilated patients: ETCO₂ and pH measuring to confirm correct placement. A pilot study. *Plos one*. 2022;17 (6):e0269024. 2. Kim HM, So BH, Jeong WJ, Choi SM, Park KN. The effectiveness of ultrasonography in verifying the placement of a nasogastric tube in patients with low consciousness at an emergency center. *Scandinavian journal of trauma, resuscitation and emergency medicine*. 2012;20 (1):1–6. 3. Mak MY, Tam G. Ultrasonography for nasogastric tube placement verification: an additional reference. *British Journal of Community Nursing*. 2020;25 (7):328–34. 4. Mumoli N, Vitale J, Pagnamenta A, Mastroiacovo D, Cei M, Pomerio F, et al. Bedside abdominal ultrasound in evaluating nasogastric tube placement: a multicenter, prospective, cohort study. *Chest*. 2021;159 (6):2366–72. 5. Peng J, Tang M, Liu L, Chen W, Ye Q. Diagnostic accuracy of ultrasonography for detecting gastric tube placement: an updated meta-analysis. *Eur Rev Med Pharmacol Sci*. 2022;26 (17):6328–39. 6. Rahimi-Movaghar V, Boroojeny S, Moghtaderi A, Keshmirian B. Intracranial placement of a nasogastric tube: a lesson to be re-learned? *Acta Neurochirurgica*. 2005;147 (5):573. 7. Tai P, Lau W, Chan P, Ng S, Lam Y, Mak H, et al. Nurse performed ultrasonography in confirming the position of nasogastric tube in the emergency department: A prospective single group diagnostic test study. *Hong Kong Journal of Emergency Medicine*. 2016;23 (6):340–9. 8. Taskiran N, Sari D. The effectiveness of auscultatory, colorimetric capnometry and pH measurement methods to confirm placement of nasogastric tubes: a methodological study. *International Journal of Nursing Practice*. 2022;28 (2):e13049. 9. Tsolaki V, Zakynthinos GE, Zygoulis P, Bardaka F, Malita A, Aslanidis V, et al. Ultrasonographic confirmation of nasogastric tube placement in the COVID-19 era. *Journal of Personalized Medicine*. 2022;12 (3):337. 10. Yaseen M, Kumar A, Bhoi S, Sinha TP, Jamshed N, Aggarwal P, et al. Point-of-care ultrasonography-assisted nasogastric tube placement in the emergency department: a randomized controlled trial. *European Journal of Emergency Medicine*. 2022;29 (6):431–6. 11. Yıldırım Ç, Coşkun S, Gökhan Ş, Pamukçu Günaydin G, Özhasenekler A, Özkula U. Verifying the placement of nasogastric tubes at an emergency center: comparison of ultrasound with chest radiograph. *Emergency Medicine International*. 2018;2018. 12. Zatelli M, Vezzali N. 4-Point ultrasonography to confirm the correct position of the nasogastric tube in 114 critically ill patients. *Journal of ultrasound*. 2017; 20:53–8.

Topic: Metabolism, endocrinology, liver failure and nutrition

001343

Association between telomere length in COVID-19 patients and respiratory progression

Ó. Martínez González¹, A. Virseda-Berdeses², M. Chana-García¹, B. López-Matamala¹, M. A. Alonso Fernández¹, C. Martín-Parra¹, M. Manso Álvarez¹, S. Sánchez López¹, M. Jiménez-Sousa², A. Fernández-Rodríguez², C. Rodríguez Ruiz³, A. Martínez De La Gandara³, Ó. Brochado-Kith², S. Bueno Bustos², M. Mallol-Poyato⁴, J. Villarín-Hernández¹, R. Blancas¹

¹Department of critical care, Hospital Universitario del Tajo. Universidad Alfonso X El Sabio, Aranjuez, Spain; ²Unit of viral infection and immunity, national center for microbiology, ISCIII, Majadahonda, Spain; ³Intensive

care units, Hospital Universitario Infanta Leonor, Madrid, Spain;
⁴Department of laboratory, Hospital Universitario del Tajo, Aranjuez, Spain
Correspondence: Ó. Martínez González
Intensive Care Medicine Experimental 2023, **11 (Suppl 1):**001343

Introduction: Telomere shortening is associated with an impairment of the immune system, which is explained by the progressive decline in physiological homeostasis associated with aging. The severity of acute respiratory distress syndrome (ARDS) depends on the amount of etiologic substances with corresponding immune reactions, the duration of the appearance of specific immune cells, or the repertoire of specific immune cells that control the substances.

Objectives: Study the impact of telomere length in whole blood from COVID-19 patients at disease onset with the need for invasive and non-invasive mechanical ventilation, need for pronation, days of pronation and worst PaO₂/FiO₂ in patients admitted to the ICU.

Methods: A cross-sectional prospective study enrolling critical patients with COVID-19 recruited at Tajo University Hospital was carried out from March to September 2020. Blood samples were obtained upon admission to the ICU, prior to connection to any kind of mechanical ventilation. Relative telomere length (RTL) quantification was carried out by monochromatic multiplex realtime quantitative PCR. Telomere length analysis was adjusted for age, gender and BMI.

Results: 72 patients were analyzed. Table 1 presents descriptive information on sample demographic characteristics. Initially, no association was found between the relative length of the telomere and the need for invasive mechanical ventilation (IMV) (OR 2,30; CI 95%: 0,63–8,49). After adjusting for age, gender and weight an association was observed. Patients who required invasive mechanical ventilation had a shorter relative telomere length than those who did not (1,69 vs 1,86), with an OR 11,49 (CI 95%: 1,60–119,05). No associations were found with need for non-invasive mechanical ventilation, need for pronation, days of pronation and worst PaO₂/FiO₂, in the adjusted and unadjusted models.

Clinical and epidemiological characteristics				
	ALL	NOT IMV	IMV	p-value
No	72	15	57	
Age (years)	62.50 [54.00, 70.25]	57.00 [52.00, 64.50]	64.00 [55.00, 71.00]	0.178
Gender (male)	52/72 (72.2)	12/15 (80.0)	40/57 (70.2)	0.666
BMI (kg/m ²)	31.14 [26.35, 35.16]	29.09 [24.24, 31.46]	32.76 [26.60, 35.16]	0.154
SDRA	71/72 (98.6)	14/15 (93.3)	57/57 (100.0)	0.470
SAPS 3	47.00 [45.50, 55.00]	45.50 [41.75, 50.25]	51.00 [46.00, 55.00]	0.421
APACHE II	11.00 [7.50, 14.00]	7.50 [6.00, 11.75]	11.00 [9.00, 14.00]	0.339
Hospital stay (days)	27.00 [19.00, 38.00]	19.00 [15.00, 23.50]	28.00 [21.00, 41.00]	0.007
Days from symptom onset to ICU admission	9.00 [5.75, 12.00]	10.00 [8.00, 11.50]	8.00 [5.00, 12.50]	0.351
ICU days	11.00 [7.75, 21.25]	5.00 [3.50, 7.00]	15.00 [9.00, 26.00]	<0.001
High-flow nasal cannula	53/72 (73.6)	15/15 (100.0)	38/57 (66.7)	0.023

Clinical and epidemiological characteristics

	ALL	NOT IMV	IMV	p-value
Prone positioning during first 7 days	21/72 (29.2)	1/15 (6.7)	20/57 (35.1)	0.066
Days prone positioning (n=21)	2.00 [1.00, 3.00]	3.00 [3.00, 3.00]	2.00 [1.00, 3.50]	0.491
Worst PaO ₂ /FiO ₂	130.71 [109.69, 160.46]	117.67 [85.62, 131.96]	136.00 [111.25, 165.20]	0.052

Conclusions: The presence of a shortened relative telomere length at admission to the ICU in patients with COVID-19 disease is associated with a greater need for invasive mechanical ventilation.

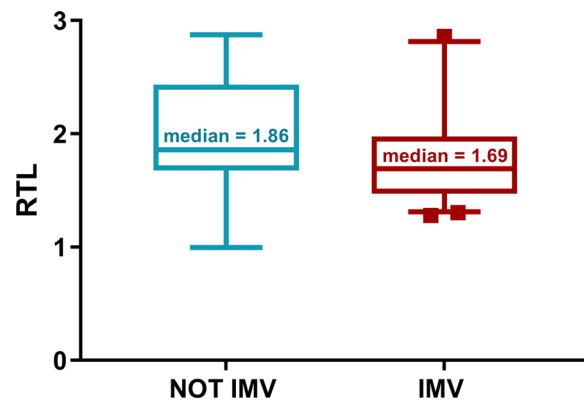

Topic: Acute respiratory failure and mechanical ventilation

001344

A retrospective, single center cohort service evaluation of anidulafungin prescribing during COVID-19 pandemic

C. Meddings¹, F. Hanks², D. P. Rahmawati³
¹Critical Care/Pharmacy, Guy's and St Thomas' Hospital, London, United Kingdom; ²Critical care, Guy's and St Thomas' NHS Foundation Trust, London, United Kingdom; ³School of Pharmacy, UCL School of Pharmacy, London, United Kingdom

Correspondence: C. Meddings
Intensive Care Medicine Experimental 2023, **11 (Suppl 1):**001344

Introduction: International guidelines recommend the use of steroids and interleukin-6 antagonists for treating COVID-19 (C-19) in patients requiring respiratory support. (1) However, these agents have been associated with increased risk of fungal infection. (2) Anidulafungin is the first-line antifungal for invasive candidiasis (IC) at Guy's and St Thomas' Adult Critical Care Units (ACCU). Increased anidulafungin consumption was observed during the C-19 pandemic on ACCU and it was unknown if this was due to increased activity or a change in prescribing practices. Therefore, we undertook a retrospective, single-centre service evaluation of anidulafungin prescribing in ACCU to identify the effect of C-19 on guideline compliance and anidulafungin usage.

Objectives: To compare the following between C-19 and non-C-19 cohorts:

1. The Defined Daily Dose of anidulafungin prescribing (DDD/100 bed days) using World Health Organisation DDD methodology. (3)
2. The percentage of suspected versus proven IC at anidulafungin prescription initiation.
3. Compliance of anidulafungin prescribing with ACCU antifungal guideline based on specified risk factors for IC.

Methods: Data collection occurred over three separate 2 calendar month periods: pre-C-19 comparator (January–February 2020), C-19 surge one (April–May 2020) and C-19 surge two (January–February 2021). All patients prescribed anidulafungin and admitted to ACCU were included. Electronic medical records were interrogated and data collected using a pre-defined data collection tool. Statistical analysis was carried out using SPSS v28. A Kruskal Walls H test was used for comparing DDD's, and Chi-square test for patient demographics. P values < 0.05 were considered statistically significant.

Results: A statistically significant increase in anidulafungin DDD was observed between the control cohort and C-19 surge 1 and surge 2 cohorts (3.42 versus 13.62 and 12.91 respectively, p = < 0.001). The indication for anidulafungin prescribing was for suspected IC in the majority of cases, with only two proven infections across all cohorts. The percentage of prescriptions that were compliant with prescribing guidelines was higher in the C-19 cohorts compared to the control (77% and 81%, compared to 60%). Median duration of anidulafungin treatment was 6 days for all cohorts.

Table 1 (abstract 001344) Patient demographics

	Pre-C-19 (n = 15)	C-19 Surge 1 (n = 60)	C-19 Surge 2 (n = 96)	Chi-square test (p-value)
Diabetes	1 (6.7%)	13 (21.7%)	34 (35.4%)	0.027
Immunosuppressive Medication	5 (33.3%)	30 (50%)	86 (89.6%)	< 0.01
Prior antibiotic use	13 (86.7%)	49 (81.7%)	86 (89.6%)	0.058
Vascular access device	11 (73.3%)	51 (85%)	89 (92.7%)	0.058
Total Parenteral Nutrition	3 (20%)	2 (3.3%)	6 (6.3%)	0.062
Abdominal surgery	4 (26.7%)	5 (8.3%)	2 (2.1%)	0.01
Median length of stays (IQR)—day	7 (2–12)	12 (7–20)	13 (8–20)	0.031
Multiple candida colonisation	2 (13%)	9 (15%)	12 (12.5%)	0.906

Conclusions: The increased anidulafungin usage observed in the C-19 cohorts was due to increased prescribing for suspected IC, rather than proven IC, or increased bed days. This is likely due to anidulafungin initiation in patients with ongoing signs of sepsis with no clear source. Potential contributing factors identified include significantly higher rates of diabetes, immunosuppressant use and longer ICU stay in C-19 cohorts. The high DDD, low proven infection rate, and high guideline compliance highlight the limitations of guideline driven anidulafungin prescribing, and the need for rapid molecular diagnostics to identify true IC, facilitating appropriate anidulafungin use.

References

1. 3. WHO Collaborating Centre for Drug Statistics Methodology, Guidelines for ATC classification and DDD assignment 2023. Oslo, Norway, 2022. Accessed 22/04/2023 via: https://www.whocc.no/atc_ddd_index_and_guidelines/guidelines/
2. 2. Clinical management of COVID-19: living guideline, 13 January 2023. Geneva: World Health Organization; 2023 (WHO/2019-nCoV/clinical/2023.1). Licence: CC BY-NC-SA 3.0 IGO. Accessed 22/04/2023 via: <https://www.who.int/publications/i/item/WHO-2019-nCoV-clinical-2023.1>
3. 1. Ezeokoli OT, Gcilitshana O, Pohl CH. Risk Factors for Fungal Co-Infections in Critically Ill COVID-19 Patients, with a Focus on Immunosuppressants. J Fungi (Basel). 2021;7 (7):545. Published 2021 Jul 9. <https://doi.org/10.3390/jof7070545>

Topic: Infections and prevention

001345

Epidemiology and clinical outcomes of sepsis-induced acute kidney injury: a prospective nationwide multicenter cohort study in South Korea

Y. Jang¹, S.Y. Lim², M. J. Song²

¹Digital Healthcare ICT lab, Seoul National University Bundang Hospital, Seongnam-si, Republic of Korea; ²Department of Internal Medicine, Seoul National University Bundang Hospital, Seongnam-si, Republic of Korea

Correspondence: Y. Jang

Intensive Care Medicine Experimental 2023, **11 (Suppl 1)**:001345

Introduction: Sepsis-induced acute kidney injury (AKI) is a common and serious complication in critically ill patients, increasing morbidity and mortality rates. This study aimed to explore the characteristics and clinical outcomes of critically ill patients with sepsis-induced AKI.

Methods: We conducted a prospective observational study involving adult patients diagnosed with sepsis according to the third International Consensus Definitions for Sepsis from 19 institutions across South Korea. AKI was defined based on the Kidney Disease Improving Global Outcomes (KDIGO) classification. Baseline creatinine was determined as the lowest value during admission or the calculated value from the Modification of Diet in Renal Disease (MDRD) study equation, assuming a baseline glomerular filtration rate of 75 mL/min/1.73 m².

Results: A total of 4,885 patients were included in the analysis. Among them, 3,063 (62.7%) presented with sepsis-induced AKI, with 549 patients in stage 1 and 2,410 in stages 2 and 3. Patients with sepsis-induced AKI had significantly higher baseline serum lactate, procalcitonin levels, and Sequential Organ Failure Assessment (SOFA) scores and required more vasoactive drugs than those without AKI. Non-adherence to obtaining blood cultures and administering broad-spectrum antibiotics within 1 h was associated with the development of AKI. Hospital mortality rates were 41.7% for sepsis patients with AKI and 23.4% for those without AKI. The adjusted hazard ratio (HR) for in-hospital mortality in patients with stage 2 and 3 AKI were 1.35 (95% CI: 1.10–1.67, $p < 0.001$) and 1.64 (95% CI: 1.33–2.03, $p < 0.001$), respectively.

Conclusions: Our study revealed a 62.7% incidence of sepsis-induced AKI in adult patients in South Korea. Sepsis-induced AKI was independently associated with longer hospital stays and increased in-hospital mortality rates.

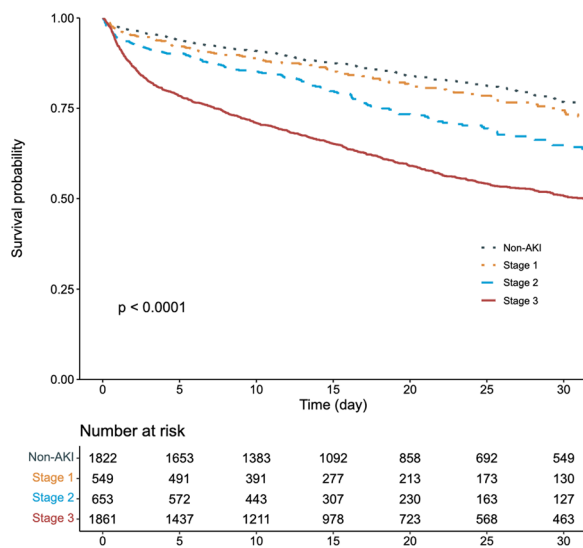

Variable	Total N = 4,885	Dead N = 1,704	Alive N = 3,181	p value	HR (95% CI)
KDIGO stage				<0.001	
Non-AKI	1,822 (37.3)	427 (25.1)	1,395 (43.9)		1 (ref.)
Stage 1	549 (11.2)	133 (7.8)	416 (13.1)		1.16 (0.93-1.46)
Stage 2	653 (13.4)	187 (11.0)	466 (14.6)		1.35 (1.10-1.67)
Stage 3	1,861 (38.1)	957 (56.2)	904 (28.4)		1.64 (1.33-2.03)
CRRT, %	1,377 (28.2)	853 (50.1)	524 (16.5)	<0.001	
Mechanical Ventilation, %	1,983 (40.6)	921 (54.0)	1,062 (33.4)	<0.001	
Length of stay, day					
ICU	8.2 ± 11.5	8.6 ± 12.7	8.0 ± 10.8	<0.001	
Hospital	25.8 ± 31.2	20.1 ± 30.2	28.8 ± 31.3	<0.001	

References

1. Lim, S. Y., Park, Y., Chin, H. J., Na, K. Y., Chae, D. W., & Kim, S. (2019). Short-term and long-term effects of low serum bicarbonate level at admission in hospitalised patients. *Scientific reports*, 9 (1), 2798. <https://doi.org/10.1038/s41598-019-38892-1>

Topic: Acute Kidney Injury and haemofiltration

001346

Management of Candidemia in a UK medico-surgical intensive care unit

P. Jenkinson¹, R. Blackman-Mark,¹ H. Mackay¹, J. Clayton,¹ R. Varghese,¹ B. Creagh-Brown¹

¹Intensive Care Medicine, Royal Surrey County Hospital, Guildford, United Kingdom

Correspondence: P. Jenkinson

Intensive Care Medicine Experimental 2023, **11 (Suppl 1):**001346

Introduction: Candidaemia is the most common form of invasive candidiasis (IC) and significantly impacts the morbidity and mortality of critically ill patients¹. The cumulative incidence of IC in Europe is 7.07 per 1000 intensive care unit (ICU) admissions². Candidaemia poses both a diagnostic and therapeutic challenge: whilst early initiation of treatment is beneficial, early diagnosis is difficult. Confirmatory cultures take time and the value of more expeditious screening tests remains uncertain³.

Objectives: To analyse the cohort of patients diagnosed with candidaemia for common risk factors, adherence to management guidelines and overall outcomes.

Methods: A retrospective notes review was conducted of all patients diagnosed with candidaemia in our mixed adult ICU between February 2019 and September 2022. Patient demographics, risk factors for candidaemia, biochemical markers of infection, candida score⁴, candida species cultured, investigations performed, antifungal treatment, in-hospital mortality and length of stay were all collected.

Results: There were 16 patients diagnosed with candidaemia during the study period. The mean patient age was 66 years and 81% were male. 44% of patients were medical admissions whilst 56% were surgical. Admission blood tests, CRP on day of candidaemia diagnosis, candida score and candida species grown are summarised in Table 1. *Candida albicans* was cultured in 10 patients (62%), whilst *Candida glabrata*, *Candida dubliniensis* and *Candida tropicalis* were grown in 4 (25%), 1 (6%) and 1 (6%) of patients respectively.

Of the 16 patients, those with typical risk factors for candidaemia were as follows: broad-spectrum antibiotics 16 (100%), indwelling central venous catheter 15 (94%), total parenteral nutrition 7 (44%), diabetes 5 (31%), immunosuppression 5 (31%), renal replacement therapy 3 (19%), neutropenia 2 (12%) and pancreatitis 2 (12%) (Table 1).

The recommended investigations for patients with candidaemia include serial blood cultures, echocardiography and fundoscopy. These were received by 11 (69%), 8 (50%) and 5 (31%) of patients respectively. Of the 13 patients with available data, 10 (77%) were managed with antifungal agents: 6 receiving fluconazole (46%) 4 receiving caspofungin (31%) and 2 receiving amphotericin B (15%) (Table 1).

The overall in-hospital mortality was 53%. The average ICU length of stay was 12 days (4–28 days range) (Table 1).

Conclusions: At our centre, the incidence of candidaemia was significantly lower than described in large multicentre studies², with a similar mortality¹. Typical risk factors described in the cohort demonstrate patients at greatest risk of candidaemia and the management demonstrates less than perfect adherence to investigation and treatment guidelines. Utilising this data to power a prospective quality improvement project could aid the recognition, management and prevention of candidaemia in future.

Baseline Data	
Characteristic	N = 16[†]
Demographics	Mean (%)
Female Sex	3 (19%)
Age (years)	66 (55, 75)
Medical Admission	7 (44%)
Laboratory Tests and Risk Score	Median (IQR)
Admission WBC ($\times 10^9/L$)	15.7 (8.6, 19.4)
Admission CRP (mg/dL)	136 (20, 254)
Admission Creatinine ($\mu\text{mol/L}$)	80 (63, 123)
Admission Lactate (mmol/L)	1.5 (0.9, 2.0)
Candida Score	2 (2, 4)
CRP on Day of Diagnosis (mg/dL)	130 (99, 280)
Antifungal Choice	Mean (%)
Caspofungin Used	4 (31%)
Fluconazole Used	6 (46%)
Amphotericin B Used	2 (15%)
Risk Factors	Mean (%)
Diabetic	5 (31%)
Diagnosis of Pancreatitis	2 (12%)
Parenteral Nutrition	7 (44%)
Renal Replacement Therapy	3 (19%)
Central Venous Catheter Present	15 (94%)
On Immunosuppressants	4 (25%)
On Broad Spectrum Antibiotics	16 (100%)
On Antifungals Pre-Diagnosis	2 (12%)
Neutropaenic (WBC $< 1 \times 10^9/L$)	2 (12%)
Fevers Despite Antibiotics ($> 38^\circ\text{C}$)	5 (31%)
Investigations Performed	Mean (%)
Fundoscopy	5 (45%)
Transthoracic Echocardiogram	8 (50%)
Transoesophageal Echocardiogram	0 (0%)
Serial Blood Cultures	11 (69%)
Species of Candida Grown	Mean (%)
Candida Albicans Grown	10 (62%)
Candida Glabrata Grown	4 (25%)
Candida Dubliniensis Grown	1 (6.2%)
Candida Tropicalis Grown	1 (6.2%)
Outcomes	Mean (%); Median (Q1, Q3)
In-Hospital Mortality	8 (53%)
ICU Length of Stay (days)	12 (4, 28)
Hospital Length of Stay (days)	18 (16, 35)

References

1. Bassetti et al. Bench to bedside review: Therapeutic management of invasive candidiasis in the intensive care unit. *Critical Care*. 2010. 14 (6):244–256.
2. Bassetti et al. Incidence and outcome of invasive candidiasis in intensive care units (ICUs) in Europe: Results of the EUCANDICU project. *Critical Care*. 2019. 23 (1):219–226.
3. Martin-Loeches et al. ESICM/ESCMID task force on practical management of invasive candidiasis in critically ill patients. *Intensive Care Med*. 2019. 45 (6):789–805.
4. León et al. A bedside scoring system (“Candida score”) for early antifungal treatment in nonneutropenic critically ill patients with Candida colonization*. *Critical Care Medicine*. 2006. 34 (3):730–737.

Topic: Infections and prevention

001347

The potential role of Neutrophil-Reactive Intensity (NEUT-RI) in ICU diagnosis of sepsis: a retrospective critical illness cohort study

E. M. A. Mantovani¹, S. Pastori², V. Roccaforte², R. Panella², A. Pezzi¹, M. Gotti¹, P. Formenti¹, G. Sabbatini¹

¹Anaesthesia and Intensive Care Medicine, Bassini Hospital, Cinisello Balsamo, Italy; ²Clinical Laboratory Medicine, Bassini Hospital, Cinisello Balsamo, Italy

Correspondence: E.M.A. Mantovani

Intensive Care Medicine Experimental 2023, **11 (Suppl 1)**:001347

Introduction: The diagnosis of sepsis is often difficult and belated, substantially increasing the mortality in affected patients. Its early identification allows to choose the most appropriate therapies in the shortest time, improving patients’ outcome and eventually their survival.

Objectives: Since neutrophil activation is an indicator of early innate immune response, the aim of the study was to evaluate the role of Neutrophil-Reactive Intensity (NEUT-RI), which is an indicator of their metabolic activity, in the diagnosis of sepsis.

Methods: Data from 96 patients consecutively admitted to the ICU were retrospectively analyzed (46 septic and 50 non-septic patients). Septic patients were further divided between “complicated sepsis” and “non complicated sepsis” according to the severity of the illness. Patients were subsequently classified according to renal function.

Results: For the diagnosis of sepsis, NEUT-RI showed an AUC of 0,826 and a better negative predictive value than Procalcitonin and C-Reactive Protein (87,4% vs 83,9% and 86,6%, $p < 0,001$). Unlike PCT and CRP, NEUT-RI seemed not positively influenced by renal failure ($p = 0,212$). No significant difference in NEUT-RI values was observed according to the severity of sepsis ($p = 0,075$).

Conclusions: In conclusion, the increase in NEUT-RI values could be useful in the early ruling out of sepsis, and it does not appear to be influenced by renal failure. However, NEUT-RI has not proved efficient in discriminating the severity of sepsis at the time of admission. Larger prospective studies are needed to confirm these results.

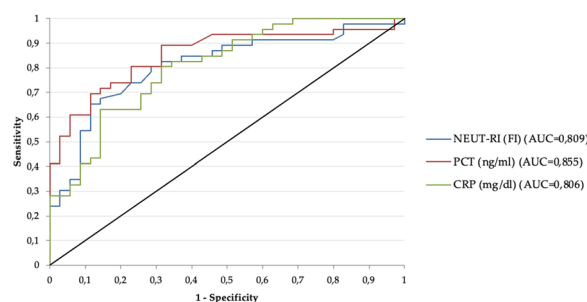

The Figure shows the area under the Receiver-operating characteristic (ROC) curve for the distinction of inflammatory parameters for detection of sepsis. The areas under the ROC curves are as follows: NEUT-RI (blue

line): 0.80 [95%CI 0.74–0.91]; PCT (red line): 0.85 [95%CI 0.77–0.93]; CRP (green line): 0.80 [95%CI 0.77–0.93]; $p < 0.001$; AUC = Area Under the Curve.

Table 1. Baseline characteristics of the study population, divided by diagnosis of sepsis at ICU admission.

	Septic (n 46)	Non septic (n 50)	P
Age (years)	70 [46; 87]	68 [29; 90]	0.172
Male sex, N (%)	24 (56)	28 (58)	0.992
Complicated sepsis N (%)	25 (54.3%)		
Diagnosis:			
Pneumonia, N (%)	23 (50)		
Peritonitis, N (%)	12 (26)		
Urinary tract infection, N (%)	11 (23)		
Coma		11 (22)	
Other neurologic disorders		14 (28)	
Acute pulmonary edema		7 (14)	
Post-surgery monitoring		18 (36)	
SOFA score at ICU admission (points)	7 [4; 8]	6 [4; 8]	0.951
AKI at ICU admission, n (%)	28 (60.1)	21 (42)	0.245
Plasmatic creatinine (mg/dl)	3.51	2.04	<0.001
NEUT-RI (FI)	60.3 [41,112]	49.9 [41.5,63.1]	<0.001
PCT (ng/ml)	56.71 [0.2,250]	2.51 [0.2,56.2]	<0.001
CRP (mg/dl)	17.89 [2.1,42.5]	6.43 [0.1,22.2]	<0.001

SOFA = Sequential Organ Failure Assessment; ICU = Intensive Care Unit; AKI = Acute kidney Injury as defined by KDIGO guidelines; PCT = Procalcitonin; CRP = C-Reactive Protein.

Table 2. Inflammatory parameters in septic vs non-septic patients, and in patients diagnosed of AKI.

	No-AKI	n	AKI	n	P
NEUT-RI (septic)	61.83 [47,1-112] FI	18	59.24 [41-75,2] FI	28	0.212
NEUT-RI (non-septic)	50.35 [41,5-63,1] FI	29	49.39 [44,2-56,4] FI	21	0.589
PCT (septic)	31.03 [0,22-250] ng/mL	18	73.22 [0,23-250] ng/mL	28	0.002
PCT (non-septic)	0.69 [0,2-3] ng/mL	20	5.08 [0,32-28,61] ng/mL	15	0.016
CRP (septic)	13.74 [2,09-37,26] mg/dL	18	20.56 [2,51-42,5] mg/dL	28	0.026
CRP (non-septic)	5.51 [0,13-22,25] mg/dL	24	7.72 [0,7-18,42] mg/dL	17	0.131

AKI = Acute kidney Injury as defined by KDIGO guidelines; No-AKI: normal renal function.

Table 3. Accuracy (AUC), cut-off, sensitivity and specificity of inflammatory parameters for detection of sepsis.

	AUROC (95% CI)	Cut-off	Youden's index	Sens (95% CI)	Spec (95% CI)	PPV	NPV
NEUT-RI	0.826 [0,741-0,912]	≥51,9 FI	0,56	80,4% [68,9-91,8]	76% [64,2-87,8]	65,2%	87,4%
PCT	0,855 [0,771-0,938]	≥2,16 ng/mL	0,58	69,6% [56,3-82,9]	88,6% [78-99,1]	77,3%	83,9%
CRP	0,822 [0,736-0,908]	≥6,91 mg/dL	0,51	80,4% [68,9-91,9]	70,7% [56,8-84,7]	60,6%	86,6%

AUROC = Area Under the ROC curve; Sens = Sensitivity; Spec = Specificity; PPV = Positive Predictive Value; NPV = Negative Predictive Value.

Topic: Sepsis

001348

Prognostic accuracy of head computed tomography for prediction of functional outcome after out-of-hospital cardiac arrest, the prospective TTM2-CT-substudy

M. Lang¹, C. Leithner², M. Scheel³, M. Kenda², T. Cronberg⁴, J. Düring⁵, C. Rylander⁶, M. Annborn⁷, J. Dankiewicz⁸, N. Deye⁹, T. Halliday¹⁰, J. Lascarrou¹¹, M. Thomas¹², P. McGuigan¹³, M. Morgan¹⁴, M. Thomas¹², S.

Ullén¹⁵, J. Undén¹⁶, M. Wheeler¹⁷, J. Martola¹⁸, M. Johnsson¹⁹, S. Owen²⁰, N. D. Nielsen²¹, M. Moseby-Knappe²²

¹Department of Radiology, Helsingborg Hospital, Department of Clinical Sciences Lund, Lund University, Lund, Sweden; ²Department of Neurology and Experimental Neurology, Charité-Universitätsmedizin Berlin, Berlin, Germany; ³Department of Neuroradiology, Charité-Universitätsmedizin Berlin, Berlin, Germany; ⁴Department of clinical sciences, neurology, Lund University, Lund, Sweden; ⁵Department of clinical sciences, intensive and perioperative care, Skåne University Hospital, SUS, Malmö, Malmö, Sweden; ⁶Anesthesiology and intensive care medicine, Sahlgrenska University Hospital, Gothenburg, Sweden; ⁷Department of anaesthesia and intensive care, Helsingborgs hospital, Helsingborg, Sweden; ⁸Department of clinical sciences Lund, neurology, Lund University, Skåne University Hospital, Sweden; ⁹Medical and toxicology intensive care unit, Hospital Lariboisière, Paris, France; ¹⁰Department of Operation and Intensive Care, Linköping University Hospital, Linköping, Sweden; ¹¹Mir, C.H.U. de Nantes, Nantes, France; ¹²Intensive Care Unit, University Hospitals Bristol and Weston, Bristol, United Kingdom; ¹³Regional Intensive Care Unit, < span Belfast, United Kingdom; ¹⁴Anaesthetic department, Cardiff & Vale University Health Board, Cardiff, United Kingdom; ¹⁵Clinical Studies Sweden-Forum South, Skåne University Hospital Lund, Lund, Sweden; ¹⁶Department of clinical sciences malmö, dept. operation and intensive care, Lund University, Lund, Sweden; ¹⁷Department of radiology, Cardiff & Vale University Health Board, Cardiff, United Kingdom; ¹⁸HUS Medical Imaging Center, University of Helsinki, Helsinki, Finland; ¹⁹Department of radiology, Helsingborg Hospital, Helsingborg, Sweden; ²⁰Department of radiology, Cardiff & Vale University Health Board, Cardiff, United Kingdom; ²¹Department of clinical sciences lund, anaesthesia and intensive care, Helsingborg Hospital, Helsingborg, Sweden; ²²Department of Clinical Sciences, Section of Neurology, Lund University, Lund, Sweden

Correspondence: M. Lang

Intensive Care Medicine Experimental 2023, 11 (Suppl 1):001348

Introduction: Head computed tomography (CT) is a guideline recommended method to predict functional outcome after cardiac arrest (CA), but standardized criteria for evaluation are lacking.

Objectives: The aim of the current study is to validate a standardized approach to radiological evaluations of HIE on CT for prediction of functional outcome in comatose CA patients.

Methods: This is a prospective observational international multicentre substudy of the Targeted Hypothermia versus Targeted Normothermia after out-of-hospital cardiac arrest (TTM2) trial. Patients still unconscious 48 h post-arrest at 13 participating hospitals were routinely examined with CT. Prior to the current study's initiation, a protocol article was published. Original images were evaluated by eight examiners from four countries blinded to clinical data using a standardized protocol. Qualitative assessment included evaluation of absence/presence of "severe HIE". Radiodensities were quantified in pre-specified regions of interest for calculation of grey-white matter ratios (GWR) at the basal ganglia level. Functional outcome was dichotomized into good (modified Rankin Scale 0–3) and poor (modified Rankin Scale 4–6) at six months post-arrest. Prognostic accuracies for good and poor outcome will be presented as sensitivities and specificities with 95% confidence intervals (using pre-specified cut-offs for quantitative analysis), descriptive statistics (Area Under the Receiver Operating Characteristics Curve), inter- and intra-rater reliabilities according to STARD guidelines.

The TTM2 trial and the TTM2 CT substudy are registered at ClinicalTrials.gov NCT02908308 and NCT03913065.

Results: Of the 473 patients included in the CT-substudy 157 (33%) had a CT > 48 h ≤ 7 days post arrest. 20 CTs were excluded; artefacts (n = 2), infarction (n = 5), intracranial haemorrhage (n = 3), not fulfilling technical requirements (n = 10). Included CTs have now been evaluated and the data is planned to be analyzed in the beginning of May 2023.

Conclusions: The results from this prospective trial will validate a standardized approach to radiological evaluations of HIE on CT for prediction of functional outcome in comatose CA patients.

Checklist - SOP for qualitative analysis in the TTM2 CT-Sub study
 Patient: _____ Rater: _____

Prerequisites

Artifacts precluding analysis	<input type="checkbox"/> yes	<input type="checkbox"/> no
Brain diseases precluding analysis	<input type="checkbox"/> yes	<input type="checkbox"/> no
Residual contrast agent visible	<input type="checkbox"/> yes	<input type="checkbox"/> no

Qualitative Analysis

Start using standard brain window and then adapt to optimize visibility of grey-white matter differentiation. Evaluate axial images at these 4 different levels. Consider the best grey-white-differentiation, best visibility of sulci

1 - Brain stem + Cerebellum

Effacement of CSF spaces	<input type="checkbox"/> yes	<input type="checkbox"/> no
Pseudo-SAH	<input type="checkbox"/> yes	<input type="checkbox"/> no
White Cerebellum Sign	<input type="checkbox"/> yes	<input type="checkbox"/> no

2 - Basal ganglia

Bilateral loss of grey-white distinction	<input type="checkbox"/> yes	<input type="checkbox"/> no
Bilateral sulcal effacement	<input type="checkbox"/> yes	<input type="checkbox"/> no
Reversal sign	<input type="checkbox"/> yes	<input type="checkbox"/> no

3 - Frontoparietal cortex, corona radiata level

Bilateral loss of grey-white distinction	<input type="checkbox"/> yes	<input type="checkbox"/> no
Bilateral sulcal effacement	<input type="checkbox"/> yes	<input type="checkbox"/> no

4 - High convexity cortex

Bilateral loss of grey-white distinction	<input type="checkbox"/> yes	<input type="checkbox"/> no
Bilateral sulcal effacement	<input type="checkbox"/> yes	<input type="checkbox"/> no

Result of qualitative analysis

Definite severe HIE: complete or near complete loss of grey-white distinction in the basal ganglia and in the frontoparietal cortex with additional evidence of brain swelling/sulcal effacement. Consider patient age while evaluating.

- Definite signs of severe HIE
- No definite signs of severe HIE

In the clinical setting, would you have diagnosed severe HIE despite the fact that the current SOP's stated criteria for definitive severe HIE are not being met?

- yes
- no

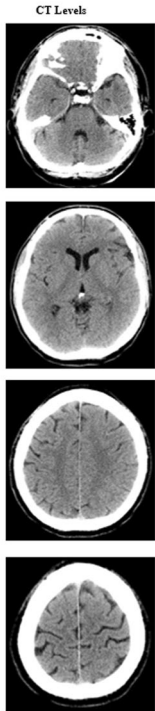

8 ROI basal ganglia GWR (8 BG)

All axial slices containing basal ganglia structures should be evaluated and ROIs placed bilaterally in the slice best representative of that target region. Thus, these 8 ROIs may be placed in different slices:

- Putamen
- Posterior limb of the internal capsule
- Head of the caudate nucleus
- Genu of the corpus callosum

In case of complete loss of grey-white distinction, use ventricles and midline as landmarks. In some patients with severe HIE radiodensity is similar in grey and white matter, exact location of target regions cannot always be determined. Nonetheless, ROIs should be placed and patients should not be excluded from GWR determination. The GWR of the 8 BG model will be calculated with the radiodensities measured at the ROI as follows:

$$8 \text{ ROI BG GWR} = \frac{CN_{right} + CN_{left} + PU_{right} + PU_{left}}{CC_{right} + CC_{left} + PIC_{right} + PIC_{left}}$$

SOP for the quantitative measurement of grey-white matter ratio. Placement of Regions of Interest (ROI) for determination of the grey-white matter ratio (GWR) at the basal ganglia level including 8 or 4 ROIs. 12,13 Yellow indicates white matter ROIs and blue indicates ROIs in the grey matter. All axial slices containing basal ganglia structures should be evaluated and ROIs placed bilaterally in the slice best representative of that target region. Thus, these 8 ROIs may be placed in different slices: 1) Putamen (PU); 2) Head of the caudate nucleus (CN); 3) Posterior limb of the internal capsule (PIC), and 4) Genu of the corpus callosum (CC). In case of complete loss of grey-white distinction, use ventricles and midline as landmarks. In some patients with severe HIE radiodensity is similar in grey and white matter, exact location of target regions cannot always be determined. Nonetheless, ROIs should be placed and patients should not be excluded from GWR determination. Crosses indicate the ROIs included in each grey-white matter ratio method: 8 BG (basal ganglia model), 4SI (simple model) and auto GWR (automated GWR determination).

References

1. Lang M, Leithner C, Scheel M, Kenda M, Cronberg T, During J, et al. Prognostic accuracy of head computed tomography for prediction of functional outcome after out-of-hospital cardiac arrest: Rationale and design of the prospective TTM2-CT-substudy. Resusc Plus. 2022;12:100,316.
2. Dankiewicz J, Cronberg T, Lilja G, Jakobsen JC, Levin H, Ullén S, et al. Hypothermia versus Normothermia after Out-of-Hospital Cardiac Arrest. N Engl J Med. 2021;384 (24):2283-94.
3. Sandroni C, D'Arrigo S, Cacciola S, Hoedemaekers CWE, Kamps MJA, Oddo M, et al. Prediction of poor neurological outcome in comatose survivors of cardiac arrest: a systematic review. Intensive Care Med. 2020;46 (10):1803-51.
4. Perkins GD, Graesner JT, Semeraro F, Olasveengen T, Soar J, Lott C, et al. European Resuscitation Council Guidelines 2021: Executive summary. Resuscitation. 2021;161:1-60.
5. The authors would like to thank Michael Borring from Skåne university hospital, Malmö for help with data collection and storage.
6. The TTM2 trial is supported by independent research grants from nonprofit or governmental agencies (the Swedish Research Council [Vetenskapsrådet], Swedish Heart-Lung Foundation, Stig and Ragna Gorthon Foundation, Knutsson Foundation, Laerdal Foundation, Hans-Gabriel and Alice Trolle-Wachtmeister Foundation for Medical Research, and Regional Research Support in Region Skåne) and by governmental funding of clinical research within the Swedish National Health Service. In addition, the CT substudy is supported by grants from the Bundy Academy, the Segerfalk Foundation and the Elsa Schmitz Foundation. MK is participant in the BIH Charité Junior Digital Clinician Scientist Program funded by the Charité—Universitätsmedizin Berlin, and the Berlin Institute of Health at Charité (BIH) and receives funding by the Laerdal Foundation for Cardiac Arrest Research.

SOP checklist for qualitative analysis. Standardised operating procedure checklist for qualitative radiological evaluation. CSF; cerebrospinal fluid, SAH; subarachnoid haemorrhage, HIE; hypoxic-ischaemic encephalopathy.

Checklist - SOP for quantitative analysis in the TTM2 CT-Sub study

Grey-white matter ratio (GWR) determination

Before starting GWR determination, perform the qualitative evaluation and enter the results into the electronic case report form.

GWR determination is carried out by manual placement of 8 circular ROIs with an area of 0.1cm².

Hounsfield Units should be displayed to ensure ROI placement in an area where radiodensity is representative of that target brain region. Focal hypo- or hyper densities, e.g. resulting from small vascular lesions, calcifications or noise must be avoided.



Figure 1 – ROI Placement for GWR determination at the basal ganglia level. Blue – grey matter ROIs, yellow – white matter ROIs. CC; genu of the corpus callosum, CN; head of the caudate nucleus, PU; putamen, and PIC; posterior limb of the internal capsule.

Topic: Cardiac arrest

001349

Years in organ donation: a single center retrospective analysis

J. Martins¹, M. Costa¹, R. Covas¹, L. Costa¹, A. Mesquita¹, J. E. Oliveira¹
¹Intensive care medicine department, Braga Public Hospital, Braga, Portugal

Correspondence: J. Martins

Intensive Care Medicine Experimental 2023, **11 (Suppl 1)**:001349

Introduction: Organ donation is an integral part of the intensive care unit activity and it provides valuable healthcare benefits for the population, it is therefore important to keep track and optimize recognition of potential organ donors as well as the correct management of the dead donor to improve outcomes of organ quantity and quality.

Objectives: The objectives of this study are to characterize the population of organ donors from 2013 until 2022 in an intensive care unit in a tertiary hospital in Portugal as well as to evaluate the impact of the COVID-19 pandemic on the number of organ donors and organs collected.

Methods: Data was retrospectively collected from an intensive care unit in the north of Portugal from the year 2013 to 2022 on the number and characteristics of brain dead donors as well as the organs collected.

Results: A total of 175 donors were identified and 579 organs collected averaging 3,30 organs harvested per donor. The mean age of the donors was 50,5 years, ranging from 17 to 74 years old. An upwards trend on the average age of donors and maximum age of donors was noted. The most frequent organ collected were kidneys (58%) followed by the liver (23%). The most frequent gender was male at 109 (62%) donors. A significant drop in the number of donors can be seen from 2019 until 2022 due to the COVID-19 pandemic.

Conclusions: A trend of increased number of organ donations, increased average age and increased maximum age was present until 2019, the COVID-19 pandemic had an important impact on the number of organ donations until 2022. The number of heart, lung and pancreas collected shows an upwards trend and 2022 was the highest average organs per donor in the 10 years analysis.

Number of donors and average age per year

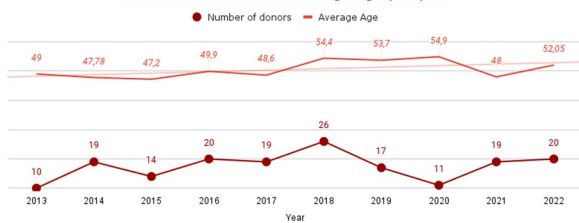

Number of donors and average age of donors per year.

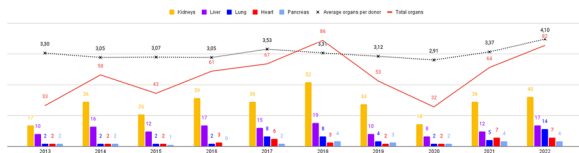

Total organs collected and type of organs collected per year and average organs per donor per year.

Topic: Brain death, organ donation and transplantation

001350

Correlation of the diaphragmatic function measured by ultrasound in comparison with the force negative inspiratory breath, as predictors of ventilatory weaning in critically ill patients in the Intensive Care Unit

J. C. C. Landeros Yañez¹, M. Ugarte²
¹Terapia intensiva neurologica, INNNMVS, Ciudad de México, Mexico;
²INNN Terapia intensiva Neurologica, INNNMVS, Ciudad de México, Mexico

Correspondence: J.C.C. Landeros Yañez

Intensive Care Medicine Experimental 2023, **11 (Suppl 1)**:001350

Introduction: Background. The diaphragm is the main respiratory muscle and its function in the critically ill patient favors the development of respiratory complications and thus an increase in the number of days on mechanical ventilation (Esper, 2016). Approximately 20% of patients under mechanical ventilation present difficulties in ventilatory weaning, it is considered that about 40% of the mechanical ventilation time is necessary for the ventilatory weaning process (Zhou, 2017). In patients under mechanical ventilation the diaphragm muscle can develop weakness and atrophy, which can lead to prolonged duration of ventilation (Rittayamai, 2019).

Objectives: To determine the diagnostic accuracy of correlates of diaphragm function measured by ultrasound compared to negative inspiratory force as predictors of ventilatory weaning in critically ill Intensive Care Unit patients.

Methods: A prospective, observational, longitudinal, comparative study of diagnostic accuracy was carried out in patients admitted to the intensive care unit. At admission, ultrasonographic measurement of diaphragmatic thickness was taken daily until the withdrawal of mechanical ventilation was evaluated under medical criteria and in compliance with the conditions for ventilatory weaning. The ultrasound was performed in M mode, taking measurements of the diaphragm with the linear transducer positioned on the chest wall at the anterior subcostal level. The measurements evaluated were diaphragmatic excursion and: the time to peak inspiratory amplitude of the diaphragm is defined as the time from the beginning of diaphragmatic contraction in inspiration, at the same time the negative inspiration force is evaluated, together with the usual predictors for ventilatory weaning. Once mechanical ventilation was withdrawn, the patient was monitored for 48 h and success in the withdrawal of mechanical ventilation was considered when the patient did not require mechanical ventilatory support during that period.

Results: During the period evaluated, 50 patients who met the inclusion criteria were included, 58% men (29/50), 42% women (21/50), with an age in years of 62 ± 2.8 SD. They had various conditions: surgical and non-surgical neurological 23 (46%), non-cardiothoracic post-surgical patient 11/50 (22%), infectious 9/50 (18%), cardiothoracic post-surgical patient 5/50 (10%) and primary respiratory disorders 2/50 (4%). The need for invasive mechanical ventilation in days was 4.6 ± 1.5 SD; spontaneous ventilatory test with T-piece was performed in 49/50 (98%) patients and CPAP/PS in 1/50 (2%) Table 1. Successful withdrawal of mechanical ventilation was reported in 44/50 (88%) patients, failure in 2 (3.3%) neurocritical patients, 2 (33.3%) patients with pathology of infectious origin, 1 (16.6%) non-cardiothoracic post-surgical patient and 1/50 (16.6%) cardiothoracic post-surgical patient.

Conclusions: Both diaphragmatic excursion and diaphragmatic peak inspiratory time, measured by ultrasound, present adequate sensitivity and specificity to predict successful extubation in the critically ill patient.

Table 1 (abstract 001350) .

Predicción de excursión diafragmática y fuerza inspiratoria negativa, como predictores de extubación exitosa ventilatorio en pacientes críticamente enfermos en la UCI Hospital Regional Puebla

Variable	AUC	IC95%	Punto de corte	κ p	Sensibilidad	Especificidad	VPP	VPN
EXCURSION DIAFRAGMATICA	0.83	0.55 a 1	1.09	0.009	97.7 %	83.3 %	97.7 %	83.3 %
TPIA	0.79	0.547 a 1	0.81	0.002	79.5%	83.3%	97.2%	35.7 %
NIF	0.48	0.79 a 0.9	-23.5	0.9	27.3%	33.3%	75 %	5.9 %
TOBIN	0.32	0.12 a 0.52	79	0.2	18%	66.7 %	80 %	10 %

Excursión diafragmática. Medición mediante modo-M de la excursión diafragmática durante una inspiración normal.

TPIA: el tiempo hasta amplitud inspiratoria pico del diafragma se define como el tiempo desde el inicio de la contracción diafragmática en inspiración y al finalizar en la espiración medido con el ultrasonido en modo M

NIF: El cálculo del valor de Fuerza Inspiratoria Negativa, denominada Presión Inspiratoria Máxima, nos proporciona un valor global de la fuerza de la musculatura respiratoria y la capacidad para toser y expectorar.

TOBIN/YANG. índice f/Vt, denominado índice de respiraciones rápidas y superficiales. Consiste en dividir la frecuencia respiratoria entre el volumen corriente en litros.

Se calculó una curva COR y consideramos significancia estadística un valor de <0.05

Topic: Acute respiratory failure and mechanical ventilation

001352

Alactic base excess in trauma patients: a simple clinical tool to identify the presence of unmeasured anions

B. Beatrice¹, A. Altomare², F. Zadek¹, M. Bulian¹, F. Baccoli¹, A. Bernareggi², SPB. Cioffi³, S. Cimbanassi⁴, O. Chiara⁴, T. Langer¹, R. Fumagalli⁵

¹Department of medicine and surgery, Università degli Studi di Milano Bicocca, Milano, Italy; ²University of Milan, Department of Medicine and Surgery, Milan, Italy; ³Department of Surgical Sciences, Sapienza University of Rome, Roma, Italy; ⁴ASST Grande Ospedale Metropolitano Niguarda, General Surgery and Trauma Team, Milan, Italy; ⁵Department of anesthesia and critical care, ASST Grande Ospedale Metropolitano Niguarda, Milano, Italy

Correspondence: B. Beatrice

Intensive Care Medicine Experimental 2023, 11 (Suppl 1):001352

Introduction: Trauma patients admitted to the emergency department are frequently characterized by metabolic acidosis, usually sustained by lactic acid and/or unmeasured anions (UA)1. The gold standard to identify and quantify the presence of UA is the Strong Ion Gap (SIG) computation, which, however, requires multiple simultaneous measurements, not always available at the bedside. Alactic Base Excess (aBE) has been recently introduced as a clinical surrogate for the identification of UA2. Indeed, aBE can be easily calculated as it is the sum of Standard Base Excess (sBE) and lactic acid. While aBE is a strong predictor of mortality in septic patients3, no data are currently available regarding trauma.

Objectives: This observational study aimed to identify the association between aBE and SIG in trauma patients and evaluate aBE as a possible marker of injury severity.

Methods: Trauma patients (Age > 13 years) admitted to the Trauma Center of the Niguarda Ca' Granda Hospital in Milan, Italy were enrolled. A blood gas analysis (RapidPoint 500e, Siemens Healthineers, Milano) was performed at admission. In addition, magnesium, albumin, and phosphate (Cobas c702; Roche Diagnostics GmbH, Mannheim, Germany) were measured. SIG, aBE, and Shock Index (heart rate/systolic blood pressure) were calculated as previously described 1,2,4. Demographic data, medical treatment, and clinical outcomes were recorded. The population was

divided in two groups according to the median value of calculated aBE. The clinical parameters of the two groups were compared.

Data are presented as mean ± SD or median [IQR]. Comparison between continuous variables was performed using a t-test or Mann-Whitney test, as appropriate. Categorical variables were compared using Fisher exact test. The association between SIG and aBE was assessed using linear regression analysis.

Results: From February to March 2023, 37 trauma patients were enrolled. Patients had a mean pH of 7.28 ± 0.17, SBE of -5.9 ± 6.5 mmol/L, SIG of 7.9 ± 4.2 mmol/L and aBE of -1.5 [-3.5, 1.5] mmol/L. Overall characteristics of the study population and comparison according to median (-1.5 mmol) aBE are reported in Table 1. Patients with lower aBE were more acidotic, had higher lactate concentrations, and lower BE. Moreover, they were characterized by higher shock index, number of transfused red blood cells, and in-hospital mortality. SIG and aBE were characterized by a negative linear association (r = -0.80, p < 0.001) (Figure 1).

Conclusions: In trauma patients, aBE seems a useful clinical tool to identify the presence of UA. Our data suggest that aBE might be a marker of injury severity.

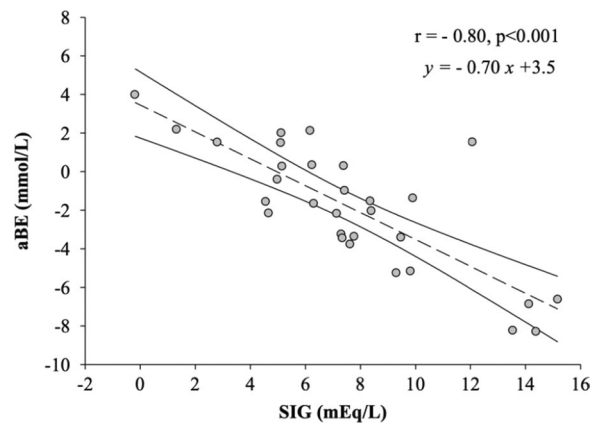

Figure 1 (abstract 001352) The association between SIG and aBE. Acronyms: aBE = alactic Base Excess, SIG = Strong Ion Gap

Table 1 (abstract 001352) Characteristics of the overall study population and divided by median alactic Base Excess, using the cut-off value of -1.5 mmol/L. Acronyms: SBE is Standard Base Excess, aBE is alactic Base Excess, SIG is Strong Ion Gap, RBC is Red Blood Cells%

Variable	Overall (n=37)	aBE < -1.5 (n=18)	aBE ≥ -1.5 (n=19)	P value
aBE (mmol/L)	-2 ± 4	-3.7 ± 3.5	0.84 ± 1.7	<0.001
Age (years)	35 [27, 56]	30 [19, 54]	39 [27, 56]	0.30
pH	7.28 ± 0.17	7.20 ± 0.21	7.35 ± 0.07	0.007
Lactate (mmol/L)	4.0 ± 3.3	5.1 ± 4.0	3.0 ± 1.9	0.04
Albumin (g/dL)	4.1 ± 0.9	3.7 ± 1.1	4.4 ± 0.5	0.04
Phosphate (mg/dL)	3.8 ± 2	4.5 ± 2.4	3.3 ± 0.9	0.08
Hemoglobin (g/dL)	13.4 ± 1.9	12.9 ± 2.3	13.9 ± 1.2	0.135
SBE (mmol/L)	-5.9 ± 6.5	-10.1 ± 6.6	-1.9 ± 2.8	<0.001
SIG (mmol/L)	7.9 ± 4.2	9.2 ± 3.4	6.6 ± 4.2	0.06
Shock Index	0.9 ± 0.5	1.1 ± 0.5	0.7 ± 0.3	0.005
Number of packed RBC in Shock Room (n)	0 [0, 2]	3 [0, 8]	0 [0, 0]	0.001
Hospital Mortality (n (%))	8 (28)	6 (54.5)	2 (11.1)	0.02
Time from event (minutes)	61 ± 15	59 ± 19	63 ± 15	0.59

References

1. 4. Vang M. et al, European Journal of Trauma and Emergency Surgery, 2022
2. 3. Cantos J. et al, J Crit Care, 2023

3. 2. Gattinoni L. et al, American Journal of Respiratory and Critical Care Medicine, 2019
4. The author (s) received no financial support for this article's research, authorship, and/or publication.
5. 1. Kaplan L.J. et al, Shock, 2008

Topic: Trauma

001353

Assessing the potential benefit of an extracorporeal membrane oxygenation (ECMO) service

S. Williamson¹, C. Baker², J. B. Simon¹, C. Weaver¹, S. Soni¹, R. Stumpfle¹, U. Waheed¹, B. Baharlo¹, P. Patel¹, L. Thakuria¹

¹Anaesthetics and Critical Care, Imperial College Healthcare NHS Trust, London, United Kingdom; ²Cardiovascular Medicine, Imperial College Healthcare NHS Trust, London, United Kingdom

Correspondence: S. Williamson

Intensive Care Medicine Experimental 2023, **11 (Suppl 1)**:001353

Introduction: Severity of cardiogenic shock (CS) is an important predictor of mortality. The European Society of Cardiology guidelines (1) suggest considering short term mechanical circulatory support (MCS) in the setting of severe cardiogenic shock. There is increasing utilisation of MCS for severe CS, including in cardiac arrest (CA), where it may be implemented alongside standard advanced life support. The 2020 ARREST trial (2) suggested significant survival benefit with extracorporeal cardiopulmonary resuscitation (ECPR).

Objectives: We assessed the number of patients with cardiogenic shock who may have benefited from short term MCS, in our tertiary cardiac centre, which is in the process of exploring the development of a veno-arterial extracorporeal membrane oxygenation (VA-ECMO) programme.

Methods: Using data collated from our Heart Attack Centre, we included patients who had out-of-hospital cardiac arrests (OOHCA), in-hospital cardiac arrests (IHCA) or were identified as having cardiogenic shock by the clinical team, between March 2021 to March 2022. The highest SCAI shock score (3) within 24 h of admission was retrospectively calculated to classify shock severity. Survival to discharge rates were obtained. Additionally, patients presenting with OOHCA were assessed against ARREST trial inclusion criteria.

Results: 83 Patients with cardiogenic shock were identified in this period. 45 patients were admitted following OOHCA, 28 after IHCA and a further 10 patients had cardiogenic shock without cardiac arrest. As demonstrated in Figure 1, the survival rate decreased with worsening SCAI shock score.

Table 1 (abstract 0001353) Survival to discharge of severe cardiogenic shock

Aetiology	Number of patients with SCAI D or E	Survival to discharge
IHCA	19	3/19 (15.8%)
OOHCA	23	12/23 (52%)
CS	5	3/5 (60%)
Total	47	18/47 (38%)

Mortality amongst 47 patients with severe shock (SCAI scores D and E) was 62%. The majority (89%) of patients with severe cardiogenic shock were cardiac arrests, 8 of which would have met ARREST trial criteria. Survival rates are shown in Table 1.

Conclusions: We identified 8 patients/year who met ARREST trial inclusion criteria. Assuming their stated 43% survival with ECPR, 3 additional patients may survive annually in our centre with emergency MCS. Whilst acknowledging that continuing work is required to further refine the selection criteria for MCS in shock,

these data suggest that our heart attack centre would achieve the minimum volume of cases for an ECMO centre as recommended by the Extracorporeal Life Support Organisation (6 cases/year), with the potential to save a small number of additional patients with shock.

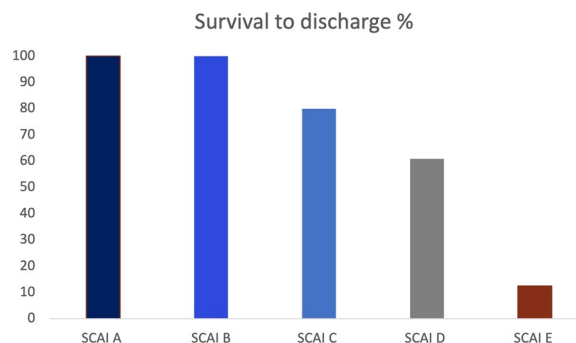

Figure 1 (abstract 001353) Survival to discharge of SCAI categories

References

1. (1) McDonagh TA et al. (2021). ESC Guidelines for the diagnosis and treatment of acute and chronic heart failure. *Eur Heart J*. 42:3599–3726. <https://doi.org/10.1093/eurheartj/ehab368>.
2. (2) Yannopoulos B et al. (2020). Advanced reperfusion strategies for patients with out-of-hospital cardiac arrest and refractory ventricular fibrillation (ARREST): a phase 2, single centre, open-label, randomised controlled trial. *Lancet*. 10265: 1807–1816. [https://doi.org/10.1016/S0140-6736\(20\)32338-2](https://doi.org/10.1016/S0140-6736(20)32338-2)
3. (3) Naidu SS et al. (2022). SCAI SHOCK Stage Classification Expert Consensus Update: A Review and Incorporation of Validation Studies. *J Am Coll Cardiol*. 79:933–946. <https://doi.org/10.1016/j.jacc.2022.01.018>

Topic: Acute respiratory failure and mechanical ventilation

001355

Overtaking, rear-end, and door crashes involving cyclists on segments in the UK: new insights

C. C. Chao¹, B. S. Wiratama², S. Wafaa³, P. Chih-Wei⁴

¹College of Public Health, Graduate Institute of Injury Prevention and Control, Taipei, Taiwan; ²Public Health and Nursing, Department of Biostatistics, Epidemiology, and Population Health, Faculty of Medicine, Gadjah Mada, Indonesia; ³Transport Research Institute, Edinburgh Napier University, Edinburgh, United Kingdom; ⁴Graduate Institute of Injury Prevention and Control, Taipei Medical University, Taipei, Taiwan

Correspondence: C.C. Chao

Intensive Care Medicine Experimental 2023, **11 (Suppl 1)**:001355

Introduction: Cycling is nowadays a crucial recreational activity and the most common transportation mode in the world. Numerous risk factors, such as road conditions, poor visibility, adverse weather, unlit conditions, and other geometric factors, contribute to bicycle crashes. While a vast majority of past studies focused on bicycle crashes that occurred at junctions, relatively little research has examined segment crashes.

Objectives: This study aims to examine the risk factor for three common crash types on segments: overtaking, rear-end, and door crashes.

Methods: By analysing British Stats19 accident data (1991–2020), our study evaluated bicycle overtaking, rear-end, and door crashes on segments. Independent variables of interest include age and sex of cyclist and crash partner, lighting condition, speed limit, crash partner's vehicle type, crash day, and crash time. Multivariate logistic regression models were employed to estimate adjusted odds ratios (AORs)

between potential risk factors. We further investigate joint effects of the variables with statistical significance.

Results: A total of 127,637 bicycle segment crashes were analyzed, of which 18,350 (14.4%) were overtaking crashes, 44,962 (35.2%) were rear-end crash, and 6,363 (5.0%) were door crash.

In overtaking crashes, bus/heavy good vehicles as crash partner was found to be a contributory factor (AORs=2.87; 95% CI=2.47–3.23). Other risk factors include elderly crash partners (AORs=2.01; 95% CI=1.94–2.09) and rural areas with speed limit \geq 40mph (AORs=2.34; 95% CI=2.16–2.32). For rear-end crashes, darkness and unlit conditions (AORs=1.49; 95% CI=1.40–1.57) and rural areas (AORs=1.32; 95% CI=1.28–1.35) increase crash risks. As for door crashes, urban areas with speed limits up to 30 mph (AORs=16.19; 95% CI=13.51–19.38) and taxi as crash partner (AORs=2.69; 95% CI=2.31–3.15) were risk factors.

Several joint effects were identified to be significant, including rural area and elderly crash partner (AORs=2.93; 95% CI=2.79–3.08) in overtaking crashes and darkness and rural area (AORs=2.15; 95% CI=2.01–2.31) for rear-end crashes.

Conclusions: Crucial risk factors include bus/heavy good vehicles, elderly drivers of crash partner, and rural areas for overtaking crashes; darkness with unlit conditions and rural areas for rear-end crashes; urban areas and taxi as crash partner for door crashes.

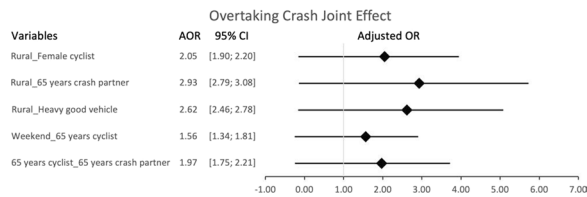

Joint effects in overtaking crash.

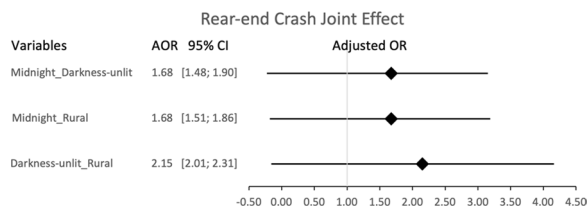

Joint effects in rear-end crash.

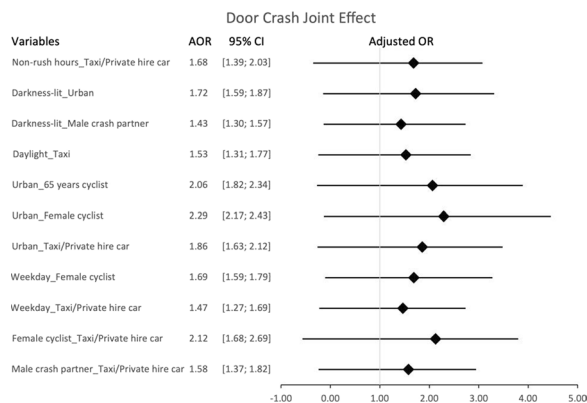

Joint effects in door crash.

References

- Pai, C. W. (2011). Overtaking, rear-end, and door crashes involving bicycles: An empirical investigation. *Accident Analysis & Prevention*, 43 (3), 1228–1235.
- Nil

Topic: Trauma

001356

Prior nutritional status and survival outcomes in patients with sepsis: a population-based cohort study

I. Hwang¹, S. In-Ae¹

¹Department of Anesthesia and Pain Medicine, Seoul National University Bundang Hospital, Seongnam-si, Republic of Korea

Correspondence: I. Hwang

Intensive Care Medicine Experimental 2023, 11 (Suppl 1):001356

Introduction: Nutritional status is an important factor affecting health-related outcomes in hospital-admitted patients. However, the association between nutritional status and survival outcomes in patients with sepsis remains unclear. We aimed to examine whether nutritional status is associated with mortality among patients with sepsis.

Methods: This population-based cohort study used data from a nationwide registration database. Adults who were diagnosed with sepsis from 2018 to 2020 and underwent standard health examinations before hospital admission for sepsis were included. Nutrition scores were evaluated using the Nutritional Lifestyle Assessment Tool in South Korea.

Results: Overall, 2,482 patients with sepsis were included in this study. The 90-day and 1-year mortality rates in patients with sepsis were 26.8% (664/2,482) and 34.2% (848/2,482), respectively. In the covariate-adjusted multivariable logistic regression model, a 1-point increase in nutrition score was associated with a decrease in 90-day mortality in patients with sepsis (odds ratio [OR]:0.98, 95% confidence interval [CI]: 0.97, 0.98; P=0.025). In the covariate-adjusted multivariable Cox regression model, a 1-point increase in nutrition score was associated with a decrease in 1-year mortality in patients with sepsis (HR: 0.99, 95% CI: 0.98, 0.99; P=0.035). In the subgroup analyses, a 1-point increase in the nutrition score was associated with decreased 90-day and 1-year mortality in the underweight group (<18.5 kg/m²).

Conclusions: Better nutritional status before hospital admission was associated with improvements in 90-day and 1-year mortality rates among patients with sepsis. This association was more evident in underweight patients (BMI <18.5 kg/m²). Our results suggest that adequate dietary intake, along with healthy eating habits, might be a protective factor against mortality among patients with sepsis.

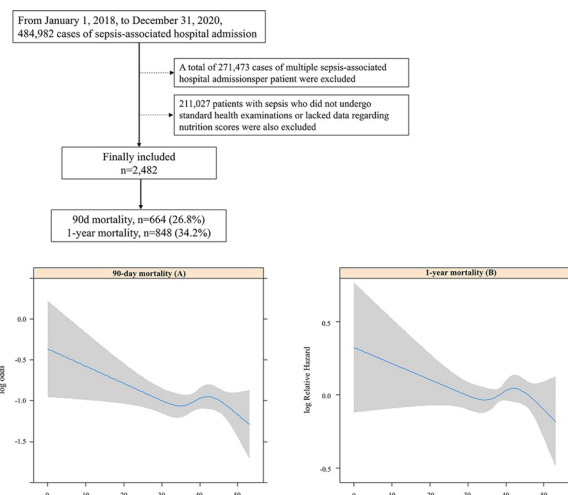

References

- Walsh NP. Nutrition and athlete immune health: new perspectives on an old paradigm. *Sports Medicine*. 2019;49 (Suppl 2):153–68.
- Kau AL, Ahern PP, Griffin NW, Goodman AL, Gordon JL. Human nutrition, the gut microbiome and the immune system. *Nature*. 2011;474 (7351):327–36.
- Robinson MK, Mogensen KM, Casey JD, McKane CK, Moromizato T, Rawn JD, et al. The relationship among obesity, nutritional status, and mortality in the critically ill. *Critical Care Medicine*. 2015;43 (1):87–100.
- Auiwattanakul S, Chittawatnanarat K, Chaiwat O, Morakul S, Kongsayreepong S, Ungpinitpong W, et al. Effects of nutrition factors on mortality and sepsis occurrence in a multicenter university-based surgical intensive care unit in Thailand (THAI-SICU study). *Nutrition*. 2019;58:94–9.
- Mogensen KM, Robinson MK, Casey JD, Gunasekera NS, Moromizato T, Rawn JD, et al. Nutritional Status and Mortality in the Critically Ill. *Crit Care Med*. 2015;43 (12):2605–15.
- Al-Dorzi HM, Arabi YM. Nutrition support for critically ill patients. *JPN J Parenter Enteral Nutr*. 2021;45 (S2):47–59.
- Dantes RB, Epstein L. Combatting sepsis: a public health perspective. *Clinical infectious diseases*. 2018;67 (8):1300–2.
- Rudd KE, Johnson SC, Agesa KM, Shackelford KA, Tsoi D, Kievlan DR, et al. Global, regional, and national sepsis incidence and mortality, 1990–2017: analysis for the Global Burden of Disease Study. *Lancet*. 2020;395 (10,219):200–11.
- Singer M, Deutschman CS, Seymour CW, Shankar-Hari M, Annane D, Bauer M, et al. The Third International Consensus Definitions for Sepsis and Septic Shock (Sepsis-3). *JAMA*. 2016;315 (8):801–10.
- none
- Abugroun A, Nayyar A, Abdel-Rahman M, Patel P. Impact of Malnutrition on Hospitalization Outcomes for Older Adults Admitted for Sepsis. *Am J Med*. 2021;134 (2):221–6 e1.

Topic: Sepsis

001358

Increased plasma calprotectin is associated with 90-day mortality and worse functional outcome in COVID-19 patients admitted to the intensive care unit

I. Didriksson¹, M. Spångfors², A. Frigyesi³, G. Lilja⁴, H. Friberg⁵, A. Schiopu⁶
¹Department of Anesthesia and Intensive Care Medicine, Skånes universitetssjukhus Malmö, Malmö, Sweden; ²Department of Anaesthesia and Intensive Care, Kristianstad Hospital, Kristianstad, Sweden; ³Department of Intensive and Perioperative Care, Skånes Universitetssjukhus Lund, Lund, Sweden; ⁴Department of Clinical Sciences Lund, Neurology, Lund University, Lund, Sweden; ⁵Department of Clinical Sciences, Intensive and Perioperative Care, Lund University, Lund, Sweden; ⁶Department of Translational Medicine, Lund University, Department of Internal Medicine, Skane University Hospital, Lund, Sweden

Correspondence: I. Didriksson

Intensive Care Medicine Experimental 2023, **11 (Suppl 1)**:001358

Introduction: Calprotectin is a pro-inflammatory alarmin and a biomarker of neutrophil activation. Previous studies found that increased calprotectin is associated with an unfavourable prognosis in unselected populations of COVID-19 patients.

Objectives: We aimed to assess calprotectin as a possible outcome predictor in COVID-19 patients admitted to the intensive care unit (ICU).

Methods: This prospective study included 498 COVID-19 patients admitted to six ICUs in Sweden between May 2020 and May 2021. Blood samples were collected on admission and day 7. Calprotectin was analysed after study completion. Functional outcome was assessed by the Glasgow Outcome Scale-Extended (GOSE). Univariable logistic regressions were performed for calprotectin on day 0 and day 7, dichotomised at the median value. Calprotectin dynamics were calculated as calprotectin change between days 0–7. The study outcomes were mortality and functional outcome at 3 months.

Results: Total 3-month mortality was 39%. Good functional outcome (GOSE > 6) among survivors at 3 months was 35%. Calprotectin

above median on day 7 was associated with increased mortality, OR 1.20 (95% CI 1.02–1.40), $p=0.025$ and fewer patients with GOSE > 6 OR = 0.75 (95% CI 0.60–0.94), $p=0.012$. Patients with calprotectin increase between days 0–7 had higher mortality compared to patients with calprotectin decrease ($p=0.045$). In addition, the need for invasive mechanical ventilation (IMV) and continuous renal replacement therapy (CRRT) was more prevalent in patients with day 7 calprotectin above median ($p=0.042$ and $p=0.007$, respectively).

Conclusions: High calprotectin on day 7 and increasing calprotectin after ICU admission are associated with an adverse prognosis in critically ill COVID-19 patients.

Study registration: ClinicalTrials.gov Identifier: NCT04974775.

References

- Cardiero G, Palma D, Vano M, Anastasio C, Pinchera B, Ferrandino M, et al. Calprotectin Levels and Neutrophil Count Are Prognostic Markers of Mortality in COVID-19 Patients. *Diagnostics (Basel)*. 2022;12 (10).
- AF was supported by governmental funding of clinical research within the Swedish national health service, 2019:YF0053.
- HF was supported by the Swedish national health service (ALF), Regional funding from Region Skåne, and the Swedish Heart–lung Foundation (grant nr 21,004,021 and 21,023,322).
- Udeh R, Advani S, de Guadiana Romualdo LG, Dolja-Gore X. Calprotectin, an Emerging Biomarker of Interest in COVID-19: A Systematic Review and Meta-Analysis. *J Clin Med*. 2021;10 (4).
- Silvin A, Chapuis N, Dunsmore G, Goubet AG, Dubuisson A, Derosa L, et al. Elevated Calprotectin and Abnormal Myeloid Cell Subsets Discriminate Severe from Mild COVID-19. *Cell*. 2020;182 (6):1401–18.e18.
- Shrivastava S, Chelluboina S, Jedge P, Doke P, Palkar S, Mishra AC, et al. Elevated Levels of Neutrophil Activated Proteins, Alpha-Defensins (DEFA1), Calprotectin (S100A8/A9) and Myeloperoxidase (MPO) Are Associated With Disease Severity in COVID-19 Patients. *Front Cell Infect Microbiol*. 2021;11:751,232.
- Shi H, Zuo Y, Yalavarthi S, Gockman K, Zuo M, Madison JA, et al. Neutrophil calprotectin identifies severe pulmonary disease in COVID-19. *J Leukoc Biol*. 2021;109 (1):67–72.
- Mahler M, Meroni PL, Infantino M, Buhler KA, Fritzier MJ. Circulating Calprotectin as a Biomarker of COVID-19 Severity. *Expert Rev Clin Immunol*. 2021;17 (5):431–43.
- Chen L, Long X, Xu Q, Tan J, Wang G, Cao Y, et al. Elevated serum levels of S100A8/A9 and HMGB1 at hospital admission are correlated with inferior clinical outcomes in COVID-19 patients. *Cell Mol Immunol*. 2020;17 (9):992–4.

Topic: Infections and prevention

001360

The impact of a dedicated critical care speech and language therapy service on multidisciplinary team management of patients with a tracheostomy

P. Day¹, B. Martin², D. McWilliams³

¹Speech and Language Therapy, University Hospital Coventry and Warwickshire, Coventry, United Kingdom; ²Speech and Language Therapy, University Hospital Coventry & Warwickshire, Coventry, United Kingdom; ³Centre for Care Excellence, University Hospital Coventry & Warwickshire, Coventry, United Kingdom

Correspondence: P. Day

Intensive Care Medicine Experimental 2023, **11 (Suppl 1)**:001360

Introduction: The role of Speech and Language Therapists (SLT) within critical care has been increasingly recognised, with national guidance in the United Kingdom recommending all patients with a tracheostomy are seen by a SLT [1,2]. Involvement of SLT for patients with a tracheostomy may reduce the time to cuff deflation and speaking valve use, facilitate weaning from mechanical ventilation, assist with verbal communication and return to oral intake [3]. In April 2022 a newly created, dedicated SLT service was created within Critical Care at University Hospital Coventry and Warwickshire.

Objectives: To evaluate whether the introduction of a dedicated SLT for Critical Care improved outcomes for patients with a tracheostomy.

Methods: All patients admitted to a neuro-trauma critical care unit, undergoing tracheostomy and surviving to Critical Care discharge were included in the analysis. Data was collected prospectively from 1st April 2022 until 31st December 2022 and compared to a historic baseline for the same period. The primary outcome was the proportion of patients decannulated within Critical Care; secondary outcomes included time from tracheostomy insertion to decannulation.

Results: 75 patients met the inclusion criteria and were seen by the SLT team during the evaluation period and compared to 104 patients in the baseline group. Time taken to tracheostomy insertion for the intervention and baseline groups was 14.8 and 14.1 days respectively. The introduction of the SLT team was associated with significant increase in the proportion of patients decannulated within critical care (65% vs 45%, $p < 0.001$), with non-significant but potentially clinically important reductions also seen in time to decannulation (21.4 vs 24.1 days) and critical care length of stay (40.1 vs 48.3 days). Whilst there was no baseline for comparison, the 2022 data showed 61% of patients had oral intake established and 78% were able to communicate verbally before Critical Care discharge.

Conclusions: The introduction of a dedicated SLT service as part of the established multi-disciplinary team was associated with an increased rate of decannulation within Critical Care. Whilst potentially important clinical reductions were observed for both time to decannulation and critical care length of stay, these were not statistically significant so should be interpreted with caution.

References

3. McGrath BA, Wallace S, Lynch J, et al. (2020) Improving tracheostomy care in the United Kingdom: results of a guided quality improvement programme in 20 diverse hospitals. *British Journal of Anaesthesia* 125 (1) ppE119-E129.
1. The Guidelines for the Provision of Intensive Care Services (GPICS) v2.1 (2022) The Faculty of Intensive Care Medicine / Intensive Care Society.
2. National Confidential Enquiry into Patient Outcome and Death: On the Right Trach? (NCEPOD, 2014)

Topic: Acute respiratory failure and mechanical ventilation

001361

MITOHEAT: temperature impacts ex-vivo function of mitochondria from experimental sepsis

J. Falconer¹, W. Pisciotta¹, E. Palmer¹, J. Harris¹, M. Duchen², M. Singer¹, R. Tidswell¹

¹Bloomsbury Institute of Intensive Care Medicine, Division of Medicine, University College London, London, United Kingdom; ²Department of Cell and Developmental Biology, Division of Biosciences, UCL, University College London, London, United Kingdom

Correspondence: J. Falconer

Intensive Care Medicine Experimental 2023, **11** (Suppl 1):001361

Introduction: Sepsis is the dysregulated host response to infection leading to organ dysfunction and death. In patients with sepsis, fever and external warming are associated with survival, hypothermia and cooling are associated with mortality. It is unclear why. Mitochondrial function is implicated in sepsis mortality yet can be manipulated by temperature in healthy tissue. We used muscle tissue from a septic rat model to investigate whether temperature effects sepsis-induced mitochondrial dysfunction and therefore may contribute to the protective effect of heat.

Methods: Rats received either sham ($n=5$) or septic ($n=5$) insult using our established faecal-peritonitis rat model of sepsis. At 6 h organ failure was confirmed by echocardiography and the soleus was removed for ex-vivo studies. Baseline, complex 1 (CI) and complex 2 (CII) stimulated electron transport chain function was measured using High Resolution Respirometry in permeabilised soleus myofibres at 34°C, 37°C and 40°C.

Results: Sepsis caused organ dysfunction demonstrated by reduced cardiac velocity time integral. CII stimulated oxygen consumption was

reduced in septic animals compared to sham, but was not statistically significant. In healthy myofibres oxygen consumption following CII stimulation was higher at 40°C vs 34°C ($p=0.006$). In septic myofibres, oxygen consumption was higher at 40°C following both CI and CII stimulation compared to 34°C ($p=0.033$ and $p=0.025$, respectively).

Conclusions: In ex-vivo studies, external temperature manipulation impacts both healthy and septic mitochondrial function in soleus muscle. Febrile-range temperature, either endogenous or exogenous, may protect or recover sepsis-induced mitochondrial dysfunction. Further studies are ongoing to confirm this and identify a mechanism.

References

- Drewry, Anne M. Mohr, Nicholas. Ablordeeppey, Enyo. Hotchkiss, R. Therapeutic Hyperthermia Is Associated With Improved Survival in Afebrile Critically Ill Patients With Sepsis: A Pilot Randomized Trial. (2022)
- Rumbus, Z. et al. Fever Is Associated with Reduced, Hypothermia with Increased Mortality in Septic Patients: A Meta-Analysis of Clinical Trials. 1–15 (2017)
- Singer, M. et al. The Third International Consensus Definitions for Sepsis and Septic Shock (Sepsis-3). *Jama* 315, 801–10 (2016)
- Brealey, D. et al. Association between mitochondrial dysfunction and severity and outcome of septic shock. *Lancet* (2002)
- Medical Research Council

Topic: Sepsis

001362

Rate of solid tumour progression to metastatic disease following critical illness: a retrospective cohort study of UK biobank participants

R. Keith¹, M. Shaw², J. McPeake¹, M. David¹, K. Puxty³

¹School of Medicine, University of Glasgow, Glasgow, United Kingdom;

²Academic Unit of Anaesthesia, Critical Care and Peri-operative Medicine, University of Glasgow, Glasgow, United Kingdom; ³Intensive Care Unit, Glasgow Royal Infirmary, Glasgow, United Kingdom

Correspondence: R. Keith

Intensive Care Medicine Experimental 2023, **11** (Suppl 1):001362

Introduction: One in twenty patients with a solid tumour require ICU admission within 2 years.[1] Critical illness has been demonstrated to significantly impact cancer survivors' long-term health, possibly through disturbance of oncologic treatment administration. Furthermore, the dysregulated inflammatory response experienced during critical illness may negatively impact disease progression.

Objectives: This study aimed to determine the impact of a critical care admission on the rate of solid tumour progression to metastatic disease.

Methods: We conducted a retrospective observational study using UK Biobank data. Adult patients with a solid tumour without metastasis were identified. Patients who survived a critical care admission within two years of diagnosis were compared to a hospitalised cohort. Kaplan–Meier survival analysis and Cox Proportional Hazards assessed differences in rate of metastatic disease, death, and progression-free survival.

Results: Data from 1854 participants with a solid tumour who survived a hospitalisation were analysed: 453 (24.4%) were critical care survivors, and 1401 (75.6%) were hospital survivors. There was a higher rate of metastatic progression in the critical care cohort at one (15% vs. 8%, $p < 0.001$), five (25% vs. 14%, $p < 0.001$), and ten years (26% vs. 16%, $p < 0.001$) (Figure 1).

This was confirmed on adjusted multivariable analysis (HR, 1.46; CI, 1.10–1.95; $p=0.01$). After adjustment for confounders, critical care survivors had a higher mortality rate (HR, 1.42; CI, 1.22–1.65; $p < 0.001$) and poorer progression-free survival (HR, 1.69; CI, 1.31–2.18; $p < 0.001$).

Conclusions: This cohort study demonstrated that the rate of solid tumour progression to metastasis is higher in critical care survivors compared to a hospitalised cohort.

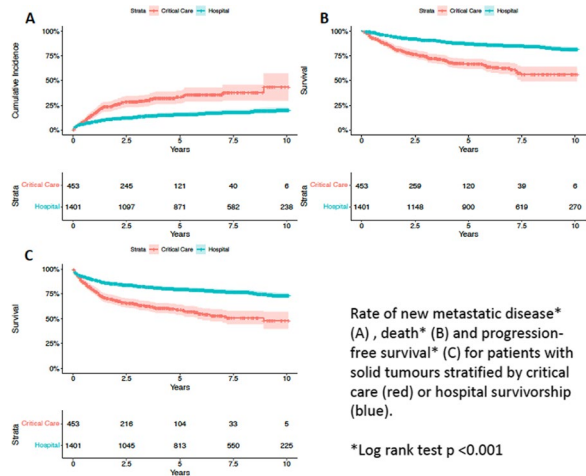

Figure 1 (abstract 001362) Rate of new metastatic disease (A), death (B) and progression-free survival (C) for patients with solid tumours stratified by critical care or hospital survivorship

References

1. Puxty K, McLoone P, Quasim T, Sloan B, Kinsella J, Morrison DS. Risk of Critical Illness Among Patients With Solid Cancers: A Population-Based Observational Study. *JAMA Oncol.* 2015;1 (8):1078–1085.
2. John Snow Award

Topic: Haematologic-oncologic issues in the ICU

001364

Doctors' perceptions of intensive care patients' one-year prognoses compared to realistic prognoses

L. Pietiläinen¹, J. Hästbacka², S. Bendel¹, M. Bäcklund³, M. Reinikainen⁴
¹Department of Anaesthesiology and Intensive Care, Kuopio University Hospital, Kuopio, Finland; ²Department of Anaesthesiology and Intensive Care, Tampere University Hospital and University of Tampere, Tampere, Finland; ³Division of Intensive Care Medicine, Helsinki University Hospital, Helsinki, Finland; ⁴Department of Anaesthesiology and Intensive Care, Kuopio University Hospital and University of Eastern Finland, Kuopio, Finland

Correspondence: M. Reinikainen

Intensive Care Medicine Experimental 2023, **11** (Suppl 1):001364

Introduction: It is unknown whether doctors have realistic perceptions of critically ill patients' prognoses.

Objectives: To survey the ability of Finnish anaesthesiologists to estimate the probability of one-year survival of intensive care patients based on data available at the beginning of intensive care.

Methods: We sent a survey by e-mail to members of the Finnish Society of Anaesthesiologists ($n = 1249$, of whom an active e-mail address was available for 887). The survey presented a brief description of 12 fictional but real-life-based patient cases. For comparable patients treated in the intensive care unit (ICU), the true one-year survival ranged from 18.2% to 100%, according to data from the national ICU quality registry. For each case, we asked the respondent to estimate the likelihood of the patient being alive one year after ICU admission, choosing from the alternatives 5%, 10–90% in 10% intervals and 95%. Based on the difference between the estimate and the registry data-based realistic probability, we categorised the estimates as perfect (within 10 percentage points of the realistic probability), good (within 20 percentage points) and poor (difference over 20 percentage points).

Results: We received 210 responses and totally $210 \times 12 = 2520$ estimates. Of the respondents, 43 (20.5%) were specialists working full-time in the ICU, 81 (38.6%) were specialists working occasionally in the ICU, 47 (22.4%) were specialists not working in the ICU and 39 (18.6%) were doctors in training. Of all estimates, 1083 (43.0%) were perfect, 645 (25.6%) were good, and 792 (31.4%) were poor, with 612 (24.3%) underestimating and 180 (7.1%) overestimating the likelihood of survival. The median estimate was perfect in eight cases, good in one case and poor in three cases, underestimating the likelihood of survival in all three cases. At best, for a middle-aged patient with diabetic ketoacidosis, 76.7% of responses were perfect (Figure 1, left panel). At worst, for an 80–84-year-old patient with need for vasopressor support after emergency coronary artery bypass grafting, 63.3% of responses were poor, severely underestimating the prognosis (Figure 1, right panel). Estimates that were poor made up 26.2% of the estimates made by specialists working full-time in the ICU (with 21.1% underestimating and 5.1% overestimating the likelihood of survival), 29.8% of those made by specialists working occasionally in the ICU (with 23.2% underestimating and 6.6% overestimating the likelihood of survival), 39.0% of those made by specialists not working in the ICU (with 30.0% underestimating and 9.0% overestimating the likelihood of survival) and 31.4% of the estimates made by doctors in training (with 23.1% underestimating and 8.3% overestimating the likelihood of survival).

Conclusions: Underestimating an intensive care patient's long-term prognosis is common. More education about critically ill patients' prognoses is needed.

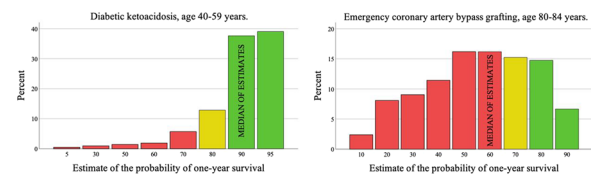

Figure 1 (abstract 001364) Distribution of estimates. The realistic likelihood of one-year survival is between the green bars

References

1. Funding for this study was provided by the governmental research funding of Kuopio University Hospital, Kuopio, Finland.

Topic: Critical care organisation, quality management, information systems, outcomes

001367

Relationship between asynchronies and sleep architecture in mechanically ventilated patients: an observational cohort study

C. Subira¹, M. Battle¹, C. Moreno¹, C. Gijón¹, S. Cano¹, Y. Tua¹, H. Baquerizo¹, P. Perelló¹, R. Fernandez¹

¹Unitat de Cures Intensives, Althaia, Xarxa Assistencial Universitària de Manresa, Manresa, Spain

Correspondence: C. Subira

Intensive Care Medicine Experimental 2023, **11** (Suppl 1):001367

Introduction: Sleep quality in ICU patients is poor. The Odds Ratio Product (ORP) is a continuous index from 0 to 2.5 based on EEG that allows a new sleep classification. The sleep patterns or ORP-Sleep architecture types can be described according to the % of total recording time (TRT) during the sleep study spent in deep sleep ($ORP < 0.5$) and the % of TRT in full wakefulness ($ORP > 2.25$). Asynchronies during MV are common and might be related to the level of sedation, but the relationships between sleep and asynchronies during MV in ICU are unknown.

Objectives: To describe the night sleep patterns using ORP and its relationship with the amount and type of asynchronies in a cohort of mechanically ventilated patients.

Methods: Prospective observational study in a single ICU from a University Hospital. A single Sleep study using Prodigy® was performed in a relatively stable phase after ICU admission, simultaneously the waveform from the ventilator were recorded using BetterCare® to detect asynchronies.

Results: 42 patients were included in the final analysis after excluding those patients with lost signals from EEG or ventilator: Age 64 yo (54–76), Females 29%, APACHE II at admission 9 (6–14). During the sleep study: level of sedation RASS -5 (-3 to -5), previous duration of MV was 3 days (2–4.75), most patients were on Volume control ventilation (68%) or Pressure Support Ventilation (19%). The use of sedatives was propofol (54%), midazolam (32%) and dexmedetomidine (12%). Almost all patients were with fentanyl infusion (85%). The amount of deep sleep was 41% “little”, 20% “normal” and 39% “excessive”. The amount of full wakefulness was 78% “little”, 15% “normal” and 7% “excessive”. No differences were found between low incidence of asynchronies by Asynchrony Index (AI) <10% and high incidence by AI >10% in deep sleep and full wakefulness. Two asynchronies were related to at least normal full wakefulness: Short Cycling (SC) ($p=0.02$) and Prolonged Cycling (PC) ($p=0.006$). The reverse trigger asynchrony (RT) was related to excessive deep sleep ($p=0.001$) (Table).

Conclusions: Most patients had either insufficient or excessive amount of deep sleep, but very little time in full wakefulness. The global incidence of asynchronies (AI) was not related with sleep patterns, but the asynchronies related to inspiratory time and flow were associated with wakefulness, and reverse triggering with an excessive amount of deep sleep.

	Little deep sleep n= 17	Normal deep sleep n=8	Excessive deep sleep n=16	p
IEE, % breaths; median (IQR)	0.2% (0-0.8)	0.38% (0-0.9)	0.15% (0-0.25)	0.2
DT, % breaths; median (IQR)	0.5% (0.1-1.1)	0.77% (0.26-1.1)	0.6% (0.3-0.82)	0.98
SC, % breath; median (IQR)	0.1% (0-0.3)	0.2% (0.1-0.4)	0.2% (0-0.3)	0.69
RT, % breath; median (IQR)	2.3% (0.7-6)	1.3% (0.15-3)	8% (4-18%)	0.001
PC, % breath; median (IQR)	0	0	0% (0-0.005)	0.74

	Little full wakefulness n=32	Normal full wakefulness n=6	Excessive full wakefulness n=3	p
IEE, % breaths; median (IQR)	0.18% (0-0.4)	0.57% (0.2-0.79)	0.02% (0-0.4)	0.18
DT, % breaths; median (IQR)	0.5% (0.14-1.1)	0.77% (0.25-1.1)	0.6% (0.3-0.8)	0.48
SC, % breath; median (IQR)	0.1% (0-0.26)	0.25% (0.14-0.4)	0.1% (0-0.26)	0.02
RT, % breath; median (IQR)	4.6% (1.2-10)	1.6% (0.7-3.5)	0.75% (0.56-4.6)	0.17
PC, % breath; median (IQR)	0	0.06% (0-0.14)	0	0.006

Amount of each asynchrony according to time in deep sleep (above) and in full wakefulness (below).

IEE: Ineffective expiratory efforts; DT: Double trigger; SC: Short cycling; RT: Reverse trigger; PC: Prolonged cycling.

Deep Sleep: ORP <0.5. Little Deep Sleep: <10% of TRT; Normal Deep Sleep 10-28% of TRT; Excessive Deep Sleep >28% of TRT.

Full wakefulness: ORP > 2.25. Little full wakefulness: < 3% of TRT; Normal full wakefulness: 3-12% of TRT; Excessive full wakefulness > 12% of TRT.

Amount of each asynchrony according to deep sleep and full wakefulness.

References

- Younes M, Gerardy B, Pack AI, Kuna ST, Castro-Diehl C, Redline S. Sleep architecture based on sleep depth and propensity: patterns in different demographics and sleep disorders and association with health outcomes. *Sleep* 2022 Jun 1;45 (6)
- Younes M, Ostrowski M, Soiferman M, Younes H, Younes M, Raneri J, et al. Odds Ratio Product of Sleep EEG as a Continuous Measure of Sleep State. *Sleep* 2015 Apr 1;38 (4):641–54.

Topic: Acute respiratory failure and mechanical ventilation

001368

PEEP titration is markedly affected by trunk inclination in mechanically ventilated patients with ARDS: a physiologic, cross-over study

F. Marrazzo¹, S. Spina¹, F. Zadek², C. Forlini¹, G. Bassi¹, R. Giudici¹, G. Bellani³, R. Fumagalli², T. Langer²

¹Anestesia e rianimazione 1, ASST Grande Ospedale Metropolitano Niguarda, Milan, Italy; ²School of medicine and surgery, University of Milano-Bicocca, Monza, Italy; ³Anesthesia and Intensive Care, Centre for Medical Sciences-CISMed, University of Trento, Trento, Italy.

Correspondence: F. Marrazzo

Intensive Care Medicine Experimental 2023, **11 (Suppl 1)**:001368

Introduction: Changing trunk inclination affects lung function in patients with ARDS. However, its impacts on PEEP titration remains unknown.

Objectives: Primary aim of this study was to assess, in mechanically-ventilated patients with COVID-19 ARDS, the effects of trunk inclination on PEEP titration. Secondary aim was to compare respiratory mechanics and gas exchange in semi-recumbent (40° head-of-the-bed) and supine-flat position (0°) following PEEP titration.

Methods: Twelve patients were positioned both at 40° and 0° trunk inclination (randomized order). The PEEP associated with the best compromise between overdistension and collapse guided by Electrical Impedance Tomography (PEEP-EIT) was set. After 30 min of controlled mechanical ventilation, data regarding respiratory mechanics, gas exchange, and EIT parameters were collected. The same procedure was repeated for the other trunk inclination.

Results: PEEP-EIT was lower in semi-recumbent than in supine-flat position (8 ± 2 vs. 13 ± 2 cmH₂O, $p < 0.001$). Moreover, the percentage of alveolar overdistension and collapse at PEEP-EIT were significantly higher in the supine-flat position (10 ± 5 vs. $5 \pm 3\%$, $p = 0.002$ and 9 ± 5 vs. $5 \pm 3\%$, $p = 0.001$, respectively). Semi-recumbent position with optimized PEEP resulted in higher PaO₂:FiO₂ (141 ± 46 vs. 196 ± 99 , $p = 0.02$) and lower global inhomogeneity index (46 ± 10 vs. 53 ± 11 , $p = 0.008$). A loss of aeration (measured by EIT) was observed only in supine-flat position (-153 ± 162 vs. 27 ± 203 ml, $p = 0.007$).

Conclusions: Semi-recumbent position is associated with lower PEEP-EIT and results in better oxygenation, less derecruitment, and more homogenous ventilation as compared to supine-flat position.

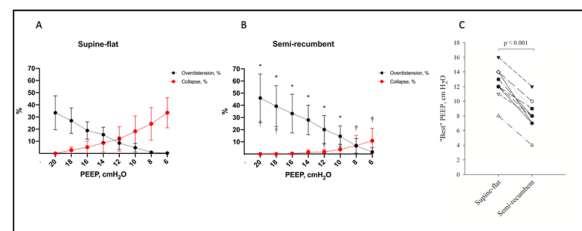

Figure. Overdistension, collapse and “Best” PEEP titration performed in supine-flat and semi-recumbent positions.

The results of collapse and overdistension during PEEP titration performed in supine-flat position and semi-recumbent position are presented in **Panel A** and **Panel B** respectively. Red dots represent the percentage of collapse, while black dots represent the percentage of overdistension.

A two-way ANOVA for repeated measures was performed to evaluate the effect of trunk inclination and PEEP both on collapse and overdistension ($p < 0.001$ for both). * = $p < 0.05$ compared to the percentage of overdistension in supine-flat position for the same PEEP value; † = $p < 0.05$ compared to the percentage of collapse in supine-flat position for the same PEEP value. **Panel C** represents the “Best” PEEP based on EIT in supine-flat and semi-recumbent position. Individual pairs of “best” PEEP identified through EIT in the two positions are reported. The p-value refers to the paired-t-test. Data of 12 patients are reported, however 2 pairs of patients have the same pair of “best” PEEP values in supine-flat and in semi-recumbent position. As a consequence, data of only 10 patients are visible.

References

- van der Zee P, Somhorst P, Endeman H, Gommers D. Electrical Impedance Tomography for Positive End-Expiratory Pressure Titration in COVID-19-related Acute Respiratory Distress Syndrome. *Am J Respir Crit Care Med* 2020;202:280–4. <https://doi.org/10.1164/rccm.202003-0816LE>.
- Costa ELV, Borges JB, Melo A, Suarez-Sipmann F, Toufen C, Bohm SH, et al. Bedside estimation of recruitable alveolar collapse and hyperdistension by electrical impedance tomography. *Intensive Care Med* 2009;35:1132–7. <https://doi.org/10.1007/s00134-009-1447-y>.
- Selickman J, Crooke PS, Tawfik P, Dries DJ, Gattinoni L, Marini JJ. Paradoxical Positioning: Does “Head Up” Always Improve Mechanics and Lung Protection? *Critical Care Medicine* n.d. <https://doi.org/10.1097/CCM.0000000000005631>.
- Marrazzo F, Spina S, Forlini C, Guarnieri M, Giudici R, Bassi G, et al. Effects of Trunk Inclination on Respiratory Mechanics in Patients with COVID-19-associated Acute Respiratory Distress Syndrome: Let’s Always Report the Angle! *Am J Respir Crit Care Med* 2022;205:582–4. <https://doi.org/10.1164/rccm.202110-2360LE>.
- Richard J-CM, Maggiore SM, Mancebo J, Lemaire F, Jonson B, Brochard L. Effects of vertical positioning on gas exchange and lung volumes in acute respiratory distress syndrome. *Intensive Care Med* 2006;32:1623–6. <https://doi.org/10.1007/s00134-006-0299-y>.
- Mezidi M, Guérin C. Effect of body position and inclination in supine and prone position on respiratory mechanics in acute respiratory distress syndrome. *Intensive Care Med* 2019;45:292–4. <https://doi.org/10.1007/s00134-018-5493-1>.
- Dellamonica J, Lerolle N, Sargentini C, Hubert S, Beduneau G, Di Marco F, et al. Effect of different seated positions on lung volume and oxygenation in acute respiratory distress syndrome. *Intensive Care Med* 2013;39:1121–7. <https://doi.org/10.1007/s00134-013-2827-x>.
- The authors are deeply grateful to all the physicians and nurses of the COVID-19 Intensive Care Units of the Niguarda Hospital.

Topic: Acute respiratory failure and mechanical ventilation

001369

Extracorporeal membrane oxygenation in acute liver failure—case series

M. Zentar¹, S. Patel², R. Loveridge³, T. Pirani⁴, C. Willars⁵, M. Angelova-Chee⁵, A. Vercueil⁵, G. Auinger⁶

¹Liver Intensive Care, King’s College London, London, United Kingdom;

²Intensive Care Department, King’s College Hospital, London, United Kingdom; ³Critical Care, Kings College Hospital NHS Foundation Trust, London, United Kingdom; ⁴Critical care, Kings College Hospital, LONDON, United Kingdom; ⁵Critical Care, King’s College Hospital, London, United Kingdom; ⁶Critical Care, King’s College Hospital NHS Foundation Trust, London, United Kingdom

Correspondence: M. Zentar

Intensive Care Medicine Experimental 2023, **11** (Suppl 1):001369

Introduction: Despite the increasing number of indications for extracorporeal membrane oxygenation (ECMO), acute liver failure (ALF) is viewed as a contraindication in the majority of circumstances. Severe coagulopathy which invariably accompanies ALF and the high incidence of cerebral oedema significantly increase the risk of bleeding complications and intracranial hypertension. Functional immunoparesis contributes to infection, sepsis and septic shock. Despite an emerging literature on the utility of ECMO in elective liver transplantation there remains a sparsity of data in ALF patients, with or without transplantation.

Objectives: To describe our experience in supporting ALF patients with ECLS and to identify predictors of successful weaning from ECMO.

Methods: Retrospective case review of patients admitted and treated at a tertiary referral liver transplant centre between 2012 and 2022, who presented with ALF and were supported with veno-arterial (VA) or veno-venous (VV) ECMO.

Results: Among 21 patients included, 12 patients (57%) were female. The median age was 31 years (IQR 26–37). In total 16 patients (76%) required VV ECMO and 5 patients (24%) VA ECMO, with a median support duration of 5 days (IQR 4–9). Median INR was 5 (IQR 3.57–7.36), median peak bilirubin was 251 μM (IQR 202–380), and median lactate was 11.7 mM (IQR 6.6–14.7). A total of 18 patients (86%) met King’s College Hospital poor prognostic criteria with 15 patients (71%) undergoing emergency liver transplantation (ELT), 12 (57%) of whom were bridged to ELT on ECMO. At the time of cannulation 21 patients (100%) required renal replacement therapy and 6 patients (29%) had signs of raised intracranial pressure with fixed and dilated pupils. For patients receiving VV ECMO the median RESP score was -8 (IQR -6 to -11), patients supported with VA ECMO had a median SAVE score of -11 (IQR -11 to -15). Circuit anticoagulation was only used in 7 patients (33%). A total of 15 patients (71%) were successfully weaned from ECMO; 3 VA ECMO (60%) and 12 VV ECMO (75%). Ten patients (48%) survived to hospital discharge; 2 VA (40%) and 8 VV ECMO (50%). Assessment of multiple variables within 24 h of ECMO initiation showed that lower lactate levels (median 10 mM weaned vs 15.35 mM not weaned, $p=0.014$), lower (VIS) Vasopressor and Inotropic Scores (median 55 weaned vs 133 not-weaned, $p=0.023$) and an increased number of days on ECMO (median 6 days weaned vs 3 days not-weaned, $p=0.0025$) were associated with a significantly greater chance of successful weaning. ROC analysis for the above variables were as follows: VIS AUC 82.2% (2.3–100%), Lactate AUC 84.4% (63.9–100%), and Days on ECMO AUC 93.3% (83.9–100%).

Conclusions: ECMO support in ALF is feasible and despite the extreme pathophysiology a significant percentage of patients survived with or without emergency liver transplant. Lower lactate levels, lower VIS and greater number of ECMO days were associated with a greater chance of successful weaning.

Topic: Metabolism, endocrinology, liver failure and nutrition

001372

A comparison between emergency physicians and radiologists on the accuracy and efficiency of the interpretation of computed tomography of acute appendicitis

C.C. Chao¹

¹Emergency Department, Taipei Medical University Hospital, Taipei, Taiwan

Correspondence: C.C. Chao

Intensive Care Medicine Experimental 2023, **11** (Suppl 1):001372

Introduction: Appendicitis is a common acute abdomen disease seen in the emergency department (ED). Early diagnosis of appendicitis can reduce time to treatment and prevent complications. We compared the interpretation of computer tomography (CT) scan between emergency physicians and radiologists.

Objectives: The aim of this study is to compare the time to and the accuracy of CT scan interpretation between emergency physicians and radiologists.

Methods: This is a retrospective study that enrolled patients with CT scan for suspected acute appendicitis in an academic hospital from July 2019 to May 2020. Analysis on the accuracy of the diagnosis of appendicitis and time from completion of CT scan testing were compared between emergency physicians and radiologists.

Results: A total of 318 patients with appendicitis were included. Patients coming to hospital at off time were younger (Mean Difference = 5; P -value = 0.016) and were more common with normal CRP (Chi-square = 11.19; P -value < 0.001). Both groups’ interpretations of appendicitis were not affected by arrival time and all did differential diagnosis well (Emergency physician

area under curve (AUC) = 0.912 versus Radiologist AUC = 0.911). Time to CT interpretation by emergency physicians was significantly lower than by radiologists (Mean Difference = -217.37 min; P -value < 0.001).

Conclusions: The interpretation of abdominal CT scan for acute appendicitis by emergency physicians was more efficient and equally accurate compared to interpretation by radiologists.

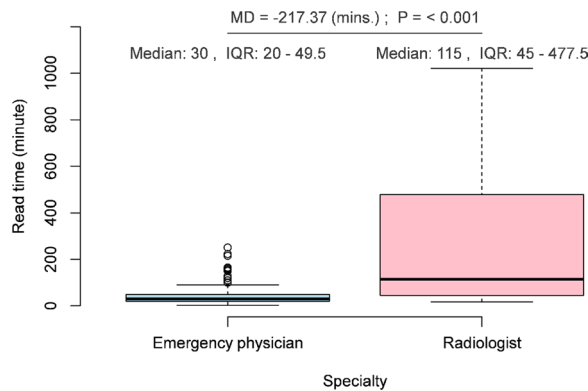

Figure 1 (abstract 001372)

Topic: Trauma

001373

Blood pressure augmentation with dobutamine and ethyl nitrite to optimize hemodynamics and spinal cord oxygenation following traumatic spinal cord injury: a pre-clinical study

R. Hoiland¹, E. Erskine², J. Duffy², O. Wearing², N. Manouchehri¹, K. So¹, J. Ethridge¹, M. Hannah¹, L. Wainman², M. Ahmadian², A. Warner¹, A. Billingsley¹, R. Newsome¹, F. Streijger¹, B. Kwon¹, C. West²

¹International Collaboration on Repair Discoveries, The University of British Columbia, Vancouver, Canada; ²International Collaboration on Repair Discoveries, The University of British Columbia-Okanagan Campus, Kelowna, Canada

Correspondence: R. Hoiland

Intensive Care Medicine Experimental 2023, **11** (Suppl 1):001373

Introduction: Following a traumatic spinal cord injury (SCI), there is a period of continued spinal cord tissue hypoxia that contributes to secondary injury. Blood pressure augmentation is employed clinically in an attempt to increase spinal cord blood flow and spinal parenchymal oxygen tension (PO₂). However, this strategy does not consistently alleviate secondary spinal cord tissue hypoxia or injury and new hemodynamic management strategies are needed.

Objectives: To investigate the influence of blood pressure augmentation with dobutamine and adjuvant ethyl nitrite (ENO), an oxygen-dependent vasodilator, on hemodynamic management and spinal cord oxygenation following traumatic spinal cord injury (SCI).

Methods: Parallel experiments were conducted in rodent and pig models of high-thoracic SCI: a dose-escalation study with ENO (0–100 ppm) and an acute treatment study (~0 to 4 h post-SCI) involving ENO (50 ppm; rodents only), dobutamine (DOB, 1 µg/kg/min, IV), and combined ENO + DOB administration along with controls (Lactated Ringer's, IV). Rodents underwent a T3 SCI (300 kdyn, no compression) while pigs underwent a T2 SCI (~2600 kdyn, 2 h compression). Mean arterial pressure (MAP; femoral artery) and intraparenchymal spinal PO₂ were measured.

Results: Dose-escalation of ENO to 50 ppm increased spinal PO₂ from 9 ± 5 to 17 ± 8 mmHg in the rodents ($P = 0.043$; $n = 4$) and from 12 ± 2 to 16 ± 3 mmHg in the pigs ($n = 2$). In the acutely treated rodents, MAP was higher with DOB (84 ± 8 mmHg; $P = 0.002$; $n = 5$) and DOB + ENO (79 ± 8 mmHg; $P = 0.018$; $n = 5$) compared to controls (63 ± 6 mmHg; $n = 5$) while ENO increased spinal PO₂ compared to controls (23 ± 7 vs. 6 ± 3 mmHg; $P = 0.002$; $n = 5$ each group); concurrent DOB infusion

further augmented PO₂ (+6 ± 4 mmHg; $P = 0.03$; $n = 5$). In the acutely treated pigs, spinal PO₂ was 12 ± 11 mmHg in controls ($n = 4$), 21 ± 11 mmHg with DOB ($n = 6$), and 34 ± 23 mmHg with DOB + ENO ($n = 5$) following decompression. Spinal PO₂ decreased from pre-SCI to post-decompression in the control group (-12 ± 15 mmHg) but was elevated in the DOB + ENO group (+21 ± 19 mmHg; $P = 0.04$ compared to the change in controls).

Conclusions: Blood pressure augmentation with dobutamine and adjuvant ethyl nitrite holds promise as an approach to optimize hemodynamic management and spinal cord oxygenation following traumatic spinal cord injury. Such improvements in spinal cord oxygenation may be a method by which we can reduce secondary injury in the spinal cord and improve outcomes for patients that suffer a traumatic spinal cord injury.

References

1. This work was funded by an ICORD Seed Grant, Bluma Tischler Postdoctoral Fellowship, Michael Smith Foundation for Health Research Trainee Award, Craig H. Neilsen Foundation Postdoctoral Fellowship, and US Department of Defence SCIRP TRA Expansion Award

Topic: Translational Medicine

001374

High-flow oxygen insufflation vs continuous positive airway pressure during one-lung ventilation: a comparison of effectiveness and postoperative outcomes

A. Farshatov¹, E. Ershov², V. Panafidina³

¹Center of Anesthesiology and Intensive care, Saint Petersburg City Clinical Oncology Center, Saint Petersburg, Russia; ²Anesthesiology and Intensive care, Voenno-Meditsinskaya Akademiya Imeni S. M. Kirova, Sankt-Peterburg, Russia; ³Anesthesiology and intensive care, Pavlov First State Medical University of Saint Petersburg, Saint-Peterburg, Russia

Correspondence: V. Panafidina

Intensive Care Medicine Experimental 2023, **11** (Suppl 1):001374

Introduction: Isolation of one lung leads to ventilation-perfusion mismatch and increases intrapulmonary shunt, which in some cases may lead to clinically significant hypoxemia and potentially could lead to significant postoperative complications. Recent research has shown that high-flow oxygen insufflation (HFO) could be applying during one-lung ventilation (Duwat A. et al., 2019).

Objectives: This study aims to compare the effectiveness of high-flow oxygen insufflation and continuous positive airway pressure (CPAP) in correcting intraoperative hypoxemia, reducing V/Q mismatch, and preventing postoperative complications and adverse outcomes.

Methods: The study included 67 patients who underwent elective video-assisted thoracoscopic lobectomy and developed hypoxemia during the first 15 min of one-lung ventilation. The patients were randomly divided into two groups: the first group (HFO group) received HFO into the non-ventilated lung to correct hypoxemia, while the CPAP group received conventional CPAP into the non-ventilated lung. Oxygenation parameters were recorded at four time points during the operation: T1 for bipulmonary ventilation, T2 for single-lung ventilation, T3 for implementation of HFO with a flow of 60 L/min (at a temperature of 37 °C) and an initial FIO₂ of 0.5 into the non-ventilated lung for the HFO group or CPAP of 5 cm H₂O into the non-ventilated lung in the CPAP group. At T4, HFO was applied with a flow of 30 L/min (at a temperature of 37 °C) and an initial FIO₂ of 0.5 into the non-ventilated lung in the HFO group, while in the CPAP group, CPAP of 2 cm H₂O was applied into the non-ventilated lung. We analyzed PaO₂, SaO₂, PCO₂, Qs/Qt, and surgical team satisfaction with lung collapse by visual analog scale (VAS; 0 is for perfect visualization, 10 is for inability to perform VTS). Postoperative complications and outcomes were analyzed.

Results: At T1 and T2, there were no statistically significant differences between the groups in oxygenation parameters. PaO₂ was significantly higher in the HFO group at T3 and T4: 134.5 (126.0; 141.75) mm Hg in the HFO group vs 108.5 (104.0; 114.5) mm Hg in the CPAP group at T3 ($p < 0.001$) and 118.5 (113.0; 122.25) mm Hg vs 92.5 (89.0;

98.25) in the CPAP group at T4 for the HFO and CPAP groups, respectively ($p < 0.001$). At T4, SaO₂ was higher (97% (96; 97)) in the HFO group: 97% (96; 97) vs 94% (94; 95) in the CPAP group ($p < 0.001$). Qs/Qt at T4 was 10.7% (9.5; 15.7) in the HFO group and 21.3% (18.4; 23.9) in the CPAP group ($p < 0.001$). There was a significant difference in surgical satisfaction between the HFO group and CPAP group at T3 and T4: 2.5 (2; 3) in the HFO group at T3, 9 (8; 9) in the CPAP group at T3 ($p < 0.001$); 1 (0; 1) in the HFO group and 5 (4; 5) in the CPAP group ($p < 0.001$). PCO₂ did not differ at any time during surgery. Postoperative complications did not differ between the two groups: class III Clavien-Dindo complication developed in one patient in the CPAP group. The need for postoperative respiratory support did not differ between the two groups (Chi-square 0.891, $p = 0.346$). No fatal outcomes were observed in our study.

Conclusions: The use of high-flow oxygen insufflation during one-lung ventilation undergoing video-assisted thoracic surgery allows for effective treatment of hypoxemia similar to the CPAP method and seems to be safe in terms of postoperative complications and outcomes. High-flow oxygenation could provide better intraoperative visualization.

References

1. Duwat A, Courivaud P, Dusart E, Pavy G, Pila C (2019) High-Flow Oxygen Therapy for Perioperative Hypoxemia during One-lung Ventilation. *J Anesth Clin Res* 10: 880.

Topic: Perioperative care

001375

Specialized medical training using clinical simulation in ECMO: only face-to-face or hybrid model?

Y. Chicote Carasa¹, J. L. PerezVela¹, R. Munoz-Calahorra¹, E. Burgui-Gualda¹, J. L. Flordelis Lasierra¹, L. J. Terceros Almanza¹, E. Renes Carreño¹

¹Intensive Care Medicine, University Hospital 12 de Octubre, Madrid, Spain

Correspondence: Y. Chicote Carasa

Intensive Care Medicine Experimental 2023, **11** (Suppl 1):001375

Introduction: Medical training continues to evolve, and theoretical training is currently inconceivable without balanced practices, even more so if we think about complex techniques or procedures such as extracorporeal membrane oxygenation (ECMO), hence the growth of the offered training through clinical simulation. However, the arrival of the pandemic abruptly modified this new training philosophy, having to update the training methods and implement multiple online platforms and supports to maintain training despite the situation caused by COVID-19.

Objectives: The objective of the study was to assess whether differences were detected between two training course models on the use and management of ECMO; one carried out entirely face-to-face and another hybrid with an online theoretical phase and face-to-face practical phase (post-COVID-19 pandemic); in terms of the degree of satisfaction, interest in the contents, integration with the teaching staff and the methodology among the students who received the full face-to-face course compared to those who received the hybrid course model (on-line plus face-to-face).

Methods: A total of 6 theoretical-practical training courses were carried out, including advanced simulation workshops, between 2017 and 2023 (4 face-to-face courses of 22 h and 2 in a mixed online format/3 months plus face-to-face/2 days). Retrospective descriptive study, for which, at the end of the course, a satisfaction survey was conducted with scores between 1 (poor) and 5 (excellent). Statistical analysis was performed with SPSS v24, quantitative variables were used that were expressed as mean and SD, and the comparison of means was carried out using the T-Student test with a pre-established degree of significance of 0.05.

Results: Data from 161 students were analyzed (135 answered the survey, 83.8%). 46 in hybrid modality and the rest in face-to-face modality (courses of 24 to 30 students). Regarding the results, both types of courses, had high evaluations and, it should be noted (Table 1)

that, both in the evaluation of the course and in the integration with the teaching staff, there were no statistically significant differences between both group models but that, in the interest in the topics and the valuation of the methodology, a relevant variable for us, did point to differences in favor of the hybrid model.

Questions	Mean face-to-face	Standard deviation face-to-face	Mean Hybrid	Standard deviation hybrid	T-Student
General evaluation of the course	4.73	0.21	4.83	0.27	0.954
Interest in the topics covered	4.06	0.85	4.45	0.47	0.004
Integration of teachers with assistants	4.60	0.64	4.67	0.49	0.532
The methodology has been adequate	4.16	0.73	4.43	0.63	0.044

Conclusions: Both course formats had a high degree of student satisfaction. The modification in the teaching strategy, with hybrid training (online 3 months associated with face-to-face simulation workshops during 2 days) not only was not inferior to the classic model, but its methodology was better valued compared to the classic one.

Topic: Translational Medicine

001378

Increase of invasive and probable invasive group A Streptococcal infections in adults in the Swiss Cantonal Hospital Grisons: a case series

A. Schweighauser¹, M. E. Kajdi², C. Alexia³, W. Adrian⁴, P. Francesca¹

¹Interdisziplinäre Intensivstation, Hospital Graubünden, Chur, Switzerland;

²Interdisziplinäre Intensivstation, Kantonsspital Graubünden, Loestrasse, Chur, Switzerland, Chur, Switzerland;

³Departement of Internal Medicine, Hospital Graubünden, Chur, Switzerland;

⁴Interdisziplinäre Intensivstation, Kantonsspital Graubünden, Chur, Switzerland

Correspondence: A. Schweighauser

Intensive Care Medicine Experimental 2023, **11** (Suppl 1):001378

Introduction: An increase of invasive and probable invasive group A Streptococcal infections (iGAS and piGAS) in the last year has been described (1). Our aim was to compare the incidence of iGAS and piGAS from 2018 to May 2022 (period 1) with incidence of cases from June 2022 to April 2023 (period 2) in the Cantonal Hospital of Grisons, Switzerland and to describe the cases occurring during the last year.

Methods: iGAS is defined by germ isolation from sterile sites (blood, synovial fluid, peritoneal fluid), whereas piGAS by germ isolation from non-sterile sites (deep skin or retropharyngeal aspirations) requiring one or more of the following: hospitalization for iv. antibiotics, surgery or admission to the Intensive Care Unit (ICU) (2). Streptococcal toxic shock syndrome (STSS) is defined as sudden onset of shock, organ failure and frequently death (3).

We captured all cases of iGAS and piGAS that were recorded in the Swiss Diagnosis Related Groups of our institution and by reviewing the medical records of all hospitalised patients with positive blood culture with group A streptococci from January 2018 until April 2023. Additionally, we summarised comorbidities, clinical presentation, therapeutic approach and outcome of all patients with iGAS and piGAS of our institution since June 2022 differentiating the patients of the ICU from patients of the wards.

Data are expressed as numbers (%) and median (IQR).

Results: During the over four years period from 2018 to May 2022 we identified totally 16 cases of iGAS and piGAS, 7 of them had positive blood cultures. From June 2022 to April 2023, we noted an increase of to a total of 40 cases. There were 22 cases of iGAS (12 treated on the ICU) and 18 piGAS (5 treated on the ICU). The male/female ratio was 2.3.

ICU: Total 17 cases, median age was 58 (39–73) years. The most common clinical manifestation was soft tissue infection $n=12$, (71%) with 3 (18%) necrotizing fasciitis. Alcohol $n=5$ (29%), drug abuse $n=5$ (29%) and obesity $n=3$ (18%) were the main comorbidities. All patients received appropriate antimicrobial treatment. Clindamycin was administered in 15 (88%) of the cases. 9 (53%) patients needed surgery with 1 patient requiring limb amputation. 7 (41%) patients developed STSS and 8 (47%) suffered from ARDS. 3 (42%) patients with STSS received Immunoglobulin (IVIG) (4). 28-days mortality was 18%.

NON-ICU: Total 23 cases, median age was 56 (39–71) years. The most common clinical presentation was soft tissue infection $n=15$ (65%). The most common co-morbidity was diabetes $n=4$ (17%). Regarding iGAS, 9 (40%) of patients did not receive Clindamycin, although indicated (5,6). 16 (70%) patients needed surgery. No patient died.

Conclusions: We noted an increase of piGAS and iGAS in our hospital since June 2022. The clinical presentations were serious: 43% of the patients were admitted to the ICU. Illicit substance, alcohol abuse and obesity were risk factors. Mortality was high. According to the literature adherence to current treatment recommendations is low. Efforts should be undertaken to improve standard of care: Immediate treatment should include clindamycin for iGAS and IVIG for STSS.

References

1. Zangarini L, Eur J Clin Microbiol Infect Dis 2023 mar 7;1–13, 2005–2020;
2. World Health Organization (15 December 2022). Available at: <https://www.who.int/emergencies/disease-outbreak-news/item/2022-DON429> (23.04.2023)
3. Babiker A, Li X, Lai YL, Strich JR, Warner S, Sarzynski S, Dekker JP, Danner RL, Kadri SS. Lancet Infect Dis. 2021 May;21 (5):697–710.
4. Zimbelman J, Palmer A, Todd J. Pediatr Infect Dis J. 1999 Dec;18 (12):1096–100.
5. Parks T, Wilson C, Curtis N, Norrby-Teglund A, Sriskandan S. Polyspecific Clin Infect Dis. 2018 Oct 15;67 (9):1434–1436.
6. Center for disease Control and Prevention Increase in Invasive Group A Strep Infections, 2022–2023 (15.04.2023)

Topic: Infections and prevention

001379

Lung microbiota composition, respiratory mechanics, and outcomes in COVID-19-related ARDS

G. De Pascale¹, B. Posteraro², F. De Maio³, P. C. Pafundi⁴, E. S. Tanzarella¹, S.L. Cutuli¹, G. Lombardi⁵, D. L. Grieco⁶, G. Santarelli³, A. Infante⁷, M. Sanguinetti³, M. Antonelli⁸

¹Dipartimento di Scienze dell’Emergenza, Anestesiologiche e della Rianimazione, Fondazione Policlinico Universitario A. Gemelli IRCCS, Rome, Italy; ²Department of Medical and Surgical Sciences, Fondazione Policlinico Universitario A. Gemelli IRCCS, Rome, Italy; ³Department of Laboratory and Infectious Sciences, Fondazione Policlinico Universitario A. Gemelli IRCCS, Rome, Italy; ⁴5 Epidemiology and Biostatistics Research Core Facility, Gemelli Science & Technology Park, Fondazione Policlinico Universitario A. Gemelli IRCCS, Rome, Italy; ⁵Dipartimento di Scienze dell’emergenza, Anestesiologiche e della Rianimazione, Fondazione Policlinico Universitario A. Gemelli, Roma, Italy; ⁶Scienze dell’emergenza, Anestesiologiche e della Rianimazione,

Fondazione Policlinico Universitario A. Gemelli, Roma, Italy; ⁷Department of Radiologic and Hematologic Sciences, Fondazione Policlinico Universitario A. Gemelli IRCCS, Rome, Italy; ⁸Anesthesia and Intensive Care, Agostino Gemelli University Polyclinic, Roma, Italy

Correspondence: G. De Pascale

Intensive Care Medicine Experimental 2023, 11 (Suppl 1):001379

Introduction: Few data are available on lung microbiota composition of patients with COVID-19-related ARDS (C-ARDS) receiving invasive mechanical ventilation (IMV). Moreover, limited evidence has investigated the correlation between lung microbiota and respiratory mechanics.

Objectives: We aimed to assess the relationship between lung microbiota composition, respiratory mechanics and clinical outcomes in critically ill patients with C-ARDS.

Methods: This observational study involved two ICUs of a university hospital in Italy from April 1 through December 31, 2020. Lung microbiota was investigated by bacterial 16S rRNA gene sequencing, performed on bronchoalveolar lavage (BAL) fluid samples withdrawn after intubation. The lung bacterial communities were analyzed after stratification by respiratory system compliance/predicted body weight (Cr_s) and ventilatory ratio (VR). Weaning from IMV and in-hospital mortality were further assessed.

Results: We enrolled 70 C-ARDS patients requiring IMV. Lung microbiota composition (phylum taxonomic level, PERMANOVA test) significantly differed between patients with low Cr_s vs. those with high (p=0.010), as well as in case of low-VR vs high-VR stratification (p=0.012). As difference-driving taxa, Proteobacteria (p=0.017) were more dominant in low vs high-Cr_s patients, whilst Firmicutes less (p=0.040). Similarly, Proteobacteria were more dominant in low vs high-VR patients (p=0.013). We further observed lung microbiota diversity as a prognostic factor of in-hospital mortality (HR=3.31, 95%CI 1.52–7.20, p=0.048).

Figure: Graphic representation of respiratory mechanics, aerated tidal and lung microbiota composition in two patients.

Computed tomography scan images of lungs from two representative patients with (A) high Cr_s/PBW (0.61 (mL/cmH₂O)/Kg) and VR (3.64) values or (B) low Cr_s/PBW (0.43 (mL/cmH₂O)/Kg) and VR (1.65) values depicted the distribution of aerated lung tissue, detailed in the respective wave frequency graphs. For each patient, bubble chart shows dominant families in the lung bacterial community. Abbreviations: Cr_s = compliance of the respiratory system. PBW = predicted body weight. VR = ventilatory ratio.

Conclusions: C-ARDS patients with low Cr_s/low VR had a Proteobacteria-dominated lung microbiota. Moreover, a more diverse lung bacterial community was more likely a predictor of weaning from IMV and discharge alive from hospital.

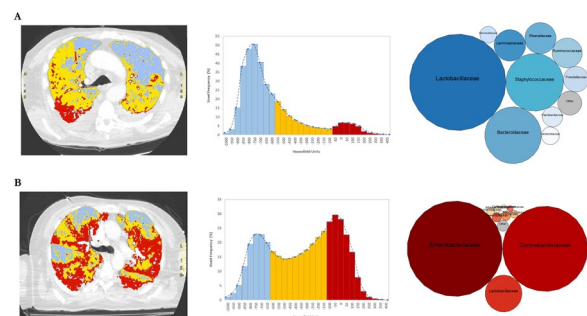

References

1. [6] Dickson R. The microbiome and critical illness. Lancet Respir Med. 2016;4 (1):59–72.
2. This study was supported by grants from the Italian Ministry for University and Scientific Research (GR-2018–1236737).

Topic: Infections and prevention

001381

Regional analgesia for chest trauma: current practice on a trauma centerD.P. Martins Fernandes¹, J. Cabral², S. Alves¹, J.M. Pereira³, S. Fonseca⁴, N. Gatta¹, R. Teles², D. Pozza⁵, J. A. Paiva³

¹Emergency and Intensive Care Department, Centro Hospitalar Universitário de São João, Porto, Portugal; ²Department of Anaesthesiology, Centro Hospitalar Universitário de São João, Porto, Portugal; ³Emergency and Intensive Care Department, Centro Hospitalar Universitário de São João, Faculty of Medicine, University of Porto, Porto, Portugal; ⁴Department of Anaesthesiology, Centro Hospitalar Universitário de São João, Faculty of Medicine, University of Porto, Porto, Portugal; ⁵Faculty of Medicine, University of Porto, Experimental Biology Unit-Department of Biomedicine, Porto, Portugal

Correspondence: D.P. Martins Fernandes*Intensive Care Medicine Experimental* 2023, **11 (Suppl 1)**:001381

Introduction: Severe chest trauma (CT) remains a leading cause of morbidity and mortality. Inadequate pain management has a deleterious effect, increasing the risk of respiratory complications, chronic pain, and prolonged hospital stay. Although opioids are commonly used, their adverse effects limit their use. Regional analgesia (RA), as part of multimodal regimen, has been shown to be beneficial in comparison to opioid-based methods. Thoracic epidural (TEP) is the recommended regional technique in most European protocols, but its use may be limited in critical care. Other techniques, such as continuous erector spinae plane block (CESB), can be a safe and effective alternative.

Objectives: To describe the use of RA in ICU patients with CT and to evaluate its impact on clinical outcomes.

Methods: Single-center retrospective cohort study of all adult patients with CT admitted on a Trauma Center of a tertiary university hospital and submitted to RA as part of a multimodal regimen between January 1st 2021 and December 31st 2022.

Primary outcome: variation in opioid consumption following RA.

Secondary outcomes: incidence of RA complications, nosocomial infections, duration of mechanical ventilation, and ICU and hospital length of stay (LOS).

Preliminary analysis included descriptive statistics, along with inferential analysis based on t-tests and chi-square comparisons.

Results: Of the 469 trauma patients admitted, 57 met the inclusion criteria (12.2%). Most were male (87.7%), with a median age of 49 years. 63.2% had comorbidities. Mean Trauma Score and Injury Severity Score was 42.9%; Mean Injury Severity Score was 25.5 and 82.5% of them had a score > than 15 (no significant difference in TEP versus CESB groups). Road traffic accidents were the main mechanism of injury (50.9%) followed by falls (31.6%). 10.5% had isolated CT. Brain, spine, and abdominal trauma were the most common concurrent injuries.

TEP was performed in 75.4% and CESB in the remaining 24.6% patients. Only one complication was documented. Median oral morphine milligram equivalents decreased significantly from 405 (IQR 1020) before RA to 60 (IQR 60) on the fifth day after RA ($p < 0.001$). This reduction in opioid consumption was statistically significant in the TEP group ($p = 0.002$) but not in the CESB group.

Mean hospital LOS was 24.7 days, with 10.1 days in ICU (6.8 of them after RA). 40.35% of patients required mechanical ventilation for a mean duration of 9.73 days, 7.35 of which after RA. Incidence of nosocomial infections was 21.4%. Total mortality was 1.7%. No differences were found between TEP and CESB groups for these parameters.

Conclusions: RA is safe and effective for pain relief and avoiding side-effects of opioid based regimens for ICU patients with severe CT. It was associated with a significant reduction in opioid consumption on the 5th day after its initiation, namely with TE. Similar clinical outcomes were observed between TEP and CESB.

References

1. Peck J, Beks RB, Kingman BF, Marsman M, Ruurda JP, Houwert RM, Leenen LPH, Hietbrink F, Jong MD, Epidural analgesia for severe chest trauma: ana analysis of current practice on the efficacy and safety, *Crit Care Research and Practice*, vol 2019, 7 pgs, Article ID 4837591, 10. 1155/2019/4837591
2. P. Bouzat et al., Chest trauma: first 48 h management, *Anaesth Crit Care Pain Med* 36 (2017) 135–145
3. Galvagno SM et al., Pain management for blunt thoracic trauma: A joint practice management guideline from Eastern Association for the Surgery of Trauma and Trauma Anesthesiology Society, *J Trauma Acute Care Surg*, 2016, Vol 81, Number 5, 936–951, 10. 1097/TA.0000000000001209
4. Diwan SM, Adyhye B, Nair A, Sancheti P, Comparison of thoracic epidural and thoracic erector spinae block for pain relief of posterolateral rib fractures—a retrospective cohort study, *Ain-Shams Journ Anesthesiology*, 12, Article number 87 (2022), 10. 1186/s42077-022–00287-2

Topic: Trauma

001382

Testosterone and sST2 as mortality predictive biomarkers in patients with sepsis induced cardiomyopathyL. Wang¹, Z. Liying¹

¹Department of Critical Care Medicine, Renmin Hospital of Wuhan University, Wuchang District, Wuhan, China, Wuhan, China

Correspondence: L. Wang*Intensive Care Medicine Experimental* 2023, **11 (Suppl 1)**:001382

Introduction: Sepsis induced cardiomyopathy (SIC) is characterized as high mortality and poor outcomes. Abnormal serum testosterone and soluble ST2 (sST2) have been reported related with cardiovascular events in sepsis. This study was performed to explore the relationship between testosterone and sST2 and all-cause mortality in SIC patients.

Methods: We conducted a prospective cohort study and enrolled 327 male patients with diagnosed SIC from January 2021 to March 2023 at a large academic medical center in Wuhan. The predictive values of testosterone and sST2 on mortality of SIC were estimated with Cox proportional hazards analysis and receiver operative characteristic curve (ROC).

Results: In present study, there were 87 deaths (26.6%) and 103 deaths (31.5%) that occurred during 28-day follow-up and 90-day follow-up, respectively. When grouped by tertiles of biomarkers, patients with higher testosterone and decreased sST2 had significantly lower 28-day and 90-day mortality (both $p < 0.01$). Kaplan–Meier analysis showed significantly higher 28-day and 90-day survival with higher testosterone and lowered sST2 (all $p < 0.001$). In logistic regression, body mass index, testosterone, sST2 and N-terminal pro-B-type natriuretic peptide (NT-proBNP) were risk factors of 28-day mortality ($p < 0.05$). The combination of testosterone and sST2 enhanced prediction of both 28-day mortality (AUC 0.805) and 90-day (AUC 0.833) mortality.

Conclusions: In this cohort of SIC patients, serum testosterone and sST2 predicted mortality independently and jointly. Their combination improved prognostic accuracy for 28-day and 90-day survival. These biomarkers may facilitate early risk stratification and identify patients who could benefit from targeted interventions.

Topic: Cardiovascular issues in ICU

001383

Analysis of multi-resistance in an ICU following an outbreak of vancomycin-resistant enterococcus and the impact of implemented measuresJ. Lujan Varas¹, E. Lopez Ramos¹, B. Llorente Ruiz², D. Troncoso³, P. Villa Diaz², R. Molina Montero², A. Acha Aranda², A. Ruiz², D. Rodriguez², L. Alcazar Sanchez-Elvira², E. Nevado⁴

¹Intensive Care Unit, Hospital Universitario Príncipe de Asturias, Alcalá de Henares, Spain; ²Intensive care unit, Hospital Príncipe de Asturias, Alcalá

de Henares, Spain; ³Preventive Medicine Unit, Hospital Universitario Príncipe de Asturias, Alcalá de Henares, Spain; ⁴Unidad de Cuidados Intensivos, Hospital Universitario Príncipe de Asturias, Alcalá de Henares, Spain

Correspondence: J. Lujan Varas

Intensive Care Medicine Experimental 2023, **11 (Suppl 1)**:001383

Introduction: The emergence of bacterial resistance to antibiotics is a major problem that society will have to face in the coming years. Enterococci are opportunistic pathogens responsible for nosocomial infections.

Objectives: To analyse the situation of multi-resistance in an Intensive Care Unit (ICU) and the impact of measures taken to control an outbreak of vancomycin-resistant Enterococcus (VRE) detected during the study period.

Methods: Retrospective, observational study in a 14-bed ICU in Level II hospital. The analysis time is divided into two periods (2015–2018 and 2019–2022) separated by the implementation of measures following the outbreak of VRE (2017–2018). 2020 was excluded from the study period due to the barrier posed by the COVID-19 pandemic. Characteristics of the patients, severity (APACHE II), length of stay and previous use of antibiotics were collected. MDR isolates were collected from clinical samples and colonisation studies. Qualitative variables are described as percentages and quantitative variables as mean (SD). Rates of patients with MDR during ICU admission are expressed per 1000 days of stay and per 100 patients.

The most relevant measures implemented were: intensification of hand hygiene training, increased supervision in the implementation of the cleaning protocol, Preventive Medicine carried out a control of surfaces by direct observation and the incorporation of tests to locate areas with a lack of cleanliness, cultures using RODAC plates and preventive decontamination systems (pulsed ultraviolet light and hydrogen peroxide vapour) were incorporated.

Results: First period, 545 patients, 63% male, mean age 64.02 years (± 15.28). Mean APACHE 14.28 (± 8.32) and mean stay 7.99 (± 15.65) days. Antibiotic treatment was given in 55.47%. MDR was detected in 13.2%. The mean rate of patients with MDR previous ICU admission was 9.07% and 4.55% for intra-ICU acquisition. Most prevalent pathogens in 2015 were VRE (33.33%), Enterobacteriaceae BLEE (33.33%) and BGN-carbapenemases (33.33%). In 2016, detection of MRSA (33.33%) became more important. In 2017 and 2018 there is a very marked increase in the detection of EVR, 83.33% and 54.55% respectively. A total of 19 cases were detected between 2017 and 2018. Of the 19 cases of the outbreak, 11 (57.89%) were acquired in the ICU and involved infection in only 2 cases (10.52%).

Second period, 411 patients, 64.89% male, mean age 62.29 (± 14.80) years. Mean APACHE 14.44 (± 8.43) and mean stay 9.58 (± 15.43) days. Antibiotics in 58.16%. MDR was detected in 10.70%. The mean rate of patients with MDR was 6.88% for pre-acquisition and 3.86% for intra-ICU acquisition. In 2019, MRSA predominates (33.33%), with EVR (22.22%) and multidrug-resistant *Pseudomonas* (22.22%) in second place. In 2021, the prevalence of MRSA increases, accounting for 40% of isolates, together with BGN-carbapenemase (40%). Finally, in 2022, 50% of BGN-carbapenemase isolates persisted, with a significant decrease in MRSA. Only 2 more cases of VRE have been identified in 2022.

Measures adopted, we analysed in more detail: adherence to hand hygiene (Table 1) and surface analysis (Table 2).

In relation to the impact of the measures adopted, the rate of patients with MDR with intra-ICU acquisition, during 2015, 2016, 2017 and 2018 was 3.51%, 8.44%, 5.75% and 9.98% respectively. In 2019, 2021 and 2022 was 7.82%, 2.82% and 3.20% respectively.

Conclusions: This study confirms the established problem of the emergence of bacterial resistance and the importance of maintaining prevention and control strategies. Also highlights the problem of the "exhaustion phenomenon" in the staff as a factor favouring the spread of MDR. The decrease in the rate of patients with intra-ICU acquisition after the implementation of measures demonstrates that preventive strategies work.

Table 1 (abstract 001383) Adherence to hand hygiene.

	Medical staff (%)	Nursing staff(%)	Auxiliary staff(%)
2015	85,71	86,36	50,00
2016	90,48	82,50	70,83
2017	62,50	73,08	84,21
2018	41,18	51,35	63,64
2019	73,33	79,17	60,61
2020	71,43	42,42	45,83
2021	70,00	66,67	66,67
2022	16,67	41,46	44,00

Table 2 (abstract 001383) Surface analysis

	Detection limit : 5 UFC /cm ²	
	CORRECT(%)	INCORRECT(%)
2018	80,45	19,55
2019	74,42	25,58
2020	68,89	31,11
2021	77,14	22,86

References

1. Diaz Granados CA, Zimmer SM, Klein M, Jernigan JA. Comparison of mortality associated with vancomycin-resistant and vancomycin-susceptible enterococcal bloodstream infections: a meta-analysis. *Clin Infect Dis*. 2005;41:327–33.
2. Sociedad Española de Medicina Intensiva, Crítica y Unidades Coronarias. Proyecto Resistencia Zero (RZ). Módulo de formación http://hws.vhebron.net/resistenciazero/descargas/MODULO%20DE%20FORMACION%20EN%20RZ_19_03_2014.pdf
3. WHO. Global Action Plan on Antimicrobial Resistance. Geneva: WHO; 2015. http://apps.who.int/iris/bitstream/handle/10665/193736/9789241509763_eng.pdf?sequence=1 (accessed Feb 12, 2018).

Topic: Infections and prevention

001384

Therapeutic plasmapheresis in the treatment of hypertriglyceridemia induced acute pancreatitis—the experience of a small portuguese center

C. Costa¹, M. Teixeira², C. Santos¹, A. Barbosa¹, B. Rodrigues¹, F. Rita¹, S. Rosado¹, J. Pacheco Pereira¹, C. Meneses-Oliveira¹, C. Simões Pereira¹

¹Intensive Care Medicine, Hospital Beatriz Ângelo, Loures, Portugal;

²Gastroenterology, Hospital de São Bernardo, Setúbal, Portugal

Correspondence: C. Costa

Intensive Care Medicine Experimental 2023, **11 (Suppl 1)**:001384

Introduction: Acute pancreatitis (AP) is a serious and potentially deadly condition and in up to 14% of the cases can be caused by hypertriglyceridemia. The risk of AP is higher in cases of severe hypertriglyceridemia (> 1000 mg/dL) and the severity of the disease is proportional to the elevation of the triglycerides. The presentation is like other causes of pancreatitis. The mortality rate is higher in the first 15 days due to the systemic inflammatory response syndrome and after this period the major causes of mortality are the complications of the disease (local or systemic).

Objectives: The aim of this study was to review all the cases of acute pancreatitis secondary to hypertriglyceridemia submitted to therapeutic plasmapheresis sessions in an intensive care unit (ICU).

Methods: This is an observational retrospective study conducted between April 2012 and March 2023 that included all the patients with AP by hypertriglyceridemia submitted to plasmapheresis sessions in the ICU. Only patients who underwent plasmapheresis outside the ICU were excluded.

Results: Of 18 patients, 88% were men (n = 16), with a median age of 43 years. The median body mass index of these patients was 28,43 kg/m². The median APACHE II score was 8,3, that represent a predicted in-hospital mortality rate of 8% for nonoperative patients. All the selected patients had severe hypertriglyceridemia at admission and 33% (n = 6) had triglycerides over 4400 mg/dL. A total of 26 plasmapheresis sessions were carried out in the intensive care unit. Most patients did only one session (n = 12, 66,7%) but one third needed two sessions (n = 6). The most used replacement solutions were albumin (n = 11, 42,3%) and albumin/crystalloid (n = 11, 42,3%), followed by fresh frozen plasma (FFP) (n = 3, 11,5%) and a combination of albumin/crystalloid/FFP (n = 1, 3,8%). The reduction of the hypertriglyceridemia was effective, mainly over 50% (n = 21) and in some cases over 90% (n = 2). There were registered 22 interruptions of treatments, mainly for rupture of the filter (n = 13, n = 59%). The most frequent complication was hydroelectrolytic disturbances (n = 6, 23,1%) and coagulopathy or thrombocytopenia (n = 5, 19,2%), but there were no major complications that lead to interrupt the treatment.

Conclusions: Therapeutic plasmapheresis is a complex technique but effective in the treatment of acute pancreatitis by hypertriglyceridemia and is recommended as a first line treatment by the American Society for Apheresis for the treatment of the AP cases associated with severe hypertriglyceridemia. There were no severe complications related to the technique.

References

1. Stefanutti, C. et al., "Severe Hypertriglyceridemia-Related Acute Pancreatitis", *Therapeutic Apheresis and Dialysis* 2013; 17 (2):130–137
2. Faria, R. et al., "Therapeutic Plasmapheresis: Seven Year Experience of an Intensive Care Unit in Portugal", *Acta Med Port* 2022 Mar;35 (3):176–183
3. Rawla, P. "Hypertriglyceridemia-induced pancreatitis: updated review of current treatment and preventive strategies", *Clin J Gastroenterol*. 2018 Dec;11 (6):441–448.
4. Banks PA, "Practice guidelines in acute pancreatitis.", *Am J Gastroenterol*. 2006;101 (10):2379
5. Padmanabhan, A et al., "Guidelines on the Use of Therapeutic Apheresis in Clinical Practice", *J Clin Apher*. 2019;34:171–354.
6. There was no external funding supporting this article.

Topic: Metabolism, endocrinology, liver failure and nutrition

001385

Adjusting the baseline immunosuppressive regimen in renal transplant recipients admitted to an intensive care unit is not associated with increased risk of acute rejection and graft loss
F. Côte-Real¹, J. Carvão², L. Mota³, M. B. Peruzzo⁴, J. Medina-Pestana³, L. R. Requião-Moura⁴

¹Serviço de Medicina Intensiva, Hospital Dr. Nélio Mendonça, Funchal, Portugal; ²Nephrology, Hospital Dr. Nélio Mendonça, Funchal, Portugal; ³Nephrology, HRIM-Hospital do Rim, São Paulo, Brazil; ⁴Unidade Terapia Intensiva, HRIM-Hospital do Rim, São Paulo, Brazil

Correspondence: F. Côte-Real

Intensive Care Medicine Experimental 2023, **11 (Suppl 1)**:001385

Introduction: The adjustment of the maintenance immunosuppressive regimen for kidney transplant recipients (KTRs) requiring intensive care management is in continuous discussion.

Objectives: Thus, this study aimed to evaluate the acute rejection risks in KTRs followed until one year after an intensive care unit (ICU) discharge.

Methods: Single-center cohort study that enrolled 376 KTR admitted to the ICU (excluding immediate post-transplant period) between 2018 and 2019. Follow-up date was one year after the ICU admission. Patients were stratified according to immunosuppressive regimen adjustment during the ICU length of stay: sustaining the immunosuppressive regimen with two or three drugs vs. use of corticosteroids alone. The primary outcome was acute rejection (AR), while the secondary was graft loss (GL). The multivariable analysis was performed by logistic regression.

Results: KTRs were 57.4 (46.1–64.8) years old, 61.4% male and 42.8% were receiving tacrolimus, mycophenolate, and prednisone as the maintenance immunosuppressive regimen. Most had acute kidney injury (60.6%), and 19.1% required renal replacement therapy. During the ICU stay, 53.5% underwent corticosteroids alone. The one-year incidence of AR and GL was 4.3% and 9.6%, respectively. Compared with sustaining the immunosuppressive regimen, corticosteroid alone was not associated with a higher incidence of AR (5.7% vs. 3.0%, p = 0.19) or GL (8.0% vs. 10.9%, p = 0.33). In the multivariable analysis, AR after the ICU discharge was only associated with age (OR for each year = 0.96; p = 0.03) and the report of AR before the ICU admission (OR = 16.5; p < 0.001). Changing the immunosuppressive regimen during the ICU stay was not associated with AR.

Conclusions: For the critically ill KTRs admitted to the ICU, the adjustment of maintenance immunosuppressive regimen for corticosteroids alone, compared with sustaining double or triple immunosuppressive regimen was not associated with increased risk of acute rejection or graft loss until 1 year after the ICU discharge.

References

1. Guinault D, Del Bello A, Lavayssiere L, et al. Outcomes of kidney transplant recipients admitted to the intensive care unit: a retrospective study of 200 patients. *BMC Anesthesiol*. 2019 Jul 17;19 (1):130.
2. Staeck, O.; Khadzhyrov, D.; Schmidt, D.; et al. Management of Immunosuppression in Critically Ill Renal Transplant Patients in the ICU: Immunologic and Overall Long-Term Outcome; Transplantation: July 15, 2014—Volume 98—Issue—p 541

Topic: Brain death, organ donation and transplantation

001388

Carboxyhemoglobin, methemoglobin, and total bilirubin as markers for mortality and hemolysis in patients with ARDS and veno-venous ECMO

V. Bünger¹, O. Hunsicker¹, A. Krannich², F. Balzer³, C. Spies⁴, WM. Kuebler⁵, S. Weber-Carstens⁶, M. Menk⁷, J. Graw⁸

¹Department of Anesthesiology and Operative Intensive Care Medicine (ccm, cvk), Charité-Universitätsmedizin Berlin, Berlin, Germany; ²Clinical Trial Office, Charité-Universitätsmedizin Berlin, Berlin, Germany;

³Department of Medical Informatics, Charité-Universitätsmedizin Berlin, Berlin, Germany; ⁴Anesthesiology and Operative Intensive Care, Charité-Universitätsmedizin Berlin, Berlin, Germany; ⁵Institute of Physiology, Charité-Universitätsmedizin Berlin, Berlin, Germany;

⁶Department of Anesthesiology and Intensive Care Medicine, Charité-Universitätsmedizin Berlin, Berlin, Germany; ⁷Department of anesthesiology and operative intensive care medicine (ccm, cvk), Universitätsklinikum Dresden, Dresden, Germany; ⁸Anesthesia and Intensive Care, University Hospital Of Ulm, Ulm, Germany

Correspondence: J. Graw

Intensive Care Medicine Experimental 2023, **11 (Suppl 1)**:001388

Introduction: Hemolysis is common in intensive care patients and associated with adverse outcomes and mortality. Beside direct and precise but not routinely measured markers for hemolysis such as cell-free hemoglobin (CFH) and haptoglobin (Hp), other CFH-downstream products like carboxyhemoglobin (CO-Hb), methemoglobin (Met-Hb), and total bilirubin (tBili) are routinely monitored via blood gas analysis. Previous studies suggest an association of tBili and CO-Hb with hemolysis and mortality. Patients with ARDS and treatment with veno-venous ECMO (VV ECMO) are especially prone to hemolysis and might benefit from early detection of increased hemolysis and potential reactions to the causes of hemolysis.

Objectives: We aimed to identify cut-off values for CO-Hb, Met-Hb, and tBili that are associated with a significant increase of mortality in patients with severe ARDS and treatment with VV-ECMO.

Methods: Retrospective analysis of patients with ARDS admitted to a tertiary ARDS referral center from 01/2007 to 12/2018. All patients with CO-Hb, Met-Hb, tBili, Hp and CFH measurements within the first week of ECMO treatment were included. Cut-off values of mean

CO-Hb, mean Met-Hb and mean tBili concentrations over therapy time associated with significant increases in ICU mortality were calculated with recursive binary partitioning. If more than one splitting node was found, only the most significant, first cut-off value was considered. Patients were grouped according to their respective mean CO-Hb, mean Met-Hb, and mean tBili values. ICU mortality, mean CFH and mean Hp values were compared. A multivariate regression model of ICU mortality and the three marker variables with their cut-off values was implemented. The study was approved by the Medical Ethics Committee of the Charité-Universitätsmedizin Berlin (No. EA2/019/19).

Results: A total of 435 patients was included. For mean CO-Hb, a cut-off value of 2.007 was found to divide the cohort into two groups with significantly different ICU mortality (CO-Hb \leq 2.007%: 37% [95% CI 31.2–44.1], n = 227 vs. CO-Hb > 2.007%: 63% [56.5–69.9], n = 208, p < 0.001). For mean Met-Hb, a cut-off value of 1.255 was calculated (Met-Hb \leq 1.255%: 45% [39.4–50.1], n = 347 vs. Met-Hb > 1.255%: 70% [59.6–79.5], n = 88, p < 0.001) and for tBili a first significant cut-off value was found at 8.386 mg/dl (tBili \leq 8.386 mg/dl: 43% [37.7–48.2], n = 361 vs. tBili > 8.386 mg/dl: 85% [75.5–92.0], n = 74, p < 0.001). Besides from mortality, all groups differed significantly in mean Hp (CO-Hb \leq 2.007%: 0.75 g/l [IQR 0.34, 1.38] vs. CO-Hb > 2.007%: 0.47 g/l [0.23, 0.75], p < 0.001; Met-Hb \leq 1.255%: 0.64 g/l [IQR 0.32, 1.15] vs. Met-Hb > 1.255%: 0.35 g/l [0.20, 0.67], p < 0.001 and tBili \leq 0.957 mg/dl: 0.66 g/l [IQR 0.34, 1.18] vs. tBili > 0.957 mg/dl: 0.25 g/l [0.13, 0.44], p < 0.001). For the direct hemolysis marker mean CFH, only the Met-Hb and tBili groups differed significantly (Met-Hb \leq 1.255%: 7.64 mg/dl [IQR 5.21–13.03] vs. Met-Hb > 1.255%: 13.14 mg/dl [8.52–31.00], p < 0.001 and tBili \leq 8.386 mg/dl: 8.33 mg/dl [IQR 5.51, 14.06] vs. tBili > 8.386 mg/dl: 11.48 mg/dl [5.40, 19.35], p = 0.045). The cut-off values were independently and significantly associated with ICU mortality in the multivariate regression model (CO-Hb: OR 3.23 [95% CI 2.12–4.99], p < 0.001; Met-Hb: 3.36 [1.95–5.90], p < 0.001; tBili 7.13 [3.68–15.02], p < 0.001).

Conclusions: CO-Hb, Met-Hb and tBili are independently associated with hemolysis and mortality in patients with ARDS and treatment with VV ECMO. These easily and rapidly measurable routine laboratory parameters might help to identify patients at risk or trigger timely measurement of the direct hemolysis parameters CFH and Hp.

Topic: Acute respiratory failure and mechanical ventilation

001389

Hypokalemia during treatment of diabetic ketoacidosis.

A retrospective analysis

A. Miller¹, S. Darawshi², M. Qassum³, I. Hochberg²

¹Medical Intensive Care Unit, Rambam Healthcare Campus, Haifa, Israel;

²Institute of Endocrinology, Diabetes and Metabolism, Rambam Health Care Campus, Haifa, Israel; ³Cardiology, Rambam Health Care Campus, Haifa, Israel

Correspondence: A. Miller

Intensive Care Medicine Experimental 2023, **11** (Suppl 1):001389

Introduction: Patients with diabetic ketoacidosis (DKA) are often potassium depleted. Although routine treatment of DKA frequently includes intravenous potassium, patients are prone to hypokalemia during treatment. The reasons of hypokalemia are multifactorial, mainly kaliuresis, inadequate oral intake and gastrointestinal losses in addition to insulin supplementation during treatment. There is a concern that hypokalemia during DKA treatment can lead to hazardous adverse events including arrhythmias and sudden cardiac death, but the actual effect of occurrence of hypokalemia during DKA treatment on mortality has not been well characterized. In this study, we assessed the outcomes of DKA hospitalizations whenever hypokalemia was present or not.

Objectives: To determine whether hypokalemia has deleterious effects during the treatment of DKA.

Methods: Using MDCOne®, we retrieved all hospitalizations of adult patients (age over 18) with moderate or severe DKA (defined by a combination of clinical diagnosis of DKA in the electronic medical record, pH under 7.3, glucose > 250 mg/dl and IV insulin treatment) in Rambam medical center, a tertiary 1000-bed academic medical center between 2/2012–1/2020 and compared demographic variables, anthropometric variables, hospitalization variables, blood tests throughout admissions, 30 day mortality and total mortality between patients who did or did not develop hypokalemia.

Results: Results: In the defined time period, there were 456 DKA hospitalizations that filled all criteria and had no missing data. About two thirds of hospitalizations (304) were complicated by hypokalemia (Potassium < 3.5 meq/L within the 3 days before or after the time of the lowest pH). Compared to patients who did not develop hypokalemia, patients who did were, on average, younger (46.3 ± 19.3 vs 52.3 ± 21.5, p = 0.003), had a lower pH (7.08 ± 0.14 vs 7.15 ± 0.11 p < 0.001), lower bicarbonate (8.99 ± 4.50 vs 12.3 ± 4.11, p < 0.001) and a significantly higher rate of patients who developed hypokalemia were admitted to ICU (36.8% vs 13.8%, p < 0.01), and higher maximal creatinine (2.18 ± 1.6 vs 1.82 ± 1.36, p < 0.05). In addition hypokalemia during DKA treatment was associated with a longer hospital stay.

The 30 day mortality was similar between the two groups (6.3% in the hypokalemia and 7.9% in normokalemia, P = 0.55) as was long term mortality (26.6% and 33.6% respectively, P = 0.13).

Conclusions: Hypokalemia occurs commonly during treatment of moderate to severe DKA and is associated with lower pH and bicarbonate, acute renal failure and higher rate of ICU admissions. However, it is not associated a higher short or long-term mortality.

References

- Misra S, Oliver NS. Diabetic ketoacidosis in adults. *BMJ*. 2015;351:h5660. <https://doi.org/10.1136/bmj.h5660>
- Kitabchi AE, Umpierrez GE, Miles JM, Fisher JN. Hyperglycemic crises in adult patients with diabetes. *Diabetes Care*. 2009;32 (7):1335–1343. <https://doi.org/10.2337/dc09-9032>
- Gosmanov AR, Gosmanova EO, Kitabchi AE. Hyperglycemic Crises: Diabetic Ketoacidosis (DKA), And Hyperglycemic Hyperosmolar State (HHS). In: Feingold KR, Anawalt B, Boyce A, et al., eds. *Endotext*. South Dartmouth (MA): MDText.com, Inc.; 2000. <http://www.ncbi.nlm.nih.gov/books/NBK279052/>. Accessed December 7, 2019.
- Lin S-F, Lin J-D, Huang Y-Y. Diabetic ketoacidosis: comparisons of patient characteristics, clinical presentations and outcomes today and 20 years ago. *Chang Gung Med J*. 2005;28 (1):24–30.
- Otieno CF, Kayima JK, Omonge EO, Oyoo GO. Diabetic ketoacidosis: risk factors, mechanisms and management strategies in sub-Saharan Africa: a review. *East Afr Med J*. 2005 Dec;82 (12 Suppl):S197–203. Review | PROF. KAYIMA JOSHUA K. <https://profiles.uonbi.ac.ke/joshuakayima/publications/otieno-cf-kayima-jk-omonge-eo-oyoo-godiabetic-ketoacidosis-risk-factors-me>. Accessed December 7, 2019.
- Powers AC, Stafford JM, Rickels MR. Diabetes Mellitus: Complications. In: Jameson JL, Fauci AS, Kasper DL, Hauser SL, Longo DL, Loscalzo J, eds. *Harrison's Principles of Internal Medicine*. 20th ed. New York, NY: McGraw-Hill Education; 2018. [accessmedicine.com/content.aspx?aid=1,155,956,247](https://www.accessmedicine.com/content.aspx?aid=1,155,956,247). Accessed December 7, 2019.
- Management-of-DKA-241013.pdf. <https://www.diabetes.org.uk/resources-s3/2017-09/Management-of-DKA-241013.pdf>. Accessed December 7, 2019.
- Usman A. Initial Potassium Replacement in Diabetic Ketoacidosis: The Unnoticed Area of Gap. *Front Endocrinol*. 2018;9. <https://doi.org/10.3389/fendo.2018.00109>
- Kardalas E, Paschou SA, Anagnostis P, Muscogiuri G, Siasos G, Vryonidou A. Hypokalemia: a clinical update. *Endocr Connect*. 2018;7 (4):R135–R146. <https://doi.org/10.1530/EC-18-0109>
- Ramaesh A. Incidence and long-term outcomes of adult patients with diabetic ketoacidosis admitted to intensive care: A retrospective cohort study. *J Intensive Care Soc*. 2016;17 (3):222–233. <https://doi.org/10.1177/1751143716644458>
- Guisado-Vasco, P et al. Clinical features, mortality, hospital admission, and length of stay of a cohort of adult patients with diabetic ketoacidosis attending the emergency room of a tertiary hospital in Spain. *Endocrinol Nutr* 62, 277–284 (2015).

Topic: Metabolism, endocrinology, liver failure and nutrition

001390

Specialized medical training and clinical simulation in extracorporeal membrane oxygenation: a new interesting horizon

Y. Chicote Carasa¹, J. L. PerezVela¹, R. Munoz-Calahorra¹, E. Burgui-Gualda¹, J. L. Flordelis Lasierra¹, L. J. Terceros Almanza¹, E. Renes Carreño¹
¹Intensive Care Medicine, University Hospital 12 de Octubre, Madrid, Spain

Correspondence: Y. Chicote Carasa
 Intensive Care Medicine Experimental 2023, 11 (Suppl 1):001390

Introduction: Extracorporeal membrane oxygenation (ECMO), is a cardiocirculatory and pulmonary support that began to be used at the end of the last century; but this complex medical tool requires specialized training for its daily management and control of complications, to this day, including tools such as advanced clinic simulation in ECMO.

Objectives: The objective was to evaluate the satisfaction, the perceived quality, as well as the methodology and teaching staff of 6 theoretical-practical courses on ECMO support based on advanced clinical simulation, to objectify the viability, interest, and quality of this interesting training model.

Methods: 6 theoretical-practical training courses were carried out, including high-fidelity clinical simulation workshops on ECMO between 2017 and 2023 (4 face-to-face courses and 2 in a mixed online and face-to-face format, that is, a hybrid model). Retrospective descriptive study, for which, after each course, the participants completed a satisfaction survey in which they had to assess satisfaction with the course, the contents, and the teachers, rating from 1 (worst score) to 5 (best score). Statistical analysis was performed with SPSS v24, using quantitative variables that were expressed as mean and SD.

Results: We carry out the training of 161 students, of which 135 answered the survey (83.8%). After the descriptive analysis (Table 1) we found that the courses reach the expectations of the students, with high satisfaction and overall assessment.

The very favorable score in the active participation of the students during the course stands out, one of the objectives sought with the methodology used, clinical simulation. Similarly, we highlight the interest and value of clinical simulation workshops with ECMO. Finally, the teaching staff and the simulation method carried out also received very positive evaluations.

Questions	Mean	Standar deviation
The course has reach your expectations	4.41	0.66
Overall satisfaction with the course	4.63	0.06
Interest of the topics covered	4.20	0.76
Understanding of theoretical aspects	4.46	0.58
Possibility of participation in workshops/exhibitions	4.75	0.50
Integration of teachers with assistants	4.63	0.59
General evaluation of the teaching staff of the theoretical topics	4.51	0.55
General evaluation of the teachers of the workshops	4.50	0.52
Possibility of practical application	4.38	0.64
The methodology has been adequate	4.27	0.70
ECMO clinical simulation workshop	4.20	0.76

Conclusions: The experience with a high number of participants shows the interest and feasibility of clinical simulation as a teaching tool. The ability to maintain these training models with ECMO simulation over time should encourage us to continue carrying out this type

of training activities, especially in the field of clinical simulation, essential in highly complex techniques such as ECMO.

Topic: Translational Medicine

001391

Correlation of creatinine value with duration of mechanical ventilation and outcome in neurosurgical patients admitted to the ICU

M. Habjanović¹, K. Kralik², D. Mandic³, A. Cicvaric⁴, T. J. Glavas⁴, S. Kvolik⁴
¹Medical Faculty, JJ Strossmayer University, Osijek, Croatia; ²Medical Faculty, JJ Strossmayer University, Osijek, Croatia; ³Department for clinical and laboratory diagnostics, Osijek University Hospital; Medical Faculty, Osijek, Croatia; ⁴Anesthesiology and ICU, Osijek University Hospital; Medical Faculty, Osijek, Croatia

Correspondence: S. Kvolik
 Intensive Care Medicine Experimental 2023, 11 (Suppl 1):001391

Introduction: Creatinine (Cr) is a breakdown product of creatine phosphate from muscle and protein metabolism. It is removed from the body mainly by glomerular filtration and is also an indicator of kidney function. While elevated creatinine values are commonly associated with inflammation, low creatinine values may be associated with lower body weight, lower muscle mass, or immobility.

Objectives: The aim of this work is to confirm whether high or low Cr values were associated with the length of mechanical ventilation (MV) and mortality in neurosurgical patients admitted to the intensive care unit (ICU).

Methods: All neurosurgical patients admitted to the ICU from January 1, 2021, to September 30, 2022, were included in the analysis. Cr values ($\mu\text{mol/L}$) were normalized according to reference values for age and gender in all patients and were classified as low, normal, and high for specific analyses. The initial values of Cr were analyzed, as well as the repeated results of Cr measurements of those patients who stayed longer in the ICU. The lowest (Cr-min) and highest (Cr-max) values were recorded as well as the day of stay on which this value was measured. An association of these values with the duration of MV and survival was calculated.

Results: A cohort of 190 patients, 95 men, and 95 women, were admitted to the ICU. Total survival was 91.1% and the length of mechanical ventilation was 6 h [3–24 h]. Median baseline Cr values on admission did not differ between survivors and nonsurvivors (62 [48.0–79.0] vs. 80 [56.5–131.5], Mann Whitney U test (MW), $P=0.05$). Nonsurvivors had higher Cr-max during the ICU stay compared to survivors (73 [58.5–101.5] vs. 151.5 [73.3–172.3], MW, $P=0.01$). A significant, negative correlation was recorded between Cr and length of mechanical ventilation (Spearman's $\rho=-0.266$, $P=0.03$), which confirmed shorter MV in patients with higher Cr levels.

For patients who had a decrease in Cr during the ICU stay, MV was significantly longer than in those who did not have a decrease ($\rho=0.337$, $P<0.001$). After the patients were classified according to the Cr-min values into groups with low, normal, and high creatinine values, the mortality during the ICU treatment was highest in the group with Cr-min in the low range vs groups with normal and higher Cr (56.3%, 25 and 18.8%, χ^2 test, $P=0.03$).

Conclusions: High values of the Cr-max in nonsurvivors suggest the existence of an acute muscle and kidney lesion and were most likely a manifestation of infections. Increased mortality in the group with Cr below the reference range can be associated with acquired muscle weakness in the ICU and was observed in patients who had prolonged MV. In addition to acute brain injury, muscle weakness may result from comorbidities. New studies should confirm the possibility of new treatment methods, such as physiotherapy, in preventing the onset of muscle weakness and the consequent drop in Cr values.

References

1. Thongprayoon C. et al. Sci Rep. 2019 Dec 10;9 (1):18,743. <https://doi.org/10.1038/s41598-019-55362-w>.
2. IP11-23 Medical faculty, University JJ. Strossmayer in Osijek, Croatia

Topic: Neurointensive care

001392

Fast duration before nutritional support initiation, hypophosphatemia and mortality in critically ill patients

L. Statlender¹, O. Raphaeli², M. Hellerman Itzhaki¹, I. Kagan¹, T. Shochat³, P. Singer¹

¹Intensive Care Unit, Rabin Medical Center, Petakh Tikva, Israel;

²Industrial Engineering and Management, Ariel University, Ariel, Israel;

³Epidemiology, Rabin Medical Center, Petah Tikva, Israel

Correspondence: L. Statlender

Intensive Care Medicine Experimental 2023, **11 (Suppl 1):**001392

Introduction: Hypophosphatemia is a major concern during the initiation of nutritional support. We evaluated the correlation between fast duration before nutritional support initiation and hypophosphatemia occurrence during ICU admission and its effect on mortality.

Methods: A retrospective analysis that included ventilated for >48 h patients' data who were admitted to a 16-beds mixed ICU. Data collected included demographic, APACHE-2 admission score, SOFA score at 24 h, hourly energy delivered & plasma phosphate levels from the first two weeks of admission, insulin delivered, length of ICU stay, length of ventilation, and mortality (ICU and 90 days). A survival analysis with competing risks was performed. Baseline characteristics and clinical outcomes were compared with Mann-Whitney or Chi-square tests.

Results: 462 patients were used in the analysis. 59.96% of the patients developed hypophosphatemia. They were younger (57.4 vs 61.3, $p < 0.001$), less obese (BMI 27.0 vs 29.3, $p < 0.001$), had lower APACHE II (21.6 vs 22.8, $p < 0.001$), lower kidney SOFA score (0.64 vs 1.26, $p < 0.001$), and higher SOFA score (8.61 vs 8.34, $p < 0.004$). They had less prevalence of diabetes (13.3% vs 23.3%, $p < 0.005$). Their admission time before ICU admission was lower (3.42 vs 6.17d, $p < 0.0001$).

Surviving analysis with hypophosphatemia as a competing risk showed a protective effect of hypophosphatemia from mortality (HR 0.447, 95% CI 0.281, 0.712). Age, APACHE2 and SOFA score were found to be significantly associated with ICU mortality.

Evaluation of patients by several comparisons of minimal fast durations (at 12h intervals of fasting up to 72 h) demonstrated that hypophosphatemia prevalence was lower in the patients who were fasting (in each starvation duration—12h, 24h, 36h, up to 72 h) compared to those who were not fasting. Hypophosphatemia prevalence ranged from 26.08% (72h fast) to 54.65% (12h fast) compared to 35.43% (not fasting 72h) to 67.03% (not fasting 12h). These differences in hypophosphatemia prevalence were not significant.

Time to hypophosphatemia appearance was significantly longer in the fasting patients compared to those who were not fasting, at all starvation duration examined up to fast of 48h (e.g.: time to hypophosphatemia was 90.59h in the patients who fasted for 24h, vs 79.7h in the patients that did not fast for 24h ($p = 0.004$)).

Conclusions: Duration of starvation for up to 72 h in ICU before starting nutritional support did not effect hypophosphatemia occurrence. However, time to appearance of hypophosphatemia was longer in the fasting patients. Hypophosphatemia had a protective effect against mortality.

Topic: Metabolism, endocrinology, liver failure and nutrition

001393

Fibrinolysis resistance duration after tranexamic acid administration: how is it affected by renal insufficiency?

A. Párkányi¹, E. Biró¹, D. Skultéti¹, E. Kovács¹, A. Fehér², A. Kállai¹, Z. Iványi¹, J. Fazakas¹, J. Gál¹

¹Department of Anesthesiology and Intensive Therapy, Semmelweis University, Budapest, Hungary; ²Department of Laboratory Medicine, Semmelweis University, Budapest, Hungary

Correspondence: A. Kállai

Intensive Care Medicine Experimental 2023, **11 (Suppl 1):**001393

Introduction: Tranexamic acid (TXA) is often used during acute bleeding management in order to inhibit fibrinolysis. According to summary of product characteristics, the elimination half-life of TXA is approximately 3 h [1]. However, it can be prolonged in case of renal insufficiency. The TPA-test from ClotPro system provides a way to examine the inhibition of fibrinolysis, even in case of the administration of TXA.

Objectives: We used the TPA-test to examine the presence of fibrinolysis inhibition in patients who received TXA as part of bleeding management upon admission to the intensive care unit.

Methods: In our retrospective observational study data were collected from patients at the Central ICU of the Department of Anaesthesiology and Intensive Therapy at Semmelweis University. The patients received TXA as part of acute haemorrhage treatment or to lower the risk of potential bleeding during or prior to admission. The route of administration of the drug varied among the cases (chronic oral, intravenous, nasogastric, intratracheal). Only patients with at least two TPA test results were enrolled in the study, who were divided into two groups according to renal function (RI vs nonRI).

Categories for fibrinolysis resistance were defined based on the TPA test results: complete lysis resistance if maximum lysis (ML) < 12%, severe if ML 12%–50%, moderate if ML > 50% with lysis time (LT) > 900s, and mild if 900s > LT > 300s.

To compare the groups Mann-Whitney U (MW) test was applied.

Results: Altogether 17 patients were eligible (female/male: 14/3; mean age: 49,48 ± 16,57). 0.14 patients have received intravenous TXA, in 3 cases the route of administration was either nasogastric, intratracheal or prior to admission regularly oral. In patients with either acute or chronic renal insufficiency, the complete fibrinolysis resistance has persisted significantly longer after the intravenous TXA administration (difference of medians: 81 h, $p = 0.004$).

During ICU treatment, newly onset RI was detected in four cases. One patient passed away, and two patients became chronic haemodialysis dependent. In the fourth case, complete remission of fibrinolysis resistance was observed following a course of plasma exchange beside the slow restoration of kidney function.

In cases of chronic oral, nasogastric or intratracheal administration, persistent complete fibrinolysis resistance was observed between 50–130 h.

Conclusions: Tranexamic acid administration in case of renal insufficiency, can result in prolonged inhibition of fibrinolysis and may play a role in the development of permanent organ failure [2]. Further studies are needed to examine whether the reversal of prolonged fibrinolysis inhibition induced by TXA improves patients' long-term outcomes and quality of life.

References

- 1: Summary of Product Characteristics and Package Leaflet—Tranexamic acid (European Medicines Agency)
- 2: Coupland, L.A., Rabbolini, D.J., Schoenecker, J.G. et al. Point-of-care diagnosis and monitoring of fibrinolysis resistance in the critically ill: results from a feasibility study. *Crit Care* 27, 55 (2023).
- 3: Another randomised study of the investigators is supported with reagents of the ClotPro® system by Diacare Solutions Kft.

Topic: Poisoning/Toxicology/Pharmacology

001394

Endogenous NO inhibition by ADMA during early phase of ICU admission

K. Myglegård Mortensen¹, T. S. Itenov², J. Stensballe³, M. H. Bestle¹

¹Department of Anesthesiology and Intensive Care, Copenhagen University Hospital-North Zealand, Copenhagen, Denmark; ²Department of Anaesthesiology and Intensive Care, Bispebjerg and Frederiksberg Hospitals, Copenhagen, Denmark; ³Department of Anesthesiology, Surgery and Trauma Center and Section of Tranfusion Medicine, Copenhagen University Hospital, Rigshospitalet, Copenhagen, Denmark

Correspondence: K. Myglegård Mortensen

Intensive Care Medicine Experimental 2023, **11 (Suppl 1):**001394

Introduction: Circulatory instability is commonly observed in patients admitted to Intensive Care Units (ICU). Nitric oxide (NO) is a vasodilator and the production is upregulated during critical illness (1). Asymmetric dimethylarginine (ADMA) is an endogenous inhibitor of NO production. Admission plasma concentrations of ADMA is increased in critically ill patients compared to healthy controls (2) and the increase is associated with mortality (2,3). The time course needs to be further investigated to decide for clinical relevance and potential of future intervention.

Objectives: The aim of this research project is to determine how endogenous NO-synthase inhibition, as measured by plasma ADMA, varies over the first five days of ICU admission, and identify subgroups with distinctive patterns.

Methods: We included adult patients admitted to the ICU of Copenhagen University Hospital—North Zealand from November 2016 to June 2019. We took blood samples during the first five days of admission. Plasma concentration of ADMA was analysed with enzyme-linked immunosorbent assay (ELISA). In subgroup analyses we further investigated the time course of plasma ADMA in patients with septic shock vs. without septic shock, in different stages of endotheliopathy (soluble thrombomodulin (sTM) <4 ng/ml vs. 4–10 ng/ml vs. >10 ng/ml), patients treated with dialysis vs. no dialysis and patients with acute kidney injury (AKI) vs. no AKI. We used linear mixed models to describe the time course of plasma ADMA and tested for subgroup effect using interaction tests.

Results: We included 567 mixed ICU patients with a total of 1924 blood samples. Median age was 71 years (interquartile range (IQR) 63–79 years) and 327 (57.7%) were male. Median SAPS 3 score was 64 (IQR 56–73). Plasma ADMA concentration increased during the first five days of ICU admission ($p < 0.001$), Figure 1. In subgroup analyses patients with AKI had significantly higher ADMA concentrations at ICU day 1 compared to patients without AKI ($p < 0.001$), however time course in the two groups were similar ($p = 0.854$), Fig. 2A. Likewise, patients with severe endotheliopathy (sTM >10 ng/ml) had significantly higher day 1 ADMA concentrations compared to patients with plasma sTM <4 ng/ml or 4–10 ng/ml ($p = 0.026$), Fig. 2B. Interaction between time and sTM group was non-significant ($p = 0.584$). When grouped by the need for dialysis at any day during the first five days of ICU admission there was both significant different ADMA concentrations at day 1 ($p = 0.014$) and significant different time courses ($p = 0.017$), Fig. 2C. The subgroup of patients with septic shock did not differ from the rest of the patients neither at baseline nor in time course ($p = 0.665$ and $p = 0.207$, respectively), Fig. 2D.

Conclusions: Endogenous NO inhibition, as measured by ADMA, increase during the first five days of ICU admission, and is amplified by AKI and endotheliopathy.

Figure 1: Time course of plasma ADMA concentration during the first five days of ICU admission. Median and interquartile range.

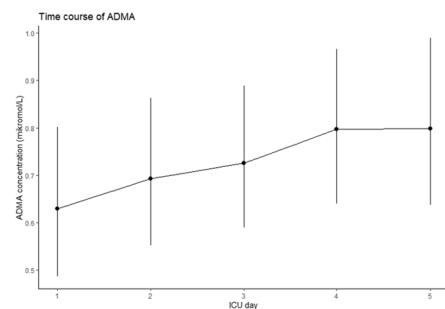
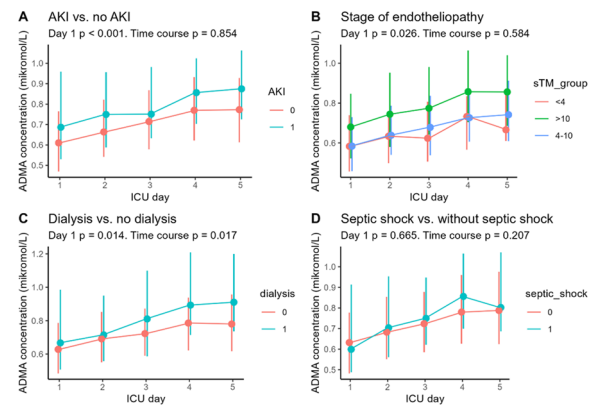

Figure 2: Time course of plasma ADMA concentration in different subgroups during the first five days of ICU admission. Median and interquartile range.



References

1. P. A. Messerschmidt og Hustrus Fond, Denmark
2. 3) Mortensen, K. M. et al. Shock 46, 365–372 (2016)
3. 2) Koch, A. et al. J. Crit. Care 28, 947–53 (2013)
4. 1) Lambden, S. et al. Crit. Care 22, 174 (2018)
5. Research Grant from Nordsjællands Hospital (Copenhagen University Hospital—North Zealand)
6. Toyota-Fonden, Denmark
7. Fonden til Lægevidenskabens Fremme, A.P. Møller Fonden, Denmark
8. Fru Olga Bryde Nielsens Fond, Denmark
9. Frimodt-Heineke Fonden, Denmark

Topic: Cardiovascular issues in ICU

001395

Effects of prone position on lung mechanics in acute respiratory distress syndrome differ according to the recruitment-to-inflation ratio in supine position: prospective observational EVALPRO Study

C. Lai¹, R. Shi¹, L. Jelinski¹, F. Lardet¹, M. Fasan¹, S. Ayed¹, H. Belotti¹, N. Biard¹, L. Guerin¹, N. Fage¹, Q. Fossé¹, T. Gobe¹, A. Pavot¹, G. Roger¹, A. Yhuel¹, T. Pham¹, J. L. Teboul¹, X. Monnet¹

¹Service de Médecine Intensive-Réanimation, Hôpital de Bicêtre, Université Paris-Saclay-Faculty of Medicine, Le Kremlin-Bicêtre, France

Correspondence: C. Lai

Intensive Care Medicine Experimental 2023, 11 (Suppl 1):001395

Introduction: Improvement in oxygenation with prone position in patients with acute respiratory distress syndrome related to Coronavirus disease 2019 (C-ARDS) are inconstant. One of the other beneficial respiratory effects of prone position could be secondary to improvement in lung mechanics. However, these improvements are inconstant. Variables predicting the efficacy a priori before starting the prone position session could be useful.

Objectives: To investigate whether a significant improvement of the compliance of the respiratory system (Cr_s) and reduction of the driving pressure at the end of a prone position session is predicted by the potential of lung recruitment at baseline in supine position.

Methods: In this prospective, observational, monocentric study in patients who underwent prone position for C-ARDS, from January to

May 2021, respiratory variables were assessed just before prone positioning and at the end of the session. Respiratory variables included mechanical ventilation settings and variables of respiratory mechanics, including the recruitment-to-inflation ratio (R/I), an estimate of the potential of lung recruitment compared to lung overinflation.

Results: In 41 patients, 156 prone position sessions lasting 18.9 ± 2.7 h, were evaluated. Mortality at day 60 was 49%. Neuromuscular blockade agents were used in 91 (58%) sessions. At baseline, tidal volume was 6.1 ± 0.5 mL/kg of predicted body weight, PEEP was 14 ± 3 cmH₂O and plateau pressure was 29 ± 4 cmH₂O. The median of the R/I ratio was 0.53 (0.31–0.79), separating low- and high-recruiters. The airway opening pressure was present in 76 (49%) patients and was 6 (5–9) cmH₂O in these patients. At the end of the prone position session PaO₂/FiO₂ increased from 111 ± 31 mmHg to 165 ± 67 mmHg ($p < 0.001$), with an increase > 20 mmHg in 96 (62%) sessions. The driving pressure decreased from 14.3 ± 4.4 to 13.7 ± 4.7 cmH₂O ($p = 0.045$) and Crs increased from 32 ± 11 to 34 ± 11 ($p = 0.037$) ml/cmH₂O. In a multivariate analysis, no respiratory or hemodynamic parameters at baseline could predict the improvement in oxygenation. Whereas the PaO₂/FiO₂ improved to the same extent in both low- and high-recruiters, driving pressure and Crs improved only in high-recruiters (from 14 ± 4 to 12 ± 4 , $p = 0.027$, and from 34 ± 11 to 38 ± 13 , $p = 0.014$, respectively).

Conclusions: Whereas oxygenation improve to the same extend in low- and high-recruiters with prone position in patients with C-ARDS, driving pressure and Crs improve only in high-recruiters patients. Benefits of prone position could be thus even greater in these patients.

Topic: Acute respiratory failure and mechanical ventilation

001396

A comparative study of Acinetobacter baumannii bacteremia in COVID-19 and non-COVID19 critically ill patients

T. Maniathopoulou¹, N. Lajos¹, N. Kazakos¹, A. Papatthanasiou¹, G. Papatthanakos¹, E. Priavali², V. Koulouras¹, I. Andrianopoulos¹

¹Intensive Care Unit, University Hospital of Ioannina, Ioannina, Greece;

²Department of Microbiology, University Hospital of Ioannina, Ioannina, Greece

Correspondence: I. Andrianopoulos

Intensive Care Medicine Experimental 2023, 11 (Suppl 1):001396

Introduction: Acinetobacter baumannii, a multi-drug resistant (MDR) gram negative pathogen, is a common cause of infections in critically ill patients. The COVID-19 pandemic has led to an increase in the incidence of MDR gram- negative infections in critically-ill patients.

Objectives: Our objective was to examine the characteristics and outcome of COVID-19 critically-ill patients with Acinetobacter baumannii bacteremia and compare with a group of non-COVID-19 critically-ill patients.

Methods: We have performed a retrospective single-center study including all consecutively critically ill mechanically ventilated PCR SARS-COV-2 positive patients with Acinetobacter baumannii bacteremia that were admitted in Ioannina University Hospital ICU from 05/2021 to 07/2022. Patients' demographics, comorbidity including Charlson Comorbidity Index, source of bacteremia, ICU length of stay (LOS), ICU mortality and bacteremia complications such as sepsis, ARDS, hepatic dysfunction, coagulopathy or acute kidney injury (AKI) and the need for renal replacement therapy (RRT) were recorded for each patient. The same type of data were gathered from a non-COVID-19 group of critically-ill patients with Acinetobacter baumannii that were admitted in our ICU from 05/2017 to 05/2019. A statistical comparison was performed between the two groups using SPSS[®] 21.

Results: Overall 106 patients (average age of 65.4 ± 13.9 years) with Acinetobacter baumannii bacteremia were included. There were 75 COVID-19 and 31 non-COVID-19 Acinetobacter baumannii bacteremias. Among the two groups there was no difference in terms of age, gender, APACHE II score, Charlson's Comorbidity Index and comorbidities apart from the fact that more non-COVID-19 patients were receiving chronic corticosteroid therapy (1.33% vs 19.3%, $p = 0.003$).

Almost all COVID-19 patients were medical patients (97% vs 77.5%, $p = 0.001$) and were admitted because of acute respiratory failure (96% vs 35.5%, $p = 0.00001$). COVID-19 patients were significantly more likely to have pneumonia as the source of bacteremia compared to the non-COVID19 patients (41.3% vs 16.1%, $p = 0.00001$). Both patient groups developed sepsis in the majority of cases (76% vs 80.6%), but COVID-19 patients developed ARDS (78.7% vs 29%, $p = 0.00001$) and shock (81.3% vs 61.3%, $p = 0.011$) more often. On the other hand COVID-19 patients developed less often Acute Kidney Injury (30.7% vs 58%, $p = 0.007$) and required less frequently RRT (8% vs 32%, $p = 0.001$). Mortality was high among both groups (69.3% vs 80.6%, $p = 0.605$) and there was no difference in the ICU or hospital LOS between the two groups.

Conclusions: Acinetobacter baumannii bacteremia is associated with high mortality in critically ill patients. COVID-19 patients are more likely to have pneumonia as the source of bacteremia and develop more frequently ARDS and shock. Better treatment options are required to improve the survival of these patients.

Topic: Infections and prevention

001399

The clinical value of D-dimer for the diagnosis of deep vein thrombosis in intensive care unit

J. Jeon¹, B. Dabboubi²

¹Intensive Care Medicine, Sheikh Khalifa Specialty Hospital, Ras

Al-Khaimah, United Arab Emirates; ²Abu Dhabi, Seha, Abu Dhabi, France

Correspondence: J. Jeon

Intensive Care Medicine Experimental 2023, 11 (Suppl 1):001399

Introduction: Deep vein thrombosis (DVT) can be safely and reliably excluded in patients with a low clinical probability and a negative D-dimer result, but the accuracy and utility of such a strategy is unclear in intensive care unit (ICU) patients.

Objectives: To determine the utility and limitations of D-dimer testing for the evaluation of lower extremity DVT in ICU patients.

Methods: A retrospective analysis of the medical record evaluating consecutive ICU patients with.

suspected lower extremity DVT between January 2015 and December 2022.

All patients underwent D-dimer test, portable extremity venous ultrasound or CT.

pulmonary embolism and deep vein thrombosis. The diagnostic sensitivity and specificity, positive predictive value (PPV), and negative predictive value (NPV) were evaluated.

Results: A total of 136 patients were evaluated. DVT was diagnosed in 32 patients (26.47%). Although the sensitivity of the D-dimer test was high (96.88%), the specificity was significantly low (4.81%). The PPV was 23.85%, and the NPV was 83.33%.

Conclusions: A negative D-dimer test result in ICU patients does not reliably exclude lower extremity DVT because the NPV of the test is significantly lower in ICU patients.

Table 1 (abstract 001399) Sensitivity, specificity, PPV and NPV of D-dimer

	image (+)	image (-)	Subtotal
D-dimer (+)	31	99	130
D-dimer (-)	1	5	6
Subtotal	32	104	136

Sensitivity(%)	96.88
Specificity(%)	4.81
Accuracy(%)	26.47
Positive predictive value (PPV)(%)	23.85
Negative predictive value (NPV)(%)	83.33
Prevalence(%)	23.53
Odds ratio	1.57
Relative risk	1.43

References

1. Limitations of D-dimer testing in unselected inpatients with suspected venous thromboembolism Daniel J Brotman et al. *Am J Med.* 2003 Mar
2. No conflict of interest

Topic: Cardiovascular issues in ICU

001400

Cholesterol treatment increases cardiac Na⁺/K⁺ ATPase activity and improves dobutamine responsiveness in septic ratsW. Pisciotto¹, T. Saha¹, A. Wu¹, A. Kleyman¹, M. Singer¹¹Bloomsbury Institute of Intensive Care Medicine, University College London, London, United Kingdom**Correspondence:** A. Kleyman
Intensive Care Medicine Experimental 2023, **11 (Suppl 1)**:001400

Introduction: Plasma cholesterol levels drop during sepsis in both patients and our rat model of faecal peritonitis. This model displays increased tachycardia and decreased responsiveness to dobutamine. Septic rats also have decreased cholesterol levels in the cardiomyocyte cell membrane which may impact upon adrenergic receptor activation (1). Na⁺/K⁺ ATPase activity impacts heart rate and cardiac contractility and depends on membrane lipid composition and cholesterol concentration (2). We assessed the impact of restoring membrane cholesterol levels in cardiomyocytes' NKA activity.

Objectives: To assess changes in cardiomyocyte cholesterol content, cardiac NKA activity, and dobutamine responsiveness in septic rats after intravenous cholesterol treatment.

Methods: Awake, instrumented male Wistar rats (300 ± 50 g) received an i.p. injection of faecal slurry. Fluid resuscitation commenced after two hours. At 6 h, baseline haemodynamic measures were performed (BP, echocardiography). Septic animals were then randomly stratified into placebo or cholesterol-treated groups (6–10 per group). Cholesterol-treated animals received a 15-h i.v. infusion of bovine HDL-cholesterol (35 mg cholesterol/rat). Rats were then anaesthetised, allowed to stabilise and haemodynamics were again measured before and after a 10 min infusion of dobutamine (10 mcg/kg/min). Animals were then sacrificed with heart tissue samples immediately frozen in liquid nitrogen. Cardiac NKA activity was measured using a published method (3) while cardiomyocyte membrane cholesterol was measured (after fractionation) by Amplex red. Control animals were treated identically, except for the administration of faecal slurry.

Results: At 21 h, non-treated septic rats had tachycardia, a fall in heart membrane cholesterol, an increase in cardiac NKA activity, and impaired responsiveness to dobutamine. HDL-Cholesterol treatment restored cardiac membrane cholesterol levels, increased NKA activity, and restored dobutamine responsiveness (Table 1).

	Sham	Sepsis	Sepsis + HDL-Ch
Heart rate (beats/min)	409 ± 67	486 ± 42 (a)	451 ± 27
Heart membrane cholesterol (mg chol/mg protein)	0.11 ± 0.02	0.08 ± 0.02 (b)	0.14 ± 0.06
Dobutamine response (% increase in stroke volume)	13.5 ± 12.3	5.5 ± 9.0 (b)	25.9 ± 14.9
NKA activity (mMol/mg protein/min × 10 ⁻³)	3.923 ± 0.93	3.715 ± 0.116	4.402 ± 0.736

a) p < 0.05 vs. sham, (b) p < 0.05 vs. Sepsis + HDL-Chol. One-way ANOVA test with multiple comparisons.

Conclusions: Infusion of HDL-cholesterol reversed the fall in cardiac membrane cholesterol, increased Na⁺/K⁺ ATPase activity and improved dobutamine responsiveness.

References

1. Hofmaenner et al. *Am J Resp Crit Care Med* 2022 Feb 15;205 (4):388–396.
2. P.L.Yeagle et al. *Biochemistry* 1988;27:6449–52
3. Bell et al. *AJP* 2008; 294: H613–21

Topic: Sepsis

001401

Outreach in an ICU and mortality at 28 days and 3 monthsJ. E. Mateus¹, M. P. Vidal¹, G. C. Almeida¹, A. Santos¹, M. Simões¹, P. Casanova¹, P. Martins¹¹Intensive Care Unit, Centro Hospitalar e Universitário de Coimbra, Coimbra, Portugal**Correspondence:** J.E. Mateus*Intensive Care Medicine Experimental* 2023, **11 (Suppl 1)**:001401

Introduction: Demand for ICU resources often exceeds supply. We must ensure that patients who occupy ICU beds are those most likely to benefit from the ICU's specialized technology and professionals. Triage algorithms and protocols can be useful but can never supplant the role of the skilled intensivist who decides whether to admit the patient, always taking into account the structure and size of the ICU in question.

Objectives: Analysis of admission decisions in the ICU of a tertiary hospital and evaluation of the mortality of patients observed in outreach at 28 days and 3 months.

Methods: Analysis of patient observation records by the outreach intensivist at the ICU, from December 1st 2022 to February 28th 2023. The form integrates an algorithm with 5 questions (reversibility of the acute illness, purpose of hospitalization in the ICU, comorbidities, functional reserve and intuitive planning by the intensivist). In addition, hospitalization priority is assigned (P1—ICU level III, P2—ICU level II, P3—ICU Trial, P4—no ICU indication: too well—TW / too bad—TB. Analysis of admission decisions in the ICU, mortality rate at 28 days (M28) and at 3 months (M3M).

Results: The outreach intensivist was requested on 203 occasions (daily average of 2.3 occurrences/day). The main observation sites were the emergency room (43%) and the wards (34%). Most requests occurred during the day (8am–8 pm; 73%). The median age of the patients observed was 71 years, 59% male, mostly due to medical pathology (68%), with acute reversible disease (68%) and with good functional reserve (62%).

P1 was attributed to 36.9% of the patients, P2 to 3.9%, P3 to 2.5% and P4 to 56.6% (TW 20.7%; TB 36.0%). M28 was 45.3% (P1: 34.6%; P2: 25.0%; P3: 80.0%; P4-TW: 9.5%; P4-TB: 76.7%) and M3M of 50.2% (P1: 40.0%; P2: 37.5%; P3: 80.0%; P4-TW: 14.3%; P4-TB: 80.8%).

Both M28 and M3M increased with the degree comorbidities decompensation, with M3M of 54.7% in patients with decompensated comorbidities and 75.0% in those with advanced disease. Functional reserve also negatively influenced both mortality rates, reaching 55.8% in partially dependent patients and 84.2% in totally dependent patients (M3M). There was agreement between 28-day and 3-month mortality and the physician's intuitive prognosis in 82.6% of cases.

Conclusions: Despite the complexity of the decision to admit patients to an ICU, our evaluation algorithm correlated well with hospital mortality. The reversibility of the acute illness, the functional reserve and the comorbidities have an impact on the prognosis and must be taken into account when making the decision. There was agreement between mortality and the intensivist's intuitive prognosis.

References

1. Ramos JGR, Ranzani OT, Perondi B, Dias RD, Jones D, Carvalho CRR, et al. A decision-aid tool for ICU admission triage is associated with a reduction in potentially inappropriate intensive care unit admissions. *J Crit Care* 2019;51:77–83. <https://doi.org/10.1016/j.jccr.2019.02.002>.

- Blanch L, Abillama FF, Amin P, Christian M, Joynt GM, Myburgh J, et al. Triage decisions for ICU admission: Report from the Task Force of the World Federation of Societies of Intensive and Critical Care Medicine. *J Crit Care* 2016;36:301–305. <https://doi.org/10.1016/j.jccr.2016.06.014>.

Topic: Infections and prevention

001404

Infective endocarditis in ICU: a 5 years cross-sectional study

L. Rodrigues de Carvalho¹, F. Reis², DC. Gomes³, G. Jesus⁴, J. Ribeiro⁵
¹Serviço de Medicina Intensiva-Hospital Santa Maria, Centro hospitalar Lisboa Norte, Lisboa, Portugal; ²Serviço de Medicina Intensiva, Hospital de Santa Maria, Lisboa, Portugal; ³Serviço de Medicina Intensiva, Centro Hospitalar Universitário Lisboa Norte-Hospital de Santa Maria, Lisbon, Portugal; ⁴Intensive Medicine Department, Centro Hospitalar Universitário Lisboa Norte, Lisboa, Portugal; ⁵Serviço Medicina Intensiva, Centro Hospitalar Universitário Lisboa Norte, Hospital Santa Maria, Lisboa, Portugal

Correspondence: L. Rodrigues de Carvalho
Intensive Care Medicine Experimental 2023, **11 (Suppl 1)**:001404

Introduction: Infective endocarditis (IE) is an infection of the endothelium of the heart. Patients with the most severe forms of IE demand intensive care management and its characteristics are not so well described, namely complications and prosecution with established guidelines. 1,2

Objectives: Characterization and profile the population of critically ill patients with a diagnosis of IE admitted to our intensive care unit (ICU).

Methods: Cross-sectional investigation including all possible and definite IE cases among patients aged eighteen and over who were admitted to an ICU of a tertiary university hospital between January 2017 and March 2022.

Results: Forty-three patients were included with a mean age of 67 ± 16 (72% male). A definitive and possible diagnosis of IE (applying Duke Criteria) were made in 83.7% and 16.3% of the patients. Mean SOFA at admission was 9.56 and mean SAPS II was 59.72. Mean length of stay in the ICU was 13,60 days. In-hospital and six-month mortality rate were 39.5% and 60.5%, respectively. IE was considered hospital-acquired in 62.8% of the patients and community-acquired in 37.2% of the patients. Risk factor prevalence for IE were central venous catheter for more than 10 days (25.5%), recent immunosuppressive drug treatment (14%), regular dialysis program (14%), valve abnormalities (11.62%) and poor metabolic control (HbA1c > 7%) in patients with diabetes (11.6%). Most patients presented with shock (79.1%), respiratory failure (79.1%) and fever (58%). Vascular phenomena were present in 46.5%, with major arterial emboli (14%) being the most common. Echocardiographic findings showed valvular regurgitation in 46.5% of patients and decreased systolic function in 53.5%. Methicillin-sensitive *Staphylococcus aureus* was the predominant pathogen identified (34.9%). Applying current guidelines, surgical therapy indication was present in 39.5% of the patients, but only 3 patients (7%) were effectively submitted to surgery, with recent stroke being present as a contraindication in 2 patients.

Conclusions: In our cohort of critically ill-patients with a diagnosis of IE, mortality directly related to the primary diagnosis was very high. This data might suggest that current guidelines for the treatment of IE, namely those concerning surgical recommendation, are not entirely adequate for patients with the most severe forms of the disease.

References

- Leroy O, Georges H, Devos P, Bitton S, De Sa N, Dedrie C, Beague S, Ducq P, Boulle-Geronimi C, Thellier D, Saulnier F, Preau S. Infective endocarditis requiring ICU admission: epidemiology and prognosis. *Ann Intensive Care*. 2015 Dec;5 (1):45.

- Muñoz, Patricia; Kestler, Martha; De Alarcon, Aristides MD; et al. Current Epidemiology and Outcome of Infective Endocarditis: A Multicenter, Prospective, Cohort Study. *Medicine* 94 (43):p e1816, October 2015.
- Scheggi, V., Merilli, I., Marcucci, R. et al. Predictors of mortality and adverse events in patients with infective endocarditis: a retrospective real world study in a surgical centre. *BMC Cardiovasc Disord* 21, 28
- Ahtela E, Oksi J, Porela P, et al Trends in occurrence and 30-day mortality of infective endocarditis in adults: population-based registry study in Finland *BMJ Open* 2019;9:e026811.
- Rajani, R, & Klein, J. L. (2020). CME: Cardiovascular Medicine Infective endocarditis: A contemporary update. In *Clinical Medicine* (Vol. 20, Issue 1).
- Baddour, L. M., Shafiqi, A., Lahr, B. D., Anavekar, N. S., Steckelberg, J. M., Wilson, W. R., Sohail, M. R., & DeSimone, D. C. (2021). A Contemporary Population-Based Profile of Infective Endocarditis Using the Expanded Rochester Epidemiology Project. *Mayo Clinic Proceedings*, 96 (6), 1438–1445.

Topic: Infections and prevention

001405

Drainage and irrigation therapy using IRRAFLOW[®] self-irrigating catheter for adult intraventricular hemorrhages

S. Teixeira¹, P. Costa¹, R. Pereira², H. Cabral², D. Matos², E. Germano¹, F. Sequeira¹, P. Martins¹

¹Intensive Care Department, Centro Hospitalar e Universitário de Coimbra, Coimbra, Portugal; ²Neurosurgery Department, Centro Hospitalar e Universitário de Coimbra, Coimbra, Portugal

Correspondence: S. Teixeira
Intensive Care Medicine Experimental 2023, **11 (Suppl 1)**:001405

Introduction: Patients suffering from intracerebral hemorrhage (ICH) with intraventricular hemorrhage (IVH), a devastating neurological condition associated with high rates of morbidity and mortality. In severe IVH with obstruction of the third or fourth ventricles, the placement of an external ventricular drain (EVD) can help lower raised intracranial pressure, the literature shows this reduces mortality, but poor outcomes remain a commonplace. Therefore, treating IVH may be a beneficial therapeutic target.

Objectives: We attempted to achieve an alternative for standard external EVD for IVH. A self-irrigation and drainage intraventricular catheter may be a good alternative for a standard EVD since it seems to avoid most of the difficulties present while using an EVD.

Methods: A retrospective observational cohort study of adult patients with IVH treated with IRRAFLOW[®] self-irrigation and drainage therapy, in our Intensive Care Unit (ICU) of a tertiary center in Portugal, between November 2020 and February 2023. Determination of intraventricular pressure is made in real time through the IRRAFLOW[®] double lumen catheter.

Results: We present 8 cases of IRRAFLOW[®] use in critical ill patients admitted with IVH in our ICU. In all of them, Ringer lactate was used for irrigation and high irrigation rates were used during the first days. We have controlled the positioning, hematoma or clot formation and hydrocephalus with serial neuroimaging control, through the patient during ICU stay. All of the patients were submitted to serial biochemistry and microbiologic cerebrospinal fluid (CSF) control to rule out infection and control the CSF characteristics. Multimodal neurologic monitoring was performed in every patient. From the 8 patients admitted with IRRAFLOW[®], 2 were female and 6 were male, with a median age of 55 (interquartile range, IQR 40–71) years old. The etiology of the ICH was arteriovenous malformations in 3 cases and spontaneous intracerebral hemorrhages in the 5 remaining patients. At the ICU admission, median initial Glasgow Coma Scale (GCS) was 8 (IQR 7–9). The median of days with IRRAFLOW[®] catheter was 11,1 (IQR

8–13) days. ICU length of stay was 19,8 (IQR 18.5–23) days. ICU mortality rate was 12,5% (only 1 patient) and mortality at 6 months was 25% (2 patients). At hospital discharge, 2 patients presented with GCS of 15, 2 with 10t, 1 with 9 and 2 with 6t. Follow-up at 6 months was done with 3 patients with Glasgow Outcome Scale (GOS) of 5. None of the catheters were complicated by obstruction or infection, and none of the presented patients needed ventriculoperitoneal shunt after IRRFLOW® removal.

Conclusions: Intraventricular hemorrhage remains a devastating clinical condition with a terrible outcome. A self-irrigation and drainage intraventricular catheter appears to be safe and may be a good alternative for a standard external ventricular drainage in patients with severe IVH and at big risk of hydrocephalus. More experience is necessary to take more conclusions and to put this novel approach in the therapeutic scenario of IVH.

References

1. Management of Intraventricular Hemorrhage. Hinson HE, Hanley Df, Ziai WC. *Curr Neurol Neurosci Rep.* 2010;10:73–82.
2. Advances in Therapeutic Approaches for Spontaneous Intracerebral Hemorrhage. Mais N. Al-Kawaz, Daniel F. Hanley, Wendy Ziai. *Neurotherapeutics* 2020 Oct; 17 (4):1757–1767

Topic: Neurointensive care

001406

Inflammatory and immune response in patients with severe coronavirus disease and its relationship with mortality

D. Pérez-Torres¹, I. Canas¹, C. Díaz-Rodríguez¹, C. Cuenca-Rubio¹, P. A. Merino-García¹, G. J. Posadas-Pita¹, C. Colmenero-Calleja¹, M. Domínguez-Gil González², P. M. Enríquez-Giraudó¹, J. M. Eiros-Bouza²
¹Servicio de Medicina Intensiva, Hospital Universitario Río Hortega, Valladolid, Spain; ²Servicio de Microbiología, Hospital Universitario Río Hortega, Valladolid, Spain

Correspondence: D. Pérez-Torres

Intensive Care Medicine Experimental 2023, **11** (Suppl 1):001406

Introduction: The COVID-19 pandemic has presented extraordinary challenges to the healthcare systems worldwide. The high transmissibility and severity of the disease have required the rapid development of effective management strategies to reduce morbidity and mortality. Inflammatory biomarkers have emerged as an important tool in guiding clinical decision-making in COVID-19. They provide valuable information on disease activity, severity, and response to therapy, enabling clinicians to tailor treatment to individual patients.

Objectives: To explore the relationship between inflammatory and immunological indicators routinely utilized in clinical practice and outcomes in patients with severe coronavirus disease (COVID-19).

Methods: We performed a prospective observational study in the Intensive Care Unit (ICU) of a university hospital in Spain. Inclusion criteria: polymerase chain reaction (PCR)-confirmed SARS-CoV-2 infection with symptoms of COVID-19, time from positive PCR to ICU admission less than 14 days, and mechanical ventilation more than 48 h. Exclusion criteria: positive SARS-CoV-2 PCR without COVID-19 or need for MV due to causes other than COVID-19. Inclusion period: 01/11/2021 to 28/02/2022. Analytical determinations were performed on days 5, 15, and 25 of ICU stay and were compared between survivors and non-survivors. The patients were followed-up for a maximum of 90 days. The results are expressed as median (interquartile range) or frequency (%). We applied the Mann–Whitney U test for comparisons.

Results: From 52 eligible patients with positive SARS-CoV-2 PCR admitted to the ICU during the study period, 35 met the inclusion criteria: age 60 ± 9 years; 77% male; APACHE-II 13 (11–18); 100% received mechanical ventilation, with a duration of 23 (12–41) days; 28.5% required veno-venous extracorporeal membrane oxygenation (ECMO), with a duration of 19 (12–46) days; 90-day mortality was 17%. The inflammatory and immunological profile is described in the Table.

	ICU day 5		p	ICU day 15		p	ICU day 25	
	Survivors	Non-survivors		Survivors	Non-survivors		Survivors	Non-survivors
Ferritin, ng/ml	655 (362–1047)	1391 (527–1695)	0.09	424 (308–839)	1070 (866–2963)	0.02	403 (275–636)	1398 (869–2036)
Triglycerides, mg/dl	197 (143–279)	198 (84–273)	0.65	199 (153–252)	204 (89–250)	0.68	190 (175–271)	555 (146–588)
Interleukin 6, pg/ml	15 (7–89)	21 (9–70)	0.57	22 (10–50)	92 (74–139)	0.02	6 (2–11)	77 (15–190)
Total immunoglobulin G (IgG)	830 (668–908)	544 (514–832)	0.41	708 (584–843)	832 (649–1010)	0.29	673 (554–851)	951 (640–1075)
Total immunoglobulin M (IgM)	94 (67–140)	79 (65–135)	0.76	88 (62–123)	79 (42–135)	0.77	84 (62–94)	114 (63–185)
Anti-S1 IgG, AU/ml	6664 (483–39,879)	2207 (451–8560)	0.43	10,243 (2605–39985)	8863 (5075–14561)	0.73	6474 (40,000)	17,017 (2783–19,061)
Anti-N IgG, AU/ml	3.4 (1.5–5.9)	4.7 (4.6–6.3)	0.14	6.3 (5.2–7.1)	5.7 (5.2–6.9)	0.74	6.6 (6.1–7.4)	7.7 (4.6–7.9)

Conclusions: In our study, patients with severe COVID-19 who died before 90 days had significantly higher levels of ferritin on ICU days 15 and 25, and significantly higher levels of interleukin 6 on ICU day 15. Triglycerides, humoral immune response markers, and antibody levels against SARS-CoV-2 did not correlate with survival status.

Topic: Infections and prevention

001407

Right ventricular free wall longitudinal strain during weaning from mechanical ventilation using high flow versus conventional oxygen treatment: a pilot trial

E. Xourgia¹, A. Koroneos¹, K. Stamatis¹, A. Kotanidou¹, I. Siempos¹, C. Routsis¹

¹First Department of Critical Care Medicine National and Kapodistrian University of Athens, Evangelismos Hospital, Athens, Greece

Correspondence: C. Routsis

Intensive Care Medicine Experimental 2023, **11** (Suppl 1):001407

Introduction: Information on right ventricular (RV) response during weaning from mechanical ventilation is limited. Recent advancements in cardiovascular imaging, namely the use of two-dimensional speckle-tracking echocardiography (2DSTE), have provided novel parameters such as RV free wall strain (RVFWS) that that outperform conventional echocardiography measurements in the estimation of RV systolic function.

Objectives: We investigated RV function during weaning from prolonged mechanical ventilation in tracheostomized patients, comparing a high flow oxygen treatment (HFOT) system, through tracheostomy, with conventional T-piece oxygenation. Both conventional echocardiography and RV-2DSTE were used.

Methods: Patients underwent a 30-min spontaneous breathing trial (SBT), randomly conducted with either standard oxygen via T-piece, or by HFOT delivered via tracheostomy, followed by a washout period of 15 min on mechanical ventilation and 30 min receiving oxygen with the other modality. Blood gases, hemodynamic and respiratory measurements, i.e., breathing frequency (f) and tidal volume (VT) measured with a handheld Wright's spirometer through the endotracheal tube. Echocardiography was performed before and at the end of each SBT phase. A repeated SBT was performed on the following day with the opposite order of the respiratory support modality.

Results: Nine patients (median age 64 [52.5–70.0], 66% males) in whom 14 SBT sessions were completed uneventfully, were included in the analysis. During SBTs, PO2/FiO2 and VT did not change whereas f/VT ratio increased compared to mechanical ventilation [57 (44–68), 62 (47–77) versus 41 (35–56) breaths/min/L on HFOT, T-piece and mechanical ventilation respectively, $p=0.004$]. RVFWs median values on mechanical ventilation, HFOT and T-piece were 22.3%, 25.0% and 24.6%, respectively. There was no statistically significant difference in conventional echocardiography parameters of RV function as well as in RVFWs among mechanical ventilation, HFOT and T-piece [F (2,26)=0.654, $p=0.568$]. Similarly, there was no significant difference among mechanical ventilation, HFOT and T-piece in basal [F (2,26)=1.048, $p=0.365$] and medial [F (2,26)=0.737, $p=0.488$] RV strain. Higher absolute RVFWs values (i.e., lower strain) along with the absence of conventional variables of RV dysfunction on mechanical ventilation were associated with weaning success within the next 24 h [$\chi^2(1)=5.531$, $p=0.019$].

Conclusions: RV function, as assessed by both conventional echocardiography and 2DSTE, was maintained during successful SBTs supported either by HFOT or conventional oxygenation via T-piece. Moreover, a lower baseline right ventricular strain was independently associated with weaning success.

References

1. Badano LP, et al. Eur Heart J Cardiovasc Imaging, 2020;21:825

Topic: Acute respiratory failure and mechanical ventilation

001408

The development and use of patient-centered observations to demonstrate the cumulative impact of critical care support

K. Fearon¹, N. Gurung¹, A. Broderick¹, K. O’reilly¹, S. Akhtar², A. Khatri¹, F. Bowtell³, I. Salako¹, T. Lalmahomed¹, P. Schalke¹, M. Derupe¹, J. Fideles¹, R. Patel¹, R. Mehta¹, T. Best¹, D. Hadfield⁴, P. A. Hopkins⁵

¹King’s Critical Care, King’s College Hospital, London, United Kingdom; ²King’s Critical care, Kings College Hospital London-London, London, United Kingdom; ³Critical care medicine, King’s College Hospital, London, United Kingdom; ⁴Critical care, King’s College London, London, United Kingdom; ⁵Critical care, King’s College Hospital, London, United Kingdom

Correspondence: P.A. Hopkins

Intensive Care Medicine Experimental 2023, 11 (Suppl 1):001408

Introduction: The quality of critical care support can have profound implications on long-term health outcomes and costs (1, 2). Critical care decision making within daily workflow is generally centred around current acute pathophysiology, clinical problems and immediate priorities. At ward rounds, static pathophysiology may be emphasized over the cumulative impact of critical care on patients or formal assessment of reversibility. Here, we describe the development of a new paradigm in critical care observations which use patient-centered parameters to highlight the cumulative impact of critical care. We further explore the views of patients and interprofessional staff around the potential benefits of such observations and support for a future cluster-randomised step-wedge trial.

Methods: Research/QI approval was gained to develop cumulative impact observations using existing healthcare record data entry. The general data protection act was followed.

Mixed methods observational techniques were used to generate a list of patient-centred cumulative impact observations using round Tables, interviews and surveys. Delphi methodology was used to refine and rank a list of cumulative impact observations, The calculations and SQL reporting functionality of a Best-Of Breed clinical data management system (Intellivue Critical Care and Anaesthesia, Philips Healthcare) were used to automatically generate the requested list of cumulative impact observations on the system flow sheet.

Feedback on the potential benefits and utilisation from 234 staff and 34 patients were obtained after a 6 month period of deploying the observations.

Results: Delphi-derived cumulative impact observations were:

Cumulative radiation exposure (years of back ground radiation equivalent); cumulative blood loss on litres (from tests/procedures); cumulative hypnotics/ analgesics-opiates-paracetamol/ pressors/antibiotics; antibiotics beyond prescribed duration; days of ventilation; days of renal replacement; days cardiovascular support; days of delirium; days of moderate or severe sleep disturbance; days of non-mobilisation from bed; days of uncontrolled pain (CPOT scoring); days of no speech; days of no oral fluids/food.; SOFA Score-daily and cumulative days of non-improvement.

The five top benefits from staff were vasopressor load, days of antibiotics beyond prescribed course; days of delirium; days of non-improved SOFA score and days of blood glucose outside target range. The five top benefits from patients who were interviewed were days of uncontrolled pain; days of delirium; total radiation exposure; days that not able to take oral fluids; and days of poor quality sleep.

Figures 1 and 2 illustrate typical cumulative impact observations from two different anonymised patients in critical care.

All healthcare professionals and patients interviewed indicated that cumulative impact observations have the potential to improve the understanding of critical care consequences on patients. 83% of healthcare professionals and 92% of patients believed that this understanding could be linked to improved quality of care and potential to improve outcomes. There was universal support for a step-wedge randomised controlled trial.

Conclusions: We were able to develop a list of twenty patient-centred observations. Further observations may be important, using the same principles and digital design. The cumulative impact observations were widely supported by both patients and staff and may form the basis of an important step-wedge randomised controlled trial in the future to provide clinically important benefits. We believe that cumulative observations provide a new paradigm for critical care observations that could be translated across healthcare settings, and provide improved insight into the consequences of critical care support for patients, and potentially improve the quality of supportive care and reduce healthcare costs.

Blood loss from tests/lines [L]	4.24	4.24	4.24	4.25	4.25	4.25	4.25	4.25
Cumulative radiation dose [yr]	9.1	9.1	9.1	9.1	9.1	9.1	9.1	9.1
Minijets Equivalent [mg]	0	0	0	0	0	0	0	0
Cumulative antibiotic days	21.78	21.78	21.78	21.78	21.78	21.78	21.78	21.78
Cumulative paracetamol dose [g]	42	42	42	42	42	42	42	43
Cumulative days of delirium	40.6	40.6	40.6	40.6	40.6	40.6	41.1	41.1
Cumulative days of delirium	10	10	10	10	10	10	10	10

Figure 1 (abstract 001408) Cumulative impact observations from patient 1

Minijets Equivalent [mg]	2.27	2.27	2.27	2.27	2.27	2.27	2.27	2.27
Cumulative antibiotic days	1878.68	1880.96	1883.23	1885.5	1887.77	1890.04	1892.32	1894.59
Cumulative paracetamol dose [g]	74	74	74	74	74	74	74	75
Cumulative days of delirium	162.5	162.5	162.5	162.5	162.5	162.5	162.5	163
Number of days where Glucose >10	31	31	31	31	31	31	31	31
Adv Resp Days	74	74	74	74	74	74	74	74
Renal Support Days	42	42	42	42	42	42	42	42
Days Muscle Relaxant	0	0	0	0	0	0	0	0
Cumulative Propofol Dose [mg]	16647.7	16647.7	16647.7	16647.7	16647.7	16647.7	16647.7	16647.7
Cumulative Midazolam Dose [mg]	353	353	353	353	353	353	353	353
Cumulative Fentanyl Dose [mg]	152.9	153.3	153.7	154.1	154.5	154.9	155.3	155.7

Figure 1 (abstract 001400) Cumulative impact observations from patient 2

References

1. Lone NI, Gillies MA, Haddow C, et al. Five-Year Mortality and Hospital Costs. Associated with Surviving Intensive Care. American journal of respiratory and critical care medicine 2016;194 (2):198–208
2. Lone NI, Seretny M, Wild SH, et al. Surviving intensive care: a systematic review of healthcare resource use after hospital discharge. Critical care medicine. 2013;41 (8):1832–43.
3. Philips healthcare have provided support costs for a nurse to attend ESICM but were otherwise not involved in the writing of the abstract.

Topic: Critical care organisation, quality management, information systems, outcomes

001409

Complications and clinical outcomes in patients with severe coronavirus disease requiring admission to the intensive care unit: does vaccination status make a difference?

I. Canas¹, D. Pérez-Torres¹, C. Díaz-Rodríguez¹, C. Cuenca-Rubio¹, P. A. Merino-García¹, C. Colmenero-Calleja¹, G. J. Posadas-Pita¹, P. M. Enríquez-Giraudó¹, J. M. Eiros-Bouza², M. Domínguez-Gil González²
¹Servicio de Medicina Intensiva, Hospital Universitario Río Hortega, Valladolid, Spain; ²Servicio de Microbiología, Hospital Universitario Río Hortega, Valladolid, Spain

Correspondence: D. Pérez-Torres

Intensive Care Medicine Experimental 2023, **11** (Suppl 1):001409

Introduction: The COVID-19 pandemic has had a significant impact on global health, with high morbidity and mortality rates, particularly in patients requiring admission to the Intensive Care Unit (ICU). The development of effective vaccines has provided hope in controlling the spread of the virus and reducing the burden on healthcare systems. Vaccination against SARS-CoV-2 has been shown to be highly effective in preventing severe illness and hospitalization. However, the impact of vaccination status on clinical outcomes in patients with severe coronavirus disease 2019 (COVID-19) requiring ICU admission remains uncertain.

Objectives: To evaluate the influence of SARS-CoV-2 vaccination status on the development of complications and clinical outcomes in patients with severe COVID-19.

Methods: We conducted a prospective observational study in the ICU of a university hospital in Spain. We included patients with confirmed COVID-19 diagnosis (molecular identification of SARS-CoV-2 with presence of symptoms), requiring mechanical ventilation for more than 2 days. We excluded patients with a SARS-CoV-2 test without COVID-19, or need for mechanical ventilation due to causes other than COVID-19. The inclusion period corresponded with the sixth wave of the disease in Spain (11/2021 to 02/2022), when the Omicron variant predominated. We measured IgG-class antibodies against S1 and N proteins of the virus on ICU days 5, 15, and 25. The results are expressed as mean \pm standard deviation, median (interquartile range), or frequency (%). We applied χ^2 , Student's T-test, or Mann-Whitney U test, as appropriate.

Results: We enrolled 35 patients during the study period, with a vaccination rate against SARS-CoV-2 of 45.7% (44% ComirnatyTM, 19% VaxzerviaTM, 19% combination of several, 12% SpikevaxTM, 6% others). Time from vaccination to microbiological diagnosis 150 (70–172) days. The temporal evolution of antibody titers is shown in the Table.

	Vaccinated patients	Non vaccinated patients	p-value
Anti-S1 IgG, AU/ml			
ICU day 5	26,197.2 \pm 5141.1	5831.6 \pm 2715.8	< 0.01
ICU day 15	25,292.5 \pm 5279.3	10,347.7 \pm 3104.1	0.02
ICU day 25	26,002.2 \pm 5535.3	4864 \pm 1116.9	< 0.01
Anti-N IgG, AU/ml			
ICU day 5	3.4 \pm 0.6	4.2 \pm 0.6	0.31
ICU day 15	5.33 \pm 0.7	5.9 \pm 0.5	0.43
ICU day 25	6.0 \pm 0.9	6.6 \pm 0.3	0.55

Clinical characteristics of vaccinated vs. non vaccinated patients: age 59.3 \pm 1.9 vs. 61.3 \pm 2.4 years old, p=0.78; male sex 75 vs. 79%, p=0.78; APACHE-II 13.5 (11.5–19) vs. 13 (11–18), p=0.73; length of mechanical ventilation 23.5 (6.5–50) vs. 23 (15–30), p=0.73; ICU length of stay 29.5 (8–53.5) vs. 26 (17–50) days, p=0.87; time to negative SARS-CoV-2 test 27.5 (20.5–52.5) vs. 30 (19–39) days, p=0.57; hospital mortality 12.5 vs. 31.6%, p=0.18.

Complications in vaccinated vs. non vaccinated patients: hospital-acquired infection 56.3 vs. 94.7%, p<0.01; delirium 62.5 vs. 42.1%, p=0.23; ICU-acquired weakness 56.3 vs. 47.4%, p=0.60; thrombosis 25 vs. 42.1%, p=0.29; pulmonary fibrosis 12.5 vs. 21.1%, p=0.50.

Conclusions: The vaccination rate in severe COVID-19 patients admitted to the ICU was low. Vaccination was associated with a significantly higher titer of anti-S1 IgG and a lower incidence of nosocomial infections. Mortality was higher in unvaccinated patients, although the strength of this association was not statistically significant.

Topic: Infections and prevention

001410

Impact of hemoglobin levels on 28-day mortality in out-of-hospital cardiac arrest patients treated with extracorporeal cardiopulmonary resuscitation

K. Maekawa¹

¹Kita14joh nishi5 chome, Kita-ku, Sapporo City, Hokkaido, Department of Emergency Medicine, Hokkaido University Hospital, Sapporo, Japan

Correspondence: K. Maekawa

Intensive Care Medicine Experimental 2023, **11** (Suppl 1):001410

Introduction: Extracorporeal cardiopulmonary resuscitation (ECPR) is an advanced treatment option for out-of-hospital cardiac arrest (OHCA) patients. Hemoglobin (Hb) plays a crucial role in oxygen transport and tissue perfusion, and previous studies have reported an association between Hb levels and survival outcomes in OHCA patients. However, there is limited information on this relationship in OHCA patients undergoing ECPR.

Objectives: This study examines the association between lower Hb levels during hospitalization and survival in OHCA patients who underwent ECPR.

Methods: We conducted a post-hoc analysis of the multicenter retrospective observational cohort SAVE-J II study, including adult OHCA patients aged 18 years and over admitted alive for at least 3 days after being introduced to ECPR between January 2013 and December 2018. The primary outcome was 28-day all-cause mortality. Propensity score-weighted analysis was used to account for potential confounders.

Results: The final analysis comprised 630 patients, with a 28-day mortality rate of 43.3%. Non-survivors had significantly lower Hb levels on ICU day 0 and 1, and lower mean and lowest Hb levels during the first 3 days than survivors. In multivariate logistic regression, the lowest Hb level and the lowest Hb range \leq 7 g/dL were independent predictors of 28-day mortality, with adjusted odds ratios of 0.85 per 1.0 g/dL increment (95% CI: 0.76–0.96) and 2.50 (95% CI: 1.27–4.91), respectively. After propensity score weighting, the 28-day survival time was significantly worse in patients with the lowest Hb range \leq 7 g/dL.

Conclusions: Lower Hb levels during the first 3 days of hospitalization were independently associated with increased 28-day mortality in OHCA patients undergoing ECPR. These findings suggest that monitoring and optimizing Hb levels in the early phase of hospitalization may improve survival outcomes for this patient population.

References

- Holmberg MJ, Geri G, Wiberg S, et al. Extracorporeal cardiopulmonary resuscitation for cardiac arrest: A systematic review. *Resuscitation*. 2018; 131:91–100.

- Inoue A, Hifumi T, Sakamoto T, et al. Extracorporeal cardiopulmonary resuscitation in adult patients with out-of-hospital cardiac arrest: a retrospective large cohort multicenter study in Japan. Crit Care. 2022; 26:129.

Topic: Cardiac arrest

001411

How to improve sleep distortion in intensive care unit?

C. Ping-Teng¹, K. Shu-Hung¹, L. Ya-Mei², C. Hsing-Chi², H. Sheng-Huei³, H. Ming-Shiuan³, J. Wang-Chuan⁴, W.C. Huang⁵

¹Department of Critical Care Medicine, Kaohsiung Veterans General Hospital, Kaohsiung, Taiwan; ²Department of Nursing, Kaohsiung Veterans General Hospital, Kaohsiung, Taiwan; ³Department of Nursing, Kaohsiung Veterans General Hospital, Kaohsiung City, Taiwan; ⁴Department of Quality Management Center, Kaohsiung Veterans General Hospital, Kaohsiung, Taiwan; ⁵Critical Care Medicine and Cardiovascular Center, Kaohsiung Veterans General Hospital, Taipei, Taiwan

Correspondence: W.C. Huang

Intensive Care Medicine Experimental 2023, 11 (Suppl 1):001411

Introduction: Intensive care unit (ICU) patients were shown to have poor quality of sleep over the last three decades. However, to improve the sleep distortion in critical patients remains challenging. The aim of this study is to investigate the impact of continuous quality improvement on sleep distortion in critical patients in critical patients.

Methods: All consecutive patients from 2019–2021 in 6 adult ICUs were enrolled. The key interventions include novel sacral suspended decompression recumbent care, simple air pressure turning device, remote warning care system and using big data to monitor critical care warning indicators. The patients were divided into three periods: pre-intervention period from Jan to Dec 2019, intervention period from Jan to Dec 2020, and post-intervention period from Jan to Dec 2021.

Results: The sleep assessment ratio improved from 49.0% in pre-intervention period, to 67.5% in intervention period and to 95.1% in post-interventional period ($p < 0.0001$). The good quality sleep ratio improved from 70.4% in pre-intervention period, to 74.2% in intervention period and to 87.8% in post-interventional period ($p < 0.0001$). Average ICU stay decrease from 7.9 days to 6.9 days after intervention ($p < 0.05$). The incidence of ventilator-associated pneumonia decreased from 0.7‰ to 0.4‰ ($p < 0.05$). The mortality decreased from 7.6‰ to 5.2‰ ($p < 0.05$).

Conclusions: The study showed that implementation of continuous quality improvement using novel critical care system could increase sleep assessment ratio and good quality sleep ratio, and reduce average ICU stay. Furthermore, the incidence of ventilator-associated pneumonia and mortality also improved.

Topic: Sedation, analgesia and delirium

001412

The association between admission clinical gestalt categories and multi-organ failure; an ICU cohort study

E.G.M. Cox¹, N. Campillo Llamazares¹, B.C. Van Busse², I. Van der Horst², J. Koeze¹

¹Department of Critical Care, University Medical Center Groningen, Groningen, Netherlands; ²Department of Intensive Care, Maastricht UMC+, Maastricht, Netherlands

Correspondence: E.G.M. Cox

Intensive Care Medicine Experimental 2023, 11 (Suppl 1):0001412

Introduction: In the intensive care unit (ICU), the clinical gestalt is an important part of the daily clinical examination physicians perform on critically ill patients. The clinical gestalt, at least unconsciously, affects physicians' patient assessment, clinical decisions, and treatment [1,2]. However, the association between objective clinical measurement of clinical gestalt and multi-organ failure in the ICU remains unknown, and if such an association is independent of laboratory and clinical ICU

variables, it could provide evidence for the application of the clinical gestalt in clinical practice [3].

Objectives: To study whether the clinical gestalt is associated with multi-organ failure defined by the maximum Sequential Organ Failure Assessment (SOFA) score during the first 7 days of patient's stay in the ICU.

Methods: This study is part of the Simple Intensive Care Studies-II (SICS-II, NCT03577405), a single-center prospective cohort study [4]. All adult patients acutely admitted to the ICU between March 26, 2019, and July 10, 2019, were included. The clinical gestalt was assessed within three hours of admission using pictograms depicting the patient's facial expression (Figure 1), along with the SOFA score. Univariate, multivariate, and longitudinal analyses were performed.

Results: The study included 228 consecutive adult patients (median age, 64 years) acutely admitted to the ICU, of which 47% were mechanically ventilated. Fourteen patients (18%) with a pale face died in-hospital. Patients with their eyes open, has a lower SOFA score than patients with their eyes slinked (1.8 point; 95%CI 0.3–3.4), slumbered (1.5 point; 95%CI 0.3–2.6), closed (1.9 point; 95%CI 0.8–3.0), or ventilated (2.2 points; 95%CI 1.3–3.0) (Table 1). The maximum SOFA score was present at 1.7 days ($SD \pm 1.0$), with a mean of 6.0 points ($SD \pm 3.3$). SOFA score was significantly different between gestalt categories.

Table 1 (abstract 001412) Distribution of the different pictograms

	Open (1,6,11)			Slinked (2,7,12)			Slumbered (3,8,13)			Closed (4,9,14)			Ventilated (5,10,15)			Total		
	T	+	%	T	+	%	T	+	%	T	+	%	T	+	%	T	+	%
Vasoco- stricted (1–5)	7	0	-	7	2	29	11	2	18	11	2	18	44	8	18	80	14	18
Normal (6–10)	7	0	-	14	1	7.1	16	0	-	20	2	10	48	9	19	105	12	11
Vasodilated (11–15)	10	1	10	4	0	-	4	1	25	10	1	10	15	0	-	43	3	7.0
Total	24	1	4.2	25	3	12	31	3	9.7	41	5	12	107	17	16	228	29	13

T: number of observations, + died in hospital

Conclusions: The clinical gestalt, particularly the state of the patient's eyes, may serve as a non-invasive marker for organ failure risk in critically ill patients. These findings highlight the potential importance of the clinical gestalt in the ICU and suggest the need for further research to validate these results and explore their potential clinical implications.

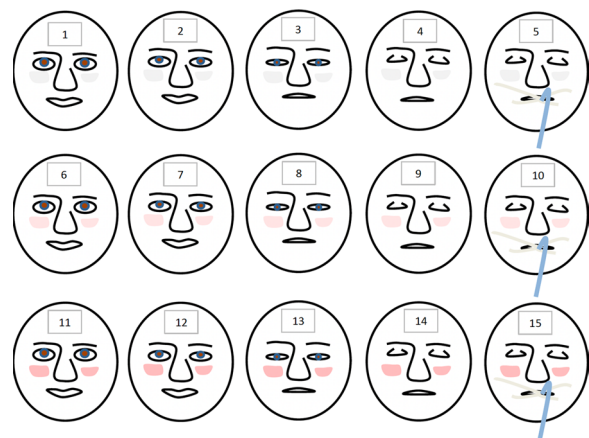

Figure 1 (abstract 001412) Design of clinical gestalt pictograms used in this study

References

1. Qiang J, Wu D, Du H, Zhu H, Chen S, Pan H. Review on Facial-Recognition-Based Applications in Disease Diagnosis. *Bioengineering*. 2022;9:1–16
2. Wiersema R, Castela Forte JN, Kaufmann T, de Haas RJ, Koster G, Hummel YM, et al. Observational Study Protocol for Repeated Clinical Examination and Critical Care Ultrasonography Within the Simple Intensive Care Studies. *J Vis Exp* [Internet]. 2019 [cited 2019 May 30];e58802. Available from: <https://www.jove.com/video/58802/observational-study-protocol-for-repeated-clinical-examination>
3. This research received no specific grant from any funding agency in any sector. Currently more statistical analyses on this data are being performed to elucidate and refine the outcomes of the study. In case of admission to the ESICM congress, revised results could be presented.
4. Forte C, Voinea A, Chichirau M, Yeshmagambetova G, Albrecht LM, Erfurt C, et al. Deep Learning for Identification of Acute Illness and Facial Cues of Illness. *Front Med*. 2021;8
5. Axelsson J, Sundelin T, Olsson MJ, Sorjonen K, Axelsson C, Lasselin J, et al. Identification of acutely sick people and facial cues of sickness. *Proc R Soc B Biol Sci*. 2018;285:3–9

Topic: Critical care organisation, quality management, information systems, outcomes

001413

Caring and learning during the COVID-19 pandemic: a sociological analysis of critical care workers experiences

N. Pattison¹, A. M. Docherty², S. Humphreys³, C. McCulloch⁴, S. Sturdy⁵, C. Montgomery⁵

¹School of Health and Social Work, University of Hertfordshire/East and North Herts NHS Trust, Stevenage, United Kingdom; ²Intensive care, University of Edinburgh Medical School, Edinburgh, United Kingdom; ³School of Health and Social Work, University of Hertfordshire, Hertfordshire, United Kingdom; ⁴Research, Lothian NHS Board, Edinburgh, United Kingdom; ⁵Usher Institute (Sociology), The University of Edinburgh, Edinburgh, United Kingdom

Correspondence: N. Pattison

Intensive Care Medicine Experimental 2023, **11** (Suppl 1):001413

Introduction: Staff experience is critical to the quality of healthcare, and an important outcome in and of itself. COVID-19 placed unprecedented demands on critical care units in the UK and globally, with profound changes to the way NHS staff had to work. By understanding staff experiences we can learn lessons to inform how staff are supported in critical care and plan for future large-scale challenges such as a pandemic.

Objectives: To understand, through a sociological lens: the experiences of frontline NHS staff in critical care in dealing with changed working conditions during the COVID-19 outbreak, to learn from frontline staff's accounts to improve pandemic response in critical care and finally to understand how can frontline NHS staff working in critical care be supported now and into the future.

Methods: We undertook semi-structured telephone interviews with 40 staff across 4 hospitals in Scotland and England. We employed purposive sampling to include critical care trained and redeployed staff, including nurses, medical staff, allied health professionals and ancillary staff, e.g. ward clerks. We sought a breadth of experience in terms of age, gender, ethnicity, and experience working in critical care. We adopted Rapid Analysis techniques, informed by sociological theory.

Results: We identified six key themes: Learning & Preparation, Adjusting to new working, Information, Practicalities of Care, Communication/End of Life Care and Impact on Self and Wellbeing. These were viewed through the theory of Communities of Fate and Place and Body in Work, both used in pandemic and disaster sociology, where purposeful collective action is undertaken by a group of people facing a common or shared crisis situation. These communities of fate, applied to COVID-19 and ICU, indicated the structural importance of social and organisational working conditions, including resourcing and the way surge plans are developed, and how organisations and individuals respond. We also found that individualised psychology-based interventions were likely to be ineffective unless social pre-conditions

for wellbeing were established. Moreover, the ICU does not exist independently of the constant embodied work of care and place-making which iteratively constitute critical care as a total system of relations.

Conclusions: COVID-19 immeasurably altered working practices in critical care and profoundly affected staff physically, mentally and emotionally. Analysis through a sociological lens identified how while people pull together in a community of fate, the need for adequate resourcing in terms of trained staff, appropriate equipment, and psychological support services should be made available to the health service to protect staff and mitigate the impact of pandemic-working. In addition, The ICU has become an increasingly data-driven place, meaning it is all the more important to appreciate how healthcare practitioners incorporate new practices—including data practices—into their existing body work.

References

1. Hamilton AB. Qualitative methods in rapid turn-around health services research. PowerPoint Present 2013 VA HSRD Cyberseminar Spotlight Womens Health. Published online 2013. Accessed November 16, 2020. www.hsrd.research.va.gov/for_researchers/cyber_seminars/archives/video_archive.cfm?SessionID=780.
2. This research was funded by Medical Research Scotland through a COVID-19 Research Grant (CVG-1739–2020) and supported in part by the Wellcome Trust (209,519/Z/17/Z).

Topic: Critical care organisation, quality management, information systems, outcomes

001414

Impact of restrictive versus liberal oxygen therapy on mortality of hospitalized patients with acute COPD exacerbations receiving mechanical ventilation: a retrospective cohort study

I. Maia¹, L. Tramuja², A. B. Cavalcanti¹

¹Hcor research institute-hospital do coração, Faculdade de Medicina da Universidade de São Paulo, São Paulo, Brazil; ²Research Institute, HCor, São Paulo, Brazil

Correspondence: I. Maia

Intensive Care Medicine Experimental 2023, **11** (Suppl 1):001414

Introduction: Guidelines suggest targeting oxygen saturation between 88 to 92%, for COPD patients who are critically ill and need oxygen therapy (1). However, whether this more restrictive target is superior to a more liberal target is uncertain (2–4).

Objectives: To investigate the effect of restrictive vs liberal oxygen therapy in hospital mortality of COPD patients with acute exacerbation who require invasive mechanical ventilation.

Methods: A retrospective cohort was conducted using TriNetX, a global health research network including data from 76 Health Care Organizations (HCO). The network was searched for people aged >18 years with chronic obstructive pulmonary disease with acute exacerbation hospitalized and intubated receiving mechanical ventilation recorded in electronic medical records. The analysis included outcomes that occurred in the time window that started 1 day after the first occurrence of the index event and ended 5 years after the first occurrence of the index event. The index event was defined as use of mechanical ventilation with SpO₂ higher than 93% that occurred within 2 months or any instance after diagnosis of hospitalized patients with COPD acute exacerbations in Cohort 1. It defines the point in time when each patient in the cohort enters the analysis. These patients were compared to controls or Cohort 2 with the same above index event definition, however with SpO₂ higher than 88 and lower or equal 92%. Characteristics of the cohorts are balanced using propensity score matching with analysis of measures of association and survival. Variables used for matching were: age, sex, pneumonia, influenza, pleural effusion, pneumothorax, diseases of pulmonary interstitium, pneumonitis, ARDS, chronic lower respiratory disease, hypertensive diseases, heart failure, cardiomyopathy, atherosclerotic diseases, ischemic heart disease, cardiac arrhythmias, aortic aneurysms, disease of pulmonary circulation, cerebral infarction, diabetes mellitus, BMI, neoplasms and carbon dioxide.

Results: After propensity-score matching, 23,013 patients (mean age 66.4 ± 11.1 ; 50.4% male) with COPD acute exacerbations treated with invasive mechanical ventilation with SpO₂ with higher than or equal to 93% were compared to 23,013 patients (mean age 66.5 ± 11 ; 50.5% male) with COPD acute exacerbations treated with invasive mechanical ventilation with SpO₂ within 88 to 92% as shown in Table 1. 12,329 patients (53.6%) in Cohort 1 and 12,329 patients (53.8%) in Cohort 2 experienced the outcome of mortality within 5 years (risk difference of -0.002 , 95% confidence interval (CI) $-0.011, 0.007$; $p=0.640$ and relative risk of 0.996, 95% CI 0.979, 1.013). The median survival time was 559 days with 29.05% survival probability at the end of time window in Cohort 1 and 527 days with 28.72% in Cohort 2 with $p=0.051$ (log rank test) and hazard ratio of 0.975, CI 0.951, 1.000; $p=0.206$ as shown Figure 1.

Conclusions: Liberal oxygen therapy in patients hospitalized receiving mechanical ventilation with acute exacerbation of COPD was not associated with higher mortality when compared to conservative oxygen therapy.

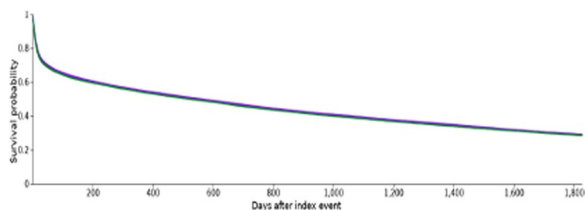

Figure 1 (abstract 001414) Kaplan Meier Survival Curve comparing Cohort 1 and 2

References

- O'Driscoll BR and BTS Emergency Oxygen Guideline Development Group. The BTS Guideline for oxygen use in adults in healthcare and emergency settings. *Thorax* 2017; 272 (Suppl 1): i1-i89
- Young PJ. Effect of oxygen therapy on mortality in the ICU. *N Engl J Med* 2021; 384: 1361–3
- Barrot L, Asfar P, Mauny F, et al. Liberal or conservative oxygen therapy for acute respiratory distress syndrome. *N Engl J Med* 2020; 382: 999–1008
- ICU-ROX Investigators and the Australian and New Zealand Intensive Care Society Clinical Trials Group. Conservative oxygen therapy during mechanical ventilation in the ICU. *N Engl J Med* 2020; 382: 989–98
- Schjorring OL, Klitgaard TL, Perner A, et al. Lower or higher oxygenation targets for acute hypoxic respiratory failure. *N Engl J Med* 2021; 384: 1301–11.
- Young, E, Soares, W, TrineTx

Topic: Acute respiratory failure and mechanical ventilation

001417

Innovative virtual reality early rehabilitation in critical patients

H. Tun-Chieh¹, W. Mei-Tzu¹, K. Shu-Hung¹, W.C. Huang²
¹Department of Critical Care Medicine, Kaohsiung Veterans General Hospital, Kaohsiung, Taiwan; ²Critical care medicine and cardiovascular center, Kaohsiung Veterans General Hospital, Taipei, Taiwan

Correspondence: W.C. Huang

Intensive Care Medicine Experimental 2023, **11 (Suppl 1)**:001417

Introduction: The early mobilization of patients in the intensive care unit (ICU) was shown to be important in patients' recovery. The aim of this study in to investigate the efficiency of virtual reality (VR) early rehabilitation in cardiac intensive care units (CICU).

Methods: The consecutive patients in adult CICU were enrolled. The patients were divided into two groups virtual reality (VR) rehabilitation group and control group. The patients in VR rehabilitation group received respiratory, functional training with virtual reality (VR). Maximal inspiratory pressure (MIP), maximal expiratory pressure (MEP), SF-36, CICU stay and intubation days were collected.

Results: After VR training, the maximal inspiratory pressure (MIP) showed significant improvement ($p=0.0088$) and maximal expiratory pressure (MEP) also improved significantly ($p=0.0203$). Further, VR rehabilitation group also had better Barthel index ($p<0.0001$), intensive mobility scale ($p<0.0001$), shorter ICU stay ($p=0.0063$), and intubation days ($p=0.006$).

Conclusions: This study demonstrate VR rehabilitation in CICU improved exercise capacity, Barthel index, intensive mobility scale, ICU stay and intubation days.

Topic: Critical care organisation, quality management, information systems, outcomes

001418

Measurement of functional residual capacity using an oxygen washin/washout technique through a mainstream oxygen sensor prototype: a first in human study

M. Docci¹, O. Putignano², G. Croci³, A. Muraro², E. Perelli Cippo², M. Tardocchi², F. Caruggi³, A. Varesano⁴, G. Gorini³, G. Foti¹, G. Bellani⁵, E. Rezoagli¹

¹School of Medicine and Surgery, University of Milano-Bicocca, Monza, Italy; ²Institute for Plasma Science and Technology, National Research Council, Milano, Italy; ³Department of Physics, University of Milan-Bicocca, Milan, Italy; ⁴Institute of Intelligent Industrial Technologies and Systems for Advanced Manufacturing, STIIMA-CNR, Biella, Italy; ⁵School of Medicine and Surgery, University of Trento, Trento, Italy

Correspondence: M. Docci

Intensive Care Medicine Experimental 2023, **11 (Suppl 1)**:001418

Introduction: The measurement of functional residual capacity (FRC) may help optimizing lung protective ventilation in patients with acute respiratory distress syndrome, but it is not routinely performed in clinical practice yet (1). Oxygen (O₂) washin/washout is a simple technique available at bedside to estimate FRC (2). However, it relies on sidestream gas analyzers, which lack of appropriate synchronous measurements of flow and gas concentration requiring complex calculations to correct for time, gas viscosity and pressure (3–5). Recently, a mainstream oxygen sensor prototype coupled in series with a fluximeter and a very fast time response and a good precision has been developed (named Italian Fast O₂ sensor—IFOX[®]).

Objectives: To explore the performance of IFOX[®] in measuring FRC using an O₂ washin/washout technique as compared to predicted FRC in healthy volunteers.

Methods: Healthy volunteers breathed in an open circuit with IFOX[®] during a 20-min experiment. The study protocol was composed of 3 phases: (1) basal phase, breathing ambient air (FiO₂ 21%) for 4 min; (2) a washin phase, breathing a gas mixture of compressed air and oxygen with an FiO₂ of 30% for 8 min; (3) a washout phase, breathing ambient air with an FiO₂ of 21% for 8 min. A brief end-expiratory pause (3–5 s) between each step allowed to connect/disconnect the circuit to a reservoir filled with the 30% O₂ 70% N₂ mixture and reach a steady state. Oxygen consumption (VO₂) at baseline was measured during step1 and then used for the quantification of FRC according to Weismann et al. (5). VO₂ and FRC measured by IFOX[®] were compared to their predicted values, in all volunteers and stratified by gender. Differences were assessed by unpaired Student's T-test or Mann-Whitney U test, as appropriate. Correlation between FRC measured with IFOX[®] and predicted values was expressed with the Pearson correlation coefficient.

Results: We enrolled 14 healthy volunteers, 8 female, with an overall height of 166 [156;183] cm (median and IQR). As shown in ** Figure 1A, the measurement of VO₂ at rest did not differ between IFOX[®] and predicted value (i.e. 3.5 mL of O₂ per kg of bodyweight) (6) either in all volunteers ($P=0.374$) or by gender stratification ($P=0.602$ for females; $P=0.127$ for males). Similarly (Figure 1B), the estimation of FRC by IFOX[®] did not significantly differ from the predicted value (i.e. 35 mL per kg of predicted bodyweight) (7) either in all volunteers ($P=0.418$) or stratified by gender ($P=0.950$ for females; $P=0.189$ for males). FRC measured with

IFox[®] well correlated with the predicted value in all volunteers ($r = 0.78$; $P < 0.001$).

Conclusions: In this first-in-human study, FRC measured with IFOx[®] sensor prototype showed no statistically significant difference as compared with the predicted values in spontaneously breathing healthy volunteers. Further studies may test IFOx[®] versus other sidestream gas analyzers based washin/washout techniques available in mechanically ventilated patients with respiratory failure.

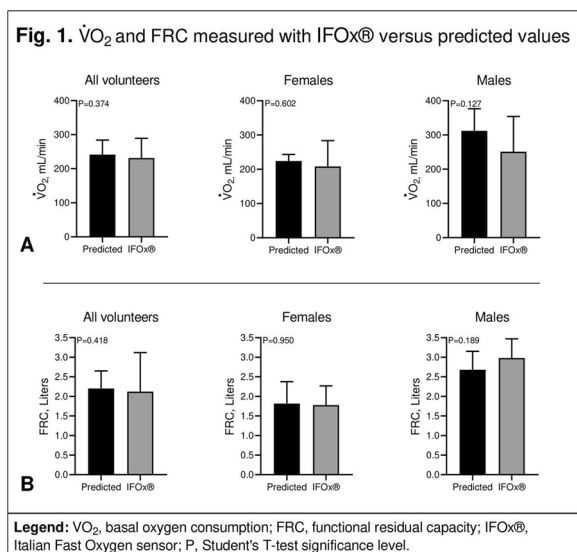

References

- Ibañez J, Raurich J. Normal values of functional residual capacity in the sitting and supine positions. *Intensive Care Med.* 1982;8 (4):173–7.
- Jetté M, Sidney K, Blümchen G. Metabolic equivalents (METs) in exercise testing, exercise prescription, and evaluation of functional capacity. *Clin Cardiol.* 1990;13 (8):555–565.
- Weismann D, Reißmann H, Maisch S, Füllekrug B, Schulte J. Monitoring of functional residual capacity by an oxygen washin/washout; technical description and evaluation. *J Clin Monit Comput.* 2006;20 (4):251–60.
- Olegård C, Söndergaard S, Houltz E, Lundin S, Stenqvist O. Estimation of functional residual capacity at the bedside using standard monitoring equipment: A modified nitrogen washout/washin technique requiring a small change of the inspired oxygen fraction. *Anesth Analg.* 2005;101 (1):206–12.
- Patroniti N, Bellani G, Manfio A, Maggioni E, Giuffrida A, Foti G, et al. Lung volume in mechanically ventilated patients: Measurement by simplified helium dilution compared to quantitative CT scan. *Intensive Care Med.* 2004;30 (2):282–9.
- Chen L, Brochard L. Lung volume assessment in acute respiratory distress syndrome. *Curr Opin Crit Care.* 2015;21 (3):259–64.
- Li H, Zhou J-X, Chen L. Lung volumes and volumetric capnography. In: Bellani G, editor. *Mechanical Ventilation from Pathophysiology to Clinical Evidence.* Springer; 2022.
- Emanuele Rezoagli is supported by the Bicocca Starting Grant 2020 from the University of Milano-Bicocca with the project titled: "Functional Residual capacity Assessment using a Wash-In/Wash-Out technique based on a fast main-stream O2 Sensor with nanofluorescent geometry for severe lung injury (FAST)—COVID and beyond".
- iFox has a deposited patent n:102022000026340.

Topic: Translational Medicine

001419

Venous excess ultrasound score is associated with acute kidney injury in critically ill patients

K. Trigkidis¹, I. Siempos¹, A. Kotanidou¹, C. Routsis¹

¹First Department of Critical Care Medicine National and Kapodistrian University of Athens, Evangelismos Hospital, Athens, Greece

Correspondence: C. Routsis

Intensive Care Medicine Experimental 2023, **11** (Suppl 1):001419

Introduction: Acute kidney injury (AKI) in intensive care unit (ICU) is a common problem and is associated with adverse outcomes (1). Among other causes, fluid overload (2) and venous congestion (3) have been implicated. Venous excess ultrasound (VExUS) grading system quantifies Doppler flow patterns of multiple ultrasound findings (hepatic veins, portal vein and intra-renal veins) reflecting right atrial pressure and venous congestion (4).

Objectives: The objective of this study was to determine whether VExUS score and the portal vein pulsatility index (PPI) are associated with the occurrence and severity of AKI in a general cohort of critically ill patients during the ICU stay.

Methods: We conducted a prospective observational study enrolling consecutive patients admitted to the ICU. Measures of venous congestion including hepatic and renal Doppler ultrasound assessments were performed within the first 24 h of ICU admission (Day1) and 24–72 h after admission (Day 2). Accordingly, VExUS score was calculated. PPI was calculated as the ratio between minimal and maximal variation of the portal blood velocity over the cardiac cycle. Clinical data including serum creatinine and urine output were recorded in order to define AKI and AKI stages according to the KDIGO definition.

Results: From October 2022 to March 2023, we enrolled 66 patients (mean age 59.2 ± 15.4 years, 57.6% males), on mechanically ventilation because of respiratory failure of various etiologies. In the subgroup of patients who did not have AKI on ICU admission ($n = 37$, 56.1%), 18 patients (48.6%) developed AKI within 28 days of ICU admission and 8 (21.6%) required Continuous Renal Replacement Therapy (CRRT). In this subgroup, VExUS score on Day 2 was associated at a statistically significant level with the development ($p = 0.029$) as well as with the severity of AKI ($p = 0.046$). Moreover, in the same subset of patients the absolute difference of VExUS score between Day 2 and Day 1 was significantly associated with CRRT duration ($p = 0.0158$) whereas the association of PPI value with subsequent AKI development and severity did not reach statistical significance.

Conclusions: VExUS score within 24–72 h after ICU admission was significantly associated with subsequent AKI development and AKI severity suggesting the venous congestion as an important cause or contributing factor. Therefore, these tools could provide a potential for guiding the clinical management aimed at preventing AKI in critically ill, mechanically ventilated patients.

References

- Singbartl K. et al. AKI in the ICU: definition, epidemiology, risk stratification, and outcomes. *Kidney Int* 2012;81:819–25.
- Wang N et al. Fluid balance and mortality in critically ill patients with acute kidney injury: a multicenter prospective epidemiological study. *Crit Care.* 2015;19:371.
- Chen K.P. et al. Peripheral Edema, Central Venous Pressure, and Risk of AKI in Critical Illness. *Clin J Am Soc Nephrol.* 2016;11:602–8.
- Beaubien—Souligny W. et al. Quantifying systemic congestion with Point-Of-Care ultrasound: development of the venous excess ultrasound grading system. *Ultrasound J.* 2020;12:16.

Topic: Acute Kidney Injury and haemofiltration

001421

Dual-energy computer tomography to quantify the effect of obesity on inflation/perfusion matchingK.J. Bjarnadóttir¹, G. Perchiazzi², C. Sidenblad³, A. Larina⁴, M. Segelsjö⁵, T. Hansen⁵, R. Frithiof⁶, M. Hultström⁶, M. Lipcsey⁷, M. Pellegrin⁴

¹Anesthesia and Intensive Care, Akademiska Uppsala University Hospital, Uppsala, Sweden; ²Hedenstierna Laboratory, Department of Surgical Sciences and, Department of Anesthesia and Intensive Care Medicine of Uppsala University Hospital, Uppsala, Sweden; ³Anesthesiology and Intensive Care, Hudiksvalls Sjukhus, Hudiksvall, Sweden; ⁴Department of Anesthesia and Intensive Care Medicine of Uppsala University Hospital, Hedenstierna Laboratory, Department of Surgical Sciences, Uppsala, Sweden; ⁵Department of radiology, Uppsala University Hospital, Uppsala, Sweden; ⁶Department of Anesthesia and Intensive Care Medicine, Uppsala University Hospital, Uppsala, Sweden; ⁷Intensive Care Units, Department of Surgical Sciences, Uppsala University Hospital, Uppsala, Sweden

Correspondence: K.J. Bjarnadóttir*Intensive Care Medicine Experimental* 2023, **11 (Suppl 1)**:001421

Introduction: Mechanical ventilation (MV) is frequently applied in the management of acute respiratory failure to improve patient outcomes. If not adequately monitored, MV has the potential to cause ventilator-induced lung injury. With over 20% of the patients admitted to the intensive care unit being obese, the impact of patients' weight on lung mechanics must be considered when devising a protective strategy for MV. The increased weight on the chest wall in obesity results in decreased lung volumes, increasing the risk for airway closure and atelectasis, potentially impairing gas/blood matching. Conversely, increased weight can be a protective factor by increasing chest wall elastance and leading to better gas/blood matching within the lung. The effect of obesity on pulmonary gas and blood distribution in mechanically ventilated patients has not been previously investigated and to what extent MV affects the distribution of gas and blood within the lung is generally not monitored in the clinical setting.

Objectives: This study aimed to evaluate the effect of obesity on pulmonary gas and blood distribution using dual-energy computer tomography (DECT).

Methods: This prospective single-center study included patients older than 18 years with severe COVID-19, admitted to the intensive care unit at the Uppsala University Hospital, Sweden, and underwent at least one chest DECT. Data was collected from April 7, 2020 to October 5, 2021. Patients were divided into three groups according to body mass index (BMI): underweight to normal weight with BMI < 25 kg/m², overweight to obese with BMI 25–40 kg/m², and morbid obese with BMI > 40 kg/m².

For each DECT investigation, 19 equally spaced DECT scans were selected between the apex and the diaphragmatic level. Inflation and perfusion maps were created for each scan representing the gas and blood distribution within the lung. For each map, a Hounsfield unit (HU) distribution was analyzed for the whole lung as well as at a regional level (10 levels along the gravitational axis). The gas/blood mismatch was calculated by comparing the HU distribution of gas and blood, where dead space was defined as gas exceeding blood and shunt, as blood exceeding gas. This analysis was performed for each BMI group separately.

Results: Data was collected for 118 patients and 142 DECT investigations were analyzed. The BMI > 40 kg/m² group had less hyperinflation in the non-dependent (ND) regions and poorly or non-inflated in the dependent regions (D), compared to BMI < 25 kg/m². BMI > 40 kg/m² showed more blood distribution away from poorly or non-inflated lung regions thereby, achieving less of a gas-blood mismatch (30%) when compared with the other two groups (36%).

Conclusions: This study demonstrated that morbid obesity improves gas/blood matching. DECT can be a useful tool, quantifying regional dead space and shunt thus providing additional information for a more individualized mechanical ventilation.

References

- Ball, L., Robba, C., Herrmann, J. et al. Lung distribution of gas and blood volume in critically ill COVID-19 patients: a quantitative dual-energy computed tomography study. *Crit Care* 25, 214 (2021). <https://doi.org/10.1186/s13054-021-03610-9>
- Gattinoni L, Caironi P, Pelosi P, Goodman LR. What has computed tomography taught us about the acute respiratory distress syndrome?. *Am J Respir Crit Care Med*. 2001;164 (9):1701–1711. <https://doi.org/10.1164/ajrccm.164.9.2103121>
- Dixon AE, Peters U. The effect of obesity on lung function. *Expert Rev Respir Med*. 2018;12 (9):755–767. <https://doi.org/10.1080/17476348.2018.1506331>
- Schetz M, De Jong A, Deane AM, et al. Obesity in the critically ill: a narrative review. *Intensive Care Med*. 2019;45 (6):757–769. <https://doi.org/10.1007/s00134-019-05594-1>
- Coudroy R, Vimperc D, Aissaoui N, et al. Prevalence of Complete Airway Closure According to Body Mass Index in Acute Respiratory Distress Syndrome. *Anesthesiology*. 2020;133 (4):867–878. <https://doi.org/10.1097/ALN.00000000000003444>
- Slutsky AS, Ranieri VM. Ventilator-Induced Lung Injury. *NEJM* 2013;369:2126–2136.

Topic: Acute respiratory failure and mechanical ventilation

001422

Mechanical ventilation induced increase in intrapulmonary postcapillary resistance plays a key role in diminishing left ventricle filling and cardiac outputA. Landesberg¹, O. Andriess¹, N. Markovitch¹, A. Livneh¹, Y. Bar-Lavie²¹Biomedical Engineering, Technion-Israel Institute of Technology, Haifa, Israel; ²Critical Care Medicine, Rambam Health Care Campus, Haifa, Israel**Correspondence:** A. Landesberg*Intensive Care Medicine Experimental* 2023, **11 (Suppl 1)**:001422

Introduction: Mechanical ventilation (MV) induced decrease in cardiac output (CO) is commonly attributed to a decrease in right ventricular (RV) preload and an increase in RV afterload. Moreover, the inspiratory increase in systolic pressure (Δ up) is attributed to a temporary increase in left ventricular (LV) stroke volume (SV).

Objectives: We have hypothesized that MV directly reduces LV filling and CO by decreasing the intrapulmonary vascular transmural pressures, which increases the vascular resistance. The phenomenon is critical in the postcapillary vessels with the lower intravascular pressure, where it can lead to postcapillary collapse.

Methods: The hypothesis was validated in normal sheep (N = 6) under regular pressure-controlled ventilation (PEEP: 2.4 ± 0.89 cmH₂O, driving pressure: 12.4 ± 0.89 cmH₂O; inspiration/expiratory ratio 1:2). The effects of MV on pulmonary hemodynamics and cardiac function were measured by simultaneous recording of both right and left pressure-volume loops, utilizing two impedance catheters (CD-Leycom) within both ventricles.

Results: The aortic systolic pressure increased during inspiration (Δ up = 6.364 ± 2.38 mmHg), but the peak always occurred before end inspiration (blue arrows in the Fig.). The pulmonary artery systolic pressure also increased during inspiration, despite the prominent inspiratory decrease in RV end-diastolic volume and SV. While the RV systolic pressure increased, there was significant decreases in the LV end-diastolic volume (EDV) and SV (-5.57 ± 6.16 [ml], -15.98 ± 19.16 [%]), measured at the time of peak inspiratory aortic pressure relative to the end-expiratory values. Interestingly, the progressive decrease in LV EDV that was followed by progressive decrease in LV-SV was observed immediately from the beginning of inspiration (red arrow in the Fig). LV filling decreases despite the increase in pulmonary artery pressure due to the increase in pulmonary vascular resistance. However, the immediate inspiratory decline in LV EDV and filling cannot be attributed to the effects of MV on RV function, which should appear with some delay. The

immediate decrease in LV filling strongly supports the immediate development of high resistance to flow from intrapulmonary postcapillary blood pool due to development of postcapillary high resistance to flow. The aortic systolic pressure (Δ up, blue arrows) increased due to the increase in the intrathoracic pressure, and not due to an increase in LV-SV. The progressive decline the LV-SV leads to reversal of the trend and to decline in systolic pressure already during inspiration.

Conclusions: The inspiratory increase in systolic pressure (Δ up) is not a reliable hallmark of an increase in LV-SV. MV can decrease the CO by increasing the postcapillary resistance which directly diminishes LV filling, even in the presence of significant Δ up. This mechanism is critical in planning the optimal MV and oxygen delivery.

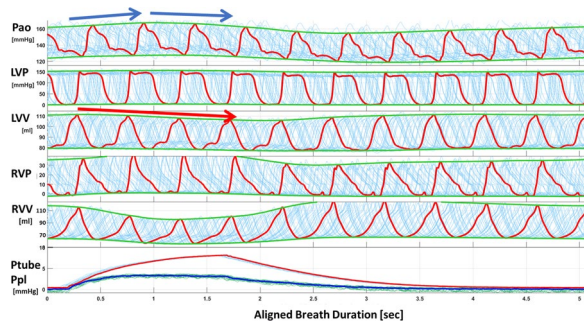

Mechanical ventilation (Peep=2.0, driving pressure=10.0 cmH₂O) increases the systolic aortic pressure (Δ up, blue arrows) during inspiration. However, there is an immediate decline of LV EDV from the beginning of inspiration (red arrow) due to the development of intrapulmonary postcapillary high resistance to blood flow. All the cardiac cycles (thin blue and bold red cycles) were aligned to the intratracheal tube pressure (Ptube, red). Pao-Aortic pressure, LVP- LV pressure, LVV- LV volume, RVP- RV pressure, RVV- RV- volume, Ppl- Pleural pressure (blue).

Topic: Cardiovascular issues in ICU

001425

Organisation and reimbursement of intensive care across European countries

E. Berger¹, H. Lantzsich¹, M. Blümel², R. Busse¹

¹Health Care Management, Berlin Institute of Technology, Berlin, Germany; ²Health Care Management, technische Universität Berlin, Berlin, Germany

Correspondence: E. Berger

Intensive Care Medicine Experimental 2023, **11** (Suppl 1):001425

Introduction: During the pandemic, intensive care units (ICUs) and especially their capacity was a heavily discussed topic in Europe. As a result, many European countries have increased their intensive care capacities to ensure treatment of all patients with a COVID-19 infection (Berger et al. 2021). A Belgian analysis, however, revealed that ICU organisational characteristics, among other factors, were associated with in-hospital mortality (Van de Voorde et al. 2020). This includes, for example, ICU overflow and a high proportion of additionally created ICU beds (Berger et al. 2021). As an internationally accepted definition of intensive care and its organisation and financing is missing, the Belgian Health Care Knowledge Centre (KCE) initiated the project "The organisation and reimbursement of intensive care in different European countries" which is integrated into a larger study.

Objectives: The aim of the project is to review international models for the organisation and reimbursement of intensive care.

Methods: Based on a scoping review a longlist of countries was compiled as a first step. For the longlist, we focused on a large regional coverage of European countries and further included countries with peculiarities in the organisation and remuneration of intensive care

medicine. As a second step, a set of criteria was defined to select about 5–7 countries for the shortlist. The final sample includes the following countries: Denmark, England, France, Germany, Italy, the Netherlands, Sweden. For these countries, an international questionnaire-based expert survey has been carried out.

Results: For the countries included, the following main research questions will be answered:

1. How is intensive care legally defined?
2. How is intensive care organised?
3. How is intensive care reimbursed?
4. Are there internationally defined and available indicators to measure outcome quality of ICUs?

Conclusions: The results of this ongoing study should inform decision makers to tackle future crises and to improve the organisation and reimbursement of intensive care medicine in general.

References

1. Van de Voorde C, Lefèvre M, Mistiaen P, Detollenaere J, Kohn L, Van den Heede K. Assessing the management of hospital surge capacity in the first wave of the COVID-19 pandemic in Belgium. *Brussels: Belgian Health Care Knowledge Centre (KCE); 2020 12/2020. KCE Reports 335* Available from: https://kce.fgov.be/sites/default/files/atoms/files/KCE_335_Surge_capacity_during_COVID_19_Belgium_Report.pdf
2. Berger, Elke; Winkelmann, Juliane; Eckhardt, Helene; Nimptsch, Ulrike; Panteli, Dimitra; Reichebner, Christoph et al. (2021): A country-level analysis comparing hospital capacity and utilisation during the first COVID-19 wave across Europe. In *Health policy* (Amsterdam, Netherlands) 126 (5), pp. 373–381. <https://doi.org/10.1016/j.healthpol.2021.11.009>.
3. The study was commissioned and funded by the Belgian Health Care Knowledge Centre

Topic: Critical care organisation, quality management, information systems, outcomes

001426

Kinetic GFR in AKI in ICU (KIA) study

V. R. Kola¹, M. Ravinder², C. Rajasekhar³, S. Goda⁴, P. Hari⁵, G. Aditya⁶, M. Ravikrishna⁴

¹critical care, yashoda hospitals, Hyderabad, India; ²Nephrology, UC San Diego School of Medicine, San Diego, United States of America; ³Nephrology, yashoda hospitals, Hyderabad, India; ⁴Critical Care medicine, Yashoda Hospitals Hitec City, Kothaguda, India; ⁵Critical Care medicine, Yashoda Hospitals-Somajiguda, Hyderabad, India; ⁶Critical Care medicine, Yashoda Hospitals-Malakpet, Hyderabad, India

Correspondence: V.R. Kola

Intensive Care Medicine Experimental 2023, **11** (Suppl 1):001426

Introduction: Acute kidney injury complicates approximately 5% of hospital admissions and 30% of intensive care admissions.¹ Hence, this renal dysfunction may result in accumulation of antimicrobial agents with resultant adverse effects if not dosed properly.² The classical dosing of antimicrobials in Intensive care Unit depend upon the estimated Glomerular Filtration rate from steady state creatinine clearance equations namely Cockcroft-Gault, MDRD and CKD-EPI equations which fall short in estimating AKI. Kinetic GFR provides a reasonably good estimate of GFR in AKI.³

Objectives:

1. To assess the concordance—discordance between GFR Estimation by K-GFR, MDRD, CG and CKDEPI in AKI Patients.
2. Assess the clinical utility of k-GFR for Dosing Antimicrobials in Patients with Acute Kidney Injury Not Receiving Renal Replacement Therapy.
3. As a predictive tool and examine the association of k-GFR to adverse renal outcomes compared with measurements to traditional estimate

Methods: This is a prospective multicentric observational study being conducted in four tertiary care ICUs of Yashoda hospitals, Hyderabad, India. The study period is 2022 December to 2023 April. All AKI patients aged 18–70 years admitted to the ICU were included in this study. AKI was defined as per AKIN criteria and GFR was calculated on day 1 and day 2 of increase in creatinine with Cockcroft-Gault⁴, MDRD⁵, CKD-EPI⁶ and KeGFR⁷ equations. The concordance—discordance of eGFR

estimated from CG, MDRD and CKD-EPI equations with that calculated from KeGFR equation is calculated. The antimicrobial dosing estimated from the GFR calculated from CG, MDRD and CKD-EPI equations is compared with dosing estimated from GFR estimated from KeGFR equation. Prediction of adverse outcomes including requirement of renal replacement therapy and in-hospital mortality in AKI patients is calculated based on KeGFR and traditional estimating methods.

Results: A total of 311 ICU admitted patients with AKI were included in the study. Their concordance–discordance of GFR calculated with KeGFR equation with that of traditional methods is as follows.

eGFR estimated on Days 1 and 2 with various formulae

Day	Formula	mean eGFR	p value
Day 1	KeGFR	40.8	
	CG	43.23	0.153
	CKD-EPI	42.8	0.191
	MDRD	39	0.22
Day 2	KeGFR	45.4	
	CG	45.8	0.851
	CKD-EPI	44.3	0.563
	MDRD	40.9	0.02

Calculated antimicrobial dose with eGFR

Antibiotic	day	mean KeGFR dose	mean MDRD dose	p value
Meropenem	Day 1	2.06	2.01	0.38
	Day 2	2.13	2	0.03
Pip + Taz	Day 1	10.88	10.73	0.48
	Day 2	11.27	10.79	0.02
Teicoplanin	Day 1	749.6	747.02	0.82
	Day 2	736.3	742.57	0.62
Cef + Sul	Day 1	5.37	5.57	0.41
	day 2	5.34	5.63	0.57
Colistin (In MU)	Day1	5.53	5.47	0.06
	Day 2	5.46	5.43	0.81

Conclusions: Kinetic-GFR may be a better method to estimate GFR in acutely changing renal function- AKI patients for antimicrobial dosing.

References

- Cockcroft DW, Gault H. Prediction of Creatinine Clearance from Serum Creatinine. *Nephron*. 1976;16 (1):31–41. <https://doi.org/10.1159/000180580>
- Levey AS. A More Accurate Method To Estimate Glomerular Filtration Rate from Serum Creatinine: A New Prediction Equation. *Ann Intern Med*. 1999;130 (6):461. <https://doi.org/10.7326/0003-4819-130-6-199903160-00002>
- Inker LA, Eneanya ND, Coresh J, et al. New Creatinine- and Cystatin C–Based Equations to Estimate GFR without Race. *N Engl J Med*. 2021;385 (19):1737–1749. <https://doi.org/10.1056/NEJMoa2102953>
- Chen S. Retooling the Creatinine Clearance Equation to Estimate Kinetic GFR when the Plasma Creatinine Is Changing Acutely. *J Am Soc Nephrol*. 2013;24 (6):877–888. <https://doi.org/10.1681/ASN.2012070653>
- There are no financial grants for this study
- Kes P, Bašić Jukić N. Acute Kidney Injury in the Intensive Care Unit. *Bosn J Basic Med Sci*. 2010;10 (1):8. <https://doi.org/10.17305/bjbm.2010.2639>
- Awdishu L, Connor A, Bouchard J, Macedo E, Chertow G, Mehta R. Use of Estimating Equations for Dosing Antimicrobials in Patients with Acute Kidney Injury Not Receiving Renal Replacement Therapy. *J Clin Med*. 2018;7 (8):211. <https://doi.org/10.3390/jcm7080211>
- Bouchard J, Macedo E, Soroko S, et al. Comparison of methods for estimating glomerular filtration rate in critically ill patients with acute kidney injury. *Nephrol Dial Transplant*. 2010;25 (1):102–107. <https://doi.org/10.1093/ndt/gfp392>

Topic: Acute Kidney Injury and haemofiltration

001427

Prognostic factors associated with development of long-term physical, mental and cognitive outcome in ICU survivors. A systematic review

H. Tamminga-Oudman¹, M. Onrust¹, P. Van Der Voort¹, F. Blokzijl¹, W. Paans², J. Koeze¹

¹Department of Critical Care, University Medical Center Groningen, Groningen, Netherlands; ²Research Group Nursing Diagnostics, Hanze University of applied Sciences Groningen, Groningen, Netherlands

Correspondence: H. Tamminga-Oudman

Intensive Care Medicine Experimental 2023, **11 (Suppl 1)**:001427

Introduction: ICU survivors suffer high rates of adverse outcomes, a variety of physical, mental and cognitive health impairments, collectively known as post intensive care syndrome (PICS). However, it is still not fully clear which factors are associated with the development of PICS. Identification and recognition of factors associated with the development of PICS potentially facilitates interventions to reduce the burden of PICS and thereby may improve patient outcomes. Furthermore, it may support caregivers in communication with patients and their relatives.

Objectives: Therefore, we performed a systematic review analyzing the QoL of ICU survivors six months or more after their unscheduled ICU admission. The aim was to identify factors associated with the development of new onset long-term physical, mental and cognitive problems.

Methods: Data sources: We searched PUBMED from inception to March, 2020.

Study Selection: All prospective observational studies concerning the acutely admitted adult ICU patient, describing any domain of Health Related Quality of Life (HRQoL) and a follow up of at least six months, were selected.

Data extraction: In different phases of the selection process one to four reviewers were involved in study selection and risk-assessment. For the final selection or the articles, a third and fourth researcher joined to reach agreement. Risk assessment was performed using the Critical Appraisal Tool for use in JBI Systematic Reviews, Checklist for Cohort Studies.

Results: After screening 4715 articles, 54 studies were included. 14 studies used SF-36/SF-12, 10 studies used EQ-5D-VAS, 6 studies used HADS and the remaining studies used other instruments. Furthermore, the timing of evaluation of outcome differed between studies evaluating at 3 months up to 2 years. Further analysis is currently being performed.

Conclusions: One of the preliminary conclusions is the large variety in used instruments to evaluate long term outcomes which make different studies difficult to compare.

Full results will be presented during the congress.

Topic: Critical care organisation, quality management, information systems, outcomes

001428

Investigating long-term kidney function in intensive care survivors

R. Glendell¹, M. Andonovic², M. Shaw³, K. Puxty⁴

¹School of Medicine, University of Glasgow, Glasgow, United Kingdom;

²Academic Department of Anaesthesia and Critical Care, University of Glasgow, Glasgow, United Kingdom; ³Academic Unit of Anaesthesia,

Critical Care and Peri-operative Medicine, University of Glasgow, Glasgow, United Kingdom; ⁴Intensive Care Unit, Glasgow Royal Infirmary, Glasgow, United Kingdom

Correspondence: R. Glendell
Intensive Care Medicine Experimental 2023, 11 (Suppl 1):001428

Introduction: There is limited evidence on long-term post-intensive care (ICU) outcomes and investigation of outcome predictors following acute kidney injury (AKI) in ICU has been identified as an area for further study (1).

Objectives: This study aimed to model the trend of post-ICU discharge kidney function in ICU survivors using estimated glomerular filtration rate (eGFR) as a measure; compare kidney function in those who experienced in-ICU AKI to those who did not; and investigate potential risk factors associated with kidney function decline in ICU survivors.

Methods: This retrospective observational cohort study identified all patients aged 16 or older admitted to two general adult ICUs in the West of Scotland between 1st July 2015 and 30th June 2018 who survived to 30 days following hospital discharge. Baseline serum creatinine and subsequent values were used to identify patients with AKI and calculate eGFR following hospital discharge. Outcomes were kidney function following hospital discharge based on eGFR decline, difference in decline between AKI and non-AKI patients, and risk factors which affected this decline. Mixed effects modelling was used to control for repeated measures and missing data, and to allow inclusion of several exploratory variables.

Results: 3649 patients with a median of 21 eGFR measurements up to 2000 days of follow-up were included, with 1252 (34%) experiencing ICU-associated kidney injury. eGFR declined at a rate of -1.9 ml/min/1.73m²/year (p -value < 0.001) in the complete dataset. Patients with AKI experienced an accelerated rate of eGFR decline of -2 ml/min/1.73m²/year compared to a rate of -1.83 ml/min/1.73m²/year in patients who did not experience AKI (p -value 0.007). A past medical history of diabetes or liver disease was associated with accelerated eGFR decline in both patients who did and did not experience AKI. Pre-existing malignancy and cardiovascular disease were also associated with accelerated decline in patients with kidney injury. Length of vasopressor support was associated with accelerated eGFR decline in both cohorts.

Conclusions: ICU survivors experienced accelerated decline in kidney function regardless of whether they experienced AKI whilst in ICU. Pre-existing comorbidities and increasing length of vasopressor support were associated with accelerated eGFR decline. Long-term follow-up is warranted in all ICU survivors to monitor kidney function and reduce morbidity and mortality associated with chronic kidney disease.

References

- Vijayan A, Abdel-Rahman EM, Liu KD, Goldstein SL, Agarwal A, Okusa MD, et al. Recovery after Critical Illness and Acute Kidney Injury. Clin J Am Soc Nephrol [Internet]. 2021 Oct 1 [cited 2022 Nov 26];16 (10):1601. Available from: /pmc/articles/PMC8499012/

Topic: Acute Kidney Injury and haemofiltration

001429

Impact of critical illness on subsequent cancer care in colorectal cancer patients

S. MacTavish¹, K. Puxty², C. Taylor²

¹Medicine, University of Glasgow, Glasgow, United Kingdom; ²Intensive Care Unit, Glasgow Royal Infirmary, Glasgow, United Kingdom

Correspondence: S. MacTavish
Intensive Care Medicine Experimental 2023, 11 (Suppl 1):001429

Introduction: One in six colorectal cancer (CRC) patients are admitted to critical care (1). While many patients have planned admissions for post-operative support, around one in ten of all CRC patients require organ support (2). Cancer care is assessed by quality performance indicators (QPIs). In this study QPIs were used to compare the cancer care of patients by critical care cohort.

Objectives: To explore the impact of critical illness on the management of CRC patients with a focus on adjuvant chemotherapy.

Methods: QPI and demographic data for 14,946 patients diagnosed with CRC in Scotland between 2013 and 2018 was extracted from the CORECT-R data set. Patients were subdivided into 3 critical care cohorts: patients who were never admitted to critical care, patients who were admitted to critical care but did not receive organ support, and patients who received organ support. Data variables were created for each QPI and patients were stratified by critical care cohort and nature of admission then QPI attainment was calculated.

QPI 11 was examined using stepwise multivariable logistic regression to determine factors associated with receiving adjuvant chemotherapy. Factors significant during univariate analysis ($p < 0.1$) were analysed in an initial multivariate model and then, if still significant, put into a final model. This model was used to determine factors significantly associated with receiving adjuvant chemotherapy.

Results: Over half (54%) of patients with CRC were admitted to critical care and 11% of all patients received organ support. Out of the 13 QPIs and their subdivisions (19 targets overall) elective and emergency cohorts respective attainment of the QPIs were 10 and 8 for the no critical care cohort, 11 and 9 for the critical care without organ support group, and 4 and 3 for the organ support group. QPIs 12 and 6 (4 targets) were assessed without dividing patients by admission nature due to small numbers. The no critical care cohort attained 2 targets while both critical care cohorts attained 3.

Being admitted to critical care and receiving organ support, along with increasing age, socioeconomic deprivation and being admitted to hospital were significantly associated with a decreased chance of receiving adjuvant chemotherapy. After adjustment, being critically ill was significantly associated with being less likely to receive adjuvant chemotherapy. This is shown separately for Dukes C cancer and high-risk Dukes B cancer in Figure 1.

Conclusions: Critically ill CRC patients have poorer cancer care compared to other counterparts. Given that CRC patients becoming critically ill is not a rare occurrence, future research should focus on the impact of not receiving adjuvant chemotherapy on mortality and morbidity.

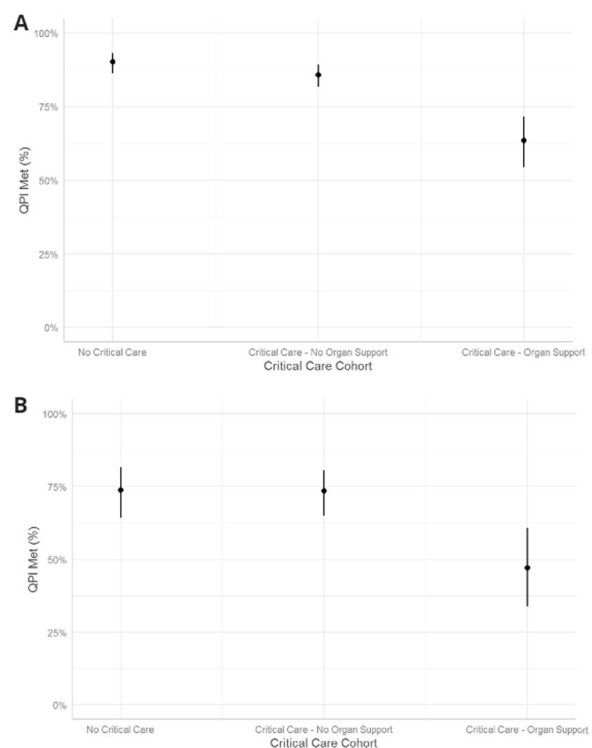

Figure 1 (abstract 001429) Predicted probabilities of patients attaining QPI 11 when adjusted for typical patient. A. Dukes C patients B. High risk Dukes B patients. Whiskers denote 95% confidence intervals.

References

2. Dale CD, McLoone P, Sloan B, Kinsella J, Morrison D, Puxty K, et al. Critical care provision after colorectal cancer surgery. *BMC Anesthesiol*. 2016;16 (1):94.
1. Puxty K, McLoone P, Quasim T, Sloan B, Kinsella J, Morrison DS. Risk of Critical Illness Among Patients With Solid Cancers: A Population-Based Observational Study. *JAMA Oncol*. 2015;1 (8):1078–85.
- The lead author of the abstract received an award from the Wolfson Foundation.

Topic: Critical care organisation, quality management, information systems, outcomes

001432

One small sTEP... improving treatment escalation planning documentation in a Scottish District General Intensive Care Unit

R. Thomas¹, J. Selfridge¹¹Intensive Care Unit, NHS Ayrshire and Arran, Crosshouse, United Kingdom**Correspondence:** R. Thomas*Intensive Care Medicine Experimental* 2023, **11 (Suppl 1)**:001432

Introduction: Treatment escalation planning encourages an individualised, patient-centred approach to medical treatments rather than relying on futile or burdensome protocol-driven interventions. Adequate communication of these treatment escalation discussions is essential, allowing for greater decision-making security for out of hours staff and could reduce the distress which results from providing futile, interventionist care.

Objectives: The primary objective was to improve the documentation of treatment escalation decisions in this ICU.

Methods: Quality improvement methodology was utilised to develop change ideas. Nurses and junior doctors were surveyed to understand their current experience regarding treatment escalation documentation. Key stakeholders were consulted early in the process with change ideas including creation of a new ICU-specific Treatment Escalation Plan (TEP) proforma and concomitant delivery of multi-professional education. We measured the percentage of patients who had a treatment escalation plan clearly documented in the notes to analyse the impact of change ideas.

Results: 289 patient's notes were reviewed using convenience sampling. The results from the initial staff survey demonstrated that prior to the project less than one third felt treatment escalation plans were clear and easily accessible and over two thirds of staff worried that they were not always aware of the most up to date treatment escalation discussions. Baseline data over the first nine weeks confirmed these views demonstrating that 17% of patients had documented treatment escalation plans. All staff surveyed thought an ICU-specific TEP proforma would be useful. Significant improvement in treatment escalation documentation was demonstrated with 70% of patients having a documented treatment escalation plan following the TEP proforma introduction and multi-disciplinary education.

Conclusions: A simple ICU-specific TEP proforma was created with early involvement of key stakeholders. This TEP proforma alongside multi-professional education significantly improved documentation of treatment escalation planning decisions in our ICU.

References

- Stockdale C, Trivedi B, Jerome E, et al. Implementation of a combined Cardiopulmonary Resuscitation and Treatment Escalation Plan document in a District General Hospital. *BMJ Open Quality* 2013;2:u202653.w1236. <https://doi.org/10.1136/bmjquality.u202653.w1236>. Available from: <https://bmjopenquality.bmj.com/content/2/2/u202653.w1236>
- Lightbody CJ, Campbell JN, Herbison GP, et al. Impact of a treatment escalation/limitation plan on non-beneficial interventions and harms

- in patients during their last admission before in-hospital death, using the Structured Judgment Review Method. *BMJ Open* 2018;8:e024264. <https://doi.org/10.1136/bmjopen-2018-024264>. Available from: <https://bmjopen.bmj.com/content/8/10/e024264>
- Taylor DR, Lightbody CJ, Venn R, Ireland AJ. Responding to the deteriorating patient: The rationale for treatment escalation plans. *Journal of the Royal College of Physicians of Edinburgh*. 2022;52 (2):172–179. <https://doi.org/10.1177/14782715221103390>. Available from: https://journals.sagepub.com/doi/10.1177/14782715221103390?url_ver=Z39.88-2003&rfr_id=ori:rid:crossref.org&rfr_dat=cr_pub%20%20pubmed

Topic: Critical care organisation, quality management, information systems, outcomes

001433

Are we looking in the right place for acute coronary syndrome patients? Short- and long-term predictors of mortality

A. Garrido Callen¹, D. Vasco Castaño¹, M. Pérez Torres¹, D. Maqueda Luva¹, G. Jimenez Alvarez¹, I. Fernandez Martin-Caro¹, I. Fernandez Muñoz¹, A. Bardal Ruiz¹, S. Lopez Cuenca¹, A. Martin Pellicer¹, M. Muñoz Varea¹, C. Merino Vega¹, M. Perez Torres¹, J. Cui², G. Castañeda², J. Cedeño Mora², P. García Olivares²¹Intensive care medicine, Hospital Universitario Rey Juan Carlos, Mostoles, Spain, Móstoles, Spain; ²Intensive care unit, H.G.U Gregorio Marañón, Madrid, Spain**Correspondence:** A. Garrido*Intensive Care Medicine Experimental* 2023, **11 (Suppl 1)**:001433

Introduction: During the last decades, numerous factors and predictive mortality scores have been described in patients with acute coronary syndrome. Their current validity is in doubt due to changes in management in recent years, such as the speed in diagnosis and response within the infarction code.

Objectives: To obtain and reassess predictive factors for mortality in patients with acute coronary syndrome (ACS) admitted to our unit from 2019 to 2021.

Methods: Prospective, observational study conducted on a cohort of all patients with a diagnosis of ACS requiring catheterization from January 2020 to November 2021. Epidemiological and clinical data, several severity scales, as well as related variables and outcomes were collected. In the descriptive analysis, quantitative variables were expressed as mean with standard deviation (normal distribution) or as median with interquartile range (IQR), and qualitative variables as percentages.

The predictive factors for mortality were obtained through univariate logistic regression without adjustment, and subsequently through multivariate analysis from a maximum model that included those significant or nearly significant variables ($p < 0.1$) from the univariate analysis adjusted for comorbidity and those considered clinically relevant, through stepwise selection based on Akaike information criterion.

Results: 155 patients were included in the study. Age was 63 ± 12 years, and 79% were male. 93.7% had a $CFS \leq 3$, and 53% had STEMI. 78% had Killip 1. Mortality in the ICU, at discharge, 6 months, and 12 months was 5.2%, 5.8%, 11%, and 15%, respectively. The ICU stay was 2 days IQR (1–3), and the hospital stay was 4 days IQR (3–6).

The following results were obtained in the multivariate analysis at twelve months mortality:

apacheii 1.11 (1.03–1.19).

nyha > = clase2 4.06 (1.23–12.95).

Conclusions: Based on our experience, despite examining multiple scores among patients with acute coronary syndrome, the only independent predictors of mortality were a prior NYHA score of $> = 2$ and the APACHE II score at admission.

Table 1 (abstract 001433) Univariate analysis at several times

OR CI (95%)	ICU MORTALITY	DISCHARGE MORTALITY	6 MONTHS MORTALITY	12 MONTHS MORTALITY
APACHE II	1.19 (1.10-1.31)	1.18 (1.01-1.30)	1.12 (1.05-1.20)	1.14 (1.07-1.23)
SAPSIII	1.17 (1.06-1.20)	1.11 (1.06-1.19)	1.06 (1.02-1.11)	1.06 (1.02-1.11)
ACEF (age/left ventricle ejection fraction)	4.83 (1.96-13.41)	4.70 (1.97-12.46)	3.77 (1.85-8.15)	3.35 (1.74-6.77)
INVASIVE MECHANICAL VENTILATION	19.80 (3.23-118.00)	15.72 (2.67-86.53)	18.94 (4.12-103.01)	12.50 (2.81-65.83)
ELECTRICAL COMPLICATIONS	17.04 (3.66-121.61)	11.27 (2.76-56.63)	3.90 (1.29-11.35)	3.82 (1.42-10.04)
MECHANICAL COMPLICATIONS	8.98 (1.85-48.65)	11.85 (2.68-61.90)	5.93 (1.89-18.23)	3.38 (1.15-9.40)

Topic: Cardiovascular issues in ICU

001437

The predictive value of BOBI score in burn patients under mechanical ventilation

S. Costa¹, A. Reigota², F. Catarina³, M. Gonçalo⁴, S. Miguel⁵, T. Isabel⁶, M. Margarida⁶, C. Luis⁶

¹Intensive Care, Hospital Santo André-Hospital Distrital de Leiria, Leiria, Portugal; ²Anesthesiology, Centro Hospitalar Baixo Vouga, Aveiro, Portugal; ³Anesthesiology, Centro Hospitalar Tondela-Viseu, Epe, Aveiro, Portugal; ⁴Intensive Care unit, Centro Hospitalar Universitário Cova da Beira (CHUCB), Covilhã, Portugal; ⁵Plastic Surgery, Centro Hospitalar e Universitário de Coimbra, Coimbra, Portugal; ⁶Coimbra Burns Center, Centro Hospitalar e Universitário de Coimbra, Coimbra, Portugal

Correspondence: S. Costa

Intensive Care Medicine Experimental 2023, **11 (Suppl 1)**:001437

Introduction: Mortality rates after burn injuries remains high (10–20%) even in well-equipped burn centers. Patients under mechanical ventilation (MV) after a burn injury have even higher mortality rates. Severity scoring systems provide a basis for clinical decision-making, having to be based on objective criteria, be accurate and easy to use. The Belgium Outcome Burn Injury (BOBI) score is a model that predicts mortality taking into account only three major risk factors: age (60 years or more); total burned surface area (TBSA) of at least 40% and presence of inhalation injury. The predictive value of this score in mechanically ventilated patients is still uncertain.

Objectives: The objective of this study is to access the capacity of the BOBI score in predicting in-hospital mortality in patients undergoing mechanical ventilation in a Burn Reference Center (BCR).

Methods: Retrospective study including all burn patients admitted to a BRC in a five year consecutive cohort (from 2018 to 2022), whom needed mechanical ventilation during the episode. Chi-square test was used for categorical variables, and analysis of variance for continuous variables. Binary logistic regression was used to control for confounding factors. The accuracy of BOBI score for prediction of in-hospital mortality was evaluated using the receiver operating characteristic (ROC) curve and computation of the area under the curve (AUC).

Results: A total of 151 ventilated patients were include, 68.2% of them were males. Mean age was 57.6 years-old. The median TBSA burned was 15.5% and 58.3% of the patients were ventilated in a pre-hospital set or at admission in urgency room, and for 41.7%, mechanical ventilation was initiated during the stay in burn unit.

In this cohort, the median length of stay at the burn unit was 22 days, with 13.8±16 days of mechanical ventilation. The mean BOBI score was 3 The mortality rate during burn unit stay was 28.9% (43 patients). After a logistic regression, that controlled for potential confounding factors, the predictors of mortality in this cohort were a higher TBSA (p=0.001), the need for antibiotic therapy (p=0.003) and a higher BOBI score (p=0.001).

Paying attention to the ROC, BOBI score proved to be a good mortality predictor the predictive value in the burn patients who needed mechanical ventilation during their stay at the Burn Unit (AUC 0.733, p=0.001).

Conclusions: In this cohort the BOBI score showed a good predictive power when it comes to in-hospital mortality.

References

- 3- Lip H., Idris M., Imran F., Azmah T., Huei T., Thomas M. Predictors of mortality and validation of burn mortality prognostic scores in a Malaysian burns intensive care unit. *BMC Emerg. Med.* 2019;19 (1)
- 2- Blot S. Development and validation of a model for prediction of mortality in patients with acute burn injury: the Belgian Outcome in Burn Injury Study Group. *Br. J. Surg.* 2008;96 (1):111–117
- 1- Peck M.D. Epidemiology of burns throughout the world. Part I: distribution and risk factors. *Burns.* 2011;37:1087e1100

Topic: Trauma

001438

The influence of different lighting conditions on serum cortisol levels in mechanically ventilated critically ill patients

L. Hancke¹, F. Borchers¹, C. Spies¹, K. D. Wernecke², H. Piazena¹, A. Lütz¹

¹Anesthesiology and Intensive Care Medicine, Charité-Universitätsmedizin Berlin, Berlin, Germany; ²Institut of Biometry and Clinical Epidemiology, Charité-Universitätsmedizin Berlin, Berlin, Germany

Correspondence: L. Hancke

Intensive Care Medicine Experimental 2023, **11 (Suppl 1)**:001438

Introduction: Abnormal zeitgebers, such as inadequate lighting conditions in the ICU, are supposed to promote chronodisruption and poor outcomes in critically ill patients¹. Cortisol and melatonin levels, which follow distinct circadian rhythms in healthy humans, exhibit pathological 24 h secretion patterns in ICU patients². Studies revealed that bright light exposure significantly influences cortisol levels in healthy subjects^{3,4}.

Objectives: To evaluate the effect of different lighting conditions on cortisol levels in mechanically ventilated critically ill patients.

Methods: In 2013 we finished rebuilding two 2-bed ICU rooms. Among interventions for noise reduction and workflow optimisation, the modified rooms were equipped with a new light ceiling for dynamic bright light therapy. Light intensity was defined by calculating the circadian effective irradiance (EC) in standard and modified rooms. It uses spectral lighting data measured at the patient's eye level, weighted by the action spectrum of melatonin suppression⁵. We analysed cortisol data from a prospective observational cohort study (NCT02143661) approved by the ethical review committee (EA1/019/14). Mechanically ventilated patients with an expected ICU length of stay > 48 h were included. Amongst others, patients with substantial recent ICU exposure and patients who were unlikely to survive for 24 h were excluded. Serum cortisol levels were measured for a maximum of three 24-h periods (serum cortisol assessment period, SCAP-A, -B and -C) every four hours starting at 8am. Differences in cortisol levels between patients in standard and modified rooms were analysed using multivariate non-parametric covariance analysis of longitudinal data.

Results: Data from 74 patients (n=37 standard vs. n=37 modified room) were included in data analysis. Serum cortisol levels under the influence of EC were significantly different between patients in standard and modified rooms during the whole time course of SCAP-A (P=0.0055) and SCAP-B (P=0.0087) but not for SCAP-C (P=0.4628). Patients in both groups showed systematic time effects for all SCAP's, referring to significant changes in cortisol levels in time (P<0.0001). Significant interactions for all SCAP's (P<0.0001) revealed that differences in cortisol between rooms are not the same over time but vary in specific periods (Table 1). There are distinct differences in relative effect sizes between rooms during 8am and 4 pm which disappear in the evening and night (Figure 1).

Table 1 (abstract 001438) Multivariate test statistics of serum cortisol under the influence of circadian effective irradiance (EC)

Hypothesis	P-Value SCAP-A	P-Value SCAP-B	P-Value SCAP-C
Difference between groups during entire SCAP	0.0055	0.0087	0.4626
Systematic time effect	< 0.0001	< 0.0001	< 0.0001
Interactions: Differences do change during SCAP between groups	< 0.0001	< 0.0001	< 0.0001

Comparison of cortisol levels between patients in standard (n=37) and modified (n=37) rooms. SCAP, serum cortisol assessment period: A, 1st day of intervention; B, 3rd day of intervention or later; C, 5th day of intervention or later.

Conclusions: Lighting conditions significantly influenced circadian cortisol levels in mechanically ventilated ICU patients. The 24-h patterns were different for patients with bright light therapy in the modified rooms compared to patients who received conventional lighting in standard rooms. As the modified rooms received various changes in design and equipment, observed effects on cortisol levels are not solely attributable to the different lighting conditions.

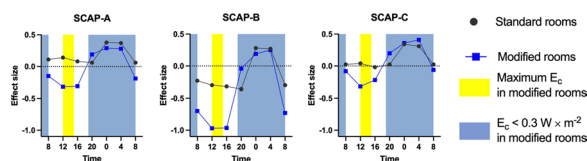

Figure 1 (abstract 001438) Relative effect sizes of serum cortisol levels under (Ec). SCAP, Serum Cortisol Assessment Period: SCAP-A, intervention or later; SCAP-B, 3rd day of intervention or later; SCAP-C, 5th day of intervention or later. Comparison of cortisol levels between patients in standard (n=37) and modified (n=37) rooms.

References

- Gao C, Knauer M. Circadian Biology and Its Importance to Intensive Care Unit Care and Outcomes. *Seminars in Respiratory and Critical Care Medicine*. 2019;40 (05):629–637. 2. Paul T, Lemmer B. Disturbance of Circadian Rhythms in Analgosedated Intensive Care Unit Patients with and without Craniocerebral Injury. 2009;24 (1). 3. Jung CM, Khalsa SBS, Scheer FAJL, et al. Acute effects of bright light exposure on cortisol levels. *Journal of biological rhythms*. 2010;25 (3):208–16. 4. Figueiro MG, Rea MS. The Effects of Red and Blue Lights on Circadian Variations in Cortisol, Alpha Amylase, and Melatonin. *International Journal of Endocrinology*. 2010;2010:829,351. 5. Luetz A, Piazena H, Weiss B, et al. Patient-centered lighting environments to improve health care in the intensive care unit. *Clinical Health Promotion*. 2016;6 (1):5–12.

Topic: Metabolism, endocrinology, liver failure and nutrition

001439

Sodium changes in trauma brain injury patients as a proxy of severity: modeling of trajectories fit for 1346 patients from CENTER-TBI

F. Mulazzani¹, F. Graziano², A. Rossi¹, P. Mangli³, A. Addis⁴, F. Zadek⁵, B. Noè¹, T. Langer⁶, G. Citerio³

¹Department of Medicine and Surgery, Università degli Studi di Milano Bicocca, Milano, Italy; ²Bicocca Bioinformatics Biostatistics and Bioimaging Center B4, School of Medicine and Surgery, University of Milano-Bicocca, Milano, Italy; ³Neuroscience Department, Fondazione

IRCCS San Gerardo dei Tintori, Monza, Italy; ⁴School of Medicine and Surgery, University of Milano-Bicocca, Monza, Italy; ⁵Department of Medicine and Surgery, Building U8-University of Milan Bicocca, Monza, Italy; ⁶Department of Anesthesiology, Fondazione IRCCS Ca'Granda Ospedale Maggiore Policlinico, Milano, Italy

Correspondence: F. Mulazzani

Intensive Care Medicine Experimental 2023, **11 (Suppl 1)**:001439

Introduction: The relationship between Intracranial Pressure (ICP) and sodium disorders is well understood as regarded the role of osmolality changes in the brain swelling process. The maintenance of plasma sodium concentration within a precise range has entered a routine practice in the management of Trauma Brain Injury (TBI) in Intensive Care Unit (ICU). Indeed, among therapies to lower ICP, increasing evidence emerges about the administration of hyperosmolar solutions (i.e. hypertonic saline solution). Meanwhile, targeting plasma sodium concentration at higher levels has not demonstrated efficacy to prevent an increase in ICP rather the acute difference generated after administration of hyperosmolar solutions seems to be effective in lowering ICP 3456. We investigated the association of sodium changes during the first week in the ICU defined as trajectories in which patients were evaluated for the probability to be allocated since admission to the ICU. For each trajectories, we secondarily investigated the association with the functional outcome as GOSE at 6 months.

Methods: Patients from the CENTER-TBI cohort admitted to Intensive Care Unit (ICU) who had sodium measure for at least three days within the first week were included in the analysis. Candidate models were investigated by varying the number and the shape (linear or modeled by splines) of trajectories, and the inclusion of baseline covariates on trauma severity (e.g. age, pupil's reactivity, and Glasgow Coma Scale). Logistic regression was used to assess the association between identified patterns and poor neurological outcomes at 6 months.

Results: A total of 1376 patients, with 7040 sodium measurements, fulfilled the study criteria. The final model included three sodium trajectories labeled by the degree of sodium increase: "fast-increase" (class-1, n=285.22%), "moderate-increase" (class-2, n=777.60%), and "stability" (class-3, n=235.18%). Patients were allocated and age, pupil reactivity, and Glasgow Coma Scale were selected as predictors of a trajectory group membership. The regression model found a significant association on poor outcomes only for class-1 compared with class-3 (OR = 4.9, 95%CI = 2.73–6.81).

Conclusions: In TBI patients admitted to ICU, severity was a predictor of their sodium trajectory. The fast increase trajectory was significantly associated with unfavorable outcomes reflecting more severe patients and, probably, more aggressive treatment should be investigated.

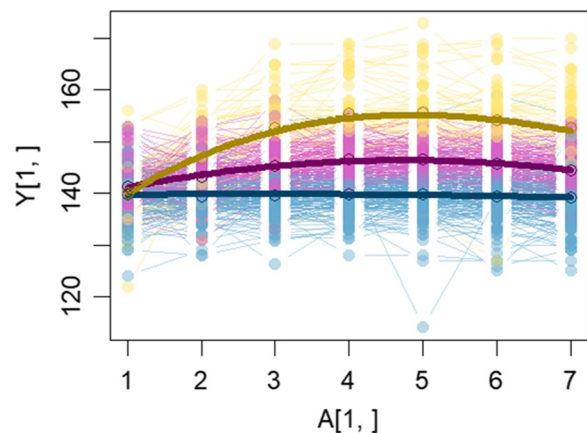

Figure 1 (abstract 001439) Graphical representation of sodium concentration (Y [1,]) changes trajectories: "fast-increase" (yellow lines), "moderate-increase" (purple lines) and "stability" (blue lines) within the first seven days (A [1,]).

References

- Carney N et al. Neurosurgery 2017
- Wells DL et al. Crit Care 2012
- Keonig MA et al. Neurology 2008
- Cottenceau V et al. J Neurotrauma 2011
- Patil H et al. World Neurosurg 2019
- Himmelseher S et al. Curr Opin Anaesthesiol 2007

Topic: Neurointensive care

001440

Quality improvement initiatives for sepsis and recording of sepsis mortality in hospitals of different sizes: results from an international survey

C. S. Scheer¹, A. Linder², R. Ferrer Roca³, D. Annane⁴, A. Artigas⁵, AT. Aslan⁶, G. Bottari⁷, H. R. Bouma⁸, V. Cerny⁹, K. Dewitte¹⁰, M. Gurjar¹¹, J. Hästbacka¹², E. A. Idelevich¹³, S. Laribi¹⁴, A. T. Lassen¹⁵, K. Lebedinski¹⁶, J. Máca¹⁷, M. Malbrain¹⁸, G. Monti¹⁹, M. Ostermann²⁰, M. Osthoff²¹, J. A. Paiva²², D. Protsenko²³, M. Sabbatucci²⁴, R. Curic Radivojevic²⁵, J. Smiechowicz²⁶, M. G. Stefan²⁷, K. Reinhart²⁸, E. Giamarellos-Bourboulis²⁹, D. Filipescu²⁷

¹Department of Anesthesiology, Emergency and Intensive Care Medicine, University Medicine Greifswald, Greifswald, Germany; ²Division of Infection Medicine, Lund University, Faculty of Medicine, Department of Clinical Sciences Lund, Lund, Sweden; ³Intensive care department, Vall d'Hebron University Hospital, Barcelona, Spain; ⁴Intensive Care, Assistance Publique-Hôpitaux de Paris, Hôpital Raymond Poincaré, Garches, France; ⁵Department of Intensive Care Medicine, Corporacion Sanitaria Universitaria Parc Tauli, Barcelona, Spain; ⁶Department of Internal Medicine, Hacettepe University, Ankara, Turkey; ⁷Pediatric Intensive Care Unit, Department of Emergency and General Pediatrics, Bambino Gesù Children's Hospital, Roma, Italy; ⁸Department of Internal Medicine, Clinical Pharmacy and Pharmacology, University Medical Center Groningen, University of Groningen, Groningen, Netherlands; ⁹Czech Republic, Masaryk Hospital, University J.E. Purkyne, ccc, Usti nad Labem, Czech Republic; ¹⁰Emergency Department, Antwerp University Hospital, Edegem, Belgium; ¹¹Intensive Care Medicine, Anjay Gandhi Post Graduate Institute of Medical Sciences, Lucknow, India; ¹²Intensive Care Units, Department of Anaesthesiology, Intensive Care and Pain Medicine, University of Helsinki and Helsinki University Hospital, Helsinki, Finland; ¹³Friedrich Loeffler-Institute of Medical Microbiology, University Medicine Greifswald, Greifswald, Germany; ¹⁴Emergency Department, Tours University Hospital, Tours, France; ¹⁵Department of Emergency Medicine, Odense University Hospital, Odense, Denmark; ¹⁶Department of Anesthesiology and Intensive Care, I.I. Mechnikov North-Western State Medical University, Saint Petersburg, Russia; ¹⁷Department of Anaesthesiology and Intensive Care Medicine, University Hospital Ostrava and University Ostrava, Faculty of Medicine, Ostrava, Czech Republic; ¹⁸First Department of Anaesthesiology and Intensive Therapy, Medical University of Lublin, Lublin, Poland; ¹⁹Dipartimento di anestesia e rianimazione, ASST Great Metropolitan Niguarda, Milano, Italy; ²⁰Intensive care, Guys & St Thomas Nhs Foundation Trust, London, United Kingdom; ²¹Division of Internal Medicine, Department of Biomedicine and Department of Clinical Research, University Hospital Basel, University of Basel, Basel, Switzerland; ²²Emergency and intensive care department, Centro Hospitalar de São João, Porto, Portugal; ²³City clinical hospital named after S.S. Yudin, Moscow, Russia; ²⁴Directorate General Health Prevention, Communicable Diseases and International Prophylaxis, Ministry of Health, Rome, Italy; ²⁵Department of Anaesthesiology, Resuscitation and Intensive Care, Zagreb University Hospital Centre, Zagreb, Croatia; ²⁶Department of Anesthesiology and Intensive Therapy, Wrocław Medical University, Wrocław, Poland; ²⁷Department of Anaesthesiology and Intensive Care, "Prof Dr CC Iliescu" Emergency Institute for Cardiovascular Diseases, Bucharest, Romania; ²⁸Department of Anesthesiology and Operative Intensive Care Medicine, Charité Universitätsmedizin Berlin, Berlin, Germany; ²⁹4th Department of Internal

Medicine, National and Kapodistrian University of Athens, Medical School, Athens, Greece

Correspondence: C.S. Scheer

Intensive Care Medicine Experimental 2023, **11** (Suppl 1):001440

Introduction: Numerous studies have shown beneficial effects of quality improvement initiatives (QII) for sepsis (1–6). Surviving sepsis campaign guidelines have recommended such initiatives for more than 10 years (7); whether these initiatives are applied or not remains unknown.

Objectives: The European Sepsis Care Survey was an initiative of the European Sepsis Alliance in the aim to investigate the current situation of sepsis care in a large sample of European and non-European hospitals. Presence of any kind of sepsis quality improvement initiatives and the existence of sepsis mortality recording were part of this analysis.

Methods: Between August 2021 and June 2022, the European Sepsis Care Survey investigated structures of sepsis care in acute care hospitals. The used online survey was primary addressed to European hospitals but non-European hospitals were also eligible. Participation was controlled by previous registration followed by a personalised invitation. The multidisciplinary cross-sectional questionnaire included 94 questions, harmonized by a multi-society (ESA, ESICM, ESAIC, ESCMID, EUSEM, ESS, ESPNIC and IFA) steering committee. Participating hospitals were grouped according to high- or middle-income countries and bed capacity (5 strata by number of hospital beds: 0–250, 251–500, 501–750, 751–1000 and > 1000).

Results: 970 hospitals from 68 countries were considered for this analysis. Of these, 705 (72.7%) hospitals were located in the European Union. The distribution of the different hospital sizes is shown in Figure 1. Overall, 31.3% (276/866) of the hospitals reported QII for sepsis. In high-income countries, QII were reported in 28.0% (176/629) and in middle-income countries in 39.4% ($p < 0.001$). Presence of sepsis QII differs depending on the hospital size ($p = 0.028$). A hospital size-related trend to higher rates of QII was observed in middle-income countries, but not in high-income countries (Fig. 2). Recording sepsis mortality was reported from 44.4% (431/970) of the hospitals, in high-income countries in 38.4% (262/682) and in middle-income countries in 58.7% (169/288) ($p < 0.001$). Presence of sepsis mortality recording also differed in hospitals of different sizes and between high- and middle-income countries (Fig. 3).

Conclusions: Sepsis quality improvement initiatives are not widespread, despite longstanding recommendations and numerous successful sepsis quality improvement studies in the past (1–6). Hospitals with any kind of quality improvement initiative for sepsis were outnumbered in this large sample of mainly European Hospitals. Perception is that there are more efforts in larger hospitals in middle-income countries compared to high-income countries.

Systematic recording of sepsis mortality as an important indicator of quality was scarce, especially in hospitals from high-income countries.

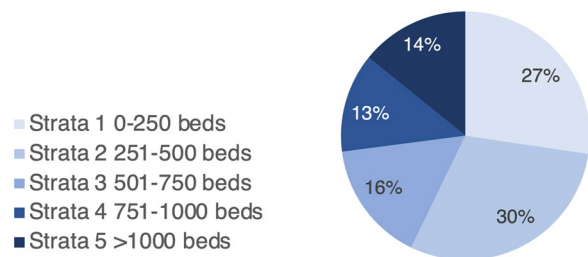

Figure 1 (abstract 001440) Size distribution of participating hospitals

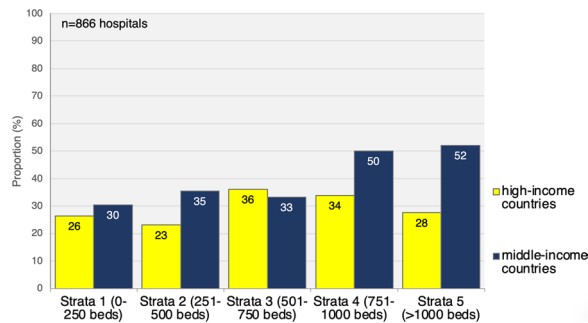

Figure 2 (abstract 001440) Presence of any kind of quality improvement initiative for sepsis

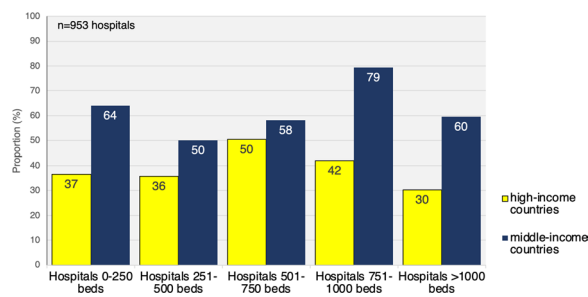

Figure 3 (abstract 001440) Presence of sepsis mortality recording

References

1. The European Sepsis Care Survey was funded by the European Sepsis Alliance and a grant by Becton & Dickinson (BD).
2. 7. Dellinger RP et al. Intensive Care Med. 2013 Feb;39 (2):165–228. <https://doi.org/10.1007/s00134-012-2769-8>.
3. 6. Levy MM et al. Am J Respir Crit Care Med. 2018 Dec 1;198 (11):1406–1412. <https://doi.org/10.1164/rccm.201712-2545OC>.
4. 5. Scheer CS et al., Crit Care Med. 2017 Feb;45 (2):241–252. <https://doi.org/10.1097/CCM.0000000000002069>.
5. 4. Noritomi DT et al. Intensive Care Med. 2014 Feb;40 (2):182–191. <https://doi.org/10.1007/s00134-013-3131-5>.
6. 3. Levy, MM et al. Intensive Care Med. 2014 Nov;40 (11):1623–33. <https://doi.org/10.1007/s00134-014-3496-0>.
7. 2. Miller RR et al. Am J Respir Crit Care Med. 2013 Jul 1;188 (1):77–82. <https://doi.org/10.1164/rccm.201212-2199OC>.
8. 1. Ferrer, R et al. JAMA. 2008 May 21;299 (19):2294–303. <https://doi.org/10.1001/jama.299.19.2294>.

Topic: Sepsis

Publisher's Note

Springer Nature remains neutral with regard to jurisdictional claims in published maps and institutional affiliations.